

Ergebnis: **386** (407.4)
 Serien: 98 97 96 95
 Zähler: 27 12 1 0 0 0 0 0 0 0
 Innenzehner: 24
 weiteste: 526 (30), 442 (14), 395 (29)
 beste Teiler 9.8 (23.) 42.9 (8.) 45.1 (9.)
 Trefferlage 0.55 mm links, 0.13 mm hoch
 Streuwert 1.59, horizontal: 1.88, vertikal: 1.22

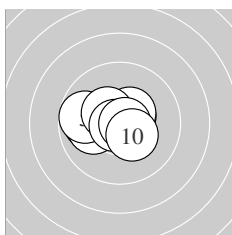

Serie 1:
 10.5 * 9.9 ← 10.5 * 10.0 ← 9.7 ←
 10.7 * 10.4 * 10.8 * 10.8 * 10.4 *
 beste Teiler 42.9 (8.) 45.1 (9.) 57.3 (6.)
 Trefferlage 0.55 mm links, 0.08 mm hoch
 Streuwert 1.18, horizontal: 1.56, vertikal: 0.62

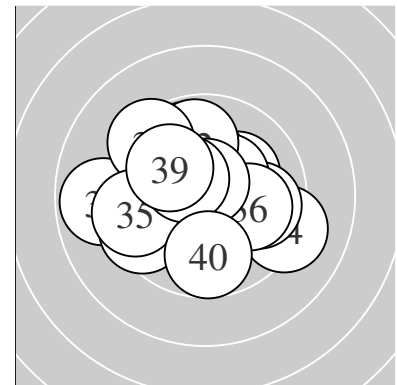
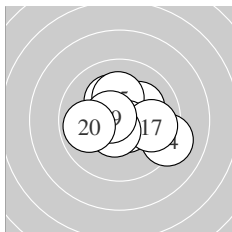

Serie 2:
 10.2 * 10.6 * 10.2 * 9.2 ↘ 10.2 *
 10.6 * 9.8 → 10.5 * 10.6 * 9.9 ←
 beste Teiler 80.6 (16.) 83.4 (19.) 92.7 (12.)
 Trefferlage 0.35 mm rechts, 0.01 mm hoch
 Streuwert 1.62, horizontal: 1.97, vertikal: 1.18

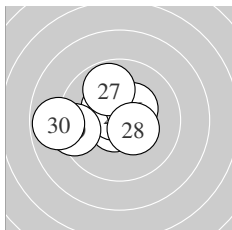

Serie 3:
 10.4 * 10.7 * 10.9 * 10.7 * 10.7 *
 10.4 * 9.8 ↖ 10.4 * 9.4 ← 8.8 ←
 beste Teiler 9.8 (23.) 53.0 (22.) 64.5 (24.)
 Trefferlage 0.93 mm links, 0.27 mm hoch
 Streuwert 1.65, horizontal: 2.08, vertikal: 1.05

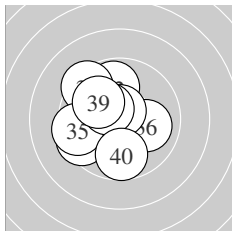

Serie 4:
 10.7 * 9.8 ↑ 9.4 ↘ 9.5 ← 9.5 ←
 10.0 → 10.7 * 10.4 * 10.0 ↘ 9.7 ↓
 beste Teiler 71.1 (37.) 73.6 (31.) 133.2 (38.)
 Trefferlage 1.09 mm links, 0.17 mm hoch
 Streuwert 1.84, horizontal: 1.80, vertikal: 1.89

Unterschrift des Schützen

Meyton Elektronik

Ergebnis:	387	(401.3)
Serien:	97	96 99 95
Zähler:	27	13 0 0 0 0 0 0 0 0
Innenzehner:	19	
weiteste:	473	(10), 472 (18), 462 (32)
beste Teiler	85.4	(2.) 107.4 (25.) 115.1 (33.)
Trefferlage	0.31	mm links, 0.12 mm hoch
Streuwert	1.79,	horizontal: 1.52, vertikal: 2.03

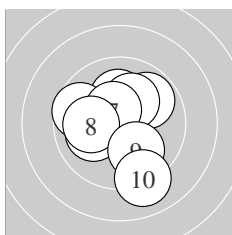
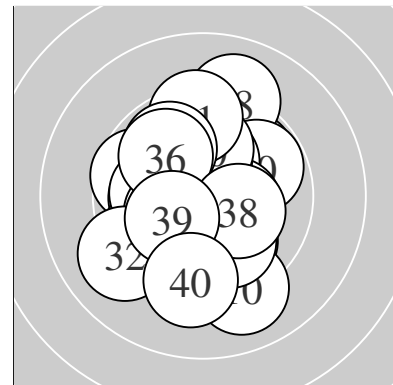

Serie 1:	10.1 ↑	10.6 *	9.6 ↖	9.8 ↗	10.2 *
	10.1 ←	10.5 *	10.0 ←	10.0 ↓	9.1 ↓
beste Teiler	85.4	(2.) 117.6 (7.)	195.9 (5.)		
Trefferlage	0.27	mm links, 0.02 mm hoch			
Streuwert	1.92,	horizontal: 1.82, vertikal: 2.02			

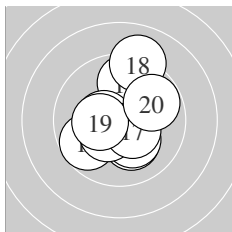

Serie 2:	9.7 ↙	10.2 *	10.2 *	10.4 *	9.8 ↑
	10.5 *	10.4 *	9.1 ↑	10.3 *	9.8 ↗
beste Teiler	124.4	(16.) 129.8 (17.)	142.2 (14.)		
Trefferlage	0.11	mm rechts, 0.19 mm hoch			
Streuwert	1.88,	horizontal: 1.59, vertikal: 2.12			

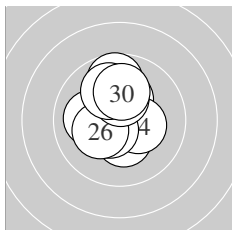

Serie 3:	10.3 *	10.4 *	10.1 ←	10.3 *	10.5 *
	10.3 *	9.7 ↑	10.3 *	10.0 ↑	10.1 ↑
beste Teiler	107.4	(25.) 150.6 (22.)	153.5 (24.)		
Trefferlage	0.32	mm links, 0.76 mm hoch			
Streuwert	1.36,	horizontal: 1.06, vertikal: 1.61			

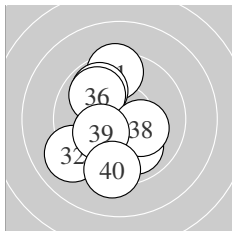

Serie 4:	9.5 ↑	9.1 ↙	10.5 *	9.9 ↘	10.3 *
	9.9 ↘	10.0 ↓	10.2 *	10.2 *	9.3 ↓
beste Teiler	115.1	(33.) 164.7 (35.)	182.0 (39.)		
Trefferlage	0.76	mm links, 0.47 mm tief			
Streuwert	2.04,	horizontal: 1.59, vertikal: 2.41			

Unterschrift des Schützen

Meyton Elektronik

Ergebnis:	387	(404.5)
Serien:	96 98 98 95	
Zähler:	27 13 0 0 0 0 0 0 0 0	
Innenzehner:	20	
weiteste:	475 (15), 439 (37), 395 (4)	
beste Teiler	49.2 (20.) 63.5 (23.) 93.2 (11.)	
Trefferlage	0.25 mm rechts, 0.12 mm hoch	
Streuwert	1.66, horizontal: 1.80, vertikal: 1.50	

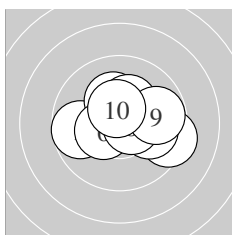
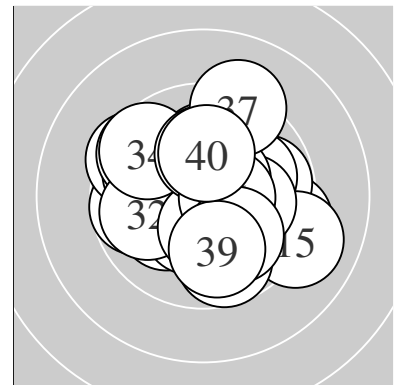

Serie 1:

9.9 →	9.7 ←	10.2 *	9.4 →	10.3 *
10.4 *	10.0 →	10.6 *	9.8 →	10.5 *
beste Teiler	93.7 (8.)	115.3 (10.)	137.3 (6.)	
Trefferlage	0.80 mm rechts, 0.18 mm hoch			
Streuwert	1.65, horizontal: 2.11, vertikal: 0.99			

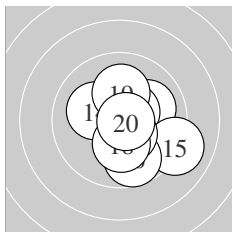

Serie 2:

10.6 *	10.0 →	10.5 *	10.1 ↖	9.1 →
9.7 ↓	10.5 *	10.2 *	10.1 ↑	10.8 *
beste Teiler	49.2 (20.)	93.2 (11.)	108.8 (13.)	
Trefferlage	0.87 mm rechts, 0.35 mm tief			
Streuwert	1.57, horizontal: 1.57, vertikal: 1.56			

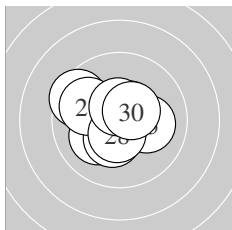

Serie 3:

10.1 ↙	9.5 ↖	10.7 *	10.3 *	10.1 →
10.5 *	9.9 ↖	10.5 *	10.5 *	10.5 *
beste Teiler	63.5 (23.)	103.8 (29.)	104.4 (26.)	
Trefferlage	0.40 mm links, 0.10 mm hoch			
Streuwert	1.39, horizontal: 1.63, vertikal: 1.10			

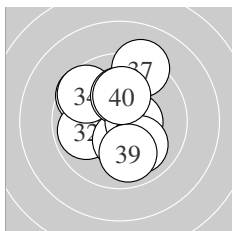

Serie 4:

9.6 ↖	9.9 ←	10.4 *	9.6 ↖	10.2 *
10.5 *	9.2 ↑	10.0 ↘	9.9 ↓	10.2 *
beste Teiler	112.2 (36.)	147.6 (33.)	195.0 (35.)	
Trefferlage	0.26 mm links, 0.54 mm hoch			
Streuwert	1.95, horizontal: 1.72, vertikal: 2.15			

Unterschrift des Schützen

Ergebnis:	368	(384.8)
Serien:	93 93 91 91	
Zähler:	16 17 6 1 0 0 0 0 0 0	
Innenzehner:	12	
weiteste:	888 (15), 668 (28), 646 (31)	
beste Teiler	47.4 (26.) 52.4 (6.) 76.4 (2.)	
Trefferlage	0.37 mm links, 1.17 mm hoch	
Streuwert	2.61, horizontal: 2.99, vertikal: 2.16	

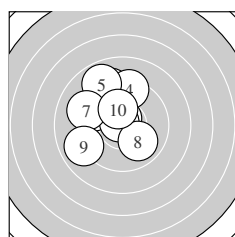
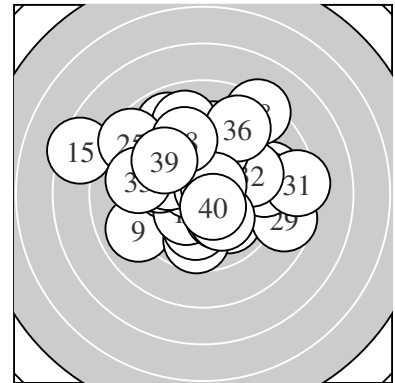

Serie 1:

9.5 ↘	10.6 *	9.2 ↗	9.3 ↑	8.9 ↖
10.7 *	9.2 ↘	10.0 ↘	9.0 ↙	10.2 *
beste Teiler	52.4 (6.)	76.4 (2.)	190.5 (10.)	
Trefferlage	1.40 mm links, 1.49 mm hoch			
Streuwert	2.24, horizontal: 2.08, vertikal: 2.40			

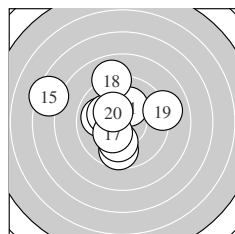

Serie 2:

10.2 *	9.9 ↖	9.7 ↓	10.1 ↖	7.4 ↖
10.0 ↓	10.3 *	9.0 ↑	9.1 →	10.3 *
beste Teiler	158.4 (20.)	167.0 (17.)	187.9 (11.)	
Trefferlage	1.19 mm links, 0.67 mm hoch			
Streuwert	2.81, horizontal: 3.18, vertikal: 2.38			

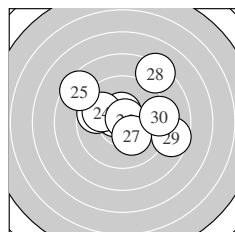

Serie 3:

10.5 *	9.7 ↖	10.5 *	9.9 ↖	8.5 ↖
10.8 *	10.2 *	8.3 ↗	8.6 →	9.3 →
beste Teiler	47.4 (26.)	103.7 (21.)	114.7 (23.)	
Trefferlage	0.35 mm rechts, 1.08 mm hoch			
Streuwert	2.81, horizontal: 3.34, vertikal: 2.14			

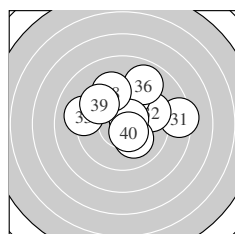

Serie 4:

8.4 →	9.5 →	9.2 ↖	10.1 ↘	9.7 ↑
8.9 ↗	10.6 *	9.4 ↖	9.6 ↖	10.5 *
beste Teiler	91.6 (37.)	111.2 (40.)	205.8 (34.)	
Trefferlage	0.72 mm rechts, 1.45 mm hoch			
Streuwert	2.55, horizontal: 3.04, vertikal: 1.93			

Unterschrift des Schützen

Ergebnis: **385** (402.8)
 Serien: 96 96 98 95
 Zähler: 27 11 2 0 0 0 0 0 0 0
 Innenzehner: 18
 weiteste: 542 (12), 509 (9), 380 (40)
 beste Teiler 20.0 (36.) 21.2 (4.) 78.3 (13.)
 Trefferlage 0.12 mm rechts, 0.44 mm hoch
 Streuwert 1.73, horizontal: 1.99, vertikal: 1.43

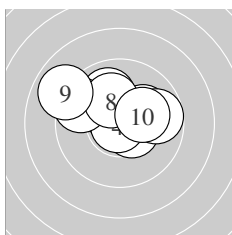
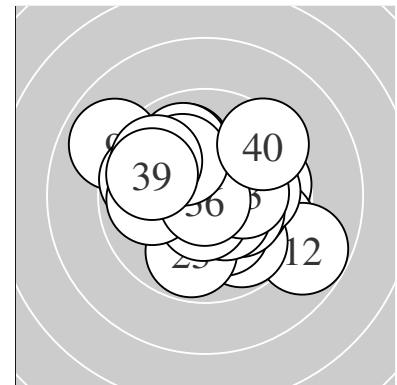

Serie 1:
 10.5 * 10.5 * 10.1 ↗ 10.9 * 9.7 →
 10.0 ↘ 9.6 ↖ 10.2 * 8.9 ↖ 10.2 *
 beste Teiler 21.2 (4.) 115.2 (1.) 115.5 (2.)
 Trefferlage 0.24 mm links, 1.03 mm hoch
 Streuwert 1.78, horizontal: 2.31, vertikal: 1.01

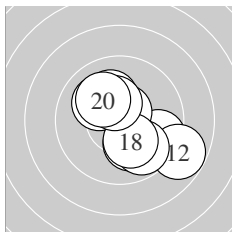

Serie 2:
 9.6 ↗ 8.8 ↗ 10.6 * 10.2 * 10.1 ↘
 10.1 ↖ 9.8 ↘ 10.2 * 10.4 * 10.1 ↖
 beste Teiler 78.3 (13.) 144.6 (19.) 189.7 (18.)
 Trefferlage 0.77 mm rechts, 0.27 mm tief
 Streuwert 1.93, horizontal: 2.03, vertikal: 1.82

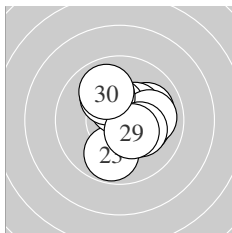

Serie 3:
 10.0 → 10.4 * 9.8 ↓ 10.2 * 10.5 *
 10.0 → 10.1 ↖ 10.2 * 10.4 * 9.9 ↖
 beste Teiler 113.7 (25.) 134.4 (29.) 149.7 (22.)
 Trefferlage 0.74 mm rechts, 0.23 mm hoch
 Streuwert 1.42, horizontal: 1.36, vertikal: 1.49

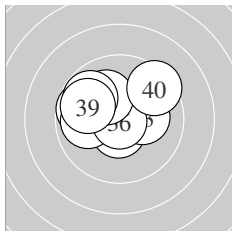

Serie 4:
 9.7 ↖ 10.6 * 10.2 * 9.9 ← 10.4 *
 10.9 * 10.1 ↖ 9.8 ↖ 9.8 ↖ 9.4 ↗
 beste Teiler 20.0 (36.) 94.4 (32.) 132.2 (35.)
 Trefferlage 0.78 mm links, 0.78 mm hoch
 Streuwert 1.59, horizontal: 1.98, vertikal: 1.07

Unterschrift des Schützen

Meyton Elektronik

Ergebnis: **363** (380.8)
 Serien: 92 87 90 94
 Zähler: 15 16 6 3 0 0 0 0 0 0
 Innenzehner: 7
 weiteste: 969 (29), 803 (4), 783 (11)
 beste Teiler 24.5 (9.) 71.6 (20.) 96.3 (40.)
 Trefferlage 0.19 mm links, 0.09 mm tief
 Streuwert 2.96, horizontal: 3.63, vertikal: 2.08

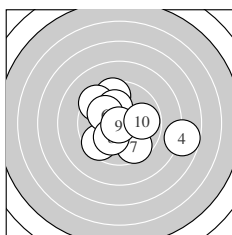
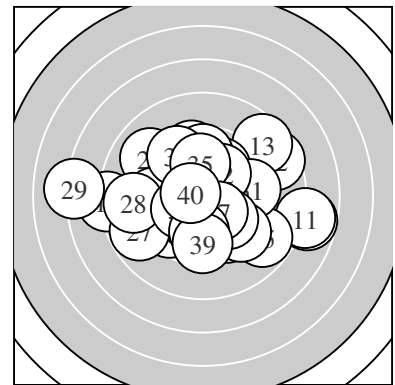

Serie 1:
 9.6 ↙ 9.5 ↑ 9.4 ↘ 7.7 → 10.1 ↑
 10.1 ↘ 9.6 ↘ 10.1 ↙ 10.9 * 9.8 →
 beste Teiler 24.5 (9.) 201.3 (8.) 202.4 (5.)
 Trefferlage 0.25 mm rechts, 0.03 mm hoch
 Streuwert 2.73, horizontal: 3.19, vertikal: 2.18

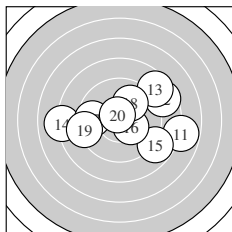

Serie 2:
 7.8 → 8.5 ↗ 8.6 ↗ 8.1 ← 8.8 ↘
 10.3 * 9.6 ← 10.0 ↗ 9.1 ← 10.7 *
 beste Teiler 71.6 (20.) 162.2 (16.) 249.7 (18.)
 Trefferlage 0.94 mm rechts, 0.23 mm hoch
 Streuwert 3.70, horizontal: 4.77, vertikal: 2.14

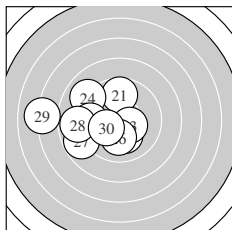

Serie 3:
 9.7 ↑ 10.1 ↓ 10.4 * 9.0 ↘ 9.5 ←
 10.1 ↓ 8.8 ↙ 8.9 ← 7.1 ← 10.2 *
 beste Teiler 140.4 (23.) 191.7 (30.) 203.9 (22.)
 Trefferlage 2.71 mm links, 0.23 mm tief
 Streuwert 2.77, horizontal: 3.39, vertikal: 1.96

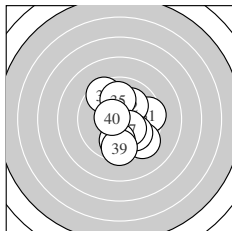

Serie 4:
 9.5 → 10.1 ↗ 9.4 ↘ 9.5 ↘ 10.0 ↑
 9.9 ↘ 10.3 * 9.9 ↓ 9.5 ↓ 10.6 *
 beste Teiler 96.3 (40.) 160.5 (37.) 214.1 (32.)
 Trefferlage 0.73 mm rechts, 0.39 mm tief
 Streuwert 2.04, horizontal: 1.73, vertikal: 2.30

Unterschrift des Schützen

Meyton Elektronik

Ergebnis: **371** (390.1)
 Serien: 93 92 94 92
 Zähler: 16 19 5 0 0 0 0 0 0
 Innenzehner: 12
 weiteste: 620 (39), 580 (25), 577 (15)
 beste Teiler 50.8 (5.) 115.4 (24.) 137.4 (19.)
 Trefferlage 0.05 mm rechts, 0.30 mm hoch
 Streuwert 2.37, horizontal: 2.95, vertikal: 1.58

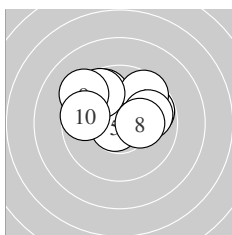
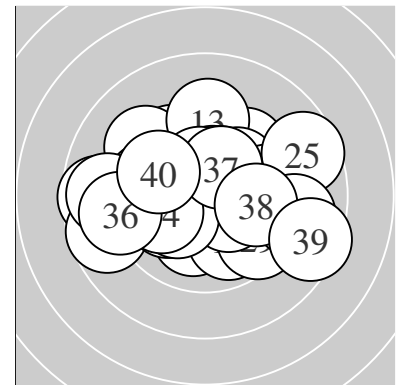

Serie 1:
 9.8 ↗ 9.7 ↘ 10.3 * 9.6 ↗ 10.8 *
 9.7 ↘ 9.9 → 10.2 * 9.3 ↘ 9.7 ←
 beste Teiler 50.8 (5.) 169.1 (3.) 184.0 (8.)
 Trefferlage 0.06 mm rechts, 1.39 mm hoch
 Streuwert 1.85, horizontal: 2.34, vertikal: 1.16

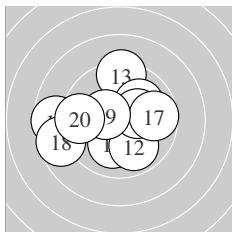

Serie 2:
 10.1 ↓ 9.9 ↘ 9.3 ↑ 10.0 ↗ 8.6 ←
 10.3 * 9.7 → 8.7 ← 10.4 * 9.5 ←
 beste Teiler 137.4 (19.) 171.4 (16.) 220.4 (11.)
 Trefferlage 0.87 mm links, 0.07 mm hoch
 Streuwert 2.58, horizontal: 3.09, vertikal: 1.93

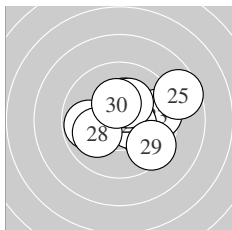

Serie 3:
 9.9 ↘ 9.8 ← 9.6 → 10.5 * 8.6 →
 10.3 * 10.3 * 10.0 ← 9.5 ↘ 10.3 *
 beste Teiler 115.4 (24.) 153.7 (30.) 161.2 (26.)
 Trefferlage 1.11 mm rechts, 0.20 mm hoch
 Streuwert 2.05, horizontal: 2.48, vertikal: 1.51

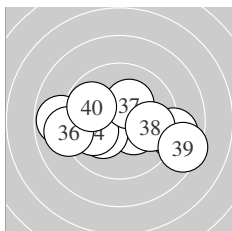

Serie 4:
 10.4 * 9.0 → 10.2 * 10.0 ← 8.8 ←
 9.1 ← 10.2 * 9.8 → 8.5 ↘ 9.8 ↘
 beste Teiler 150.9 (31.) 176.8 (37.) 187.6 (33.)
 Trefferlage 0.07 mm links, 0.47 mm tief
 Streuwert 2.81, horizontal: 3.80, vertikal: 1.17

Unterschrift des Schützen

Meyton Elektronik

Ergebnis:	371	(389.3)
Serien:	95 91 91 94	
Zähler:	15 22 2 1 0 0 0 0 0 0	
Innenzehner:	12	
weiteste:	842 (20), 511 (29), 509 (11)	
beste Teiler	51.2 (14.) 84.0 (13.) 95.3 (35.)	
Trefferlage	0.27 mm links, 0.36 mm tief	
Streuwert	2.41, horizontal: 2.75, vertikal: 2.00	

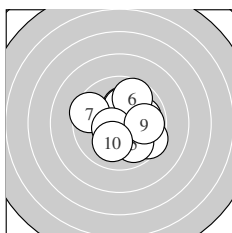
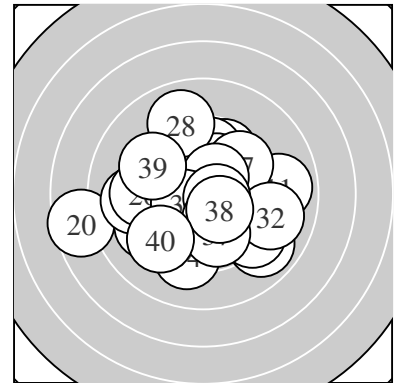

Serie 1:	10.2 *	10.2 *	9.5 ↘	10.0 →	9.9 ↘
	9.7 ↗	9.5 ←	10.5 *	9.8 →	10.1 ↘
beste Teiler	104.1 (8.) 183.3 (2.) 184.7 (1.)				
Trefferlage	0.70 mm rechts, 0.16 mm hoch				
Streuwert	1.88, horizontal: 2.00, vertikal: 1.76				

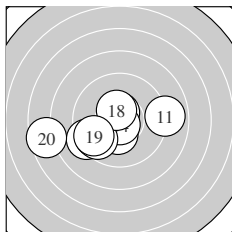

Serie 2:	8.9 →	10.3 *	10.6 *	10.7 *	9.2 ↙
	9.6 ↙	9.6 ↙	10.5 *	9.6 ↙	7.6 ←
beste Teiler	51.2 (14.) 84.0 (13.) 115.4 (18.)				
Trefferlage	1.54 mm links, 0.96 mm tief				
Streuwert	2.59, horizontal: 3.42, vertikal: 1.31				

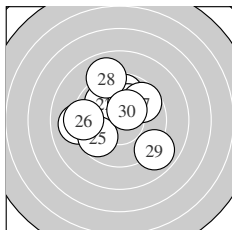

Serie 3:	9.8 ↑	9.9 ↘	10.1 ↗	9.1 ←	9.7 ↙
	9.3 ←	9.7 ↗	9.0 ↘	8.9 ↘	10.4 *
beste Teiler	140.4 (30.) 203.4 (23.) 258.9 (22.)				
Trefferlage	0.57 mm links, 0.89 mm hoch				
Streuwert	2.56, horizontal: 2.75, vertikal: 2.35				

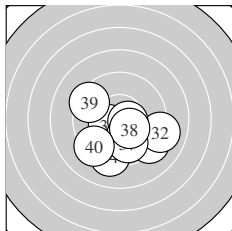

Serie 4:	9.2 ↘	9.0 →	10.4 *	9.2 ↓	10.6 *
	10.2 *	9.8 ↓	10.3 *	9.4 ↘	9.3 ↙
beste Teiler	95.3 (35.) 139.5 (33.) 152.8 (38.)				
Trefferlage	0.30 mm rechts, 1.58 mm tief				
Streuwert	2.14, horizontal: 2.51, vertikal: 1.70				

Unterschrift des Schützen

Meyton Elektronik

Ergebnis: **390** (403.7)
 Serien: 98 98 96 98
 Zähler: 30 10 0 0 0 0 0 0 0 0
 Innenzehner: 17
 weiteste: 441 (38), 416 (10), 402 (15)
 beste Teiler 52.0 (3.) 63.1 (4.) 64.3 (14.)
 Trefferlage 0.16 mm rechts, 0.49 mm tief
 Streuwert 1.65, horizontal: 1.65, vertikal: 1.65

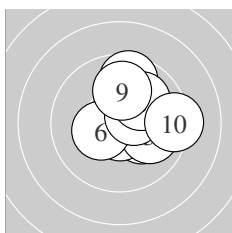
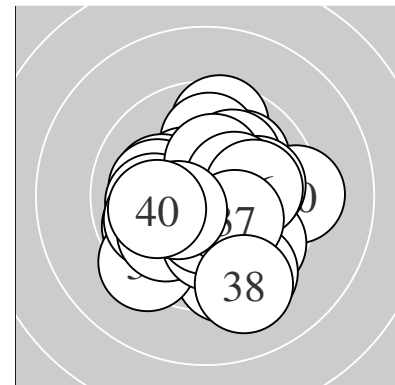

Serie 1:
 10.2 * 9.6 ↑ 10.7 * 10.7 * 10.0 →
 10.3 * 10.5 * 10.0 ↗ 10.0 ↑ 9.3 →
 beste Teiler 52.0 (3.) 63.1 (4.) 122.9 (7.)
 Trefferlage 1.03 mm rechts, 0.56 mm hoch
 Streuwert 1.50, horizontal: 1.53, vertikal: 1.46

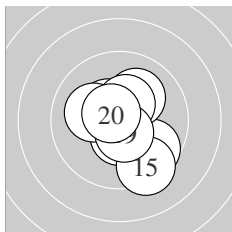

Serie 2:
 10.4 * 9.7 ↘ 10.5 * 10.7 * 9.3 ↓
 10.1 ← 10.1 ↗ 10.4 * 10.5 * 10.6 *
 beste Teiler 64.3 (14.) 82.4 (20.) 102.1 (19.)
 Trefferlage 0.24 mm rechts, 0.24 mm tief
 Streuwert 1.51, horizontal: 1.35, vertikal: 1.66

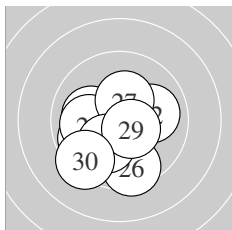

Serie 3:
 9.7 ↓ 10.0 → 9.8 ↙ 10.1 ← 10.0 ←
 9.5 ↓ 10.3 * 10.1 ↙ 10.5 * 9.3 ↙
 beste Teiler 109.8 (29.) 155.7 (27.) 205.4 (28.)
 Trefferlage 0.55 mm links, 1.14 mm tief
 Streuwert 1.75, horizontal: 1.79, vertikal: 1.72

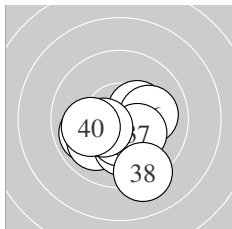

Serie 4:
 9.9 ↙ 10.0 ↙ 10.1 ↓ 10.4 * 10.4 *
 10.1 → 10.3 * 9.2 ↓ 10.4 * 10.0 ←
 beste Teiler 134.0 (34.) 140.0 (39.) 150.7 (35.)
 Trefferlage 0.06 mm links, 1.15 mm tief
 Streuwert 1.54, horizontal: 1.74, vertikal: 1.32

Unterschrift des Schützen

Ergebnis: **345** (361.3)
 Serien: 84 84 93 84
 Zähler: 9 17 7 4 3 0 0 0 0 0
 Innenzehner: 8
 weiteste: 1227 (33), 1220 (8), 1141 (14)
 beste Teiler 94.6 (11.) 108.3 (7.) 111.6 (37.)
 Trefferlage 0.87 mm links, 1.35 mm tief
 Streuwert 3.87, horizontal: 4.02, vertikal: 3.71

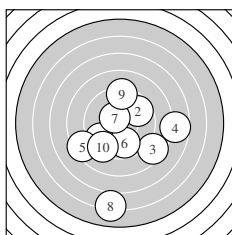
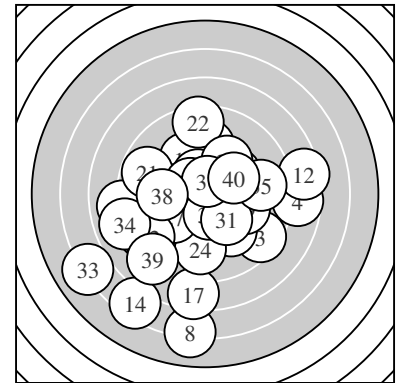

Serie 1:
 9.5 ↙ 9.7 ↗ 8.5 ↘ 7.7 → 8.4 ↖
 9.8 ↓ 10.5 * 6.1 ↓ 9.2 ↑ 9.3 ↘
 beste Teiler 108.3 (7.) 295.4 (6.) 321.7 (2.)
 Trefferlage 0.40 mm rechts, 2.15 mm tief
 Streuwert 4.19, horizontal: 3.98, vertikal: 4.40

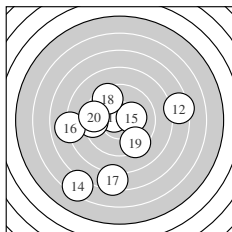

Serie 2:
 10.6 * 7.4 → 9.4 ← 6.4 ↙ 10.2 *
 8.0 ← 7.4 ↓ 9.5 ↘ 9.4 ↘ 9.4 ←
 beste Teiler 94.6 (11.) 178.3 (15.) 358.6 (18.)
 Trefferlage 1.19 mm links, 1.66 mm tief
 Streuwert 4.48, horizontal: 4.65, vertikal: 4.30

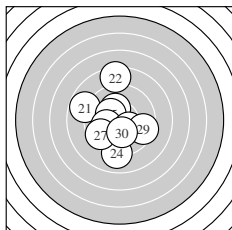

Serie 3:
 8.8 ↖ 8.4 ↑ 10.2 * 9.0 ↓ 10.3 *
 10.1 ← 9.6 ↙ 10.3 * 9.5 → 10.2 *
 beste Teiler 159.2 (25.) 171.4 (28.) 179.7 (23.)
 Trefferlage 0.76 mm links, 0.09 mm tief
 Streuwert 2.68, horizontal: 2.31, vertikal: 3.01

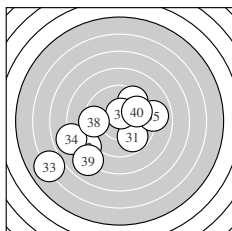

Serie 4:
 9.8 ↘ 8.5 ↙ 6.0 ↙ 7.9 ← 9.0 →
 9.6 ↗ 10.5 * 9.4 ← 8.0 ↙ 9.8 ↗
 beste Teiler 111.6 (37.) 289.1 (40.) 294.4 (31.)
 Trefferlage 1.92 mm links, 1.49 mm tief
 Streuwert 4.15, horizontal: 4.91, vertikal: 3.21

Unterschrift des Schützen

Ergebnis: **378** (394.2)
 Serien: 96 94 93 95
 Zähler: 23 13 3 1 0 0 0 0 0 0
 Innenzehner: 16
 weiteste: 833 (17), 632 (21), 568 (22)
 beste Teiler 16.7 (8.) 68.0 (7.) 98.2 (23.)
 Trefferlage 0.85 mm links, 0.33 mm hoch
 Streuwert 2.20, horizontal: 2.70, vertikal: 1.54

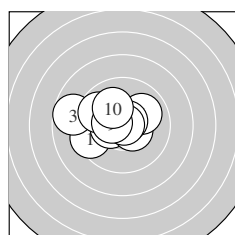
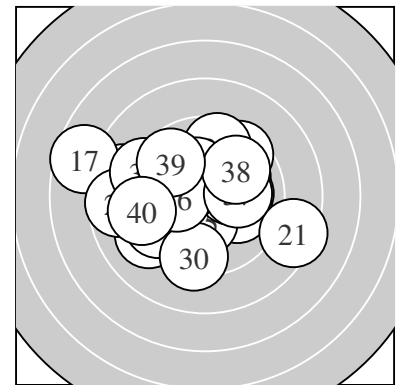

Serie 1:
 9.4 ← 10.4 * 8.7 ↖ 10.5 * 9.8 ↗
 10.0 ↗ 10.7 * 10.9 * 10.5 * 10.1 ↘
 beste Teiler 16.7 (8.) 68.0 (7.) 120.0 (9.)
 Trefferlage 1.13 mm links, 0.41 mm hoch
 Streuwert 1.76, horizontal: 2.27, vertikal: 1.02

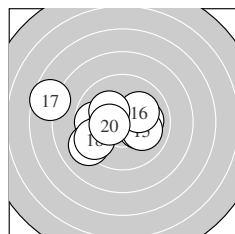

Serie 2:
 10.2 * 10.0 → 9.7 ← 9.2 ↙ 10.0 ↘
 10.1 ↗ 7.6 ↖ 9.5 ↙ 10.2 * 10.4 *
 beste Teiler 146.5 (20.) 185.3 (11.) 188.5 (19.)
 Trefferlage 1.28 mm links, 0.13 mm tief
 Streuwert 2.57, horizontal: 3.33, vertikal: 1.47

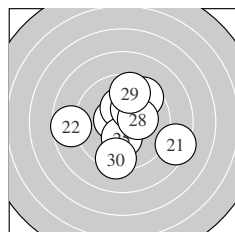

Serie 3:
 8.4 ↘ 8.7 ← 10.6 * 10.3 * 10.3 *
 10.3 * 9.5 ↗ 10.3 * 9.6 ↑ 9.3 ↓
 beste Teiler 98.2 (23.) 159.6 (24.) 171.4 (28.)
 Trefferlage 0.37 mm rechts, 0.09 mm hoch
 Streuwert 2.62, horizontal: 2.90, vertikal: 2.30

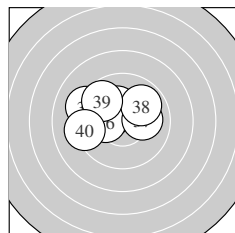

Serie 4:
 10.4 * 10.1 ↘ 9.9 ↘ 9.2 ↖ 10.3 *
 10.2 * 10.1 → 9.9 ↗ 9.7 ↘ 9.2 ←
 beste Teiler 142.6 (31.) 171.1 (35.) 186.3 (36.)
 Trefferlage 1.37 mm links, 0.95 mm hoch
 Streuwert 1.68, horizontal: 2.14, vertikal: 1.03

Unterschrift des Schützen

Ergebnis:	341	(360.6)
Serien:	84 85 83 89	
Zähler:	8 14 10 7 1 0 0 0 0 0	
Innenzehner:	7	
weiteste:	1090 (27), 923 (13), 909 (14)	
beste Teiler	71.3 (19.) 72.0 (33.) 72.2 (24.)	
Trefferlage	0.87 mm links, 1.06 mm hoch	
Streuwert	3.86, horizontal: 4.52, vertikal: 3.05	

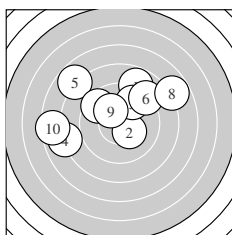
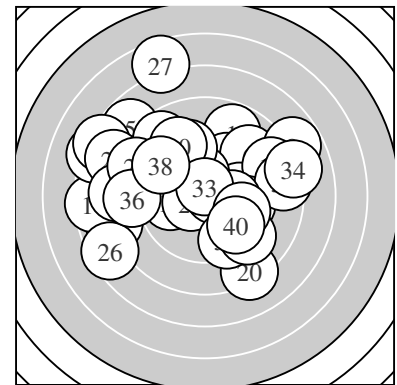

Serie 1:	8.8 ↗	10.3 *	9.7 ↗	8.0 ←	7.8 ↘
	9.0 ↗	9.5 ↘	7.8 ↗	10.2 *	7.4 ←
beste Teiler	168.1 (2.) 199.4 (9.) 319.3 (3.)				
Trefferlage	1.03 mm links, 2.03 mm hoch				
Streuwert	4.00, horizontal: 5.04, vertikal: 2.58				

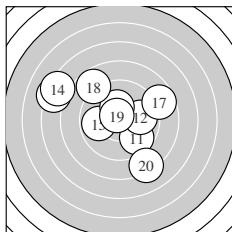

Serie 2:	9.7 ↘	9.9 →	7.3 ↘	7.3 ↘	9.9 ←
	10.3 *	8.7 ↗	8.7 ↘	10.7 *	8.2 ↘
beste Teiler	71.3 (19.) 175.3 (16.) 272.5 (12.)				
Trefferlage	1.00 mm links, 0.82 mm hoch				
Streuwert	4.02, horizontal: 4.72, vertikal: 3.16				

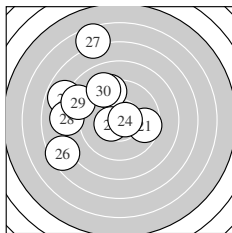

Serie 3:	9.6 →	9.4 ↖	10.5 *	10.7 *	7.9 ↘
	7.5 ←	6.6 ↖	8.2 ←	8.6 ↘	9.2 ↘
beste Teiler	72.2 (24.) 121.7 (23.) 334.9 (21.)				
Trefferlage	3.09 mm links, 1.81 mm hoch				
Streuwert	3.77, horizontal: 3.64, vertikal: 3.90				

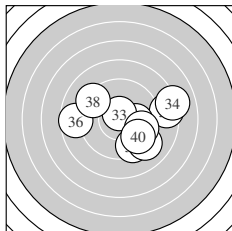

Serie 4:	8.5 →	10.1 →	10.7 *	8.1 →	9.4 ↘
	8.7 ←	9.1 ↘	9.3 ↘	9.7 →	9.6 ↘
beste Teiler	72.0 (33.) 213.2 (32.) 311.6 (39.)				
Trefferlage	1.62 mm rechts, 0.41 mm tief				
Streuwert	3.13, horizontal: 3.90, vertikal: 2.08				

Unterschrift des Schützen

Ergebnis: **378** (399.5)
 Serien: 94 92 97 95
 Zähler: 22 16 1 0 1 0 0 0 0 0
 Innenzehner: 18
 weiteste: 1164 (38), 514 (18), 485 (7)
 beste Teiler 14.1 (33.) 29.7 (24.) 38.3 (16.)
 Trefferlage 0.47 mm links, 0.54 mm hoch
 Streuwert 2.19, horizontal: 2.40, vertikal: 1.96

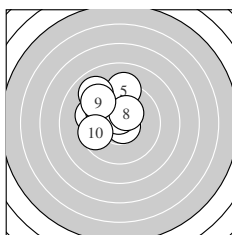
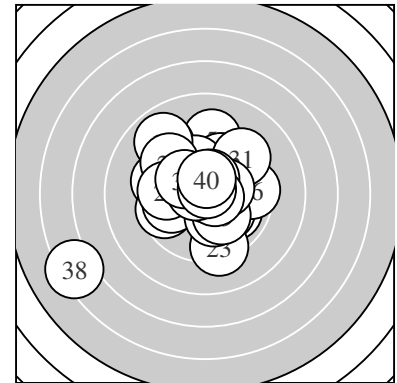

Serie 1:
 10.1 ↘ 9.5 ← 10.7 * 9.9 ↘ 9.2 ↑
 10.6 * 9.0 ↘ 10.3 * 9.4 ↘ 9.6 ←
 beste Teiler 57.4 (3.) 82.8 (6.) 155.8 (8.)
 Trefferlage 1.41 mm links, 1.53 mm hoch
 Streuwert 1.70, horizontal: 1.71, vertikal: 1.70

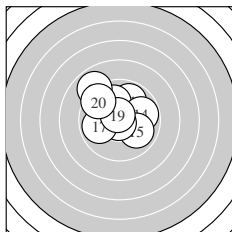

Serie 2:
 9.9 ↗ 9.9 ↘ 10.0 ↗ 9.8 → 9.9 ↘
 10.8 * 9.9 ← 8.9 ↘ 10.7 * 9.5 ↘
 beste Teiler 38.3 (16.) 70.0 (19.) 239.0 (13.)
 Trefferlage 0.53 mm links, 1.21 mm hoch
 Streuwert 1.91, horizontal: 2.09, vertikal: 1.70

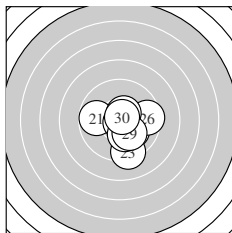

Serie 3:
 9.8 ← 10.1 ↘ 9.3 ↓ 10.8 * 10.6 *
 9.5 → 10.2 * 10.5 * 10.1 ↘ 10.8 *
 beste Teiler 29.7 (24.) 50.6 (30.) 90.3 (25.)
 Trefferlage 0.69 mm rechts, 0.69 mm tief
 Streuwert 1.57, horizontal: 1.61, vertikal: 1.53

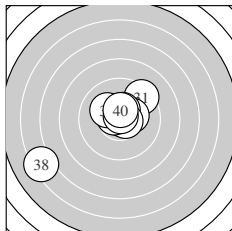

Serie 4:
 9.4 ↗ 10.3 * 10.9 * 10.5 * 10.6 *
 10.7 * 10.2 * 6.3 ← 10.8 * 10.5 *
 beste Teiler 14.1 (33.) 39.5 (39.) 73.7 (36.)
 Trefferlage 0.64 mm links, 0.13 mm hoch
 Streuwert 2.96, horizontal: 3.52, vertikal: 2.26

Unterschrift des Schützen

Ergebnis:	337	(355.1)
Serien:	80	83 84 90
Zähler:	7	14 12 3 4 0 0 0 0 0
Innenzehner:	4	
weiteste:	1147 (10), 1147 (12), 1115 (8)	
beste Teiler	98.7 (28.) 141.0 (37.) 159.8 (14.)	
Trefferlage	0.22 mm links, 1.32 mm tief	
Streuwert	4.11, horizontal: 4.83, vertikal: 3.23	

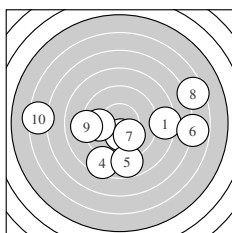
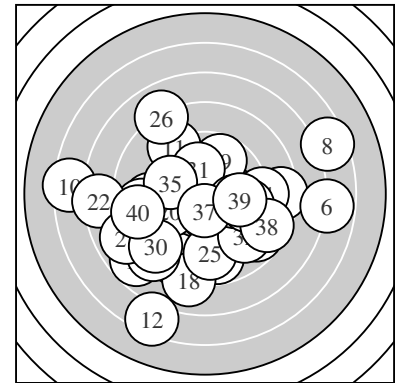

Serie 1:

8.4 →	10.3 *	9.8 ←	8.5 ↓	8.8 ↓
6.8 →	10.1 ↘	6.5 →	9.1 ←	6.4 ←

beste Teiler 164.5 (2.) 214.5 (7.) 287.1 (3.)
 Trefferlage 0.82 mm rechts, 1.09 mm tief
 Streuwert 5.21, horizontal: 6.80, vertikal: 2.83

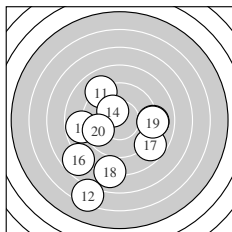

Serie 2:

9.1 ↖	6.4 ↓	8.8 ←	10.3 *	9.1 →
7.8 ↙	8.7 ↘	8.0 ↓	9.1 →	9.6 ←

beste Teiler 159.8 (14.) 331.0 (20.) 466.7 (19.)
 Trefferlage 0.98 mm links, 2.43 mm tief
 Streuwert 4.22, horizontal: 4.13, vertikal: 4.32

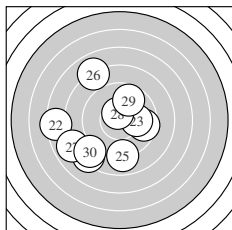

Serie 3:

9.6 →	7.4 ←	10.0 →	8.3 ↙	8.9 ↓
8.0 ↘	7.9 ↙	10.6 *	9.7 ↗	8.5 ↙

beste Teiler 98.7 (28.) 240.0 (23.) 308.3 (29.)
 Trefferlage 2.06 mm links, 0.92 mm tief
 Streuwert 3.93, horizontal: 4.10, vertikal: 3.75

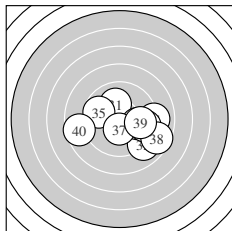

Serie 4:

10.1 ↗	9.0 ↘	9.9 →	9.0 →	9.7 ←
9.5 →	10.4 *	8.6 ↘	9.8 →	8.6 ←

beste Teiler 141.0 (37.) 218.1 (31.) 256.1 (33.)
 Trefferlage 1.31 mm rechts, 0.82 mm tief
 Streuwert 2.76, horizontal: 3.55, vertikal: 1.64

Unterschrift des Schützen

Meyton Elektronik

Ergebnis:	362	(380.9)
Serien:	91 93 88 90	
Zähler:	13 18 7 2 0 0 0 0 0 0	
Innenzehner:	10	
weiteste:	819 (5), 794 (27), 630 (32)	
beste Teiler	33.3 (29.) 82.2 (3.) 103.2 (1.)	
Trefferlage	0.43 mm links, 2.05 mm tief	
Streuwert	2.47, horizontal: 2.83, vertikal: 2.05	

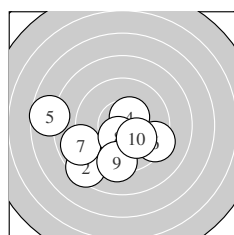
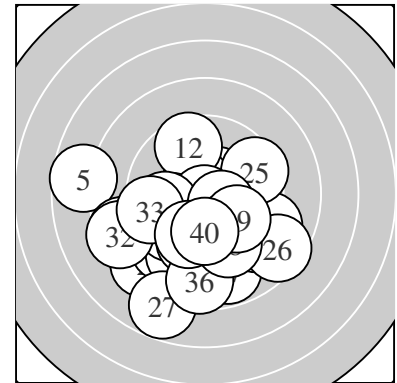

Serie 1:

10.5 *	8.5 ↙	10.6 *	10.5 *	7.7 ←
9.3 ↘	8.9 ←	10.4 *	9.3 ↓	10.1 ↘
beste Teiler	82.2 (3.)	103.2 (1.)	118.5 (4.)	
Trefferlage	1.09 mm links, 1.49 mm tief			
Streuwert	2.79, horizontal: 3.49, vertikal: 1.84			

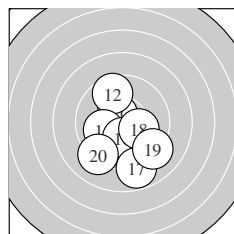

Serie 2:

10.5 *	9.6 ↗	9.4 ↘	9.8 ↘	10.0 ←
10.3 *	8.8 ↓	10.2 *	9.2 ↘	9.1 ↙
beste Teiler	105.9 (11.)	173.0 (16.)	196.3 (18.)	
Trefferlage	0.30 mm rechts, 1.68 mm tief			
Streuwert	2.19, horizontal: 1.96, vertikal: 2.41			

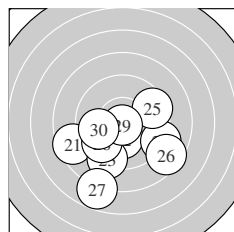

Serie 3:

8.5 ←	10.2 *	9.2 ↓	9.1 ↘	9.5 →
8.5 ↘	7.8 ↓	9.7 ↙	10.8 *	9.8 ←
beste Teiler	33.3 (29.)	183.0 (22.)	277.6 (30.)	
Trefferlage	0.26 mm links, 2.33 mm tief			
Streuwert	2.97, horizontal: 3.43, vertikal: 2.41			

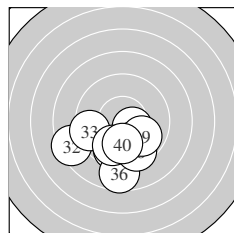

Serie 4:

9.5 ↓	8.4 ←	9.4 ←	9.6 ↓	10.4 *
8.6 ↓	9.8 ↓	9.5 ↘	9.9 ↘	10.0 ↓
beste Teiler	128.1 (35.)	250.0 (40.)	270.6 (39.)	
Trefferlage	0.69 mm links, 2.72 mm tief			
Streuwert	1.97, horizontal: 2.39, vertikal: 1.44			

Unterschrift des Schützen

Ergebnis: **332** (348.1)
 Serien: 75 89 86 82
 Zähler: 5 16 10 5 3 1 0 0 0 0
 Innenzehner: 5
 weiteste: 1296 (6), 1154 (17), 1125 (8)
 beste Teiler 20.0 (25.) 84.4 (29.) 106.4 (18.)
 Trefferlage 0.61 mm rechts, 0.25 mm tief
 Streuwert 4.59, horizontal: 5.63, vertikal: 3.23

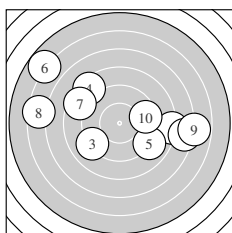
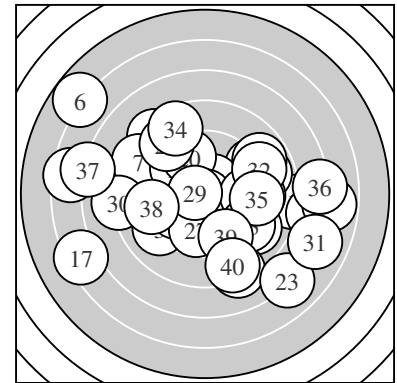

Serie 1:
 8.0 → 7.3 → 9.1 ↙ 8.4 ↘ 9.0 ↘
 5.8 ↘ 8.5 ↘ 6.5 ← 6.8 → 9.5 →
 beste Teiler 369.6 (10.) 471.2 (3.) 495.3 (5.)
 Trefferlage 0.08 mm links, 0.89 mm hoch
 Streuwert 6.09, horizontal: 7.90, vertikal: 3.43

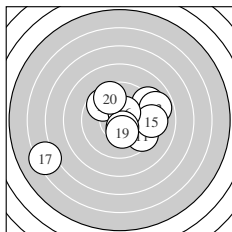

Serie 2:
 9.5 ↘ 9.1 ↗ 8.9 → 9.7 ↘ 9.2 →
 10.5 * 6.3 ↙ 10.5 * 10.3 * 9.6 ↘
 beste Teiler 106.4 (18.) 123.4 (16.) 165.9 (19.)
 Trefferlage 0.38 mm rechts, 0.02 mm hoch
 Streuwert 3.65, horizontal: 4.48, vertikal: 2.56

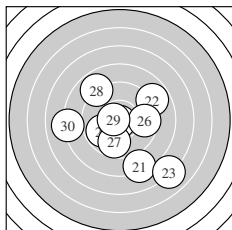

Serie 3:
 8.2 ↘ 8.8 ↗ 7.0 ↘ 9.8 ↙ 10.9 *
 9.6 → 9.7 ↓ 8.9 ↘ 10.6 * 8.1 ←
 beste Teiler 20.0 (25.) 84.4 (29.) 281.1 (24.)
 Trefferlage 0.31 mm rechts, 1.19 mm tief
 Streuwert 3.85, horizontal: 4.13, vertikal: 3.56

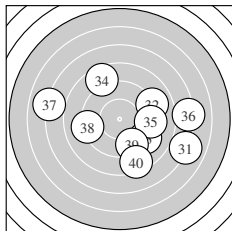

Serie 4:
 7.0 ↘ 9.0 → 9.2 ↘ 8.6 ↘ 9.2 →
 7.1 → 7.0 ← 9.1 ← 9.4 ↘ 8.4 ↘
 beste Teiler 390.0 (39.) 430.5 (35.) 438.2 (33.)
 Trefferlage 1.83 mm rechts, 0.73 mm tief
 Streuwert 4.85, horizontal: 5.96, vertikal: 3.39

Unterschrift des Schützen