

Ergebnis: **335** (353.9)
 Serien: 80 83 86 86
 Zähler: 5 14 14 5 2 0 0 0 0 0
 Innenzehner: 3
 weiteste: 1209 (7), 1112 (20), 856 (26)
 beste Teiler 105.0 (36.) 107.1 (17.) 156.6 (31.)
 Trefferlage 0.35 mm links, 0.39 mm tief
 Streuwert 4.15, horizontal: 4.51, vertikal: 3.76

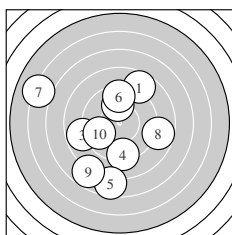

Serie 1:
 8.7 ↗ 9.9 ↑ 8.8 ← 9.2 ↓ 7.6 ↓
 9.5 ↑ 6.1 ↖ 8.7 → 7.8 ↙ 9.7 ←
 beste Teiler 251.3 (2.) 313.5 (10.) 375.1 (6.)
 Trefferlage 1.66 mm links, 0.79 mm tief
 Streuwert 4.64, horizontal: 4.60, vertikal: 4.69

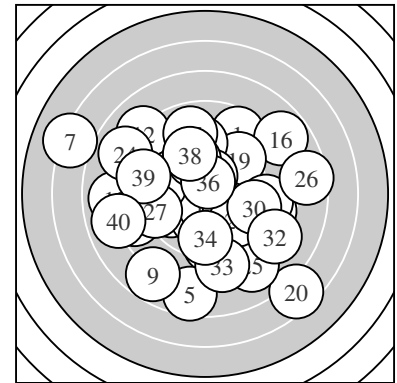
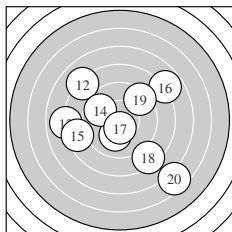

Serie 2:
 10.1 ↓ 8.1 ↖ 8.0 ← 9.7 ↖ 8.5 ←
 7.8 ↗ 10.5 * 8.3 ↘ 9.3 ↗ 6.5 ↘
 beste Teiler 107.1 (17.) 213.8 (11.) 303.2 (14.)
 Trefferlage 0.10 mm links, 0.49 mm tief
 Streuwert 4.74, horizontal: 5.23, vertikal: 4.19

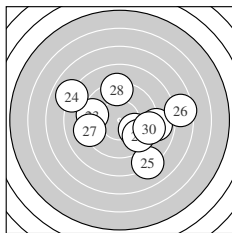

Serie 3:
 8.9 → 10.0 ↘ 9.4 ← 8.0 ↖ 8.1 ↓
 7.5 → 9.2 ← 9.2 ↑ 9.6 ↘ 9.3 →
 beste Teiler 244.9 (22.) 338.7 (29.) 384.9 (23.)
 Trefferlage 1.12 mm rechts, 0.28 mm tief
 Streuwert 3.94, horizontal: 4.76, vertikal: 2.90

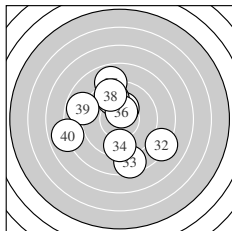

Serie 4:
 10.3 * 8.2 ↘ 8.5 ↓ 9.5 ↓ 9.8 ↑
 10.5 * 8.9 ↑ 9.5 ↖ 8.8 ← 7.9 ←
 beste Teiler 105.0 (36.) 156.6 (31.) 294.7 (35.)
 Trefferlage 0.78 mm links, 0.02 mm tief
 Streuwert 3.56, horizontal: 3.53, vertikal: 3.59

Unterschrift des Schützen

Ergebnis:	386	(402.1)
Serien:	95	97 98 96
Zähler:	26	14 0 0 0 0 0 0 0 0
Innenzehner:	20	
weiteste:	472	(1), 440 (4), 427 (33)
beste Teiler	31.1	(25.) 34.0 (27.) 37.0 (17.)
Trefferlage	0.18 mm	rechts, 0.42 mm hoch
Streuwert	1.83,	horizontal: 2.03, vertikal: 1.60

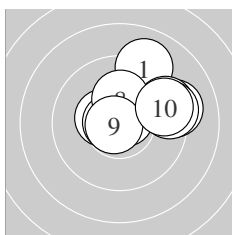
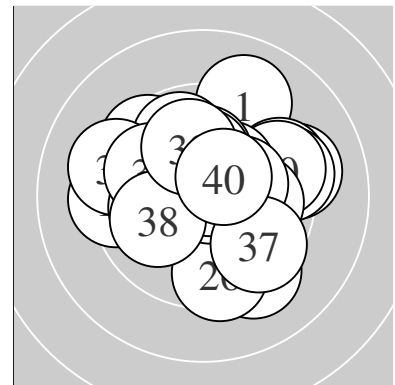

Serie 1:	9.1 ↗	10.7 *	10.4 *	9.2 →	9.4 →
	9.3 →	10.7 *	10.2 *	10.8 *	9.5 →
beste Teiler	45.8	(9.) 59.4 (2.)	64.4 (7.)		
Trefferlage	1.52 mm	rechts, 1.18 mm hoch			
Streuwert	1.75,	horizontal: 2.13, vertikal: 1.27			

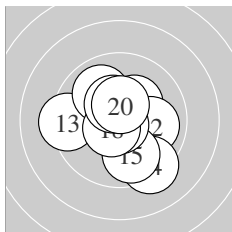

Serie 2:	10.3 *	10.0 →	9.3 ←	9.3 ↘	9.8 ↓
	10.0 ↘	10.8 *	10.6 *	10.4 *	10.5 *
beste Teiler	37.0	(17.) 87.6 (18.)	120.1 (20.)		
Trefferlage	0.02 mm	rechts, 0.19 mm tief			
Streuwert	1.84,	horizontal: 1.90, vertikal: 1.77			

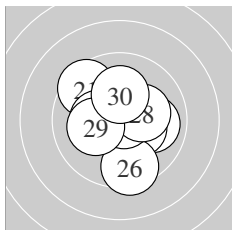

Serie 3:	9.5 ↘	10.0 →	10.3 *	10.3 *	10.8 *
	9.5 ↓	10.8 *	10.2 *	10.2 *	10.2 *
beste Teiler	31.1	(25.) 34.0 (27.)	155.0 (24.)		
Trefferlage	0.06 mm	rechts, 0.04 mm hoch			
Streuwert	1.65,	horizontal: 1.65, vertikal: 1.64			

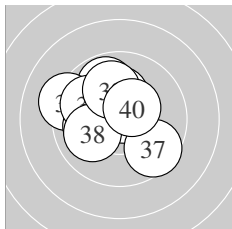

Serie 4:	9.8 ↖	10.8 *	9.2 ↖	10.2 *	10.1 ←
	9.9 ↖	9.6 ↘	10.0 ←	10.0 ↑	10.4 *
beste Teiler	48.9	(32.) 130.9 (40.)	185.0 (34.)		
Trefferlage	0.85 mm	links, 0.66 mm hoch			
Streuwert	1.75,	horizontal: 1.93, vertikal: 1.55			

Unterschrift des Schützen

Meyton Elektronik

Ergebnis:	352	(371.2)
Serien:	90 85 86 91	
Zähler:	12 17 6 2 2 1 0 0 0 0	
Innenzehner:	11	
weiteste:	1431 (26), 1223 (11), 1054 (12)	
beste Teiler	13.8 (19.) 90.0 (17.) 100.1 (31.)	
Trefferlage	0.97 mm rechts, 0.27 mm tief	
Streuwert	3.65, horizontal: 4.22, vertikal: 2.96	

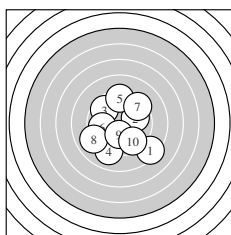
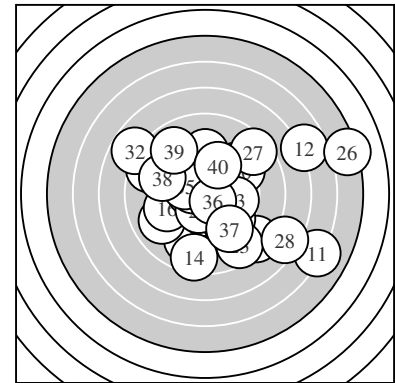

Serie 1:	8.3 ↘	9.9 →	9.6 ↖	9.1 ↓	9.3 ↑
	9.8 ←	9.4 ↗	9.0 ↙	10.2 *	9.5 ↘
beste Teiler	181.3 (9.)	266.9 (2.)	282.8 (6.)		
Trefferlage	0.12 mm rechts, 0.68 mm tief				
Streuwert	2.97, horizontal: 2.93, vertikal: 3.00				

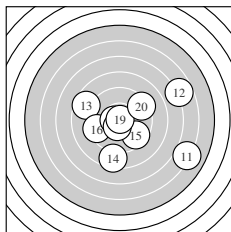

Serie 2:	6.1 ↘	6.7 ↗	8.6 ↖	8.5 ↓	9.5 ↘
	9.4 ←	10.6 *	10.5 *	10.9 *	9.3 ↗
beste Teiler	13.8 (19.)	90.0 (17.)	110.7 (18.)		
Trefferlage	1.51 mm rechts, 0.73 mm tief				
Streuwert	4.43, horizontal: 5.26, vertikal: 3.39				

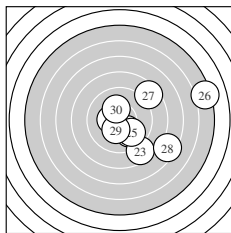

Serie 3:	9.9 ↘	10.4 *	8.6 ↖	10.2 *	9.9 ↘
	5.2 →	8.5 ↗	7.4 ↘	10.3 *	10.2 *
beste Teiler	140.2 (22.)	163.4 (29.)	187.2 (30.)		
Trefferlage	3.14 mm rechts, 0.64 mm tief				
Streuwert	3.95, horizontal: 4.61, vertikal: 3.14				

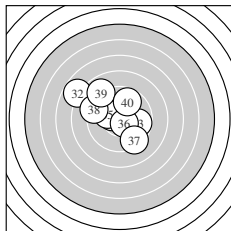

Serie 4:	10.6 *	7.8 ↖	9.8 →	10.5 *	10.1 ↖
	10.5 *	9.3 ↘	9.2 ↖	8.9 ↖	9.7 ↑
beste Teiler	100.1 (31.)	101.2 (36.)	123.6 (34.)		
Trefferlage	0.88 mm links, 0.96 mm hoch				
Streuwert	2.74, horizontal: 3.09, vertikal: 2.33				

Unterschrift des Schützen

Ergebnis:	388	(403.1)
Serien:	98 95 96 99	
Zähler:	29 10 1 0 0 0 0 0 0 0	
Innenzehner:	19	
weiteste:	584 (17), 500 (30), 428 (11)	
beste Teiler	23.0 (40.) 27.3 (36.) 39.5 (19.)	
Trefferlage	0.29 mm links, 0.08 mm hoch	
Streuwert	1.78, horizontal: 1.85, vertikal: 1.70	

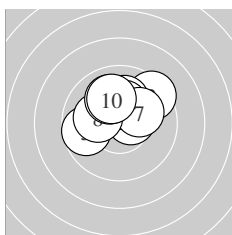
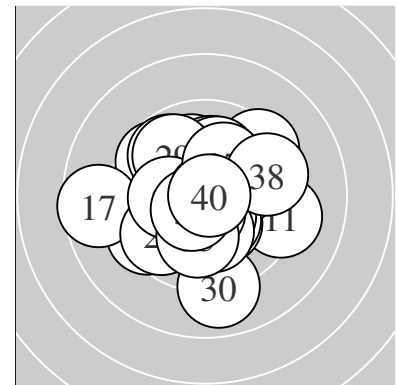

Serie 1:				
	10.5 *	9.4 ↗	10.1 ↑	10.3 *
	10.3 *	10.1 ↘	10.1 ←	9.7 ←
beste Teiler	105.7 (1.) 170.8 (4.) 173.3 (6.)			
Trefferlage	0.07 mm links, 1.33 mm hoch			
Streuwert	1.44, horizontal: 1.75, vertikal: 1.03			

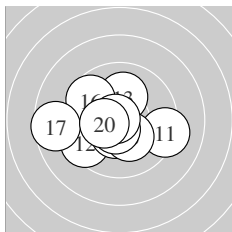

Serie 2:				
	9.2 →	9.5 ↙	10.1 ↑	10.4 *
	9.7 ↘	8.6 ←	10.6 *	10.3 *
beste Teiler	39.5 (19.) 90.4 (18.) 129.6 (14.)			
Trefferlage	0.88 mm links, 0.34 mm tief			
Streuwert	2.11, horizontal: 2.65, vertikal: 1.37			

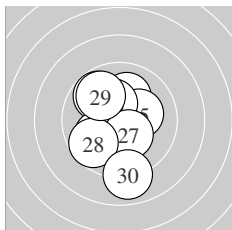

Serie 3:				
	10.1 ↑	10.4 *	9.8 ↘	10.0 ↙
	10.3 *	10.3 *	9.7 ↙	10.2 *
beste Teiler	148.2 (22.) 154.0 (27.) 162.8 (26.)			
Trefferlage	0.48 mm links, 0.25 mm tief			
Streuwert	1.96, horizontal: 1.44, vertikal: 2.37			

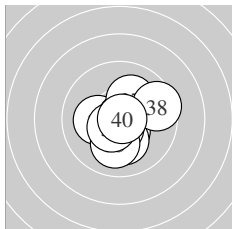

Serie 4:				
	10.5 *	10.2 *	10.2 *	10.6 *
	10.8 *	10.1 ↑	9.5 →	10.1 ↓
beste Teiler	23.0 (40.) 27.3 (36.) 85.0 (34.)			
Trefferlage	0.26 mm rechts, 0.38 mm tief			
Streuwert	1.31, horizontal: 1.37, vertikal: 1.25			

Unterschrift des Schützen

Ergebnis: **344** (363.5)
 Serien: 89 83 83 89
 Zähler: 7 16 12 4 1 0 0 0 0 0
 Innenzehner: 5
 weiteste: 1239 (13), 915 (24), 829 (3)
 beste Teiler 41.7 (32.) 139.0 (16.) 143.3 (36.)
 Trefferlage 0.09 mm rechts, 1.32 mm tief
 Streuwert 3.67, horizontal: 4.44, vertikal: 2.67

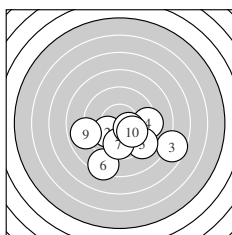
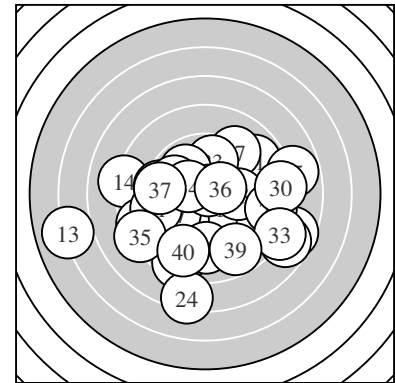

Serie 1:
 9.9 ↘ 10.1 ↙ 7.6 → 9.3 → 9.2 ↘
 8.4 ↓ 9.8 ↓ 10.4 * 8.9 ← 10.1 ↘
 beste Teiler 148.9 (8.) 213.6 (2.) 219.1 (10.)
 Trefferlage 1.08 mm rechts, 2.16 mm tief
 Streuwert 2.80, horizontal: 3.56, vertikal: 1.71

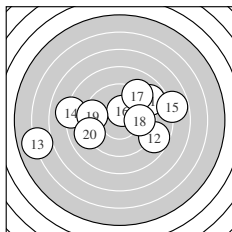

Serie 2:
 8.9 ↗ 8.7 → 6.0 ← 8.1 ← 7.8 →
 10.4 * 9.2 ↗ 9.8 → 9.3 ← 9.1 ←
 beste Teiler 139.0 (16.) 290.0 (18.) 401.6 (19.)
 Trefferlage 0.44 mm links, 0.38 mm hoch
 Streuwert 4.65, horizontal: 6.16, vertikal: 2.32

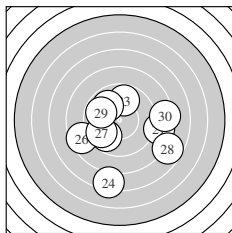

Serie 3:
 8.6 → 9.8 ↙ 9.8 ↑ 7.3 ↓ 9.9 ↖
 8.5 ← 9.7 ← 7.7 → 9.8 ↖ 8.3 →
 beste Teiler 266.3 (25.) 287.8 (29.) 291.8 (23.)
 Trefferlage 0.39 mm rechts, 1.44 mm tief
 Streuwert 3.98, horizontal: 4.43, vertikal: 3.46

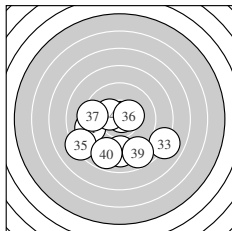

Serie 4:
 9.2 ← 10.8 * 8.0 → 10.3 * 8.3 ↙
 10.4 * 9.4 ← 9.1 ↓ 8.8 ↘ 8.8 ↓
 beste Teiler 41.7 (32.) 143.3 (36.) 158.4 (34.)
 Trefferlage 0.62 mm links, 2.08 mm tief
 Streuwert 3.09, horizontal: 3.63, vertikal: 2.45

Unterschrift des Schützen

Ergebnis:	385	(401.0)
Serien:	97	96 96 96
Zähler:	26	13 1 0 0 0 0 0 0 0
Innenzehner:	18	
weiteste:	680	(30), 447 (18), 412 (10)
beste Teiler	36.7	(21.) 64.1 (36.) 74.6 (39.)
Trefferlage	0.45 mm	links, 0.26 mm hoch
Streuwert	1.85,	horizontal: 2.04, vertikal: 1.65

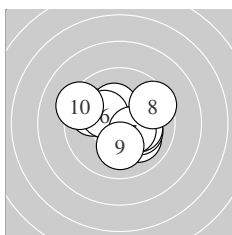
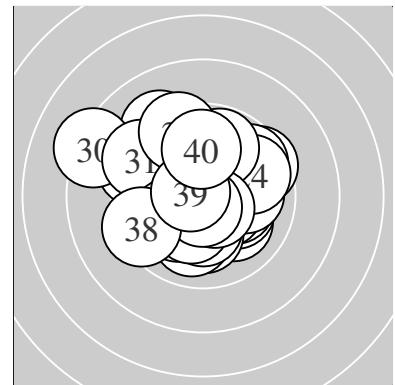

Serie 1:

9.9 ↖	10.1 ↘	10.2 *	10.3 *	10.2 *
10.3 *	10.4 *	9.5 ↗	10.1 ↓	9.3 ↖
beste Teiler	138.3 (7.)	162.5 (4.)	166.8 (6.)	
Trefferlage	0.15 mm rechts, 0.12 mm hoch			
Streuwert	1.85, horizontal: 2.21, vertikal: 1.40			

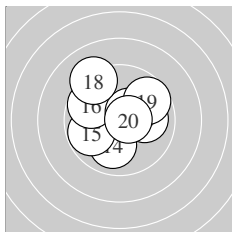

Serie 2:

10.3 *	10.1 ↗	10.0 →	10.0 ↓	9.8 ↖
9.7 ↖	10.5 *	9.2 ↘	9.7 ↗	10.6 *
beste Teiler	83.2 (20.)	117.5 (17.)	168.9 (11.)	
Trefferlage	0.50 mm links, 0.27 mm hoch			
Streuwert	1.90, horizontal: 2.04, vertikal: 1.76			

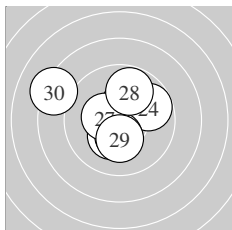

Serie 3:

10.8 *	10.0 ↗	10.3 *	9.8 ↗	10.3 *
10.4 *	10.4 *	9.8 ↑	10.3 *	8.2 ↖
beste Teiler	36.7 (21.)	141.2 (27.)	147.4 (26.)	
Trefferlage	0.23 mm links, 0.54 mm hoch			
Streuwert	2.08, horizontal: 2.42, vertikal: 1.67			

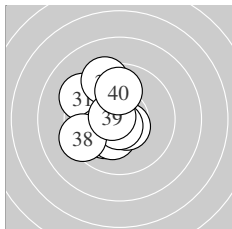

Serie 4:

9.3 ↖	10.1 ↖	10.1 ↖	10.3 *	10.6 *
10.7 *	9.4 ↘	9.4 ↖	10.7 *	9.9 ↑
beste Teiler	64.1 (36.)	74.6 (39.)	96.8 (35.)	
Trefferlage	1.24 mm links, 0.12 mm hoch			
Streuwert	1.70, horizontal: 1.39, vertikal: 1.96			

Unterschrift des Schützen

Meyton Elektronik

Ergebnis:	335	(352.3)
Serien:	86	84 82 83
Zähler:	7	13 13 3 3 1 0 0 0 0
Innenzehner:	6	
weiteste:	1289 (21), 1043 (32), 1008 (29)	
beste Teiler	100.0 (10.)	134.4 (11.) 160.2 (35.)
Trefferlage	0.98 mm links, 0.42 mm tief	
Streuwert	4.28, horizontal: 4.63, vertikal: 3.89	

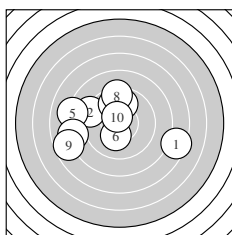
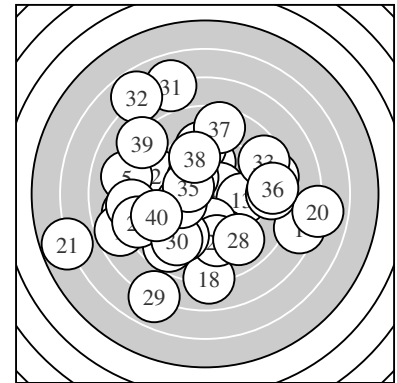

Serie 1:	7.4 →	9.1 ↖	9.8 ↗	9.8 ↑	8.1 ←
	10.2 *	8.1 ←	9.3 ↑	7.7 ←	10.6 *
beste Teiler	100.0 (10.)	186.6 (6.)	283.4 (4.)		
Trefferlage	1.89 mm links, 0.42 mm hoch				
Streuwert	3.84, horizontal: 4.75, vertikal: 2.62				

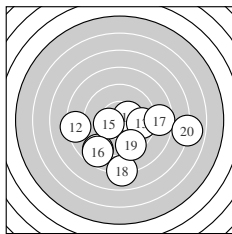

Serie 2:	10.4 *	8.3 ←	9.6 →	8.8 ↙	10.3 *
	8.7 ↘	8.6 →	8.0 ↓	9.4 ↘	6.9 →
beste Teiler	134.4 (11.)	166.6 (15.)	327.8 (13.)		
Trefferlage	0.77 mm rechts, 2.28 mm tief				
Streuwert	3.84, horizontal: 4.79, vertikal: 2.57				

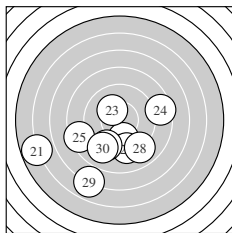

Serie 3:	5.8 ←	9.9 ↓	10.2 *	8.5 →	8.4 ←
	9.3 ↓	9.3 ↙	9.0 ↘	6.9 ↙	9.1 ↙
beste Teiler	181.8 (23.)	266.3 (22.)	415.5 (27.)		
Trefferlage	1.74 mm links, 3.13 mm tief				
Streuwert	4.16, horizontal: 5.04, vertikal: 3.03				

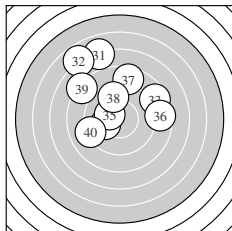

Serie 4:	7.0 ↗	6.8 ↘	8.6 ↗	10.1 ←	10.3 *
	8.6 →	8.6 ↑	9.6 ↗	8.1 ↖	9.1 ←
beste Teiler	160.2 (35.)	222.3 (34.)	334.8 (38.)		
Trefferlage	1.09 mm links, 3.29 mm hoch				
Streuwert	3.98, horizontal: 4.13, vertikal: 3.83				

Unterschrift des Schützen

Ergebnis:	385	(402.3)
Serien:	95	98 97 95
Zähler:	26	13 1 0 0 0 0 0 0 0
Innenzehner:	18	
weiteste:	611	(32), 500 (3), 495 (23)
beste Teiler	40.1	(28.) 43.4 (35.) 45.6 (2.)
Trefferlage	0.13 mm	links, 0.45 mm hoch
Streuwert	1.88,	horizontal: 1.83, vertikal: 1.93

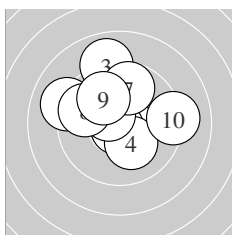
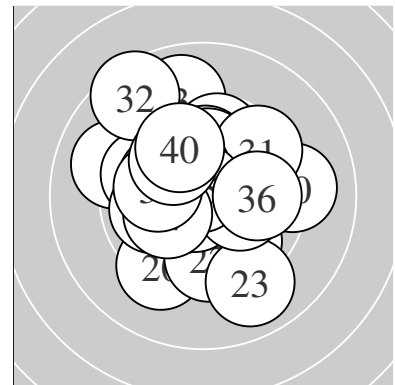

Serie 1:	10.8 *	10.8 *	9.0 ↑	10.2 *	10.5 *
	9.1 ↖	9.7 ↑	9.7 ↖	10.0 ↘	9.1 →
beste Teiler	45.6 (2.)	47.7 (1.)	116.6 (5.)		
Trefferlage	0.42 mm links, 1.18 mm hoch				
Streuwert	2.14, horizontal: 2.41, vertikal: 1.83				

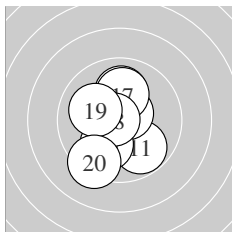

Serie 2:	9.8 ↘	10.7 *	10.7 *	10.0 ↑	10.6 *
	10.0 ↙	10.1 ↑	10.7 *	10.1 ↖	9.3 ↙
beste Teiler	52.3 (12.)	53.2 (18.)	70.5 (13.)		
Trefferlage	0.31 mm links, 0.06 mm tief				
Streuwert	1.60, horizontal: 1.19, vertikal: 1.93				

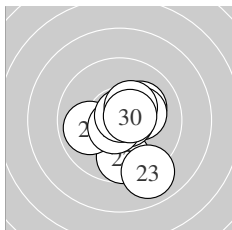

Serie 3:	10.1 ↗	9.7 ↓	9.0 ↘	10.2 *	9.9 ←
	10.7 *	10.7 *	10.8 *	10.4 *	10.6 *
beste Teiler	40.1 (28.)	66.0 (26.)	73.6 (27.)		
Trefferlage	0.58 mm rechts, 0.53 mm tief				
Streuwert	1.60, horizontal: 1.37, vertikal: 1.80				

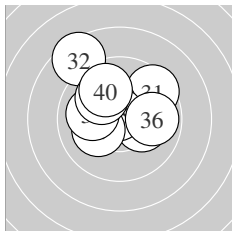

Serie 4:	9.5 ↗	8.5 ↘	10.3 *	10.2 *	10.8 *
	9.9 →	10.2 *	10.0 ←	10.0 ↘	9.9 ↘
beste Teiler	43.4 (35.)	151.4 (33.)	194.0 (34.)		
Trefferlage	0.38 mm links, 1.22 mm hoch				
Streuwert	1.97, horizontal: 2.16, vertikal: 1.77				

Unterschrift des Schützen

Meyton Elektronik

Ergebnis:	378	(395.3)
Serien:	93 97 95 93 9	
Zähler:	20 19 2 0 0 0 0 0 0	
Innenzehner:	15	
weiteste:	651 (1), 526 (36), 484 (40)	
beste Teiler	68.7 (12.) 87.5 (26.) 99.1 (4.)	
Trefferlage	0.08 mm links, 0.19 mm hoch	
Streuwert	2.13, horizontal: 2.34, vertikal: 1.89	

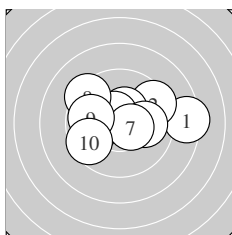
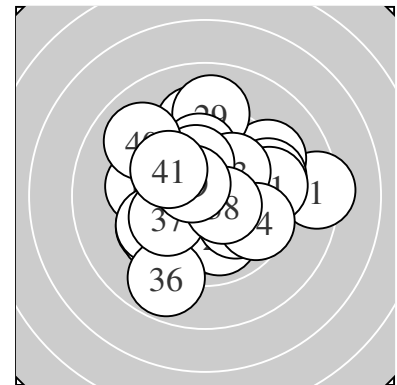

Serie 1:

8.3 →	9.4 ↗	10.4 *	10.6 *	10.0 →
9.9 ←	10.5 *	9.3 ↘	9.8 ←	9.6 ←
beste Teiler	99.1 (4.)	115.4 (7.)	135.4 (3.)	
Trefferlage	0.19 mm rechts, 0.45 mm hoch			
Streuwert	2.43, horizontal: 3.20, vertikal: 1.27			

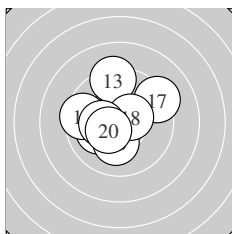

Serie 2:

10.5 *	10.7 *	9.3 ↑	10.1 ←	9.5 ←
10.2 *	9.3 ↗	10.5 *	10.3 *	10.4 *
beste Teiler	68.7 (12.)	106.2 (11.)	115.4 (18.)	
Trefferlage	0.57 mm links, 0.49 mm hoch			
Streuwert	1.82, horizontal: 1.92, vertikal: 1.70			

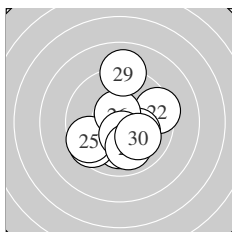

Serie 3:

10.0 ↓	9.4 →	9.6 ↙	10.2 *	9.6 ↙
10.6 *	10.5 *	9.9 ↓	9.0 ↑	10.0 ↘
beste Teiler	87.5 (26.)	120.2 (27.)	192.7 (24.)	
Trefferlage	0.26 mm rechts, 0.52 mm tief			
Streuwert	2.11, horizontal: 1.99, vertikal: 2.22			

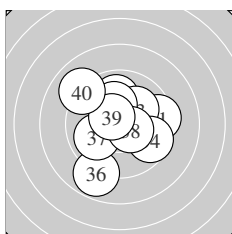

Serie 4:

9.4 →	9.9 ↑	10.1 ↗	9.6 ↘	10.2 *
8.8 ↘	9.9 ←	10.5 *	10.5 *	9.0 ↘
beste Teiler	103.3 (39.)	118.9 (38.)	195.6 (35.)	
Trefferlage	0.04 mm links, 0.23 mm hoch			
Streuwert	2.36, horizontal: 2.37, vertikal: 2.34			

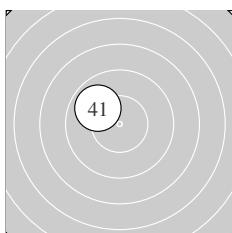

Serie 5:

9.9 ↘				
beste Teiler	2.11 mm links, 1.54 mm hoch			
Trefferlage	0.00, horizontal: 0.00, vertikal: 0.00			
Streuwert				

Unterschrift des Schützen

Meyton Elektronik

Ergebnis:	386	(403.0)
Serien:	97 96 95 98 9	
Zähler:	29 9 3 0 0 0 0 0 0 0	
Innenzehner:	23	
weiteste:	568 (27), 520 (20), 508 (38)	
beste Teiler	17.0 (34.) 36.0 (25.) 55.0 (10.)	
Trefferlage	0.03 mm rechts, 0.44 mm hoch	
Streuwert	1.83, horizontal: 1.97, vertikal: 1.67	

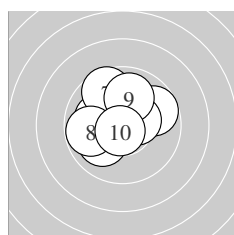
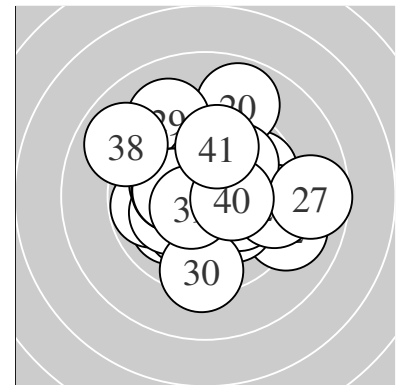

Serie 1:

10.1 ↖	10.0 ↙	10.4 *	9.7 →	10.5 *
10.4 *	9.6 ↘	9.8 ←	10.0 ↑	10.7 *
beste Teiler	55.0 (10.) 101.5 (5.) 130.9 (6.)			
Trefferlage	0.17 mm links, 0.65 mm hoch			
Streuwert	1.59, horizontal: 1.79, vertikal: 1.35			

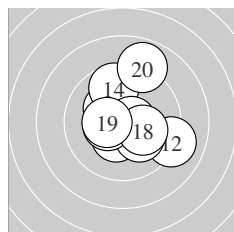

Serie 2:

10.4 *	9.1 →	10.2 *	9.7 ↑	10.1 ↘
10.6 *	10.4 *	10.2 *	10.4 *	8.9 ↑
beste Teiler	78.2 (16.) 136.5 (17.) 140.0 (19.)			
Trefferlage	0.48 mm rechts, 0.37 mm hoch			
Streuwert	2.01, horizontal: 1.89, vertikal: 2.13			

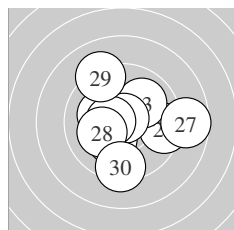

Serie 3:

10.2 *	9.4 →	10.0 ↗	10.2 *	10.8 *
10.5 *	8.7 →	10.1 ↖	9.1 ↘	9.3 ↓
beste Teiler	36.0 (25.) 107.2 (26.) 181.7 (24.)			
Trefferlage	0.33 mm rechts, 0.02 mm tief			
Streuwert	2.36, horizontal: 2.60, vertikal: 2.10			

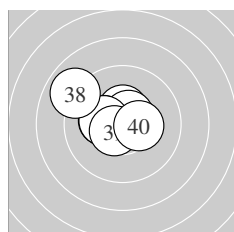

Serie 4:

10.5 *	10.6 *	10.4 *	10.9 *	10.3 *
10.6 *	10.3 *	8.9 ↘	10.6 *	10.4 *
beste Teiler	17.0 (34.) 81.9 (32.) 94.3 (36.)			
Trefferlage	0.57 mm links, 0.55 mm hoch			
Streuwert	1.35, horizontal: 1.67, vertikal: 0.93			

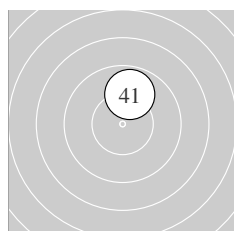

Serie 5:

9.9 ↑				
beste Teiler				
Trefferlage	0.64 mm rechts, 2.65 mm hoch			
Streuwert	0.00, horizontal: 0.00, vertikal: 0.00			

Unterschrift des Schützen

Meyton Elektronik

Ergebnis:	369	(386.9)
Serien:	93 94 91 91 7	
Zähler:	14 21 5 1 0 0 0 0 0 0	
Innenzehner:	9	
weiteste:	748 (21), 642 (22), 559 (31)	
beste Teiler	60.6 (35.) 78.6 (23.) 85.0 (12.)	
Trefferlage	1.07 mm rechts, 0.21 mm tief	
Streuwert	2.55, horizontal: 3.15, vertikal: 1.76	

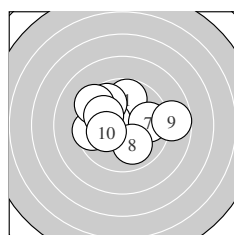
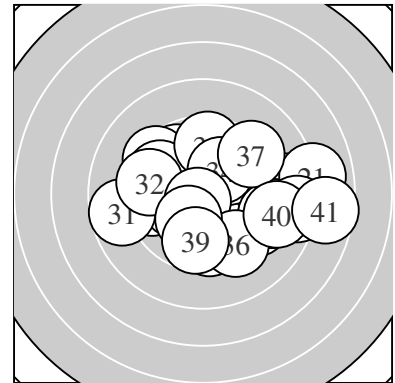

Serie 1:

9.8 ↑	10.4 *	9.6 ←	9.7 ↖	9.4 ↖
10.0 ↖	9.8 →	10.0 ↓	8.7 →	10.2 *
beste Teiler	139.4 (2.) 196.6 (10.) 239.7 (6.)			
Trefferlage	0.36 mm links, 0.66 mm hoch			
Streuwert	2.32, horizontal: 2.86, vertikal: 1.59			

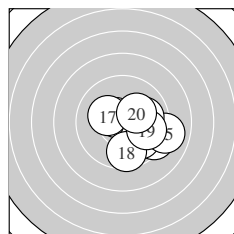

Serie 2:

9.6 ↘	10.6 *	9.3 ↘	9.9 ↘	9.0 →
10.0 →	10.2 *	9.6 ↓	9.8 →	10.2 *
beste Teiler	85.0 (12.) 182.6 (17.) 186.3 (20.)			
Trefferlage	1.80 mm rechts, 0.78 mm tief			
Streuwert	1.72, horizontal: 1.96, vertikal: 1.45			

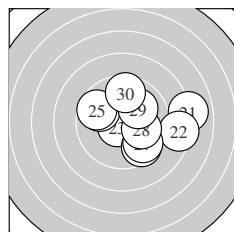

Serie 3:

8.0 →	8.4 →	10.6 *	9.8 ↖	9.7 ↖
9.6 ↘	9.7 ↘	10.1 →	10.0 ↗	9.6 ↑
beste Teiler	78.6 (23.) 225.2 (28.) 229.6 (29.)			
Trefferlage	1.62 mm rechts, 0.11 mm hoch			
Streuwert	2.73, horizontal: 3.35, vertikal: 1.91			

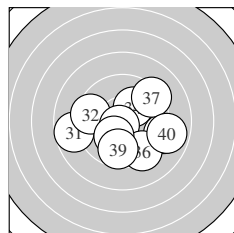

Serie 4:

8.7 ←	9.5 ←	9.0 →	10.2 *	10.7 *
9.4 ↘	9.3 ↗	10.2 *	9.7 ↓	8.9 →
beste Teiler	60.6 (35.) 195.3 (38.) 199.2 (34.)			
Trefferlage	0.52 mm rechts, 0.76 mm tief			
Streuwert	2.77, horizontal: 3.40, vertikal: 1.95			

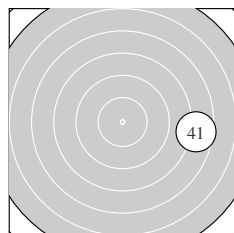

Serie 5:

7.6 →				
beste Teiler	8.26 mm rechts, 1.10 mm tief			
Trefferlage	0.00, horizontal: 0.00, vertikal: 0.00			

Unterschrift des Schützen

Meyton Elektronik

Ergebnis: **376** (394.1)
 Serien: 91 93 98 94 10
 Zähler: 19 20 2 0 0 0 0 0 0
 Innenzehner: 15
 weiteste: 638 (38), 603 (10), 468 (6)
 beste Teiler 72.0 (34.) 75.3 (2.) 91.2 (22.)
 Trefferlage 0.61 mm links, 0.32 mm hoch
 Streuwert 2.13, horizontal: 2.51, vertikal: 1.65

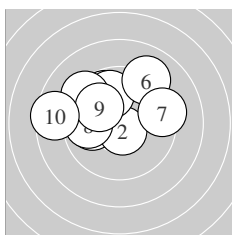
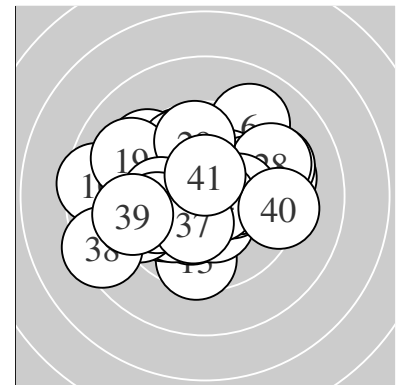

Serie 1:
 9.9 ← 10.7 * 9.8 ↖ 9.8 ↑ 9.3 ↘
 9.1 ↗ 9.3 → 9.8 ← 10.0 ↘ 8.5 ←
 beste Teiler 75.3 (2.) 237.8 (9.) 253.3 (1.)
 Trefferlage 1.20 mm links, 1.39 mm hoch
 Streuwert 2.30, horizontal: 2.87, vertikal: 1.53

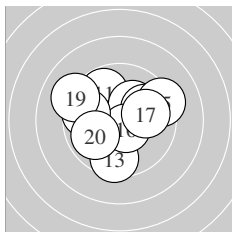

Serie 2:
 9.8 ↖ 10.2 * 9.5 ↓ 9.9 → 9.3 →
 10.6 * 10.0 → 9.7 ← 9.1 ↘ 9.9 ↖
 beste Teiler 95.4 (16.) 186.6 (12.) 249.3 (17.)
 Trefferlage 0.10 mm links, 0.43 mm hoch
 Streuwert 2.26, horizontal: 2.62, vertikal: 1.84

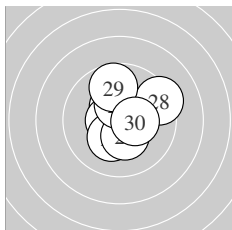

Serie 3:
 10.5 * 10.6 * 10.4 * 10.6 * 10.3 *
 10.3 * 10.4 * 9.3 → 9.7 ↑ 10.4 *
 beste Teiler 91.2 (22.) 93.0 (24.) 115.5 (21.)
 Trefferlage 0.20 mm rechts, 0.40 mm hoch
 Streuwert 1.46, horizontal: 1.40, vertikal: 1.53

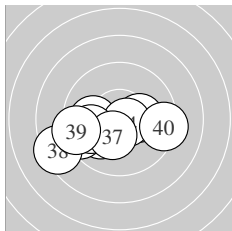

Serie 4:
 10.2 * 10.0 ← 10.0 ↙ 10.7 * 9.4 ←
 9.8 ← 10.3 * 8.4 ← 9.3 ← 9.3 →
 beste Teiler 72.0 (34.) 163.4 (37.) 183.3 (31.)
 Trefferlage 1.43 mm links, 1.01 mm tief
 Streuwert 2.18, horizontal: 2.96, vertikal: 0.86

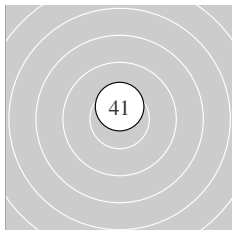

Serie 5:
 10.5 *
 beste Teiler
 Trefferlage 0.00 mm , 1.15 mm hoch
 Streuwert 0.00, horizontal: 0.00, vertikal: 0.00

Unterschrift des Schützen

Meyton Elektronik

Ergebnis:	361	(377.3)				
Serien:	90	93	87	91	7	
Zähler:	16	14	7	2	2	0 0 0 0 0
Innenzehner:	12					
weiteste:	1106 (2), 1003 (29), 870 (27)					
beste Teiler	40.8 (16.) 67.0 (34.) 68.1 (1.)					
Trefferlage	0.49 mm links, 0.75 mm hoch					
Streuwert	3.34, horizontal: 3.13, vertikal: 3.54					

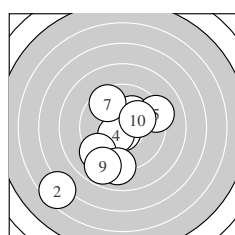
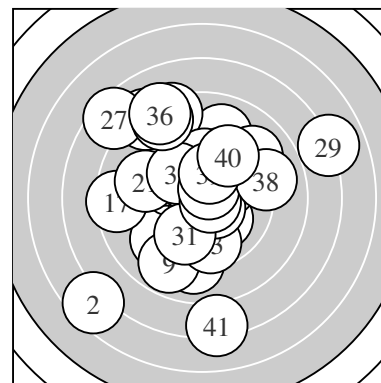

Serie 1:	10.7 *	6.5 ↙	10.2 *	10.5 *	9.2 ↗
	9.2 ↘	9.6 ↖	9.0 ↓	8.8 ↙	10.1 ↗
beste Teiler	68.1 (1.) 120.4 (4.) 195.6 (3.)				
Trefferlage	0.97 mm links, 1.46 mm tief				
Streuwert	3.35, horizontal: 3.24, vertikal: 3.46				

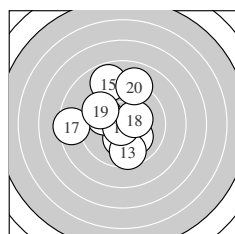

Serie 2:	10.3 *	10.1 ↘	9.6 ↓	10.0 ↖	8.8 ↖
	10.8 *	8.5 ←	10.3 *	9.7 ↖	9.0 ↑
beste Teiler	40.8 (16.) 158.2 (18.) 173.9 (11.)				
Trefferlage	0.82 mm links, 0.57 mm hoch				
Streuwert	2.56, horizontal: 2.46, vertikal: 2.66				

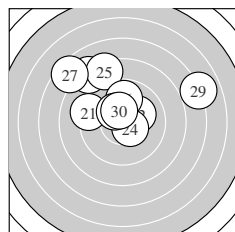

Serie 3:	9.2 ↖	10.1 ↗	8.1 ↖	10.5 *	8.3 ↖
	9.8 ↑	7.5 ↖	10.3 *	6.9 →	10.4 *
beste Teiler	117.4 (24.) 146.1 (30.) 160.0 (28.)				
Trefferlage	0.61 mm links, 2.86 mm hoch				
Streuwert	3.51, horizontal: 4.33, vertikal: 2.43				

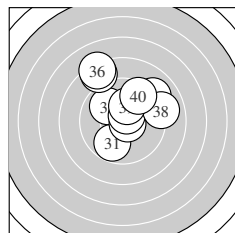

Serie 4:	9.8 ↙	9.9 ↖	8.4 ↖	10.7 *	10.6 *
	8.2 ↖	9.0 ↗	9.0 →	10.2 *	9.5 ↗
beste Teiler	67.0 (34.) 83.0 (35.) 189.8 (39.)				
Trefferlage	0.28 mm rechts, 2.07 mm hoch				
Streuwert	2.63, horizontal: 2.63, vertikal: 2.64				

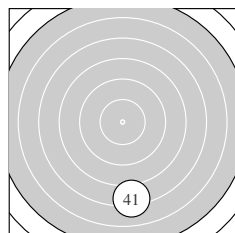

Serie 5:	7.2 ↓				
beste Teiler	1.08 mm rechts, 9.35 mm tief				
Trefferlage	0.00, horizontal: 0.00, vertikal: 0.00				
Streuwert					

Unterschrift des Schützen

Meyton Elektronik

Ergebnis:	373	(389.2)
Serien:	89 93 97 94 10	
Zähler:	20 16 4 1 0 0 0 0 0	
Innenzehner:	13	
weiteste:	854 (3), 633 (1), 618 (10)	
beste Teiler	49.0 (22.) 56.6 (37.) 72.7 (35.)	
Trefferlage	0.28 mm links, 0.18 mm tief	
Streuwert	2.48, horizontal: 2.82, vertikal: 2.09	

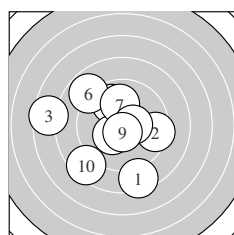
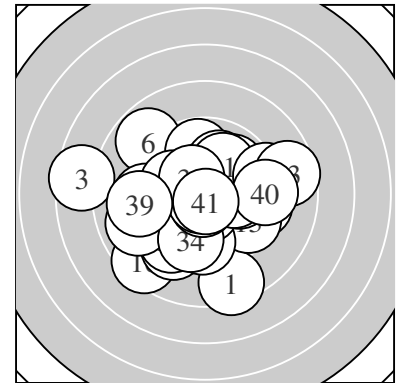

Serie 1:

8.4 ↘	9.4 →	7.5 ←	9.9 ↗	10.3 *
8.8 ↘	10.0 ↑	10.5 *	10.6 *	8.5 ↙
beste Teiler	80.0 (9.)	118.1 (8.)	162.6 (5.)	
Trefferlage	1.25 mm links, 0.36 mm tief			
Streuwert	3.29, horizontal: 3.50, vertikal: 3.07			

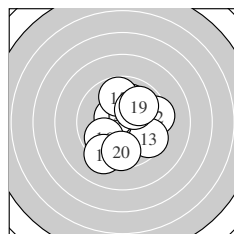

Serie 2:

10.0 ↗	9.4 →	9.6 ↘	10.5 *	9.8 ↑
9.8 ↙	10.2 *	9.3 ↙	9.9 ↗	9.6 ↓
beste Teiler	115.4 (14.)	193.8 (17.)	226.7 (11.)	
Trefferlage	0.47 mm rechts, 0.09 mm tief			
Streuwert	2.19, horizontal: 2.02, vertikal: 2.35			

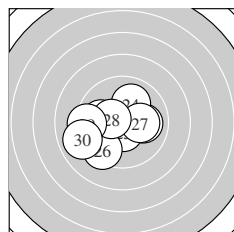

Serie 3:

10.0 →	10.8 *	10.0 ←	10.0 ↗	10.5 *
9.4 ↙	10.2 *	10.4 *	9.3 ←	9.0 ←
beste Teiler	49.0 (22.)	112.4 (25.)	132.9 (28.)	
Trefferlage	0.98 mm links, 0.38 mm tief			
Streuwert	1.98, horizontal: 2.40, vertikal: 1.43			

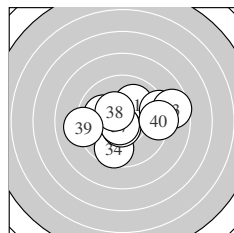

Serie 4:

10.0 ↗	9.2 →	8.6 →	9.6 ↓	10.7 *
10.0 ↖	10.7 *	10.4 *	9.1 ←	9.3 →
beste Teiler	56.6 (37.)	72.7 (35.)	142.7 (38.)	
Trefferlage	0.60 mm rechts, 0.15 mm hoch			
Streuwert	2.48, horizontal: 3.18, vertikal: 1.48			

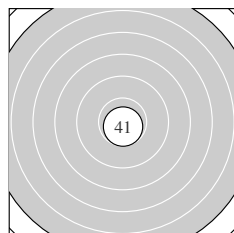

Serie 5:

10.7 *				
beste Teiler				
Trefferlage	0.05 mm rechts, 0.52 mm tief			
Streuwert	0.00, horizontal: 0.00, vertikal: 0.00			

Unterschrift des Schützen

Meyton Elektronik

Ergebnis:	363	(380.5)
Serien:	90 93 91 89 8	
Zähler:	13 18 9 1 0 0 0 0 0 0	
Innenzehner:	8	
weiteste:	874 (6), 737 (31), 716 (38)	
beste Teiler	33.1 (3.) 89.1 (23.) 93.1 (22.)	
Trefferlage	0.27 mm rechts, 0.01 mm tief	
Streuwert	2.99, horizontal: 2.14, vertikal: 3.65	

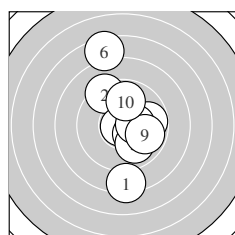
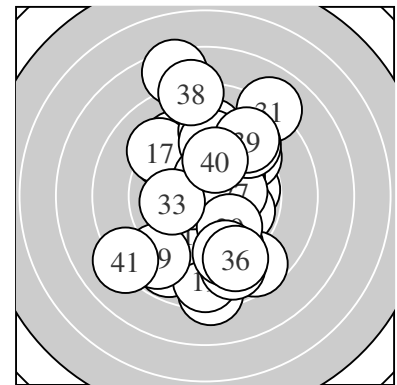

Serie 1:	8.3 ↓	9.3 ↖	10.8 *	10.4 *	9.9 ↘
	7.5 ↑	9.8 →	10.4 *	9.9 →	9.8 ↑
beste Teiler	33.1 (3.)	143.4 (8.)	146.5 (4.)		
Trefferlage	0.56 mm rechts, 0.45 mm hoch				
Streuwert	3.05, horizontal: 1.69, vertikal: 3.96				

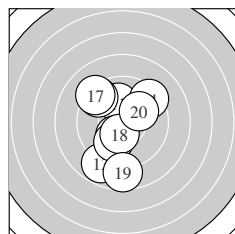

Serie 2:	10.0 ↑	10.3 *	8.8 ↙	9.3 ↗	9.4 ↖
	10.0 ↘	9.2 ↘	10.4 *	8.7 ↓	10.1 ↗
beste Teiler	139.4 (18.)	171.0 (12.)	224.9 (20.)		
Trefferlage	0.62 mm links, 0.34 mm tief				
Streuwert	2.68, horizontal: 1.96, vertikal: 3.24				

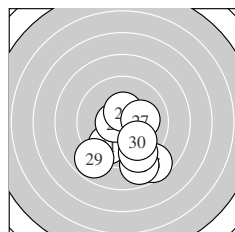

Serie 3:	9.7 ↙	10.6 *	10.6 *	10.5 *	8.6 ↘
	8.9 ↘	10.1 →	9.4 ↘	8.8 ↙	9.9 ↘
beste Teiler	89.1 (23.)	93.1 (22.)	119.1 (24.)		
Trefferlage	0.51 mm rechts, 1.95 mm tief				
Streuwert	2.20, horizontal: 2.03, vertikal: 2.36				

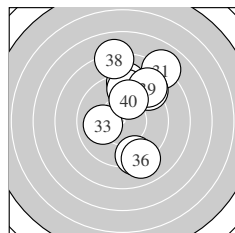

Serie 4:	8.0 ↗	9.1 ↗	10.0 ←	9.2 ↑	9.3 ↘
	9.0 ↘	9.5 ↑	8.1 ↑	9.0 ↗	9.9 ↑
beste Teiler	229.6 (33.)	255.4 (40.)	368.6 (37.)		
Trefferlage	1.20 mm rechts, 2.22 mm hoch				
Streuwert	3.08, horizontal: 1.97, vertikal: 3.89				

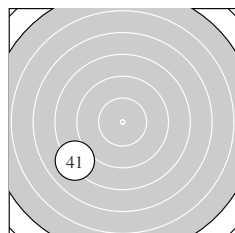

Serie 5:	8.1 ↙				
beste Teiler					
Trefferlage	5.47 mm links, 4.42 mm tief				
Streuwert	0.00, horizontal: 0.00, vertikal: 0.00				

Unterschrift des Schützen

Meyton Elektronik

Ergebnis:	367	(385.3)
Serien:	88 92 96 91 9	
Zähler:	14 21 5 1 0 0 0 0 0	
Innenzehner:	11	
weiteste:	915 (7), 670 (3), 623 (37)	
beste Teiler	66.8 (38.) 70.4 (18.) 106.3 (2.)	
Trefferlage	0.42 mm links, 0.00 mm	
Streuwert	2.67, horizontal: 3.14, vertikal: 2.10	

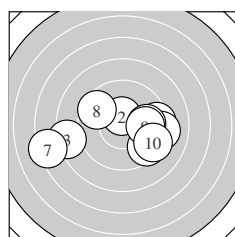
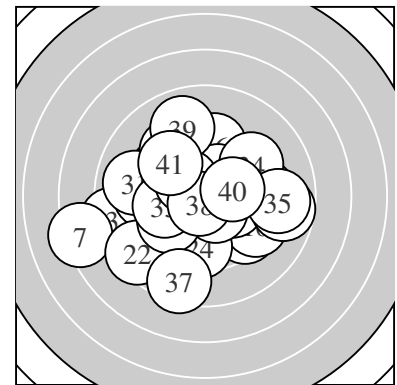

Serie 1:	9.4 →	10.5 *	8.3 ←	9.1 →	9.4 ↘
	9.8 →	7.3 ←	9.6 ↖	9.9 →	9.3 ↘
beste Teiler	106.3 (2.)	265.1 (9.)	279.5 (6.)		
Trefferlage	0.19 mm rechts, 0.62 mm tief				
Streuwert	3.50, horizontal: 4.70, vertikal: 1.55				

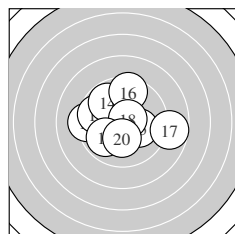

Serie 2:	9.3 ←	9.9 ↖	9.7 ↖	9.8 ↖	10.1 →
	9.5 ↑	8.7 →	10.7 *	9.9 ↗	10.2 *
beste Teiler	70.4 (18.)	186.1 (20.)	202.7 (15.)		
Trefferlage	0.44 mm links, 0.37 mm hoch				
Streuwert	2.34, horizontal: 2.79, vertikal: 1.79				

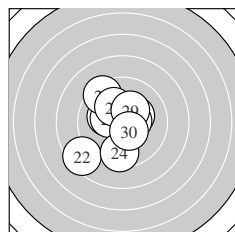

Serie 3:	10.1 ↖	8.5 ↗	10.3 *	9.5 ↓	9.4 ↘
	10.3 *	10.5 *	10.1 ↖	10.3 *	10.4 *
beste Teiler	116.6 (27.)	127.6 (30.)	160.4 (23.)		
Trefferlage	0.76 mm links, 0.02 mm tief				
Streuwert	2.11, horizontal: 1.95, vertikal: 2.25				

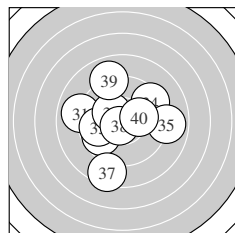

Serie 4:	9.0 ↖	9.7 ↗	9.8 ←	9.4 ↗	8.9 →
	10.3 *	8.5 ↓	10.7 *	9.0 ↖	10.2 *
beste Teiler	66.8 (38.)	165.2 (36.)	197.4 (40.)		
Trefferlage	0.50 mm links, 0.00 mm				
Streuwert	2.92, horizontal: 3.05, vertikal: 2.77				

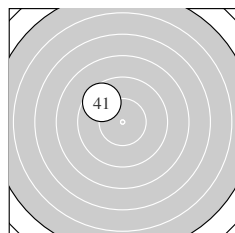

Serie 5:	9.6 ↖				
beste Teiler					
Trefferlage	2.43 mm links, 2.30 mm hoch				
Streuwert	0.00, horizontal: 0.00, vertikal: 0.00				

Unterschrift des Schützen

Meyton Elektronik