

Ergebnis:	394	(410.3)
Serien:	98 98 99 99	
Zähler:	34 6 0 0 0 0 0 0 0 0	
Innenzehner:	29	
weiteste:	426 (18), 375 (4), 355 (12)	
beste Teiler	12.0 (30.) 40.8 (29.) 46.8 (23.)	
Trefferlage	0.19 mm links, 0.12 mm hoch	
Streuwert	1.40, horizontal: 1.49, vertikal: 1.31	

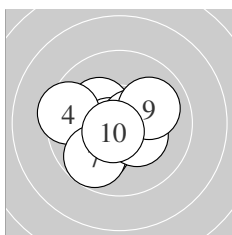

Serie 1:	10.0 ↙	10.2 *	10.6 *	9.5 ←	10.6 *
	10.7 *	9.8 ↙	10.3 *	10.0 →	10.6 *
beste Teiler	72.4 (6.)	76.2 (10.)	82.8 (3.)		
Trefferlage	0.49 mm links, 0.37 mm tief				
Streuwert	1.47, horizontal: 1.71, vertikal: 1.18				

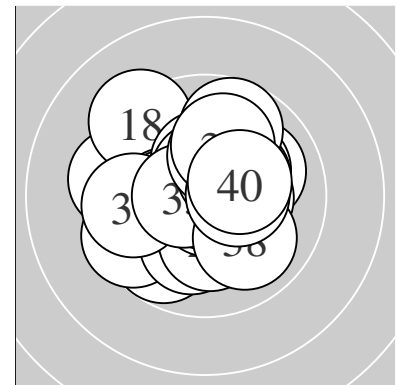
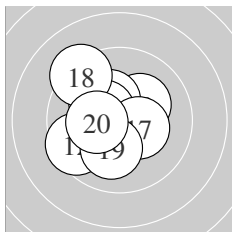

Serie 2:	10.6 *	9.5 ↙	10.2 *	10.2 *	10.3 *
	10.4 *	10.4 *	9.2 ↘	10.1 ↓	10.3 *
beste Teiler	99.1 (11.)	132.0 (16.)	147.0 (17.)		
Trefferlage	0.96 mm links, 0.31 mm hoch				
Streuwert	1.53, horizontal: 1.50, vertikal: 1.56				

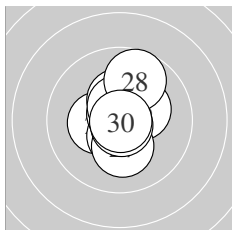

Serie 3:	10.3 *	10.5 *	10.8 *	10.4 *	10.3 *
	10.6 *	10.2 *	9.7 ↑	10.8 *	10.9 *
beste Teiler	12.0 (30.)	40.8 (29.)	46.8 (23.)		
Trefferlage	0.10 mm rechts, 0.28 mm hoch				
Streuwert	1.10, horizontal: 0.80, vertikal: 1.34				

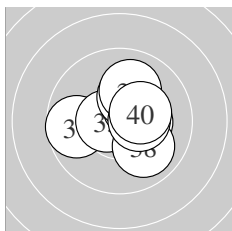

Serie 4:	9.7 ←	10.4 *	10.6 *	10.4 *	10.3 *
	10.2 *	10.0 ↑	10.0 ↘	10.4 *	10.3 *
beste Teiler	92.0 (33.)	135.1 (32.)	141.1 (39.)		
Trefferlage	0.57 mm rechts, 0.26 mm hoch				
Streuwert	1.35, horizontal: 1.50, vertikal: 1.18				

Unterschrift des Schützen

Ergebnis: **400** (417.2)
 Serien: 100 100 100 100
 Zähler: 40 0 0 0 0 0 0 0 0 0
 Innenzehner: 35
 weiteste: 225 (39), 220 (8), 218 (10)
 beste Teiler 37.8 (12.) 42.4 (31.) 46.3 (35.)
 Trefferlage 0.02 mm links, 0.27 mm hoch
 Streuwert 1.00, horizontal: 1.08, vertikal: 0.92

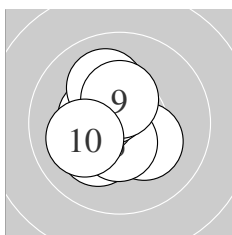
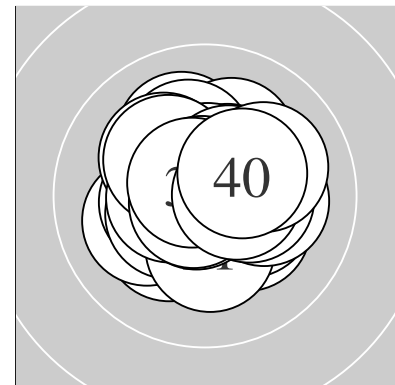

Serie 1:
 10.2 * 10.3 * 10.2 * 10.5 * 10.5 *
 10.4 * 10.5 * 10.1 ↖ 10.4 * 10.1 ←
 beste Teiler 103.5 (4.) 112.1 (5.) 116.4 (7.)
 Trefferlage 0.60 mm links, 0.18 mm hoch
 Streuwert 1.12, horizontal: 0.94, vertikal: 1.28

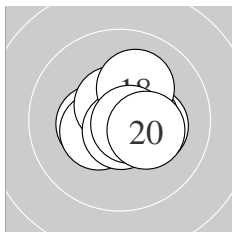

Serie 2:
 10.3 * 10.8 * 10.4 * 10.5 * 10.4 *
 10.6 * 10.7 * 10.1 ↗ 10.7 * 10.3 *
 beste Teiler 37.8 (12.) 60.6 (17.) 62.7 (19.)
 Trefferlage 0.29 mm rechts, 0.04 mm hoch
 Streuwert 0.95, horizontal: 1.09, vertikal: 0.79

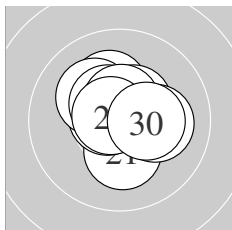

Serie 3:
 10.2 * 10.2 * 10.7 * 10.2 * 10.5 *
 10.1 → 10.5 * 10.6 * 10.7 * 10.3 *
 beste Teiler 57.2 (29.) 74.3 (23.) 97.4 (28.)
 Trefferlage 0.07 mm rechts, 0.44 mm hoch
 Streuwert 1.05, horizontal: 1.10, vertikal: 1.00

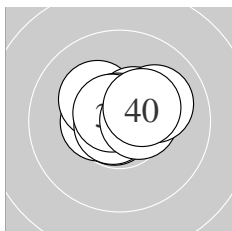

Serie 4:
 10.8 * 10.5 * 10.2 * 10.5 * 10.8 *
 10.7 * 10.7 * 10.5 * 10.1 ↗ 10.4 *
 beste Teiler 42.4 (31.) 46.3 (35.) 53.1 (36.)
 Trefferlage 0.15 mm rechts, 0.43 mm hoch
 Streuwert 0.87, horizontal: 1.10, vertikal: 0.55

Unterschrift des Schützen

Ergebnis:	396	(413.8)
Serien:	98 99 100 99	
Zähler:	36 4 0 0 0 0 0 0 0 0	
Innenzehner:	32	
weiteste:	300 (35), 283 (19), 280 (6)	
beste Teiler	48.0 (32.) 49.6 (38.) 70.0 (4.)	
Trefferlage	0.29 mm rechts, 0.15 mm hoch	
Streuwert	1.15, horizontal: 1.32, vertikal: 0.96	

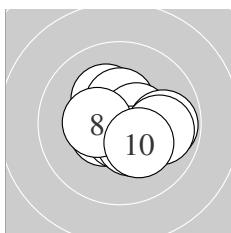
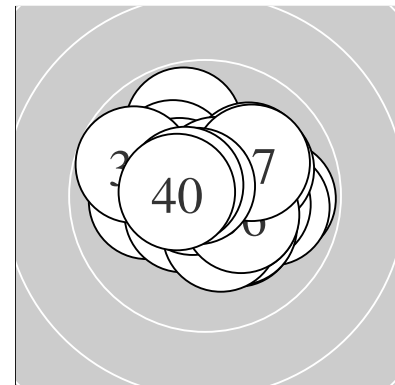

Serie 1:	10.2 *	10.4 *	10.5 *	10.7 *	10.5 *
	9.8 →	10.4 *	10.4 *	9.9 →	10.2 *
beste Teiler	70.0 (4.)	110.9 (3.)	114.4 (5.)		
Trefferlage	0.51 mm rechts, 0.09 mm tief				
Streuwert	1.22, horizontal: 1.45, vertikal: 0.95				

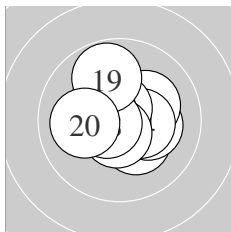

Serie 2:	10.3 *	10.2 *	10.2 *	10.4 *	10.6 *
	10.6 *	10.4 *	10.6 *	9.8 ↑	10.1 ←
beste Teiler	77.4 (15.)	82.7 (18.)	84.7 (16.)		
Trefferlage	0.05 mm rechts, 0.20 mm hoch				
Streuwert	1.25, horizontal: 1.37, vertikal: 1.12				

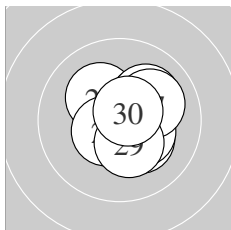

Serie 3:	10.2 *	10.2 *	10.2 *	10.5 *	10.3 *
	10.1 ↗	10.1 ↗	10.5 *	10.3 *	10.6 *
beste Teiler	79.2 (30.)	108.9 (24.)	110.8 (28.)		
Trefferlage	0.78 mm rechts, 0.09 mm hoch				
Streuwert	1.10, horizontal: 1.07, vertikal: 1.13				

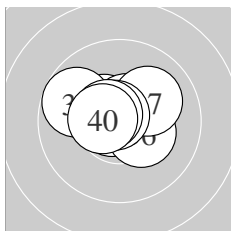

Serie 4:	10.6 *	10.8 *	10.5 *	10.6 *	9.8 ↖
	10.3 *	10.1 ↗	10.8 *	10.6 *	10.5 *
beste Teiler	48.0 (32.)	49.6 (38.)	87.7 (39.)		
Trefferlage	0.18 mm links, 0.42 mm hoch				
Streuwert	1.05, horizontal: 1.36, vertikal: 0.61				

Unterschrift des Schützen

Ergebnis: **389** (406.5)
 Serien: 97 98 97 97
 Zähler: 29 11 0 0 0 0 0 0 0 0
 Innenzehner: 24
 weiteste: 466 (3), 370 (30), 352 (27)
 beste Teiler 19.2 (11.) 71.5 (22.) 84.2 (8.)
 Trefferlage 0.41 mm rechts, 0.36 mm tief
 Streuwert 1.52, horizontal: 1.55, vertikal: 1.49

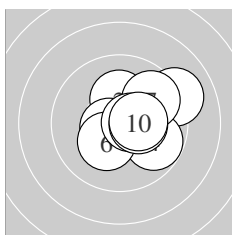
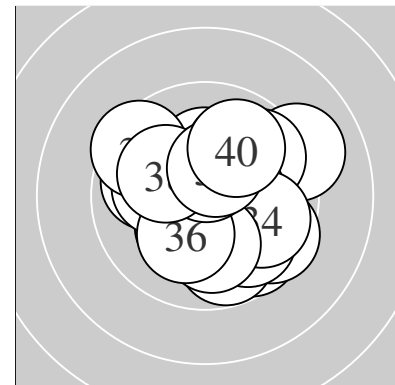

Serie 1:
 10.5 * 10.2 * 9.1 ↗ 9.8 ↘ 10.6 *
 10.3 * 9.8 ↗ 10.6 * 10.4 * 10.4 *
 beste Teiler 84.2 (8.) 87.4 (5.) 125.9 (1.)
 Trefferlage 1.21 mm rechts, 0.33 mm hoch
 Streuwert 1.43, horizontal: 1.60, vertikal: 1.24

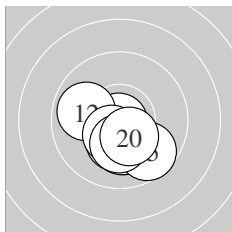

Serie 2:
 10.9 * 9.9 ← 10.2 * 10.2 * 9.7 ↘
 10.3 * 10.4 * 10.5 * 10.2 * 10.4 *
 beste Teiler 19.2 (11.) 125.2 (18.) 145.2 (20.)
 Trefferlage 0.04 mm links, 1.30 mm tief
 Streuwert 1.05, horizontal: 1.16, vertikal: 0.92

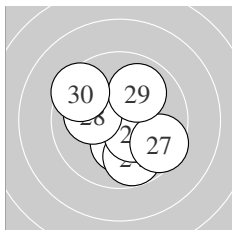

Serie 3:
 10.4 * 10.7 * 10.2 * 9.8 ↓ 10.4 *
 10.1 ← 9.5 ↘ 10.1 ← 10.0 ↗ 9.5 ↖
 beste Teiler 71.5 (22.) 128.3 (21.) 140.7 (25.)
 Trefferlage 0.02 mm links, 0.22 mm tief
 Streuwert 1.78, horizontal: 1.88, vertikal: 1.67

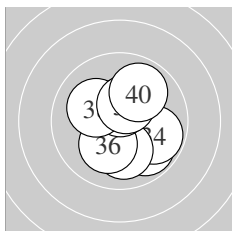

Serie 4:
 10.4 * 10.2 * 9.8 ↘ 9.8 ↘ 10.1 ↓
 10.2 * 10.5 * 10.1 ↖ 10.4 * 9.9 ↗
 beste Teiler 104.1 (37.) 137.0 (39.) 137.9 (31.)
 Trefferlage 0.52 mm rechts, 0.24 mm tief
 Streuwert 1.51, horizontal: 1.31, vertikal: 1.69

Unterschrift des Schützen

Meyton Elektronik

Ergebnis: **389** (408.6)
 Serien: 99 98 96 96
 Zähler: 29 11 0 0 0 0 0 0 0 0
 Innenzehner: 25
 weiteste: 376 (36), 355 (21), 336 (22)
 beste Teiler 15.0 (23.) 56.0 (14.) 62.7 (16.)
 Trefferlage 0.10 mm rechts, 0.31 mm hoch
 Streuwert 1.44, horizontal: 1.63, vertikal: 1.22

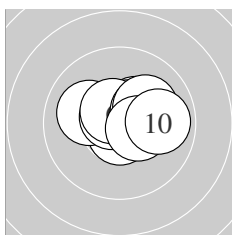
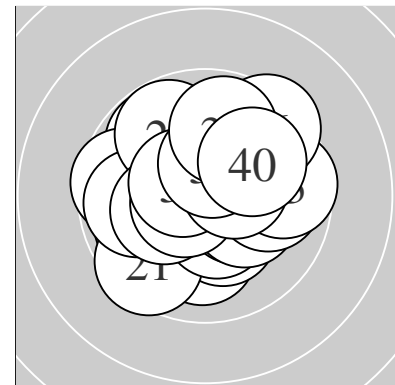

Serie 1:
 10.7 * 10.4 * 10.1 ↖ 10.7 * 10.6 *
 10.6 * 10.2 * 10.1 ↗ 10.4 * 9.9 →
 beste Teiler 64.0 (1.) 68.2 (4.) 95.8 (6.)
 Trefferlage 0.58 mm rechts, 0.47 mm hoch
 Streuwert 1.06, horizontal: 1.38, vertikal: 0.58

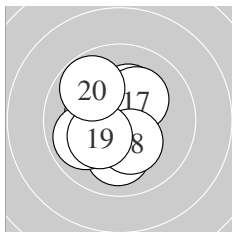

Serie 2:
 10.0 ↓ 10.3 * 10.3 * 10.7 * 9.9 ↙
 10.7 * 10.2 * 10.3 * 10.3 * 9.8 ↘
 beste Teiler 56.0 (14.) 62.7 (16.) 161.5 (13.)
 Trefferlage 0.53 mm links, 0.06 mm hoch
 Streuwert 1.35, horizontal: 1.20, vertikal: 1.49

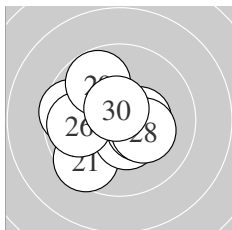

Serie 3:
 9.5 ↙ 9.6 ← 10.9 * 10.4 * 10.4 *
 9.8 ← 10.4 * 10.2 * 9.8 ↘ 10.6 *
 beste Teiler 15.0 (23.) 82.0 (30.) 126.8 (24.)
 Trefferlage 0.54 mm links, 0.14 mm tief
 Streuwert 1.61, horizontal: 1.82, vertikal: 1.36

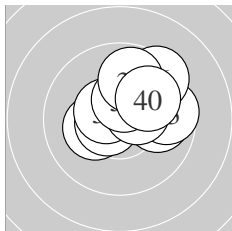

Serie 4:
 10.2 * 9.9 → 9.6 → 10.6 * 10.5 *
 9.4 ↗ 10.4 * 10.4 * 9.8 ↑ 10.0 ↗
 beste Teiler 89.8 (34.) 107.1 (35.) 131.1 (37.)
 Trefferlage 0.91 mm rechts, 0.88 mm hoch
 Streuwert 1.45, horizontal: 1.69, vertikal: 1.16

Unterschrift des Schützen

Ergebnis:	396	(413.0)
Serien:	98 99 99 100	
Zähler:	36 4 0 0 0 0 0 0 0 0	
Innenzehner:	28	
weiteste:	391 (1), 332 (4), 294 (17)	
beste Teiler	32.5 (26.) 36.0 (34.) 38.2 (2.)	
Trefferlage	0.40 mm rechts, 0.13 mm hoch	
Streuwert	1.24, horizontal: 1.26, vertikal: 1.23	

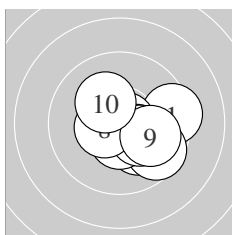
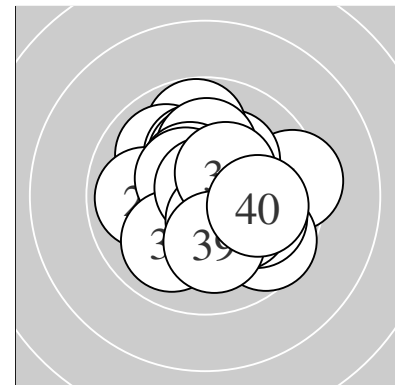

Serie 1:					
	9.4 →	10.8 *	10.1 ↘	9.6 ↘	10.4 *
	10.5 *	10.3 *	10.5 *	10.0 →	10.2 *
beste Teiler	38.2 (2.) 114.2 (8.) 115.0 (6.)				
Trefferlage	1.11 mm rechts, 0.54 mm tief				
Streuwert	1.35, horizontal: 1.59, vertikal: 1.05				

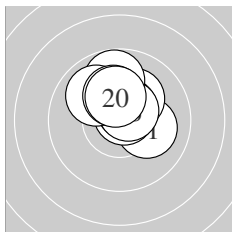

Serie 2:					
	10.1 →	10.2 *	10.7 *	10.6 *	10.3 *
	10.6 *	9.8 ↑	10.0 ↘	10.2 *	10.3 *
beste Teiler	52.6 (13.) 94.8 (16.) 99.9 (14.)				
Trefferlage	0.13 mm rechts, 1.29 mm hoch				
Streuwert	0.99, horizontal: 1.02, vertikal: 0.96				

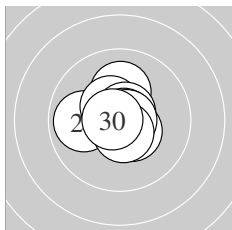

Serie 3:					
	10.5 *	10.1 ↑	9.9 ←	10.5 *	10.7 *
	10.8 *	10.5 *	10.8 *	10.6 *	10.7 *
beste Teiler	32.5 (26.) 50.0 (28.) 53.2 (30.)				
Trefferlage	0.16 mm links, 0.31 mm hoch				
Streuwert	0.95, horizontal: 0.99, vertikal: 0.91				

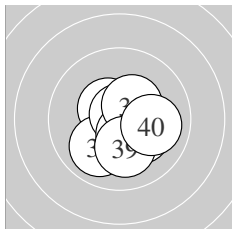

Serie 4:					
	10.5 *	10.4 *	10.0 ↙	10.8 *	10.4 *
	10.2 *	10.5 *	10.4 *	10.1 ↓	10.0 →
beste Teiler	36.0 (34.) 116.1 (31.) 119.9 (37.)				
Trefferlage	0.54 mm rechts, 0.53 mm tief				
Streuwert	1.10, horizontal: 1.12, vertikal: 1.08				

Unterschrift des Schützen

Ergebnis: **365** (382.2)
 Serien: 97 92 99 77
 Zähler: 25 11 2 0 0 0 0 0 0 0
 Innenzehner: 18
 weiteste: 3039 (39), 520 (11), 511 (19)
 beste Teiler 14.2 (1.) 21.9 (10.) 34.0 (24.)
 Trefferlage 0.07 mm rechts, 0.85 mm hoch
 Streuwert 3.89, horizontal: 2.87, vertikal: 4.69

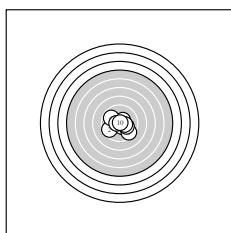
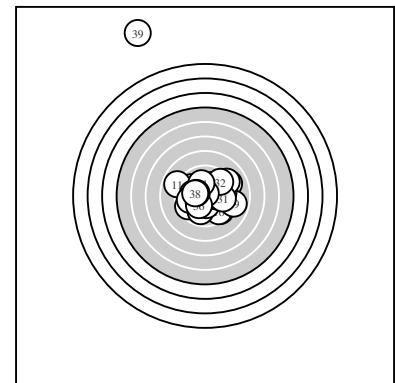

Serie 1:
 10.9 * 9.6 ↙ 10.5 * 10.5 * 9.5 ↘
 9.8 ↖ 10.1 ↗ 10.6 * 10.3 * 10.9 *
 beste Teiler 14.2 (1.) 21.9 (10.) 86.0 (8.)
 Trefferlage 0.15 mm rechts, 0.40 mm tief
 Streuwert 1.53, horizontal: 1.80, vertikal: 1.21

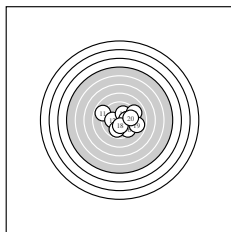

Serie 2:
 8.9 ↖ 10.1 ← 10.1 ↗ 9.1 ↗ 10.2 *
 9.5 ↘ 9.9 ↓ 10.3 * 8.9 → 9.7 →
 beste Teiler 160.2 (18.) 199.2 (15.) 204.0 (12.)
 Trefferlage 1.01 mm rechts, 0.12 mm tief
 Streuwert 2.47, horizontal: 2.97, vertikal: 1.84

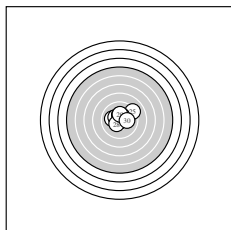

Serie 3:
 10.1 ← 10.4 * 10.1 → 10.8 * 9.2 ↗
 10.4 * 10.3 * 10.4 * 10.3 * 10.1 →
 beste Teiler 34.0 (24.) 135.0 (28.) 139.0 (22.)
 Trefferlage 0.45 mm rechts, 0.72 mm hoch
 Streuwert 1.45, horizontal: 1.75, vertikal: 1.05

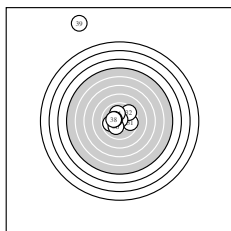

Serie 4:
 9.7 → 9.5 ↗ 10.8 * 10.0 ↑ 9.9 ←
 10.2 * 10.3 * 10.3 * 0.0 ↑
 beste Teiler 43.6 (33.) 158.7 (37.) 175.8 (38.)
 Trefferlage 1.47 mm links, 3.48 mm hoch
 Streuwert 7.24, horizontal: 4.26, vertikal: 9.32

Unterschrift des Schützen

Meyton Elektronik

Ergebnis: **398** (413.2)
 Serien: 99 100 100 99
 Zähler: 38 2 0 0 0 0 0 0 0 0
 Innenzehner: 32
 weiteste: 370 (3), 269 (37), 249 (36)
 beste Teiler 43.2 (22.) 52.9 (15.) 55.1 (9.)
 Trefferlage 0.07 mm rechts, 0.09 mm hoch
 Streuwert 1.21, horizontal: 1.37, vertikal: 1.03

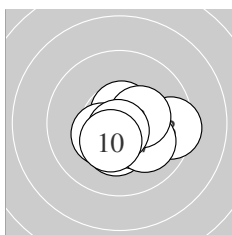
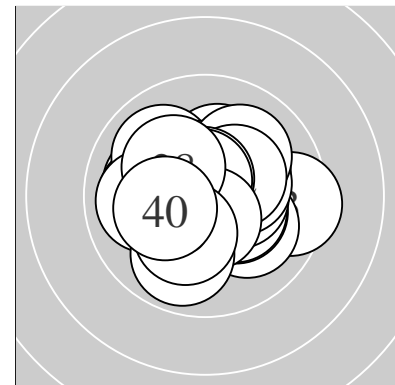

Serie 1:
 10.3 * 10.6 * 9.5 → 10.3 * 10.4 *
 10.4 * 10.1 ↘ 10.3 * 10.7 * 10.4 *
 beste Teiler 55.1 (9.) 81.2 (2.) 140.8 (6.)
 Trefferlage 0.72 mm rechts, 0.62 mm tief
 Streuwert 1.16, horizontal: 1.45, vertikal: 0.76

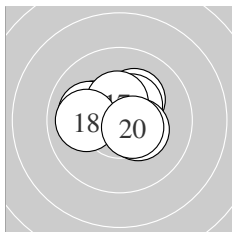

Serie 2:
 10.6 * 10.2 * 10.2 * 10.4 * 10.7 *
 10.1 ← 10.4 * 10.0 ← 10.4 * 10.5 *
 beste Teiler 52.9 (15.) 98.7 (11.) 106.9 (20.)
 Trefferlage 0.17 mm links, 0.48 mm hoch
 Streuwert 1.14, horizontal: 1.44, vertikal: 0.72

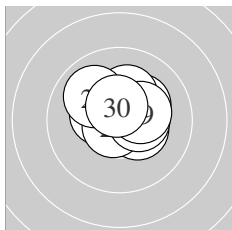

Serie 3:
 10.4 * 10.8 * 10.4 * 10.2 * 10.7 *
 10.4 * 10.2 * 10.0 ↘ 10.3 * 10.5 *
 beste Teiler 43.2 (22.) 65.0 (25.) 103.1 (30.)
 Trefferlage 0.23 mm rechts, 0.58 mm hoch
 Streuwert 1.03, horizontal: 1.21, vertikal: 0.82

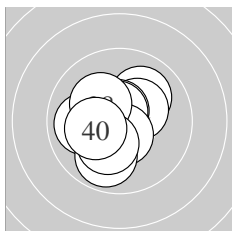

Serie 4:
 10.0 ↗ 10.3 * 10.7 * 10.7 * 10.6 *
 10.0 ← 9.9 ↓ 10.2 * 10.2 * 10.2 *
 beste Teiler 69.2 (34.) 75.9 (33.) 100.8 (35.)
 Trefferlage 0.47 mm links, 0.06 mm tief
 Streuwert 1.31, horizontal: 1.27, vertikal: 1.35

Unterschrift des Schützen

Ergebnis:	394	(412.0)
Serien:	99 96 100 99	
Zähler:	34 6 0 0 0 0 0 0 0 0	
Innenzehner:	29	
weiteste:	381 (19), 295 (5), 284 (13)	
beste Teiler	28.1 (39.) 36.0 (1.) 42.2 (18.)	
Trefferlage	0.11 mm rechts, 0.07 mm tief	
Streuwert	1.30, horizontal: 1.29, vertikal: 1.31	

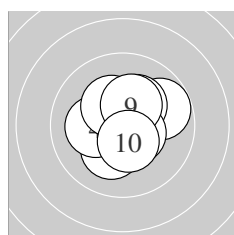
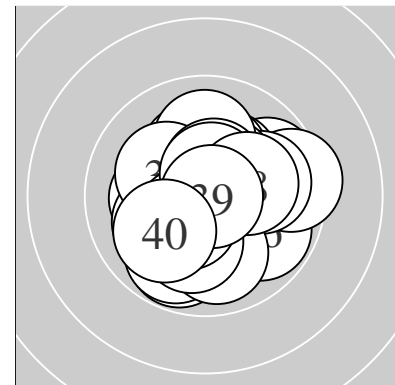

Serie 1:				
	10.8 *	10.5 *	10.2 *	10.2 *
	10.3 *	10.3 *	10.5 *	9.8 ↗
beste Teiler	36.0 (1.)	108.2 (8.)	116.2 (2.)	
Trefferlage	0.10 mm rechts, 0.27 mm hoch			
Streuwert	1.24, horizontal: 1.33, vertikal: 1.14			

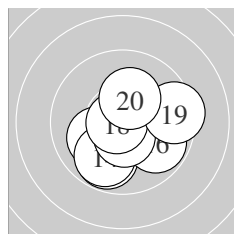

Serie 2:				
	10.1 ↙	10.6 *	9.8 ↓	9.9 ↓
	9.8 ↘	10.5 *	10.8 *	10.6 *
beste Teiler	42.2 (18.)	76.6 (12.)	96.3 (15.)	
Trefferlage	0.38 mm rechts, 0.62 mm tief			
Streuwert	1.55, horizontal: 1.72, vertikal: 1.37			

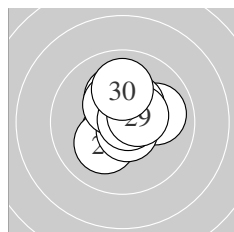

Serie 3:				
	10.0 →	10.2 *	10.5 *	10.2 *
	10.7 *	10.4 *	10.8 *	10.5 *
beste Teiler	43.8 (28.)	71.1 (26.)	112.4 (23.)	10.4 *
Trefferlage	0.17 mm rechts, 0.49 mm hoch			
Streuwert	1.15, horizontal: 1.08, vertikal: 1.22			

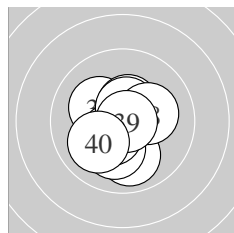

Serie 4:				
	10.2 *	10.5 *	9.9 ↓	10.1 ↓
	10.5 *	10.6 *	10.2 *	10.8 *
beste Teiler	28.1 (39.)	99.7 (37.)	119.2 (36.)	10.4 *
Trefferlage	0.19 mm links, 0.45 mm tief			
Streuwert	1.22, horizontal: 1.08, vertikal: 1.34			

Unterschrift des Schützen

Ergebnis: **397** (416.5)
 Serien: 99 100 100 98
 Zähler: 37 3 0 0 0 0 0 0 0 0
 Innenzehner: 34
 weiteste: 327 (35), 277 (10), 264 (33)
 beste Teiler 31.0 (8.) 35.2 (7.) 57.5 (19.)
 Trefferlage 0.14 mm links, 0.31 mm hoch
 Streuwert 1.05, horizontal: 1.13, vertikal: 0.95

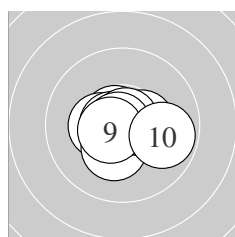
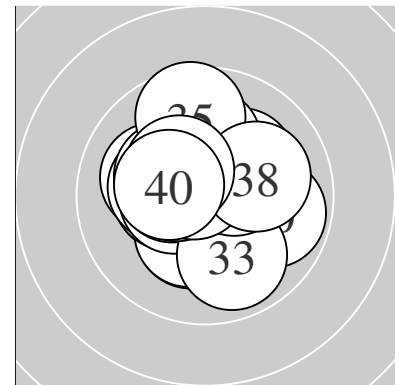

Serie 1:
 10.7 * 10.4 * 10.6 * 10.3 * 10.7 *
 10.4 * 10.8 * 10.8 * 10.6 * 9.8 →
 beste Teiler 31.0 (8.) 35.2 (7.) 68.7 (1.)
 Trefferlage 0.08 mm links, 0.22 mm tief
 Streuwert 0.95, horizontal: 1.21, vertikal: 0.58

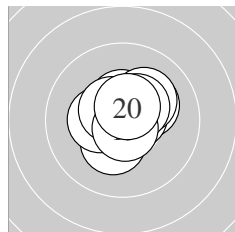

Serie 2:
 10.3 * 10.5 * 10.2 * 10.6 * 10.3 *
 10.5 * 10.2 * 10.4 * 10.7 * 10.6 *
 beste Teiler 57.5 (19.) 85.3 (14.) 97.4 (20.)
 Trefferlage 0.23 mm rechts, 0.43 mm hoch
 Streuwert 0.95, horizontal: 1.01, vertikal: 0.89

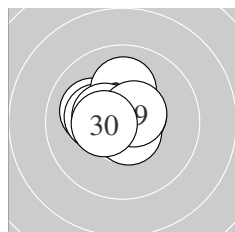

Serie 3:
 10.7 * 10.7 * 10.1 ↖ 10.2 * 10.6 *
 10.1 ↑ 10.4 * 10.6 * 10.6 * 10.5 *
 beste Teiler 59.9 (21.) 63.4 (22.) 78.5 (28.)
 Trefferlage 0.41 mm links, 0.47 mm hoch
 Streuwert 0.91, horizontal: 1.06, vertikal: 0.72

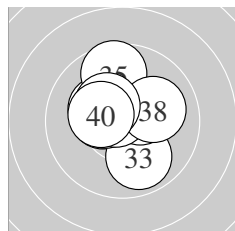

Serie 4:
 10.3 * 10.4 * 9.9 ↘ 10.4 * 9.6 ↑
 10.5 * 10.7 * 10.1 → 10.4 * 10.3 *
 beste Teiler 65.7 (37.) 122.7 (36.) 134.1 (34.)
 Trefferlage 0.32 mm links, 0.57 mm hoch
 Streuwert 1.32, horizontal: 1.29, vertikal: 1.35

Unterschrift des Schützen

Ergebnis: **388** (405.1)
 Serien: 97 97 98 96
 Zähler: 29 10 1 0 0 0 0 0 0 0
 Innenzehner: 21
 weiteste: 505 (18), 370 (12), 338 (31)
 beste Teiler 40.1 (9.) 60.8 (36.) 73.8 (6.)
 Trefferlage 0.30 mm links, 0.27 mm hoch
 Streuwert 1.60, horizontal: 1.38, vertikal: 1.79

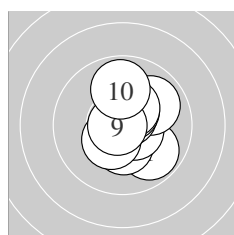
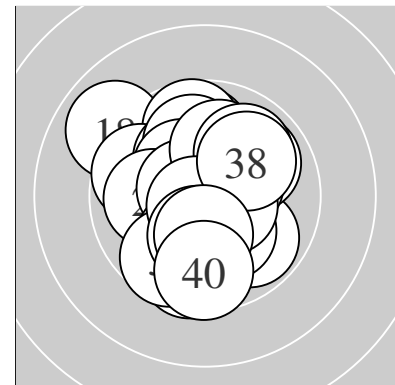

Serie 1:
 9.8 ↘ 10.3 * 10.6 * 10.4 * 9.9 ↗
 10.7 * 10.5 * 10.4 * 10.8 * 9.9 ↑
 beste Teiler 40.1 (9.) 73.8 (6.) 95.7 (3.)
 Trefferlage 0.51 mm rechts, 0.22 mm hoch
 Streuwert 1.24, horizontal: 0.96, vertikal: 1.47

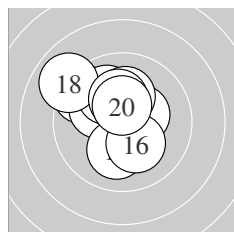

Serie 2:
 10.4 * 9.5 ↖ 10.1 ↖ 10.0 ↖ 10.1 ↓
 10.2 * 10.2 * 8.9 ↖ 10.2 * 10.4 *
 beste Teiler 126.0 (20.) 144.6 (11.) 179.0 (19.)
 Trefferlage 0.84 mm links, 1.00 mm hoch
 Streuwert 1.68, horizontal: 1.72, vertikal: 1.64

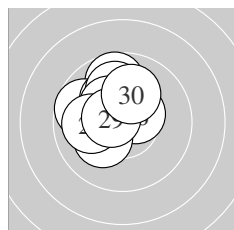

Serie 3:
 9.7 ↑ 9.7 ↖ 10.2 * 10.0 ↑ 10.3 *
 10.5 * 10.2 * 10.0 ← 10.6 * 10.1 ↑
 beste Teiler 92.4 (29.) 116.2 (26.) 161.1 (25.)
 Trefferlage 0.92 mm links, 1.11 mm hoch
 Streuwert 1.23, horizontal: 1.19, vertikal: 1.26

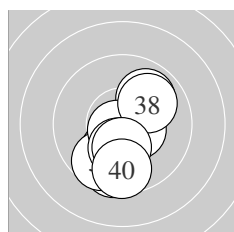

Serie 4:
 9.6 ↓ 10.1 ↓ 9.9 ↗ 9.7 ↓ 10.5 *
 10.7 * 10.2 * 10.0 ↗ 10.2 * 9.6 ↓
 beste Teiler 60.8 (36.) 113.0 (35.) 176.1 (39.)
 Trefferlage 0.05 mm rechts, 1.23 mm tief
 Streuwert 1.56, horizontal: 1.15, vertikal: 1.88

Unterschrift des Schützen

Ergebnis: **392** (408.1)
 Serien: 97 98 98 99
 Zähler: 32 8 0 0 0 0 0 0 0 0
 Innenzehner: 23
 weiteste: 376 (7), 364 (12), 308 (17)
 beste Teiler 4.4 (6.) 39.8 (39.) 68.7 (18.)
 Trefferlage 0.21 mm links, 0.05 mm hoch
 Streuwert 1.44, horizontal: 1.27, vertikal: 1.60

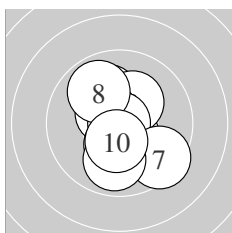
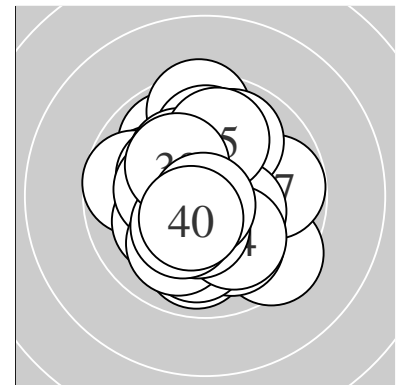

Serie 1:
 10.1 ↖ 10.5 * 10.2 * 10.5 * 10.3 *
 10.9 * 9.4 ↘ 9.9 ↖ 9.9 ↓ 10.4 *
 beste Teiler 4.4 (6.) 104.2 (2.) 118.4 (4.)
 Trefferlage 0.01 mm rechts, 0.22 mm tief
 Streuwert 1.53, horizontal: 1.22, vertikal: 1.79

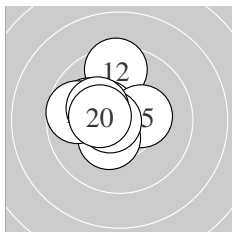

Serie 2:
 10.6 * 9.5 ↑ 10.0 ↖ 10.5 * 10.3 *
 10.4 * 9.7 ← 10.7 * 10.2 * 10.4 *
 beste Teiler 68.7 (18.) 93.5 (11.) 122.8 (14.)
 Trefferlage 1.01 mm links, 0.50 mm hoch
 Streuwert 1.25, horizontal: 1.22, vertikal: 1.29

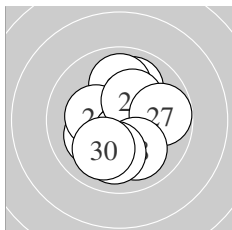

Serie 3:
 10.0 ↗ 10.1 ↖ 9.9 ↑ 10.3 * 10.5 *
 10.3 * 9.8 → 10.0 ↘ 10.0 ↓ 10.0 ↙
 beste Teiler 110.0 (25.) 168.3 (26.) 171.3 (24.)
 Trefferlage 0.13 mm rechts, 0.16 mm tief
 Streuwert 1.64, horizontal: 1.45, vertikal: 1.81

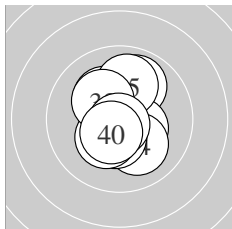

Serie 4:
 10.2 * 9.9 ↗ 10.4 * 10.1 ↘ 10.0 ↑
 10.4 * 10.3 * 10.2 * 10.8 * 10.5 *
 beste Teiler 39.8 (39.) 113.2 (40.) 133.6 (36.)
 Trefferlage 0.00 mm , 0.12 mm hoch
 Streuwert 1.33, horizontal: 0.98, vertikal: 1.61

Unterschrift des Schützen

Meyton Elektronik

Ergebnis: **395** (412.6)
 Serien: 100 98 99 98
 Zähler: 35 5 0 0 0 0 0 0 0 0
 Innenzehner: 29
 weiteste: 403 (17), 315 (34), 296 (28)
 beste Teiler 24.5 (21.) 36.4 (25.) 40.0 (6.)
 Trefferlage 0.05 mm links, 0.15 mm tief
 Streuwert 1.30, horizontal: 1.51, vertikal: 1.06

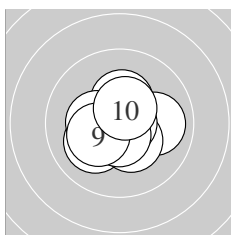
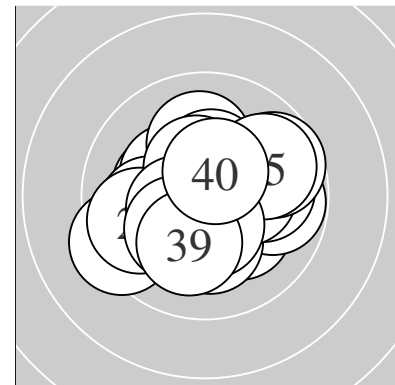

Serie 1:
 10.0 → 10.3 * 10.1 ↙ 10.8 * 10.4 *
 10.8 * 10.3 * 10.6 * 10.3 * 10.5 *
 beste Teiler 40.0 (6.) 49.0 (4.) 84.0 (8.)
 Trefferlage 0.05 mm links, 0.20 mm tief
 Streuwert 1.11, horizontal: 1.27, vertikal: 0.93

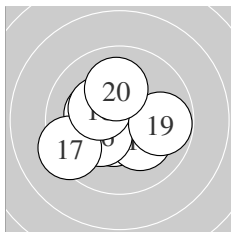

Serie 2:
 10.7 * 10.3 * 10.5 * 10.7 * 10.2 *
 10.3 * 9.3 ↙ 10.3 * 9.8 → 10.1 ↑
 beste Teiler 53.0 (11.) 70.7 (14.) 111.2 (13.)
 Trefferlage 0.53 mm links, 0.16 mm tief
 Streuwert 1.51, horizontal: 1.75, vertikal: 1.22

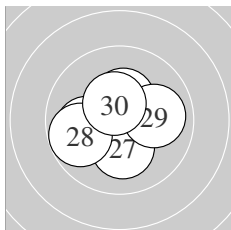

Serie 3:
 10.9 * 10.4 * 10.5 * 10.7 * 10.8 *
 10.0 ← 10.2 * 9.8 ↙ 10.0 → 10.5 *
 beste Teiler 24.5 (21.) 36.4 (25.) 69.0 (24.)
 Trefferlage 0.32 mm links, 0.21 mm tief
 Streuwert 1.25, horizontal: 1.45, vertikal: 1.02

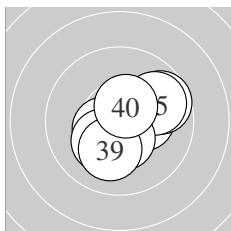

Serie 4:
 10.7 * 10.2 * 10.3 * 9.7 → 9.8 →
 10.5 * 10.2 * 10.5 * 10.1 ↓ 10.5 *
 beste Teiler 65.4 (31.) 113.8 (40.) 123.4 (36.)
 Trefferlage 0.70 mm rechts, 0.01 mm tief
 Streuwert 1.34, horizontal: 1.46, vertikal: 1.19

Unterschrift des Schützen

Meyton Elektronik

Ergebnis:	396	(413.3)
Serien:	100 100 98 98	
Zähler:	36 4 0 0 0 0 0 0 0 0	
Innenzehner:	31	
weiteste:	389 (38), 307 (39), 289 (22)	
beste Teiler	17.0 (9.) 33.7 (5.) 51.8 (3.)	
Trefferlage	0.15 mm rechts, 0.34 mm hoch	
Streuwert	1.19, horizontal: 1.26, vertikal: 1.11	

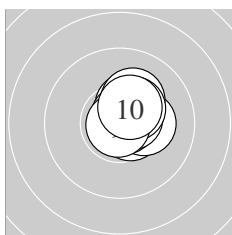
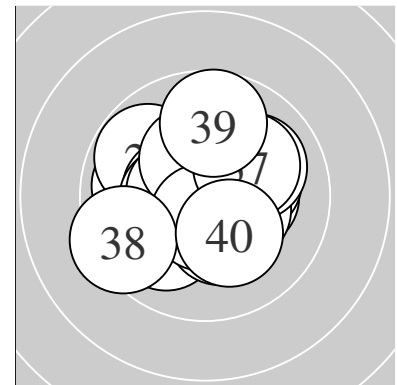

Serie 1:					
	10.6 *	10.4 *	10.7 *	10.3 *	10.8 *
	10.6 *	10.2 *	10.4 *	10.9 *	10.4 *
beste Teiler	17.0 (9.)	33.7 (5.)	51.8 (3.)		
Trefferlage	0.68 mm rechts, 0.53 mm hoch				
Streuwert	0.59, horizontal: 0.49, vertikal: 0.67				

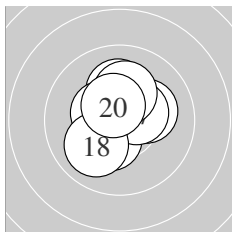

Serie 2:					
	10.6 *	10.5 *	10.1 ↑	10.2 *	10.4 *
	10.4 *	10.4 *	10.0 ↙	10.2 *	10.5 *
beste Teiler	86.2 (11.)	106.4 (12.)	111.4 (20.)		
Trefferlage	0.03 mm rechts, 0.52 mm hoch				
Streuwert	1.13, horizontal: 1.06, vertikal: 1.20				

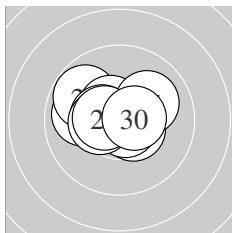

Serie 3:					
	9.9 ↖	9.8 ↖	10.5 *	10.5 *	10.7 *
	10.5 *	10.0 ↗	10.4 *	10.5 *	10.5 *
beste Teiler	55.2 (25.)	102.9 (30.)	107.0 (29.)		
Trefferlage	0.48 mm links, 0.34 mm hoch				
Streuwert	1.17, horizontal: 1.50, vertikal: 0.70				

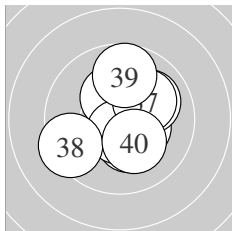

Serie 4:					
	10.4 *	10.0 ↗	10.4 *	10.3 *	10.3 *
	10.6 *	10.1 ↗	9.4 ↙	9.7 ↑	10.2 *
beste Teiler	90.2 (36.)	129.8 (33.)	147.4 (31.)		
Trefferlage	0.38 mm rechts, 0.03 mm tief				
Streuwert	1.61, horizontal: 1.55, vertikal: 1.66				

Unterschrift des Schützen

Ergebnis: **387** (405.3)
 Serien: 96 96 97 98
 Zähler: 27 13 0 0 0 0 0 0 0 0
 Innenzehner: 22
 weiteste: 454 (1), 424 (11), 369 (7)
 beste Teiler 61.4 (2.) 67.4 (14.) 98.2 (17.)
 Trefferlage 0.32 mm links, 0.04 mm hoch
 Streuwert 1.63, horizontal: 1.81, vertikal: 1.43

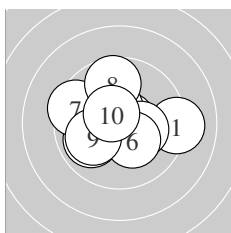
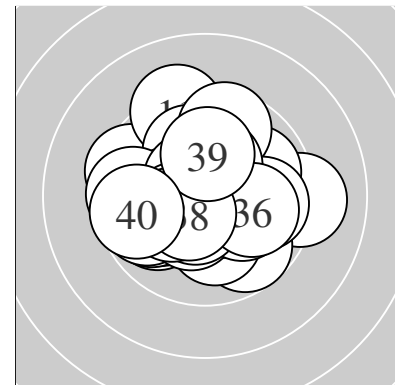

Serie 1:
 9.1 → 10.7 * 10.5 * 9.9 ↙ 10.3 *
 10.3 * 9.5 ↖ 9.7 ↑ 10.0 ↙ 10.6 *
 beste Teiler 61.4 (2.) 100.0 (10.) 123.6 (3.)
 Trefferlage 0.16 mm links, 0.20 mm hoch
 Streuwert 1.90, horizontal: 2.29, vertikal: 1.41

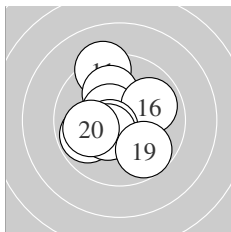

Serie 2:
 9.3 ↑ 10.1 ↑ 9.8 ↙ 10.7 * 10.6 *
 9.9 → 10.6 * 10.4 * 9.7 ↘ 10.0 ↖
 beste Teiler 67.4 (14.) 98.2 (17.) 100.8 (15.)
 Trefferlage 0.57 mm links, 0.22 mm hoch
 Streuwert 1.71, horizontal: 1.58, vertikal: 1.84

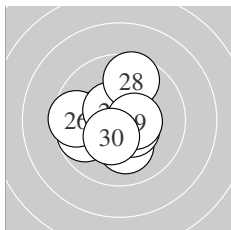

Serie 3:
 9.8 ↙ 10.1 ↓ 10.3 * 10.5 * 10.5 *
 9.6 ↖ 10.5 * 9.6 ↑ 10.5 * 10.4 *
 beste Teiler 105.6 (27.) 116.4 (29.) 119.4 (25.)
 Trefferlage 0.55 mm links, 0.01 mm hoch
 Streuwert 1.55, horizontal: 1.62, vertikal: 1.48

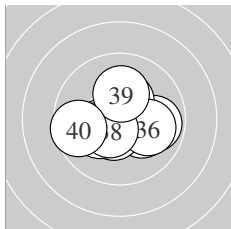

Serie 4:
 9.9 → 10.2 * 10.3 * 10.5 * 10.4 *
 10.0 → 10.2 * 10.5 * 10.2 * 9.6 ↖
 beste Teiler 113.2 (38.) 113.7 (34.) 146.7 (35.)
 Trefferlage 0.00 mm , 0.25 mm tief
 Streuwert 1.53, horizontal: 1.87, vertikal: 1.07

Unterschrift des Schützen

Meyton Elektronik