

Ergebnis: **383** (403.3)  
 Serien: 98 94 95 96  
 Zähler: 27 10 2 1 0 0 0 0 0 0  
 Innenzehner: 21  
 weiteste: 809 (21), 517 (20), 515 (17)  
 beste Teiler 24.4 (24.) 47.3 (18.) 56.0 (5.)  
 Trefferlage 0.39 mm rechts, 0.24 mm hoch  
 Streuwert 1.87, horizontal: 2.21, vertikal: 1.45

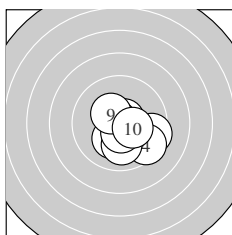

Serie 1:  
 9.5 → 10.7 \* 10.7 \* 9.5 ↘ 10.7 \*  
 10.2 \* 10.0 ↓ 10.5 \* 10.4 \* 10.3 \*  
 beste Teiler 56.0 (5.) 59.7 (2.) 66.5 (3.)  
 Trefferlage 0.71 mm rechts, 0.70 mm tief  
 Streuwert 1.36, horizontal: 1.51, vertikal: 1.21

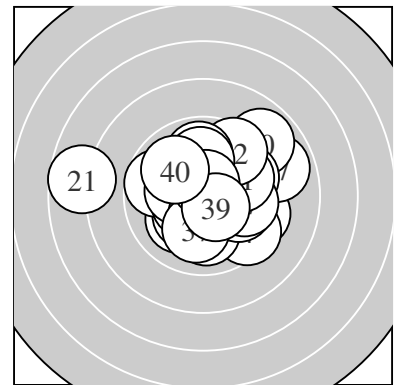
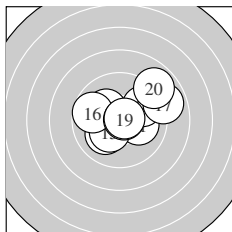

Serie 2:  
 10.1 → 10.1 ↙ 10.2 \* 9.8 ↗ 10.3 \*  
 9.7 ← 8.9 → 10.8 \* 10.7 \* 8.9 ↗  
 beste Teiler 47.3 (18.) 56.9 (19.) 168.7 (15.)  
 Trefferlage 0.71 mm rechts, 0.58 mm hoch  
 Streuwert 2.10, horizontal: 2.55, vertikal: 1.53

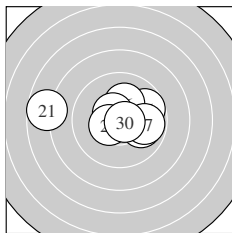

Serie 3:  
 7.7 ← 10.0 → 10.3 \* 10.9 \* 9.7 ↗  
 10.2 \* 9.8 → 10.5 \* 10.4 \* 10.7 \*  
 beste Teiler 24.4 (24.) 59.4 (30.) 106.7 (28.)  
 Trefferlage 0.03 mm rechts, 0.32 mm hoch  
 Streuwert 2.32, horizontal: 3.16, vertikal: 0.88

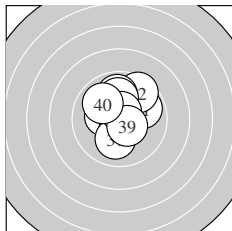

Serie 4:  
 9.9 → 9.5 ↗ 9.9 ↑ 10.0 ↑ 10.3 \*  
 10.4 \* 10.1 ↓ 10.6 \* 10.5 \* 9.9 ↘  
 beste Teiler 81.7 (38.) 112.6 (39.) 127.1 (36.)  
 Trefferlage 0.10 mm rechts, 0.77 mm hoch  
 Streuwert 1.57, horizontal: 1.38, vertikal: 1.74

Unterschrift des Schützen

Meyton Elektronik

Ergebnis: **382** (401.5)  
 Serien: 94 97 94 97  
 Zähler: 22 18 0 0 0 0 0 0 0 0  
 Innenzehner: 16  
 weiteste: 483 (10), 439 (27), 404 (24)  
 beste Teiler 9.4 (21.) 10.6 (39.) 47.0 (34.)  
 Trefferlage 0.17 mm links, 0.15 mm hoch  
 Streuwert 1.81, horizontal: 2.14, vertikal: 1.41

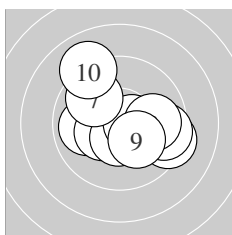
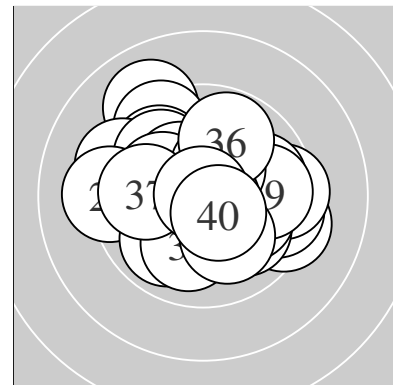

Serie 1:  
 9.9 ←                      9.3 →                      10.4 \*                      10.5 \*                      9.5 →  
 10.6 \*                      9.8 ↘                      9.9 →                      10.2 \*                      9.0 ↘  
 beste Teiler 96.0 (6.) 112.4 (4.) 148.9 (3.)  
 Trefferlage 0.37 mm rechts, 0.08 mm hoch  
 Streuwert 2.10, horizontal: 2.42, vertikal: 1.72

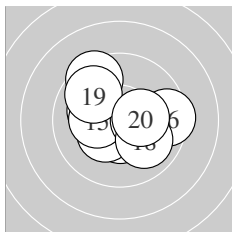

Serie 2:  
 9.5 ↘                      10.5 \*                      10.3 \*                      10.1 ↖                      10.3 \*  
 9.5 →                      10.3 \*                      10.0 ↘                      9.8 ↘                      10.3 \*  
 beste Teiler 115.1 (12.) 152.0 (17.) 152.1 (13.)  
 Trefferlage 0.00 mm , 0.26 mm hoch  
 Streuwert 1.78, horizontal: 2.07, vertikal: 1.45

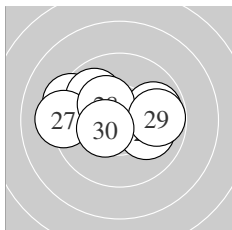

Serie 3:  
 10.9 \*                      9.9 →                      9.6 ↖                      9.3 ↖                      10.1 →  
 9.9 ↘                      9.2 ←                      10.3 \*                      9.8 →                      10.4 \*  
 beste Teiler 9.4 (21.) 130.3 (30.) 163.7 (28.)  
 Trefferlage 0.78 mm links, 0.49 mm hoch  
 Streuwert 1.99, horizontal: 2.67, vertikal: 0.88

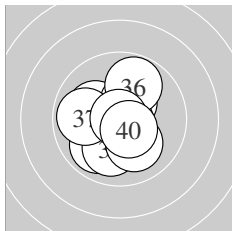

Serie 4:  
 9.9 ↗                      10.1 ↖                      10.4 \*                      10.8 \*                      10.0 ↘  
 9.8 ↗                      9.9 ←                      10.1 ↘                      10.9 \*                      10.5 \*  
 beste Teiler 10.6 (39.) 47.0 (34.) 107.6 (40.)  
 Trefferlage 0.29 mm links, 0.21 mm tief  
 Streuwert 1.47, horizontal: 1.37, vertikal: 1.56

Unterschrift des Schützen

Meyton Elektronik

Ergebnis: **385** (401.5)  
 Serien: 97 96 98 94  
 Zähler: 26 13 1 0 0 0 0 0 0 0  
 Innenzehner: 17  
 weiteste: 513 (37), 483 (5), 417 (26)  
 beste Teiler 19.2 (23.) 46.2 (2.) 65.1 (24.)  
 Trefferlage 0.05 mm links, 0.01 mm tief  
 Streuwert 1.82, horizontal: 1.72, vertikal: 1.91

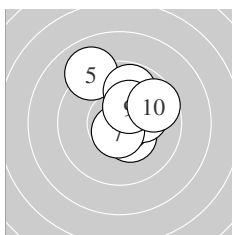
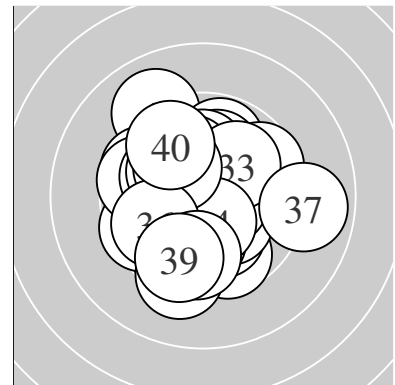

Serie 1:  
 10.4 \*                      10.8 \*                      10.3 \*                      10.2 \*                      9.0 ↘  
 10.0 ↗                      10.7 \*                      9.8 ↑                      10.3 \*                      9.7 ↗  
 beste Teiler 46.2 (2.) 71.3 (7.) 139.0 (1.)  
 Trefferlage 0.77 mm rechts, 1.15 mm hoch  
 Streuwert 1.50, horizontal: 1.38, vertikal: 1.60

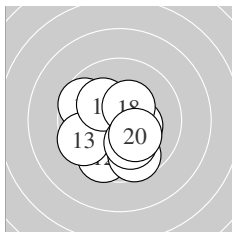

Serie 2:  
 9.7 ↖                      9.6 ↓                      9.6 ↙                      10.3 \*                      10.4 \*  
 10.2 \*                      9.7 ↓                      10.4 \*                      10.1 ↓                      10.2 \*  
 beste Teiler 136.1 (18.) 148.3 (15.) 151.5 (14.)  
 Trefferlage 0.19 mm links, 0.84 mm tief  
 Streuwert 1.73, horizontal: 1.81, vertikal: 1.65

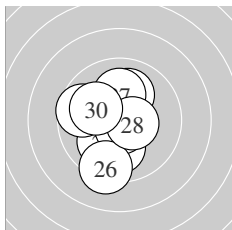

Serie 3:  
 10.0 ↓                      10.1 ↙                      10.9 \*                      10.7 \*                      10.1 ↑  
 9.3 ↓                      10.1 ↑                      10.5 \*                      9.7 ↖                      10.1 ↖  
 beste Teiler 19.2 (23.) 65.1 (24.) 111.3 (28.)  
 Trefferlage 0.58 mm links, 0.31 mm tief  
 Streuwert 1.67, horizontal: 1.31, vertikal: 1.96

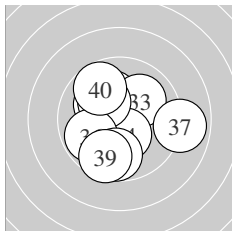

Serie 4:  
 10.1 ↖                      10.2 \*                      10.0 ↗                      10.4 \*                      10.2 \*  
 9.8 ↙                      8.9 →                      9.7 ↓                      9.6 ↓                      9.7 ↘  
 beste Teiler 138.8 (34.) 194.0 (35.) 197.9 (32.)  
 Trefferlage 0.19 mm links, 0.07 mm tief  
 Streuwert 2.14, horizontal: 2.20, vertikal: 2.08

Unterschrift des Schützen

Meyton Elektronik

Ergebnis: **389** (406.5)  
 Serien: 95 97 98 99  
 Zähler: 30 9 1 0 0 0 0 0 0 0  
 Innenzehner: 23  
 weiteste: 532 (7), 447 (4), 417 (12)  
 beste Teiler 21.2 (31.) 36.6 (34.) 46.0 (8.)  
 Trefferlage 0.48 mm links, 0.02 mm tief  
 Streuwert 1.64, horizontal: 1.75, vertikal: 1.53

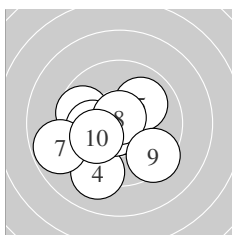
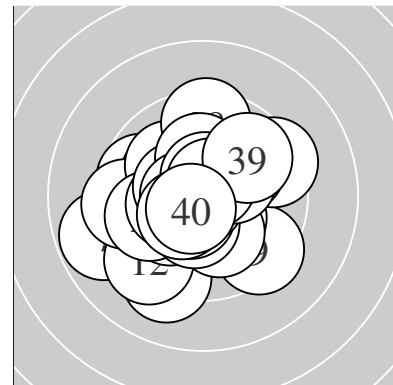

Serie 1:  
 10.7 \*                      9.7 ↖                      10.0 ←                      9.2 ↓                      10.0 ↗  
 10.7 \*                      8.8 ←                      10.8 \*                      9.4 ↘                      10.1 ←  
 beste Teiler 46.0 (8.) 65.4 (6.) 72.2 (1.)  
 Trefferlage 0.92 mm links, 0.81 mm tief  
 Streuwert 2.04, horizontal: 2.33, vertikal: 1.71

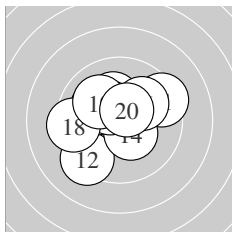

Serie 2:  
 9.4 ↗                      9.3 ↙                      10.1 ↘                      10.4 \*                      10.2 \*  
 10.0 ↗                      10.4 \*                      9.4 ←                      10.1 ↘                      10.5 \*  
 beste Teiler 103.4 (20.) 128.4 (17.) 143.2 (14.)  
 Trefferlage 0.45 mm links, 0.45 mm hoch  
 Streuwert 1.92, horizontal: 2.21, vertikal: 1.58

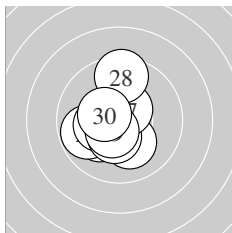

Serie 3:  
 10.1 ↙                      9.8 ←                      10.7 \*                      10.3 \*                      10.2 \*  
 10.4 \*                      10.5 \*                      9.5 ↑                      10.5 \*                      10.4 \*  
 beste Teiler 73.5 (23.) 101.7 (27.) 109.8 (29.)  
 Trefferlage 0.68 mm links, 0.24 mm tief  
 Streuwert 1.37, horizontal: 1.10, vertikal: 1.59

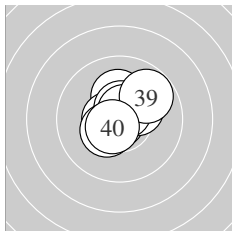

Serie 4:  
 10.9 \*                      10.3 \*                      10.2 \*                      10.8 \*                      10.6 \*  
 10.6 \*                      10.7 \*                      10.4 \*                      9.8 ↗                      10.6 \*  
 beste Teiler 21.2 (31.) 36.6 (34.) 74.6 (37.)  
 Trefferlage 0.12 mm rechts, 0.48 mm hoch  
 Streuwert 0.99, horizontal: 1.02, vertikal: 0.96

Unterschrift des Schützen

Meyton Elektronik

Ergebnis:	<b>358</b>	(378.4)
Serien:	86 91 92 89	
Zähler:	9 22 8 0 1 0 0 0 0 0	
Innenzehner:	7	
weiteste:	1080 (3), 678 (35), 662 (2)	
beste Teiler	80.0 (26.) 84.4 (13.) 88.2 (21.)	
Trefferlage	1.13 mm links, 1.16 mm hoch	
Streuwert	2.75, horizontal: 3.17, vertikal: 2.26	

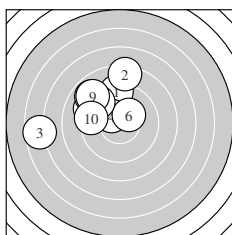
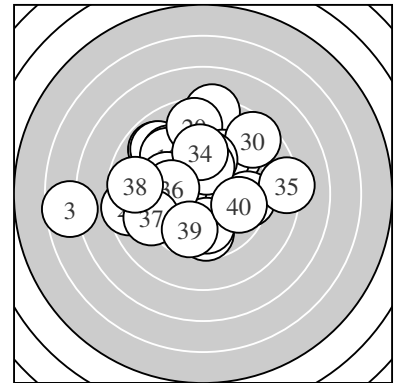

Serie 1:	9.2 ↑	8.3 ↑	6.6 ←	10.4 *	9.2 ↖
	10.3 *	9.3 ↘	8.9 ↘	8.9 ↘	9.4 ←
beste Teiler	143.0 (4.)	166.4 (6.)	389.3 (10.)		
Trefferlage	2.83 mm links, 2.43 mm hoch				
Streuwert	2.87, horizontal: 3.41, vertikal: 2.21				

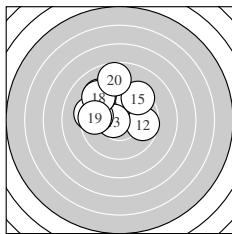

Serie 2:	10.1 ↘	9.7 →	10.6 *	9.3 ↘	9.4 ↗
	9.3 ←	9.7 ←	9.3 ↘	9.6 ←	8.7 ↑
beste Teiler	84.4 (13.)	212.0 (11.)	314.9 (12.)		
Trefferlage	1.28 mm links, 1.79 mm hoch				
Streuwert	2.17, horizontal: 2.42, vertikal: 1.89				

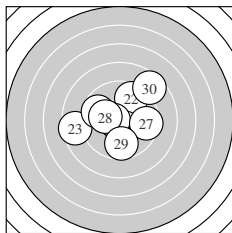

Serie 3:	10.6 *	9.6 ↗	8.5 ←	10.5 *	9.7 ↖
	10.6 *	9.5 →	10.2 *	9.7 ↓	8.6 ↗
beste Teiler	80.0 (26.)	88.2 (21.)	125.9 (24.)		
Trefferlage	0.14 mm links, 0.23 mm hoch				
Streuwert	2.60, horizontal: 2.98, vertikal: 2.15				

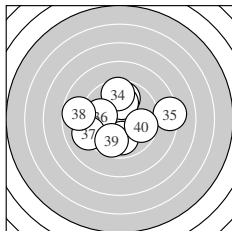

Serie 4:	9.8 ↑	9.9 ↓	10.1 ↑	9.6 ↑	8.2 →
	9.9 ←	9.1 ←	8.7 ←	9.7 ↓	9.7 →
beste Teiler	220.7 (33.)	257.6 (32.)	259.2 (36.)		
Trefferlage	0.27 mm links, 0.20 mm hoch				
Streuwert	2.91, horizontal: 3.48, vertikal: 2.20				

Unterschrift des Schützen

Ergebnis: **391** (409.5)  
 Serien: 96 97 99 99  
 Zähler: 31 9 0 0 0 0 0 0 0 0  
 Innenzehner: 26  
 weiteste: 494 (24), 399 (34), 332 (7)  
 beste Teiler 30.8 (8.) 39.2 (21.) 53.7 (22.)  
 Trefferlage 0.33 mm links, 0.08 mm hoch  
 Streuwert 1.46, horizontal: 1.62, vertikal: 1.28

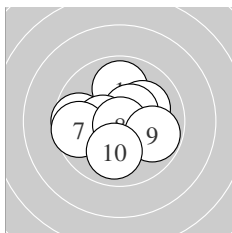
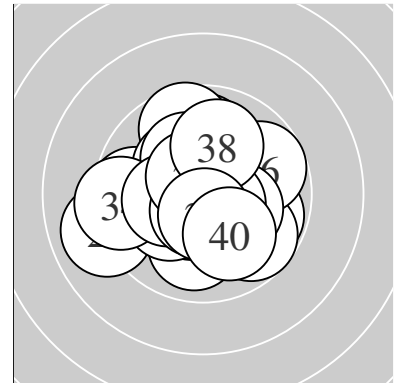

Serie 1:  
 9.9 ↑ 10.1 ↗ 10.5 \* 9.6 ← 10.4 \*  
 10.4 \* 9.6 ← 10.8 \* 9.8 → 10.0 ↓  
 beste Teiler 30.8 (8.) 114.9 (3.) 135.8 (6.)  
 Trefferlage 0.38 mm links, 0.12 mm tief  
 Streuwert 1.68, horizontal: 1.94, vertikal: 1.37

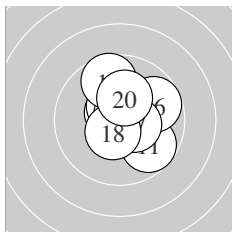

Serie 2:  
 9.7 ↘ 10.6 \* 10.6 \* 10.5 \* 10.7 \*  
 9.7 → 10.5 \* 10.5 \* 9.7 ↑ 10.2 \*  
 beste Teiler 55.9 (15.) 84.8 (12.) 93.0 (13.)  
 Trefferlage 0.43 mm rechts, 0.61 mm hoch  
 Streuwert 1.34, horizontal: 1.25, vertikal: 1.43

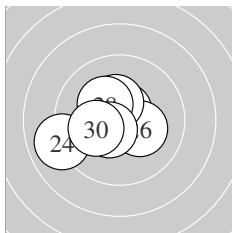

Serie 3:  
 10.8 \* 10.7 \* 10.6 \* 9.0 ← 10.7 \*  
 10.2 \* 10.4 \* 10.3 \* 10.5 \* 10.1 ←  
 beste Teiler 39.2 (21.) 53.7 (22.) 61.4 (25.)  
 Trefferlage 0.78 mm links, 0.04 mm tief  
 Streuwert 1.36, horizontal: 1.64, vertikal: 1.02

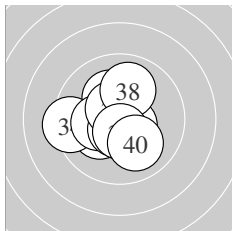

Serie 4:  
 10.2 \* 10.6 \* 10.2 \* 9.4 ← 10.3 \*  
 10.6 \* 10.6 \* 10.0 ↑ 10.5 \* 10.0 ↘  
 beste Teiler 86.5 (36.) 92.6 (32.) 98.7 (37.)  
 Trefferlage 0.60 mm links, 0.11 mm tief  
 Streuwert 1.43, horizontal: 1.53, vertikal: 1.32

Unterschrift des Schützen

Meyton Elektronik

Ergebnis: **355** (373.3)  
 Serien: 89 87 91 88  
 Zähler: 12 15 9 4 0 0 0 0 0 0  
 Innenzehner: 8  
 weiteste: 864 (5), 820 (31), 814 (3)  
 beste Teiler 88.1 (9.) 101.6 (10.) 104.6 (8.)  
 Trefferlage 1.06 mm links, 0.05 mm hoch  
 Streuwert 3.20, horizontal: 3.38, vertikal: 3.01

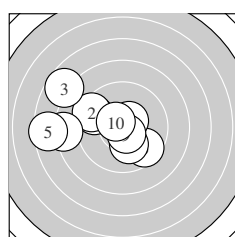
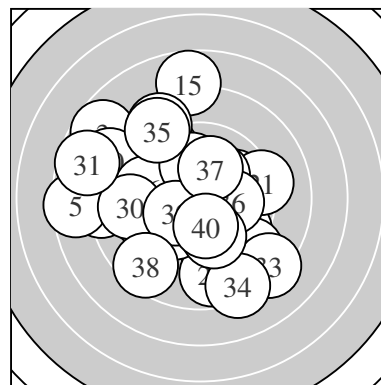

Serie 1:  
 9.5 ↖ 9.4 ↖ 7.7 ↖ 8.2 ← 7.5 ←  
 9.6 ↘ 10.1 ↓ 10.5 \* 10.6 \* 10.5 \*  
 beste Teiler 88.1 (9.) 101.6 (10.) 104.6 (8.)  
 Trefferlage 2.54 mm links, 0.28 mm hoch  
 Streuwert 3.08, horizontal: 3.86, vertikal: 2.01

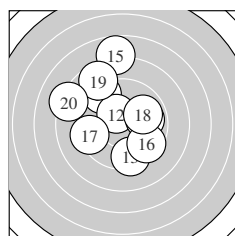

Serie 2:  
 9.3 ↖ 10.4 \* 9.4 ↓ 9.9 → 7.7 ↑  
 9.5 ↘ 9.3 ← 9.9 ↗ 8.6 ↖ 8.2 ↖  
 beste Teiler 140.4 (12.) 261.2 (18.) 264.1 (14.)  
 Trefferlage 0.82 mm links, 1.47 mm hoch  
 Streuwert 3.27, horizontal: 3.03, vertikal: 3.49

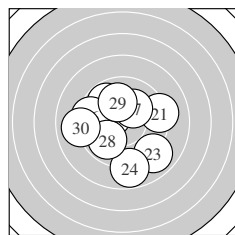

Serie 3:  
 9.2 → 9.8 ↖ 8.9 ↘ 8.8 ↓ 10.4 \*  
 9.4 ← 10.2 \* 9.9 ↙ 10.0 ↑ 9.0 ←  
 beste Teiler 142.2 (25.) 198.8 (27.) 236.2 (29.)  
 Trefferlage 0.42 mm links, 0.30 mm tief  
 Streuwert 2.75, horizontal: 2.92, vertikal: 2.57

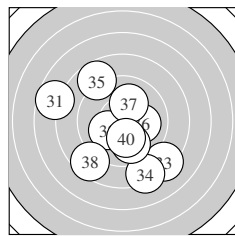

Serie 4:  
 7.7 ↖ 10.2 \* 8.3 ↘ 8.3 ↓ 8.7 ↖  
 10.1 → 10.1 ↑ 8.5 ↙ 9.8 ↓ 10.2 \*  
 beste Teiler 198.8 (40.) 200.3 (32.) 217.2 (37.)  
 Trefferlage 0.46 mm links, 1.22 mm tief  
 Streuwert 3.59, horizontal: 3.67, vertikal: 3.50

Unterschrift des Schützen

Meyton Elektronik

Ergebnis: **375** (394.8)  
 Serien: 91 96 95 93  
 Zähler: 17 21 2 0 0 0 0 0 0 0  
 Innenzehner: 15  
 weiteste: 638 (31), 506 (3), 479 (30)  
 beste Teiler 45.3 (26.) 59.0 (21.) 76.5 (7.)  
 Trefferlage 0.04 mm rechts, 0.43 mm hoch  
 Streuwert 2.15, horizontal: 2.65, vertikal: 1.49

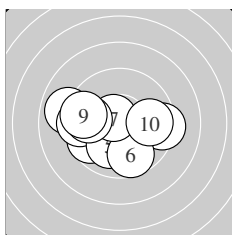
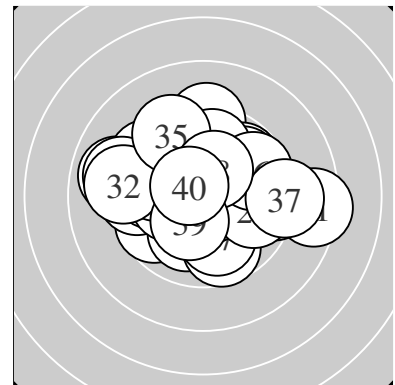

Serie 1:  
 9.7 ↙                      9.3 →                      8.9 ←                      9.4 ←                      10.0 ↘  
 9.7 ↓                      10.6 \*                      9.8 ←                      9.5 ←                      9.8 →  
 beste Teiler 76.5 (7.) 228.2 (5.) 287.1 (10.)  
 Trefferlage 1.14 mm links, 0.40 mm tief  
 Streuwert 2.33, horizontal: 3.00, vertikal: 1.35

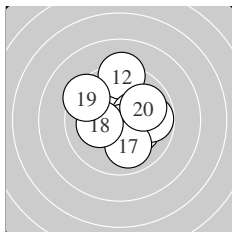

Serie 2:  
 10.5 \*                      9.3 ↑                      10.2 \*                      10.3 \*                      10.6 \*  
 9.8 →                      10.0 ↓                      10.2 \*                      9.4 ↘                      9.9 →  
 beste Teiler 80.6 (15.) 111.0 (11.) 151.1 (14.)  
 Trefferlage 0.54 mm rechts, 0.46 mm hoch  
 Streuwert 1.83, horizontal: 1.85, vertikal: 1.81

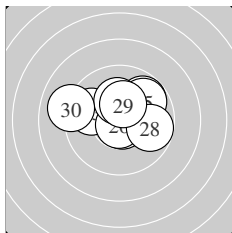

Serie 3:  
 10.7 \*                      9.8 ↗                      9.8 ←                      10.6 \*                      9.8 ↗  
 10.8 \*                      10.2 \*                      9.8 →                      10.3 \*                      9.0 ←  
 beste Teiler 45.3 (26.) 59.0 (21.) 94.3 (24.)  
 Trefferlage 0.12 mm rechts, 0.73 mm hoch  
 Streuwert 1.80, horizontal: 2.31, vertikal: 1.06

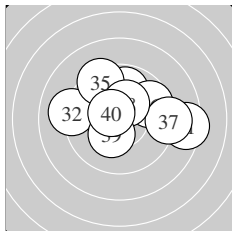

Serie 4:  
 8.4 →                      9.1 ←                      9.8 ↑                      10.4 \*                      9.4 ↘  
 9.7 ↗                      9.1 →                      10.3 \*                      10.3 \*                      10.6 \*  
 beste Teiler 98.0 (40.) 133.1 (34.) 161.3 (38.)  
 Trefferlage 0.67 mm rechts, 0.94 mm hoch  
 Streuwert 2.50, horizontal: 3.20, vertikal: 1.50

Unterschrift des Schützen

Meyton Elektronik



Ergebnis: **399** (417.6)  
 Serien: 100 100 99 100  
 Zähler: 39 1 0 0 0 0 0 0 0 0  
 Innenzehner: 33  
 weiteste: 282 (21), 244 (22), 239 (20)  
 beste Teiler 27.6 (24.) 38.8 (11.) 48.9 (9.)  
 Trefferlage 0.00 mm , 0.09 mm tief  
 Streuwert 1.01, horizontal: 0.97, vertikal: 1.04

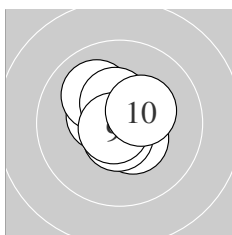
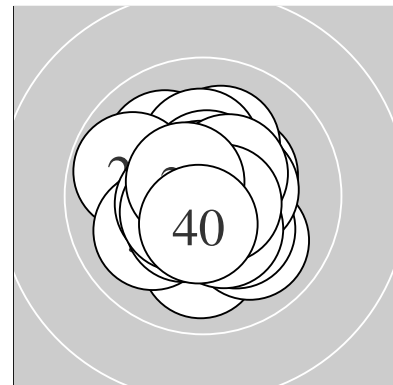

Serie 1:  
 10.6 \*                      10.3 \*                      10.5 \*                      10.0 ↘                      10.7 \*  
 10.4 \*                      10.4 \*                      10.6 \*                      10.8 \*                      10.3 \*  
 beste Teiler 48.9 (9.) 52.3 (5.) 77.8 (1.)  
 Trefferlage 0.10 mm links, 0.28 mm hoch  
 Streuwert 0.95, horizontal: 0.92, vertikal: 0.97

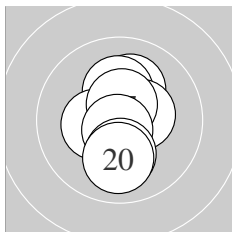

Serie 2:  
 10.8 \*                      10.1 ↑                      10.2 \*                      10.6 \*                      10.4 \*  
 10.4 \*                      10.6 \*                      10.7 \*                      10.1 ↓                      10.0 ↓  
 beste Teiler 38.8 (11.) 63.7 (18.) 79.8 (14.)  
 Trefferlage 0.08 mm rechts, 0.08 mm tief  
 Streuwert 1.15, horizontal: 0.70, vertikal: 1.47

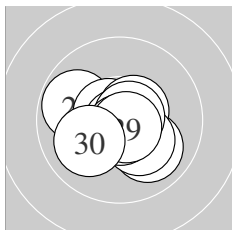

Serie 3:  
 9.8 ↙                      10.0 ↘                      10.6 \*                      10.8 \*                      10.5 \*  
 10.2 \*                      10.7 \*                      10.7 \*                      10.7 \*                      10.0 ↙  
 beste Teiler 27.6 (24.) 60.8 (29.) 61.2 (28.)  
 Trefferlage 0.03 mm links, 0.35 mm tief  
 Streuwert 1.16, horizontal: 1.38, vertikal: 0.88

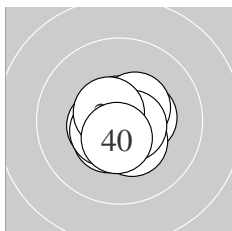

Serie 4:  
 10.5 \*                      10.7 \*                      10.4 \*                      10.4 \*                      10.5 \*  
 10.5 \*                      10.4 \*                      10.6 \*                      10.6 \*                      10.5 \*  
 beste Teiler 60.6 (32.) 78.5 (38.) 86.8 (39.)  
 Trefferlage 0.02 mm rechts, 0.23 mm tief  
 Streuwert 0.82, horizontal: 0.88, vertikal: 0.76

Unterschrift des Schützen

Meyton Elektronik

Ergebnis: **387** (408.1)  
 Serien: 96 95 98 98  
 Zähler: 27 13 0 0 0 0 0 0 0 0  
 Innenzehner: 23  
 weiteste: 413 (9), 410 (20), 373 (14)  
 beste Teiler 17.8 (8.) 18.0 (18.) 26.0 (15.)  
 Trefferlage 0.35 mm links, 0.33 mm hoch  
 Streuwert 1.54, horizontal: 1.64, vertikal: 1.44

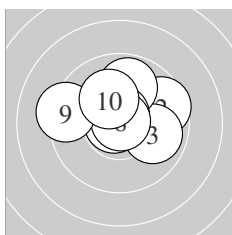
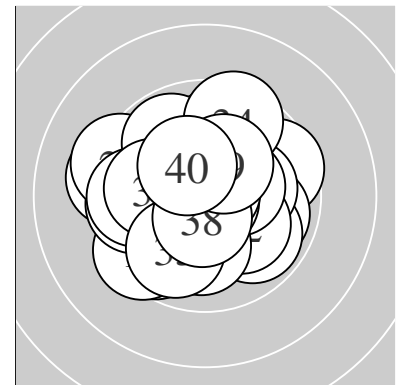

Serie 1:  
 10.2 \* 9.6 → 9.9 → 10.2 \* 9.9 ↑  
 10.7 \* 10.8 \* 10.9 \* 9.3 ← 10.2 \*  
 beste Teiler 17.8 (8.) 42.0 (7.) 63.0 (6.)  
 Trefferlage 0.09 mm rechts, 1.01 mm hoch  
 Streuwert 1.56, horizontal: 1.94, vertikal: 1.05

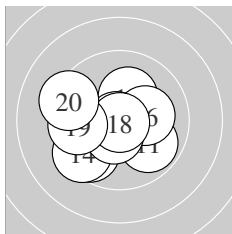

Serie 2:  
 9.9 ↘ 10.2 \* 9.6 ↙ 9.5 ↙ 10.8 \*  
 10.2 \* 10.5 \* 10.9 \* 9.7 ← 9.3 ↖  
 beste Teiler 18.0 (18.) 26.0 (15.) 114.0 (17.)  
 Trefferlage 0.79 mm links, 0.47 mm tief  
 Streuwert 1.82, horizontal: 2.11, vertikal: 1.46

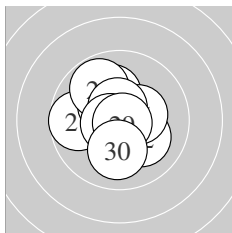

Serie 3:  
 9.7 ← 10.1 ↘ 10.4 \* 10.1 ↑ 10.4 \*  
 9.8 ↘ 10.6 \* 10.7 \* 10.8 \* 10.1 ↓  
 beste Teiler 29.0 (29.) 75.2 (28.) 95.3 (27.)  
 Trefferlage 0.39 mm links, 0.28 mm hoch  
 Streuwert 1.39, horizontal: 1.37, vertikal: 1.41

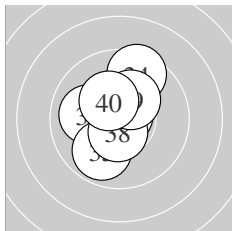

Serie 4:  
 10.7 \* 10.0 ← 10.8 \* 9.5 ↑ 9.9 ↙  
 10.5 \* 10.5 \* 10.6 \* 10.3 \* 10.3 \*  
 beste Teiler 38.8 (33.) 62.6 (31.) 97.8 (38.)  
 Trefferlage 0.30 mm links, 0.52 mm hoch  
 Streuwert 1.34, horizontal: 1.03, vertikal: 1.58

Unterschrift des Schützen

Ergebnis: **395** (414.0)  
 Serien: 99 99 99 98  
 Zähler: 35 5 0 0 0 0 0 0 0 0  
 Innenzehner: 31  
 weiteste: 365 (37), 350 (35), 296 (27)  
 beste Teiler 32.0 (13.) 43.7 (38.) 57.7 (25.)  
 Trefferlage 0.04 mm rechts, 0.12 mm hoch  
 Streuwert 1.21, horizontal: 1.23, vertikal: 1.18

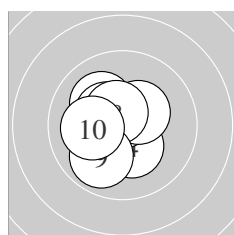
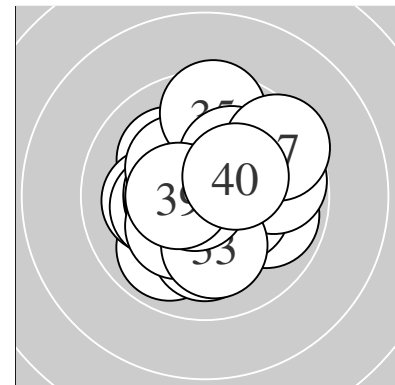

Serie 1:  
 10.1 ↘                      10.7 \*                      10.6 \*                      10.3 \*                      10.4 \*  
 10.7 \*                      10.4 \*                      10.6 \*                      9.9 ✓                      10.1 ←  
 beste Teiler 57.9 (2.) 59.5 (6.) 79.6 (3.)  
 Trefferlage 0.49 mm links, 0.06 mm hoch  
 Streuwert 1.12, horizontal: 1.04, vertikal: 1.19

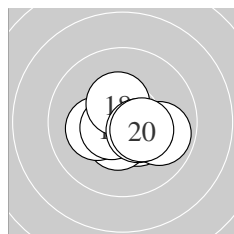

Serie 2:  
 10.4 \*                      10.6 \*                      10.8 \*                      10.5 \*                      10.2 \*  
 9.9 →                      10.6 \*                      10.4 \*                      10.5 \*                      10.4 \*  
 beste Teiler 32.0 (13.) 79.3 (12.) 85.4 (17.)  
 Trefferlage 0.21 mm rechts, 0.28 mm tief  
 Streuwert 1.04, horizontal: 1.27, vertikal: 0.74

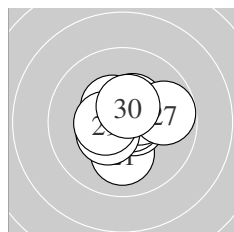

Serie 3:  
 10.1 ↓                      10.4 \*                      10.4 \*                      10.6 \*                      10.7 \*  
 10.4 \*                      9.8 →                      10.4 \*                      10.5 \*                      10.5 \*  
 beste Teiler 57.7 (25.) 79.9 (24.) 117.3 (30.)  
 Trefferlage 0.35 mm rechts, 0.15 mm hoch  
 Streuwert 1.13, horizontal: 1.21, vertikal: 1.04

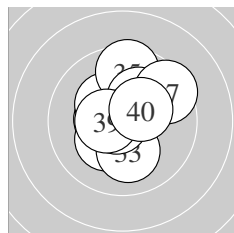

Serie 4:  
 10.5 \*                      10.3 \*                      10.1 ↓                      10.3 \*                      9.6 ↑  
 10.2 \*                      9.5 ↗                      10.8 \*                      10.5 \*                      10.3 \*  
 beste Teiler 43.7 (38.) 112.0 (39.) 120.7 (31.)  
 Trefferlage 0.11 mm rechts, 0.57 mm hoch  
 Streuwert 1.51, horizontal: 1.40, vertikal: 1.61

Unterschrift des Schützen

Meyton Elektronik

Ergebnis: **380** (399.2)  
 Serien: 94 90 98 98  
 Zähler: 23 14 3 0 0 0 0 0 0 0  
 Innenzehner: 17  
 weiteste: 591 (12), 523 (10), 511 (16)  
 beste Teiler 11.6 (26.) 46.6 (3.) 52.7 (36.)  
 Trefferlage 0.97 mm rechts, 0.88 mm hoch  
 Streuwert 1.79, horizontal: 2.01, vertikal: 1.53

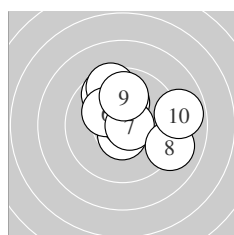
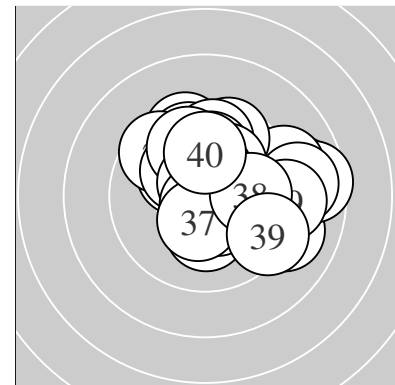

Serie 1:  
 10.1 ↑                      10.6 \*                      10.8 \*                      9.7 ↘                      9.5 ↘  
 10.2 \*                      10.7 \*                      9.1 ↘                      9.9 ↑                      8.9 →  
 beste Teiler 46.6 (3.) 64.1 (7.) 92.0 (2.)  
 Trefferlage 0.66 mm rechts, 1.06 mm hoch  
 Streuwert 2.02, horizontal: 2.28, vertikal: 1.72

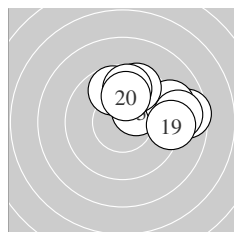

Serie 2:  
 9.7 ↘                      8.6 →                      10.3 \*                      9.1 →                      9.8 ↑  
 8.9 →                      9.6 ↑                      9.7 ↑                      9.2 →                      10.0 ↑  
 beste Teiler 159.9 (13.) 239.7 (20.) 282.0 (15.)  
 Trefferlage 2.26 mm rechts, 1.80 mm hoch  
 Streuwert 1.89, horizontal: 2.39, vertikal: 1.20

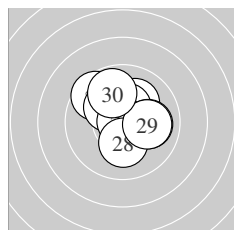

Serie 3:  
 10.3 \*                      9.6 ↘                      10.1 ↗                      10.4 \*                      10.2 \*  
 10.9 \*                      10.0 →                      10.2 \*                      10.1 →                      9.8 ↘  
 beste Teiler 11.6 (26.) 136.4 (24.) 159.6 (21.)  
 Trefferlage 0.20 mm rechts, 0.86 mm hoch  
 Streuwert 1.46, horizontal: 1.52, vertikal: 1.39

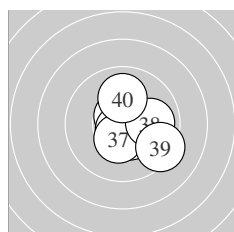

Serie 4:  
 10.6 \*                      10.7 \*                      10.6 \*                      10.5 \*                      10.5 \*  
 10.7 \*                      10.4 \*                      9.9 →                      9.3 ↘                      10.0 ↑  
 beste Teiler 52.7 (36.) 57.6 (32.) 82.2 (33.)  
 Trefferlage 0.77 mm rechts, 0.19 mm tief  
 Streuwert 1.26, horizontal: 1.28, vertikal: 1.23

Unterschrift des Schützen

Meyton Elektronik

Ergebnis: **375** (393.2)

Serien: 96 91 93 95

Zähler: 19 17 4 0 0 0 0 0 0 0

Innenzehner: 14

weiteste: 663 (35), 652 (13), 542 (12)

beste Teiler 32.0 (29.) 65.4 (32.) 66.0 (11.)

Trefferlage 0.13 mm rechts, 0.94 mm hoch

Streuwert 2.20, horizontal: 2.65, vertikal: 1.62

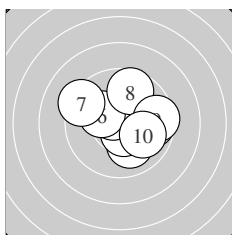
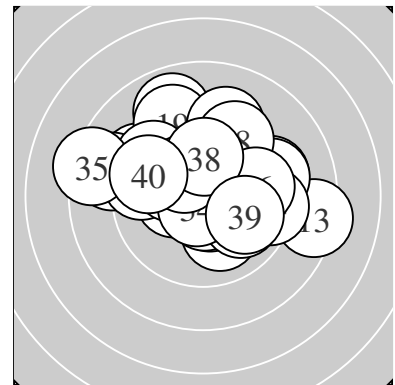

Serie 1:

10.5 *	9.7 →	10.0 ↘	10.5 *	10.6 *
10.2 *	9.3 ↖	9.7 ↑	9.5 →	10.0 ↗

beste Teiler 86.2 (5.) 104.0 (4.) 124.4 (1.)

Trefferlage 0.55 mm rechts, 0.38 mm hoch

Streuwert 1.88, horizontal: 2.18, vertikal: 1.53

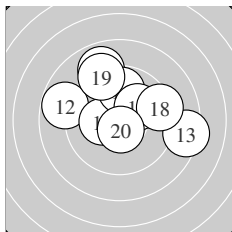

Serie 2:

10.7 *	8.8 ←	8.3 →	8.9 ↑	10.3 *
9.8 ↑	10.1 ↗	9.3 →	9.1 ↘	10.6 *

beste Teiler 66.0 (11.) 91.6 (20.) 166.6 (15.)

Trefferlage 0.13 mm rechts, 1.29 mm hoch

Streuwert 2.74, horizontal: 3.26, vertikal: 2.10

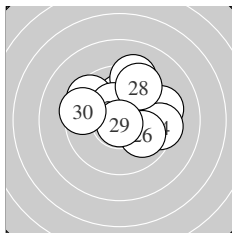

Serie 3:

10.1 ↑	9.3 →	9.3 ↑	9.4 →	9.5 ↖
9.9 ↘	10.4 *	9.5 ↑	10.8 *	9.5 ←

beste Teiler 32.0 (29.) 147.7 (27.) 220.3 (21.)

Trefferlage 0.61 mm rechts, 1.26 mm hoch

Streuwert 2.15, horizontal: 2.53, vertikal: 1.70

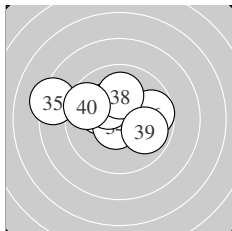

Serie 4:

10.2 *	10.7 *	10.2 *	10.7 *	8.3 ←
9.7 →	10.3 *	10.0 ↑	9.9 ↘	9.6 ←

beste Teiler 65.4 (32.) 75.1 (34.) 166.7 (37.)

Trefferlage 0.77 mm links, 0.84 mm hoch

Streuwert 2.05, horizontal: 2.69, vertikal: 1.09

Unterschrift des Schützen

Meyton Elektronik

Ergebnis:	<b>380</b>	(394.9)
Serien:	94 96 97 93	
Zähler:	21 18 1 0 0 0 0 0 0 0	
Innenzehner:	14	
weiteste:	641 (10), 469 (3), 456 (38)	
beste Teiler	53.8 (24.) 72.2 (36.) 92.0 (5.)	
Trefferlage	0.01 mm rechts, 0.11 mm tief	
Streuwert	2.12, horizontal: 2.22, vertikal: 2.01	

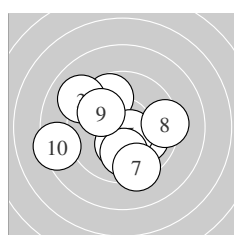
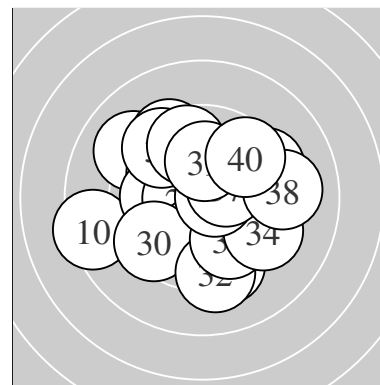

Serie 1:					
	10.0 ↘	9.7 ↗	9.1 ↘	10.3 *	10.6 *
	10.0 ↓	9.4 ↓	9.4 →	10.0 ↖	8.4 ←
beste Teiler	92.0 (5.) 162.5 (4.) 234.3 (1.)				
Trefferlage	0.54 mm links, 0.39 mm tief				
Streuwert	2.58, horizontal: 2.95, vertikal: 2.16				

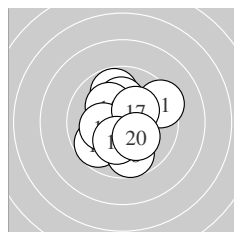

Serie 2:					
	9.4 ↗	9.7 ↖	9.8 ↗	10.2 *	10.2 *
	10.2 *	10.3 *	9.7 ↓	10.2 *	10.2 *
beste Teiler	164.2 (17.) 179.9 (19.) 185.3 (20.)				
Trefferlage	0.01 mm links, 0.06 mm hoch				
Streuwert	1.87, horizontal: 1.75, vertikal: 1.99				

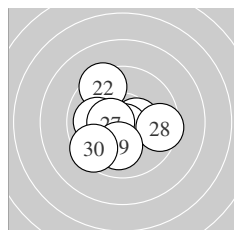

Serie 3:					
	10.4 *	9.4 ↖	10.5 *	10.7 *	10.0 ←
	10.1 ↖	10.5 *	9.5 →	10.0 ↓	9.5 ↖
beste Teiler	53.8 (24.) 112.0 (27.) 119.2 (23.)				
Trefferlage	0.57 mm links, 0.41 mm tief				
Streuwert	1.75, horizontal: 1.86, vertikal: 1.63				

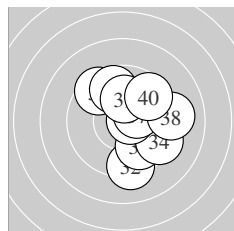

Serie 4:					
	9.5 ↖	9.2 ↓	9.8 ↘	9.4 ↘	9.7 ↗
	10.7 *	10.4 *	9.1 →	10.1 ↑	9.6 ↗
beste Teiler	72.2 (36.) 148.9 (37.) 207.5 (39.)				
Trefferlage	1.18 mm rechts, 0.29 mm hoch				
Streuwert	2.21, horizontal: 1.99, vertikal: 2.42				

Unterschrift des Schützen

Meyton Elektronik

Ergebnis: **380** (394.5)  
 Serien: 95 92 96 97  
 Zähler: 26 9 4 1 0 0 0 0 0 0  
 Innenzehner: 18  
 weiteste: 777 (16), 660 (14), 653 (4)  
 beste Teiler 66.7 (36.) 80.6 (6.) 93.0 (21.)  
 Trefferlage 0.99 mm rechts, 0.00 mm  
 Streuwert 2.20, horizontal: 2.48, vertikal: 1.88

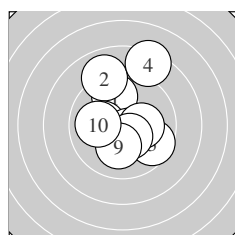
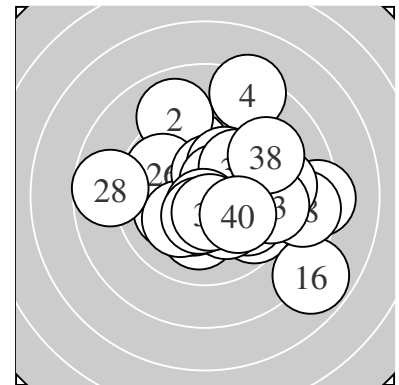

Serie 1:  
 9.8 ↗ 9.0 ↗ 9.6 ↘ 8.3 ↗ 10.2 \*  
 10.6 \* 10.2 \* 10.4 \* 10.1 ↓ 10.0 ←  
 beste Teiler 80.6 (6.) 129.5 (8.) 184.1 (7.)  
 Trefferlage 0.11 mm rechts, 0.82 mm hoch  
 Streuwert 2.35, horizontal: 1.89, vertikal: 2.74

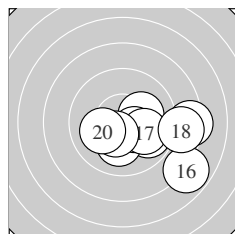

Serie 2:  
 10.2 \* 9.8 ↘ 10.1 ↓ 8.3 → 10.4 \*  
 7.8 ↘ 10.0 ↘ 8.6 → 10.4 \* 10.1 ←  
 beste Teiler 134.4 (19.) 136.2 (15.) 193.8 (11.)  
 Trefferlage 2.31 mm rechts, 1.18 mm tief  
 Streuwert 2.35, horizontal: 3.01, vertikal: 1.42

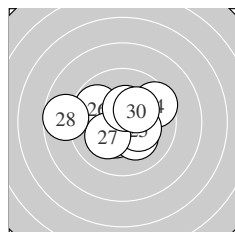

Serie 3:  
 10.6 \* 10.4 \* 10.2 \* 9.5 ↗ 10.3 \*  
 9.8 ↖ 10.2 \* 8.7 ← 10.4 \* 10.2 \*  
 beste Teiler 93.0 (21.) 136.6 (29.) 143.6 (22.)  
 Trefferlage 0.19 mm links, 0.08 mm hoch  
 Streuwert 1.97, horizontal: 2.48, vertikal: 1.27

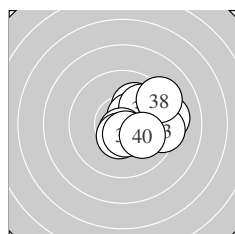

Serie 4:  
 10.1 ↗ 9.2 → 9.4 → 10.5 \* 10.0 ↗  
 10.7 \* 10.5 \* 9.2 ↗ 10.6 \* 10.1 ↘  
 beste Teiler 66.7 (36.) 100.9 (39.) 108.3 (34.)  
 Trefferlage 1.73 mm rechts, 0.28 mm hoch  
 Streuwert 1.53, horizontal: 1.69, vertikal: 1.34

Unterschrift des Schützen

Meyton Elektronik

Ergebnis: **387** (404.0)  
 Serien: 98 98 94 97  
 Zähler: 29 9 2 0 0 0 0 0 0 0  
 Innenzehner: 21  
 weiteste: 643 (28), 596 (33), 477 (19)  
 beste Teiler 63.6 (37.) 65.7 (15.) 78.0 (16.)  
 Trefferlage 0.58 mm rechts, 0.14 mm hoch  
 Streuwert 1.73, horizontal: 1.98, vertikal: 1.44

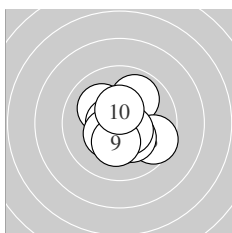
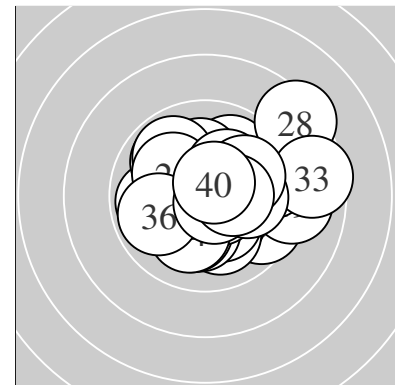

Serie 1:  
 10.1 ↘ 9.9 ↗ 9.6 ↘ 10.6 \* 10.4 \*  
 10.3 \* 10.5 \* 10.4 \* 10.3 \* 10.5 \*  
 beste Teiler 87.2 (4.) 104.8 (7.) 123.0 (10.)  
 Trefferlage 0.29 mm rechts, 0.26 mm tief  
 Streuwert 1.40, horizontal: 1.39, vertikal: 1.40

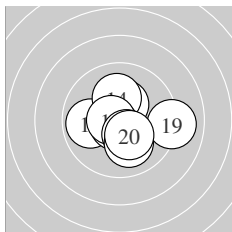

Serie 2:  
 10.4 \* 9.9 ← 10.4 \* 10.1 ↑ 10.7 \*  
 10.6 \* 10.4 \* 10.1 ↓ 9.0 → 10.3 \*  
 beste Teiler 65.7 (15.) 78.0 (16.) 138.0 (11.)  
 Trefferlage 0.33 mm rechts, 0.10 mm tief  
 Streuwert 1.63, horizontal: 1.87, vertikal: 1.34

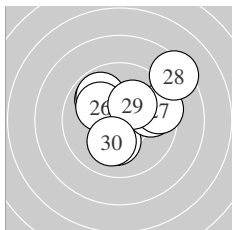

Serie 3:  
 10.2 \* 9.9 ↘ 10.3 \* 9.8 → 9.9 ↘  
 10.1 ↘ 9.5 → 8.4 ↗ 10.2 \* 10.1 ↓  
 beste Teiler 166.8 (23.) 183.2 (29.) 192.2 (21.)  
 Trefferlage 0.51 mm rechts, 0.98 mm hoch  
 Streuwert 2.17, horizontal: 2.49, vertikal: 1.79

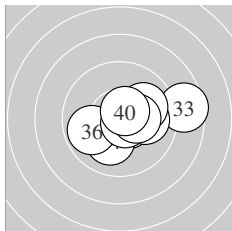

Serie 4:  
 10.3 \* 10.6 \* 8.6 → 10.1 ↓ 10.0 →  
 9.9 ← 10.7 \* 10.0 ↗ 10.3 \* 10.6 \*  
 beste Teiler 63.6 (37.) 87.9 (40.) 89.6 (32.)  
 Trefferlage 1.18 mm rechts, 0.05 mm tief  
 Streuwert 1.70, horizontal: 2.20, vertikal: 0.96

Unterschrift des Schützen

Meyton Elektronik



Ergebnis: **388** (408.4)  
 Serien: 97 96 99 96  
 Zähler: 31 7 1 1 0 0 0 0 0 0  
 Innenzehner: 26  
 weiteste: 754 (10), 630 (36), 396 (39)  
 beste Teiler 28.0 (11.) 32.5 (25.) 41.6 (17.)  
 Trefferlage 0.43 mm links, 0.11 mm tief  
 Streuwert 1.68, horizontal: 1.56, vertikal: 1.79

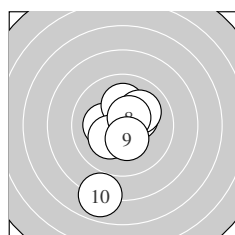
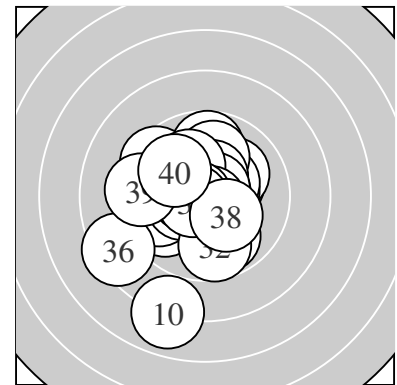

Serie 1:  
 10.8 \*                      10.3 \*                      10.2 \*                      10.1 ↑                      10.2 \*  
 10.5 \*                      10.1 ↗                      10.5 \*                      10.4 \*                      7.9 ↓  
 beste Teiler 49.0 (1.) 102.9 (8.) 104.0 (6.)  
 Trefferlage 0.04 mm links, 0.46 mm tief  
 Streuwert 2.08, horizontal: 1.36, vertikal: 2.60

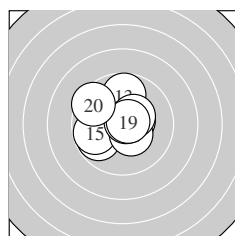

Serie 2:  
 10.8 \*                      9.8 ↙                      9.7 ↑                      10.5 \*                      9.8 ←  
 10.4 \*                      10.8 \*                      10.4 \*                      10.7 \*                      9.5 ↘  
 beste Teiler 28.0 (11.) 41.6 (17.) 62.6 (19.)  
 Trefferlage 0.38 mm links, 0.33 mm hoch  
 Streuwert 1.54, horizontal: 1.68, vertikal: 1.38

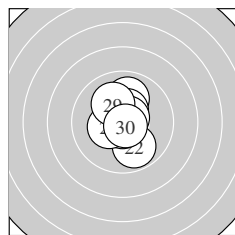

Serie 3:  
 10.0 ↑                      9.9 ↓                      10.5 \*                      10.4 \*                      10.8 \*  
 10.8 \*                      10.4 \*                      10.7 \*                      10.1 ↘                      10.8 \*  
 beste Teiler 32.5 (25.) 48.6 (30.) 49.0 (26.)  
 Trefferlage 0.02 mm rechts, 0.29 mm hoch  
 Streuwert 1.14, horizontal: 0.75, vertikal: 1.42

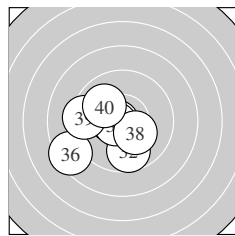

Serie 4:  
 10.7 \*                      9.7 ↓                      10.4 \*                      10.5 \*                      10.7 \*  
 8.4 ↙                      10.6 \*                      10.2 \*                      9.4 ←                      10.0 ↘  
 beste Teiler 58.5 (35.) 66.4 (31.) 78.9 (37.)  
 Trefferlage 1.32 mm links, 0.62 mm tief  
 Streuwert 1.79, horizontal: 2.01, vertikal: 1.53

Unterschrift des Schützen

Meyton Elektronik

Ergebnis: **380** (398.8)  
 Serien: 94 94 95 97  
 Zähler: 22 17 0 1 0 0 0 0 0 0  
 Innenzehner: 15  
 weiteste: 768 (14), 488 (32), 472 (21)  
 beste Teiler 28.8 (8.) 47.7 (16.) 59.6 (40.)  
 Trefferlage 0.17 mm rechts, 0.40 mm hoch  
 Streuwert 2.01, horizontal: 2.37, vertikal: 1.58

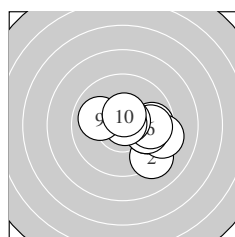
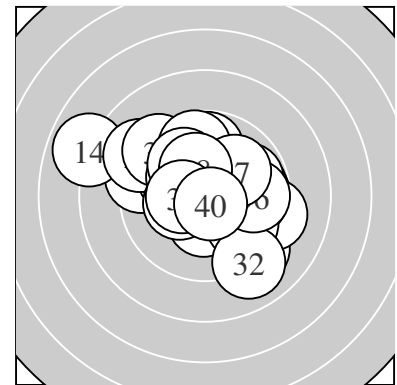

Serie 1:  
 9.7 → 9.2 ↘ 9.9 → 9.3 → 9.9 →  
 9.8 → 10.7 \* 10.8 \* 10.0 ← 10.5 \*  
 beste Teiler 28.8 (8.) 75.2 (7.) 107.2 (10.)  
 Trefferlage 1.65 mm rechts, 0.34 mm tief  
 Streuwert 1.61, horizontal: 1.92, vertikal: 1.22

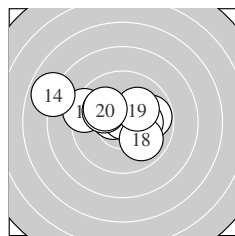

Serie 2:  
 9.8 → 9.3 ← 10.2 \* 7.9 ← 10.5 \*  
 10.8 \* 10.1 ← 9.9 ↘ 10.1 ↗ 10.1 ↖  
 beste Teiler 47.7 (16.) 108.2 (15.) 192.0 (13.)  
 Trefferlage 0.74 mm links, 0.76 mm hoch  
 Streuwert 2.34, horizontal: 3.10, vertikal: 1.16

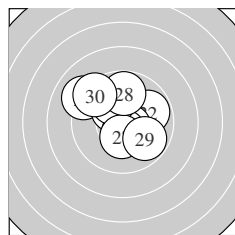

Serie 3:  
 9.1 ↖ 9.8 → 10.6 \* 10.3 \* 10.6 \*  
 10.1 ↖ 10.4 \* 9.8 ↑ 9.8 ↘ 9.4 ↖  
 beste Teiler 78.4 (23.) 95.7 (25.) 150.2 (27.)  
 Trefferlage 0.31 mm links, 0.78 mm hoch  
 Streuwert 1.92, horizontal: 2.04, vertikal: 1.80

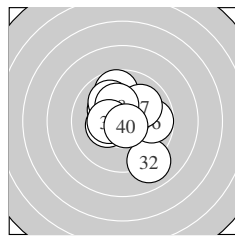

Serie 4:  
 9.7 ↑ 9.0 ↘ 10.2 \* 10.3 \* 10.0 ↖  
 9.8 → 10.0 ↗ 10.3 \* 10.4 \* 10.7 \*  
 beste Teiler 59.6 (40.) 140.0 (39.) 163.3 (34.)  
 Trefferlage 0.09 mm rechts, 0.42 mm hoch  
 Streuwert 1.87, horizontal: 1.77, vertikal: 1.96

Unterschrift des Schützen

Ergebnis: **390** (406.7)  
 Serien: 98 97 98 97  
 Zähler: 30 10 0 0 0 0 0 0 0 0  
 Innenzehner: 22  
 weiteste: 391 (39), 368 (14), 368 (24)  
 beste Teiler 46.1 (20.) 48.9 (17.) 78.4 (18.)  
 Trefferlage 0.18 mm links, 0.10 mm hoch  
 Streuwert 1.57, horizontal: 1.51, vertikal: 1.62

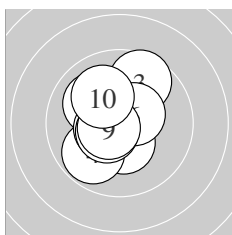
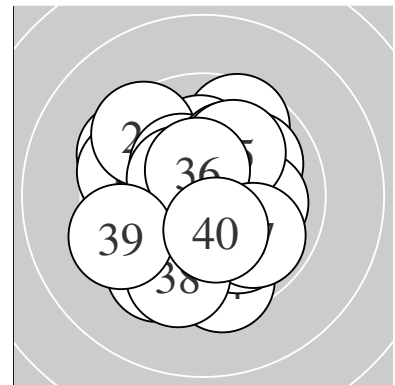

Serie 1:  
 10.4 \*                      10.5 \*                      9.6 ↗                      9.8 ↘                      10.0 ↘  
 10.5 \*                      10.5 \*                      10.5 \*                      10.6 \*                      10.1 ↘  
 beste Teiler 83.7 (9.) 107.6 (8.) 110.3 (7.)  
 Trefferlage 0.43 mm links, 0.32 mm hoch  
 Streuwert 1.37, horizontal: 1.17, vertikal: 1.55

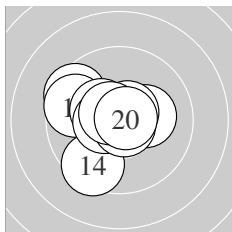

Serie 2:  
 9.5 ↘                      9.6 ↘                      10.4 \*                      9.5 ↘                      10.2 \*  
 10.5 \*                      10.8 \*                      10.6 \*                      10.6 \*                      10.8 \*  
 beste Teiler 46.1 (20.) 48.9 (17.) 78.4 (18.)  
 Trefferlage 0.81 mm links, 0.13 mm hoch  
 Streuwert 1.48, horizontal: 1.64, vertikal: 1.30

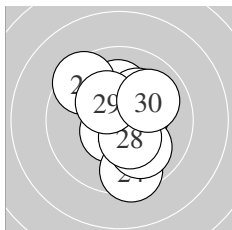

Serie 3:  
 10.6 \*                      10.1 ↑                      10.4 \*                      9.5 ↓                      10.0 ↘  
 9.5 ↘                      10.2 \*                      10.4 \*                      10.3 \*                      10.0 ↗  
 beste Teiler 99.2 (21.) 134.8 (23.) 143.5 (28.)  
 Trefferlage 0.34 mm rechts, 0.16 mm hoch  
 Streuwert 1.71, horizontal: 1.39, vertikal: 1.98

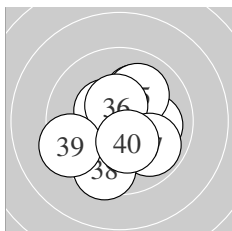

Serie 4:  
 10.6 \*                      10.4 \*                      10.1 ↗                      10.0 →                      10.0 ↗  
 10.5 \*                      9.9 ↘                      9.5 ↓                      9.4 ↖                      10.3 \*  
 beste Teiler 93.2 (31.) 112.5 (36.) 126.0 (32.)  
 Trefferlage 0.15 mm rechts, 0.21 mm tief  
 Streuwert 1.75, horizontal: 1.74, vertikal: 1.77

Unterschrift des Schützen

Meyton Elektronik

Ergebnis:	<b>382</b>	(398.1)
Serien:	97 93 96 96	
Zähler:	24 14 2 0 0 0 0 0 0 0	
Innenzehner:	18	
weiteste:	547 (34), 519 (13), 488 (11)	
beste Teiler	78.7 (29.) 85.6 (3.) 92.2 (23.)	
Trefferlage	0.32 mm rechts, 0.68 mm hoch	
Streuwert	1.91, horizontal: 2.29, vertikal: 1.44	

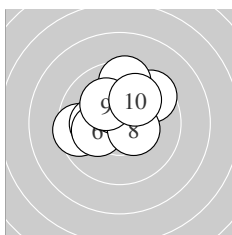
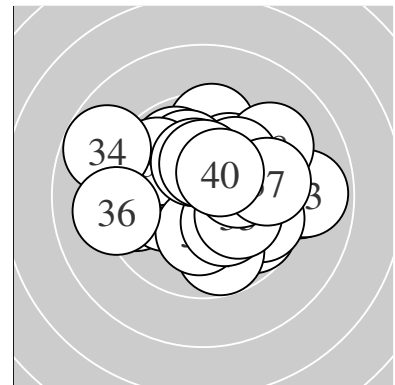

Serie 1:	9.5 ←	9.6 ↗	10.6 *	10.1 ←	9.5 ↑
	10.2 *	10.4 *	10.4 *	10.2 *	10.0 ↗
beste Teiler	85.6 (3.) 130.3 (8.) 141.6 (7.)				
Trefferlage	0.27 mm links, 0.96 mm hoch				
Streuwert	1.65, horizontal: 1.86, vertikal: 1.41				

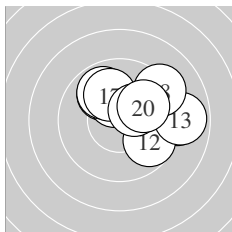

Serie 2:	9.0 →	9.7 ↘	8.9 →	9.9 ↖	10.3 *
	9.9 ↖	10.0 ↖	9.2 ↗	10.3 *	10.0 ↗
beste Teiler	152.5 (19.) 169.0 (15.) 231.3 (17.)				
Trefferlage	1.52 mm rechts, 1.14 mm hoch				
Streuwert	2.01, horizontal: 2.50, vertikal: 1.34				

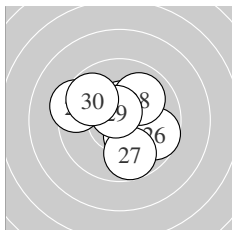

Serie 3:	10.5 *	9.4 ↖	10.6 *	10.4 *	10.3 *
	9.7 ↘	9.8 ↓	10.0 ↗	10.6 *	9.8 ↖
beste Teiler	78.7 (29.) 92.2 (23.) 112.7 (21.)				
Trefferlage	0.16 mm rechts, 0.28 mm hoch				
Streuwert	1.74, horizontal: 1.93, vertikal: 1.54				

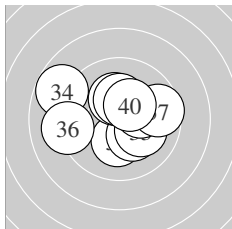

Serie 4:	10.2 *	10.3 *	10.1 ↘	8.8 ↖	10.2 *
	9.2 ←	9.6 →	10.2 *	10.3 *	10.4 *
beste Teiler	148.2 (40.) 165.0 (39.) 174.1 (32.)				
Trefferlage	0.11 mm links, 0.34 mm hoch				
Streuwert	2.14, horizontal: 2.65, vertikal: 1.46				

Unterschrift des Schützen

Ergebnis: **387** (403.0)  
 Serien: 97 96 97 97  
 Zähler: 27 13 0 0 0 0 0 0 0 0  
 Innenzehner: 18  
 weiteste: 437 (3), 421 (17), 396 (4)  
 beste Teiler 26.6 (1.) 72.4 (22.) 82.4 (5.)  
 Trefferlage 0.21 mm links, 0.21 mm hoch  
 Streuwert 1.68, horizontal: 1.74, vertikal: 1.61

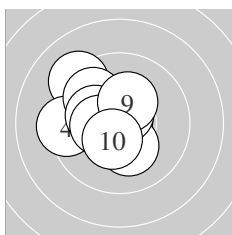
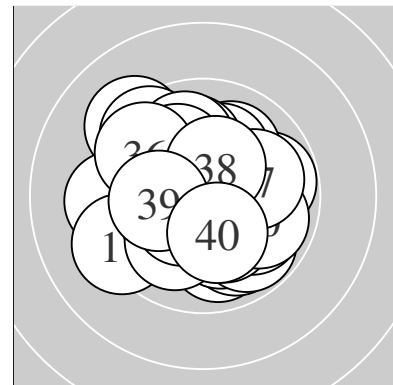

Serie 1:  
 10.8 \*                      10.2 \*                      9.2 ↘                      9.4 ←                      10.6 \*  
 9.9 ↘                      10.2 \*                      10.4 \*                      10.3 \*                      10.4 \*  
 beste Teiler 26.6 (1.) 82.4 (5.) 131.0 (10.)  
 Trefferlage 1.10 mm links, 0.48 mm hoch  
 Streuwert 1.53, horizontal: 1.62, vertikal: 1.45

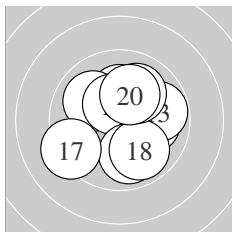

Serie 2:  
 10.2 \*                      10.0 →                      9.8 →                      10.0 ↘                      10.4 \*  
 9.9 ↓                      9.3 ↙                      9.9 ↘                      10.0 ↗                      10.1 ↗  
 beste Teiler 130.7 (15.) 190.0 (11.) 204.6 (20.)  
 Trefferlage 0.31 mm rechts, 0.19 mm hoch  
 Streuwert 1.90, horizontal: 1.95, vertikal: 1.84

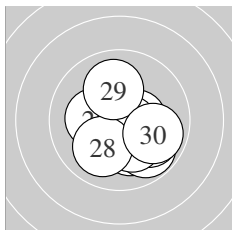

Serie 3:  
 10.5 \*                      10.7 \*                      10.1 ↓                      9.8 ↘                      9.9 ↘  
 10.2 \*                      10.2 \*                      10.0 ↙                      10.0 ↑                      9.9 ↘  
 beste Teiler 72.4 (22.) 124.0 (21.) 183.4 (26.)  
 Trefferlage 0.66 mm rechts, 0.78 mm tief  
 Streuwert 1.40, horizontal: 1.45, vertikal: 1.34

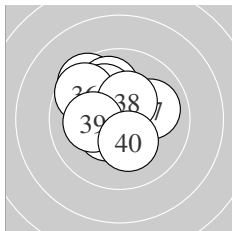

Serie 4:  
 10.4 \*                      9.5 ↘                      9.9 ↗                      10.3 \*                      10.1 ↘  
 9.7 ↘                      10.0 →                      10.4 \*                      10.2 \*                      10.2 \*  
 beste Teiler 127.3 (31.) 144.3 (38.) 168.1 (34.)  
 Trefferlage 0.73 mm links, 0.96 mm hoch  
 Streuwert 1.48, horizontal: 1.52, vertikal: 1.44

Unterschrift des Schützen

Meyton Elektronik

Ergebnis: **369** (386.5)  
 Serien: 92 89 95 93  
 Zähler: 15 20 4 1 0 0 0 0 0 0  
 Innenzehner: 11  
 weiteste: 837 (4), 663 (16), 606 (34)  
 beste Teiler 61.0 (19.) 91.0 (11.) 104.0 (37.)  
 Trefferlage 0.49 mm links, 0.55 mm hoch  
 Streuwert 2.54, horizontal: 3.21, vertikal: 1.62

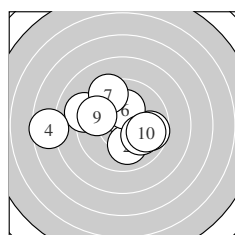
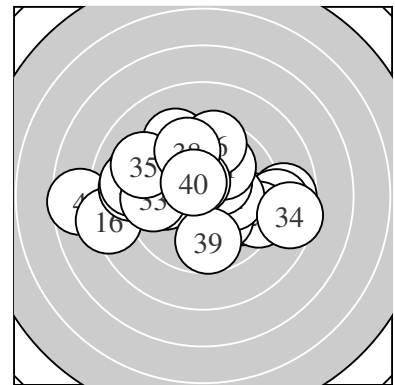

Serie 1:  
 10.4 \* 10.0 ↓ 9.1 ↖ 7.6 ← 9.7 →  
 10.2 \* 9.4 ↗ 10.0 ↘ 9.7 ↖ 9.8 →  
 beste Teiler 146.5 (1.) 182.6 (6.) 226.2 (2.)  
 Trefferlage 0.90 mm links, 0.41 mm hoch  
 Streuwert 2.79, horizontal: 3.55, vertikal: 1.72

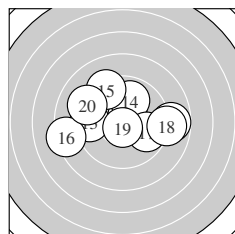

Serie 2:  
 10.6 \* 8.8 → 9.5 ← 9.9 ↑ 9.3 ↗  
 8.3 ← 9.8 ↘ 8.9 → 10.7 \* 9.2 ↖  
 beste Teiler 61.0 (19.) 91.0 (11.) 258.6 (14.)  
 Trefferlage 0.14 mm links, 0.49 mm hoch  
 Streuwert 3.02, horizontal: 3.92, vertikal: 1.70

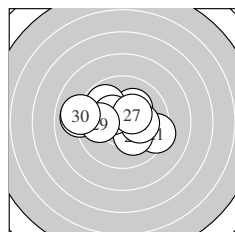

Serie 3:  
 9.4 ↘ 10.2 \* 10.2 \* 10.2 \* 9.8 ↗  
 10.4 \* 10.4 \* 9.0 ← 9.9 ← 9.0 ←  
 beste Teiler 140.6 (26.) 142.6 (27.) 192.2 (22.)  
 Trefferlage 0.62 mm links, 0.37 mm hoch  
 Streuwert 2.21, horizontal: 2.92, vertikal: 1.13

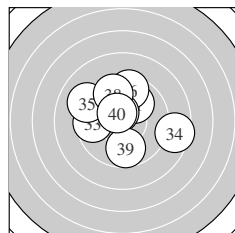

Serie 4:  
 10.0 ↗ 10.1 ↖ 9.6 ← 8.5 → 9.1 ↖  
 9.5 ↑ 10.5 \* 9.6 ↗ 9.7 ↓ 10.5 \*  
 beste Teiler 104.0 (37.) 111.2 (40.) 215.8 (32.)  
 Trefferlage 0.29 mm links, 0.93 mm hoch  
 Streuwert 2.42, horizontal: 2.77, vertikal: 2.01

Unterschrift des Schützen

Meyton Elektronik

Ergebnis: **382** (400.8)  
 Serien: 92 98 98 94  
 Zähler: 22 18 0 0 0 0 0 0 0 0  
 Innenzehner: 18  
 weiteste: 476 (40), 447 (3), 426 (6)  
 beste Teiler 66.4 (13.) 80.8 (9.) 92.0 (31.)  
 Trefferlage 0.24 mm links, 0.02 mm tief  
 Streuwert 1.80, horizontal: 2.16, vertikal: 1.35

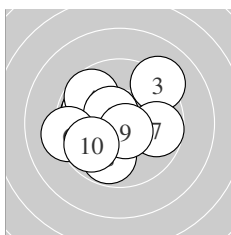
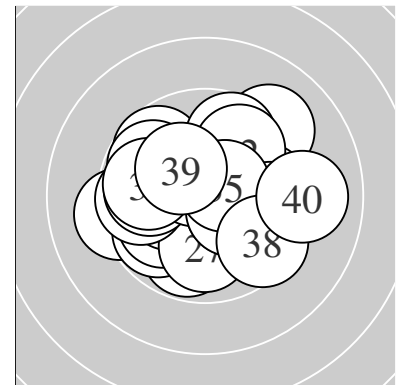

Serie 1:  
 9.9 ↖                      9.9 ↖                      9.2 ↗                      9.7 ↘                      10.5 \*  
 9.2 ←                      9.7 →                      9.8 ↓                      10.6 \*                      9.8 ↙  
 beste Teiler 80.8 (9.) 103.3 (5.) 268.8 (2.)  
 Trefferlage 0.88 mm links, 0.13 mm hoch  
 Streuwert 2.13, horizontal: 2.44, vertikal: 1.78

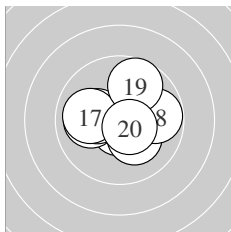

Serie 2:  
 10.2 \*                      10.5 \*                      10.7 \*                      10.0 ←                      10.2 \*  
 10.2 \*                      10.0 ←                      9.8 →                      9.7 ↑                      10.6 \*  
 beste Teiler 66.4 (13.) 98.4 (20.) 115.3 (12.)  
 Trefferlage 0.15 mm rechts, 0.10 mm tief  
 Streuwert 1.53, horizontal: 1.78, vertikal: 1.22

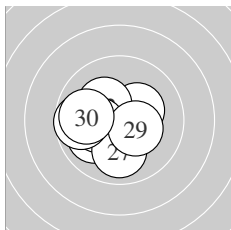

Serie 3:  
 10.3 \*                      10.2 \*                      10.3 \*                      10.3 \*                      10.0 ↙  
 10.2 \*                      10.0 ↓                      9.7 ←                      10.4 \*                      9.9 ←  
 beste Teiler 146.7 (29.) 156.0 (24.) 157.8 (23.)  
 Trefferlage 1.02 mm links, 0.47 mm tief  
 Streuwert 1.34, horizontal: 1.55, vertikal: 1.10

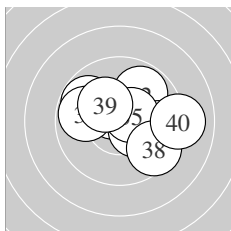

Serie 4:  
 10.6 \*                      9.8 ↗                      9.7 →                      10.4 \*                      10.5 \*  
 9.8 ↖                      9.8 ←                      9.5 ↘                      10.2 \*                      9.0 →  
 beste Teiler 92.0 (31.) 106.8 (35.) 149.0 (34.)  
 Trefferlage 0.76 mm rechts, 0.33 mm hoch  
 Streuwert 1.98, horizontal: 2.50, vertikal: 1.28

Unterschrift des Schützen

Meyton Elektronik

Ergebnis: **388** (404.3)  
 Serien: 95 98 97 98  
 Zähler: 29 10 1 0 0 0 0 0 0 0  
 Innenzehner: 22  
 weiteste: 539 (8), 463 (11), 439 (31)  
 beste Teiler 40.0 (32.) 53.3 (38.) 58.7 (9.)  
 Trefferlage 0.25 mm links, 0.71 mm hoch  
 Streuwert 1.66, horizontal: 1.87, vertikal: 1.42

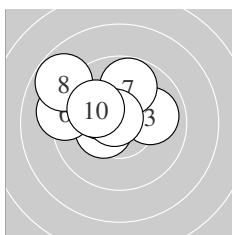
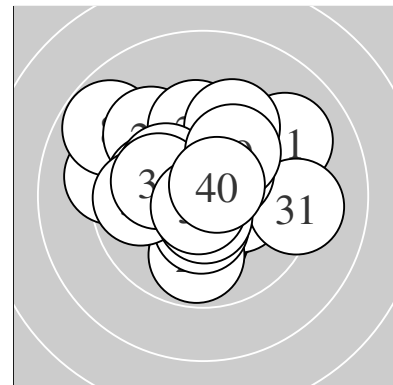

Serie 1:  
 10.4 \* 9.7 ← 10.0 → 10.4 \* 10.3 \*  
 9.2 ← 9.8 ↑ 8.8 ↘ 10.7 \* 10.1 ↖  
 beste Teiler 58.7 (9.) 134.2 (4.) 137.7 (1.)  
 Trefferlage 1.47 mm links, 1.10 mm hoch  
 Streuwert 1.67, horizontal: 2.08, vertikal: 1.11

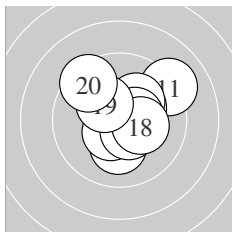

Serie 2:  
 9.1 ↗ 10.3 \* 10.2 \* 10.2 \* 10.5 \*  
 10.5 \* 10.5 \* 10.3 \* 10.3 \* 9.4 ↘  
 beste Teiler 110.7 (17.) 115.0 (15.) 123.2 (16.)  
 Trefferlage 0.56 mm rechts, 0.53 mm hoch  
 Streuwert 1.67, horizontal: 1.75, vertikal: 1.59

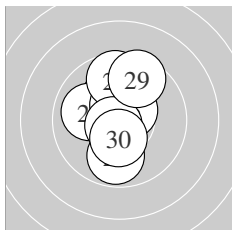

Serie 3:  
 10.2 \* 10.0 ← 10.0 ↑ 10.5 \* 10.5 \*  
 9.7 ↑ 10.7 \* 9.8 ↓ 9.6 ↗ 10.4 \*  
 beste Teiler 63.7 (27.) 106.8 (25.) 118.3 (24.)  
 Trefferlage 0.20 mm links, 0.85 mm hoch  
 Streuwert 1.54, horizontal: 0.98, vertikal: 1.95

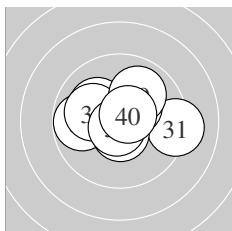

Serie 4:  
 9.2 → 10.8 \* 9.8 ← 10.1 ↖ 10.3 \*  
 10.1 ← 10.6 \* 10.7 \* 10.0 ↗ 10.6 \*  
 beste Teiler 40.0 (32.) 53.3 (38.) 83.2 (40.)  
 Trefferlage 0.08 mm rechts, 0.38 mm hoch  
 Streuwert 1.60, horizontal: 2.07, vertikal: 0.91

Unterschrift des Schützen



Ergebnis: **390** (409.3)  
 Serien: 99 98 98 95  
 Zähler: 30 10 0 0 0 0 0 0 0 0  
 Innenzehner: 25  
 weiteste: 425 (38), 415 (39), 355 (21)  
 beste Teiler 22.2 (18.) 37.5 (10.) 40.4 (19.)  
 Trefferlage 0.65 mm rechts, 0.23 mm tief  
 Streuwert 1.42, horizontal: 1.63, vertikal: 1.16

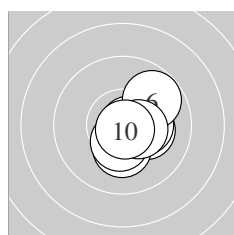
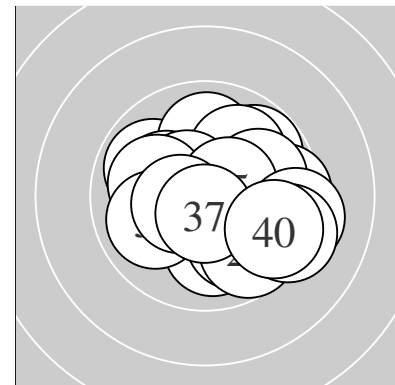

Serie 1:  
 10.2 \*                      10.5 \*                      10.3 \*                      10.8 \*                      10.7 \*  
 9.8 ↗                      10.3 \*                      10.4 \*                      10.5 \*                      10.8 \*  
 beste Teiler 37.5 (10.) 50.0 (4.) 73.6 (5.)  
 Trefferlage 0.87 mm rechts, 0.30 mm tief  
 Streuwert 0.89, horizontal: 0.83, vertikal: 0.95

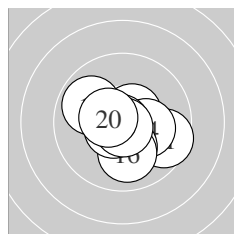

Serie 2:  
 9.6 ↘                      9.9 ↖                      10.6 \*                      10.2 \*                      10.2 \*  
 10.0 ↓                      10.6 \*                      10.9 \*                      10.8 \*                      10.5 \*  
 beste Teiler 22.2 (18.) 40.4 (19.) 85.2 (17.)  
 Trefferlage 0.21 mm rechts, 0.46 mm tief  
 Streuwert 1.33, horizontal: 1.52, vertikal: 1.11

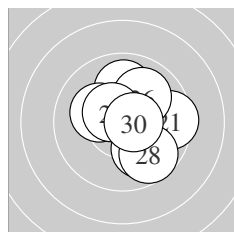

Serie 3:  
 9.5 →                      10.0 ↘                      10.5 \*                      10.5 \*                      10.0 ↑  
 10.0 ↗                      10.2 \*                      9.7 ↘                      10.5 \*                      10.6 \*  
 beste Teiler 84.0 (30.) 111.1 (29.) 116.7 (23.)  
 Trefferlage 0.55 mm rechts, 0.35 mm hoch  
 Streuwert 1.57, horizontal: 1.59, vertikal: 1.55

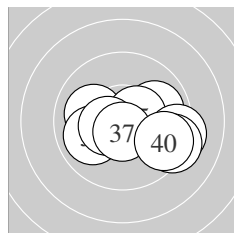

Serie 4:  
 9.9 →                      10.0 ←                      9.9 ↙                      10.6 \*                      10.5 \*  
 10.5 \*                      10.6 \*                      9.3 →                      9.3 ↘                      9.6 ↘  
 beste Teiler 81.0 (37.) 81.3 (34.) 115.3 (35.)  
 Trefferlage 0.96 mm rechts, 0.50 mm tief  
 Streuwert 1.79, horizontal: 2.38, vertikal: 0.87

Unterschrift des Schützen

Meyton Elektronik

Ergebnis: **384** (402.9)  
 Serien: 97 95 96 96  
 Zähler: 25 14 1 0 0 0 0 0 0 0  
 Innenzehner: 20  
 weiteste: 604 (13), 459 (12), 412 (26)  
 beste Teiler 32.2 (2.) 40.0 (22.) 49.0 (31.)  
 Trefferlage 0.21 mm rechts, 0.12 mm hoch  
 Streuwert 1.78, horizontal: 1.86, vertikal: 1.71

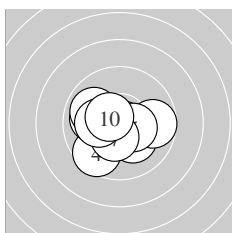
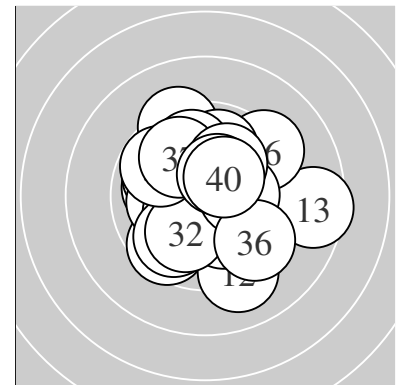

Serie 1:  
 10.2 \*                      10.8 \*                      9.7 →                      9.6 ✓                      10.4 \*  
 10.0 ←                      10.4 \*                      9.9 ↖                      10.2 \*                      10.5 \*  
 beste Teiler 32.2 (2.) 110.7 (10.) 130.2 (5.)  
 Trefferlage 0.44 mm links, 0.39 mm tief  
 Streuwert 1.53, horizontal: 1.86, vertikal: 1.12

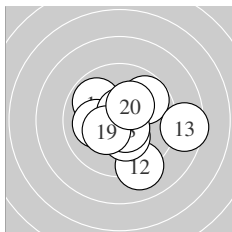

Serie 2:  
 9.8 ↗                      9.1 ↓                      8.5 →                      9.9 ↖                      10.1 ←  
 10.3 \*                      10.7 \*                      10.6 \*                      10.3 \*                      10.3 \*  
 beste Teiler 73.9 (17.) 91.6 (18.) 153.4 (19.)  
 Trefferlage 0.69 mm rechts, 0.27 mm tief  
 Streuwert 2.14, horizontal: 2.41, vertikal: 1.82

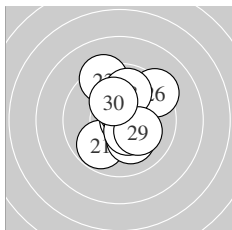

Serie 3:  
 9.8 ✓                      10.8 \*                      9.3 ↗                      10.1 ↓                      10.6 \*  
 9.3 ↗                      10.4 \*                      9.9 ↑                      10.2 \*                      10.2 \*  
 beste Teiler 40.0 (22.) 83.6 (25.) 127.6 (27.)  
 Trefferlage 0.44 mm rechts, 0.52 mm hoch  
 Streuwert 1.80, horizontal: 1.48, vertikal: 2.07

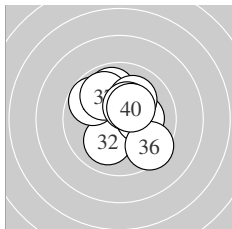

Serie 4:  
 10.8 \*                      10.0 ✓                      9.8 ↖                      9.9 ↑                      10.2 \*  
 9.5 ↘                      9.9 ↖                      10.1 ↗                      10.4 \*                      10.4 \*  
 beste Teiler 49.0 (31.) 137.9 (39.) 148.4 (40.)  
 Trefferlage 0.14 mm rechts, 0.62 mm hoch  
 Streuwert 1.66, horizontal: 1.64, vertikal: 1.69

Unterschrift des Schützen

Meyton Elektronik

Ergebnis:	<b>382</b>	(399.4)
Serien:	93	98 96 95
Zähler:	26	10 4 0 0 0 0 0 0 0
Innenzehner:	21	
weiteste:	559 (4),	546 (21), 540 (37)
beste Teiler	34.7 (2.)	47.2 (28.) 93.8 (5.)
Trefferlage	0.34 mm	rechts, 0.61 mm hoch
Streuwert	1.94,	horizontal: 2.12, vertikal: 1.75

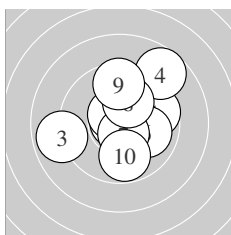
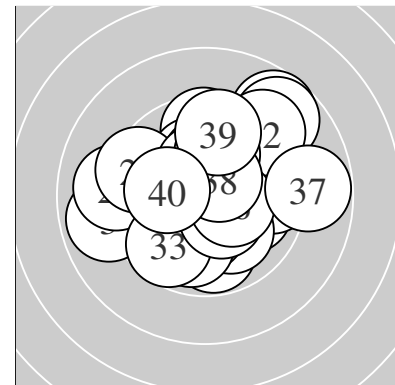

Serie 1:	9.7 →	10.8 *	8.9 ←	8.7 ↗	10.6 *
	10.0 →	10.6 *	10.2 *	9.6 ↑	9.8 ↓
beste Teiler	34.7 (2.)	93.8 (5.)	97.1 (7.)		
Trefferlage	0.44 mm	rechts, 0.57 mm	hoch		
Streuwert	2.29,	horizontal: 2.40,	vertikal: 2.18		

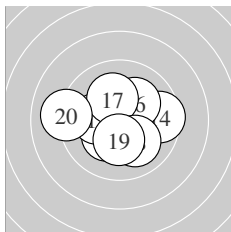

Serie 2:	10.3 *	10.1 →	10.4 *	9.6 →	10.2 *
	10.2 *	10.2 *	10.0 ↘	10.3 *	9.1 ←
beste Teiler	133.8 (13.)	171.1 (19.)	172.7 (11.)		
Trefferlage	0.10 mm	rechts, 0.03 mm	hoch		
Streuwert	1.87,	horizontal: 2.32,	vertikal: 1.27		

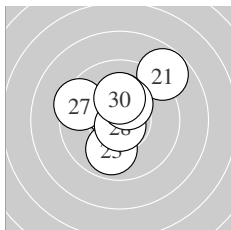

Serie 3:	8.8 ↗	10.4 *	9.9 ↓	10.5 *	10.5 *
	10.2 *	9.5 ←	10.8 *	10.3 *	10.2 *
beste Teiler	47.2 (28.)	102.3 (24.)	105.6 (25.)		
Trefferlage	0.00 mm	, 1.05 mm	hoch		
Streuwert	1.72,	horizontal: 1.75,	vertikal: 1.68		

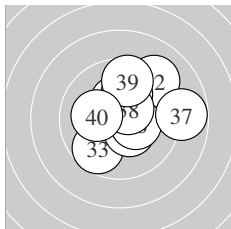

Serie 4:	10.3 *	9.2 ↗	9.7 ↙	10.4 *	10.0 ↑
	10.4 *	8.8 →	10.5 *	9.6 ↑	10.1 ←
beste Teiler	115.7 (38.)	134.1 (34.)	146.8 (36.)		
Trefferlage	0.85 mm	rechts, 0.79 mm	hoch		
Streuwert	2.03,	horizontal: 2.18,	vertikal: 1.87		

Unterschrift des Schützen

Meyton Elektronik

Ergebnis:	<b>388</b>	(404.3)
Serien:	96 98 95 99	
Zähler:	29 10 1 0 0 0 0 0 0 0	
Innenzehner:	20	
weiteste:	556 (3), 360 (31), 332 (29)	
beste Teiler	55.1 (4.) 63.6 (24.) 63.7 (27.)	
Trefferlage	0.37 mm rechts, 0.25 mm hoch	
Streuwert	1.63, horizontal: 1.65, vertikal: 1.61	

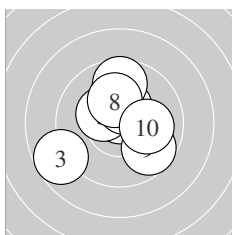
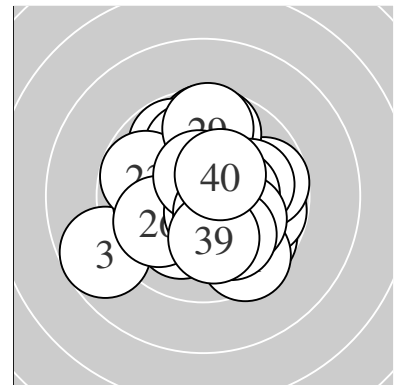

Serie 1:	10.4 *	10.1 ↑	8.7 ↙	10.7 *	10.3 *
	10.4 *	9.7 ↑	10.2 *	9.7 ↘	10.1 →
beste Teiler	55.1 (4.)	138.5 (6.)	145.7 (1.)		
Trefferlage	0.23 mm links, 0.61 mm hoch				
Streuwert	1.93, horizontal: 2.00, vertikal: 1.86				

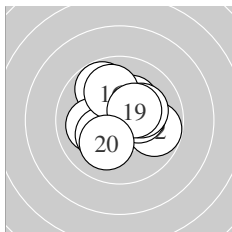

Serie 2:	9.8 ↖	9.8 →	10.3 *	10.1 ←	10.2 *
	10.0 ↑	10.3 *	10.2 *	10.4 *	10.1 ↙
beste Teiler	144.5 (19.)	159.3 (17.)	172.5 (13.)		
Trefferlage	0.15 mm rechts, 0.40 mm hoch				
Streuwert	1.59, horizontal: 1.70, vertikal: 1.46				

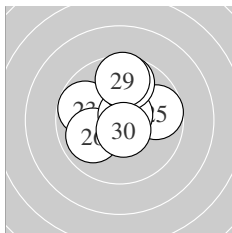

Serie 3:	10.2 *	10.3 *	9.8 ↖	10.7 *	9.7 →
	9.9 ↙	10.7 *	9.7 ↑	9.6 ↑	10.6 *
beste Teiler	63.6 (24.)	63.7 (27.)	86.1 (30.)		
Trefferlage	0.33 mm rechts, 0.74 mm hoch				
Streuwert	1.62, horizontal: 1.73, vertikal: 1.49				

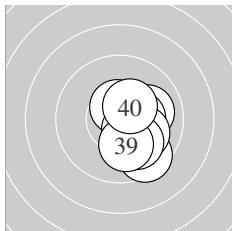

Serie 4:	9.5 ↘	10.5 *	10.0 →	10.5 *	10.2 *
	10.3 *	10.1 ↘	10.0 ↘	10.1 ↓	10.4 *
beste Teiler	101.2 (32.)	113.2 (34.)	135.0 (40.)		
Trefferlage	1.23 mm rechts, 0.74 mm tief				
Streuwert	1.11, horizontal: 0.76, vertikal: 1.37				

Unterschrift des Schützen

Meyton Elektronik

Ergebnis: **385** (400.4)  
 Serien: 93 98 98 96  
 Zähler: 26 13 1 0 0 0 0 0 0 0  
 Innenzehner: 19  
 weiteste: 512 (3), 483 (10), 463 (9)  
 beste Teiler 31.0 (27.) 51.0 (29.) 77.3 (15.)  
 Trefferlage 0.02 mm rechts, 0.49 mm hoch  
 Streuwert 1.90, horizontal: 2.34, vertikal: 1.30

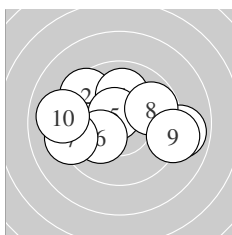
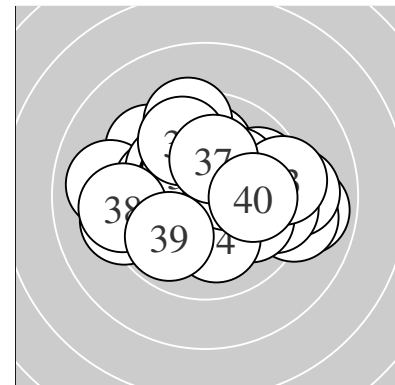

Serie 1:  
 10.4 \* 9.5 ↘ 8.9 → 10.0 ↑ 10.6 \*  
 10.2 \* 9.2 ← 9.8 ↗ 9.1 → 9.0 ←  
 beste Teiler 87.3 (5.) 128.0 (1.) 197.2 (6.)  
 Trefferlage 0.21 mm links, 0.40 mm hoch  
 Streuwert 2.60, horizontal: 3.40, vertikal: 1.39

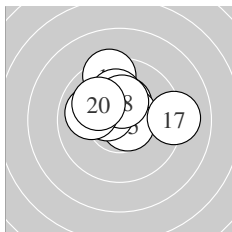

Serie 2:  
 10.4 \* 10.5 \* 9.4 ↑ 10.1 ↑ 10.6 \*  
 10.5 \* 9.1 → 10.3 \* 10.0 ← 10.1 ↘  
 beste Teiler 77.3 (15.) 102.8 (12.) 114.4 (16.)  
 Trefferlage 0.04 mm rechts, 1.15 mm hoch  
 Streuwert 1.59, horizontal: 1.92, vertikal: 1.17

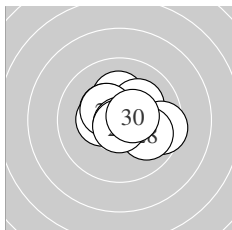

Serie 3:  
 10.2 \* 10.2 \* 10.4 \* 9.5 → 10.4 \*  
 10.4 \* 10.8 \* 9.9 ↘ 10.7 \* 10.5 \*  
 beste Teiler 31.0 (27.) 51.0 (29.) 115.1 (30.)  
 Trefferlage 0.45 mm rechts, 0.26 mm hoch  
 Streuwert 1.32, horizontal: 1.62, vertikal: 0.94

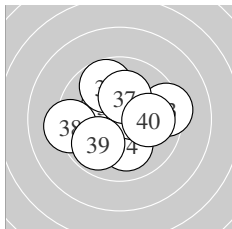

Serie 4:  
 10.1 ← 10.4 \* 9.4 → 10.1 ↓ 10.5 \*  
 9.8 ↖ 10.2 \* 9.3 ← 9.9 ↙ 10.0 →  
 beste Teiler 123.9 (35.) 149.9 (32.) 191.1 (37.)  
 Trefferlage 0.17 mm links, 0.16 mm hoch  
 Streuwert 2.01, horizontal: 2.36, vertikal: 1.59

Unterschrift des Schützen

Ergebnis: **384** (402.1)  
 Serien: 95 98 96 95  
 Zähler: 24 16 0 0 0 0 0 0 0 0  
 Innenzehner: 15  
 weiteste: 476 (1), 384 (39), 366 (33)  
 beste Teiler 50.6 (31.) 50.8 (19.) 64.3 (11.)  
 Trefferlage 0.14 mm rechts, 0.00 mm  
 Streuwert 1.77, horizontal: 1.94, vertikal: 1.57

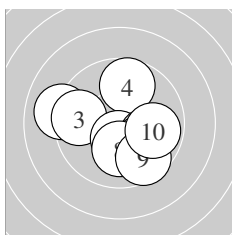
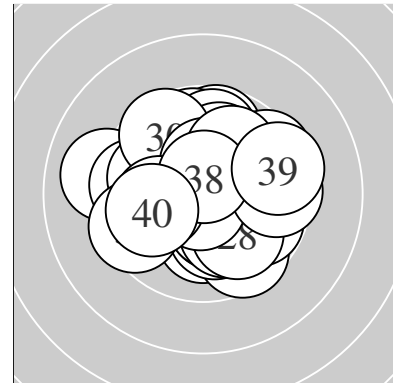

Serie 1:  
 9.0 ←                      10.0 ↘                      9.6 ←                      9.7 ↑                      10.5 \*  
 10.0 →                      10.0 ↘                      10.1 ↓                      9.6 ↘                      9.9 →  
 beste Teiler 123.5 (5.) 208.0 (8.) 240.5 (7.)  
 Trefferlage 0.28 mm rechts, 0.67 mm tief  
 Streuwert 2.12, horizontal: 2.45, vertikal: 1.72

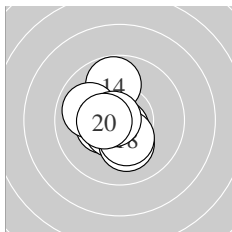

Serie 2:  
 10.7 \*                      10.4 \*                      10.3 \*                      9.8 ↑                      10.6 \*  
 9.9 ←                      10.2 \*                      10.3 \*                      10.8 \*                      10.5 \*  
 beste Teiler 50.8 (19.) 64.3 (11.) 97.0 (15.)  
 Trefferlage 0.65 mm links, 0.04 mm tief  
 Streuwert 1.17, horizontal: 0.93, vertikal: 1.37

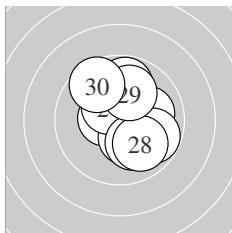

Serie 3:  
 10.0 →                      10.5 \*                      10.4 \*                      10.4 \*                      9.8 ↘  
 10.1 ↘                      9.8 ↑                      9.9 ↘                      10.0 ↑                      9.6 ↘  
 beste Teiler 115.8 (22.) 138.8 (24.) 148.0 (23.)  
 Trefferlage 0.55 mm rechts, 0.32 mm hoch  
 Streuwert 1.69, horizontal: 1.46, vertikal: 1.88

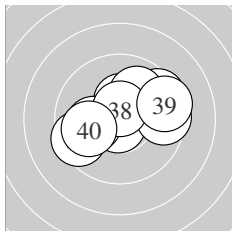

Serie 4:  
 10.8 \*                      9.5 ↗                      9.5 ←                      9.5 →                      10.4 \*  
 10.0 ↗                      10.1 ←                      10.6 \*                      9.4 →                      9.9 ←  
 beste Teiler 50.6 (31.) 83.1 (38.) 145.6 (35.)  
 Trefferlage 0.38 mm rechts, 0.42 mm hoch  
 Streuwert 1.98, horizontal: 2.53, vertikal: 1.23

Unterschrift des Schützen

Meyton Elektronik

Ergebnis: **375** (393.8)  
 Serien: 91 97 92 95  
 Zähler: 18 19 3 0 0 0 0 0 0  
 Innenzehner: 13  
 weiteste: 551 (30), 517 (4), 505 (22)  
 beste Teiler 56.3 (37.) 75.1 (5.) 78.7 (40.)  
 Trefferlage 0.39 mm links, 0.00 mm  
 Streuwert 2.19, horizontal: 2.60, vertikal: 1.67

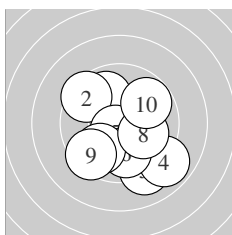
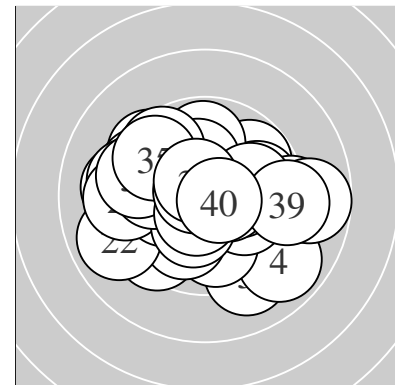

Serie 1:  
 9.9 ↖ 9.5 ↘ 9.1 ↘ 8.9 ↘ 10.7 \*  
 9.9 ↓ 9.8 ↙ 10.0 → 9.5 ↙ 9.8 ↗  
 beste Teiler 75.1 (5.) 227.1 (8.) 261.1 (1.)  
 Trefferlage 0.24 mm rechts, 1.01 mm tief  
 Streuwert 2.38, horizontal: 2.34, vertikal: 2.41

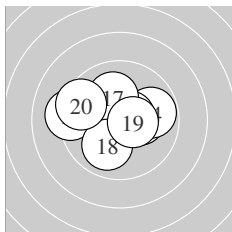

Serie 2:  
 10.2 \* 10.4 \* 10.3 \* 9.8 → 9.2 ←  
 10.6 \* 10.1 ↑ 10.0 ↙ 10.5 \* 9.5 ↖  
 beste Teiler 91.5 (16.) 118.3 (19.) 150.4 (12.)  
 Trefferlage 0.53 mm links, 0.19 mm hoch  
 Streuwert 1.79, horizontal: 2.24, vertikal: 1.19

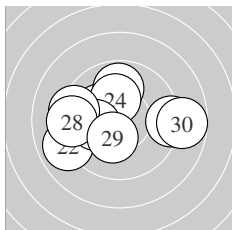

Serie 3:  
 10.2 \* 8.9 ← 9.8 ↑ 10.2 \* 9.1 →  
 10.1 ← 9.3 ← 9.3 ← 10.3 \* 8.7 →  
 beste Teiler 166.0 (29.) 187.8 (24.) 200.4 (21.)  
 Trefferlage 0.77 mm links, 0.17 mm hoch  
 Streuwert 2.66, horizontal: 3.46, vertikal: 1.49

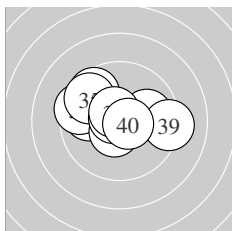

Serie 4:  
 9.9 ← 9.5 ← 9.6 ↘ 10.0 → 9.6 ↘  
 10.5 \* 10.7 \* 10.6 \* 9.2 → 10.6 \*  
 beste Teiler 56.3 (37.) 78.7 (40.) 91.0 (38.)  
 Trefferlage 0.50 mm links, 0.61 mm hoch  
 Streuwert 1.90, horizontal: 2.48, vertikal: 1.04

Unterschrift des Schützen

Ergebnis: **392** (407.2)  
 Serien: 97 97 99 99  
 Zähler: 32 8 0 0 0 0 0 0 0 0  
 Innenzehner: 20  
 weiteste: 500 (1), 445 (2), 343 (20)  
 beste Teiler 39.5 (16.) 39.8 (17.) 48.2 (27.)  
 Trefferlage 0.00 mm , 0.03 mm tief  
 Streuwert 1.56, horizontal: 1.70, vertikal: 1.42

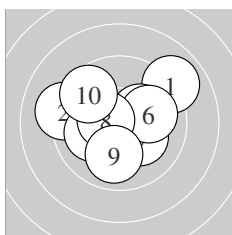
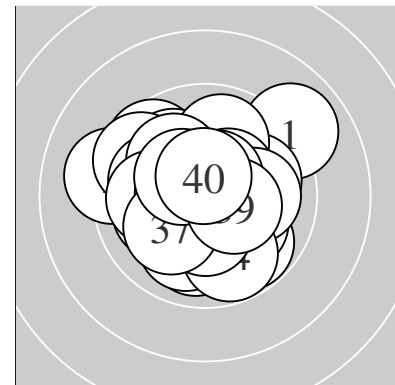

Serie 1:  
 9.0 ↗ 9.2 ← 10.6 \* 10.2 \* 10.2 \*  
 10.0 → 10.1 ← 10.5 \* 10.0 ↓ 9.6 ↘  
 beste Teiler 79.2 (3.) 109.4 (8.) 176.6 (4.)  
 Trefferlage 0.02 mm links, 0.37 mm hoch  
 Streuwert 2.10, horizontal: 2.52, vertikal: 1.58

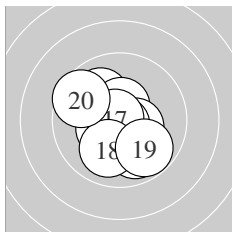

Serie 2:  
 10.4 \* 10.0 ↖ 10.5 \* 9.9 ↘ 10.4 \*  
 10.8 \* 10.8 \* 10.0 ↓ 9.8 ↘ 9.6 ↘  
 beste Teiler 39.5 (16.) 39.8 (17.) 108.6 (13.)  
 Trefferlage 0.23 mm links, 0.34 mm tief  
 Streuwert 1.52, horizontal: 1.48, vertikal: 1.56

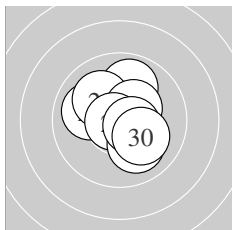

Serie 3:  
 9.9 ↑ 10.6 \* 10.0 ← 10.1 ↖ 10.3 \*  
 10.4 \* 10.8 \* 10.0 ↘ 10.5 \* 10.1 ↘  
 beste Teiler 48.2 (27.) 91.6 (22.) 102.9 (29.)  
 Trefferlage 0.32 mm rechts, 0.16 mm hoch  
 Streuwert 1.34, horizontal: 1.30, vertikal: 1.38

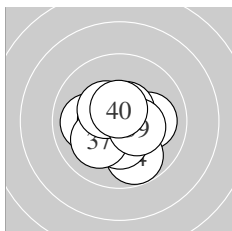

Serie 4:  
 10.1 → 10.0 ← 10.6 \* 9.8 ↘ 10.5 \*  
 10.4 \* 10.1 ↗ 10.4 \* 10.4 \* 10.6 \*  
 beste Teiler 93.2 (40.) 96.7 (33.) 104.5 (35.)  
 Trefferlage 0.08 mm links, 0.34 mm tief  
 Streuwert 1.33, horizontal: 1.44, vertikal: 1.20

Unterschrift des Schützen



Ergebnis: **389** (411.0)  
 Serien: 96 96 98 99  
 Zähler: 29 11 0 0 0 0 0 0 0 0  
 Innenzehner: 25  
 weiteste: 388 (18), 311 (10), 308 (22)  
 beste Teiler 17.1 (3.) 29.6 (37.) 43.6 (36.)  
 Trefferlage 0.10 mm links, 0.33 mm hoch  
 Streuwert 1.37, horizontal: 1.38, vertikal: 1.35

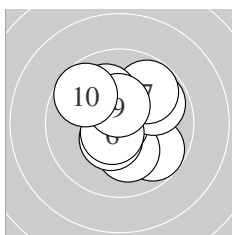
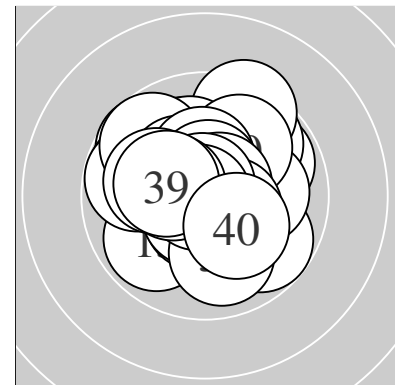

Serie 1:  
 9.8 ↘ 10.2 \* 10.9 \* 9.8 ↗ 10.5 \*  
 10.6 \* 9.8 ↗ 10.1 ↘ 10.4 \* 9.7 ↘  
 beste Teiler 17.1 (3.) 84.8 (6.) 125.7 (5.)  
 Trefferlage 0.25 mm rechts, 0.32 mm hoch  
 Streuwert 1.60, horizontal: 1.57, vertikal: 1.62

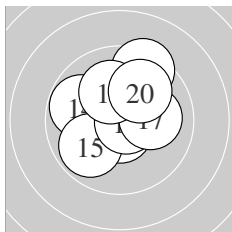

Serie 2:  
 10.4 \* 10.2 \* 10.6 \* 9.8 ↖ 9.9 ↗  
 10.8 \* 10.1 → 9.4 ↑ 10.1 ↖ 9.9 ↗  
 beste Teiler 49.3 (16.) 79.2 (13.) 131.2 (11.)  
 Trefferlage 0.10 mm rechts, 0.84 mm hoch  
 Streuwert 1.59, horizontal: 1.63, vertikal: 1.54

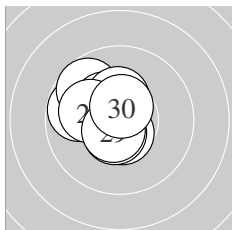

Serie 3:  
 9.8 ↖ 9.7 ↘ 10.3 \* 10.6 \* 10.3 \*  
 10.6 \* 10.6 \* 10.1 ↖ 10.6 \* 10.6 \*  
 beste Teiler 86.0 (29.) 91.2 (24.) 92.9 (26.)  
 Trefferlage 0.93 mm links, 0.53 mm hoch  
 Streuwert 1.07, horizontal: 1.08, vertikal: 1.05

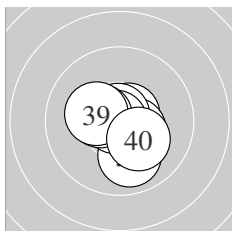

Serie 4:  
 10.7 \* 10.6 \* 10.6 \* 9.9 ↓ 10.5 \*  
 10.8 \* 10.8 \* 10.4 \* 10.3 \* 10.2 \*  
 beste Teiler 29.6 (37.) 43.6 (36.) 74.4 (31.)  
 Trefferlage 0.15 mm rechts, 0.38 mm tief  
 Streuwert 0.96, horizontal: 0.99, vertikal: 0.93

Unterschrift des Schützen

Ergebnis: **391** (405.6)  
 Serien: 100 98 94 99  
 Zähler: 32 7 1 0 0 0 0 0 0 0  
 Innenzehner: 21  
 weiteste: 553 (28), 457 (23), 427 (25)  
 beste Teiler 13.4 (3.) 64.5 (36.) 65.2 (19.)  
 Trefferlage 0.58 mm links, 0.79 mm hoch  
 Streuwert 1.54, horizontal: 1.80, vertikal: 1.22

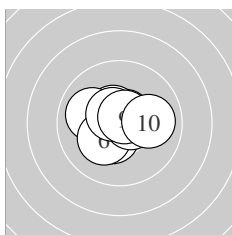
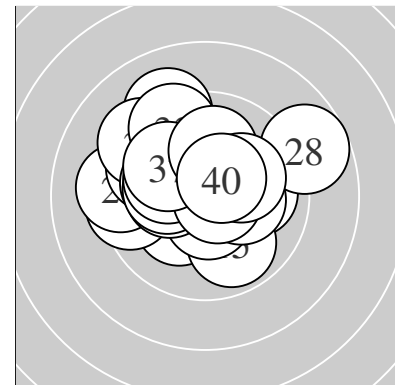

Serie 1:  
 10.7 \* 10.5 \* 10.9 \* 10.0 ↖ 10.4 \*  
 10.2 \* 10.6 \* 10.6 \* 10.7 \* 10.0 →  
 beste Teiler 13.4 (3.) 66.2 (9.) 75.4 (1.)  
 Trefferlage 0.09 mm links, 0.13 mm hoch  
 Streuwert 1.06, horizontal: 1.29, vertikal: 0.77

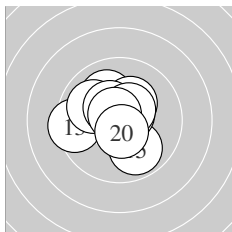

Serie 2:  
 10.1 ↖ 10.3 \* 9.4 ← 10.0 ↖ 9.9 ↘  
 10.6 \* 10.4 \* 10.5 \* 10.7 \* 10.6 \*  
 beste Teiler 65.2 (19.) 83.4 (16.) 96.5 (20.)  
 Trefferlage 0.44 mm links, 0.37 mm hoch  
 Streuwert 1.44, horizontal: 1.59, vertikal: 1.28

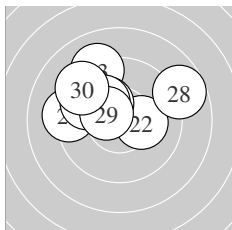

Serie 3:  
 10.0 ↖ 10.2 \* 9.1 ↖ 10.3 \* 9.2 ←  
 10.1 ↖ 9.7 ↖ 8.7 → 10.5 \* 9.3 ↖  
 beste Teiler 123.8 (29.) 175.6 (24.) 183.0 (22.)  
 Trefferlage 1.06 mm links, 1.59 mm hoch  
 Streuwert 2.08, horizontal: 2.67, vertikal: 1.25

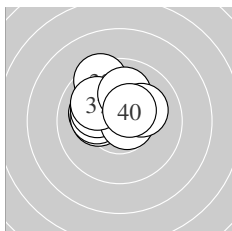

Serie 4:  
 10.1 ↖ 9.5 ↖ 10.2 \* 10.2 \* 10.1 ↖  
 10.7 \* 10.0 ↖ 10.0 ↑ 10.1 → 10.5 \*  
 beste Teiler 64.5 (36.) 121.6 (40.) 178.5 (33.)  
 Trefferlage 0.73 mm links, 1.08 mm hoch  
 Streuwert 1.29, horizontal: 1.48, vertikal: 1.06

Unterschrift des Schützen

Ergebnis: **389** (407.1)  
 Serien: 99 95 98 97  
 Zähler: 29 11 0 0 0 0 0 0 0 0  
 Innenzehner: 24  
 weiteste: 482 (3), 424 (25), 362 (34)  
 beste Teiler 23.0 (5.) 42.1 (19.) 59.1 (14.)  
 Trefferlage 0.36 mm links, 0.20 mm hoch  
 Streuwert 1.56, horizontal: 1.79, vertikal: 1.28

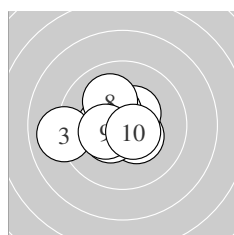
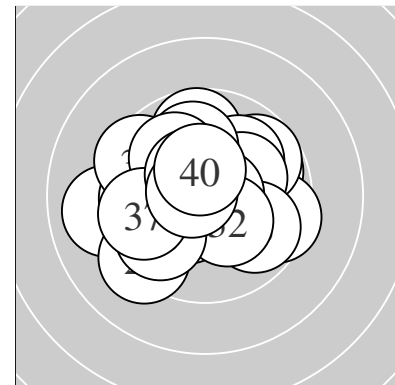

Serie 1:  
 10.4 \*                      10.4 \*                      9.0 ←                      10.4 \*                      10.9 \*  
 10.4 \*                      10.4 \*                      10.1 ↘                      10.4 \*                      10.5 \*  
 beste Teiler 23.0 (5.) 101.5 (10.) 126.4 (6.)  
 Trefferlage 0.76 mm links, 0.04 mm hoch  
 Streuwert 1.39, horizontal: 1.71, vertikal: 0.97

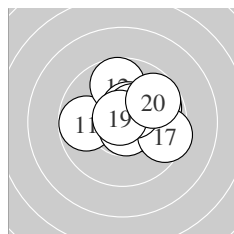

Serie 2:  
 9.8 ←                      9.7 ↑                      10.3 \*                      10.7 \*                      10.5 \*  
 9.8 →                      9.5 ↘                      10.5 \*                      10.8 \*                      9.7 ↗  
 beste Teiler 42.1 (19.) 59.1 (14.) 114.6 (15.)  
 Trefferlage 0.81 mm rechts, 0.64 mm hoch  
 Streuwert 1.56, horizontal: 1.85, vertikal: 1.20

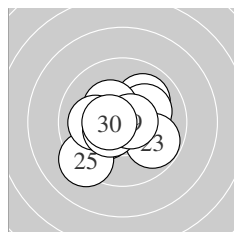

Serie 3:  
 10.0 ↗                      10.2 \*                      9.8 ↘                      10.3 \*                      9.3 ↙  
 10.3 \*                      10.1 ←                      10.5 \*                      10.7 \*                      10.5 \*  
 beste Teiler 65.2 (29.) 108.0 (30.) 118.8 (28.)  
 Trefferlage 0.31 mm links, 0.21 mm tief  
 Streuwert 1.62, horizontal: 1.83, vertikal: 1.38

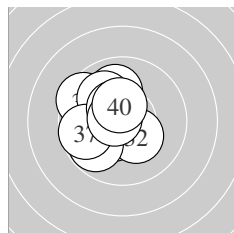

Serie 4:  
 10.4 \*                      10.3 \*                      9.8 ↙                      9.5 ↘                      10.0 ↑  
 10.0 ↘                      9.7 ←                      10.4 \*                      10.7 \*                      10.4 \*  
 beste Teiler 68.0 (39.) 126.7 (38.) 131.4 (40.)  
 Trefferlage 1.18 mm links, 0.34 mm hoch  
 Streuwert 1.42, horizontal: 1.31, vertikal: 1.51

Unterschrift des Schützen

Meyton Elektronik

Ergebnis: **387** (405.8)  
 Serien: 94 97 99 97  
 Zähler: 28 11 1 0 0 0 0 0 0 0  
 Innenzehner: 23  
 weiteste: 592 (1), 375 (37), 361 (34)  
 beste Teiler 53.3 (14.) 57.6 (25.) 62.9 (40.)  
 Trefferlage 0.45 mm rechts, 0.20 mm hoch  
 Streuwert 1.62, horizontal: 1.76, vertikal: 1.46

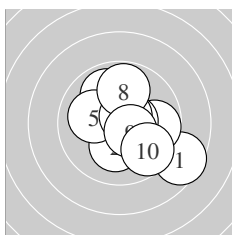
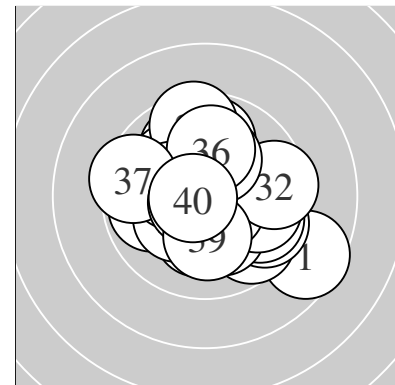

Serie 1:  
 8.6 ↘ 10.2 \* 9.8 → 9.9 ↗ 10.1 ↖  
 10.5 \* 10.6 \* 9.8 ↑ 10.5 \* 9.7 ↘  
 beste Teiler 79.5 (7.) 103.7 (6.) 115.2 (9.)  
 Trefferlage 0.96 mm rechts, 0.15 mm tief  
 Streuwert 1.99, horizontal: 2.09, vertikal: 1.88

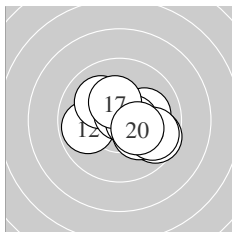

Serie 2:  
 10.1 → 9.9 ← 10.1 ↘ 10.7 \* 10.5 \*  
 9.6 ↘ 10.3 \* 10.2 \* 9.7 ↘ 10.3 \*  
 beste Teiler 53.3 (14.) 104.5 (15.) 156.9 (17.)  
 Trefferlage 0.75 mm rechts, 0.09 mm tief  
 Streuwert 1.53, horizontal: 1.88, vertikal: 1.07

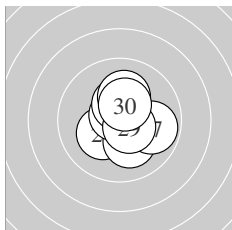

Serie 3:  
 10.2 \* 10.6 \* 10.2 \* 10.6 \* 10.7 \*  
 10.4 \* 9.9 → 10.2 \* 10.6 \* 10.4 \*  
 beste Teiler 57.6 (25.) 82.3 (24.) 89.1 (22.)  
 Trefferlage 0.45 mm rechts, 0.20 mm hoch  
 Streuwert 1.13, horizontal: 1.04, vertikal: 1.20

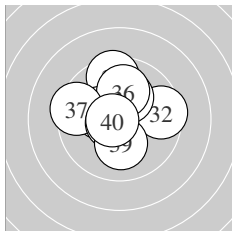

Serie 4:  
 10.4 \* 9.5 → 10.2 \* 9.5 ↑ 10.3 \*  
 10.0 ↑ 9.5 ← 10.7 \* 10.1 ↓ 10.7 \*  
 beste Teiler 62.9 (40.) 73.7 (38.) 150.4 (31.)  
 Trefferlage 0.33 mm links, 0.85 mm hoch  
 Streuwert 1.69, horizontal: 1.81, vertikal: 1.56

Unterschrift des Schützen

Meyton Elektronik

Ergebnis: **385** (401.7)  
 Serien: 98 94 98 95  
 Zähler: 28 9 3 0 0 0 0 0 0 0  
 Innenzehner: 19  
 weiteste: 570 (40), 523 (34), 511 (14)  
 beste Teiler 26.1 (7.) 66.1 (30.) 78.6 (32.)  
 Trefferlage 0.34 mm rechts, 0.36 mm hoch  
 Streuwert 1.84, horizontal: 2.16, vertikal: 1.46

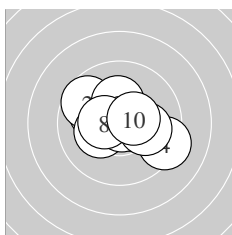
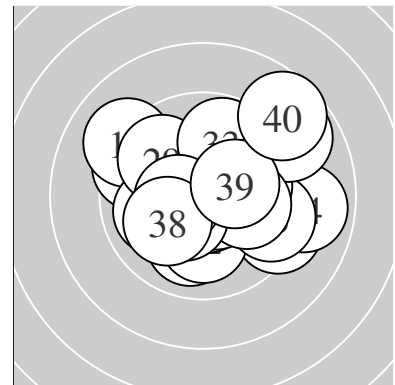

Serie 1:  
 10.1 ↖ 9.7 ↖ 10.2 \* 9.3 ↘ 10.5 \*  
 10.3 \* 10.8 \* 10.4 \* 10.1 → 10.5 \*  
 beste Teiler 26.1 (7.) 123.9 (5.) 124.2 (10.)  
 Trefferlage 0.08 mm rechts, 0.16 mm hoch  
 Streuwert 1.63, horizontal: 2.05, vertikal: 1.08

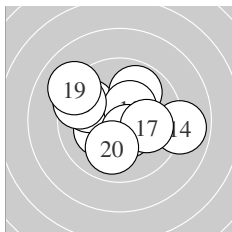

Serie 2:  
 10.2 \* 9.8 ↖ 9.9 ↗ 8.9 → 10.4 \*  
 10.5 \* 10.0 → 9.5 ↖ 9.1 ↖ 10.0 ↓  
 beste Teiler 114.6 (16.) 139.4 (15.) 183.8 (11.)  
 Trefferlage 0.18 mm links, 0.36 mm hoch  
 Streuwert 2.28, horizontal: 2.78, vertikal: 1.63

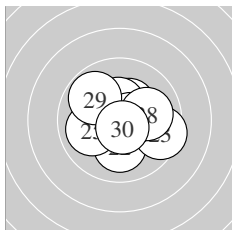

Serie 3:  
 10.6 \* 10.1 ↓ 9.5 ↘ 10.4 \* 10.0 ←  
 10.4 \* 10.6 \* 10.0 → 9.8 ↖ 10.7 \*  
 beste Teiler 66.1 (30.) 90.3 (27.) 100.1 (21.)  
 Trefferlage 0.40 mm rechts, 0.09 mm hoch  
 Streuwert 1.52, horizontal: 1.74, vertikal: 1.25

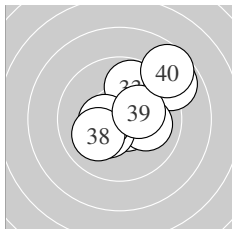

Serie 4:  
 10.2 \* 10.6 \* 9.8 ↗ 8.9 ↗ 10.0 →  
 10.4 \* 10.4 \* 10.1 ↙ 10.3 \* 8.7 ↗  
 beste Teiler 78.6 (32.) 126.1 (37.) 142.2 (36.)  
 Trefferlage 1.08 mm rechts, 0.83 mm hoch  
 Streuwert 1.97, horizontal: 2.08, vertikal: 1.86

Unterschrift des Schützen

Ergebnis: **357** (377.5)  
 Serien: 91 85 92 89  
 Zähler: 9 22 6 3 0 0 0 0 0 0  
 Innenzehner: 7  
 weiteste: 937 (5), 857 (15), 851 (20)  
 beste Teiler 112.4 (22.) 118.7 (4.) 119.8 (25.)  
 Trefferlage 0.95 mm links, 0.72 mm hoch  
 Streuwert 2.94, horizontal: 3.61, vertikal: 2.06

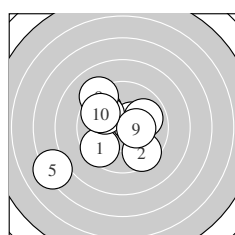
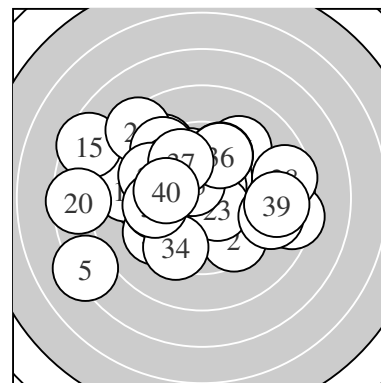

Serie 1:  
 9.6 ↙ 9.5 ↘ 9.7 ↖ 10.5 \* 7.2 ↙  
 10.0 ↖ 9.9 → 9.2 ↖ 10.3 \* 9.7 ↖  
 beste Teiler 118.7 (4.) 156.5 (9.) 249.4 (6.)  
 Trefferlage 1.31 mm links, 0.01 mm hoch  
 Streuwert 2.89, horizontal: 3.19, vertikal: 2.57

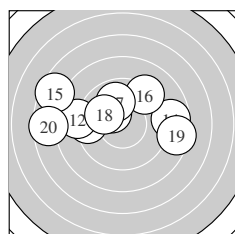

Serie 2:  
 9.4 ← 8.9 ← 10.3 \* 8.7 → 7.5 ↖  
 9.3 ↗ 9.9 ↑ 10.0 ↖ 8.4 → 7.5 ←  
 beste Teiler 173.9 (13.) 237.5 (18.) 267.5 (17.)  
 Trefferlage 1.53 mm links, 1.16 mm hoch  
 Streuwert 3.78, horizontal: 5.10, vertikal: 1.59

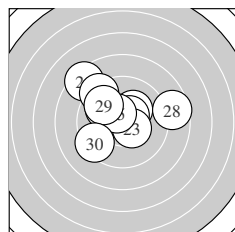

Serie 3:  
 10.2 \* 10.5 \* 10.4 \* 9.9 ↖ 10.5 \*  
 8.4 ↖ 9.2 ↖ 8.6 → 9.8 ↖ 9.4 ↙  
 beste Teiler 112.4 (22.) 119.8 (25.) 127.5 (23.)  
 Trefferlage 0.64 mm links, 1.29 mm hoch  
 Streuwert 2.49, horizontal: 2.94, vertikal: 1.93

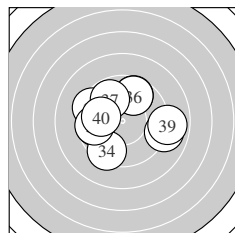

Serie 4:  
 9.4 ↖ 9.7 ↗ 9.7 ← 9.4 ↙ 9.0 →  
 9.7 ↗ 9.8 ↖ 9.6 ← 8.9 → 9.9 ←  
 beste Teiler 252.0 (40.) 288.6 (37.) 316.3 (36.)  
 Trefferlage 0.32 mm links, 0.42 mm hoch  
 Streuwert 2.72, horizontal: 3.25, vertikal: 2.06

Unterschrift des Schützen

Meyton Elektronik

Ergebnis: **383** (401.4)  
 Serien: 94 93 98 98  
 Zähler: 24 15 1 0 0 0 0 0 0 0  
 Innenzehner: 16  
 weiteste: 503 (16), 444 (10), 421 (19)  
 beste Teiler 31.9 (6.) 54.4 (39.) 61.9 (29.)  
 Trefferlage 0.47 mm rechts, 0.78 mm tief  
 Streuwert 1.70, horizontal: 1.92, vertikal: 1.44

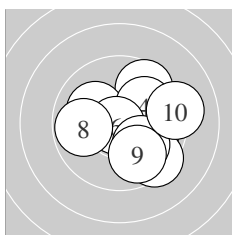
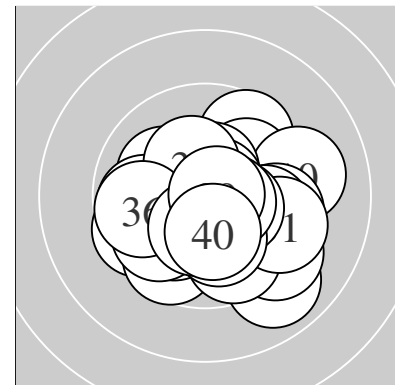

Serie 1:  
 9.9 ↘ 9.6 ↗ 10.1 ↖ 10.0 ↗ 9.4 ↘  
 10.8 \* 10.0 ↘ 9.8 ← 9.8 ↘ 9.2 →  
 beste Teiler 31.9 (6.) 213.8 (3.) 234.7 (7.)  
 Trefferlage 1.12 mm rechts, 0.23 mm tief  
 Streuwert 1.98, horizontal: 2.17, vertikal: 1.76

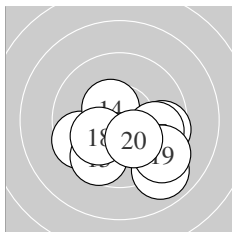

Serie 2:  
 9.6 ← 10.7 \* 9.7 ↘ 10.5 \* 9.6 →  
 8.9 ↘ 9.8 → 10.1 ↗ 9.3 ↘ 10.2 \*  
 beste Teiler 66.1 (12.) 116.4 (14.) 182.8 (20.)  
 Trefferlage 0.60 mm rechts, 1.41 mm tief  
 Streuwert 1.98, horizontal: 2.41, vertikal: 1.42

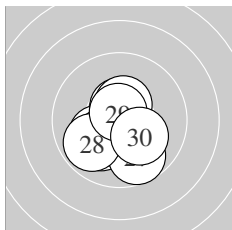

Serie 3:  
 10.1 ↗ 10.1 ↗ 10.0 ↘ 10.5 \* 10.2 \*  
 10.5 \* 9.7 ↘ 9.9 ↗ 10.7 \* 10.2 \*  
 beste Teiler 61.9 (29.) 103.3 (24.) 123.2 (26.)  
 Trefferlage 0.24 mm links, 0.91 mm tief  
 Streuwert 1.35, horizontal: 1.34, vertikal: 1.37

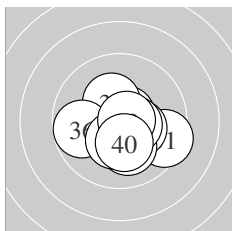

Serie 4:  
 9.5 → 10.3 \* 10.7 \* 10.3 \* 10.1 ↘  
 9.8 ← 10.3 \* 10.5 \* 10.7 \* 10.3 \*  
 beste Teiler 54.4 (39.) 70.0 (33.) 110.8 (38.)  
 Trefferlage 0.40 mm rechts, 0.59 mm tief  
 Streuwert 1.38, horizontal: 1.63, vertikal: 1.08

Unterschrift des Schützen

Meyton Elektronik

Ergebnis: **380** (399.3)  
 Serien: 95 95 96 94  
 Zähler: 21 18 1 0 0 0 0 0 0 0  
 Innenzehner: 16  
 weiteste: 700 (38), 467 (11), 442 (15)  
 beste Teiler 49.0 (37.) 51.4 (34.) 68.6 (9.)  
 Trefferlage 1.30 mm rechts, 0.44 mm hoch  
 Streuwert 1.77, horizontal: 2.07, vertikal: 1.41

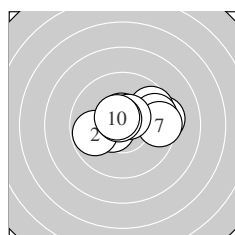
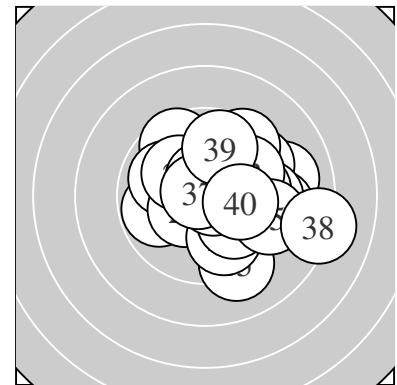

Serie 1:  
 10.5 \*                      9.8 ←                      10.6 \*                      9.4 →                      9.7 ↗  
 9.6 →                      9.5 →                      10.6 \*                      10.7 \*                      10.6 \*  
 beste Teiler 68.6 (9.) 95.0 (3.) 96.0 (10.)  
 Trefferlage 0.93 mm rechts, 0.51 mm hoch  
 Streuwert 1.70, horizontal: 2.31, vertikal: 0.71

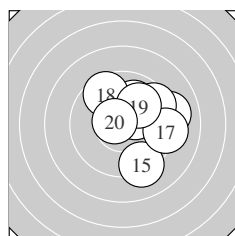

Serie 2:  
 9.1 →                      10.0 ↗                      10.3 \*                      9.5 ↗                      9.2 ↓  
 10.4 \*                      9.2 →                      9.6 ↘                      10.0 ↗                      10.6 \*  
 beste Teiler 84.1 (20.) 144.1 (16.) 164.4 (13.)  
 Trefferlage 1.66 mm rechts, 0.70 mm hoch  
 Streuwert 1.96, horizontal: 1.97, vertikal: 1.95

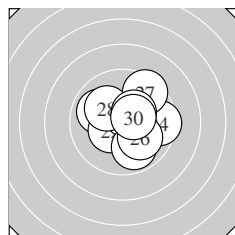

Serie 3:  
 9.9 ↖                      10.4 \*                      10.6 \*                      9.5 →                      9.9 ↓  
 10.0 ↘                      9.5 ↗                      10.1 ↖                      10.4 \*                      10.5 \*  
 beste Teiler 81.1 (23.) 118.1 (30.) 142.5 (22.)  
 Trefferlage 0.62 mm rechts, 0.26 mm hoch  
 Streuwert 1.70, horizontal: 1.83, vertikal: 1.55

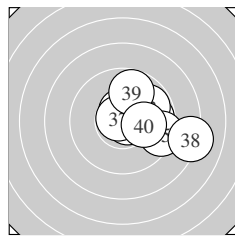

Serie 4:  
 9.8 →                      10.6 \*                      9.8 ↗                      10.7 \*                      9.3 →  
 10.5 \*                      10.8 \*                      8.2 →                      9.8 ↑                      10.1 →  
 beste Teiler 49.0 (37.) 51.4 (34.) 99.8 (32.)  
 Trefferlage 1.98 mm rechts, 0.29 mm hoch  
 Streuwert 1.79, horizontal: 2.16, vertikal: 1.32

Unterschrift des Schützen

Meyton Elektronik