

Ergebnis: **391** (409.8)
 Serien: 97 97 99 98
 Zähler: 31 9 0 0 0 0 0 0 0 0
 Innenzehner: 25
 weiteste: 419 (30), 409 (14), 406 (7)
 beste Teiler 32.8 (6.) 36.3 (26.) 42.2 (36.)
 Trefferlage 0.15 mm rechts, 0.23 mm hoch
 Streuwert 1.48, horizontal: 1.71, vertikal: 1.21

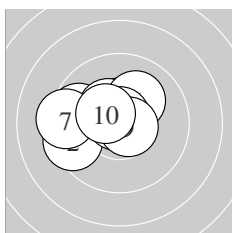

Serie 1:
 9.7 ← 9.4 ← 10.5 * 10.4 * 10.1 ↗
 10.8 * 9.3 ← 10.8 * 10.7 * 10.4 *
 beste Teiler 32.8 (6.) 50.0 (8.) 71.3 (9.)
 Trefferlage 1.08 mm links, 0.49 mm hoch
 Streuwert 1.43, horizontal: 1.84, vertikal: 0.85

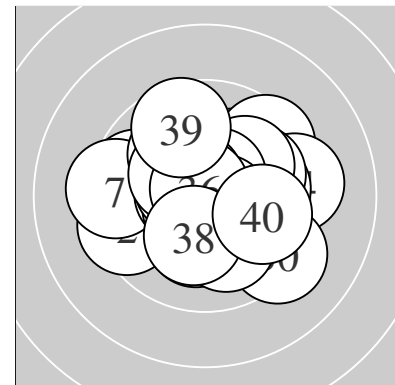
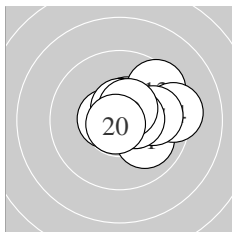

Serie 2:
 10.0 ↘ 10.5 * 9.5 ↗ 9.3 → 10.6 *
 10.6 * 9.9 → 10.5 * 10.5 * 10.8 *
 beste Teiler 42.4 (20.) 90.1 (16.) 95.5 (15.)
 Trefferlage 1.23 mm rechts, 0.45 mm hoch
 Streuwert 1.29, horizontal: 1.55, vertikal: 0.97

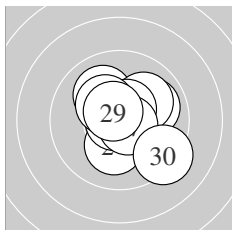

Serie 3:
 10.0 ↘ 10.0 → 10.0 ↗ 10.2 * 10.6 *
 10.8 * 10.7 * 10.3 * 10.6 * 9.3 ↘
 beste Teiler 36.3 (26.) 73.5 (27.) 83.0 (29.)
 Trefferlage 0.49 mm rechts, 0.19 mm hoch
 Streuwert 1.49, horizontal: 1.52, vertikal: 1.45

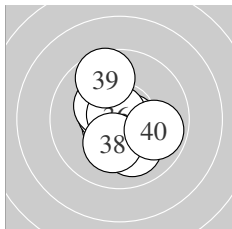

Serie 4:
 10.6 * 10.5 * 10.6 * 10.5 * 10.3 *
 10.8 * 10.0 ↘ 10.2 * 9.6 ↗ 9.9 →
 beste Teiler 42.2 (36.) 78.6 (33.) 82.2 (31.)
 Trefferlage 0.03 mm links, 0.18 mm tief
 Streuwert 1.35, horizontal: 1.18, vertikal: 1.51

Unterschrift des Schützen

Meyton Elektronik

Ergebnis: **394** (413.8)
 Serien: 98 98 100 98
 Zähler: 34 6 0 0 0 0 0 0 0 0
 Innenzehner: 30
 weiteste: 376 (10), 292 (8), 278 (40)
 beste Teiler 15.2 (32.) 16.4 (9.) 58.0 (22.)
 Trefferlage 0.13 mm rechts, 0.10 mm hoch
 Streuwert 1.23, horizontal: 1.37, vertikal: 1.07

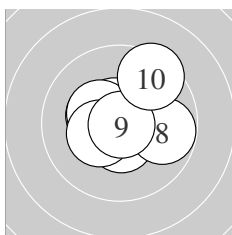
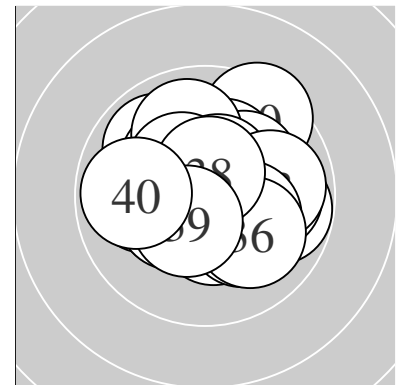

Serie 1:
 10.6 * 10.6 * 10.7 * 10.5 * 10.4 *
 10.4 * 10.4 * 9.8 → 10.9 * 9.4 ↗
 beste Teiler 16.4 (9.) 68.8 (3.) 83.3 (2.)
 Trefferlage 0.11 mm rechts, 0.12 mm hoch
 Streuwert 1.34, horizontal: 1.42, vertikal: 1.25

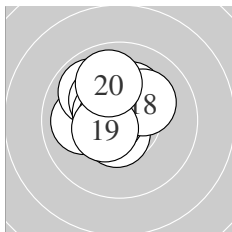

Serie 2:
 10.0 ← 9.9 ↖ 10.2 * 10.6 * 10.2 *
 10.5 * 10.7 * 10.2 * 10.5 * 9.9 ↗
 beste Teiler 61.1 (17.) 94.9 (14.) 105.1 (16.)
 Trefferlage 0.66 mm links, 0.75 mm hoch
 Streuwert 1.14, horizontal: 1.16, vertikal: 1.13

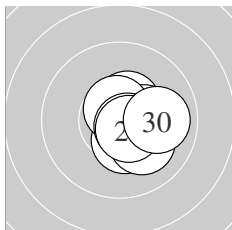

Serie 3:
 10.4 * 10.7 * 10.5 * 10.3 * 10.6 *
 10.6 * 10.1 ↘ 10.7 * 10.6 * 10.0 →
 beste Teiler 58.0 (22.) 67.4 (28.) 77.3 (25.)
 Trefferlage 0.87 mm rechts, 0.23 mm tief
 Streuwert 0.79, horizontal: 0.78, vertikal: 0.80

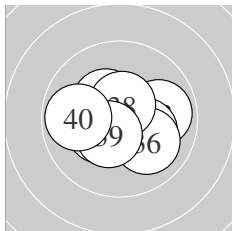

Serie 4:
 10.2 * 10.9 * 9.9 → 10.4 * 10.2 *
 10.0 ↘ 10.4 * 10.6 * 10.5 * 9.8 ←
 beste Teiler 15.2 (32.) 97.4 (38.) 125.4 (39.)
 Trefferlage 0.21 mm rechts, 0.23 mm tief
 Streuwert 1.35, horizontal: 1.69, vertikal: 0.89

Unterschrift des Schützen

Meyton Elektronik

Ergebnis:	386	(402.9)
Serien:	98 98 96 94	
Zähler:	26 14 0 0 0 0 0 0 0 0	
Innenzehner:	20	
weiteste:	482 (5), 405 (38), 369 (35)	
beste Teiler	49.7 (21.) 73.8 (22.) 74.2 (24.)	
Trefferlage	0.41 mm rechts, 0.24 mm hoch	
Streuwert	1.68, horizontal: 1.96, vertikal: 1.35	

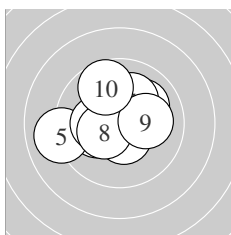
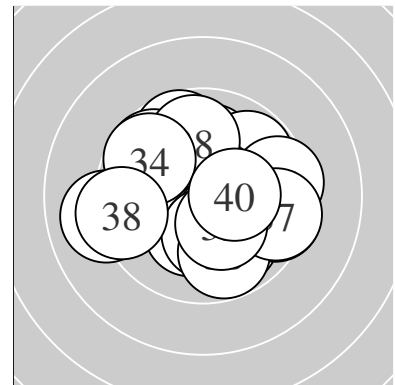

Serie 1:	10.1 ↗	10.5 *	10.6 *	10.2 *	9.0 ←
	10.2 *	10.1 ↗	10.4 *	10.1 →	9.7 ↖
beste Teiler	86.0 (3.)	115.4 (2.)	139.5 (8.)		
Trefferlage	0.50 mm links, 0.36 mm hoch				
Streuwert	1.73, horizontal: 2.06, vertikal: 1.33				

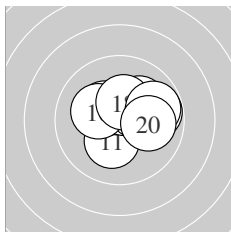

Serie 2:	10.2 *	10.3 *	10.5 *	10.3 *	10.1 ↗
	10.2 *	9.8 →	10.4 *	9.8 →	10.0 →
beste Teiler	105.9 (13.)	148.4 (18.)	153.2 (12.)		
Trefferlage	0.80 mm rechts, 0.58 mm hoch				
Streuwert	1.33, horizontal: 1.64, vertikal: 0.92				

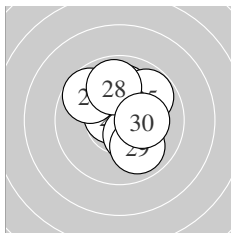

Serie 3:	10.8 *	10.7 *	10.0 ↑	10.7 *	9.8 ↗
	9.7 ↘	10.4 *	9.9 ↑	9.9 ↘	10.2 *
beste Teiler	49.7 (21.)	73.8 (22.)	74.2 (24.)		
Trefferlage	0.39 mm rechts, 0.65 mm hoch				
Streuwert	1.45, horizontal: 1.34, vertikal: 1.56				

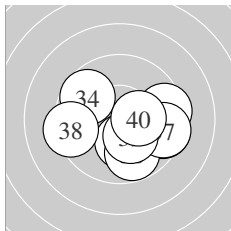

Serie 4:	10.2 *	9.5 →	10.2 *	9.7 ↘	9.5 →
	9.8 ↓	9.5 →	9.3 ←	10.3 *	10.3 *
beste Teiler	154.1 (40.)	162.5 (39.)	184.3 (33.)		
Trefferlage	0.96 mm rechts, 0.63 mm tief				
Streuwert	2.03, horizontal: 2.56, vertikal: 1.28				

Unterschrift des Schützen

Meyton Elektronik

Ergebnis: **385** (406.4)
 Serien: 98 95 97 95
 Zähler: 26 13 1 0 0 0 0 0 0 0
 Innenzehner: 24
 weiteste: 577 (15), 453 (38), 420 (37)
 beste Teiler 9.8 (2.) 35.3 (36.) 59.2 (8.)
 Trefferlage 0.32 mm links, 1.02 mm hoch
 Streuwert 1.49, horizontal: 1.62, vertikal: 1.36

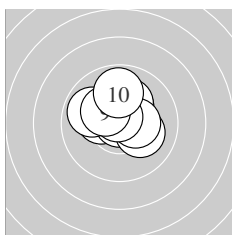
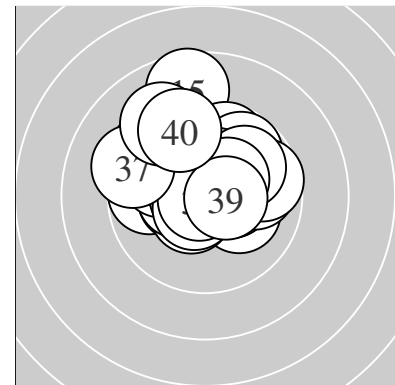

Serie 1:
 10.3 * 10.9 * 10.3 * 9.9 ↖ 10.2 *
 10.1 ↗ 10.4 * 10.7 * 10.3 * 9.9 ↑
 beste Teiler 9.8 (2.) 59.2 (8.) 144.0 (7.)
 Trefferlage 0.08 mm links, 0.82 mm hoch
 Streuwert 1.21, horizontal: 1.38, vertikal: 1.02

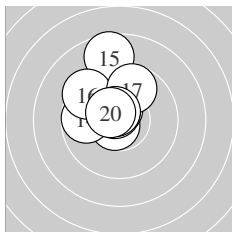

Serie 2:
 10.7 * 10.6 * 10.3 * 9.8 ← 8.6 ↑
 9.5 ↘ 9.7 ↑ 10.7 * 10.6 * 10.5 *
 beste Teiler 63.7 (11.) 72.4 (18.) 85.8 (19.)
 Trefferlage 0.86 mm links, 1.50 mm hoch
 Streuwert 1.52, horizontal: 1.24, vertikal: 1.77

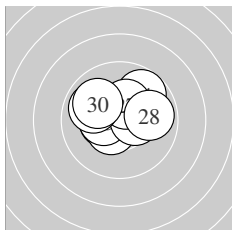

Serie 3:
 10.4 * 10.5 * 10.5 * 9.8 ↗ 10.4 *
 10.4 * 10.3 * 9.9 → 9.9 ↖ 10.0 ↘
 beste Teiler 101.2 (22.) 114.1 (23.) 138.3 (21.)
 Trefferlage 0.19 mm links, 0.64 mm hoch
 Streuwert 1.40, horizontal: 1.73, vertikal: 0.95

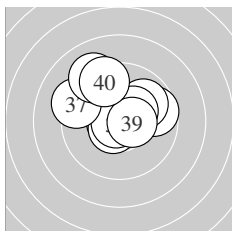

Serie 4:
 10.7 * 9.7 → 9.9 ↗ 10.6 * 10.3 *
 10.8 * 9.3 ↖ 9.1 ↘ 10.5 * 9.4 ↖
 beste Teiler 35.3 (36.) 74.5 (31.) 88.6 (34.)
 Trefferlage 0.16 mm links, 1.12 mm hoch
 Streuwert 1.85, horizontal: 2.11, vertikal: 1.56

Unterschrift des Schützen

Meyton Elektronik

Ergebnis: **374** (393.0)
 Serien: 89 93 97 95
 Zähler: 17 20 3 0 0 0 0 0 0 0
 Innenzehner: 14
 weiteste: 601 (19), 590 (6), 545 (8)
 beste Teiler 101.7 (2.) 103.7 (33.) 120.4 (14.)
 Trefferlage 0.72 mm rechts, 0.20 mm tief
 Streuwert 2.16, horizontal: 2.34, vertikal: 1.96

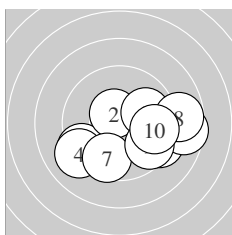
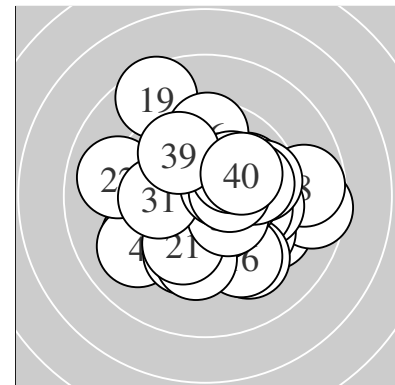

Serie 1:
 9.3 ↙ 10.5 * 9.3 ↘ 9.1 ↙ 9.9 →
 8.6 → 9.6 ↓ 8.8 → 9.6 ↘ 9.7 →
 beste Teiler 101.7 (2.) 256.8 (5.) 323.7 (10.)
 Trefferlage 1.44 mm rechts, 1.07 mm tief
 Streuwert 2.67, horizontal: 3.45, vertikal: 1.53

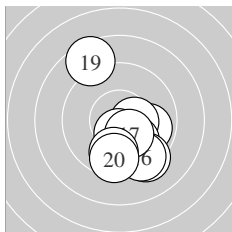

Serie 2:
 9.9 → 10.4 * 10.0 ↘ 10.5 * 9.3 ↘
 9.4 ↘ 10.3 * 9.8 ↓ 8.5 ↖ 9.6 ↓
 beste Teiler 120.4 (14.) 134.8 (12.) 153.1 (17.)
 Trefferlage 0.67 mm rechts, 1.28 mm tief
 Streuwert 2.19, horizontal: 1.63, vertikal: 2.63

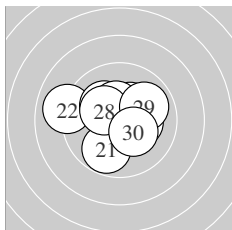

Serie 3:
 9.8 ↓ 9.0 ← 10.3 * 10.3 * 10.2 *
 10.3 * 10.4 * 10.3 * 9.9 → 10.3 *
 beste Teiler 137.0 (27.) 154.4 (26.) 164.6 (30.)
 Trefferlage 0.14 mm links, 0.39 mm hoch
 Streuwert 1.77, horizontal: 2.13, vertikal: 1.31

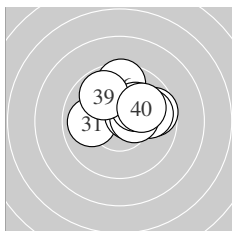

Serie 4:
 9.9 ← 9.7 → 10.5 * 10.1 → 9.9 →
 9.6 ↑ 10.4 * 10.2 * 9.8 ↖ 10.0 →
 beste Teiler 103.7 (33.) 137.6 (37.) 194.7 (38.)
 Trefferlage 0.94 mm rechts, 1.16 mm hoch
 Streuwert 1.45, horizontal: 1.78, vertikal: 1.04

Unterschrift des Schützen

Ergebnis: **374** (393.8)
 Serien: 91 92 97 94
 Zähler: 19 17 3 1 0 0 0 0 0 0
 Innenzehner: 17
 weiteste: 758 (1), 636 (12), 565 (17)
 beste Teiler 24.7 (18.) 49.7 (16.) 79.4 (32.)
 Trefferlage 0.25 mm links, 0.10 mm tief
 Streuwert 2.30, horizontal: 2.92, vertikal: 1.43

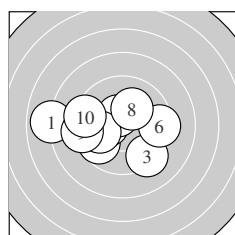
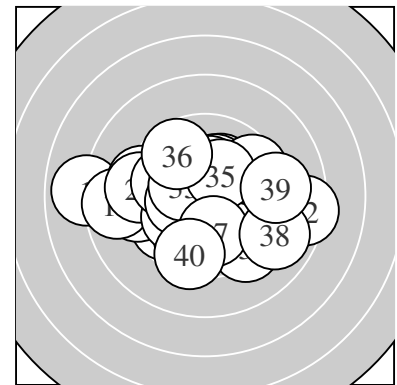

Serie 1:
 7.9 ← 9.7 ↙ 9.3 ↘ 10.3 * 10.5 *
 9.4 → 9.9 ← 10.2 * 9.2 ← 9.3 ←
 beste Teiler 111.3 (5.) 161.0 (4.) 199.8 (8.)
 Trefferlage 1.54 mm links, 0.26 mm tief
 Streuwert 2.65, horizontal: 3.44, vertikal: 1.47

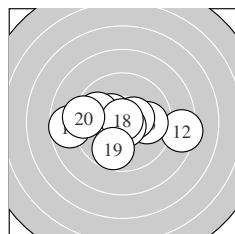

Serie 2:
 10.4 * 8.4 → 9.9 → 9.8 ↖ 10.5 *
 10.8 * 8.7 ← 10.9 * 9.8 ↓ 9.3 ←
 beste Teiler 24.7 (18.) 49.7 (16.) 123.7 (15.)
 Trefferlage 0.44 mm links, 0.17 mm tief
 Streuwert 2.53, horizontal: 3.41, vertikal: 1.10

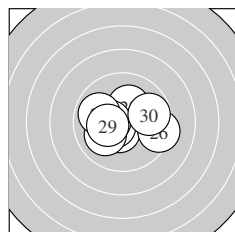

Serie 3:
 10.3 * 10.5 * 10.2 * 10.6 * 10.0 ↙
 9.4 → 10.4 * 9.9 ↖ 10.3 * 9.8 →
 beste Teiler 98.6 (24.) 107.2 (22.) 135.2 (27.)
 Trefferlage 0.05 mm rechts, 0.01 mm tief
 Streuwert 1.66, horizontal: 2.13, vertikal: 0.98

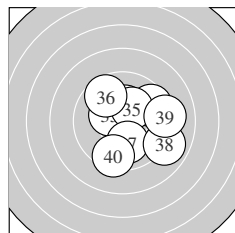

Serie 4:
 10.3 * 10.6 * 10.3 * 9.6 ↗ 10.3 *
 9.7 ↘ 10.0 ↓ 8.9 ↘ 9.1 → 9.4 ↓
 beste Teiler 79.4 (32.) 152.0 (33.) 161.2 (31.)
 Trefferlage 0.89 mm rechts, 0.05 mm hoch
 Streuwert 2.23, horizontal: 2.34, vertikal: 2.11

Unterschrift des Schützen

Ergebnis:	379	(401.1)
Serien:	94 96 96 93	
Zähler:	19 21 0 0 0 0 0 0 0 0	
Innenzehner:	13	
weiteste:	414 (27), 377 (2), 367 (37)	
beste Teiler	41.4 (30.) 48.3 (24.) 62.9 (35.)	
Trefferlage	0.54 mm rechts, 0.55 mm hoch	
Streuwert	1.72, horizontal: 1.73, vertikal: 1.71	

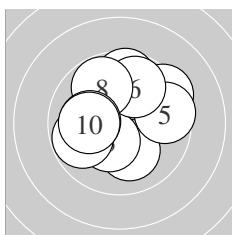
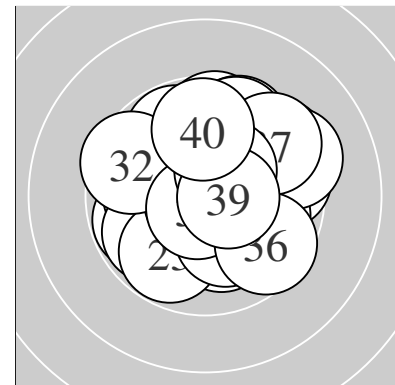

Serie 1:					
	10.1 ↘	9.4 ↗	10.4 *	9.7 ↑	9.6 →
	9.8 ↗	9.8 ←	9.8 ↘	10.1 ←	10.1 ←
beste Teiler	150.4 (3.) 209.7 (1.) 217.3 (9.)				
Trefferlage	0.04 mm links, 0.71 mm hoch				
Streuwert	2.01, horizontal: 2.16, vertikal: 1.85				

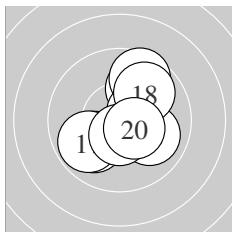

Serie 2:					
	9.9 ↗	9.6 ↗	10.4 *	10.0 ↙	10.5 *
	10.0 →	9.8 ↙	9.9 ↗	10.5 *	10.5 *
beste Teiler	108.0 (19.) 120.2 (15.) 122.6 (20.)				
Trefferlage	0.59 mm rechts, 0.13 mm hoch				
Streuwert	1.63, horizontal: 1.52, vertikal: 1.73				

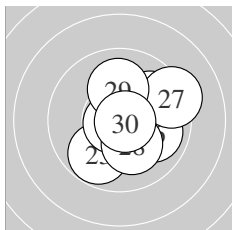

Serie 3:					
	10.6 *	9.9 ↗	9.8 ↙	10.8 *	10.6 *
	9.9 →	9.3 →	10.2 *	10.0 ↑	10.8 *
beste Teiler	41.4 (30.) 48.3 (24.) 87.6 (21.)				
Trefferlage	0.88 mm rechts, 0.04 mm hoch				
Streuwert	1.52, horizontal: 1.55, vertikal: 1.50				

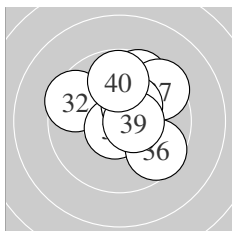

Serie 4:					
	9.9 ↗	9.5 ↖	9.8 ↗	9.6 ↗	10.7 *
	9.6 ↘	9.5 ↗	10.4 *	10.5 *	9.8 ↑
beste Teiler	62.9 (35.) 102.1 (39.) 143.6 (38.)				
Trefferlage	0.73 mm rechts, 1.31 mm hoch				
Streuwert	1.71, horizontal: 1.72, vertikal: 1.70				

Unterschrift des Schützen

Meyton Elektronik

Ergebnis:	370	(387.5)
Serien:	92 89 93 96	
Zähler:	14 23 2 1 0 0 0 0 0 0	
Innenzehner:	8	
weiteste:	828 (18), 721 (12), 536 (8)	
beste Teiler	107.4 (35.) 112.9 (3.) 127.0 (30.)	
Trefferlage	0.97 mm rechts, 0.54 mm hoch	
Streuwert	2.38, horizontal: 2.92, vertikal: 1.68	

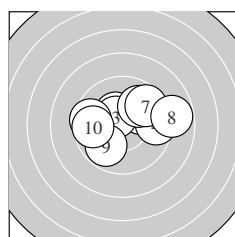
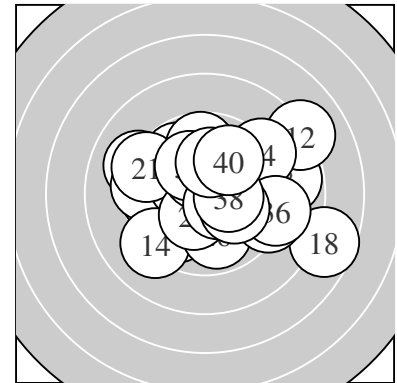

Serie 1:	10.4 *	10.0 ↗	10.5 *	9.5 →	9.9 ↗
	9.6 ←	9.7 ↗	8.8 →	9.8 ↘	9.7 ←
beste Teiler	112.9 (3.)	150.9 (1.)	231.6 (2.)		
Trefferlage	0.51 mm rechts, 0.68 mm hoch				
Streuwert	2.25, horizontal: 2.94, vertikal: 1.24				

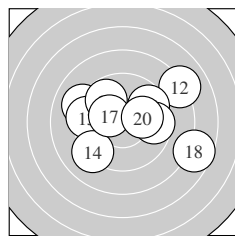

Serie 2:	9.1 ↖	8.1 ↗	9.4 ←	9.1 ↘	9.6 ↗
	9.8 ↘	10.3 *	7.6 →	9.6 →	10.1 →
beste Teiler	156.1 (17.)	218.5 (20.)	294.4 (16.)		
Trefferlage	0.75 mm rechts, 0.50 mm hoch				
Streuwert	3.39, horizontal: 4.26, vertikal: 2.22				

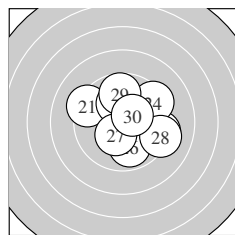

Serie 3:	9.3 ↖	9.8 →	9.3 →	9.4 ↗	10.1 ↗
	9.9 ↓	10.3 *	9.2 →	9.7 ↑	10.4 *
beste Teiler	127.0 (30.)	154.3 (27.)	208.8 (25.)		
Trefferlage	1.06 mm rechts, 0.27 mm hoch				
Streuwert	2.24, horizontal: 2.53, vertikal: 1.90				

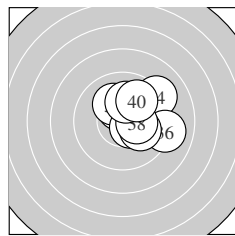

Serie 4:	10.4 *	9.8 →	10.1 ↘	9.2 ↗	10.5 *
	9.1 →	10.1 →	10.3 *	10.1 ↑	9.9 ↗
beste Teiler	107.4 (35.)	132.1 (31.)	153.3 (38.)		
Trefferlage	1.56 mm rechts, 0.71 mm hoch				
Streuwert	1.59, horizontal: 1.74, vertikal: 1.41				

Unterschrift des Schützen

Ergebnis: **395** (412.0)
 Serien: 99 100 98 98
 Zähler: 35 5 0 0 0 0 0 0 0 0
 Innenzehner: 28
 weiteste: 485 (30), 339 (35), 286 (38)
 beste Teiler 26.0 (32.) 41.4 (33.) 42.4 (39.)
 Trefferlage 0.12 mm links, 0.02 mm hoch
 Streuwert 1.32, horizontal: 1.56, vertikal: 1.03

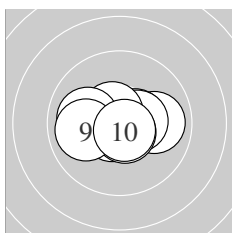
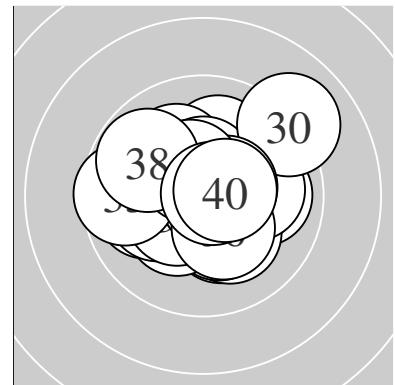

Serie 1:
 10.6 * 9.9 → 10.1 ← 10.5 * 10.4 *
 10.6 * 10.6 * 10.0 ← 10.0 ← 10.7 *
 beste Teiler 62.6 (10.) 76.3 (1.) 76.6 (7.)
 Trefferlage 0.22 mm links, 0.08 mm tief
 Streuwert 1.23, horizontal: 1.67, vertikal: 0.47

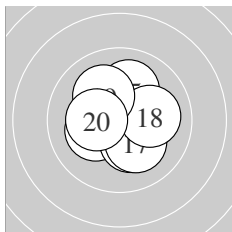

Serie 2:
 10.5 * 10.2 * 10.2 * 10.4 * 10.1 ↗
 10.3 * 10.2 * 10.1 → 10.1 ↘ 10.3 *
 beste Teiler 108.2 (11.) 140.8 (14.) 167.0 (20.)
 Trefferlage 0.41 mm rechts, 0.03 mm hoch
 Streuwert 1.34, horizontal: 1.43, vertikal: 1.25

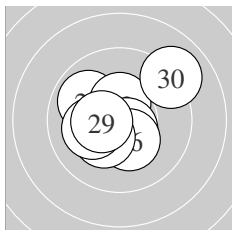

Serie 3:
 10.4 * 9.9 ↖ 10.5 * 10.6 * 10.6 *
 10.3 * 10.3 * 10.1 ← 10.4 * 9.0 ↗
 beste Teiler 81.6 (25.) 92.1 (24.) 121.0 (23.)
 Trefferlage 0.32 mm links, 0.00 mm
 Streuwert 1.59, horizontal: 1.72, vertikal: 1.45

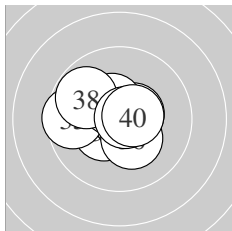

Serie 4:
 10.4 * 10.8 * 10.8 * 10.5 * 9.6 ←
 10.3 * 10.5 * 9.8 ↖ 10.8 * 10.6 *
 beste Teiler 26.0 (32.) 41.4 (33.) 42.4 (39.)
 Trefferlage 0.36 mm links, 0.12 mm hoch
 Streuwert 1.22, horizontal: 1.51, vertikal: 0.83

Unterschrift des Schützen

Meyton Elektronik

Ergebnis: **384** (404.6)
 Serien: 93 96 97 98
 Zähler: 26 12 2 0 0 0 0 0 0 0
 Innenzehner: 20
 weiteste: 517 (4), 501 (17), 351 (2)
 beste Teiler 21.3 (32.) 29.2 (39.) 44.1 (16.)
 Trefferlage 0.16 mm links, 0.62 mm hoch
 Streuwert 1.64, horizontal: 1.86, vertikal: 1.39

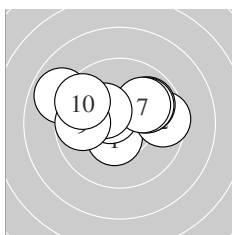
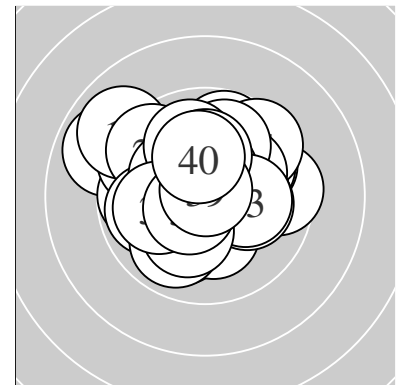

Serie 1:
 10.5 * 9.5 → 9.9 ↗ 8.9 ↖ 9.9 ↗
 10.6 * 10.0 ↗ 10.3 * 9.8 ← 9.6 ↖
 beste Teiler 96.8 (6.) 124.9 (1.) 160.0 (8.)
 Trefferlage 0.33 mm links, 0.91 mm hoch
 Streuwert 2.04, horizontal: 2.71, vertikal: 1.00

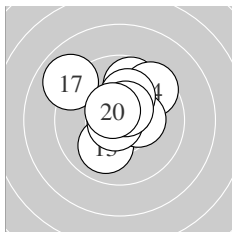

Serie 2:
 9.8 ↑ 10.6 * 10.0 ↙ 9.6 ↗ 10.4 *
 10.8 * 8.9 ↖ 10.1 ↑ 10.5 * 10.6 *
 beste Teiler 44.1 (16.) 78.4 (12.) 95.2 (20.)
 Trefferlage 0.04 mm links, 1.03 mm hoch
 Streuwert 1.67, horizontal: 1.75, vertikal: 1.59

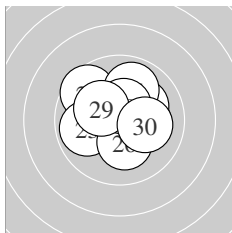

Serie 3:
 10.2 * 9.6 ↖ 9.9 ← 10.1 ↗ 10.6 *
 10.2 * 9.9 ↑ 10.5 * 10.3 * 10.1 →
 beste Teiler 95.1 (25.) 116.7 (28.) 175.0 (29.)
 Trefferlage 0.12 mm rechts, 0.40 mm hoch
 Streuwert 1.58, horizontal: 1.76, vertikal: 1.37

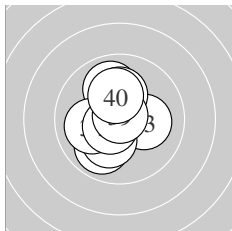

Serie 4:
 9.9 ↑ 10.9 * 10.2 * 9.9 ↙ 10.2 *
 10.2 * 10.0 ← 10.6 * 10.8 * 10.2 *
 beste Teiler 21.3 (32.) 29.2 (39.) 96.2 (38.)
 Trefferlage 0.42 mm links, 0.14 mm hoch
 Streuwert 1.35, horizontal: 1.11, vertikal: 1.55

Unterschrift des Schützen

Meyton Elektronik

Ergebnis: **388** (406.6)
 Serien: 95 98 98 97
 Zähler: 28 12 0 0 0 0 0 0 0 0
 Innenzehner: 22
 weiteste: 455 (32), 395 (29), 352 (7)
 beste Teiler 30.0 (15.) 31.6 (18.) 38.0 (2.)
 Trefferlage 0.41 mm rechts, 0.53 mm hoch
 Streuwert 1.51, horizontal: 1.70, vertikal: 1.30

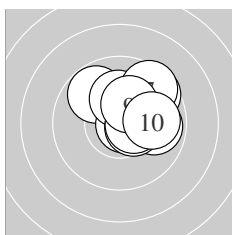
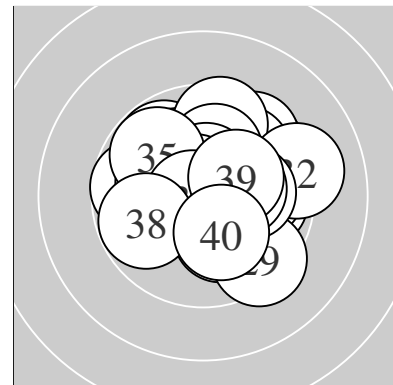

Serie 1:
 9.8 ↘ 10.8 * 9.6 ↗ 9.9 → 10.2 *
 10.5 * 9.5 ↗ 10.5 * 10.3 * 9.9 →
 beste Teiler 38.0 (2.) 111.6 (8.) 113.2 (6.)
 Trefferlage 1.14 mm rechts, 0.99 mm hoch
 Streuwert 1.34, horizontal: 1.45, vertikal: 1.22

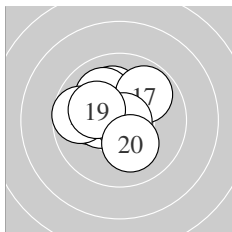

Serie 2:
 10.0 ← 10.4 * 10.1 ↑ 10.0 ↘ 10.8 *
 9.7 ← 9.8 ↗ 10.8 * 10.2 * 10.2 *
 beste Teiler 30.0 (15.) 31.6 (18.) 144.0 (12.)
 Trefferlage 0.73 mm links, 0.58 mm hoch
 Streuwert 1.36, horizontal: 1.52, vertikal: 1.18

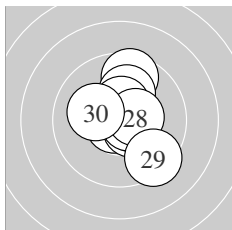

Serie 3:
 10.7 * 9.6 ↑ 10.5 * 10.6 * 10.6 *
 10.1 ↑ 10.5 * 10.4 * 9.4 ↘ 10.2 *
 beste Teiler 54.8 (21.) 77.1 (25.) 100.8 (24.)
 Trefferlage 0.57 mm rechts, 0.31 mm hoch
 Streuwert 1.46, horizontal: 1.17, vertikal: 1.70

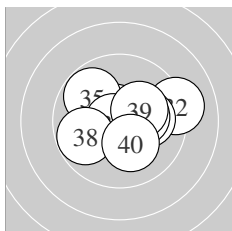

Serie 4:
 10.1 → 9.1 → 10.6 * 10.1 → 9.8 ↘
 10.8 * 10.3 * 9.8 ← 10.2 * 10.2 *
 beste Teiler 50.9 (36.) 76.6 (33.) 172.1 (37.)
 Trefferlage 0.69 mm rechts, 0.23 mm hoch
 Streuwert 1.70, horizontal: 2.15, vertikal: 1.07

Unterschrift des Schützen

Ergebnis: **380** (395.9)
 Serien: 95 98 95 92
 Zähler: 20 20 0 0 0 0 0 0 0 0
 Innenzehner: 14
 weiteste: 488 (10), 487 (33), 475 (34)
 beste Teiler 31.0 (27.) 70.8 (30.) 73.1 (2.)
 Trefferlage 0.30 mm rechts, 0.77 mm hoch
 Streuwert 2.01, horizontal: 2.42, vertikal: 1.49

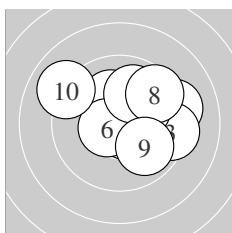
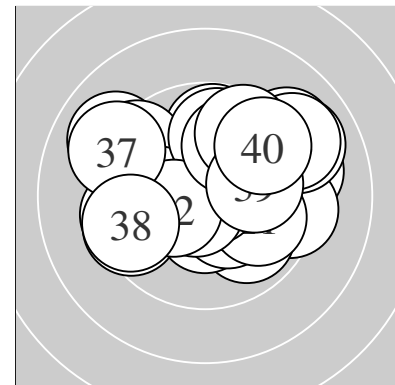

Serie 1:
 9.2 → 10.7 * 9.4 → 10.2 * 10.1 ↗
 10.5 * 10.0 ↑ 9.5 ↘ 9.9 ↘ 9.0 ↘
 beste Teiler 73.1 (2.) 102.1 (6.) 199.3 (4.)
 Trefferlage 1.01 mm rechts, 0.79 mm hoch
 Streuwert 2.07, horizontal: 2.50, vertikal: 1.52

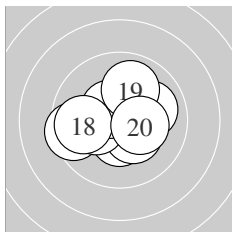

Serie 2:
 10.4 * 10.3 * 9.5 ← 10.0 → 10.6 *
 10.2 * 10.5 * 9.8 ← 10.0 ↑ 10.3 *
 beste Teiler 81.9 (15.) 113.2 (17.) 133.0 (11.)
 Trefferlage 0.28 mm links, 0.02 mm hoch
 Streuwert 1.57, horizontal: 1.91, vertikal: 1.14

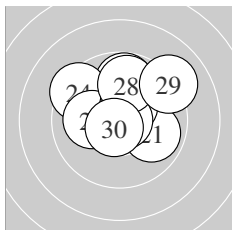

Serie 3:
 9.9 ↘ 9.8 ↑ 10.3 * 9.4 ↘ 10.1 ←
 10.4 * 10.8 * 9.8 ↑ 9.1 ↗ 10.7 *
 beste Teiler 31.0 (27.) 70.8 (30.) 132.6 (26.)
 Trefferlage 0.10 mm rechts, 1.09 mm hoch
 Streuwert 1.79, horizontal: 2.06, vertikal: 1.48

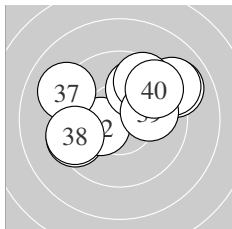

Serie 4:
 9.5 ← 10.3 * 9.0 ↗ 9.1 ↗ 9.9 ↑
 9.6 ↗ 9.1 ↘ 9.5 ← 10.0 → 9.5 ↗
 beste Teiler 155.8 (32.) 236.4 (39.) 260.2 (35.)
 Trefferlage 0.37 mm rechts, 1.18 mm hoch
 Streuwert 2.56, horizontal: 3.20, vertikal: 1.70

Unterschrift des Schützen

Ergebnis: **389** (406.7)
 Serien: 97 98 97 97
 Zähler: 29 11 0 0 0 0 0 0 0 0
 Innenzehner: 26
 weiteste: 456 (31), 397 (34), 388 (5)
 beste Teiler 53.0 (11.) 64.6 (25.) 80.0 (32.)
 Trefferlage 0.49 mm rechts, 0.00 mm
 Streuwert 1.53, horizontal: 1.89, vertikal: 1.04

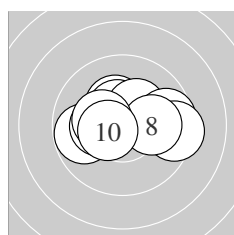
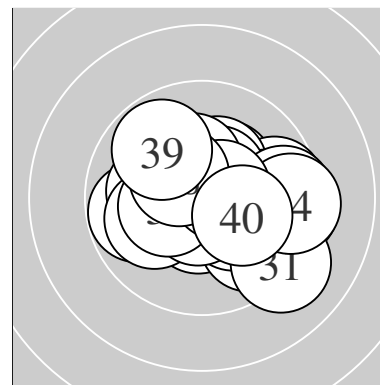

Serie 1:
 10.3 * 10.5 * 10.3 * 9.6 → 9.4 →
 9.8 ← 10.3 * 10.1 → 10.3 * 10.5 *
 beste Teiler 117.6 (10.) 121.4 (2.) 158.8 (9.)
 Trefferlage 0.21 mm rechts, 0.32 mm hoch
 Streuwert 1.69, horizontal: 2.26, vertikal: 0.76

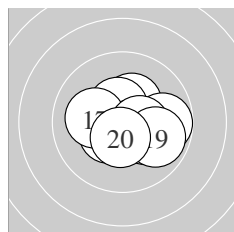

Serie 2:
 10.7 * 10.3 * 10.5 * 10.2 * 10.4 *
 9.8 → 10.1 ← 10.4 * 9.9 ↘ 10.5 *
 beste Teiler 53.0 (11.) 115.2 (20.) 115.7 (13.)
 Trefferlage 0.59 mm rechts, 0.18 mm tief
 Streuwert 1.27, horizontal: 1.56, vertikal: 0.89

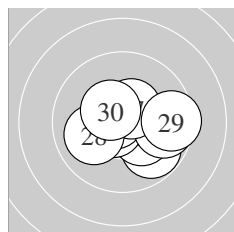

Serie 3:
 10.4 * 9.8 ↘ 10.3 * 10.6 * 10.7 *
 9.7 → 10.5 * 10.0 ← 9.5 → 10.4 *
 beste Teiler 64.6 (25.) 81.4 (24.) 118.4 (27.)
 Trefferlage 0.79 mm rechts, 0.29 mm tief
 Streuwert 1.46, horizontal: 1.87, vertikal: 0.89

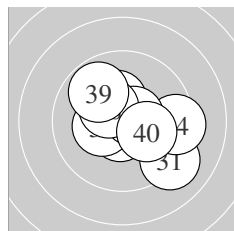

Serie 4:
 9.1 ↘ 10.6 * 10.2 * 9.4 → 10.3 *
 10.3 * 10.6 * 10.4 * 9.8 ↘ 10.2 *
 beste Teiler 80.0 (32.) 90.0 (37.) 142.1 (38.)
 Trefferlage 0.39 mm rechts, 0.15 mm hoch
 Streuwert 1.81, horizontal: 2.08, vertikal: 1.50

Unterschrift des Schützen

Meyton Elektronik

Ergebnis: **383** (401.3)
 Serien: 97 94 97 95
 Zähler: 25 13 2 0 0 0 0 0 0 0
 Innenzehner: 19
 weiteste: 539 (35), 506 (18), 456 (39)
 beste Teiler 63.6 (25.) 88.5 (7.) 101.2 (3.)
 Trefferlage 0.72 mm rechts, 0.14 mm tief
 Streuwert 1.77, horizontal: 2.01, vertikal: 1.49

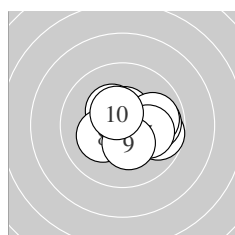
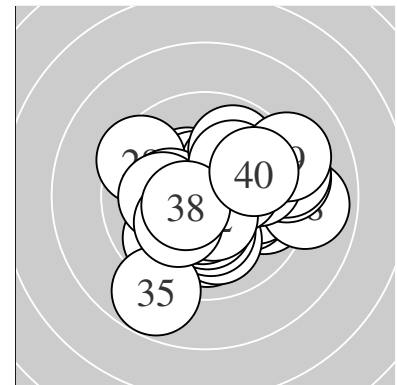

Serie 1:
 9.7 → 9.9 → 10.5 * 9.9 → 10.1 →
 10.4 * 10.6 * 10.2 * 10.3 * 10.5 *
 beste Teiler 88.5 (7.) 101.2 (3.) 114.4 (10.)
 Trefferlage 0.75 mm rechts, 0.04 mm tief
 Streuwert 1.37, horizontal: 1.69, vertikal: 0.95

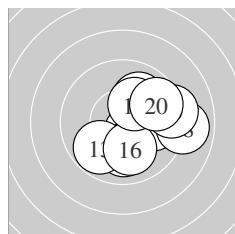

Serie 2:
 10.5 * 10.0 ↓ 9.8 ↙ 9.9 → 10.0 ↗
 10.0 ↓ 10.2 * 8.9 → 9.3 → 9.7 →
 beste Teiler 104.7 (11.) 181.9 (17.) 230.4 (16.)
 Trefferlage 1.64 mm rechts, 0.21 mm tief
 Streuwert 1.86, horizontal: 2.04, vertikal: 1.65

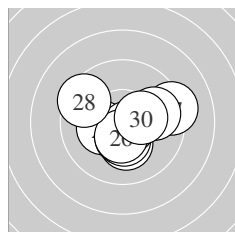

Serie 3:
 10.3 * 10.2 * 10.4 * 10.4 * 10.7 *
 10.5 * 9.3 → 9.5 ↖ 9.9 → 10.3 *
 beste Teiler 63.6 (25.) 120.5 (26.) 133.3 (23.)
 Trefferlage 0.40 mm rechts, 0.27 mm tief
 Streuwert 1.69, horizontal: 2.06, vertikal: 1.23

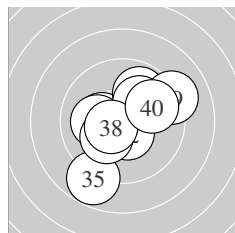

Serie 4:
 10.3 * 10.5 * 10.1 ← 9.9 ↗ 8.8 ↙
 10.1 ↗ 10.2 * 10.5 * 9.1 → 9.9 →
 beste Teiler 108.6 (38.) 111.2 (32.) 175.6 (31.)
 Trefferlage 0.11 mm rechts, 0.04 mm tief
 Streuwert 2.15, horizontal: 2.20, vertikal: 2.09

Unterschrift des Schützen

Meyton Elektronik

Ergebnis: **384** (400.7)
 Serien: 98 97 95 94
 Zähler: 26 12 2 0 0 0 0 0 0 0
 Innenzehner: 16
 weiteste: 520 (28), 518 (31), 460 (20)
 beste Teiler 55.2 (2.) 66.0 (13.) 72.1 (38.)
 Trefferlage 0.14 mm links, 0.66 mm hoch
 Streuwert 1.81, horizontal: 2.18, vertikal: 1.34

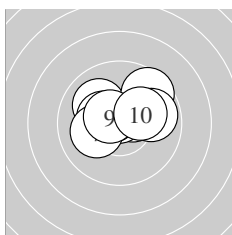
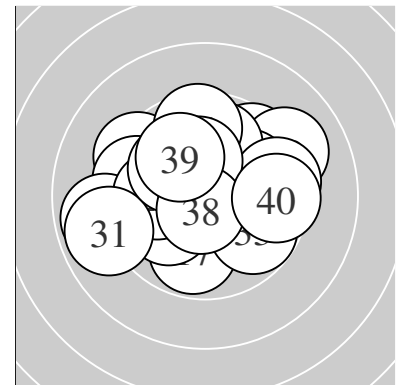

Serie 1:
 10.4 * 10.7 * 10.6 * 10.0 ↘ 10.4 *
 9.6 ↗ 10.1 ← 9.9 → 10.6 * 10.2 *
 beste Teiler 55.2 (2.) 89.0 (3.) 98.4 (9.)
 Trefferlage 0.13 mm rechts, 0.76 mm hoch
 Streuwert 1.34, horizontal: 1.72, vertikal: 0.80

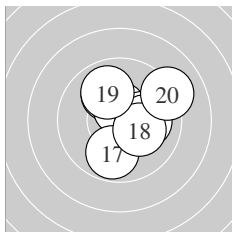

Serie 2:
 10.5 * 10.0 ↖ 10.7 * 10.6 * 10.2 *
 10.1 → 9.8 ↓ 10.2 * 9.9 ↖ 9.1 ↗
 beste Teiler 66.0 (13.) 97.0 (14.) 102.0 (11.)
 Trefferlage 0.87 mm rechts, 0.42 mm hoch
 Streuwert 1.59, horizontal: 1.61, vertikal: 1.58

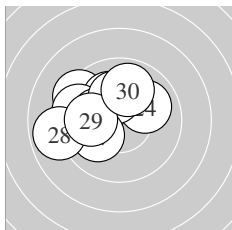

Serie 3:
 9.4 ↘ 10.1 ↖ 9.5 ← 10.0 ↗ 10.2 *
 10.2 * 10.1 ↙ 8.9 ← 10.0 ← 9.9 ↑
 beste Teiler 190.6 (25.) 195.5 (26.) 207.0 (22.)
 Trefferlage 1.65 mm links, 0.83 mm hoch
 Streuwert 1.77, horizontal: 2.13, vertikal: 1.32

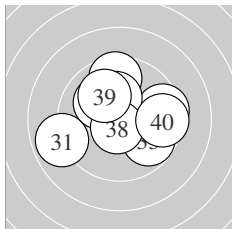

Serie 4:
 8.9 ← 9.5 → 9.8 ↘ 9.6 ↑ 10.1 ↖
 10.5 * 10.2 * 10.7 * 10.0 ↖ 9.5 →
 beste Teiler 72.1 (38.) 125.7 (36.) 181.4 (37.)
 Trefferlage 0.04 mm rechts, 0.61 mm hoch
 Streuwert 2.19, horizontal: 2.60, vertikal: 1.68

Unterschrift des Schützen

Meyton Elektronik

Ergebnis: **380** (397.9)
 Serien: 93 98 95 94
 Zähler: 21 18 1 0 0 0 0 0 0 0
 Innenzehner: 14
 weiteste: 612 (26), 482 (2), 471 (1)
 beste Teiler 51.9 (11.) 59.6 (38.) 75.9 (9.)
 Trefferlage 0.16 mm links, 0.08 mm hoch
 Streuwert 2.00, horizontal: 2.32, vertikal: 1.62

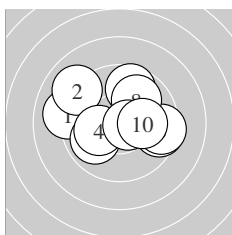
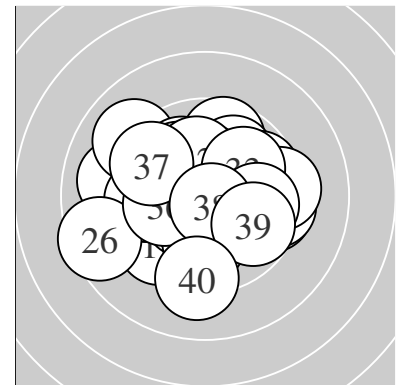

Serie 1:
 9.1 ← 9.0 ↘ 9.9 ↙ 10.2 * 9.5 →
 9.4 → 9.7 ↑ 9.9 ↗ 10.7 * 10.1 →
 beste Teiler 75.9 (9.) 196.0 (4.) 205.0 (10.)
 Trefferlage 0.00 mm , 0.53 mm hoch
 Streuwert 2.39, horizontal: 2.96, vertikal: 1.62

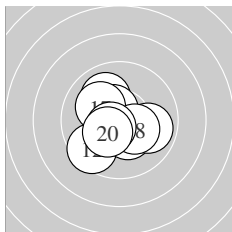

Serie 2:
 10.7 * 9.5 ↙ 10.4 * 10.0 ↘ 10.5 *
 9.9 → 10.1 ↘ 10.3 * 10.6 * 10.3 *
 beste Teiler 51.9 (11.) 100.2 (19.) 110.4 (15.)
 Trefferlage 0.33 mm links, 0.34 mm tief
 Streuwert 1.43, horizontal: 1.51, vertikal: 1.35

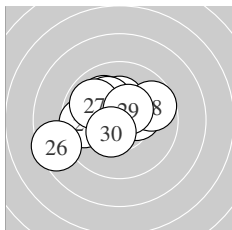

Serie 3:
 9.7 ← 10.3 * 10.1 ↘ 10.3 * 10.2 *
 8.5 ← 9.9 ↘ 9.7 → 10.5 * 10.4 *
 beste Teiler 123.0 (29.) 131.0 (30.) 154.8 (22.)
 Trefferlage 0.92 mm links, 0.55 mm hoch
 Streuwert 1.98, horizontal: 2.44, vertikal: 1.37

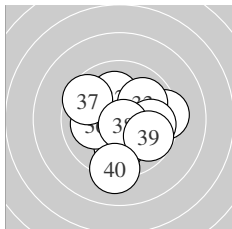

Serie 4:
 9.3 → 10.1 ↑ 9.9 ↗ 9.8 → 10.0 ↓
 10.1 ← 9.6 ↘ 10.7 * 9.8 ↘ 9.2 ↓
 beste Teiler 59.6 (38.) 208.1 (32.) 221.4 (36.)
 Trefferlage 0.58 mm rechts, 0.42 mm tief
 Streuwert 2.13, horizontal: 2.24, vertikal: 2.01

Unterschrift des Schützen

Meyton Elektronik

Ergebnis: **384** (403.0)
 Serien: 98 95 94 97
 Zähler: 26 12 2 0 0 0 0 0 0 0
 Innenzehner: 20
 weiteste: 521 (19), 506 (29), 427 (27)
 beste Teiler 42.4 (40.) 45.6 (21.) 60.6 (12.)
 Trefferlage 0.06 mm links, 0.26 mm hoch
 Streuwert 1.79, horizontal: 2.01, vertikal: 1.53

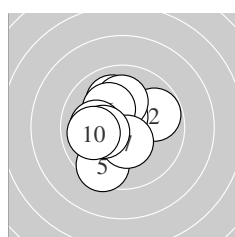
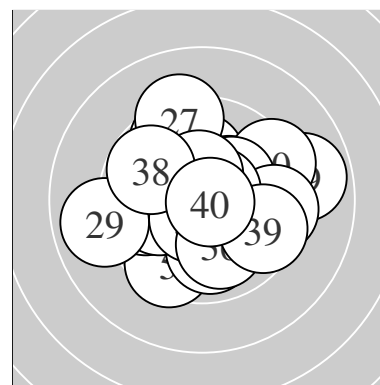

Serie 1:
 10.0 ↖ 9.8 ↗ 10.6 * 10.1 ↑ 9.5 ↘
 10.2 * 10.4 * 10.1 ← 10.3 * 10.0 ←
 beste Teiler 86.7 (3.) 128.1 (7.) 169.7 (9.)
 Trefferlage 0.72 mm links, 0.24 mm hoch
 Streuwert 1.60, horizontal: 1.52, vertikal: 1.67

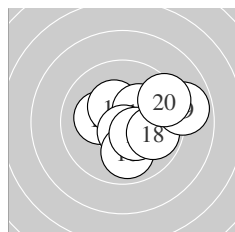

Serie 2:
 10.2 * 10.7 * 10.4 * 10.3 * 10.6 *
 9.9 ↓ 10.4 * 9.9 ↘ 8.9 → 9.4 ↗
 beste Teiler 60.6 (12.) 80.6 (15.) 147.9 (17.)
 Trefferlage 1.20 mm rechts, 0.01 mm hoch
 Streuwert 1.74, horizontal: 2.05, vertikal: 1.36

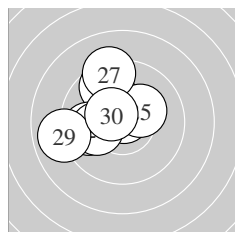

Serie 3:
 10.8 * 9.9 ↖ 10.5 * 9.6 ↖ 10.2 *
 9.8 ← 9.2 ↖ 10.1 ← 8.9 ← 10.5 *
 beste Teiler 45.6 (21.) 115.6 (30.) 118.0 (23.)
 Trefferlage 1.30 mm links, 1.04 mm hoch
 Streuwert 1.73, horizontal: 1.77, vertikal: 1.68

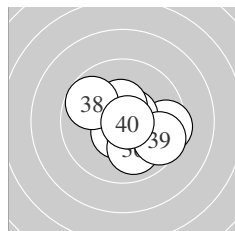

Serie 4:
 10.4 * 10.2 * 10.5 * 9.5 → 10.6 *
 10.0 ↓ 10.4 * 9.8 ↖ 9.6 ↘ 10.8 *
 beste Teiler 42.4 (40.) 86.0 (35.) 103.7 (33.)
 Trefferlage 0.56 mm rechts, 0.24 mm tief
 Streuwert 1.60, horizontal: 1.85, vertikal: 1.29

Unterschrift des Schützen

Meyton Elektronik

Ergebnis: **390** (405.4)
 Serien: 99 98 96 97
 Zähler: 30 10 0 0 0 0 0 0 0 0
 Innenzehner: 23
 weiteste: 395 (39), 391 (33), 378 (23)
 beste Teiler 54.2 (34.) 64.7 (14.) 67.2 (24.)
 Trefferlage 0.09 mm links, 0.06 mm tief
 Streuwert 1.61, horizontal: 1.78, vertikal: 1.42

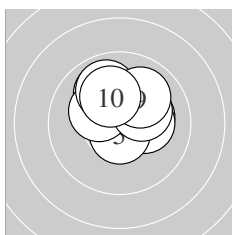
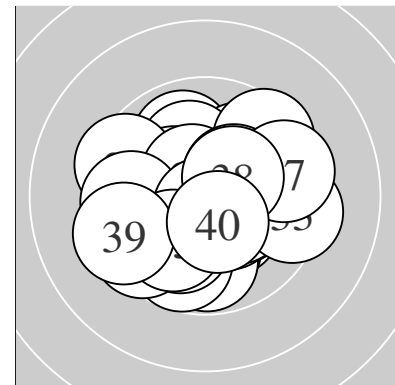

Serie 1:
 10.2 * 10.3 * 10.2 * 10.0 ↖ 10.6 *
 10.3 * 9.9 ↖ 10.2 * 10.0 ↗ 10.1 ↖
 beste Teiler 76.0 (5.) 169.8 (2.) 175.2 (6.)
 Trefferlage 0.10 mm rechts, 1.09 mm hoch
 Streuwert 1.24, horizontal: 1.43, vertikal: 1.02

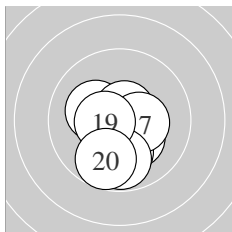

Serie 2:
 10.3 * 10.2 * 10.7 * 10.7 * 10.7 *
 10.0 ↓ 10.4 * 9.8 ↓ 10.5 * 9.7 ↓
 beste Teiler 64.7 (14.) 68.7 (15.) 73.8 (13.)
 Trefferlage 0.12 mm links, 0.94 mm tief
 Streuwert 1.18, horizontal: 0.99, vertikal: 1.34

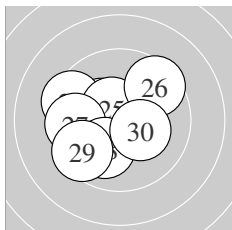

Serie 3:
 10.0 ← 10.3 * 9.4 ↖ 10.7 * 10.5 *
 9.5 ↗ 9.6 ← 10.0 ↓ 9.5 ↘ 10.3 *
 beste Teiler 67.2 (24.) 108.7 (25.) 160.1 (22.)
 Trefferlage 1.12 mm links, 0.07 mm hoch
 Streuwert 1.76, horizontal: 2.00, vertikal: 1.48

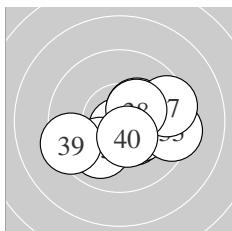

Serie 4:
 10.4 * 10.3 * 9.4 → 10.7 * 10.0 ↘
 10.3 * 9.5 → 10.4 * 9.4 ← 10.4 *
 beste Teiler 54.2 (34.) 127.9 (40.) 143.5 (31.)
 Trefferlage 0.77 mm rechts, 0.49 mm tief
 Streuwert 1.71, horizontal: 2.17, vertikal: 1.09

Unterschrift des Schützen

Meyton Elektronik

Ergebnis: **390** (409.2)
 Serien: 95 100 98 97
 Zähler: 30 10 0 0 0 0 0 0 0 0
 Innenzehner: 25
 weiteste: 452 (25), 420 (35), 380 (5)
 beste Teiler 8.4 (13.) 31.0 (18.) 35.2 (19.)
 Trefferlage 0.31 mm links, 0.23 mm hoch
 Streuwert 1.51, horizontal: 1.86, vertikal: 1.03

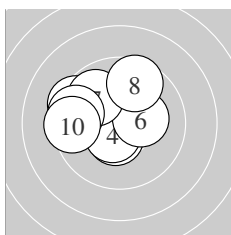
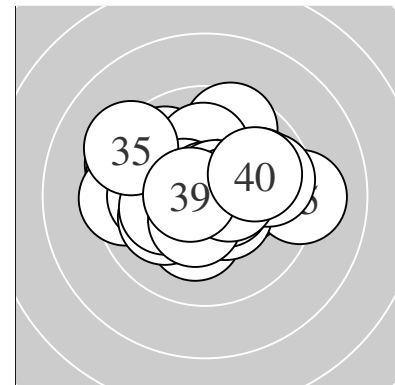

Serie 1:
 10.0 ↘ 10.2 * 10.5 * 10.5 * 9.4 ↘
 10.3 * 9.8 ↘ 9.6 ↑ 9.5 ← 9.4 ←
 beste Teiler 104.6 (4.) 116.4 (3.) 171.8 (6.)
 Trefferlage 1.46 mm links, 0.71 mm hoch
 Streuwert 1.65, horizontal: 1.93, vertikal: 1.30

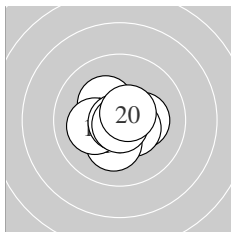

Serie 2:
 10.3 * 10.6 * 10.9 * 10.3 * 10.5 *
 10.2 * 10.1 ← 10.8 * 10.8 * 10.6 *
 beste Teiler 8.4 (13.) 31.0 (18.) 35.2 (19.)
 Trefferlage 0.09 mm links, 0.22 mm tief
 Streuwert 0.94, horizontal: 1.07, vertikal: 0.80

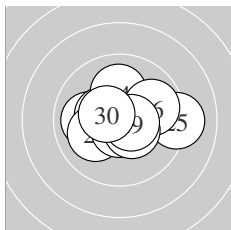

Serie 3:
 10.0 ← 10.4 * 10.1 ↙ 10.1 ↑ 9.1 →
 9.9 → 10.7 * 10.4 * 10.6 * 10.5 *
 beste Teiler 72.2 (27.) 94.3 (29.) 113.6 (30.)
 Trefferlage 0.20 mm rechts, 0.12 mm hoch
 Streuwert 1.65, horizontal: 2.12, vertikal: 0.96

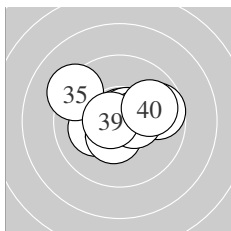

Serie 4:
 10.8 * 10.7 * 10.2 * 9.7 → 9.3 ↘
 10.8 * 10.5 * 10.5 * 10.7 * 9.9 →
 beste Teiler 37.0 (31.) 39.5 (36.) 68.4 (32.)
 Trefferlage 0.09 mm rechts, 0.31 mm hoch
 Streuwert 1.51, horizontal: 1.91, vertikal: 0.93

Unterschrift des Schützen

Ergebnis: **386** (404.0)
 Serien: 98 96 97 95
 Zähler: 28 10 2 0 0 0 0 0 0 0
 Innenzehner: 24
 weiteste: 665 (39), 638 (19), 431 (32)
 beste Teiler 47.5 (40.) 50.6 (4.) 68.9 (14.)
 Trefferlage 0.36 mm rechts, 0.43 mm hoch
 Streuwert 1.79, horizontal: 1.94, vertikal: 1.63

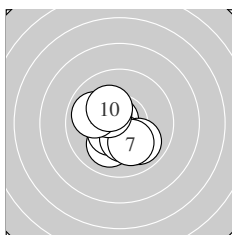
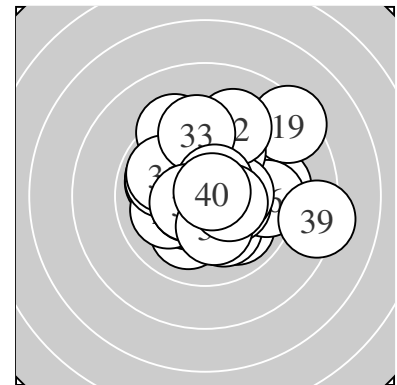

Serie 1:
 10.3 * 10.1 ↙ 10.5 * 10.8 * 9.9 ↘
 10.3 * 10.1 ↘ 10.4 * 9.9 ↖ 10.3 *
 beste Teiler 50.6 (4.) 125.8 (3.) 136.6 (8.)
 Trefferlage 0.30 mm links, 0.61 mm tief
 Streuwert 1.29, horizontal: 1.24, vertikal: 1.33

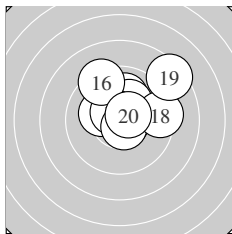

Serie 2:
 10.0 ↑ 10.2 * 10.2 * 10.7 * 10.6 *
 9.3 ↘ 10.6 * 9.4 → 8.4 ↗ 10.6 *
 beste Teiler 68.9 (14.) 76.5 (17.) 98.7 (20.)
 Trefferlage 0.79 mm rechts, 1.35 mm hoch
 Streuwert 1.90, horizontal: 2.15, vertikal: 1.61

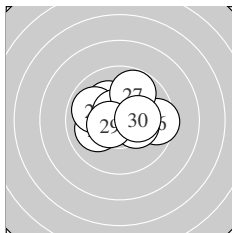

Serie 3:
 10.0 ← 10.2 * 9.9 ↖ 10.3 * 10.6 *
 9.5 → 9.8 ↑ 10.3 * 10.5 * 10.2 *
 beste Teiler 82.8 (25.) 105.1 (29.) 152.3 (24.)
 Trefferlage 0.25 mm rechts, 0.48 mm hoch
 Streuwert 1.56, horizontal: 1.94, vertikal: 1.06

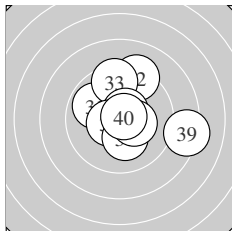

Serie 4:
 9.9 ↖ 9.2 ↑ 9.5 ↑ 10.7 * 10.6 *
 10.5 * 10.2 * 10.4 * 8.3 → 10.8 *
 beste Teiler 47.5 (40.) 72.9 (34.) 93.6 (35.)
 Trefferlage 0.71 mm rechts, 0.52 mm hoch
 Streuwert 2.16, horizontal: 2.35, vertikal: 1.96

Unterschrift des Schützen

Meyton Elektronik

Ergebnis: **379** (399.2)
 Serien: 91 96 95 97
 Zähler: 21 18 0 1 0 0 0 0 0 0
 Innenzehner: 15
 weiteste: 822 (7), 411 (10), 405 (8)
 beste Teiler 20.2 (38.) 35.1 (16.) 46.0 (32.)
 Trefferlage 1.01 mm links, 0.11 mm hoch
 Streuwert 1.86, horizontal: 1.88, vertikal: 1.85

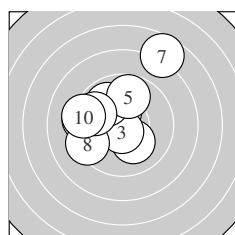
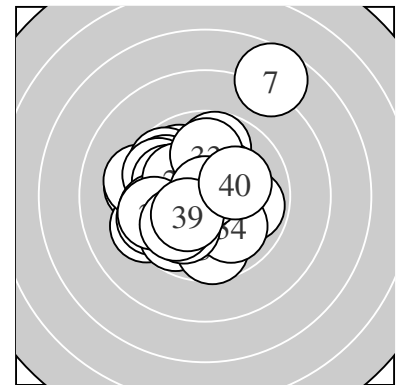

Serie 1:
 10.1 ↘ 10.4 * 10.7 * 9.9 ↖ 9.8 ↑
 9.3 ← 7.7 ↗ 9.3 ← 9.7 ↖ 9.3 ←
 beste Teiler 66.4 (3.) 143.7 (2.) 202.7 (1.)
 Trefferlage 1.06 mm links, 1.20 mm hoch
 Streuwert 2.62, horizontal: 2.63, vertikal: 2.60

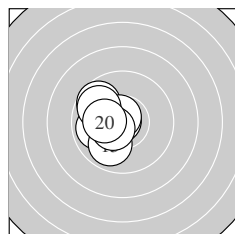

Serie 2:
 10.3 * 10.3 * 9.9 ← 9.7 ↖ 9.9 ↙
 10.8 * 10.7 * 9.8 ↖ 10.5 * 10.2 *
 beste Teiler 35.1 (16.) 64.1 (17.) 117.5 (19.)
 Trefferlage 1.55 mm links, 0.18 mm hoch
 Streuwert 1.01, horizontal: 0.82, vertikal: 1.17

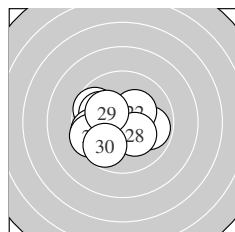

Serie 3:
 9.9 → 10.3 * 9.7 ↖ 10.2 * 10.0 ↖
 9.7 ← 9.6 ← 10.2 * 10.2 * 9.8 ↙
 beste Teiler 165.8 (22.) 176.7 (28.) 186.7 (24.)
 Trefferlage 1.14 mm links, 0.17 mm tief
 Streuwert 1.74, horizontal: 2.09, vertikal: 1.29

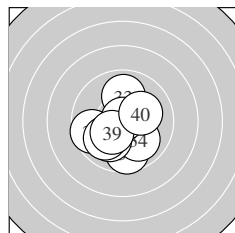

Serie 4:
 9.7 ↓ 10.8 * 9.9 ↑ 10.0 ↘ 9.6 ←
 10.0 ↙ 10.0 ↙ 10.9 * 10.3 * 10.1 →
 beste Teiler 20.2 (38.) 46.0 (32.) 159.1 (39.)
 Trefferlage 0.28 mm links, 0.74 mm tief
 Streuwert 1.60, horizontal: 1.55, vertikal: 1.65

Unterschrift des Schützen

Meyton Elektronik

Ergebnis: **390** (408.6)
 Serien: 97 98 97 98
 Zähler: 30 10 0 0 0 0 0 0 0 0
 Innenzehner: 27
 weiteste: 444 (30), 438 (26), 418 (16)
 beste Teiler 53.5 (12.) 56.5 (39.) 66.4 (34.)
 Trefferlage 0.35 mm links, 0.33 mm hoch
 Streuwert 1.46, horizontal: 1.71, vertikal: 1.18

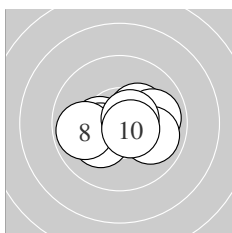
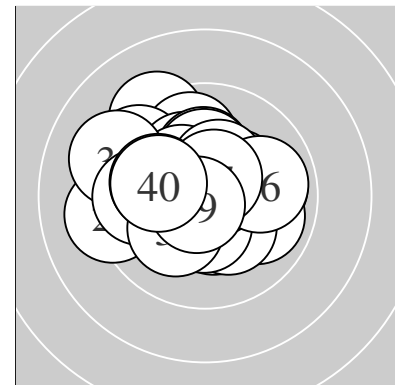

Serie 1:
 10.3 * 10.3 * 9.9 → 10.3 * 10.6 *
 10.2 * 9.9 ↘ 9.9 ← 10.6 * 10.6 *
 beste Teiler 78.6 (5.) 88.2 (9.) 96.6 (10.)
 Trefferlage 0.16 mm rechts, 0.24 mm tief
 Streuwert 1.36, horizontal: 1.82, vertikal: 0.64

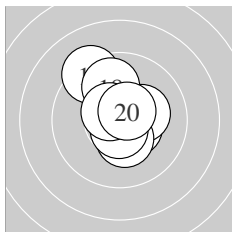

Serie 2:
 10.5 * 10.7 * 10.2 * 10.4 * 10.3 *
 9.3 ↘ 10.7 * 9.9 ↑ 10.6 * 10.6 *
 beste Teiler 53.5 (12.) 73.1 (17.) 90.2 (20.)
 Trefferlage 0.02 mm links, 0.71 mm hoch
 Streuwert 1.32, horizontal: 1.10, vertikal: 1.50

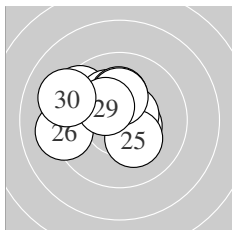

Serie 3:
 10.5 * 9.5 ↘ 10.6 * 10.2 * 10.2 *
 9.2 ← 10.2 * 10.2 * 10.3 * 9.2 ↖
 beste Teiler 89.8 (23.) 114.2 (21.) 152.0 (29.)
 Trefferlage 1.06 mm links, 0.78 mm hoch
 Streuwert 1.71, horizontal: 2.06, vertikal: 1.28

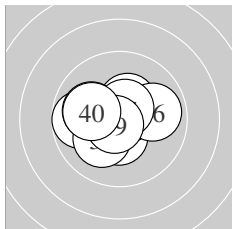

Serie 4:
 10.4 * 10.4 * 9.8 ← 10.7 * 10.0 ↖
 9.9 → 10.6 * 10.1 ↗ 10.7 * 10.1 ↖
 beste Teiler 56.5 (39.) 66.4 (34.) 93.4 (37.)
 Trefferlage 0.50 mm links, 0.10 mm hoch
 Streuwert 1.36, horizontal: 1.68, vertikal: 0.92

Unterschrift des Schützen

Meyton Elektronik

Ergebnis: **381** (399.9)
 Serien: 97 94 94 96
 Zähler: 22 17 1 0 0 0 0 0 0 0
 Innenzehner: 18
 weiteste: 641 (30), 486 (12), 432 (13)
 beste Teiler 48.7 (28.) 53.2 (39.) 67.1 (14.)
 Trefferlage 0.41 mm rechts, 0.05 mm tief
 Streuwert 1.95, horizontal: 2.00, vertikal: 1.89

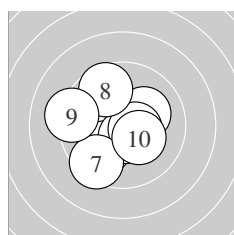
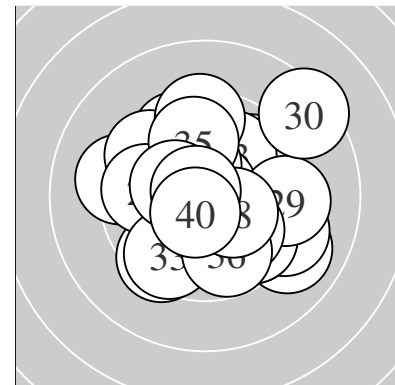

Serie 1:
 10.4 * 10.7 * 10.0 ✓ 10.2 * 10.6 *
 10.5 * 9.5 ✓ 9.6 ↖ 9.2 ← 10.3 *
 beste Teiler 73.5 (2.) 96.5 (5.) 108.8 (6.)
 Trefferlage 0.51 mm links, 0.38 mm tief
 Streuwert 1.78, horizontal: 1.88, vertikal: 1.67

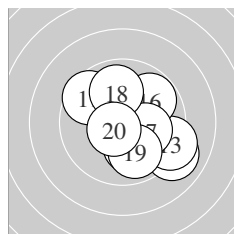

Serie 2:
 9.6 ↘ 9.0 ↘ 9.2 ↘ 10.7 * 10.1 ↓
 9.8 ↗ 10.2 * 9.9 ↑ 9.9 ↓ 10.6 *
 beste Teiler 67.1 (14.) 93.0 (20.) 199.8 (17.)
 Trefferlage 1.01 mm rechts, 0.31 mm tief
 Streuwert 2.03, horizontal: 2.13, vertikal: 1.93

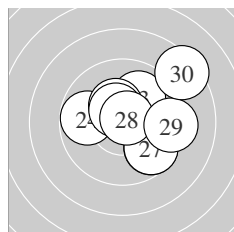

Serie 3:
 10.4 * 9.7 ↘ 10.0 ↗ 9.8 ← 10.4 *
 10.5 * 9.7 ↘ 10.8 * 9.3 → 8.4 ↗
 beste Teiler 48.7 (28.) 114.6 (26.) 148.0 (21.)
 Trefferlage 1.27 mm rechts, 0.48 mm hoch
 Streuwert 2.10, horizontal: 2.32, vertikal: 1.85

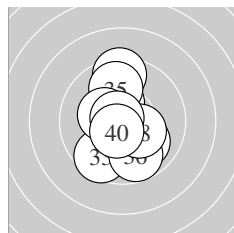

Serie 4:
 9.4 ↑ 10.3 * 9.6 ✓ 10.0 ↘ 9.9 ↑
 9.8 ↓ 10.3 * 10.3 * 10.7 * 10.6 *
 beste Teiler 53.2 (39.) 96.3 (40.) 157.0 (32.)
 Trefferlage 0.13 mm links, 0.01 mm tief
 Streuwert 1.79, horizontal: 1.17, vertikal: 2.24

Unterschrift des Schützen

Meyton Elektronik

Ergebnis: **385** (403.7)
 Serien: 97 96 96 96
 Zähler: 25 15 0 0 0 0 0 0 0 0
 Innenzehner: 17
 weiteste: 419 (25), 416 (10), 373 (1)
 beste Teiler 34.0 (6.) 75.7 (16.) 93.6 (28.)
 Trefferlage 0.04 mm links, 0.29 mm hoch
 Streuwert 1.68, horizontal: 1.51, vertikal: 1.83

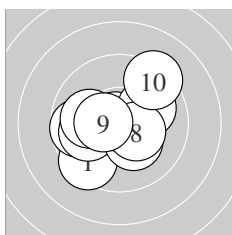
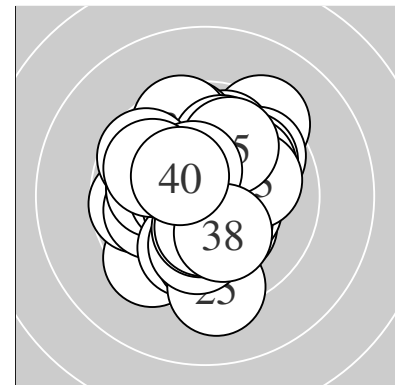

Serie 1:
 9.5 ↙ 9.7 ← 10.0 ← 10.0 ← 10.3 *
 10.8 * 10.0 ↗ 10.4 * 10.5 * 9.3 ↗
 beste Teiler 34.0 (6.) 124.1 (9.) 141.7 (8.)
 Trefferlage 0.48 mm links, 0.08 mm tief
 Streuwert 1.86, horizontal: 2.09, vertikal: 1.60

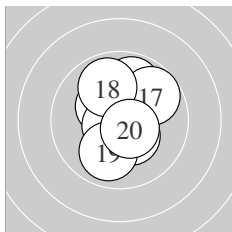

Serie 2:
 10.5 * 10.3 * 10.6 * 10.4 * 9.9 ↗
 10.7 * 9.8 ↗ 9.9 ↘ 9.9 ↓ 10.5 *
 beste Teiler 75.7 (16.) 100.1 (13.) 102.1 (20.)
 Trefferlage 0.28 mm rechts, 0.48 mm hoch
 Streuwert 1.40, horizontal: 1.12, vertikal: 1.63

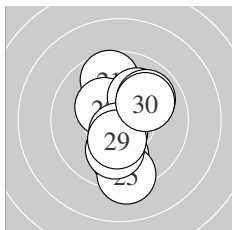

Serie 3:
 9.7 ↑ 10.3 * 10.1 ↗ 9.9 ↓ 9.3 ↓
 9.9 ↗ 10.0 ↓ 10.6 * 10.4 * 10.0 ↗
 beste Teiler 93.6 (28.) 149.3 (29.) 153.9 (22.)
 Trefferlage 0.31 mm rechts, 0.27 mm tief
 Streuwert 1.84, horizontal: 1.10, vertikal: 2.36

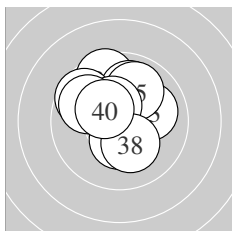

Serie 4:
 9.6 ↖ 10.4 * 10.0 ↗ 10.0 ↑ 9.9 ↗
 9.7 ↖ 10.4 * 10.2 * 9.9 ↖ 10.4 *
 beste Teiler 130.1 (37.) 143.1 (32.) 146.6 (40.)
 Trefferlage 0.30 mm links, 1.06 mm hoch
 Streuwert 1.58, horizontal: 1.57, vertikal: 1.58

Unterschrift des Schützen