

Ergebnis: **387** (407.0)
 Serien: 96 98 97 96
 Zähler: 27 13 0 0 0 0 0 0 0 0
 Innenzehner: 26
 weiteste: 462 (32), 461 (24), 430 (1)
 beste Teiler 52.6 (34.) 60.8 (19.) 62.6 (17.)
 Trefferlage 0.48 mm rechts, 0.33 mm hoch
 Streuwert 1.56, horizontal: 1.90, vertikal: 1.14

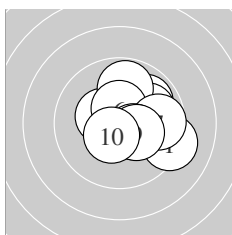

Serie 1:
 9.2 ↘ 9.9 ↗ 10.4 * 10.0 → 9.8 ↑
 10.5 * 9.7 → 10.4 * 10.3 * 10.5 *
 beste Teiler 115.9 (10.) 118.0 (6.) 129.8 (8.)
 Trefferlage 1.22 mm rechts, 0.33 mm hoch
 Streuwert 1.52, horizontal: 1.67, vertikal: 1.35

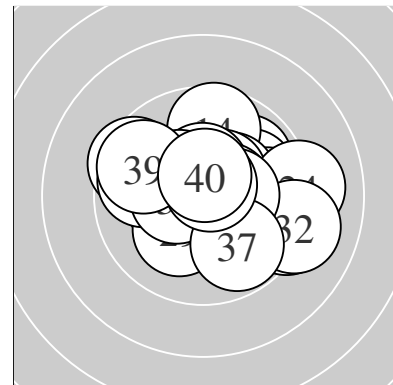
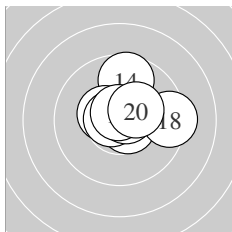

Serie 2:
 10.4 * 10.5 * 10.6 * 9.7 ↑ 10.4 *
 10.7 * 10.7 * 9.4 → 10.7 * 10.3 *
 beste Teiler 60.8 (19.) 62.6 (17.) 66.9 (16.)
 Trefferlage 0.63 mm rechts, 0.70 mm hoch
 Streuwert 1.21, horizontal: 1.39, vertikal: 0.99

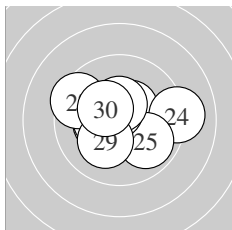

Serie 3:
 10.3 * 10.4 * 10.4 * 9.1 → 9.9 ↘
 10.6 * 9.5 ↖ 10.4 * 10.2 * 10.4 *
 beste Teiler 80.0 (26.) 126.9 (23.) 127.0 (28.)
 Trefferlage 0.14 mm links, 0.22 mm hoch
 Streuwert 1.76, horizontal: 2.22, vertikal: 1.12

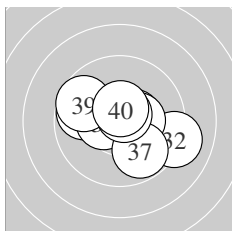

Serie 4:
 10.5 * 9.1 → 9.8 ↖ 10.7 * 10.4 *
 10.4 * 9.8 ↘ 10.7 * 9.7 ↖ 10.6 *
 beste Teiler 52.6 (34.) 63.5 (38.) 99.3 (40.)
 Trefferlage 0.21 mm rechts, 0.06 mm hoch
 Streuwert 1.74, horizontal: 2.18, vertikal: 1.14

Unterschrift des Schützen

Ergebnis: **384** (402.9)
 Serien: 97 96 95 96
 Zähler: 24 16 0 0 0 0 0 0 0 0
 Innenzehner: 20
 weiteste: 404 (24), 392 (2), 361 (21)
 beste Teiler 68.3 (40.) 89.0 (7.) 91.9 (28.)
 Trefferlage 0.15 mm links, 0.47 mm hoch
 Streuwert 1.67, horizontal: 1.99, vertikal: 1.27

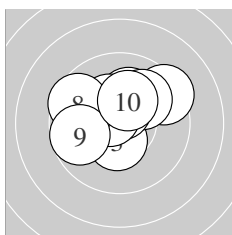
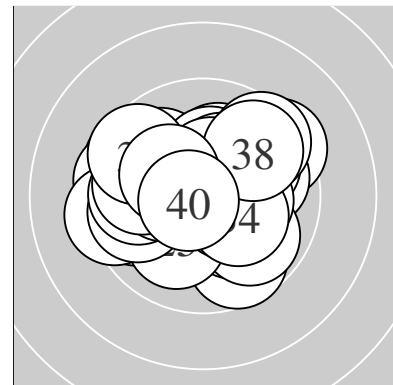

Serie 1:
 10.1 ↗ 9.4 ↗ 10.4 * 10.0 ↗ 10.3 *
 10.6 * 10.6 * 9.6 ↖ 9.7 ← 10.2 *
 beste Teiler 89.0 (7.) 100.6 (6.) 130.2 (3.)
 Trefferlage 0.14 mm links, 0.96 mm hoch
 Streuwert 1.60, horizontal: 1.94, vertikal: 1.18

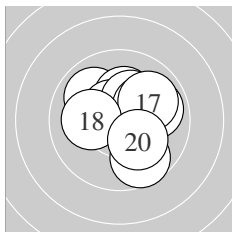

Serie 2:
 9.9 ↘ 10.2 * 10.6 * 10.3 * 10.2 *
 9.9 → 9.9 ↗ 10.1 ← 9.7 ↘ 10.2 *
 beste Teiler 97.0 (13.) 168.8 (14.) 177.9 (12.)
 Trefferlage 0.57 mm rechts, 0.47 mm hoch
 Streuwert 1.56, horizontal: 1.62, vertikal: 1.49

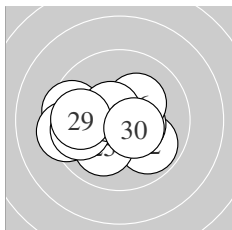

Serie 3:
 9.5 ← 9.9 ↘ 10.5 * 9.3 ← 10.1 ↘
 10.2 * 9.8 ← 10.6 * 9.8 ← 10.5 *
 beste Teiler 91.9 (28.) 122.1 (30.) 124.1 (23.)
 Trefferlage 0.95 mm links, 0.35 mm tief
 Streuwert 1.76, horizontal: 2.27, vertikal: 1.04

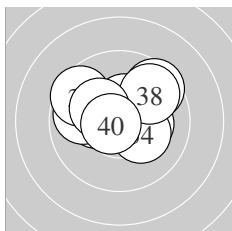

Serie 4:
 10.4 * 10.2 * 9.5 ↗ 10.2 * 10.3 *
 9.9 ← 9.6 ↘ 9.8 ↗ 10.2 * 10.7 *
 beste Teiler 68.3 (40.) 131.7 (31.) 173.2 (35.)
 Trefferlage 0.09 mm links, 0.79 mm hoch
 Streuwert 1.66, horizontal: 2.08, vertikal: 1.09

Unterschrift des Schützen

Meyton Elektronik

Ergebnis: **387** (404.5)
 Serien: 100 95 94 98
 Zähler: 28 11 1 0 0 0 0 0 0 0
 Innenzehner: 23
 weiteste: 542 (28), 444 (14), 437 (18)
 beste Teiler 53.0 (20.) 54.3 (34.) 70.3 (23.)
 Trefferlage 0.82 mm rechts, 0.64 mm hoch
 Streuwert 1.55, horizontal: 1.83, vertikal: 1.21

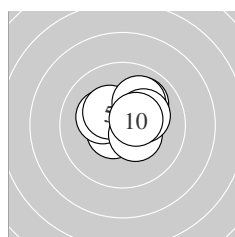
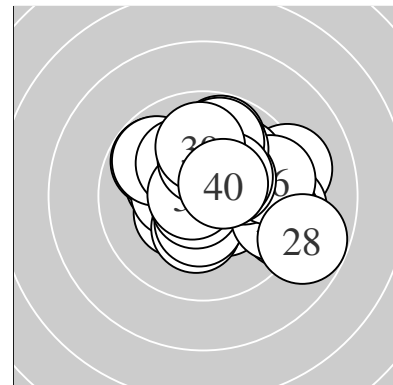

Serie 1:
 10.6 * 10.6 * 10.5 * 10.2 * 10.3 *
 10.0 ↗ 10.0 ↗ 10.4 * 10.2 * 10.5 *
 beste Teiler 94.6 (2.) 99.0 (1.) 106.0 (3.)
 Trefferlage 0.46 mm rechts, 0.68 mm hoch
 Streuwert 1.05, horizontal: 1.21, vertikal: 0.86

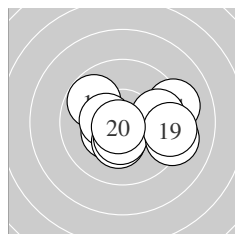

Serie 2:
 10.4 * 9.8 ↘ 10.4 * 9.2 → 9.8 →
 10.3 * 10.4 * 9.2 → 9.4 → 10.7 *
 beste Teiler 53.0 (20.) 130.3 (17.) 138.9 (13.)
 Trefferlage 0.93 mm rechts, 0.23 mm tief
 Streuwert 2.00, horizontal: 2.58, vertikal: 1.15

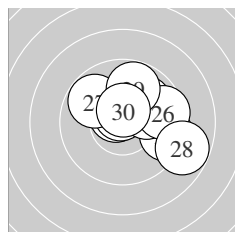

Serie 3:
 10.6 * 9.4 → 10.7 * 10.0 ↗ 10.1 →
 9.6 → 9.8 ↘ 8.8 → 9.8 ↑ 10.6 *
 beste Teiler 70.3 (23.) 79.1 (21.) 100.1 (30.)
 Trefferlage 1.37 mm rechts, 0.68 mm hoch
 Streuwert 1.86, horizontal: 2.23, vertikal: 1.40

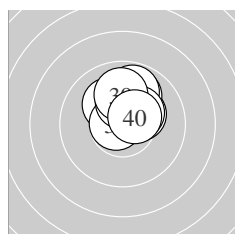

Serie 4:
 10.2 * 10.3 * 10.3 * 10.7 * 10.2 *
 9.9 ↑ 9.8 ↑ 10.3 * 10.0 ↑ 10.5 *
 beste Teiler 54.3 (34.) 117.9 (40.) 157.6 (38.)
 Trefferlage 0.49 mm rechts, 1.43 mm hoch
 Streuwert 0.89, horizontal: 0.89, vertikal: 0.88

Unterschrift des Schützen

Meyton Elektronik

Ergebnis: **394** (410.8)
 Serien: 98 99 99 98
 Zähler: 34 6 0 0 0 0 0 0 0 0
 Innenzehner: 24
 weiteste: 337 (31), 322 (4), 319 (6)
 beste Teiler 42.7 (24.) 65.8 (12.) 70.7 (14.)
 Trefferlage 0.30 mm links, 0.01 mm hoch
 Streuwert 1.33, horizontal: 1.45, vertikal: 1.20

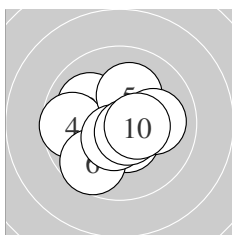
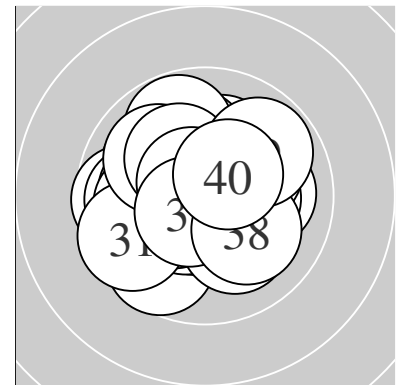

Serie 1:
 10.5 * 10.0 ↖ 10.3 * 9.7 ← 10.2 *
 9.7 ↙ 10.5 * 10.6 * 10.0 → 10.5 *
 beste Teiler 80.8 (8.) 105.1 (7.) 120.5 (1.)
 Trefferlage 0.32 mm links, 0.36 mm tief
 Streuwert 1.49, horizontal: 1.68, vertikal: 1.27

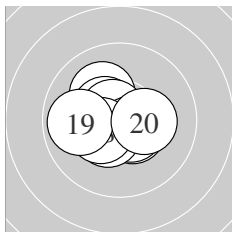

Serie 2:
 10.1 ↖ 10.7 * 10.5 * 10.7 * 10.5 *
 10.6 * 10.5 * 10.4 * 9.9 ← 10.3 *
 beste Teiler 65.8 (12.) 70.7 (14.) 99.0 (16.)
 Trefferlage 0.45 mm links, 0.07 mm tief
 Streuwert 1.07, horizontal: 1.26, vertikal: 0.84

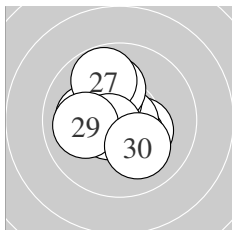

Serie 3:
 10.3 * 10.4 * 10.1 ← 10.8 * 10.3 *
 10.1 ↑ 9.8 ↖ 10.6 * 10.0 ← 10.1 ↘
 beste Teiler 42.7 (24.) 84.0 (28.) 139.0 (22.)
 Trefferlage 0.35 mm links, 0.18 mm hoch
 Streuwert 1.37, horizontal: 1.30, vertikal: 1.43

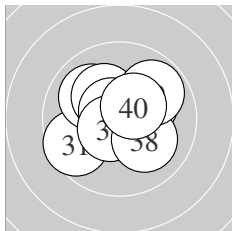

Serie 4:
 9.6 ← 10.1 ↗ 10.0 ↖ 10.7 * 10.2 *
 10.6 * 10.6 * 10.1 ↘ 9.8 ↗ 10.4 *
 beste Teiler 75.6 (34.) 78.4 (36.) 89.8 (37.)
 Trefferlage 0.10 mm links, 0.31 mm hoch
 Streuwert 1.49, horizontal: 1.69, vertikal: 1.26

Unterschrift des Schützen

Meyton Elektronik

| | | |
|--------------|--|-----------------------|
| Ergebnis: | 375 | (392.1) |
| Serien: | 95 | 94 95 91 |
| Zähler: | 19 17 4 | 0 0 0 0 0 0 0 |
| Innenzehner: | 15 | |
| weiteste: | 632 (6), 615 (18), 503 (40) | |
| beste Teiler | 45.6 (17.) | 48.0 (32.) 48.7 (35.) |
| Trefferlage | 0.22 mm rechts, 0.89 mm hoch | |
| Streuwert | 2.30, horizontal: 2.62, vertikal: 1.91 | |

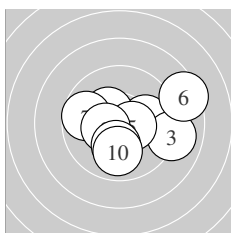
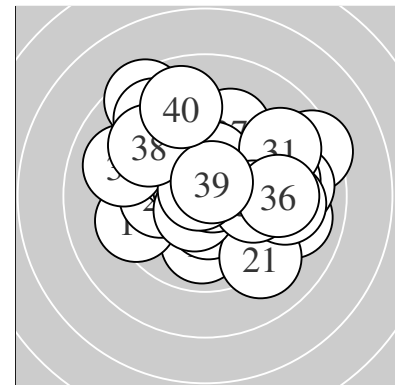

| | | | | | |
|--------------|--|--------|--------|--------|--------|
| Serie 1: | 10.0 → | 10.6 * | 9.0 → | 10.4 * | 10.5 * |
| | 8.4 → | 9.7 ← | 10.4 * | 10.1 ↓ | 9.9 ↓ |
| beste Teiler | 89.0 (2.) 114.9 (5.) 134.7 (8.) | | | | |
| Trefferlage | 0.73 mm rechts, 0.15 mm tief | | | | |
| Streuwert | 2.24, horizontal: 2.80, vertikal: 1.47 | | | | |

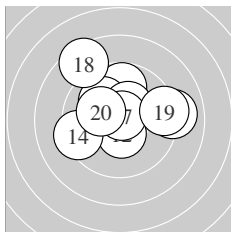

| | | | | | |
|--------------|--|--------|-------|-------|--------|
| Serie 2: | 9.8 ↑ | 10.5 * | 9.0 → | 9.4 ← | 10.0 ↖ |
| | 10.4 * | 10.8 * | 8.5 ↘ | 9.3 → | 10.2 * |
| beste Teiler | 45.6 (17.) 123.3 (12.) 149.3 (16.) | | | | |
| Trefferlage | 0.00 mm , 1.12 mm hoch | | | | |
| Streuwert | 2.40, horizontal: 2.80, vertikal: 1.92 | | | | |

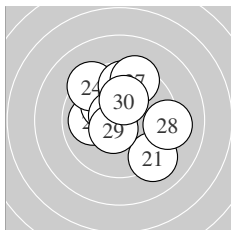

| | | | | | |
|--------------|--|--------|--------|--------|--------|
| Serie 3: | 9.1 ↘ | 10.0 ← | 10.2 * | 9.4 ↘ | 10.7 * |
| | 9.7 ↑ | 9.4 ↑ | 9.2 → | 10.6 * | 10.2 * |
| beste Teiler | 71.8 (25.) 97.4 (29.) 185.9 (30.) | | | | |
| Trefferlage | 0.20 mm rechts, 0.88 mm hoch | | | | |
| Streuwert | 2.20, horizontal: 2.23, vertikal: 2.16 | | | | |

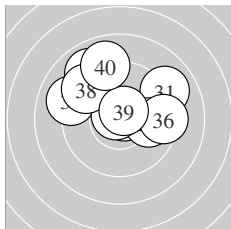

| | | | | | |
|--------------|--|--------|-------|--------|--------|
| Serie 4: | 9.0 → | 10.8 * | 9.9 → | 9.1 ↖ | 10.8 * |
| | 9.4 → | 8.9 ↘ | 9.3 ↘ | 10.6 * | 8.9 ↑ |
| beste Teiler | 48.0 (32.) 48.7 (35.) 83.6 (39.) | | | | |
| Trefferlage | 0.03 mm links, 1.70 mm hoch | | | | |
| Streuwert | 2.46, horizontal: 2.96, vertikal: 1.82 | | | | |

Unterschrift des Schützen

| | | |
|--------------|--|---------|
| Ergebnis: | 377 | (394.0) |
| Serien: | 92 95 97 93 | |
| Zähler: | 19 19 2 0 0 0 0 0 0 0 | |
| Innenzehner: | 15 | |
| weiteste: | 603 (34), 560 (40), 495 (36) | |
| beste Teiler | 30.3 (28.) 40.0 (14.) 46.6 (38.) | |
| Trefferlage | 0.34 mm links, 0.52 mm hoch | |
| Streuwert | 2.23, horizontal: 2.59, vertikal: 1.79 | |

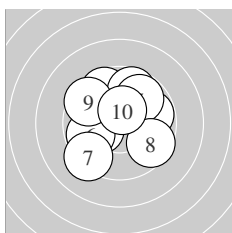
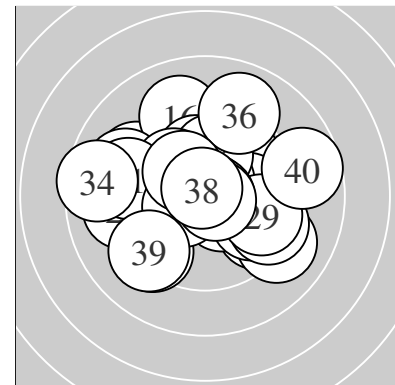

| | | | | | |
|--------------|--|-------|--------|-------|--------|
| Serie 1: | 9.7 ↘ | 9.7 ↗ | 10.2 * | 9.8 → | 9.8 ↗ |
| | 9.8 ← | 9.3 ↙ | 9.6 ↘ | 9.6 ↖ | 10.5 * |
| beste Teiler | 122.3 (10.) 192.5 (3.) 287.4 (6.) | | | | |
| Trefferlage | 0.28 mm links, 0.55 mm hoch | | | | |
| Streuwert | 2.22, horizontal: 2.33, vertikal: 2.10 | | | | |

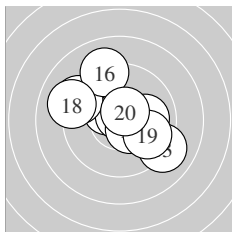

| | | | | | |
|--------------|--|--------|-------|--------|--------|
| Serie 2: | 10.0 → | 10.4 * | 9.1 ↘ | 10.8 * | 9.3 ↖ |
| | 9.1 ↗ | 10.5 * | 9.1 ← | 9.8 ↘ | 10.6 * |
| beste Teiler | 40.0 (14.) 94.3 (20.) 124.6 (17.) | | | | |
| Trefferlage | 0.04 mm links, 0.52 mm hoch | | | | |
| Streuwert | 2.35, horizontal: 2.71, vertikal: 1.92 | | | | |

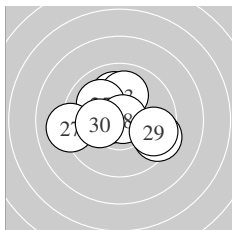

| | | | | | |
|--------------|--|--------|--------|--------|--------|
| Serie 3: | 10.2 * | 10.0 ↗ | 10.0 ↑ | 10.6 * | 10.0 ↖ |
| | 9.4 ↘ | 9.1 ← | 10.8 * | 9.6 → | 10.2 * |
| beste Teiler | 30.3 (28.) 84.5 (24.) 186.4 (30.) | | | | |
| Trefferlage | 0.27 mm links, 0.44 mm hoch | | | | |
| Streuwert | 1.95, horizontal: 2.36, vertikal: 1.42 | | | | |

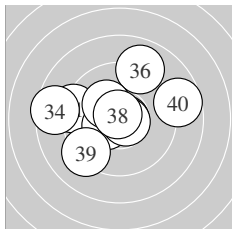

| | | | | | |
|--------------|--|--------|--------|-------|--------|
| Serie 4: | 9.2 ↖ | 10.4 * | 10.7 * | 8.5 ← | 10.7 * |
| | 9.0 ↗ | 10.2 * | 10.8 * | 9.2 ↙ | 8.7 → |
| beste Teiler | 46.6 (38.) 51.3 (33.) 62.7 (35.) | | | | |
| Trefferlage | 0.76 mm links, 0.57 mm hoch | | | | |
| Streuwert | 2.66, horizontal: 3.23, vertikal: 1.93 | | | | |

Unterschrift des Schützen

Ergebnis: **370** (386.4)
 Serien: 92 93 89 96
 Zähler: 17 16 7 0 0 0 0 0 0
 Innenzehner: 12
 weiteste: 681 (11), 645 (29), 625 (18)
 beste Teiler 85.0 (1.) 100.6 (32.) 116.7 (38.)
 Trefferlage 0.24 mm links, 0.40 mm hoch
 Streuwert 2.58, horizontal: 3.10, vertikal: 1.93

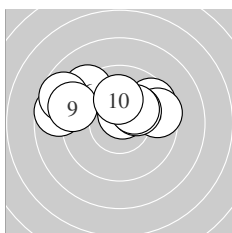
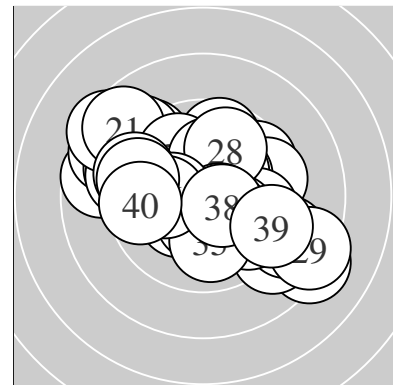

Serie 1:
 10.6 * 9.6 ↗ 9.5 → 8.7 ← 10.2 *
 9.3 ↘ 10.2 * 8.7 ↖ 9.1 ↖ 10.1 ↑
 beste Teiler 85.0 (1.) 185.3 (7.) 189.8 (5.)
 Trefferlage 0.84 mm links, 1.60 mm hoch
 Streuwert 2.41, horizontal: 3.33, vertikal: 0.73

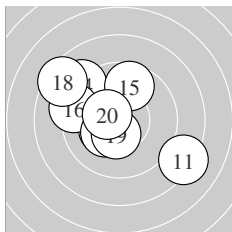

Serie 2:
 8.2 ↘ 10.3 * 10.3 * 9.1 ↘ 9.7 ↑
 9.2 ← 10.3 * 8.5 ↘ 10.4 * 10.5 *
 beste Teiler 123.9 (20.) 130.9 (19.) 158.2 (12.)
 Trefferlage 1.16 mm links, 0.54 mm hoch
 Streuwert 2.70, horizontal: 3.05, vertikal: 2.31

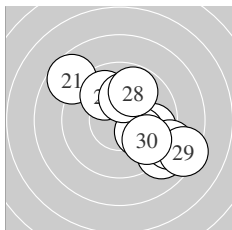

Serie 3:
 8.7 ↘ 9.0 ↘ 9.9 ↘ 9.8 → 10.1 ↘
 8.9 → 10.1 ↑ 9.8 ↑ 8.4 → 9.7 ↘
 beste Teiler 204.8 (27.) 207.1 (25.) 262.3 (23.)
 Trefferlage 1.71 mm rechts, 0.11 mm tief
 Streuwert 2.75, horizontal: 2.96, vertikal: 2.51

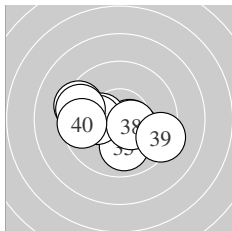

Serie 4:
 10.2 * 10.6 * 9.4 ↖ 10.3 * 10.0 ↓
 10.1 ← 9.5 ← 10.5 * 9.3 → 9.6 ←
 beste Teiler 100.6 (32.) 116.7 (38.) 170.3 (34.)
 Trefferlage 0.69 mm links, 0.43 mm tief
 Streuwert 1.96, horizontal: 2.55, vertikal: 1.10

Unterschrift des Schützen

Meyton Elektronik

| | | |
|--------------|--|----------|
| Ergebnis: | 355 | (372.2) |
| Serien: | 92 | 87 89 87 |
| Zähler: | 11 18 6 5 0 0 0 0 0 0 | |
| Innenzehner: | 8 | |
| weiteste: | 972 (24), 950 (8), 930 (32) | |
| beste Teiler | 78.4 (33.) 101.9 (30.) 131.1 (36.) | |
| Trefferlage | 0.68 mm rechts, 0.32 mm hoch | |
| Streuwert | 3.35, horizontal: 4.33, vertikal: 1.93 | |

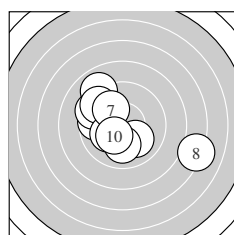
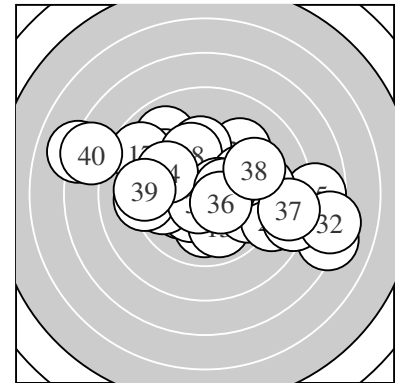

| | | | | | |
|--------------|--|------------|------------|--------|--------|
| Serie 1: | 9.7 ← | 10.0 ↘ | 8.9 ↖ | 9.4 ↖ | 9.4 ↖ |
| | 10.2 * | 10.0 ↖ | 7.2 → | 10.0 ↓ | 10.3 * |
| beste Teiler | 160.7 (10.) | 199.9 (6.) | 227.1 (2.) | | |
| Trefferlage | 0.62 mm links, 0.10 mm hoch | | | | |
| Streuwert | 3.12, horizontal: 3.70, vertikal: 2.39 | | | | |

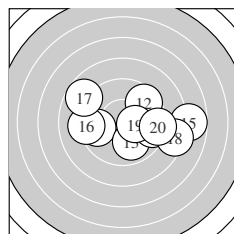

| | | | | | |
|--------------|--|-------------|-------------|--------|-------|
| Serie 2: | 9.7 ← | 9.6 ↗ | 9.9 ↓ | 9.5 → | 7.8 → |
| | 9.2 ← | 8.7 ↖ | 8.3 → | 10.3 * | 9.2 → |
| beste Teiler | 152.7 (19.) | 256.1 (13.) | 313.4 (11.) | | |
| Trefferlage | 1.51 mm rechts, 0.16 mm tief | | | | |
| Streuwert | 3.31, horizontal: 4.38, vertikal: 1.66 | | | | |

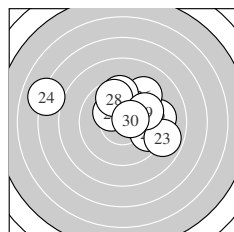

| | | | | | |
|--------------|--|-------------|-------------|-------|--------|
| Serie 3: | 9.6 → | 9.2 → | 8.9 → | 7.1 ← | 10.2 * |
| | 9.3 ↗ | 9.6 ↑ | 9.7 ↖ | 9.8 → | 10.5 * |
| beste Teiler | 101.9 (30.) | 179.5 (25.) | 300.5 (29.) | | |
| Trefferlage | 0.64 mm rechts, 1.27 mm hoch | | | | |
| Streuwert | 3.18, horizontal: 4.08, vertikal: 1.90 | | | | |

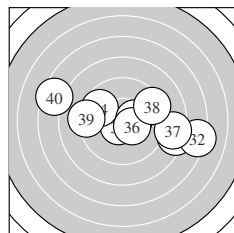

| | | | | | |
|--------------|--|-------------|-------------|-------|--------|
| Serie 4: | 8.3 → | 7.2 → | 10.6 * | 9.7 ↖ | 10.4 * |
| | 10.4 * | 8.5 → | 9.3 ↗ | 9.2 ← | 7.4 ← |
| beste Teiler | 78.4 (33.) | 131.1 (36.) | 146.5 (35.) | | |
| Trefferlage | 1.18 mm rechts, 0.06 mm hoch | | | | |
| Streuwert | 3.96, horizontal: 5.36, vertikal: 1.65 | | | | |

Unterschrift des Schützen

Meyton Elektronik

Ergebnis: **389** (408.8)
 Serien: 97 99 95 98
 Zähler: 30 9 1 0 0 0 0 0 0 0
 Innenzehner: 25
 weiteste: 503 (21), 369 (33), 338 (8)
 beste Teiler 40.3 (38.) 53.0 (31.) 66.8 (3.)
 Trefferlage 0.04 mm rechts, 0.26 mm hoch
 Streuwert 1.48, horizontal: 1.54, vertikal: 1.42

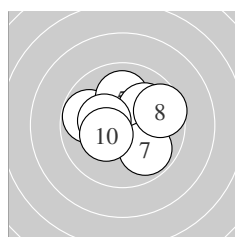
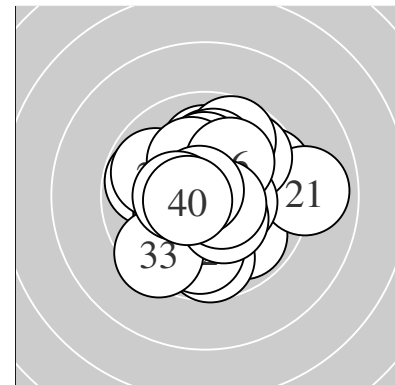

Serie 1:
 10.5 * 9.8 ← 10.7 * 10.7 * 10.0 ↑
 10.1 ↗ 9.9 ↘ 9.6 → 10.3 * 10.3 *
 beste Teiler 66.8 (3.) 75.6 (4.) 124.8 (1.)
 Trefferlage 0.03 mm rechts, 0.33 mm hoch
 Streuwert 1.57, horizontal: 1.83, vertikal: 1.25

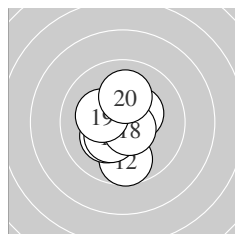

Serie 2:
 10.6 * 9.7 ↓ 10.7 * 10.4 * 10.5 *
 10.2 * 10.3 * 10.6 * 10.2 * 10.1 ↑
 beste Teiler 73.5 (13.) 78.4 (18.) 82.8 (11.)
 Trefferlage 0.21 mm links, 0.09 mm tief
 Streuwert 1.24, horizontal: 0.97, vertikal: 1.46

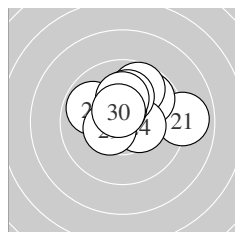

Serie 3:
 8.9 → 9.8 ↗ 9.7 ↗ 10.4 * 10.1 ↑
 10.5 * 9.8 ← 10.2 * 10.5 * 10.5 *
 beste Teiler 101.8 (30.) 116.2 (26.) 119.8 (29.)
 Trefferlage 0.61 mm rechts, 1.15 mm hoch
 Streuwert 1.64, horizontal: 2.04, vertikal: 1.09

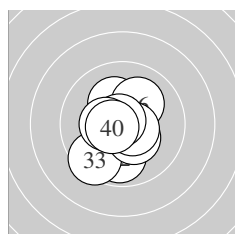

Serie 4:
 10.7 * 9.9 ↓ 9.5 ↙ 10.4 * 10.2 *
 10.1 ↗ 10.6 * 10.8 * 10.4 * 10.6 *
 beste Teiler 40.3 (38.) 53.0 (31.) 90.9 (40.)
 Trefferlage 0.24 mm links, 0.32 mm tief
 Streuwert 1.37, horizontal: 1.13, vertikal: 1.57

Unterschrift des Schützen

Meyton Elektronik

Ergebnis: **390** (408.1)
 Serien: 99 95 99 97
 Zähler: 30 10 0 0 0 0 0 0 0 0
 Innenzehner: 22
 weiteste: 445 (40), 392 (28), 347 (7)
 beste Teiler 40.2 (18.) 54.0 (26.) 55.0 (27.)
 Trefferlage 0.06 mm links, 0.08 mm hoch
 Streuwert 1.52, horizontal: 1.50, vertikal: 1.54

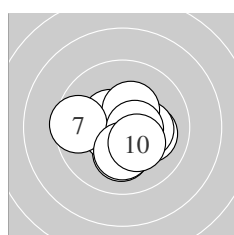
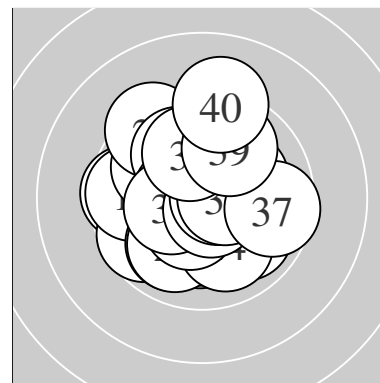

Serie 1:
 10.2 * 10.6 * 10.1 → 10.2 * 10.5 *
 10.4 * 9.6 ← 10.6 * 10.2 * 10.3 *
 beste Teiler 96.1 (8.) 98.3 (2.) 119.6 (5.)
 Trefferlage 0.10 mm rechts, 0.39 mm tief
 Streuwert 1.37, horizontal: 1.62, vertikal: 1.06

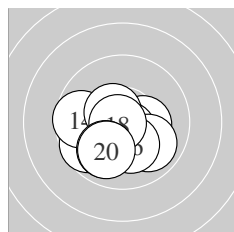

Serie 2:
 10.3 * 9.7 ↙ 10.7 * 9.7 ← 9.9 ↘
 10.2 * 10.5 * 10.8 * 9.9 ↘ 9.9 ↘
 beste Teiler 40.2 (18.) 71.5 (13.) 108.8 (17.)
 Trefferlage 0.51 mm links, 0.93 mm tief
 Streuwert 1.43, horizontal: 1.71, vertikal: 1.07

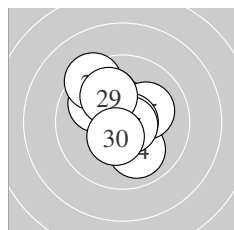

Serie 3:
 10.1 ↖ 10.5 * 10.0 ↖ 10.0 ↘ 10.1 →
 10.7 * 10.7 * 9.4 ↖ 10.0 ↖ 10.5 *
 beste Teiler 54.0 (26.) 55.0 (27.) 101.8 (22.)
 Trefferlage 0.29 mm links, 0.70 mm hoch
 Streuwert 1.48, horizontal: 1.34, vertikal: 1.60

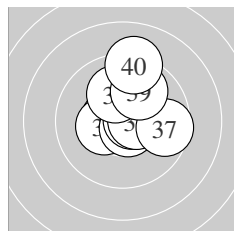

Serie 4:
 10.6 * 10.4 * 10.1 ↑ 10.7 * 10.7 *
 10.5 * 9.6 → 10.1 ↑ 9.9 ↗ 9.2 ↑
 beste Teiler 69.2 (34.) 73.1 (35.) 100.2 (31.)
 Trefferlage 0.44 mm rechts, 0.96 mm hoch
 Streuwert 1.51, horizontal: 1.36, vertikal: 1.65

Unterschrift des Schützen

Ergebnis: **394** (409.3)
 Serien: 100 99 98 97
 Zähler: 34 6 0 0 0 0 0 0 0 0
 Innenzehner: 25
 weiteste: 415 (31), 392 (12), 314 (38)
 beste Teiler 50.6 (7.) 61.9 (25.) 64.1 (1.)
 Trefferlage 0.25 mm links, 0.30 mm hoch
 Streuwert 1.41, horizontal: 1.49, vertikal: 1.32

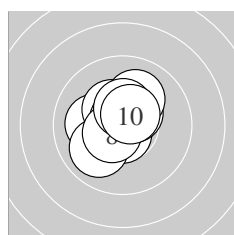
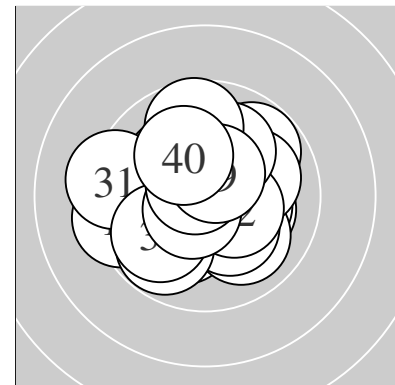

Serie 1:
 10.7 * 10.1 ← 10.5 * 10.0 ↙ 10.4 *
 10.1 ↗ 10.8 * 10.6 * 10.4 * 10.5 *
 beste Teiler 50.6 (7.) 64.1 (1.) 99.4 (8.)
 Trefferlage 0.34 mm links, 0.38 mm hoch
 Streuwert 1.07, horizontal: 1.05, vertikal: 1.10

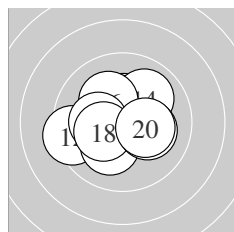

Serie 2:
 10.4 * 9.4 ← 10.4 * 10.0 ↗ 10.2 *
 10.2 * 10.2 * 10.3 * 10.2 * 10.2 *
 beste Teiler 129.0 (13.) 144.2 (11.) 161.4 (18.)
 Trefferlage 0.37 mm links, 0.16 mm hoch
 Streuwert 1.57, horizontal: 1.82, vertikal: 1.26

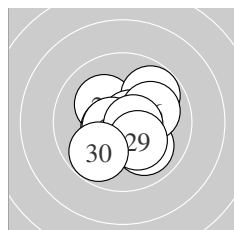

Serie 3:
 10.2 * 10.0 ↘ 9.8 ↗ 10.5 * 10.7 *
 10.0 → 10.6 * 10.6 * 10.2 * 9.8 ↙
 beste Teiler 61.9 (25.) 82.0 (28.) 89.5 (27.)
 Trefferlage 0.34 mm rechts, 0.20 mm tief
 Streuwert 1.42, horizontal: 1.47, vertikal: 1.36

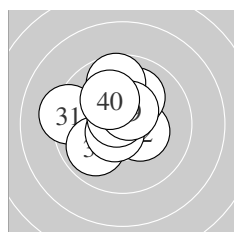

Serie 4:
 9.3 ← 10.4 * 9.9 ↙ 10.0 ↑ 10.6 *
 10.1 ↗ 10.7 * 9.7 ↑ 10.5 * 10.1 ↘
 beste Teiler 67.2 (37.) 84.8 (35.) 112.7 (39.)
 Trefferlage 0.63 mm links, 0.87 mm hoch
 Streuwert 1.53, horizontal: 1.55, vertikal: 1.50

Unterschrift des Schützen

Meyton Elektronik

Ergebnis: **384** (400.0)
 Serien: 94 97 95 98
 Zähler: 24 16 0 0 0 0 0 0 0 0
 Innenzehner: 15
 weiteste: 499 (20), 444 (7), 397 (30)
 beste Teiler 18.0 (39.) 60.5 (38.) 72.4 (19.)
 Trefferlage 0.34 mm rechts, 0.19 mm tief
 Streuwert 1.86, horizontal: 1.96, vertikal: 1.75

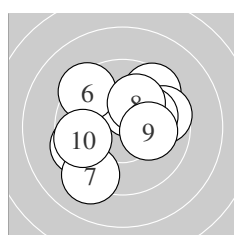
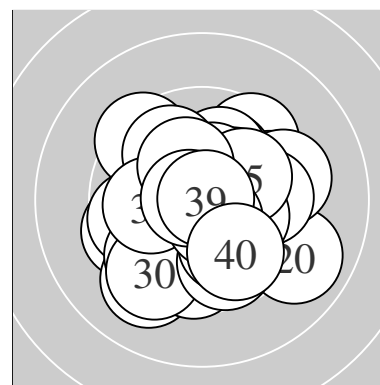

Serie 1:
 9.5 ← 9.5 ↗ 9.6 → 10.1 → 10.3 *
 9.4 ↘ 9.2 ↙ 10.1 ↑ 10.1 → 9.7 ←
 beste Teiler 157.0 (5.) 203.2 (9.) 214.9 (8.)
 Trefferlage 0.05 mm links, 0.43 mm hoch
 Streuwert 2.31, horizontal: 2.56, vertikal: 2.02

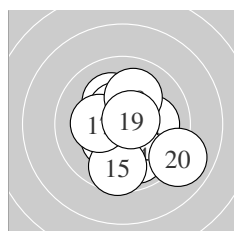

Serie 2:
 10.1 → 10.4 * 10.2 * 9.9 ↘ 9.6 ↓
 10.5 * 10.2 * 10.1 ↑ 10.7 * 9.0 ↘
 beste Teiler 72.4 (19.) 110.5 (16.) 149.5 (12.)
 Trefferlage 0.44 mm rechts, 0.41 mm tief
 Streuwert 1.82, horizontal: 1.78, vertikal: 1.85

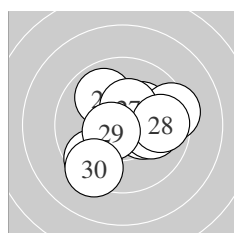

Serie 3:
 10.2 * 10.3 * 9.4 → 9.6 ↙ 9.9 ↘
 10.1 → 10.4 * 9.8 → 10.6 * 9.4 ↙
 beste Teiler 100.2 (29.) 142.6 (27.) 161.7 (22.)
 Trefferlage 0.55 mm rechts, 0.13 mm tief
 Streuwert 1.96, horizontal: 2.17, vertikal: 1.72

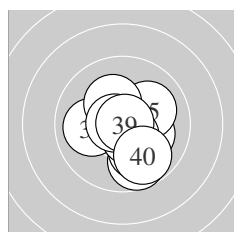

Serie 4:
 10.0 ← 9.7 ↘ 10.0 ↘ 10.2 * 10.1 →
 10.5 * 10.2 * 10.7 * 10.9 * 9.8 ↘
 beste Teiler 18.0 (39.) 60.5 (38.) 109.6 (36.)
 Trefferlage 0.45 mm rechts, 0.64 mm tief
 Streuwert 1.41, horizontal: 1.36, vertikal: 1.46

Unterschrift des Schützen

Meyton Elektronik

Ergebnis: **385** (401.6)
 Serien: 98 97 94 96
 Zähler: 25 15 0 0 0 0 0 0 0 0
 Innenzehner: 20
 weiteste: 498 (36), 437 (27), 422 (23)
 beste Teiler 42.1 (25.) 55.6 (2.) 70.6 (16.)
 Trefferlage 0.53 mm links, 0.25 mm hoch
 Streuwert 1.77, horizontal: 2.01, vertikal: 1.50

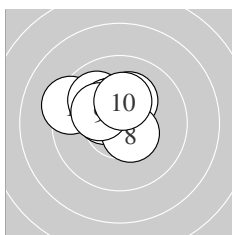
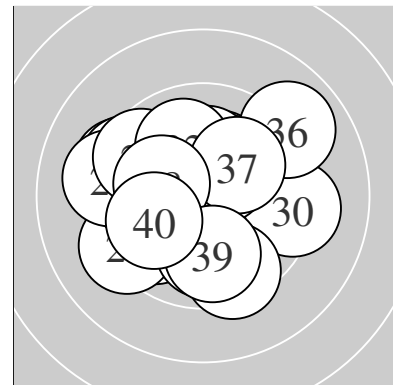

Serie 1:
 9.3 ↖ 10.7 * 9.9 ↘ 10.4 * 10.4 *
 10.2 * 10.4 * 10.5 * 10.2 * 10.3 *
 beste Teiler 55.6 (2.) 114.6 (8.) 127.9 (4.)
 Trefferlage 0.74 mm links, 1.03 mm hoch
 Streuwert 1.15, horizontal: 1.42, vertikal: 0.79

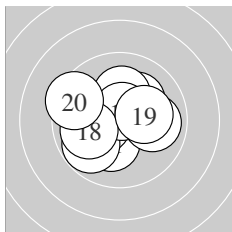

Serie 2:
 10.2 * 10.4 * 10.2 * 10.2 * 9.8 ↙
 10.7 * 9.9 → 10.0 ← 10.2 * 9.4 ↘
 beste Teiler 70.6 (16.) 141.1 (12.) 185.1 (11.)
 Trefferlage 0.40 mm links, 0.11 mm hoch
 Streuwert 1.69, horizontal: 1.98, vertikal: 1.33

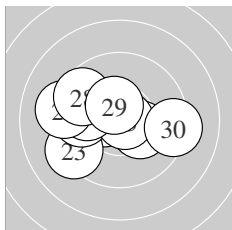

Serie 3:
 10.3 * 10.5 * 9.3 ↙ 9.8 ← 10.8 *
 9.9 ↖ 9.2 ← 9.6 ↘ 10.5 * 9.3 →
 beste Teiler 42.1 (25.) 120.2 (22.) 122.0 (29.)
 Trefferlage 1.16 mm links, 0.11 mm hoch
 Streuwert 2.03, horizontal: 2.64, vertikal: 1.15

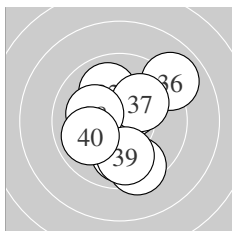

Serie 4:
 10.4 * 10.0 ↖ 9.5 ↘ 10.0 ↓ 10.2 *
 9.0 ↗ 10.1 ↗ 10.1 ← 9.9 ↓ 9.9 ↖
 beste Teiler 126.3 (31.) 178.3 (35.) 201.2 (38.)
 Trefferlage 0.15 mm rechts, 0.24 mm tief
 Streuwert 2.08, horizontal: 1.90, vertikal: 2.24

Unterschrift des Schützen

Ergebnis: **387** (406.0)
 Serien: 98 97 94 98
 Zähler: 27 13 0 0 0 0 0 0 0 0
 Innenzehner: 23
 weiteste: 497 (9), 493 (24), 428 (28)
 beste Teiler 37.0 (22.) 38.3 (12.) 49.7 (36.)
 Trefferlage 0.00 mm , 0.00 mm
 Streuwert 1.70, horizontal: 2.11, vertikal: 1.17

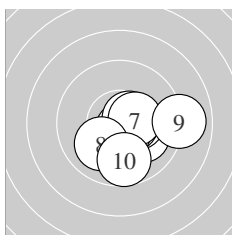
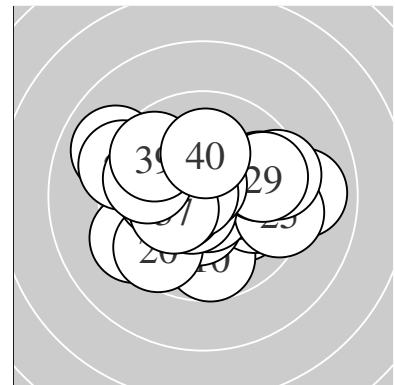

Serie 1:
 10.1 ↘ 10.7 * 10.4 * 10.6 * 10.6 *
 10.6 * 10.4 * 10.0 ↙ 9.0 → 9.7 ↓
 beste Teiler 51.4 (2.) 82.7 (5.) 89.9 (6.)
 Trefferlage 1.09 mm rechts, 0.61 mm tief
 Streuwert 1.40, horizontal: 1.65, vertikal: 1.08

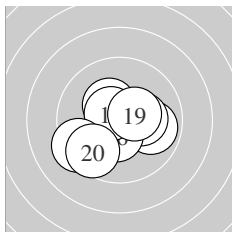

Serie 2:
 10.3 * 10.8 * 9.9 → 10.2 * 10.7 *
 10.4 * 10.6 * 9.3 ↙ 10.4 * 9.6 ↘
 beste Teiler 38.3 (12.) 69.0 (15.) 89.8 (17.)
 Trefferlage 0.20 mm links, 0.37 mm tief
 Streuwert 1.56, horizontal: 1.82, vertikal: 1.24

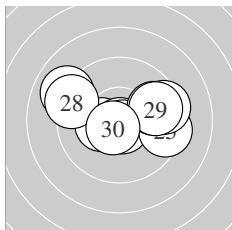

Serie 3:
 10.3 * 10.8 * 10.7 * 9.0 ↖ 9.4 →
 9.4 → 9.7 → 9.2 ↖ 9.7 → 10.6 *
 beste Teiler 37.0 (22.) 61.4 (23.) 85.7 (30.)
 Trefferlage 0.31 mm rechts, 0.40 mm hoch
 Streuwert 2.27, horizontal: 3.02, vertikal: 1.09

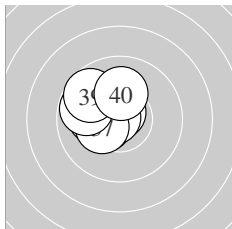

Serie 4:
 10.5 * 10.7 * 10.5 * 10.4 * 10.1 ←
 10.8 * 10.3 * 9.8 ↖ 9.7 ↖ 10.1 ↑
 beste Teiler 49.7 (36.) 57.2 (32.) 102.8 (31.)
 Trefferlage 1.17 mm links, 0.55 mm hoch
 Streuwert 0.98, horizontal: 1.02, vertikal: 0.95

Unterschrift des Schützen

Meyton Elektronik

Ergebnis: **381** (396.4)
 Serien: 93 96 97 95
 Zähler: 23 15 2 0 0 0 0 0 0 0
 Innenzehner: 16
 weiteste: 696 (5), 593 (20), 495 (1)
 beste Teiler 31.9 (4.) 78.2 (29.) 97.1 (40.)
 Trefferlage 0.37 mm rechts, 0.11 mm tief
 Streuwert 2.12, horizontal: 2.60, vertikal: 1.50

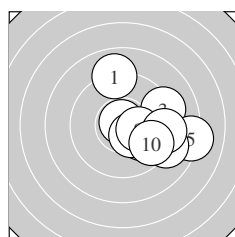
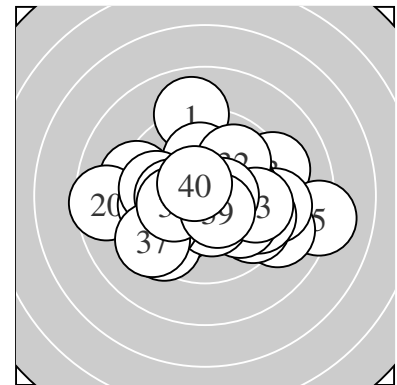

Serie 1:
 9.0 ↑ 10.0 ↘ 9.2 ↗ 10.8 * 8.2 →
 10.4 * 9.0 ↘ 10.3 * 9.3 → 9.6 ↘
 beste Teiler 31.9 (4.) 131.1 (6.) 163.2 (8.)
 Trefferlage 2.57 mm rechts, 0.16 mm tief
 Streuwert 2.21, horizontal: 2.34, vertikal: 2.07

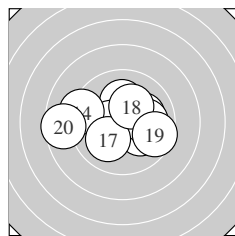

Serie 2:
 10.1 ↑ 10.1 ↘ 10.5 * 9.3 ← 10.1 →
 10.0 → 10.1 ↙ 10.2 * 9.6 → 8.6 ←
 beste Teiler 118.2 (13.) 178.6 (18.) 201.0 (11.)
 Trefferlage 0.25 mm links, 0.08 mm hoch
 Streuwert 2.26, horizontal: 2.95, vertikal: 1.24

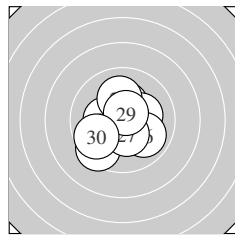

Serie 3:
 10.3 * 10.3 * 10.5 * 9.5 ✓ 10.2 *
 9.9 ↘ 10.4 * 10.1 ↑ 10.6 * 9.7 ↙
 beste Teiler 78.2 (29.) 121.5 (23.) 143.9 (27.)
 Trefferlage 0.09 mm links, 0.20 mm tief
 Streuwert 1.62, horizontal: 1.67, vertikal: 1.58

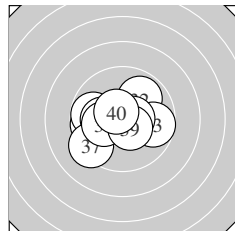

Serie 4:
 9.7 ← 9.9 ↗ 9.7 → 10.6 * 9.8 ←
 10.2 * 9.3 ↙ 10.2 * 10.5 * 10.6 *
 beste Teiler 97.1 (40.) 98.0 (34.) 114.8 (39.)
 Trefferlage 0.70 mm links, 0.18 mm tief
 Streuwert 1.78, horizontal: 2.21, vertikal: 1.20

Unterschrift des Schützen

Meyton Elektronik

Ergebnis: **380** (398.2)
 Serien: 94 97 94 95
 Zähler: 21 18 1 0 0 0 0 0 0 0
 Innenzehner: 15
 weiteste: 521 (2), 479 (34), 468 (5)
 beste Teiler 40.6 (31.) 62.5 (17.) 70.0 (22.)
 Trefferlage 0.20 mm links, 0.37 mm hoch
 Streuwert 1.98, horizontal: 2.24, vertikal: 1.69

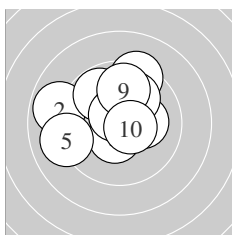
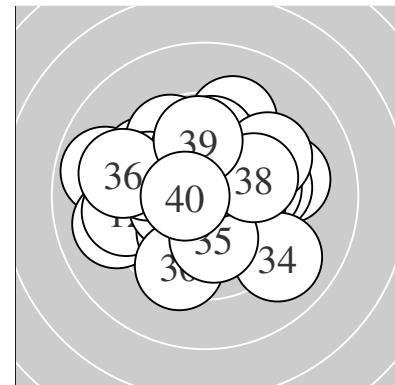

Serie 1:
 9.3 ↗ 8.9 ← 10.5 * 9.8 ↘ 9.1 ←
 10.2 * 10.6 * 10.0 ↗ 9.8 ↑ 10.6 *
 beste Teiler 79.6 (7.) 97.1 (10.) 119.8 (3.)
 Trefferlage 0.62 mm links, 1.02 mm hoch
 Streuwert 2.11, horizontal: 2.42, vertikal: 1.74

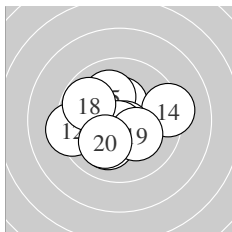

Serie 2:
 10.4 * 9.3 ← 10.1 ↙ 9.3 → 10.1 ↘
 10.7 * 10.7 * 9.8 ↘ 10.2 * 10.1 ↙
 beste Teiler 62.5 (17.) 75.7 (16.) 139.4 (11.)
 Trefferlage 0.37 mm links, 0.14 mm tief
 Streuwert 1.84, horizontal: 2.19, vertikal: 1.41

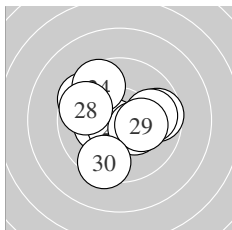

Serie 3:
 10.3 * 10.7 * 9.6 ↘ 9.6 ↘ 9.7 →
 9.9 → 10.4 * 9.7 ← 10.2 * 9.4 ↙
 beste Teiler 70.0 (22.) 143.6 (27.) 168.4 (21.)
 Trefferlage 0.21 mm links, 0.08 mm hoch
 Streuwert 2.00, horizontal: 2.27, vertikal: 1.70

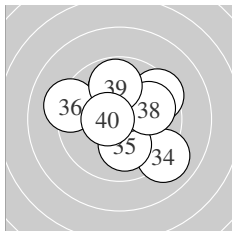

Serie 4:
 10.8 * 10.0 ↑ 9.5 ↗ 9.0 ↘ 10.1 ↓
 9.2 ← 10.4 * 9.9 → 9.8 ↑ 10.5 *
 beste Teiler 40.6 (31.) 101.0 (40.) 128.3 (37.)
 Trefferlage 0.39 mm rechts, 0.52 mm hoch
 Streuwert 2.11, horizontal: 2.29, vertikal: 1.90

Unterschrift des Schützen

Meyton Elektronik

Ergebnis: **391** (410.0)
 Serien: 100 95 97 99
 Zähler: 32 7 1 0 0 0 0 0 0 0
 Innenzehner: 29
 weiteste: 525 (12), 369 (22), 360 (16)
 beste Teiler 38.3 (2.) 42.3 (30.) 48.3 (17.)
 Trefferlage 0.61 mm rechts, 0.42 mm tief
 Streuwert 1.36, horizontal: 1.64, vertikal: 1.01

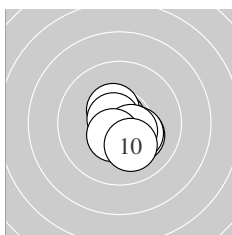
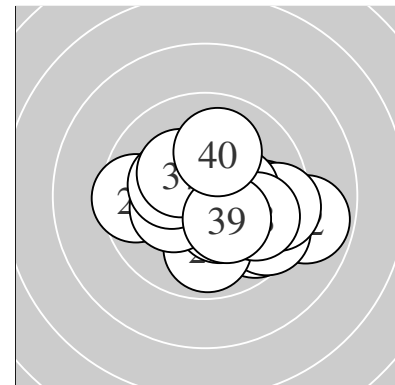

Serie 1:
 10.2 * 10.8 * 10.5 * 10.5 * 10.7 *
 10.4 * 10.3 * 10.5 * 10.5 * 10.1 ↘
 beste Teiler 38.3 (2.) 61.5 (5.) 113.1 (3.)
 Trefferlage 0.46 mm rechts, 0.56 mm tief
 Streuwert 0.87, horizontal: 0.84, vertikal: 0.91

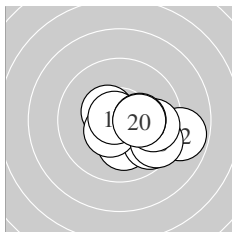

Serie 2:
 10.1 ↓ 8.9 → 10.5 * 9.7 ↘ 10.5 *
 9.5 ↘ 10.8 * 9.8 → 10.3 * 10.3 *
 beste Teiler 48.3 (17.) 119.6 (15.) 124.8 (13.)
 Trefferlage 1.51 mm rechts, 0.73 mm tief
 Streuwert 1.56, horizontal: 1.99, vertikal: 0.97

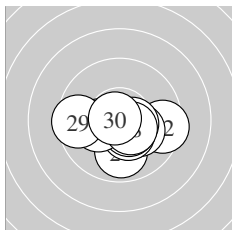

Serie 3:
 9.9 ↓ 9.5 → 10.2 * 10.5 * 10.4 *
 10.5 * 10.2 * 10.5 * 9.5 ← 10.8 *
 beste Teiler 42.3 (30.) 111.4 (24.) 115.3 (26.)
 Trefferlage 0.32 mm rechts, 0.75 mm tief
 Streuwert 1.48, horizontal: 1.94, vertikal: 0.77

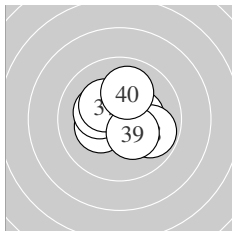

Serie 4:
 10.3 * 10.7 * 10.2 * 10.5 * 10.7 *
 10.3 * 10.3 * 9.8 ↘ 10.3 * 10.0 ↑
 beste Teiler 55.0 (32.) 71.5 (35.) 119.9 (34.)
 Trefferlage 0.14 mm rechts, 0.35 mm hoch
 Streuwert 1.24, horizontal: 1.41, vertikal: 1.06

Unterschrift des Schützen

Ergebnis: **389** (404.5)
 Serien: 95 97 99 98
 Zähler: 30 9 1 0 0 0 0 0 0 0
 Innenzehner: 22
 weiteste: 573 (3), 478 (1), 372 (15)
 beste Teiler 43.1 (5.) 67.7 (8.) 75.5 (31.)
 Trefferlage 0.09 mm links, 0.34 mm hoch
 Streuwert 1.67, horizontal: 1.99, vertikal: 1.26

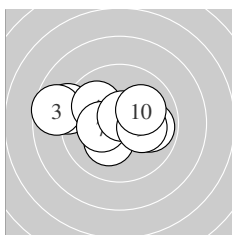
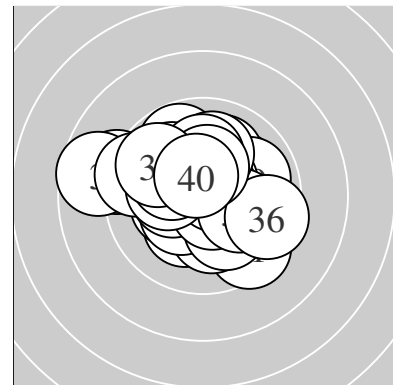

Serie 1:
 9.0 ← 9.9 → 8.7 ← 9.9 ↘ 10.8 *
 10.2 * 10.3 * 10.7 * 10.1 → 10.1 ↗
 beste Teiler 43.1 (5.) 67.7 (8.) 162.1 (7.)
 Trefferlage 0.79 mm links, 0.36 mm hoch
 Streuwert 2.07, horizontal: 2.76, vertikal: 0.98

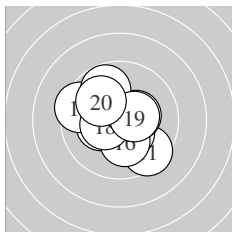

Serie 2:
 9.5 ↘ 10.4 * 10.3 * 10.3 * 9.5 ←
 10.2 * 9.8 ↖ 10.4 * 10.4 * 10.0 ↘
 beste Teiler 134.8 (19.) 135.7 (18.) 144.2 (12.)
 Trefferlage 0.28 mm links, 0.03 mm tief
 Streuwert 1.76, horizontal: 1.87, vertikal: 1.64

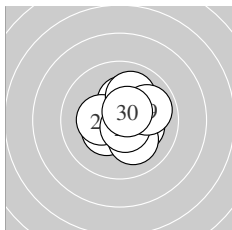

Serie 3:
 10.3 * 10.4 * 10.3 * 10.0 ↗ 10.3 *
 10.2 * 10.1 ↘ 10.6 * 9.9 → 10.5 *
 beste Teiler 80.4 (28.) 101.9 (30.) 146.6 (22.)
 Trefferlage 0.67 mm rechts, 0.21 mm hoch
 Streuwert 1.23, horizontal: 1.27, vertikal: 1.20

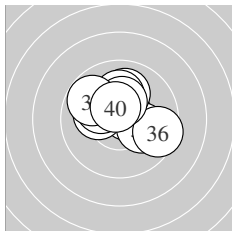

Serie 4:
 10.7 * 10.2 * 10.1 ↘ 10.2 * 10.0 ↑
 9.5 → 10.1 ↑ 10.3 * 9.8 ↘ 10.5 *
 beste Teiler 75.5 (31.) 114.1 (40.) 156.4 (38.)
 Trefferlage 0.03 mm rechts, 0.84 mm hoch
 Streuwert 1.50, horizontal: 1.78, vertikal: 1.15

Unterschrift des Schützen

Meyton Elektronik

Ergebnis: **379** (399.5)
 Serien: 96 97 93 93
 Zähler: 21 17 2 0 0 0 0 0 0 0
 Innenzehner: 15
 weiteste: 579 (33), 507 (2), 455 (30)
 beste Teiler 44.5 (18.) 50.9 (24.) 51.0 (3.)
 Trefferlage 0.09 mm rechts, 0.29 mm hoch
 Streuwert 1.92, horizontal: 2.19, vertikal: 1.59

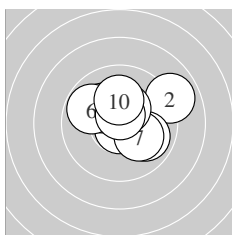
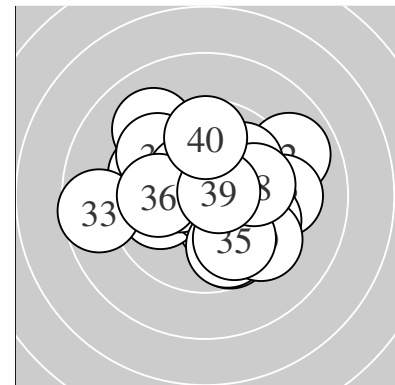

Serie 1:
 10.2 * 8.9 ↗ 10.7 * 10.1 ↘ 9.9 ↘
 9.8 ↖ 10.1 ↘ 10.4 * 10.7 * 10.1 ↑
 beste Teiler 51.0 (3.) 75.2 (9.) 143.2 (8.)
 Trefferlage 0.69 mm rechts, 0.62 mm hoch
 Streuwert 1.68, horizontal: 2.02, vertikal: 1.26

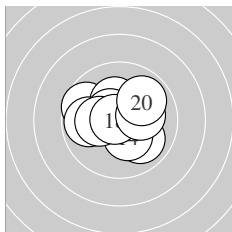

Serie 2:
 9.7 ↖ 9.8 ← 10.0 ↘ 10.3 * 10.3 *
 10.5 * 10.2 * 10.8 * 10.2 * 9.9 ↗
 beste Teiler 44.5 (18.) 103.4 (16.) 159.2 (14.)
 Trefferlage 0.28 mm links, 0.23 mm hoch
 Streuwert 1.56, horizontal: 1.88, vertikal: 1.16

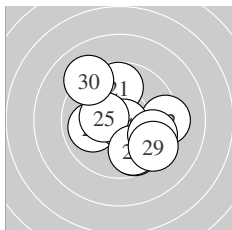

Serie 3:
 9.8 ↑ 9.3 → 10.0 ← 10.8 * 10.4 *
 9.7 ↓ 9.8 ↓ 9.7 ↘ 9.4 ↘ 9.1 ↖
 beste Teiler 50.9 (24.) 142.5 (25.) 250.0 (23.)
 Trefferlage 0.63 mm rechts, 0.33 mm tief
 Streuwert 2.28, horizontal: 2.36, vertikal: 2.20

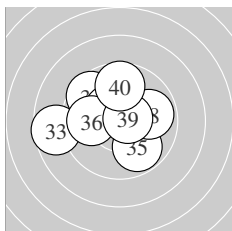

Serie 4:
 10.0 ↘ 9.6 ↖ 8.6 ← 10.4 * 9.8 ↘
 9.9 ← 10.4 * 9.9 → 10.6 * 9.7 ↑
 beste Teiler 77.4 (39.) 138.1 (34.) 140.0 (37.)
 Trefferlage 0.65 mm links, 0.67 mm hoch
 Streuwert 2.08, horizontal: 2.48, vertikal: 1.57

Unterschrift des Schützen

| | | |
|--------------|--|--------------------|
| Ergebnis: | 388 | (404.5) |
| Serien: | 97 | 100 95 96 |
| Zähler: | 28 | 12 0 0 0 0 0 0 0 0 |
| Innenzehner: | 21 | |
| weiteste: | 432 (3), 430 (35), 374 (39) | |
| beste Teiler | 45.0 (4.) 53.9 (27.) 59.3 (5.) | |
| Trefferlage | 0.58 mm links, 0.50 mm hoch | |
| Streuwert | 1.58, horizontal: 1.83, vertikal: 1.28 | |

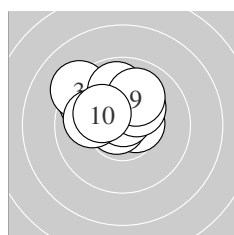
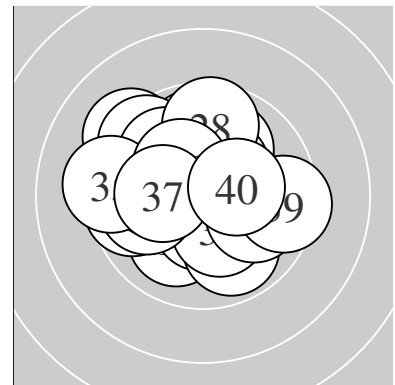

Serie 1:

| | | | | |
|--------------|--|-----------|------------|--------|
| 10.5 * | 9.7 ↖ | 9.2 ↖ | 10.8 * | 10.7 * |
| 10.0 ↖ | 9.9 ↑ | 10.3 * | 10.0 ↗ | 10.2 * |
| beste Teiler | 45.0 (4.) | 59.3 (5.) | 102.8 (1.) | |
| Trefferlage | 0.76 mm links, 1.27 mm hoch | | | |
| Streuwert | 1.36, horizontal: 1.64, vertikal: 1.01 | | | |

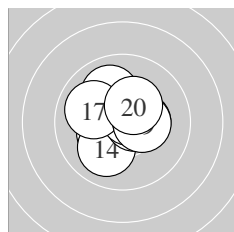

Serie 2:

| | | | | |
|--------------|--|------------|-------------|--------|
| 10.2 * | 10.3 * | 10.0 ↖ | 10.0 ↗ | 10.6 * |
| 10.7 * | 10.0 ↖ | 10.4 * | 10.4 * | 10.3 * |
| beste Teiler | 68.1 (16.) | 90.0 (15.) | 148.0 (18.) | |
| Trefferlage | 0.19 mm links, 0.33 mm hoch | | | |
| Streuwert | 1.29, horizontal: 1.38, vertikal: 1.19 | | | |

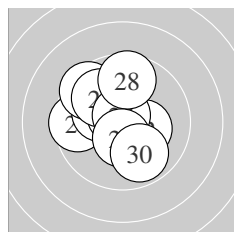

Serie 3:

| | | | | |
|--------------|--|------------|-------------|--------|
| 9.6 ← | 10.3 * | 10.2 * | 9.5 ↖ | 10.7 * |
| 9.9 ↖ | 10.7 * | 9.6 ↑ | 10.5 * | 9.9 ↘ |
| beste Teiler | 53.9 (27.) | 75.6 (25.) | 123.2 (29.) | |
| Trefferlage | 0.69 mm links, 0.52 mm hoch | | | |
| Streuwert | 1.67, horizontal: 1.65, vertikal: 1.69 | | | |

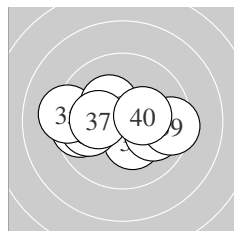

Serie 4:

| | | | | |
|--------------|--|-------------|-------------|--------|
| 10.3 * | 9.6 ← | 9.9 ← | 10.1 ← | 9.2 ← |
| 10.3 * | 10.2 * | 10.0 → | 9.5 → | 10.3 * |
| beste Teiler | 160.3 (40.) | 167.4 (36.) | 168.6 (31.) | |
| Trefferlage | 0.68 mm links, 0.10 mm tief | | | |
| Streuwert | 1.95, horizontal: 2.64, vertikal: 0.80 | | | |

Unterschrift des Schützen

Ergebnis: **383** (401.9)
 Serien: 93 97 97 96
 Zähler: 23 17 0 0 0 0 0 0 0 0
 Innenzehner: 16
 weiteste: 469 (3), 468 (2), 463 (5)
 beste Teiler 28.2 (4.) 58.4 (6.) 61.1 (17.)
 Trefferlage 0.19 mm links, 0.95 mm hoch
 Streuwert 1.68, horizontal: 1.78, vertikal: 1.58

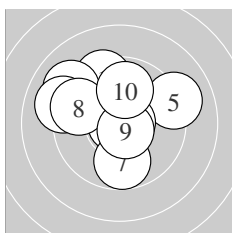
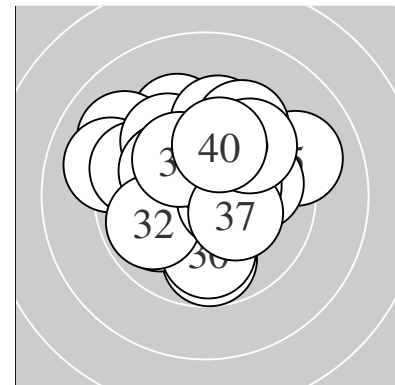

Serie 1:
 9.4 ↖ 9.1 ↘ 9.1 ↘ 10.8 * 9.1 ↗
 10.7 * 9.8 ↓ 9.6 ↖ 10.7 * 9.9 ↑
 beste Teiler 28.2 (4.) 58.4 (6.) 73.1 (9.)
 Trefferlage 0.71 mm links, 0.99 mm hoch
 Streuwert 2.28, horizontal: 2.60, vertikal: 1.92

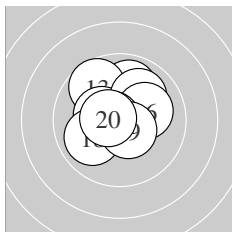

Serie 2:
 9.9 ↑ 10.2 * 9.7 ↘ 10.4 * 10.0 ↗
 10.1 ↗ 10.7 * 9.9 ↙ 10.5 * 10.6 *
 beste Teiler 61.1 (17.) 92.2 (20.) 104.8 (19.)
 Trefferlage 0.30 mm links, 0.76 mm hoch
 Streuwert 1.38, horizontal: 1.43, vertikal: 1.33

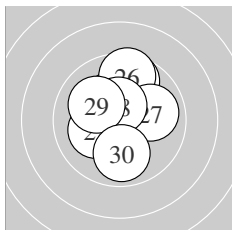

Serie 3:
 10.5 * 9.7 ↑ 10.2 * 10.1 ↑ 10.3 *
 9.5 ↑ 10.0 → 10.5 * 10.1 ↖ 9.9 ↓
 beste Teiler 115.3 (28.) 121.4 (21.) 172.8 (25.)
 Trefferlage 0.08 mm links, 1.02 mm hoch
 Streuwert 1.56, horizontal: 1.31, vertikal: 1.78

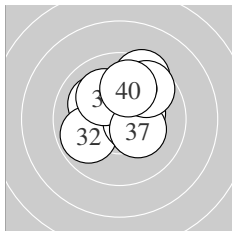

Serie 4:
 10.1 ↖ 9.9 ↙ 10.4 * 10.6 * 10.4 *
 10.1 ↖ 10.3 * 9.5 ↑ 9.7 ↗ 9.9 ↑
 beste Teiler 93.9 (34.) 141.0 (35.) 145.7 (33.)
 Trefferlage 0.31 mm rechts, 1.05 mm hoch
 Streuwert 1.53, horizontal: 1.59, vertikal: 1.47

Unterschrift des Schützen

Meyton Elektronik

Ergebnis: **366** (385.3)
 Serien: 86 92 95 93
 Zähler: 16 16 6 2 0 0 0 0 0 0
 Innenzehner: 13
 weiteste: 981 (6), 754 (12), 619 (8)
 beste Teiler 24.3 (29.) 61.4 (16.) 79.7 (5.)
 Trefferlage 0.15 mm links, 0.59 mm hoch
 Streuwert 2.76, horizontal: 3.51, vertikal: 1.69

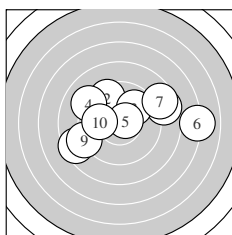
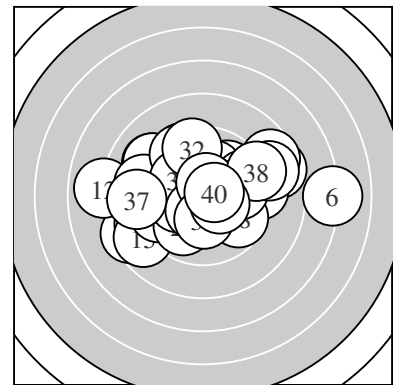

Serie 1:
 8.6 → 9.5 ↘ 9.9 ↙ 9.1 ↖ 10.6 *
 7.0 → 8.6 ↗ 8.5 ← 9.0 ← 9.9 ←
 beste Teiler 79.7 (5.) 252.6 (10.) 268.1 (3.)
 Trefferlage 0.51 mm rechts, 0.80 mm hoch
 Streuwert 3.86, horizontal: 5.04, vertikal: 2.08

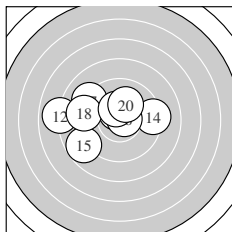

Serie 2:
 10.3 * 7.9 ← 10.5 * 9.3 → 8.8 ↙
 10.7 * 9.1 ↖ 9.1 ← 10.4 * 10.1 ↗
 beste Teiler 61.4 (16.) 103.6 (13.) 147.0 (19.)
 Trefferlage 1.52 mm links, 0.73 mm hoch
 Streuwert 2.68, horizontal: 3.46, vertikal: 1.53

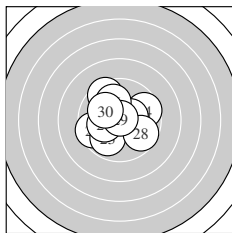

Serie 3:
 9.5 ← 9.5 ↘ 9.9 ↙ 9.6 → 10.4 *
 10.0 ↘ 10.2 * 9.7 ↖ 10.9 * 10.1 ↖
 beste Teiler 24.3 (29.) 143.2 (25.) 195.7 (27.)
 Trefferlage 0.39 mm links, 0.29 mm hoch
 Streuwert 1.95, horizontal: 2.14, vertikal: 1.74

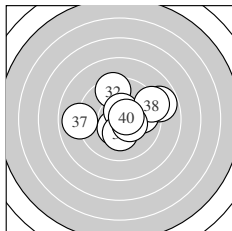

Serie 4:
 10.5 * 9.5 ↘ 9.9 → 10.5 * 8.8 →
 10.3 * 8.9 ← 9.2 ↗ 10.4 * 10.6 *
 beste Teiler 87.9 (40.) 102.3 (34.) 124.4 (31.)
 Trefferlage 0.77 mm rechts, 0.54 mm hoch
 Streuwert 2.29, horizontal: 2.82, vertikal: 1.61

Unterschrift des Schützen

Meyton Elektronik

Ergebnis: **379** (393.6)
 Serien: 93 91 98 97
 Zähler: 22 15 3 0 0 0 0 0 0 0
 Innenzehner: 13
 weiteste: 749 (9), 631 (5), 543 (15)
 beste Teiler 39.4 (40.) 63.2 (31.) 88.3 (17.)
 Trefferlage 0.18 mm rechts, 0.58 mm hoch
 Streuwert 2.20, horizontal: 2.63, vertikal: 1.66

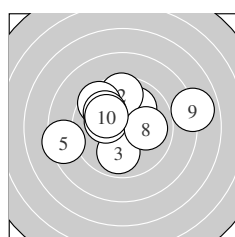
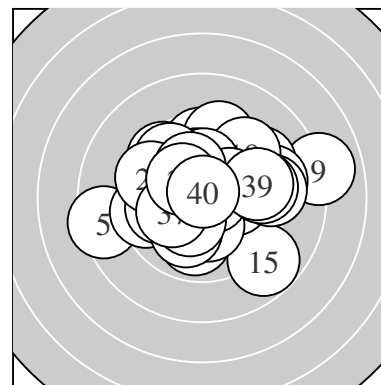

Serie 1:
 10.0 ↗ 9.6 ↑ 9.9 ↓ 9.6 ↘ 8.4 ←
 10.0 ↖ 10.2 * 10.0 → 8.0 → 10.1 ↖
 beste Teiler 183.7 (7.) 203.0 (10.) 233.5 (1.)
 Trefferlage 0.33 mm links, 0.86 mm hoch
 Streuwert 2.81, horizontal: 3.53, vertikal: 1.83

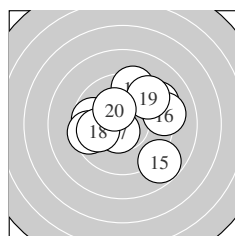

Serie 2:
 9.4 ↑ 9.7 ← 9.3 ↗ 9.5 ← 8.8 ↘
 9.2 → 10.6 * 9.9 ← 9.4 ↗ 10.3 *
 beste Teiler 88.3 (17.) 175.0 (20.) 262.6 (18.)
 Trefferlage 0.50 mm rechts, 0.57 mm hoch
 Streuwert 2.64, horizontal: 3.00, vertikal: 2.21

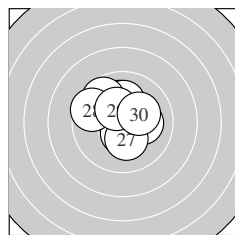

Serie 3:
 10.1 ↑ 10.5 * 10.1 ↑ 10.4 * 9.7 ↘
 10.1 → 10.2 * 9.6 ↖ 10.3 * 10.2 *
 beste Teiler 115.1 (22.) 142.3 (24.) 151.2 (29.)
 Trefferlage 0.07 mm links, 0.77 mm hoch
 Streuwert 1.51, horizontal: 1.61, vertikal: 1.40

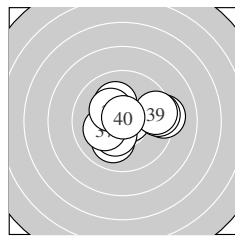

Serie 4:
 10.7 * 10.0 ↘ 9.2 → 10.3 * 9.4 →
 10.2 * 10.1 ← 10.3 * 9.5 → 10.8 *
 beste Teiler 39.4 (40.) 63.2 (31.) 158.4 (34.)
 Trefferlage 0.65 mm rechts, 0.11 mm hoch
 Streuwert 1.83, horizontal: 2.29, vertikal: 1.21

Unterschrift des Schützen

Meyton Elektronik

| | | | | | |
|--------------|--|---------|----|----|-------------|
| Ergebnis: | 350 | (369.4) | | | |
| Serien: | 90 | 86 | 89 | 85 | |
| Zähler: | 7 | 21 | 8 | 3 | 1 0 0 0 0 0 |
| Innenzehner: | 4 | | | | |
| weiteste: | 1003 (29), 871 (37), 832 (16) | | | | |
| beste Teiler | 68.8 (26.) 120.0 (20.) 122.3 (24.) | | | | |
| Trefferlage | 0.71 mm links, 0.26 mm hoch | | | | |
| Streuwert | 3.39, horizontal: 4.05, vertikal: 2.57 | | | | |

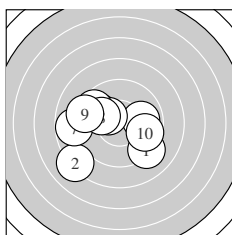
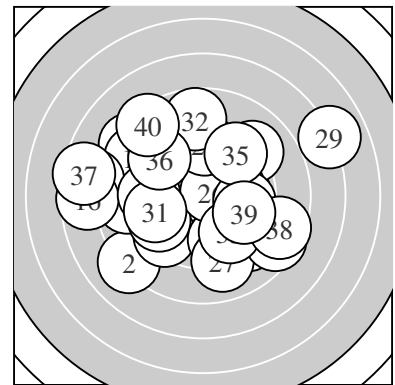

| | | | | | |
|--------------|--|-------|--------|-------|--------|
| Serie 1: | 9.1 ↘ | 8.1 ↙ | 9.9 → | 9.8 ↖ | 10.3 * |
| | 9.5 ↖ | 8.8 ← | 10.0 ↖ | 9.2 ↖ | 9.7 → |
| beste Teiler | 157.3 (5.) 232.1 (8.) 258.8 (3.) | | | | |
| Trefferlage | 1.52 mm links, 0.32 mm tief | | | | |
| Streuwert | 2.80, horizontal: 3.34, vertikal: 2.13 | | | | |

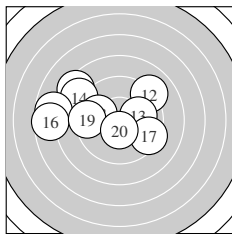

| | | | | | |
|--------------|--|-------|--------|-------|--------|
| Serie 2: | 8.4 ↖ | 9.1 ↗ | 10.0 → | 8.7 ↖ | 7.8 ← |
| | 7.6 ← | 9.4 ↘ | 9.9 ↖ | 9.4 ← | 10.5 * |
| beste Teiler | 120.0 (20.) 230.4 (13.) 265.1 (18.) | | | | |
| Trefferlage | 2.35 mm links, 0.88 mm hoch | | | | |
| Streuwert | 3.41, horizontal: 4.46, vertikal: 1.85 | | | | |

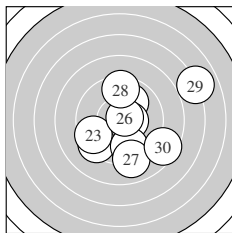

| | | | | | |
|--------------|--|-------|-------|--------|-------|
| Serie 3: | 10.0 ↗ | 9.4 ↙ | 9.5 ↙ | 10.5 * | 9.6 ↓ |
| | 10.7 * | 9.0 ↓ | 9.5 ↑ | 6.9 → | 8.5 ↘ |
| beste Teiler | 68.8 (26.) 122.3 (24.) 245.6 (21.) | | | | |
| Trefferlage | 1.41 mm rechts, 0.52 mm tief | | | | |
| Streuwert | 3.34, horizontal: 3.56, vertikal: 3.09 | | | | |

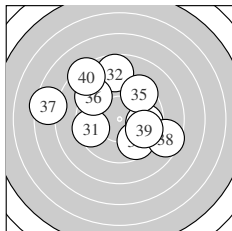

| | | | | | |
|--------------|--|-------|-------|-------|-------|
| Serie 4: | 9.5 ← | 8.7 ↑ | 9.7 ↘ | 9.8 → | 9.4 ↗ |
| | 9.3 ↖ | 7.5 ← | 8.6 ↘ | 9.7 → | 8.4 ↖ |
| beste Teiler | 300.9 (34.) 318.4 (39.) 324.4 (33.) | | | | |
| Trefferlage | 0.39 mm links, 1.03 mm hoch | | | | |
| Streuwert | 3.70, horizontal: 4.31, vertikal: 2.97 | | | | |

Unterschrift des Schützen

Ergebnis: **380** (400.1)
 Serien: 96 95 94 95
 Zähler: 22 16 2 0 0 0 0 0 0 0
 Innenzehner: 18
 weiteste: 591 (24), 555 (11), 443 (20)
 beste Teiler 10.7 (14.) 39.6 (2.) 67.2 (15.)
 Trefferlage 0.28 mm rechts, 0.12 mm hoch
 Streuwert 1.94, horizontal: 2.20, vertikal: 1.65

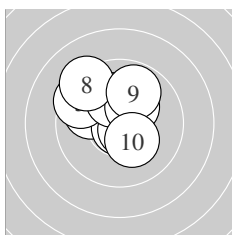
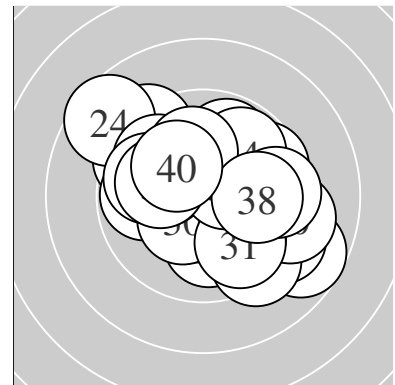

Serie 1:
 9.9 ↖ 10.8 * 10.6 * 10.7 * 9.5 ↖
 10.2 * 10.3 * 9.3 ↘ 9.8 ↗ 10.3 *
 beste Teiler 39.6 (2.) 68.7 (4.) 88.2 (3.)
 Trefferlage 0.46 mm links, 1.02 mm hoch
 Streuwert 1.57, horizontal: 1.67, vertikal: 1.46

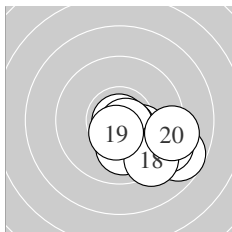

Serie 2:
 8.7 ↘ 10.2 * 10.6 * 10.9 * 10.7 *
 10.0 ↓ 9.2 ↘ 9.3 ↘ 10.5 * 9.2 →
 beste Teiler 10.7 (14.) 67.2 (15.) 94.1 (13.)
 Trefferlage 1.84 mm rechts, 1.45 mm tief
 Streuwert 1.54, horizontal: 1.92, vertikal: 1.04

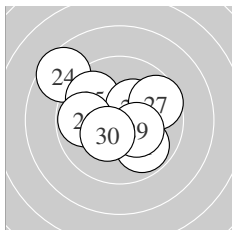

Serie 3:
 9.8 ↘ 10.5 * 10.6 * 8.6 ↖ 9.8 ↖
 10.3 * 9.6 ↗ 9.8 ← 10.3 * 10.4 *
 beste Teiler 94.2 (23.) 109.2 (22.) 150.8 (30.)
 Trefferlage 0.49 mm links, 0.28 mm hoch
 Streuwert 2.05, horizontal: 2.34, vertikal: 1.72

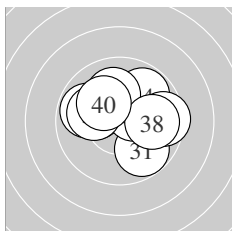

Serie 4:
 9.8 ↘ 10.1 ↖ 10.4 * 9.8 ↗ 10.1 ↗
 9.5 → 9.8 ↖ 9.9 → 10.1 ↖ 10.2 *
 beste Teiler 128.8 (33.) 196.2 (40.) 207.0 (32.)
 Trefferlage 0.25 mm rechts, 0.64 mm hoch
 Streuwert 1.81, horizontal: 2.23, vertikal: 1.27

Unterschrift des Schützen

Meyton Elektronik

Ergebnis: **383** (398.7)
 Serien: 96 95 96 96
 Zähler: 24 15 1 0 0 0 0 0 0 0
 Innenzehner: 16
 weiteste: 627 (9), 461 (30), 426 (15)
 beste Teiler 57.5 (33.) 97.7 (21.) 107.0 (19.)
 Trefferlage 0.07 mm rechts, 0.43 mm hoch
 Streuwert 1.92, horizontal: 2.30, vertikal: 1.45

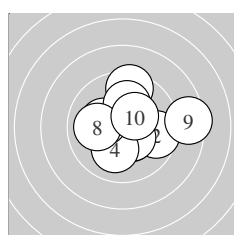
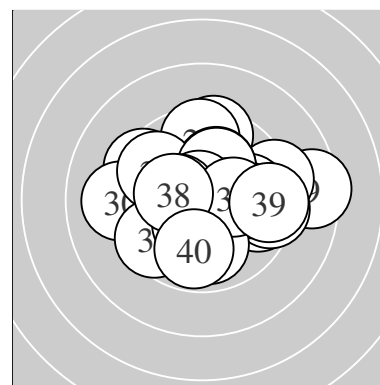

Serie 1:
 10.4 * 9.7 → 10.4 * 10.1 ↓ 9.5 ↑
 10.2 * 10.1 ↑ 10.0 ← 8.4 → 10.3 *
 beste Teiler 129.6 (1.) 131.6 (3.) 155.0 (10.)
 Trefferlage 0.84 mm rechts, 0.32 mm hoch
 Streuwert 2.11, horizontal: 2.47, vertikal: 1.68

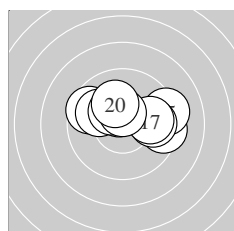

Serie 2:
 9.6 ↖ 10.5 * 10.0 ↖ 9.4 → 9.2 →
 9.8 → 9.9 → 10.3 * 10.5 * 10.1 ↖
 beste Teiler 107.0 (19.) 110.0 (12.) 159.0 (18.)
 Trefferlage 0.60 mm rechts, 0.87 mm hoch
 Streuwert 1.89, horizontal: 2.58, vertikal: 0.70

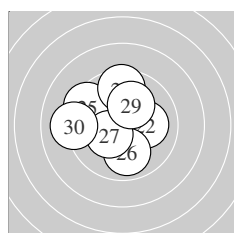

Serie 3:
 10.6 * 10.1 → 10.2 * 10.4 * 9.4 ↖
 9.9 ↓ 10.3 * 9.6 ↑ 10.1 ↑ 9.1 ←
 beste Teiler 97.7 (21.) 145.9 (24.) 153.1 (27.)
 Trefferlage 0.83 mm links, 0.68 mm hoch
 Streuwert 1.84, horizontal: 2.01, vertikal: 1.66

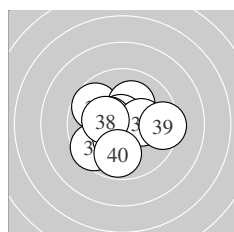

Serie 4:
 9.7 ↖ 10.1 ↑ 10.7 * 10.4 * 9.6 ↖
 10.4 * 10.2 * 10.3 * 9.4 → 9.8 ↓
 beste Teiler 57.5 (33.) 140.4 (34.) 149.1 (36.)
 Trefferlage 0.31 mm links, 0.15 mm tief
 Streuwert 1.78, horizontal: 2.01, vertikal: 1.52

Unterschrift des Schützen

Meyton Elektronik

Ergebnis: **388** (406.6)
 Serien: 97 98 98 95
 Zähler: 28 12 0 0 0 0 0 0 0 0
 Innenzehner: 23
 weiteste: 363 (18), 345 (40), 343 (10)
 beste Teiler 65.8 (37.) 73.9 (25.) 77.3 (15.)
 Trefferlage 0.21 mm links, 0.53 mm hoch
 Streuwert 1.49, horizontal: 1.55, vertikal: 1.43

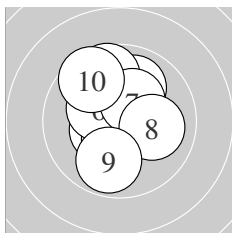
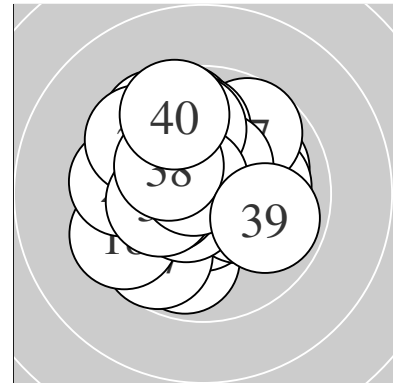

Serie 1:
 10.4 * 10.4 * 10.0 ↗ 9.7 ↑ 10.4 *
 10.3 * 10.3 * 10.1 → 9.8 ↓ 9.6 ↘
 beste Teiler 126.2 (5.) 132.8 (1.) 137.0 (2.)
 Trefferlage 0.10 mm links, 0.55 mm hoch
 Streuwert 1.63, horizontal: 1.37, vertikal: 1.86

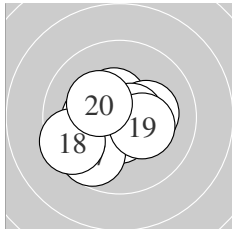

Serie 2:
 10.6 * 10.5 * 10.2 * 10.6 * 10.6 *
 10.3 * 9.7 ↙ 9.5 ↙ 10.3 * 10.3 *
 beste Teiler 77.3 (15.) 79.9 (14.) 92.1 (11.)
 Trefferlage 0.37 mm links, 0.34 mm tief
 Streuwert 1.40, horizontal: 1.64, vertikal: 1.11

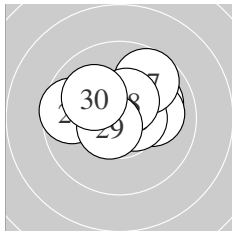

Serie 3:
 10.0 → 10.4 * 9.6 ← 10.1 → 10.7 *
 10.5 * 9.7 ↗ 10.5 * 10.6 * 10.1 ↘
 beste Teiler 73.9 (25.) 88.2 (29.) 101.0 (26.)
 Trefferlage 0.25 mm rechts, 0.71 mm hoch
 Streuwert 1.41, horizontal: 1.81, vertikal: 0.85

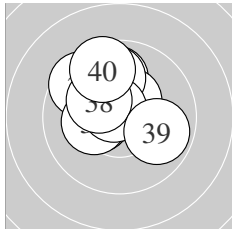

Serie 4:
 9.9 ↑ 9.6 ↘ 10.4 * 10.4 * 10.2 *
 9.9 ↑ 10.7 * 10.2 * 9.9 → 9.6 ↑
 beste Teiler 65.8 (37.) 128.9 (34.) 147.8 (33.)
 Trefferlage 0.63 mm links, 1.20 mm hoch
 Streuwert 1.44, horizontal: 1.44, vertikal: 1.45

Unterschrift des Schützen

Meyton Elektronik

Ergebnis: **388** (405.3)
 Serien: 96 98 98 96
 Zähler: 28 12 0 0 0 0 0 0 0 0
 Innenzehner: 24
 weiteste: 414 (19), 388 (5), 379 (8)
 beste Teiler 7.2 (12.) 67.4 (15.) 84.5 (23.)
 Trefferlage 0.13 mm rechts, 0.31 mm hoch
 Streuwert 1.63, horizontal: 1.67, vertikal: 1.59

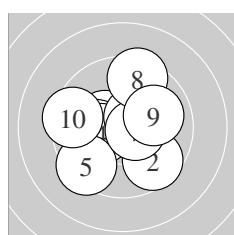
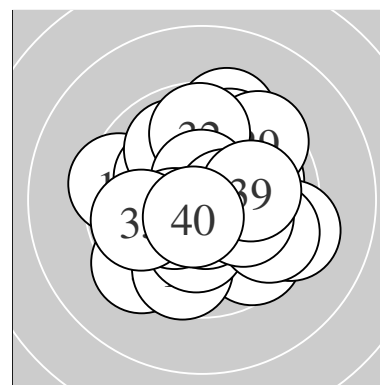

Serie 1:
 10.4 * 9.6 ↘ 10.2 * 10.3 * 9.4 ↙
 10.5 * 10.6 * 9.4 ↑ 10.0 → 9.4 ←
 beste Teiler 97.5 (7.) 114.0 (6.) 140.4 (1.)
 Trefferlage 0.38 mm links, 0.03 mm hoch
 Streuwert 1.97, horizontal: 2.13, vertikal: 1.81

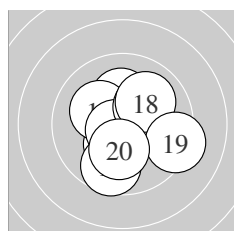

Serie 2:
 10.3 * 10.9 * 10.2 * 10.2 * 10.7 *
 10.2 * 9.7 ↓ 10.0 ↗ 9.3 → 10.2 *
 beste Teiler 7.2 (12.) 67.4 (15.) 162.0 (11.)
 Trefferlage 0.30 mm rechts, 0.23 mm tief
 Streuwert 1.66, horizontal: 1.63, vertikal: 1.69

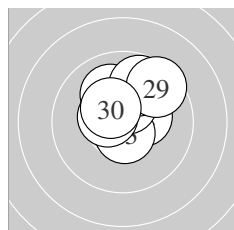

Serie 3:
 10.4 * 10.4 * 10.6 * 10.2 * 10.4 *
 10.1 ↖ 10.5 * 9.8 ↑ 9.5 ↗ 10.4 *
 beste Teiler 84.5 (23.) 117.9 (27.) 127.9 (21.)
 Trefferlage 0.36 mm rechts, 1.26 mm hoch
 Streuwert 1.14, horizontal: 1.17, vertikal: 1.11

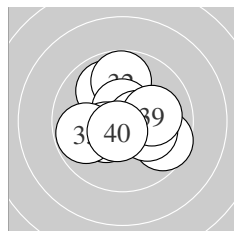

Serie 4:
 9.9 ↖ 9.8 ↑ 10.6 * 10.4 * 9.8 ←
 10.5 * 9.6 ↘ 10.2 * 10.1 → 10.6 *
 beste Teiler 85.4 (40.) 88.0 (33.) 107.0 (36.)
 Trefferlage 0.23 mm rechts, 0.18 mm hoch
 Streuwert 1.62, horizontal: 1.77, vertikal: 1.46

Unterschrift des Schützen

Meyton Elektronik

Ergebnis: **391** (409.7)
 Serien: 97 99 98 97
 Zähler: 32 7 1 0 0 0 0 0 0 0
 Innenzehner: 29
 weiteste: 678 (34), 375 (21), 358 (33)
 beste Teiler 34.3 (28.) 36.7 (22.) 39.2 (14.)
 Trefferlage 0.24 mm links, 0.21 mm tief
 Streuwert 1.52, horizontal: 1.75, vertikal: 1.24

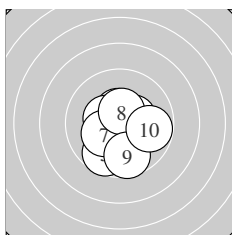
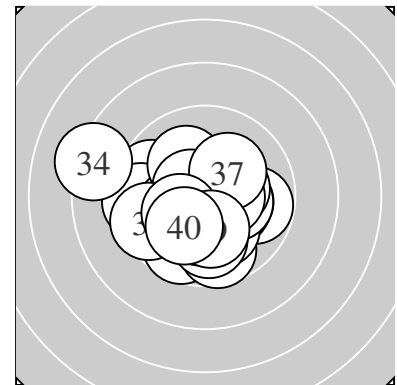

Serie 1:
 10.5 * 10.4 * 10.7 * 10.4 * 9.7 ↙
 10.4 * 10.2 * 10.5 * 9.7 ↓ 9.8 →
 beste Teiler 72.1 (3.) 113.6 (1.) 115.5 (8.)
 Trefferlage 0.12 mm rechts, 0.47 mm tief
 Streuwert 1.46, horizontal: 1.42, vertikal: 1.50

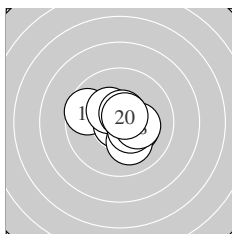

Serie 2:
 10.3 * 9.6 ↖ 10.6 * 10.8 * 10.4 *
 10.1 ↓ 10.4 * 10.2 * 10.6 * 10.6 *
 beste Teiler 39.2 (14.) 77.3 (20.) 79.6 (13.)
 Trefferlage 0.20 mm rechts, 0.04 mm hoch
 Streuwert 1.22, horizontal: 1.43, vertikal: 0.98

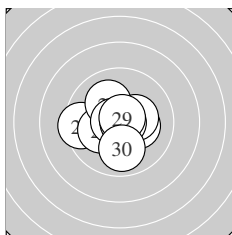

Serie 3:
 9.5 ↖ 10.8 * 10.3 * 10.2 * 10.3 *
 10.1 ↘ 10.7 * 10.8 * 10.8 * 9.9 ↓
 beste Teiler 34.3 (28.) 36.7 (22.) 48.8 (29.)
 Trefferlage 0.29 mm links, 0.10 mm tief
 Streuwert 1.38, horizontal: 1.62, vertikal: 1.10

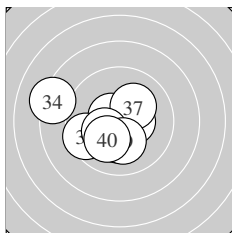

Serie 4:
 10.6 * 10.6 * 9.5 ↖ 8.2 ↖ 10.5 *
 10.2 * 10.2 * 10.3 * 10.2 * 10.1 ↙
 beste Teiler 91.2 (31.) 93.5 (32.) 123.1 (35.)
 Trefferlage 1.00 mm links, 0.34 mm tief
 Streuwert 1.96, horizontal: 2.38, vertikal: 1.44

Unterschrift des Schützen

Meyton Elektronik

Ergebnis: **375** (393.4)
 Serien: 91 94 94 96
 Zähler: 17 21 2 0 0 0 0 0 0 0
 Innenzehner: 11
 weiteste: 555 (3), 536 (10), 483 (16)
 beste Teiler 46.0 (39.) 69.2 (6.) 78.2 (15.)
 Trefferlage 0.26 mm links, 0.71 mm hoch
 Streuwert 2.15, horizontal: 2.49, vertikal: 1.73

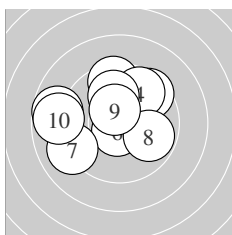
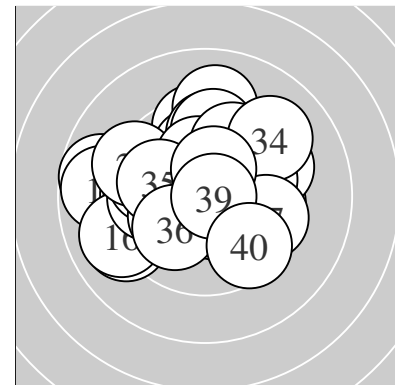

Serie 1:
 9.5 ↗ 9.5 ↑ 8.7 ← 9.7 ↗ 10.0 ↑
 10.7 * 9.1 ← 9.8 → 10.5 * 8.8 ←
 beste Teiler 69.2 (6.) 125.5 (9.) 246.0 (5.)
 Trefferlage 0.98 mm links, 0.98 mm hoch
 Streuwert 2.53, horizontal: 3.03, vertikal: 1.90

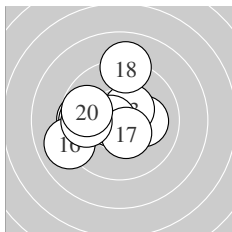

Serie 2:
 10.1 → 9.6 ← 10.5 * 9.7 ← 10.6 *
 9.0 ← 10.5 * 9.1 ↑ 9.8 ← 9.8 ←
 beste Teiler 78.2 (15.) 125.6 (13.) 125.6 (17.)
 Trefferlage 1.33 mm links, 0.30 mm hoch
 Streuwert 2.00, horizontal: 2.22, vertikal: 1.75

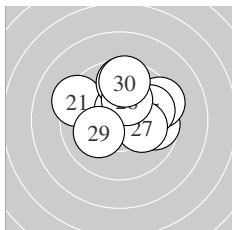

Serie 3:
 9.3 ↖ 9.7 → 9.4 ↗ 10.6 * 9.9 →
 9.6 ↑ 10.1 → 10.2 * 10.1 ← 9.6 ↑
 beste Teiler 94.0 (24.) 188.5 (28.) 203.4 (27.)
 Trefferlage 0.68 mm rechts, 1.14 mm hoch
 Streuwert 1.91, horizontal: 2.24, vertikal: 1.51

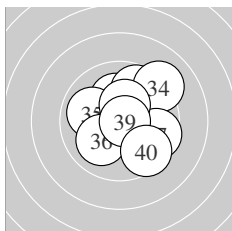

Serie 4:
 10.2 * 10.5 * 9.7 ↗ 9.1 ↗ 10.0 ←
 10.0 ↙ 9.6 → 10.4 * 10.8 * 9.6 ↘
 beste Teiler 46.0 (39.) 122.2 (32.) 148.9 (38.)
 Trefferlage 0.57 mm rechts, 0.42 mm hoch
 Streuwert 1.95, horizontal: 2.02, vertikal: 1.88

Unterschrift des Schützen

Meyton Elektronik

Ergebnis: **379** (397.2)
 Serien: 92 96 96 95
 Zähler: 22 15 3 0 0 0 0 0 0 0
 Innenzehner: 16
 weiteste: 678 (6), 589 (20), 527 (10)
 beste Teiler 19.9 (36.) 74.9 (40.) 76.0 (37.)
 Trefferlage 0.06 mm rechts, 0.11 mm hoch
 Streuwert 2.09, horizontal: 2.66, vertikal: 1.30

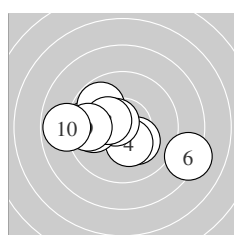
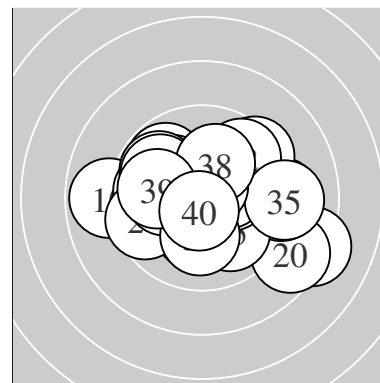

Serie 1:
 9.6 ← 10.2 * 9.8 ↘ 10.3 * 10.6 *
 8.2 → 9.9 ← 10.3 * 9.7 ← 8.8 ←
 beste Teiler 82.6 (5.) 152.2 (8.) 158.2 (4.)
 Trefferlage 1.06 mm links, 0.23 mm tief
 Streuwert 2.46, horizontal: 3.22, vertikal: 1.31

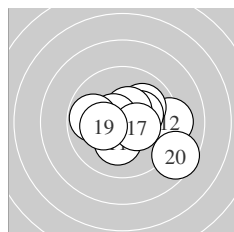

Serie 2:
 10.2 * 9.2 → 10.0 ↗ 10.3 * 10.5 *
 10.6 * 10.4 * 9.8 ← 10.2 * 8.6 →
 beste Teiler 96.1 (16.) 121.6 (15.) 141.0 (17.)
 Trefferlage 0.88 mm rechts, 0.16 mm tief
 Streuwert 2.02, horizontal: 2.51, vertikal: 1.38

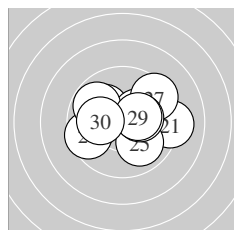

Serie 3:
 9.2 → 10.1 ↘ 10.3 * 9.6 ← 10.0 ↘
 9.8 ↘ 9.4 ↗ 10.3 * 10.3 * 10.1 ←
 beste Teiler 154.0 (29.) 161.9 (23.) 167.6 (28.)
 Trefferlage 0.40 mm rechts, 0.38 mm hoch
 Streuwert 2.04, horizontal: 2.58, vertikal: 1.27

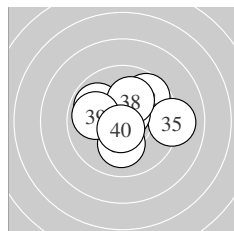

Serie 4:
 9.9 ↘ 9.7 ↗ 10.1 ↓ 9.9 ↘ 9.1 →
 10.9 * 10.6 * 10.1 ↑ 9.9 ← 10.7 *
 beste Teiler 19.9 (36.) 74.9 (40.) 76.0 (37.)
 Trefferlage 0.03 mm rechts, 0.48 mm hoch
 Streuwert 1.82, horizontal: 2.23, vertikal: 1.29

Unterschrift des Schützen

Meyton Elektronik

| | | | | | |
|--------------|--|---------|----|----|-------------|
| Ergebnis: | 361 | (379.0) | | | |
| Serien: | 88 | 92 | 90 | 91 | |
| Zähler: | 10 | 23 | 5 | 2 | 0 0 0 0 0 0 |
| Innenzehner: | 6 | | | | |
| weiteste: | 951 (2), 888 (10), 713 (21) | | | | |
| beste Teiler | 46.9 (31.) 92.0 (38.) 138.8 (6.) | | | | |
| Trefferlage | 0.75 mm links, 0.37 mm tief | | | | |
| Streuwert | 2.92, horizontal: 3.58, vertikal: 2.05 | | | | |

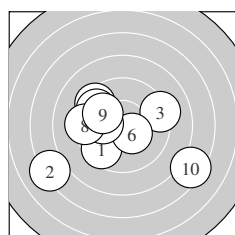
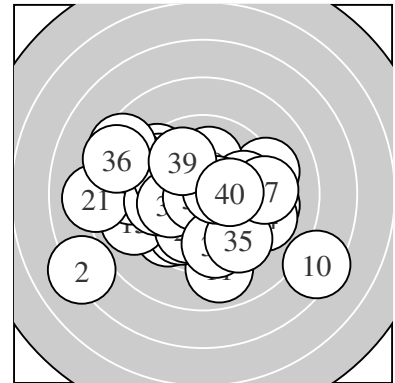

| | | | | | |
|--------------|--|--------|-------|-------|-------|
| Serie 1: | 9.6 ↙ | 7.1 ↙ | 9.2 → | 9.4 ↘ | 9.6 ↘ |
| | 10.4 * | 10.1 ← | 9.3 ← | 9.9 ↘ | 7.4 ↘ |
| beste Teiler | 138.8 (6.) 216.7 (7.) 256.0 (9.) | | | | |
| Trefferlage | 1.21 mm links, 0.59 mm tief | | | | |
| Streuwert | 3.65, horizontal: 4.42, vertikal: 2.67 | | | | |

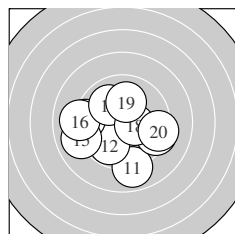

| | | | | | |
|--------------|--|--------|--------|--------|-------|
| Serie 2: | 8.9 ↓ | 9.8 ↙ | 9.3 ← | 9.4 → | 9.0 ← |
| | 9.1 ← | 10.0 ↘ | 10.4 * | 10.1 ↑ | 9.3 → |
| beste Teiler | 138.9 (18.) 225.3 (19.) 241.9 (17.) | | | | |
| Trefferlage | 0.59 mm links, 0.73 mm tief | | | | |
| Streuwert | 2.73, horizontal: 3.23, vertikal: 2.12 | | | | |

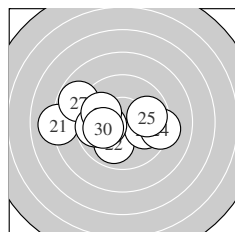

| | | | | | |
|--------------|--|-------|-------|-------|--------|
| Serie 3: | 8.1 ← | 9.9 ↙ | 9.9 → | 9.3 → | 9.8 → |
| | 10.2 * | 8.8 ↘ | 9.7 ← | 9.9 ↘ | 10.1 ← |
| beste Teiler | 183.5 (26.) 224.3 (30.) 252.9 (22.) | | | | |
| Trefferlage | 1.29 mm links, 0.16 mm tief | | | | |
| Streuwert | 2.64, horizontal: 3.52, vertikal: 1.24 | | | | |

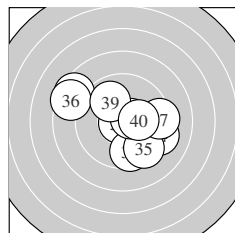

| | | | | | |
|--------------|--|-------|--------|-------|--------|
| Serie 4: | 10.8 * | 8.5 ↘ | 9.6 ↓ | 9.2 → | 9.4 ↘ |
| | 8.5 ↘ | 9.3 → | 10.6 * | 9.9 ↘ | 10.2 * |
| beste Teiler | 46.9 (31.) 92.0 (38.) 178.3 (40.) | | | | |
| Trefferlage | 0.10 mm rechts, 0.01 mm hoch | | | | |
| Streuwert | 2.88, horizontal: 3.44, vertikal: 2.17 | | | | |

Unterschrift des Schützen

Meyton Elektronik

Ergebnis: **375** (393.6)
 Serien: 94 93 94 94
 Zähler: 15 25 0 0 0 0 0 0 0 0
 Innenzehner: 12
 weiteste: 457 (1), 437 (20), 421 (40)
 beste Teiler 64.4 (33.) 105.6 (37.) 113.8 (8.)
 Trefferlage 0.46 mm rechts, 0.56 mm hoch
 Streuwert 2.05, horizontal: 1.83, vertikal: 2.26

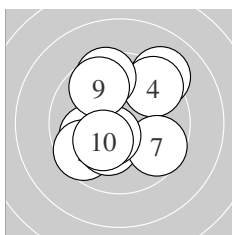
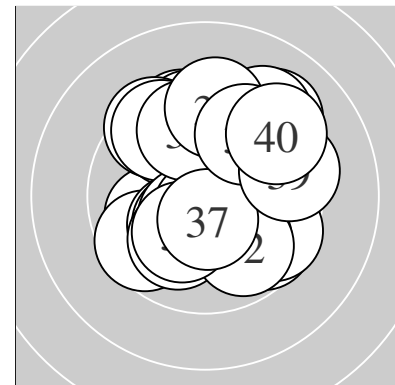

Serie 1:
 9.1 ↗ 10.0 ← 9.6 ↙ 9.5 ↗ 9.5 ↑
 10.2 * 9.7 ↘ 10.5 * 9.7 ↖ 10.2 *
 beste Teiler 113.8 (8.) 177.5 (10.) 182.9 (6.)
 Trefferlage 0.19 mm links, 0.38 mm hoch
 Streuwert 2.24, horizontal: 2.13, vertikal: 2.34

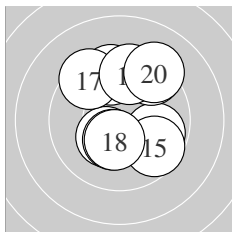

Serie 2:
 10.3 * 9.8 ↘ 10.3 * 9.6 ↑ 9.7 ↘
 9.3 ↗ 9.4 ↖ 10.3 * 9.6 ↑ 9.2 ↗
 beste Teiler 151.8 (18.) 153.7 (13.) 159.9 (11.)
 Trefferlage 0.60 mm rechts, 0.96 mm hoch
 Streuwert 2.20, horizontal: 1.81, vertikal: 2.52

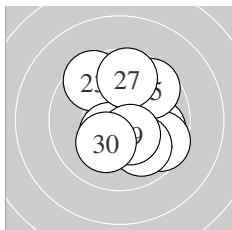

Serie 3:
 9.9 ↘ 10.0 ↑ 9.6 ↖ 9.6 ↘ 9.7 ↗
 10.5 * 9.7 ↑ 9.9 ↘ 10.4 * 10.2 *
 beste Teiler 120.2 (26.) 133.8 (29.) 193.4 (30.)
 Trefferlage 0.65 mm rechts, 0.29 mm hoch
 Streuwert 1.92, horizontal: 1.71, vertikal: 2.11

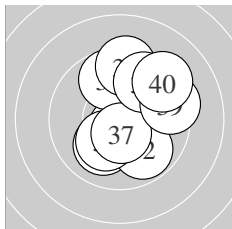

Serie 4:
 10.0 ↙ 9.8 ↘ 10.7 * 10.2 * 9.7 ↑
 9.4 ↑ 10.5 * 9.6 ↗ 9.4 → 9.3 ↗
 beste Teiler 64.4 (33.) 105.6 (37.) 190.5 (34.)
 Trefferlage 0.79 mm rechts, 0.60 mm hoch
 Streuwert 2.07, horizontal: 1.75, vertikal: 2.35

Unterschrift des Schützen

Meyton Elektronik

Ergebnis: **397** (418.0)
 Serien: 99 99 99 100
 Zähler: 37 3 0 0 0 0 0 0 0 0
 Innenzehner: 34
 weiteste: 361 (11), 298 (23), 257 (2)
 beste Teiler 9.8 (6.) 11.1 (9.) 31.0 (31.)
 Trefferlage 0.05 mm links, 0.03 mm hoch
 Streuwert 1.06, horizontal: 1.14, vertikal: 0.97

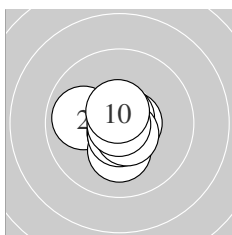
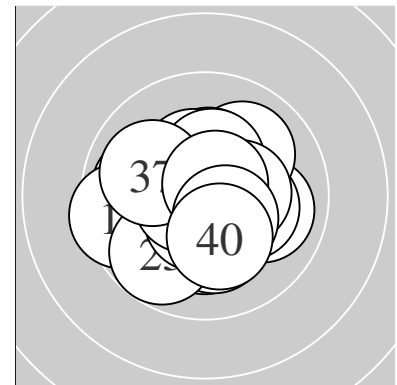

Serie 1:
 10.6 * 9.9 ← 10.7 * 10.2 * 10.8 *
 10.9 * 10.6 * 10.6 * 10.9 * 10.6 *
 beste Teiler 9.8 (6.) 11.1 (9.) 43.9 (5.)
 Trefferlage 0.13 mm links, 0.25 mm tief
 Streuwert 0.85, horizontal: 0.90, vertikal: 0.80

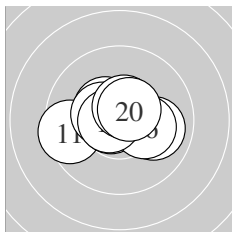

Serie 2:
 9.5 ← 10.7 * 10.0 → 10.6 * 10.4 *
 10.2 * 10.4 * 10.7 * 10.6 * 10.5 *
 beste Teiler 62.3 (12.) 72.2 (18.) 79.3 (14.)
 Trefferlage 0.11 mm links, 0.10 mm hoch
 Streuwert 1.27, horizontal: 1.69, vertikal: 0.63

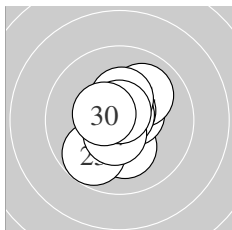

Serie 3:
 10.2 * 10.5 * 9.8 ↙ 10.0 ↗ 10.7 *
 10.8 * 10.6 * 10.4 * 10.7 * 10.5 *
 beste Teiler 41.6 (26.) 58.0 (29.) 72.9 (25.)
 Trefferlage 0.02 mm rechts, 0.05 mm hoch
 Streuwert 1.18, horizontal: 0.96, vertikal: 1.36

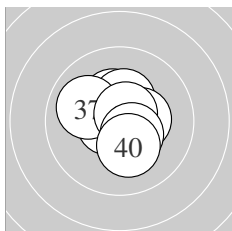

Serie 4:
 10.8 * 10.3 * 10.6 * 10.6 * 10.4 *
 10.4 * 10.0 ↖ 10.7 * 10.4 * 10.2 *
 beste Teiler 31.0 (31.) 67.4 (38.) 80.6 (33.)
 Trefferlage 0.00 mm , 0.23 mm hoch
 Streuwert 1.02, horizontal: 1.02, vertikal: 1.02

Unterschrift des Schützen

Meyton Elektronik

Ergebnis: **390** (406.5)
 Serien: 98 96 98 98
 Zähler: 30 10 0 0 0 0 0 0 0 0
 Innenzehner: 23
 weiteste: 465 (18), 410 (20), 374 (30)
 beste Teiler 21.4 (8.) 24.2 (25.) 92.5 (37.)
 Trefferlage 0.12 mm links, 0.20 mm tief
 Streuwert 1.58, horizontal: 1.56, vertikal: 1.59

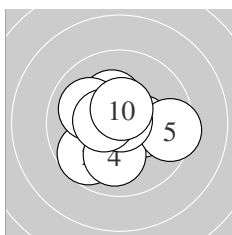
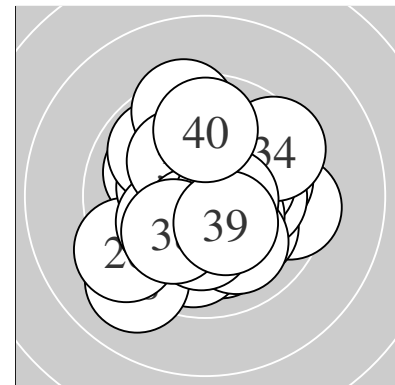

Serie 1:
 10.3 * 9.7 ↙ 10.3 * 10.0 ↓ 9.5 →
 10.6 * 10.0 ↖ 10.9 * 10.5 * 10.5 *
 beste Teiler 21.4 (8.) 98.8 (6.) 102.9 (10.)
 Trefferlage 0.19 mm links, 0.07 mm tief
 Streuwert 1.53, horizontal: 1.74, vertikal: 1.28

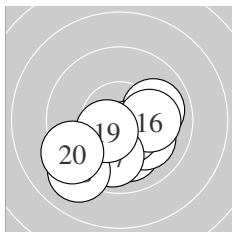

Serie 2:
 10.4 * 9.9 → 10.1 ↓ 10.1 ↘ 10.5 *
 10.1 → 9.9 ↓ 9.1 ↙ 10.5 * 9.3 ↖
 beste Teiler 107.2 (15.) 121.2 (19.) 135.8 (11.)
 Trefferlage 0.04 mm links, 1.42 mm tief
 Streuwert 1.67, horizontal: 1.99, vertikal: 1.28

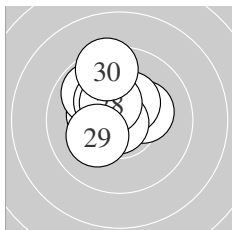

Serie 3:
 10.5 * 10.2 * 10.3 * 10.4 * 10.9 *
 9.9 ↖ 10.3 * 10.4 * 10.2 * 9.5 ↑
 beste Teiler 24.2 (25.) 118.0 (21.) 138.6 (28.)
 Trefferlage 0.67 mm links, 0.88 mm hoch
 Streuwert 1.22, horizontal: 1.12, vertikal: 1.32

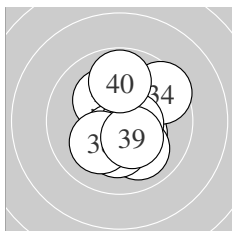

Serie 4:
 10.4 * 10.0 ↘ 10.2 * 9.5 ↗ 10.2 *
 10.5 * 10.6 * 10.1 ↙ 10.4 * 9.8 ↑
 beste Teiler 92.5 (37.) 111.8 (36.) 145.8 (31.)
 Trefferlage 0.41 mm rechts, 0.21 mm tief
 Streuwert 1.52, horizontal: 1.29, vertikal: 1.72

Unterschrift des Schützen

Meyton Elektronik

Ergebnis: **394** (411.5)
 Serien: 98 98 98 100
 Zähler: 34 6 0 0 0 0 0 0 0 0
 Innenzehner: 28
 weiteste: 328 (21), 305 (10), 305 (23)
 beste Teiler 46.6 (35.) 61.3 (36.) 63.5 (12.)
 Trefferlage 0.01 mm rechts, 0.11 mm hoch
 Streuwert 1.30, horizontal: 1.31, vertikal: 1.29

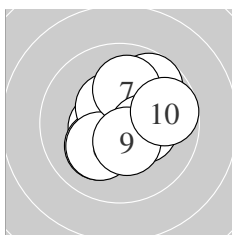
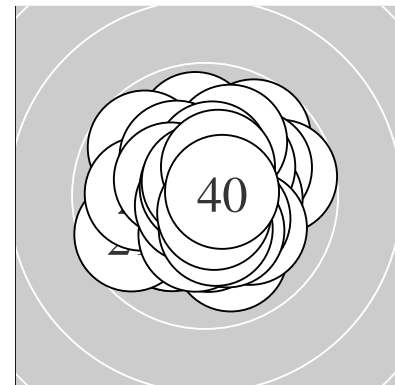

Serie 1:
 9.7 ↗ 10.7 * 10.5 * 10.1 ↘ 10.5 *
 10.2 * 10.0 ↑ 10.3 * 10.4 * 9.7 →
 beste Teiler 65.7 (2.) 117.1 (3.) 124.8 (5.)
 Trefferlage 0.26 mm rechts, 0.21 mm hoch
 Streuwert 1.46, horizontal: 1.49, vertikal: 1.42

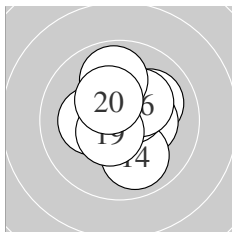

Serie 2:
 10.0 ↗ 10.7 * 10.3 * 9.9 ↘ 10.5 *
 10.3 * 9.9 ↑ 10.2 * 10.6 * 10.4 *
 beste Teiler 63.5 (12.) 100.1 (19.) 103.3 (15.)
 Trefferlage 0.36 mm rechts, 0.34 mm hoch
 Streuwert 1.29, horizontal: 1.21, vertikal: 1.36

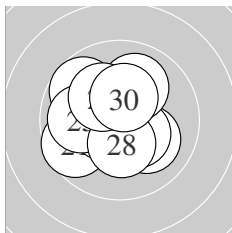

Serie 3:
 9.6 ↙ 10.1 ↘ 9.7 ↘ 10.5 * 10.0 ←
 10.4 * 10.0 ↑ 10.3 * 10.2 * 10.4 *
 beste Teiler 108.0 (24.) 143.6 (26.) 150.6 (30.)
 Trefferlage 0.56 mm links, 0.15 mm hoch
 Streuwert 1.58, horizontal: 1.67, vertikal: 1.48

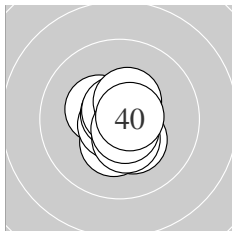

Serie 4:
 10.3 * 10.4 * 10.3 * 10.7 * 10.8 *
 10.7 * 10.4 * 10.5 * 10.6 * 10.7 *
 beste Teiler 46.6 (35.) 61.3 (36.) 64.4 (34.)
 Trefferlage 0.00 mm , 0.23 mm tief
 Streuwert 0.83, horizontal: 0.68, vertikal: 0.95

Unterschrift des Schützen

Ergebnis: **382** (400.2)
 Serien: 95 93 98 96
 Zähler: 23 16 1 0 0 0 0 0 0 0
 Innenzehner: 17
 weiteste: 510 (19), 484 (36), 413 (10)
 beste Teiler 52.1 (24.) 52.1 (37.) 63.6 (32.)
 Trefferlage 0.44 mm rechts, 0.40 mm tief
 Streuwert 1.83, horizontal: 2.12, vertikal: 1.48

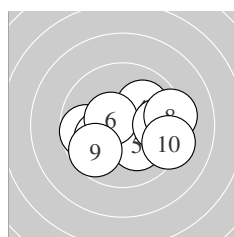
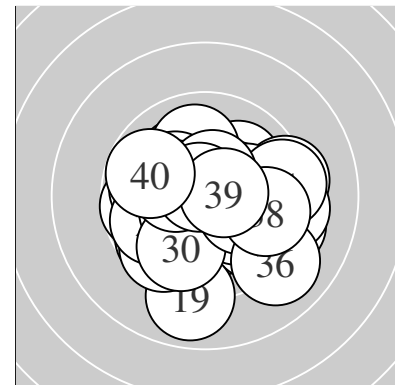

Serie 1:
 10.6 * 9.7 ← 10.1 ↙ 10.0 ↗ 10.2 *
 10.5 * 9.7 → 9.3 → 9.7 ↘ 9.3 ↘
 beste Teiler 90.5 (1.) 112.2 (6.) 199.0 (5.)
 Trefferlage 0.63 mm rechts, 0.31 mm tief
 Streuwert 2.02, horizontal: 2.59, vertikal: 1.20

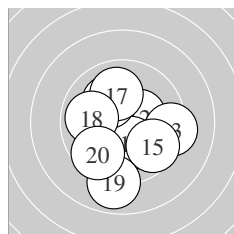

Serie 2:
 9.9 ↘ 10.4 * 9.3 → 10.2 * 9.7 ↘
 10.1 ↘ 10.0 ↑ 9.9 ← 8.9 ↓ 9.6 ↘
 beste Teiler 148.4 (12.) 189.4 (14.) 207.7 (16.)
 Trefferlage 0.37 mm rechts, 0.83 mm tief
 Streuwert 2.18, horizontal: 2.17, vertikal: 2.19

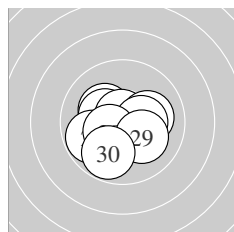

Serie 3:
 10.2 * 10.5 * 10.3 * 10.7 * 10.1 →
 9.8 ↙ 10.3 * 10.4 * 10.1 ↘ 9.8 ↘
 beste Teiler 52.1 (24.) 107.6 (22.) 132.8 (28.)
 Trefferlage 0.20 mm links, 0.42 mm tief
 Streuwert 1.37, horizontal: 1.60, vertikal: 1.10

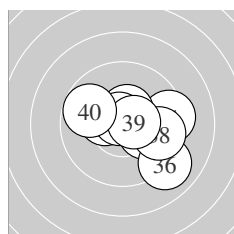

Serie 4:
 9.4 → 10.7 * 10.3 * 10.2 * 10.5 *
 9.0 ↘ 10.7 * 9.7 → 10.6 * 9.8 ↙
 beste Teiler 52.1 (37.) 63.6 (32.) 96.3 (39.)
 Trefferlage 0.96 mm rechts, 0.04 mm tief
 Streuwert 1.79, horizontal: 2.17, vertikal: 1.30

Unterschrift des Schützen

Meyton Elektronik

Ergebnis: **377** (395.5)
 Serien: 94 93 96 94
 Zähler: 18 21 1 0 0 0 0 0 0 0
 Innenzehner: 12
 weiteste: 560 (35), 479 (9), 443 (17)
 beste Teiler 65.3 (38.) 67.1 (3.) 102.2 (15.)
 Trefferlage 0.52 mm rechts, 0.55 mm hoch
 Streuwert 2.01, horizontal: 2.13, vertikal: 1.87

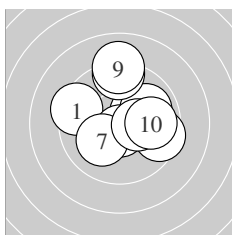
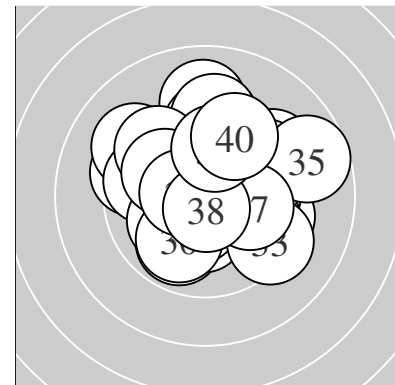

Serie 1:
 9.4 ↖ 10.3 * 10.7 * 9.9 ↗ 9.5 →
 9.2 ↑ 10.1 ↙ 10.3 * 9.0 ↑ 9.9 →
 beste Teiler 67.1 (3.) 154.7 (8.) 168.6 (2.)
 Trefferlage 0.59 mm rechts, 0.90 mm hoch
 Streuwert 2.12, horizontal: 2.13, vertikal: 2.12

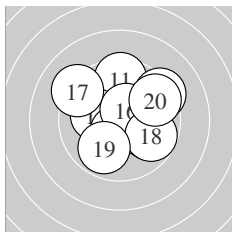

Serie 2:
 9.5 ↑ 9.3 ↗ 9.9 ↘ 10.1 ↖ 10.5 *
 10.5 * 9.2 ↘ 9.8 ↘ 9.9 ↙ 9.5 →
 beste Teiler 102.2 (15.) 107.7 (16.) 204.7 (14.)
 Trefferlage 0.50 mm rechts, 0.56 mm hoch
 Streuwert 2.19, horizontal: 2.40, vertikal: 1.96

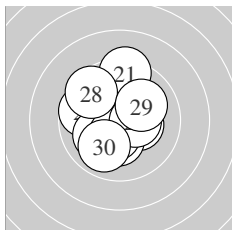

Serie 3:
 9.3 ↑ 10.3 * 9.7 ↖ 10.1 ↙ 10.3 *
 10.4 * 10.4 * 9.6 ↘ 10.0 ↗ 9.9 ↙
 beste Teiler 132.8 (26.) 135.2 (27.) 160.8 (22.)
 Trefferlage 0.38 mm links, 0.15 mm hoch
 Streuwert 1.86, horizontal: 1.72, vertikal: 1.99

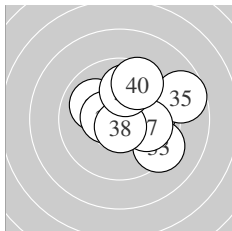

Serie 4:
 9.8 → 10.0 ↖ 9.3 ↘ 10.5 * 8.7 →
 10.5 * 10.0 → 10.7 * 9.9 ↑ 9.6 ↑
 beste Teiler 65.3 (38.) 114.8 (36.) 116.1 (34.)
 Trefferlage 1.36 mm rechts, 0.60 mm hoch
 Streuwert 1.92, horizontal: 2.18, vertikal: 1.62

Unterschrift des Schützen

Meyton Elektronik

Ergebnis: **379** (397.3)
 Serien: 94 96 94 95
 Zähler: 23 14 2 1 0 0 0 0 0 0
 Innenzehner: 16
 weiteste: 834 (22), 614 (17), 557 (8)
 beste Teiler 15.8 (39.) 58.3 (29.) 70.1 (11.)
 Trefferlage 0.83 mm rechts, 0.35 mm tief
 Streuwert 2.05, horizontal: 2.50, vertikal: 1.48

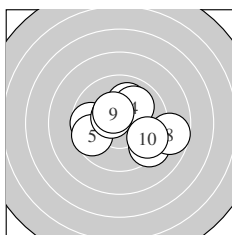
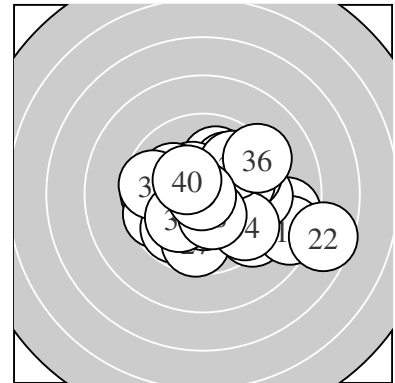

Serie 1:
 9.7 ← 10.5 * 10.0 ↑ 10.0 ↗ 9.6 ↖
 10.5 * 9.3 ↘ 8.7 → 10.4 * 9.6 ↘
 beste Teiler 108.7 (6.) 123.0 (2.) 134.9 (9.)
 Trefferlage 0.55 mm rechts, 0.02 mm hoch
 Streuwert 2.26, horizontal: 2.79, vertikal: 1.58

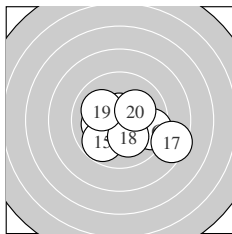

Serie 2:
 10.7 * 10.2 * 10.6 * 10.4 * 9.8 ↖
 9.5 → 8.5 ↘ 10.2 * 10.1 ↙ 10.2 *
 beste Teiler 70.1 (11.) 94.0 (13.) 126.1 (14.)
 Trefferlage 0.70 mm rechts, 0.69 mm tief
 Streuwert 1.96, horizontal: 2.46, vertikal: 1.29

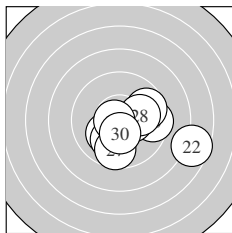

Serie 3:
 10.1 ↖ 7.6 → 9.5 → 10.4 * 9.7 →
 10.0 ↙ 9.7 ↓ 10.0 → 10.7 * 10.4 *
 beste Teiler 58.3 (29.) 136.9 (24.) 143.0 (30.)
 Trefferlage 1.45 mm rechts, 0.94 mm tief
 Streuwert 2.26, horizontal: 2.84, vertikal: 1.46

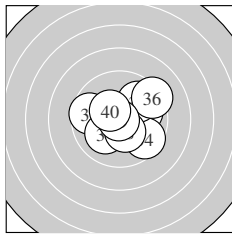

Serie 4:
 9.9 → 10.6 * 9.6 ← 9.6 ↘ 9.9 ↗
 9.3 ↗ 10.1 ↖ 10.4 * 10.9 * 10.4 *
 beste Teiler 15.8 (39.) 99.8 (32.) 139.6 (40.)
 Trefferlage 0.61 mm rechts, 0.20 mm hoch
 Streuwert 1.84, horizontal: 2.15, vertikal: 1.47

Unterschrift des Schützen

Meyton Elektronik

Ergebnis: **385** (405.5)
 Serien: 96 97 95 97
 Zähler: 26 13 1 0 0 0 0 0 0 0
 Innenzehner: 24
 weiteste: 501 (17), 461 (1), 405 (31)
 beste Teiler 37.6 (40.) 41.6 (5.) 51.0 (12.)
 Trefferlage 0.20 mm rechts, 0.43 mm hoch
 Streuwert 1.66, horizontal: 1.47, vertikal: 1.84

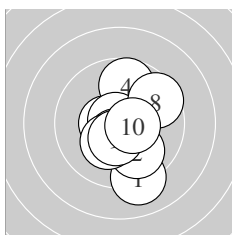
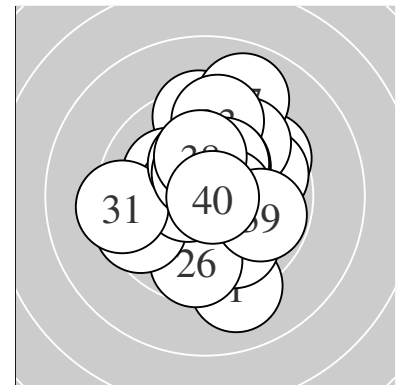

Serie 1:
 9.1 ↘ 9.9 ↘ 10.5 * 9.7 ↑ 10.8 *
 10.5 * 10.2 * 9.6 ↗ 10.5 * 10.5 *
 beste Teiler 41.6 (5.) 106.8 (10.) 107.0 (3.)
 Trefferlage 0.44 mm rechts, 0.54 mm tief
 Streuwert 1.72, horizontal: 1.27, vertikal: 2.07

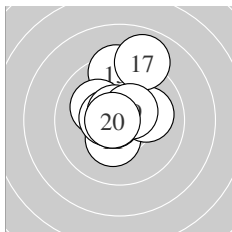

Serie 2:
 10.3 * 10.7 * 9.4 ↑ 10.1 ↖ 10.1 →
 10.5 * 8.9 ↑ 10.7 * 10.5 * 10.7 *
 beste Teiler 51.0 (12.) 58.0 (20.) 71.5 (18.)
 Trefferlage 0.02 mm links, 0.99 mm hoch
 Streuwert 1.58, horizontal: 1.25, vertikal: 1.86

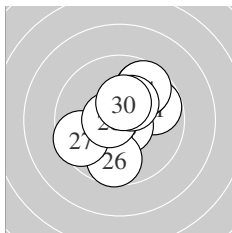

Serie 3:
 9.8 → 9.7 ↗ 10.7 * 9.7 ↗ 10.4 *
 9.7 ↓ 9.6 ↖ 10.6 * 10.3 * 10.4 *
 beste Teiler 67.8 (23.) 82.0 (28.) 132.2 (25.)
 Trefferlage 0.27 mm rechts, 0.31 mm hoch
 Streuwert 1.78, horizontal: 1.74, vertikal: 1.81

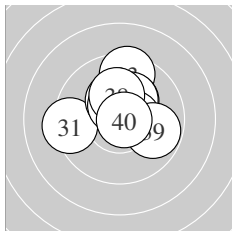

Serie 4:
 9.3 ← 10.3 * 9.5 ↑ 10.5 * 10.3 *
 10.2 * 10.5 * 10.2 * 9.8 → 10.8 *
 beste Teiler 37.6 (40.) 107.1 (37.) 116.0 (34.)
 Trefferlage 0.14 mm rechts, 0.97 mm hoch
 Streuwert 1.56, horizontal: 1.73, vertikal: 1.36

Unterschrift des Schützen

Meyton Elektronik