

Ergebnis: **391** (411.8)
 Serien: 98 98 96 99
 Zähler: 31 9 0 0 0 0 0 0 0 0
 Innenzehner: 28
 weiteste: 443 (29), 409 (37), 360 (2)
 beste Teiler 18.0 (33.) 30.0 (32.) 46.0 (12.)
 Trefferlage 0.03 mm rechts, 0.01 mm hoch
 Streuwert 1.42, horizontal: 1.43, vertikal: 1.40

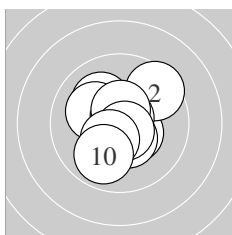

Serie 1:
 10.4 * 9.5 ↗ 10.4 * 10.1 ↘ 10.7 *
 10.1 ↖ 10.6 * 10.7 * 10.4 * 9.9 ↙
 beste Teiler 53.0 (5.) 69.3 (8.) 100.3 (7.)
 Trefferlage 0.00 mm , 0.03 mm hoch
 Streuwert 1.41, horizontal: 1.35, vertikal: 1.48

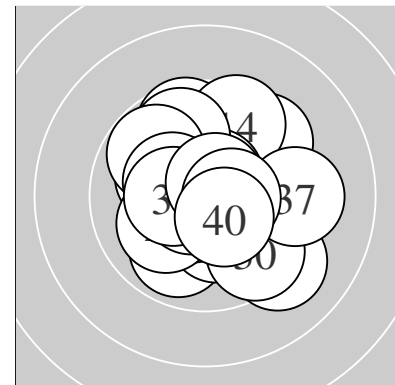
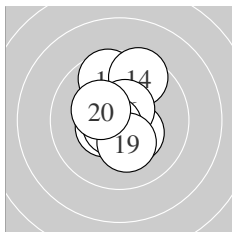

Serie 2:
 10.4 * 10.8 * 9.7 ↑ 9.5 ↗ 10.5 *
 10.6 * 10.5 * 10.7 * 10.2 * 10.3 *
 beste Teiler 46.0 (12.) 69.2 (18.) 92.5 (16.)
 Trefferlage 0.13 mm links, 0.46 mm hoch
 Streuwert 1.35, horizontal: 1.00, vertikal: 1.63

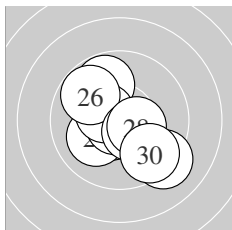

Serie 3:
 9.8 ↑ 10.6 * 10.1 ↙ 10.8 * 10.5 *
 9.8 ↖ 10.5 * 10.4 * 9.2 ↘ 9.6 ↙
 beste Teiler 48.9 (24.) 96.6 (22.) 123.0 (25.)
 Trefferlage 0.06 mm rechts, 0.41 mm tief
 Streuwert 1.78, horizontal: 1.81, vertikal: 1.75

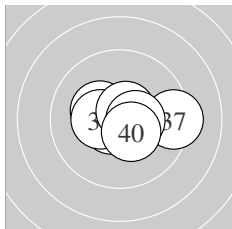

Serie 4:
 10.7 * 10.8 * 10.9 * 10.6 * 10.3 *
 10.4 * 9.3 → 10.6 * 10.5 * 10.4 *
 beste Teiler 18.0 (33.) 30.0 (32.) 74.3 (31.)
 Trefferlage 0.19 mm rechts, 0.02 mm tief
 Streuwert 1.21, horizontal: 1.65, vertikal: 0.46

Unterschrift des Schützen

Ergebnis: **390** (409.4)
 Serien: 94 99 98 99
 Zähler: 30 10 0 0 0 0 0 0 0 0
 Innenzehner: 23
 weiteste: 402 (20), 393 (40), 353 (6)
 beste Teiler 6.7 (26.) 44.7 (38.) 57.7 (34.)
 Trefferlage 0.31 mm rechts, 0.06 mm tief
 Streuwert 1.46, horizontal: 1.65, vertikal: 1.24

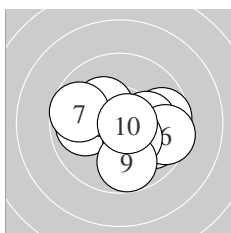
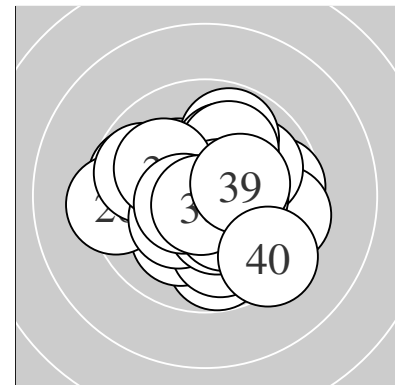

Serie 1:
 9.9 ↘ 9.9 ← 9.7 → 10.3 * 10.1 →
 9.5 → 9.7 ← 10.4 * 9.8 ↓ 10.7 *
 beste Teiler 58.1 (10.) 145.3 (8.) 173.2 (4.)
 Trefferlage 0.63 mm rechts, 0.36 mm tief
 Streuwert 1.81, horizontal: 2.27, vertikal: 1.20

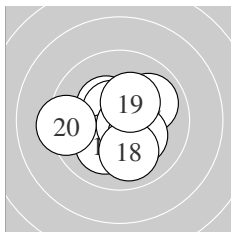

Serie 2:
 10.7 * 10.0 ↗ 10.4 * 10.6 * 10.1 ↘
 10.7 * 10.2 * 10.0 ↓ 10.3 * 9.3 ←
 beste Teiler 61.6 (11.) 62.6 (16.) 92.2 (14.)
 Trefferlage 0.10 mm links, 0.22 mm tief
 Streuwert 1.52, horizontal: 1.71, vertikal: 1.30

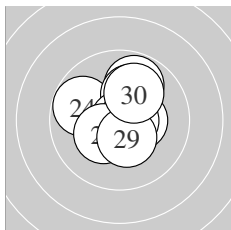

Serie 3:
 9.8 ↗ 10.4 * 10.7 * 9.8 ↖ 10.1 ↗
 10.9 * 10.7 * 10.3 * 10.4 * 10.0 ↗
 beste Teiler 6.7 (26.) 70.1 (27.) 70.7 (23.)
 Trefferlage 0.15 mm rechts, 0.58 mm hoch
 Streuwert 1.29, horizontal: 1.27, vertikal: 1.31

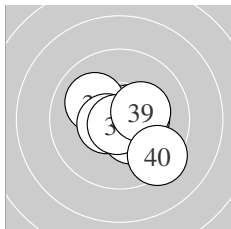

Serie 4:
 10.7 * 10.4 * 10.4 * 10.7 * 10.7 *
 10.1 ↖ 10.5 * 10.8 * 10.3 * 9.4 ↘
 beste Teiler 44.7 (38.) 57.7 (34.) 61.0 (31.)
 Trefferlage 0.56 mm rechts, 0.25 mm tief
 Streuwert 1.21, horizontal: 1.33, vertikal: 1.07

Unterschrift des Schützen

Meyton Elektronik

Ergebnis: **388** (403.6)
 Serien: 95 98 97 98
 Zähler: 28 12 0 0 0 0 0 0 0 0
 Innenzehner: 24
 weiteste: 497 (22), 493 (8), 469 (40)
 beste Teiler 31.1 (14.) 51.6 (26.) 79.2 (27.)
 Trefferlage 0.40 mm rechts, 0.66 mm hoch
 Streuwert 1.66, horizontal: 1.93, vertikal: 1.34

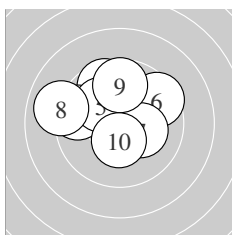
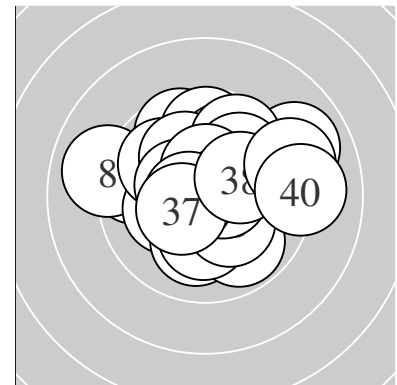

Serie 1:
 9.6 ↖ 9.5 ← 10.3 * 10.3 * 10.1 ↘
 9.5 ↗ 10.2 * 9.0 ← 9.7 ↑ 10.4 *
 beste Teiler 140.1 (10.) 153.4 (3.) 161.5 (4.)
 Trefferlage 0.56 mm links, 1.17 mm hoch
 Streuwert 1.94, horizontal: 2.36, vertikal: 1.41

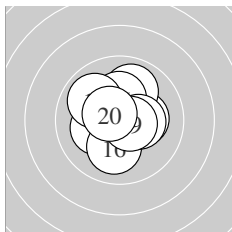

Serie 2:
 10.2 * 9.9 ↑ 10.2 * 10.8 * 10.3 *
 10.1 ↓ 10.3 * 9.9 ↘ 10.6 * 10.6 *
 beste Teiler 31.1 (14.) 88.8 (19.) 97.0 (20.)
 Trefferlage 0.02 mm links, 0.32 mm hoch
 Streuwert 1.31, horizontal: 1.31, vertikal: 1.31

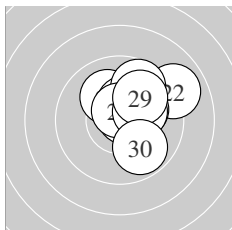

Serie 3:
 10.1 ↘ 9.0 ↗ 10.4 * 10.2 * 9.7 ↑
 10.7 * 10.6 * 10.2 * 10.0 ↗ 9.8 ↘
 beste Teiler 51.6 (26.) 79.2 (27.) 140.9 (23.)
 Trefferlage 1.24 mm rechts, 1.06 mm hoch
 Streuwert 1.42, horizontal: 1.45, vertikal: 1.39

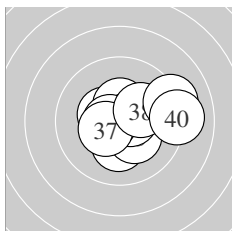

Serie 4:
 10.4 * 10.2 * 10.3 * 10.4 * 10.6 *
 10.6 * 10.4 * 10.2 * 9.2 → 9.1 →
 beste Teiler 79.4 (36.) 89.4 (35.) 128.0 (34.)
 Trefferlage 0.94 mm rechts, 0.09 mm hoch
 Streuwert 1.66, horizontal: 2.08, vertikal: 1.09

Unterschrift des Schützen

Ergebnis:	380	(398.1)
Serien:	93 96 97 94	
Zähler:	22 16 2 0 0 0 0 0 0 0	
Innenzehner:	17	
weiteste:	546 (8), 541 (5), 492 (11)	
beste Teiler	43.9 (16.) 47.5 (2.) 72.0 (20.)	
Trefferlage	0.98 mm links, 0.17 mm hoch	
Streuwert	1.91, horizontal: 1.74, vertikal: 2.06	

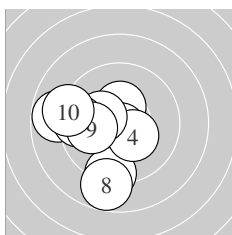
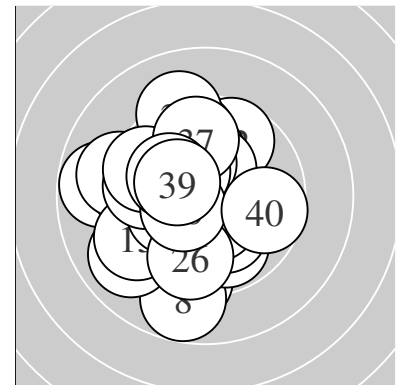

Serie 1:

10.4 *	10.8 *	9.2 ↓	10.3 *	8.8 ←
10.3 *	9.5 ←	8.8 ↓	10.0 ←	9.1 ←
beste Teiler	47.5 (2.) 141.0 (1.) 158.4 (4.)			
Trefferlage	1.81 mm links, 0.78 mm tief			
Streuwert	2.21, horizontal: 2.12, vertikal: 2.28			

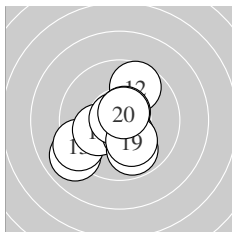

Serie 2:

9.0 ↙	9.7 ↗	9.3 ↙	10.1 ↙	10.4 *
10.8 *	10.6 *	9.8 ↓	10.1 ↓	10.7 *
beste Teiler	43.9 (16.) 72.0 (20.) 82.1 (17.)			
Trefferlage	0.47 mm links, 0.72 mm tief			
Streuwert	1.88, horizontal: 1.95, vertikal: 1.82			

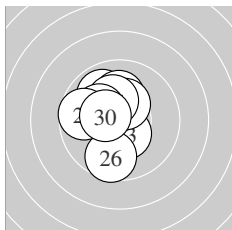

Serie 3:

9.9 ↘	10.6 *	10.4 *	10.1 ↑	10.4 *
9.6 ↓	10.2 *	10.2 *	9.7 ←	10.4 *
beste Teiler	95.8 (22.) 128.4 (23.) 129.6 (30.)			
Trefferlage	0.82 mm links, 0.57 mm hoch			
Streuwert	1.40, horizontal: 1.12, vertikal: 1.64			

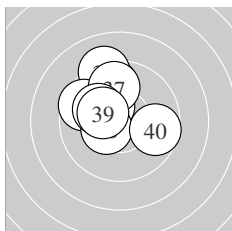

Serie 4:

9.7 ↑	9.8 ↑	9.2 ↑	9.6 ↖	10.3 *
10.4 *	9.8 ↑	10.1 ↖	10.3 *	9.7 →
beste Teiler	131.2 (36.) 159.0 (35.) 162.3 (39.)			
Trefferlage	0.85 mm links, 1.61 mm hoch			
Streuwert	1.62, horizontal: 1.59, vertikal: 1.65			

Unterschrift des Schützen

Meyton Elektronik

Ergebnis: **376** (393.3)
 Serien: 93 96 92 95
 Zähler: 20 16 4 0 0 0 0 0 0 0
 Innenzehner: 14
 weiteste: 678 (29), 545 (27), 532 (9)
 beste Teiler 60.7 (33.) 85.4 (6.) 91.0 (20.)
 Trefferlage 0.16 mm links, 0.44 mm hoch
 Streuwert 2.25, horizontal: 2.69, vertikal: 1.69

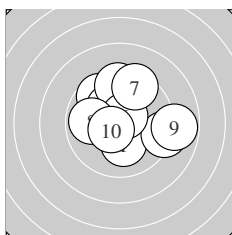
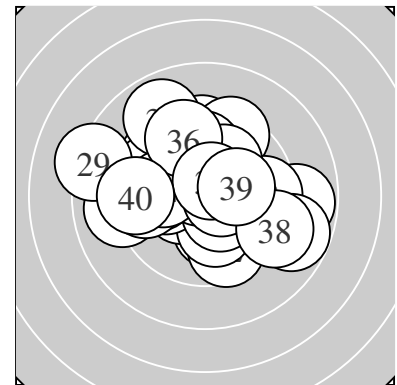

Serie 1:
 10.2 * 9.2 → 9.7 ↖ 10.2 * 9.5 ↑
 10.6 * 9.4 ↗ 9.9 ← 8.8 → 10.5 *
 beste Teiler 85.4 (6.) 102.8 (10.) 182.0 (4.)
 Trefferlage 0.53 mm rechts, 0.81 mm hoch
 Streuwert 2.28, horizontal: 2.57, vertikal: 1.94

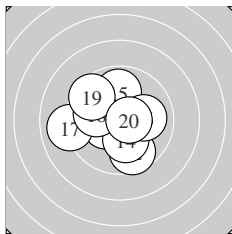

Serie 2:
 10.4 * 9.6 ↓ 10.4 * 10.2 * 9.9 ↑
 10.0 → 9.0 ← 10.0 ← 9.6 ↖ 10.6 *
 beste Teiler 91.0 (20.) 146.4 (13.) 146.7 (11.)
 Trefferlage 0.47 mm links, 0.03 mm tief
 Streuwert 2.00, horizontal: 2.24, vertikal: 1.71

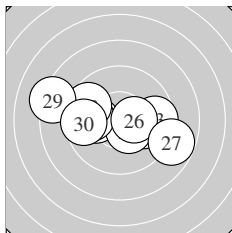

Serie 3:
 10.0 → 10.0 ← 9.6 → 10.4 * 9.9 ←
 10.4 * 8.8 → 9.6 ↖ 8.2 ↖ 9.6 ←
 beste Teiler 133.1 (24.) 141.0 (26.) 228.0 (22.)
 Trefferlage 0.49 mm links, 0.01 mm tief
 Streuwert 2.69, horizontal: 3.63, vertikal: 1.14

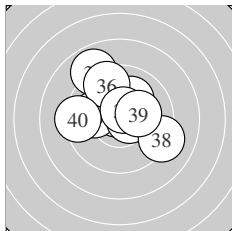

Serie 4:
 10.1 ↗ 8.9 ↖ 10.7 * 10.0 ← 10.6 *
 9.5 ↖ 10.6 * 9.2 → 10.2 * 9.3 ←
 beste Teiler 60.7 (33.) 94.1 (37.) 95.6 (35.)
 Trefferlage 0.23 mm links, 1.01 mm hoch
 Streuwert 2.14, horizontal: 2.40, vertikal: 1.84

Unterschrift des Schützen

Meyton Elektronik

Ergebnis: **375** (392.1)
 Serien: 91 95 97 92
 Zähler: 19 17 4 0 0 0 0 0 0
 Innenzehner: 11
 weiteste: 730 (3), 631 (33), 555 (4)
 beste Teiler 37.4 (19.) 86.4 (36.) 87.0 (15.)
 Trefferlage 0.35 mm rechts, 0.03 mm hoch
 Streuwert 2.30, horizontal: 2.71, vertikal: 1.81

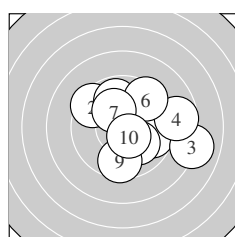
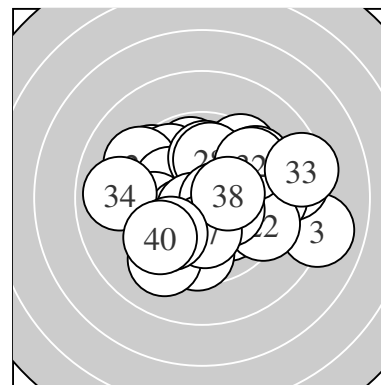

Serie 1:
 9.7 → 9.4 ↖ 8.0 → 8.7 → 9.8 ↑
 9.5 ↗ 10.2 * 10.1 ↘ 9.6 ↓ 10.5 *
 beste Teiler 109.8 (10.) 190.5 (7.) 224.1 (8.)
 Trefferlage 1.51 mm rechts, 0.15 mm hoch
 Streuwert 2.67, horizontal: 3.07, vertikal: 2.19

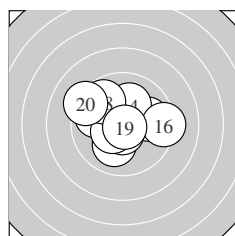

Serie 2:
 9.8 ↖ 9.9 → 10.1 ↓ 10.1 ↑ 10.6 *
 9.3 → 10.4 * 9.8 ↖ 10.8 * 9.2 ↖
 beste Teiler 37.4 (19.) 87.0 (15.) 126.0 (17.)
 Trefferlage 0.26 mm links, 0.36 mm hoch
 Streuwert 1.96, horizontal: 2.37, vertikal: 1.44

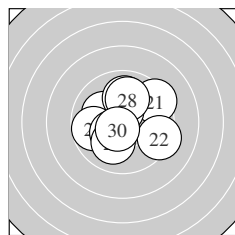

Serie 3:
 9.4 ↗ 9.3 → 10.5 * 10.1 ↖ 9.7 ←
 10.3 * 10.0 ↑ 10.0 ↑ 10.1 ↓ 10.6 *
 beste Teiler 88.6 (30.) 114.2 (23.) 154.1 (26.)
 Trefferlage 0.00 mm , 0.29 mm hoch
 Streuwert 1.91, horizontal: 2.10, vertikal: 1.70

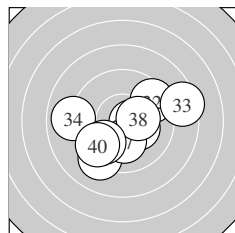

Serie 4:
 9.2 ↓ 9.5 ↗ 8.4 → 8.9 ← 10.3 *
 10.6 * 10.1 ↓ 10.3 * 9.8 ↙ 9.5 ↙
 beste Teiler 86.4 (36.) 160.1 (38.) 173.1 (35.)
 Trefferlage 0.14 mm rechts, 0.68 mm tief
 Streuwert 2.62, horizontal: 3.20, vertikal: 1.88

Unterschrift des Schützen

Meyton Elektronik

Ergebnis: **365** (382.1)
 Serien: 90 93 90 92
 Zähler: 14 19 5 2 0 0 0 0 0 0
 Innenzehner: 8
 weiteste: 973 (19), 848 (32), 668 (7)
 beste Teiler 71.7 (14.) 101.3 (37.) 134.1 (40.)
 Trefferlage 0.29 mm links, 0.44 mm hoch
 Streuwert 2.85, horizontal: 3.32, vertikal: 2.29

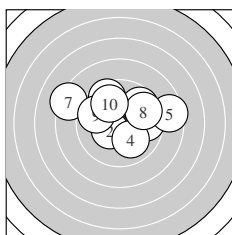
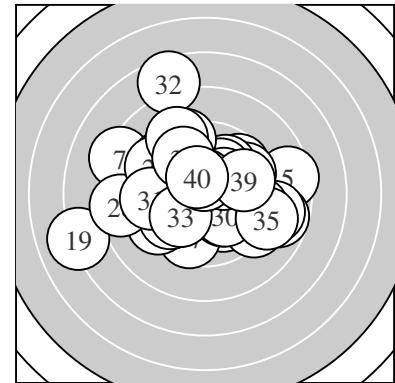

Serie 1:
 9.7 → 10.4 * 9.6 ↖ 10.0 ↘ 8.5 →
 9.7 ↗ 8.3 ↙ 9.7 ↗ 9.8 ↖ 9.9 ↖
 beste Teiler 144.6 (2.) 235.2 (4.) 266.5 (10.)
 Trefferlage 0.29 mm rechts, 1.12 mm hoch
 Streuwert 2.74, horizontal: 3.53, vertikal: 1.60

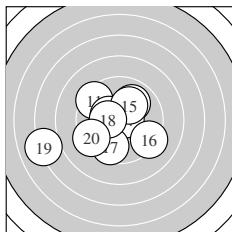

Serie 2:
 9.4 ↖ 10.4 * 10.0 ↗ 10.7 * 10.1 ↗
 9.3 ↘ 9.6 ↓ 10.4 * 7.1 ← 9.3 ↖
 beste Teiler 71.7 (14.) 141.2 (18.) 144.4 (12.)
 Trefferlage 1.26 mm links, 0.38 mm tief
 Streuwert 2.92, horizontal: 3.51, vertikal: 2.17

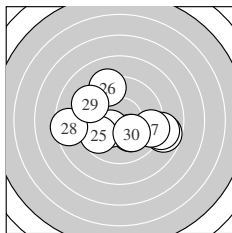

Serie 3:
 10.1 ↘ 8.7 → 10.4 * 8.9 → 9.7 ↖
 9.3 ↖ 9.4 → 8.5 ← 9.3 ↖ 10.1 ↘
 beste Teiler 150.6 (23.) 201.7 (21.) 212.9 (30.)
 Trefferlage 0.20 mm rechts, 0.48 mm tief
 Streuwert 3.00, horizontal: 3.80, vertikal: 1.88

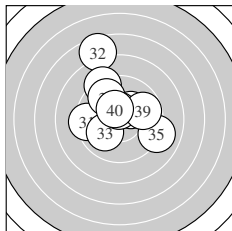

Serie 4:
 9.4 ← 7.6 ↖ 10.0 ↙ 9.1 ↖ 9.0 →
 10.3 * 10.5 * 9.7 ↖ 9.8 → 10.4 *
 beste Teiler 101.3 (37.) 134.1 (40.) 173.5 (36.)
 Trefferlage 0.39 mm links, 1.53 mm hoch
 Streuwert 2.75, horizontal: 2.59, vertikal: 2.89

Unterschrift des Schützen

Meyton Elektronik

Ergebnis: **380** (398.3)
 Serien: 94 98 95 93
 Zähler: 23 14 3 0 0 0 0 0 0 0
 Innenzehner: 16
 weiteste: 665 (5), 635 (9), 511 (31)
 beste Teiler 16.6 (8.) 27.2 (26.) 74.0 (20.)
 Trefferlage 0.09 mm links, 0.49 mm tief
 Streuwert 2.02, horizontal: 2.24, vertikal: 1.77

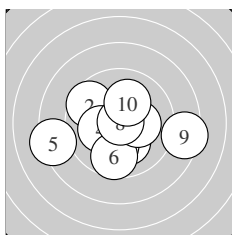
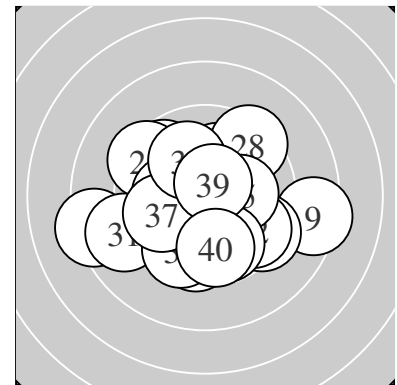

Serie 1:
 10.2 * 9.6 ↖ 10.1 ↓ 10.2 * 8.3 ←
 9.7 ↓ 10.3 * 10.9 * 8.4 → 10.1 ↑
 beste Teiler 16.6 (8.) 175.1 (7.) 186.9 (4.)
 Trefferlage 0.24 mm links, 0.69 mm tief
 Streuwert 2.59, horizontal: 3.26, vertikal: 1.68

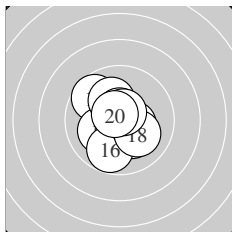

Serie 2:
 9.7 ↖ 10.1 ↗ 10.2 * 10.1 ↖ 10.6 *
 9.8 ↓ 10.4 * 10.1 ↘ 10.6 * 10.7 *
 beste Teiler 74.0 (20.) 82.3 (19.) 85.0 (15.)
 Trefferlage 0.18 mm links, 0.07 mm tief
 Streuwert 1.46, horizontal: 1.35, vertikal: 1.57

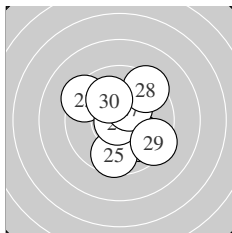

Serie 3:
 10.4 * 10.4 * 9.4 ↖ 9.9 ↘ 9.6 ↓
 10.8 * 10.3 * 9.4 ↗ 9.4 ↘ 10.1 ↖
 beste Teiler 27.2 (26.) 130.6 (22.) 140.2 (21.)
 Trefferlage 0.51 mm rechts, 0.12 mm tief
 Streuwert 2.00, horizontal: 1.92, vertikal: 2.08

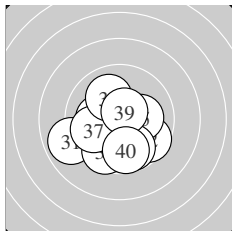

Serie 4:
 8.9 ← 9.6 ↘ 9.6 ↓ 10.2 * 10.2 *
 9.8 ↓ 9.9 ← 10.0 ↖ 10.6 * 9.7 ↓
 beste Teiler 87.1 (39.) 198.2 (34.) 199.4 (35.)
 Trefferlage 0.45 mm links, 1.07 mm tief
 Streuwert 2.03, horizontal: 2.26, vertikal: 1.76

Unterschrift des Schützen

Meyton Elektronik

Ergebnis: **384** (401.9)
 Serien: 97 96 95 96
 Zähler: 25 14 1 0 0 0 0 0 0 0
 Innenzehner: 18
 weiteste: 518 (30), 469 (11), 439 (38)
 beste Teiler 45.8 (4.) 50.0 (17.) 55.5 (10.)
 Trefferlage 0.16 mm links, 0.22 mm tief
 Streuwert 1.80, horizontal: 1.84, vertikal: 1.76

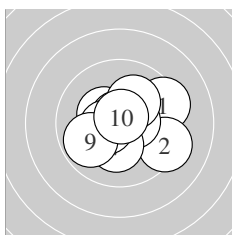
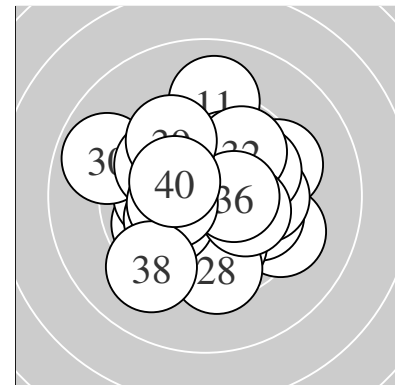

Serie 1:
 9.4 ↗ 9.3 ↘ 10.4 * 10.8 * 10.5 *
 10.1 ↖ 10.2 * 10.5 * 9.9 ↙ 10.7 *
 beste Teiler 45.8 (4.) 55.5 (10.) 112.8 (5.)
 Trefferlage 0.45 mm rechts, 0.01 mm tief
 Streuwert 1.68, horizontal: 1.99, vertikal: 1.28

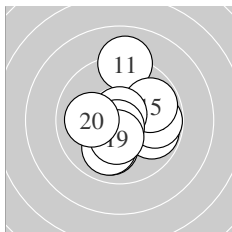

Serie 2:
 9.1 ↑ 10.0 ↓ 9.8 ↘ 9.8 → 9.8 ↗
 10.0 ↓ 10.8 * 10.7 * 10.4 * 10.0 ←
 beste Teiler 50.0 (17.) 60.7 (18.) 141.2 (19.)
 Trefferlage 0.42 mm rechts, 0.10 mm tief
 Streuwert 1.88, horizontal: 1.73, vertikal: 2.03

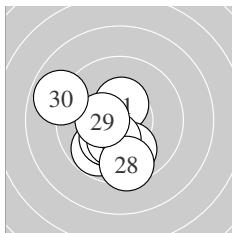

Serie 3:
 10.4 * 9.8 ↙ 9.9 ↓ 10.2 * 10.2 *
 10.2 * 10.3 * 9.5 ↓ 10.4 * 8.9 ↖
 beste Teiler 129.8 (21.) 143.0 (29.) 165.1 (27.)
 Trefferlage 1.00 mm links, 1.12 mm tief
 Streuwert 1.64, horizontal: 1.60, vertikal: 1.69

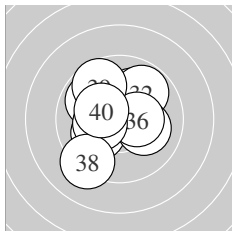

Serie 4:
 10.1 ↖ 9.8 ↗ 10.1 ↙ 10.1 ↘ 9.9 ↖
 10.4 * 10.3 * 9.2 ↙ 9.7 ↘ 10.3 *
 beste Teiler 143.0 (36.) 165.9 (37.) 165.9 (40.)
 Trefferlage 0.51 mm links, 0.33 mm hoch
 Streuwert 1.86, horizontal: 1.84, vertikal: 1.88

Unterschrift des Schützen

Meyton Elektronik

Ergebnis: **396** (411.3)
 Serien: 99 100 97 100
 Zähler: 36 4 0 0 0 0 0 0 0 0
 Innenzehner: 27
 weiteste: 371 (28), 346 (7), 338 (27)
 beste Teiler 18.0 (24.) 41.4 (14.) 53.1 (20.)
 Trefferlage 0.25 mm links, 0.38 mm hoch
 Streuwert 1.29, horizontal: 1.24, vertikal: 1.35

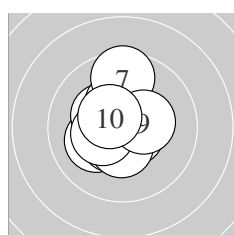
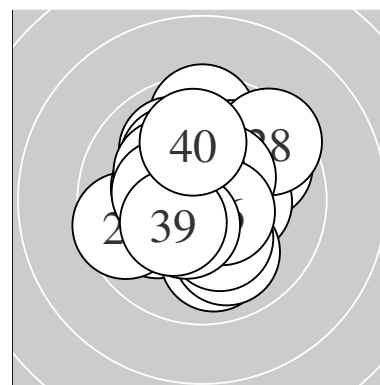

Serie 1:
 10.1 ↙ 10.5 * 10.3 * 10.6 * 10.3 *
 10.4 * 9.6 ↑ 10.4 * 10.4 * 10.5 *
 beste Teiler 81.5 (4.) 116.5 (10.) 118.2 (2.)
 Trefferlage 0.46 mm links, 0.29 mm hoch
 Streuwert 1.25, horizontal: 1.02, vertikal: 1.45

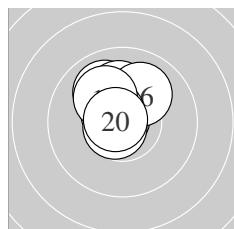

Serie 2:
 10.5 * 10.0 ↘ 10.1 ↑ 10.8 * 10.4 *
 10.0 ↗ 10.6 * 10.7 * 10.1 ↖ 10.7 *
 beste Teiler 41.4 (14.) 53.1 (20.) 64.3 (18.)
 Trefferlage 0.46 mm links, 1.08 mm hoch
 Streuwert 0.79, horizontal: 0.68, vertikal: 0.88

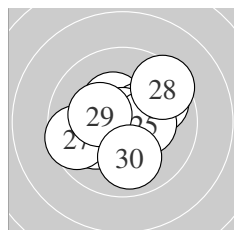

Serie 3:
 10.4 * 9.8 ↗ 10.4 * 10.9 * 10.3 *
 10.1 ↙ 9.6 ↖ 9.5 ↗ 10.3 * 10.0 ↓
 beste Teiler 18.0 (24.) 138.9 (23.) 144.0 (21.)
 Trefferlage 0.11 mm rechts, 0.17 mm hoch
 Streuwert 1.71, horizontal: 1.96, vertikal: 1.42

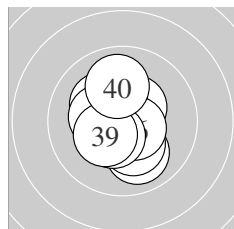

Serie 4:
 10.2 * 10.0 ↓ 10.3 * 10.4 * 10.4 *
 10.6 * 10.3 * 10.5 * 10.3 * 10.0 ↑
 beste Teiler 96.0 (36.) 125.1 (38.) 128.8 (34.)
 Trefferlage 0.22 mm links, 0.01 mm tief
 Streuwert 1.27, horizontal: 1.02, vertikal: 1.47

Unterschrift des Schützen

Meyton Elektronik

Ergebnis: **380** (400.3)
 Serien: 94 96 95 95
 Zähler: 21 18 1 0 0 0 0 0 0 0
 Innenzehner: 15
 weiteste: 571 (10), 457 (2), 436 (28)
 beste Teiler 20.0 (11.) 38.2 (15.) 70.3 (1.)
 Trefferlage 0.21 mm rechts, 0.23 mm hoch
 Streuwert 1.88, horizontal: 1.96, vertikal: 1.79

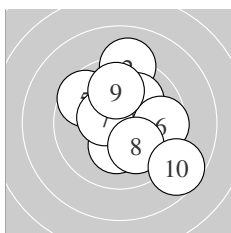
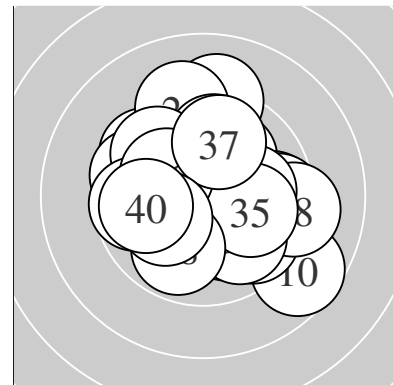

Serie 1:
 10.7 * 9.1 ↑ 10.2 * 10.1 ↗ 9.6 ↖
 9.6 → 10.5 * 10.1 ↘ 9.9 ↑ 8.7 ↘
 beste Teiler 70.3 (1.) 125.3 (7.) 178.8 (3.)
 Trefferlage 0.72 mm rechts, 0.38 mm hoch
 Streuwert 2.25, horizontal: 2.09, vertikal: 2.39

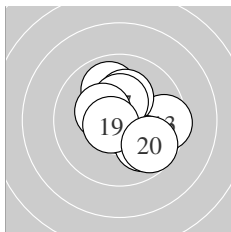

Serie 2:
 10.9 * 9.9 ↖ 9.5 → 10.2 * 10.8 *
 9.9 ↘ 10.4 * 10.4 * 10.6 * 9.7 ↘
 beste Teiler 20.0 (11.) 38.2 (15.) 78.2 (19.)
 Trefferlage 0.51 mm rechts, 0.16 mm hoch
 Streuwert 1.51, horizontal: 1.56, vertikal: 1.45

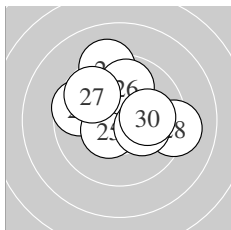

Serie 3:
 10.6 * 9.6 ↖ 10.5 * 9.2 ↑ 10.5 *
 9.9 ↑ 9.8 ↖ 9.2 → 10.2 * 10.1 →
 beste Teiler 84.0 (21.) 116.7 (25.) 122.4 (23.)
 Trefferlage 0.28 mm rechts, 0.92 mm hoch
 Streuwert 1.94, horizontal: 2.22, vertikal: 1.61

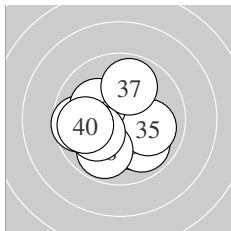

Serie 4:
 10.1 ↘ 9.9 ↘ 10.3 * 9.7 ← 10.0 →
 10.2 * 9.9 ↑ 9.9 ↓ 10.1 ← 9.8 ←
 beste Teiler 169.9 (33.) 199.6 (36.) 210.4 (39.)
 Trefferlage 0.64 mm links, 0.51 mm tief
 Streuwert 1.74, horizontal: 1.95, vertikal: 1.50

Unterschrift des Schützen

Meyton Elektronik

Ergebnis: **392** (412.1)
 Serien: 98 96 100 98
 Zähler: 32 8 0 0 0 0 0 0 0 0
 Innenzehner: 28
 weiteste: 353 (13), 329 (11), 318 (12)
 beste Teiler 14.8 (28.) 27.0 (27.) 48.5 (32.)
 Trefferlage 0.02 mm links, 0.09 mm hoch
 Streuwert 1.32, horizontal: 1.32, vertikal: 1.32

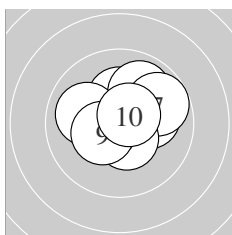
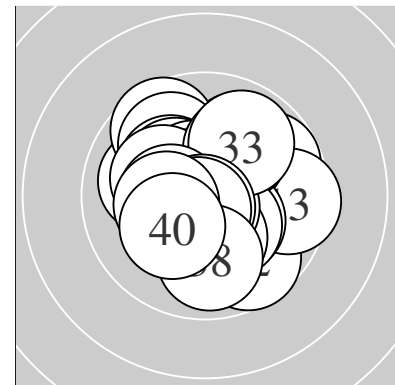

Serie 1:
 10.8 * 10.3 * 10.4 * 9.9 ↗ 10.0 ↖
 10.1 → 9.8 ↗ 10.5 * 10.4 * 10.6 *
 beste Teiler 50.3 (1.) 87.7 (10.) 118.5 (8.)
 Trefferlage 0.24 mm rechts, 0.40 mm hoch
 Streuwert 1.34, horizontal: 1.54, vertikal: 1.10

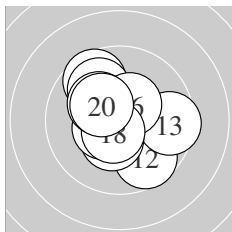

Serie 2:
 9.6 ↖ 9.7 ↘ 9.5 → 10.4 * 9.9 ↖
 10.4 * 10.5 * 10.6 * 10.2 * 10.3 *
 beste Teiler 92.2 (18.) 124.7 (17.) 132.8 (16.)
 Trefferlage 0.19 mm links, 0.27 mm hoch
 Streuwert 1.69, horizontal: 1.72, vertikal: 1.67

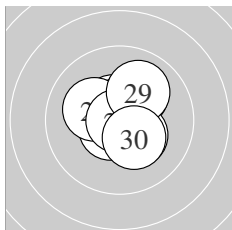

Serie 3:
 10.5 * 10.6 * 10.1 ↗ 10.6 * 10.3 *
 10.2 * 10.8 * 10.9 * 10.0 ↗ 10.3 *
 beste Teiler 14.8 (28.) 27.0 (27.) 81.3 (24.)
 Trefferlage 0.13 mm rechts, 0.31 mm hoch
 Streuwert 1.07, horizontal: 1.03, vertikal: 1.10

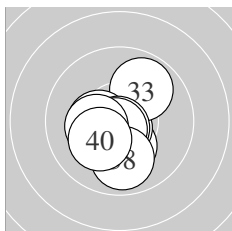

Serie 4:
 10.2 * 10.8 * 9.9 ↗ 10.7 * 10.4 *
 10.8 * 10.7 * 9.9 ↓ 10.3 * 10.2 *
 beste Teiler 48.5 (32.) 50.4 (36.) 63.2 (34.)
 Trefferlage 0.28 mm links, 0.60 mm tief
 Streuwert 1.13, horizontal: 0.98, vertikal: 1.26

Unterschrift des Schützen

Meyton Elektronik

Ergebnis:	391	(411.1)			
Serien:	98	98	97	98	
Zähler:	31	9	0	0	0
Innenzehner:	26				
weiteste:	386 (20), 364 (6), 359 (21)				
beste Teiler	31.3 (12.) 43.1 (25.) 45.2 (17.)				
Trefferlage	0.32 mm rechts, 0.40 mm hoch				
Streuwert	1.36, horizontal: 1.31, vertikal: 1.40				

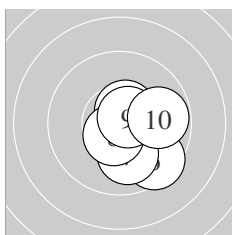
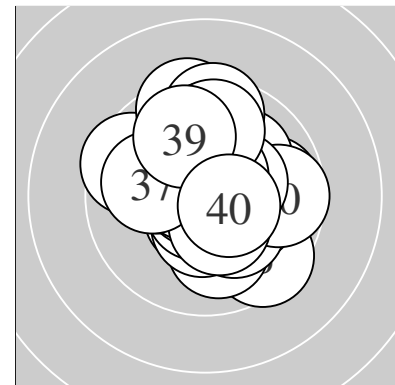

Serie 1:	10.2 *	10.7 *	10.6 *	10.4 *	10.7 *
	9.5 ↘	10.0 ↓	10.6 *	10.7 *	9.8 →
beste Teiler	58.2 (2.) 60.1 (5.) 75.2 (9.)				
Trefferlage	1.04 mm rechts, 0.56 mm tief				
Streuwert	1.08, horizontal: 1.02, vertikal: 1.14				

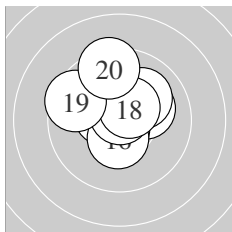

Serie 2:	10.1 ↗	10.8 *	10.1 ↗	10.7 *	10.5 *
	10.4 *	10.8 *	10.5 *	9.5 ↖	9.4 ↑
beste Teiler	31.3 (12.) 45.2 (17.) 66.1 (14.)				
Trefferlage	0.09 mm links, 0.76 mm hoch				
Streuwert	1.41, horizontal: 1.44, vertikal: 1.38				

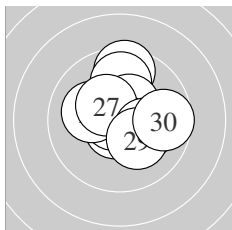

Serie 3:	9.5 ↑	9.9 ↑	10.4 *	10.7 *	10.8 *
	10.1 ↖	10.4 *	10.2 *	10.2 *	9.7 →
beste Teiler	43.1 (25.) 67.2 (24.) 131.2 (23.)				
Trefferlage	0.37 mm rechts, 0.65 mm hoch				
Streuwert	1.51, horizontal: 1.49, vertikal: 1.54				

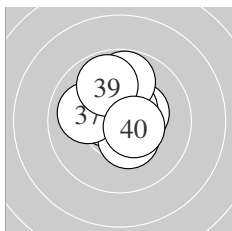

Serie 4:	10.6 *	10.5 *	10.4 *	10.6 *	10.4 *
	10.5 *	10.0 ←	9.8 ↑	9.9 ↑	10.5 *
beste Teiler	76.6 (31.) 79.3 (34.) 101.5 (36.)				
Trefferlage	0.03 mm links, 0.74 mm hoch				
Streuwert	1.17, horizontal: 1.12, vertikal: 1.22				

Unterschrift des Schützen

Meyton Elektronik

Ergebnis: **384** (400.0)
 Serien: 97 97 94 96
 Zähler: 27 10 3 0 0 0 0 0 0 0
 Innenzehner: 21
 weiteste: 676 (29), 585 (40), 571 (22)
 beste Teiler 73.0 (30.) 93.2 (23.) 96.2 (36.)
 Trefferlage 0.19 mm rechts, 0.42 mm tief
 Streuwert 2.00, horizontal: 2.34, vertikal: 1.60

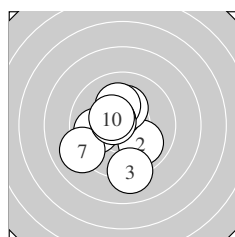
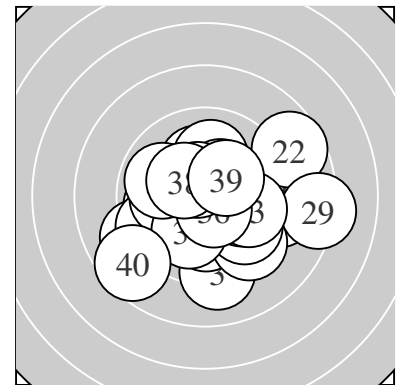

Serie 1:
 9.9 ← 10.0 ↘ 9.1 ↓ 10.5 * 10.3 *
 10.2 * 9.1 ← 10.5 * 10.6 * 10.4 *
 beste Teiler 97.7 (9.) 109.5 (8.) 114.8 (4.)
 Trefferlage 0.76 mm links, 0.29 mm tief
 Streuwert 1.85, horizontal: 1.63, vertikal: 2.04

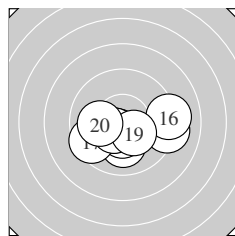

Serie 2:
 10.5 * 10.1 ↓ 9.2 → 10.4 * 10.4 *
 9.1 → 9.5 ← 10.5 * 10.3 * 10.1 ←
 beste Teiler 106.0 (11.) 118.7 (18.) 126.9 (15.)
 Trefferlage 0.24 mm rechts, 0.94 mm tief
 Streuwert 1.86, horizontal: 2.51, vertikal: 0.78

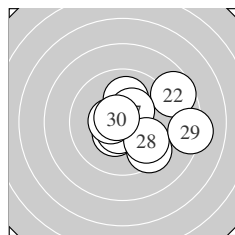

Serie 3:
 10.4 * 8.7 ↗ 10.6 * 10.0 ↑ 10.5 *
 9.4 ↘ 10.4 * 9.8 ↘ 8.2 → 10.7 *
 beste Teiler 73.0 (30.) 93.2 (23.) 117.4 (25.)
 Trefferlage 1.50 mm rechts, 0.08 mm tief
 Streuwert 2.25, horizontal: 2.65, vertikal: 1.76

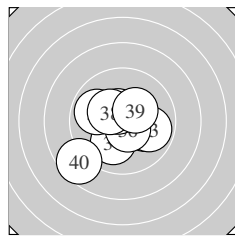

Serie 4:
 10.0 → 10.5 * 9.9 → 10.0 ↓ 9.9 ←
 10.6 * 10.5 * 10.3 * 10.3 * 8.6 ←
 beste Teiler 96.2 (36.) 105.1 (37.) 109.0 (32.)
 Trefferlage 0.20 mm links, 0.38 mm tief
 Streuwert 1.91, horizontal: 2.14, vertikal: 1.65

Unterschrift des Schützen

Ergebnis:	388	(406.4)
Serien:	97 95 99 97	
Zähler:	29 10 1 0 0 0 0 0 0 0	
Innenzehner:	23	
weiteste:	636 (17), 454 (14), 372 (9)	
beste Teiler	49.0 (12.) 54.3 (28.) 61.0 (5.)	
Trefferlage	0.08 mm rechts, 0.10 mm hoch	
Streuwert	1.64, horizontal: 1.75, vertikal: 1.52	

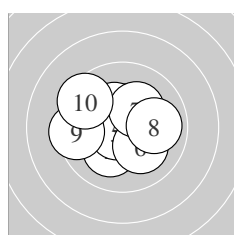
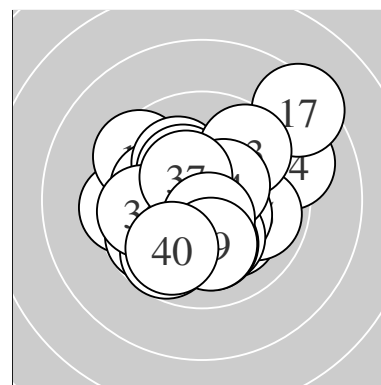

Serie 1:	10.4 *	10.1 ↙	10.6 *	10.3 *	10.7 *
	10.1 ↘	10.2 *	9.9 →	9.5 ←	9.5 ↖
beste Teiler	61.0 (5.)	78.4 (3.)	130.9 (1.)		
Trefferlage	0.40 mm links, 0.26 mm hoch				
Streuwert	1.64, horizontal: 1.92, vertikal: 1.29				

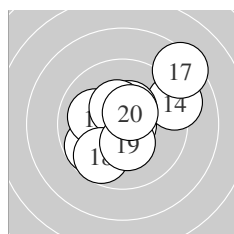

Serie 2:	9.8 ↙	10.8 *	10.0 ↖	9.1 →	10.4 *
	10.4 *	8.4 ↗	9.7 ↙	10.3 *	10.5 *
beste Teiler	49.0 (12.)	111.2 (20.)	136.3 (15.)		
Trefferlage	0.40 mm rechts, 0.43 mm hoch				
Streuwert	2.22, horizontal: 2.42, vertikal: 2.01				

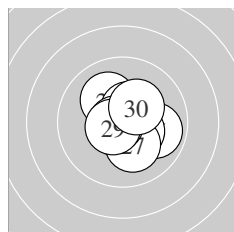

Serie 3:	10.6 *	10.1 ↘	10.5 *	10.6 *	9.9 →
	10.4 *	10.2 *	10.7 *	10.6 *	10.3 *
beste Teiler	54.3 (28.)	79.0 (24.)	87.2 (29.)		
Trefferlage	0.42 mm rechts, 0.12 mm tief				
Streuwert	1.11, horizontal: 1.10, vertikal: 1.11				

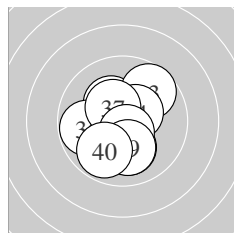

Serie 4:	10.3 *	10.4 *	9.7 ↗	10.5 *	10.1 ↓
	9.8 ←	10.4 *	10.6 *	10.1 ↓	9.9 ↙
beste Teiler	97.0 (38.)	125.3 (34.)	130.8 (32.)		
Trefferlage	0.07 mm links, 0.16 mm tief				
Streuwert	1.56, horizontal: 1.43, vertikal: 1.69				

Unterschrift des Schützen

Meyton Elektronik

Ergebnis: **384** (401.6)
 Serien: 98 95 95 96
 Zähler: 24 16 0 0 0 0 0 0 0 0
 Innenzehner: 14
 weiteste: 464 (22), 437 (37), 400 (17)
 beste Teiler 55.0 (2.) 75.8 (25.) 86.8 (13.)
 Trefferlage 0.08 mm links, 0.07 mm hoch
 Streuwert 1.79, horizontal: 1.99, vertikal: 1.56

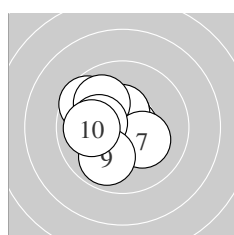
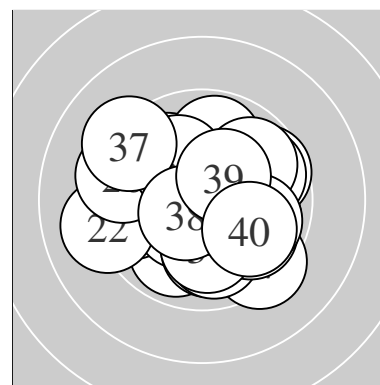

Serie 1:
 10.6 * 10.7 * 9.6 ↘ 10.5 * 10.4 *
 10.0 ↘ 10.2 * 10.2 * 9.9 ↙ 10.0 ←
 beste Teiler 55.0 (2.) 87.0 (1.) 114.4 (4.)
 Trefferlage 0.91 mm links, 0.20 mm hoch
 Streuwert 1.35, horizontal: 1.39, vertikal: 1.31

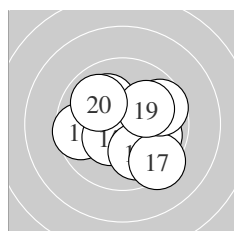

Serie 2:
 9.6 ← 10.1 ↘ 10.6 * 9.9 → 10.4 *
 10.0 ↓ 9.4 ↘ 9.7 → 10.1 → 9.9 ↘
 beste Teiler 86.8 (13.) 141.4 (15.) 210.8 (12.)
 Trefferlage 0.33 mm rechts, 0.23 mm tief
 Streuwert 1.93, horizontal: 2.18, vertikal: 1.65

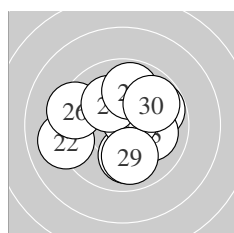

Serie 3:
 9.8 → 9.1 ← 10.1 → 10.0 ↓ 10.7 *
 9.4 ← 10.2 * 9.8 ↑ 10.0 ↓ 9.8 →
 beste Teiler 75.8 (25.) 198.4 (27.) 224.4 (23.)
 Trefferlage 0.00 mm , 0.22 mm hoch
 Streuwert 2.14, horizontal: 2.44, vertikal: 1.79

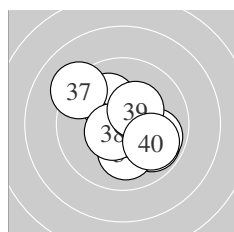

Serie 4:
 9.8 ↘ 10.4 * 9.9 → 10.1 ↓ 10.6 *
 10.1 ↘ 9.2 ↘ 10.6 * 10.3 * 9.9 ↘
 beste Teiler 96.1 (35.) 99.6 (38.) 130.0 (32.)
 Trefferlage 0.26 mm rechts, 0.10 mm hoch
 Streuwert 1.75, horizontal: 1.86, vertikal: 1.64

Unterschrift des Schützen

Meyton Elektronik

Ergebnis: **389** (406.3)
 Serien: 97 99 97 96
 Zähler: 29 11 0 0 0 0 0 0 0 0
 Innenzehner: 22
 weiteste: 469 (25), 371 (2), 335 (33)
 beste Teiler 20.0 (27.) 79.4 (12.) 88.1 (21.)
 Trefferlage 0.75 mm rechts, 0.25 mm hoch
 Streuwert 1.44, horizontal: 1.57, vertikal: 1.30

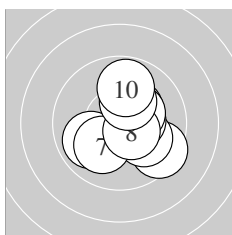
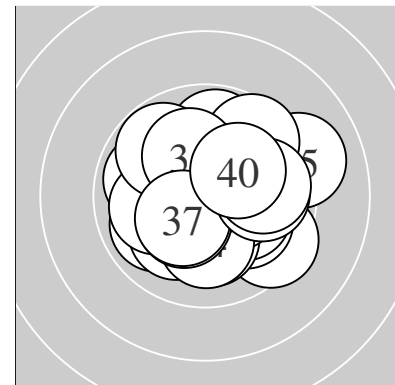

Serie 1:
 9.9 ↙ 9.5 ↘ 10.3 * 10.1 ↘ 10.4 *
 10.3 * 10.1 ↙ 10.5 * 10.2 * 9.8 ↑
 beste Teiler 111.2 (8.) 139.3 (5.) 155.0 (6.)
 Trefferlage 0.73 mm rechts, 0.02 mm tief
 Streuwert 1.57, horizontal: 1.53, vertikal: 1.60

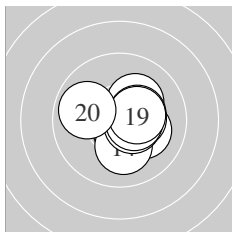

Serie 2:
 10.2 * 10.6 * 10.2 * 10.1 ↓ 10.4 *
 10.5 * 10.4 * 10.5 * 10.4 * 9.9 ↖
 beste Teiler 79.4 (12.) 107.5 (16.) 114.8 (18.)
 Trefferlage 0.72 mm rechts, 0.09 mm tief
 Streuwert 1.12, horizontal: 1.26, vertikal: 0.96

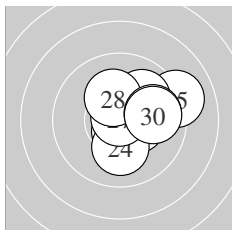

Serie 3:
 10.6 * 10.4 * 10.3 * 10.1 ↓ 9.1 →
 10.0 ↗ 10.9 * 10.2 * 9.9 → 9.9 →
 beste Teiler 20.0 (27.) 88.1 (21.) 138.7 (22.)
 Trefferlage 1.33 mm rechts, 0.43 mm hoch
 Streuwert 1.41, horizontal: 1.54, vertikal: 1.27

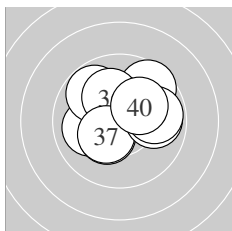

Serie 4:
 10.0 ← 9.8 ↘ 9.6 ↗ 10.4 * 10.4 *
 10.1 ↘ 10.4 * 9.9 → 9.8 → 10.2 *
 beste Teiler 143.7 (35.) 148.4 (37.) 150.3 (34.)
 Trefferlage 0.20 mm rechts, 0.70 mm hoch
 Streuwert 1.65, horizontal: 1.92, vertikal: 1.33

Unterschrift des Schützen

Ergebnis: **395** (410.4)
 Serien: 99 99 99 98
 Zähler: 35 5 0 0 0 0 0 0 0 0
 Innenzehner: 27
 weiteste: 401 (31), 303 (22), 274 (10)
 beste Teiler 63.2 (13.) 76.3 (5.) 80.3 (21.)
 Trefferlage 0.04 mm links, 0.17 mm hoch
 Streuwert 1.33, horizontal: 1.45, vertikal: 1.20

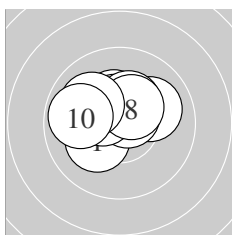
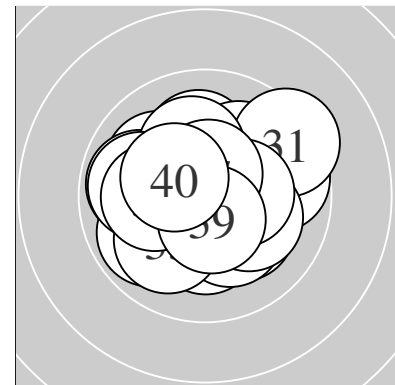

Serie 1:
 10.2 * 10.0 ↗ 10.4 * 10.5 * 10.6 *
 10.4 * 10.3 * 10.4 * 10.0 ↘ 9.9 ←
 beste Teiler 76.3 (5.) 118.5 (4.) 134.8 (6.)
 Trefferlage 0.40 mm links, 0.78 mm hoch
 Streuwert 1.16, horizontal: 1.46, vertikal: 0.76

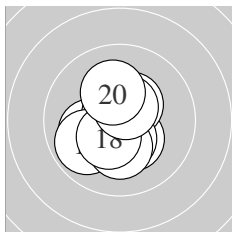

Serie 2:
 10.1 ← 10.3 * 10.7 * 10.4 * 9.9 ↙
 10.4 * 10.2 * 10.4 * 10.6 * 10.2 *
 beste Teiler 63.2 (13.) 99.7 (19.) 131.9 (16.)
 Trefferlage 0.34 mm links, 0.34 mm tief
 Streuwert 1.20, horizontal: 1.08, vertikal: 1.32

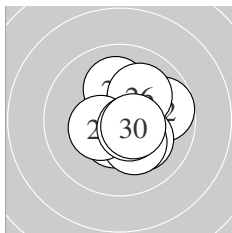

Serie 3:
 10.6 * 9.7 → 10.5 * 10.2 * 10.1 ↑
 10.1 ↗ 10.2 * 10.4 * 10.6 * 10.5 *
 beste Teiler 80.3 (21.) 89.3 (29.) 103.3 (30.)
 Trefferlage 0.66 mm rechts, 0.00 mm
 Streuwert 1.23, horizontal: 1.19, vertikal: 1.28

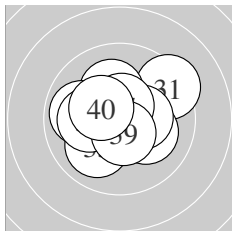

Serie 4:
 9.3 ↗ 10.1 ↘ 10.0 ↙ 10.2 * 10.4 *
 9.9 ← 10.6 * 10.1 ← 10.6 * 10.4 *
 beste Teiler 93.0 (37.) 100.6 (39.) 146.4 (35.)
 Trefferlage 0.10 mm links, 0.26 mm hoch
 Streuwert 1.61, horizontal: 1.89, vertikal: 1.26

Unterschrift des Schützen

Meyton Elektronik

Ergebnis: **374** (392.0)
 Serien: 94 94 94 92
 Zähler: 18 18 4 0 0 0 0 0 0
 Innenzehner: 11
 weiteste: 624 (18), 589 (24), 587 (38)
 beste Teiler 43.6 (27.) 59.6 (19.) 65.1 (15.)
 Trefferlage 0.50 mm rechts, 0.28 mm hoch
 Streuwert 2.30, horizontal: 1.94, vertikal: 2.61

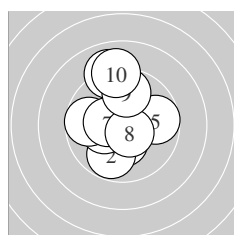
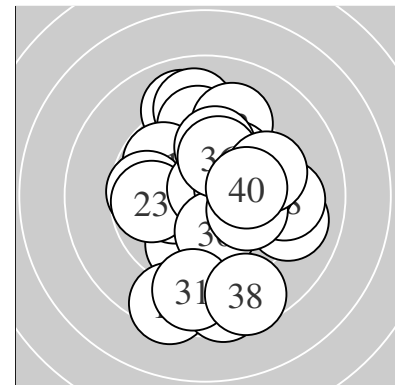

Serie 1:
 10.3 * 9.8 ↘ 10.3 * 9.7 ← 9.7 →
 9.0 ↑ 10.4 * 10.6 * 9.7 ↑ 9.0 ↑
 beste Teiler 93.3 (8.) 139.8 (7.) 156.2 (1.)
 Trefferlage 0.49 mm links, 0.83 mm hoch
 Streuwert 2.14, horizontal: 1.66, vertikal: 2.53

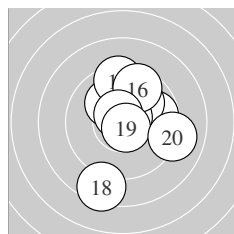

Serie 2:
 9.8 → 10.1 ↖ 9.4 ↑ 10.0 ↗ 10.7 *
 9.6 ↗ 10.6 * 8.5 ↓ 10.7 * 9.0 →
 beste Teiler 59.6 (19.) 65.1 (15.) 81.4 (17.)
 Trefferlage 0.72 mm rechts, 0.45 mm hoch
 Streuwert 2.37, horizontal: 1.96, vertikal: 2.73

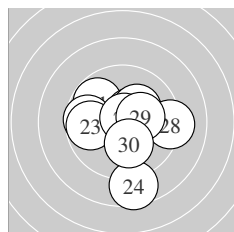

Serie 3:
 9.8 ↖ 9.7 ← 9.8 ← 8.6 ↓ 10.5 *
 10.2 * 10.8 * 9.2 → 10.3 * 10.1 ↓
 beste Teiler 43.6 (27.) 115.8 (25.) 170.8 (29.)
 Trefferlage 0.13 mm rechts, 0.32 mm tief
 Streuwert 2.27, horizontal: 2.35, vertikal: 2.18

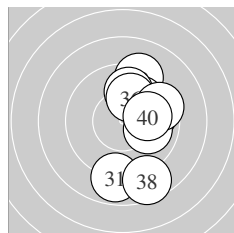

Serie 4:
 8.9 ↓ 9.3 ↑ 9.9 → 10.0 ↗ 9.9 ↑
 10.0 ↑ 10.0 → 8.6 ↓ 9.5 → 10.0 →
 beste Teiler 227.0 (36.) 233.3 (40.) 244.1 (37.)
 Trefferlage 1.66 mm rechts, 0.16 mm hoch
 Streuwert 2.39, horizontal: 1.19, vertikal: 3.17

Unterschrift des Schützen

Meyton Elektronik

Ergebnis:	386	(406.1)
Serien:	95	100 96 95
Zähler:	26	14 0 0 0 0 0 0 0 0
Innenzehner:	20	
weiteste:	429 (4), 363 (25), 347 (39)	
beste Teiler	38.8 (29.)	45.8 (1.) 63.4 (19.)
Trefferlage	0.48 mm rechts, 0.43 mm hoch	
Streuwert	1.52, horizontal: 1.52, vertikal: 1.51	

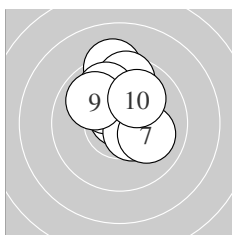
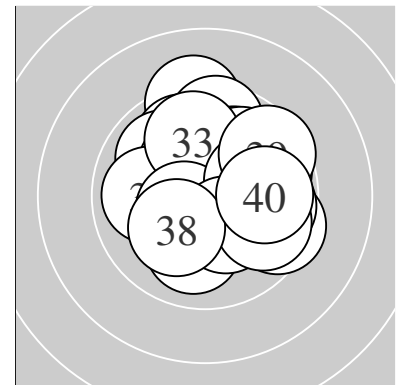

Serie 1:	10.8 *	9.9 ↑	10.3 *	9.2 ↑	9.6 ↑
	10.5 *	10.1 →	9.9 ↘	9.9 ↘	10.0 ↗
beste Teiler	45.8 (1.)	117.0 (6.)	170.5 (3.)		
Trefferlage	0.07 mm rechts, 1.65 mm hoch				
Streuwert	1.44, horizontal: 1.22, vertikal: 1.64				

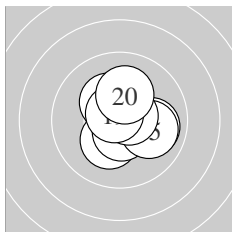

Serie 2:	10.3 *	10.0 →	10.4 *	10.6 *	10.0 →
	10.6 *	10.6 *	10.3 *	10.7 *	10.2 *
beste Teiler	63.4 (19.)	79.7 (16.)	92.0 (14.)		
Trefferlage	0.29 mm rechts, 0.26 mm hoch				
Streuwert	1.17, horizontal: 1.19, vertikal: 1.14				

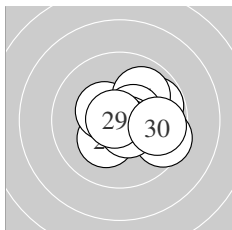

Serie 3:	9.8 →	10.2 *	10.4 *	9.9 ↗	9.5 →
	10.5 *	10.7 *	10.6 *	10.8 *	9.8 →
beste Teiler	38.8 (29.)	72.6 (27.)	92.6 (28.)		
Trefferlage	1.03 mm rechts, 0.00 mm				
Streuwert	1.37, horizontal: 1.62, vertikal: 1.07				

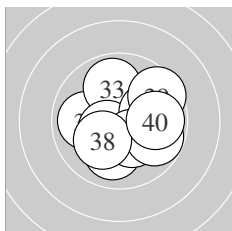

Serie 4:	10.0 ↓	9.9 ←	9.9 ↑	10.5 *	10.0 →
	10.3 *	9.8 →	10.2 *	9.6 ↗	9.8 →
beste Teiler	116.7 (34.)	164.8 (36.)	197.5 (38.)		
Trefferlage	0.55 mm rechts, 0.16 mm tief				
Streuwert	1.79, horizontal: 1.99, vertikal: 1.56				

Unterschrift des Schützen

Meyton Elektronik

Ergebnis: **375** (396.6)
 Serien: 93 96 92 94
 Zähler: 19 17 4 0 0 0 0 0 0 0
 Innenzehner: 17
 weiteste: 718 (9), 544 (27), 522 (30)
 beste Teiler 32.1 (5.) 68.1 (19.) 76.1 (35.)
 Trefferlage 0.39 mm rechts, 0.50 mm tief
 Streuwert 2.10, horizontal: 2.63, vertikal: 1.37

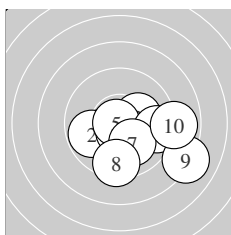
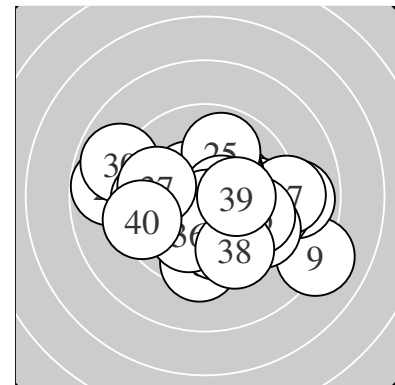

Serie 1:
 10.5 * 9.8 ← 10.2 * 10.6 * 10.8 *
 9.5 → 10.1 ↘ 9.4 ↓ 8.1 ↘ 8.9 →
 beste Teiler 32.1 (5.) 82.0 (4.) 106.3 (1.)
 Trefferlage 1.37 mm rechts, 1.15 mm tief
 Streuwert 2.26, horizontal: 2.84, vertikal: 1.46

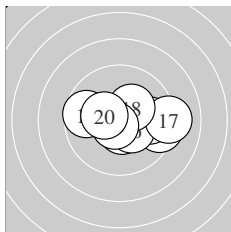

Serie 2:
 10.4 * 9.4 → 9.7 ← 9.8 → 10.5 *
 10.4 * 9.1 → 10.3 * 10.7 * 10.3 *
 beste Teiler 68.1 (19.) 103.5 (15.) 136.6 (11.)
 Trefferlage 1.00 mm rechts, 0.12 mm tief
 Streuwert 1.75, horizontal: 2.37, vertikal: 0.71

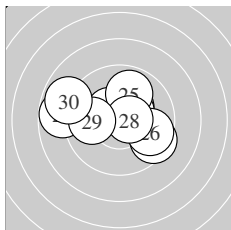

Serie 3:
 10.3 * 10.4 * 10.4 * 9.5 ↘ 9.9 ↑
 9.7 → 8.8 ← 10.6 * 9.9 ← 8.9 ←
 beste Teiler 93.1 (28.) 128.0 (23.) 132.6 (22.)
 Trefferlage 0.38 mm links, 0.48 mm hoch
 Streuwert 2.33, horizontal: 3.02, vertikal: 1.31

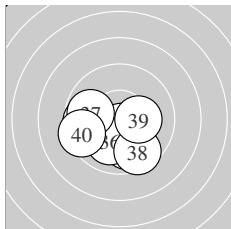

Serie 4:
 9.9 ↘ 10.6 * 9.7 ← 9.9 ↓ 10.6 *
 10.0 ↓ 9.8 ← 9.6 ↘ 10.2 * 9.4 ←
 beste Teiler 76.1 (35.) 98.3 (32.) 179.0 (39.)
 Trefferlage 0.41 mm links, 1.23 mm tief
 Streuwert 1.69, horizontal: 2.06, vertikal: 1.21

Unterschrift des Schützen

Meyton Elektronik

Ergebnis: **393** (409.7)
 Serien: 96 99 99 99
 Zähler: 34 5 1 0 0 0 0 0 0 0
 Innenzehner: 26
 weiteste: 697 (7), 345 (18), 330 (4)
 beste Teiler 19.4 (30.) 42.0 (35.) 45.2 (36.)
 Trefferlage 0.29 mm links, 0.09 mm hoch
 Streuwert 1.50, horizontal: 1.88, vertikal: 0.98

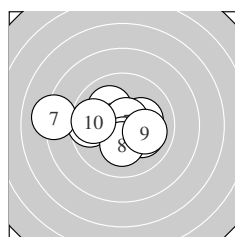
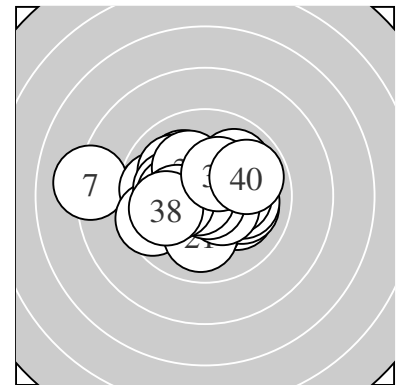

Serie 1:
 10.1 ↖ 10.1 → 10.2 * 9.6 ← 10.7 *
 10.4 * 8.2 ← 10.2 * 10.0 → 9.8 ←
 beste Teiler 63.5 (5.) 142.1 (6.) 190.0 (8.)
 Trefferlage 0.81 mm links, 0.09 mm tief
 Streuwert 2.19, horizontal: 2.88, vertikal: 1.12

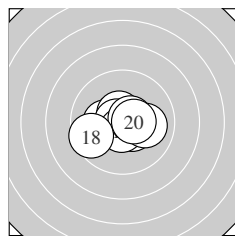

Serie 2:
 10.6 * 10.2 * 10.6 * 10.7 * 10.5 *
 10.6 * 10.6 * 9.6 ← 10.0 → 10.5 *
 beste Teiler 59.6 (14.) 80.6 (16.) 87.6 (11.)
 Trefferlage 0.14 mm links, 0.11 mm tief
 Streuwert 1.20, horizontal: 1.55, vertikal: 0.69

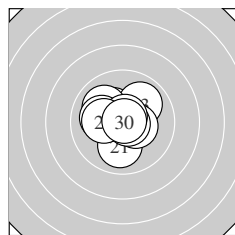

Serie 3:
 10.0 ↓ 10.3 * 9.9 ↗ 10.4 * 10.0 ↖
 10.1 ← 10.7 * 10.7 * 10.2 * 10.9 *
 beste Teiler 19.4 (30.) 56.9 (27.) 60.0 (28.)
 Trefferlage 0.30 mm links, 0.28 mm hoch
 Streuwert 1.27, horizontal: 1.36, vertikal: 1.17

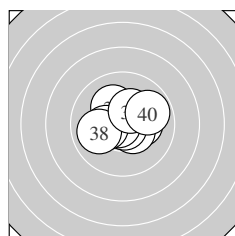

Serie 4:
 10.2 * 10.5 * 10.2 * 10.4 * 10.8 *
 10.8 * 10.3 * 10.0 ← 10.3 * 9.8 →
 beste Teiler 42.0 (35.) 45.2 (36.) 115.4 (32.)
 Trefferlage 0.10 mm rechts, 0.29 mm hoch
 Streuwert 1.26, horizontal: 1.52, vertikal: 0.93

Unterschrift des Schützen

Meyton Elektronik

Ergebnis:	376	(394.5)			
Serien:	95	93	93	95	
Zähler:	21	14	5	0	0 0 0 0 0 0
Innenzehner:	17				
weiteste:	732 (6), 622 (39), 589 (15)				
beste Teiler	59.1 (10.) 62.1 (36.) 93.4 (35.)				
Trefferlage	0.38 mm rechts, 0.30 mm hoch				
Streuwert	2.26, horizontal: 2.64, vertikal: 1.79				

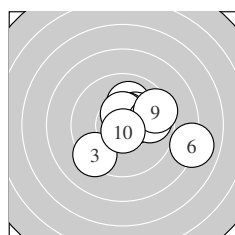
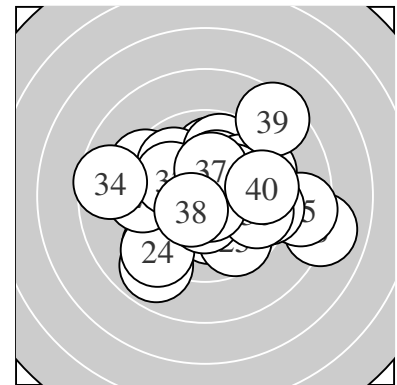

Serie 1:	10.6 *	10.0 ↑	9.3 ↙	10.3 *	10.5 *
	8.0 →	10.5 *	9.8 →	9.5 →	10.7 *
beste Teiler	59.1 (10.) 100.4 (1.) 113.8 (5.)				
Trefferlage	1.35 mm rechts, 0.20 mm hoch				
Streuwert	2.17, horizontal: 2.61, vertikal: 1.63				

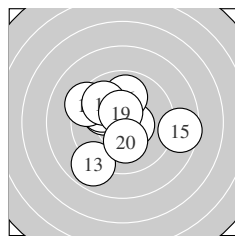

Serie 2:	10.5 *	10.1 ↖	8.9 ↙	10.0 ↖	8.6 →
	9.9 ↑	9.3 ↖	9.9 ↖	10.5 *	10.2 *
beste Teiler	101.0 (19.) 105.0 (11.) 193.3 (20.)				
Trefferlage	0.52 mm links, 0.21 mm hoch				
Streuwert	2.41, horizontal: 2.71, vertikal: 2.08				

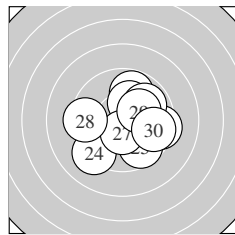

Serie 3:	9.8 ↑	9.4 →	10.2 *	9.2 ↙	9.7 ↘
	9.9 ↗	10.4 *	9.4 ←	10.2 *	9.6 →
beste Teiler	126.0 (27.) 189.4 (23.) 191.1 (29.)				
Trefferlage	0.75 mm rechts, 0.19 mm tief				
Streuwert	2.22, horizontal: 2.45, vertikal: 1.96				

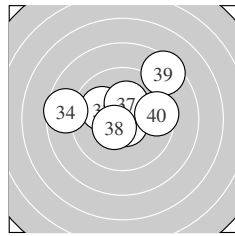

Serie 4:	10.4 *	10.5 *	10.0 ↖	8.6 ←	10.6 *
	10.7 *	10.3 *	10.5 *	8.5 ↗	9.5 →
beste Teiler	62.1 (36.) 93.4 (35.) 116.4 (32.)				
Trefferlage	0.03 mm links, 0.99 mm hoch				
Streuwert	2.23, horizontal: 2.78, vertikal: 1.51				

Unterschrift des Schützen

Ergebnis: **377** (396.5)
 Serien: 93 92 97 95
 Zähler: 19 20 0 1 0 0 0 0 0 0
 Innenzehner: 12
 weiteste: 842 (13), 416 (31), 397 (19)
 beste Teiler 58.9 (30.) 63.5 (28.) 81.3 (34.)
 Trefferlage 0.75 mm links, 0.52 mm hoch
 Streuwert 1.99, horizontal: 2.30, vertikal: 1.63

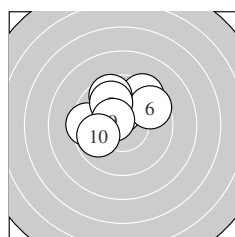
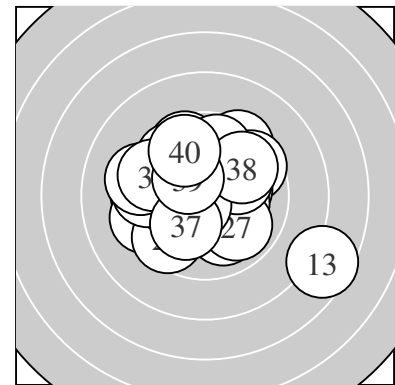

Serie 1:
 9.7 ← 10.2 * 9.5 ↗ 10.4 * 9.5 ←
 9.6 ↗ 9.6 ↘ 9.9 ↘ 10.5 * 9.9 ←
 beste Teiler 113.6 (9.) 140.8 (4.) 196.0 (2.)
 Trefferlage 0.95 mm links, 1.26 mm hoch
 Streuwert 1.77, horizontal: 2.08, vertikal: 1.39

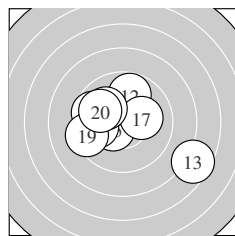

Serie 2:
 10.3 * 9.8 ↑ 7.6 ↘ 9.7 ↖ 10.5 *
 9.9 ← 10.1 → 10.0 ↘ 9.4 ← 9.9 ↖
 beste Teiler 124.0 (15.) 169.3 (11.) 201.8 (17.)
 Trefferlage 0.53 mm links, 0.16 mm hoch
 Streuwert 2.69, horizontal: 3.27, vertikal: 1.95

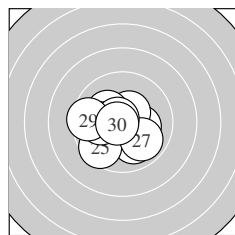

Serie 3:
 10.2 * 10.0 ↘ 10.5 * 10.2 * 9.6 ↗
 10.0 ← 9.9 ↘ 10.7 * 9.5 ← 10.7 *
 beste Teiler 58.9 (30.) 63.5 (28.) 121.2 (23.)
 Trefferlage 0.53 mm links, 0.45 mm tief
 Streuwert 1.62, horizontal: 1.90, vertikal: 1.29

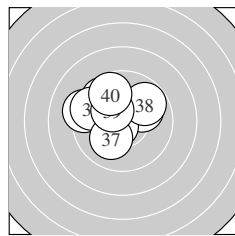

Serie 4:
 9.3 ↖ 10.0 ↗ 10.1 ↘ 10.6 * 9.7 ↘
 9.6 ↖ 10.1 ↗ 9.8 ↗ 10.3 * 9.7 ↘
 beste Teiler 81.3 (34.) 154.8 (39.) 211.2 (33.)
 Trefferlage 1.00 mm links, 1.11 mm hoch
 Streuwert 1.70, horizontal: 1.99, vertikal: 1.36

Unterschrift des Schützen

Meyton Elektronik