

EYL Rifle – Wertung – offene Klasse

StartNr: 6

StandNr: 139

9. Juni 2018 9:47

KRUMM, Clémentine #1000000237

France / France

Ergebnis: **410.7** (394)
 Serien: 101.7 102.5 104.3 102.2
 Zähler: 34 6 0 0 0 0 0 0 0 0
 Innenzehner: 24
 weiteste: 365 (40), 321 (22), 300 (6)
 beste Teiler 6.7 (24.) 41.1 (29.) 60.6 (8.)
 Trefferlage 0.14 mm links, 0.02 mm hoch
 Streuwert 1.37, horizontal: 1.51, vertikal: 1.21

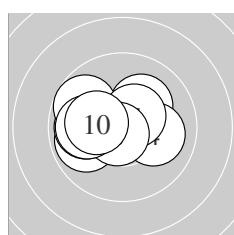
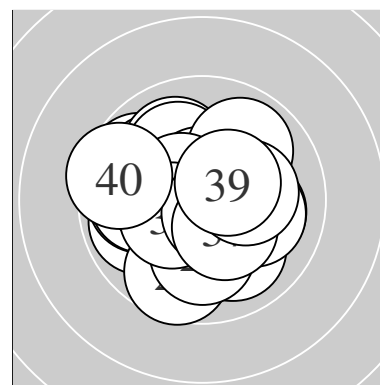

Serie 1:
 10.2 * 9.9 ← 9.9 ← 10.1 → 10.4 *
 9.8 ↖ 10.5 * 10.7 * 10.0 ← 10.2 *
 beste Teiler 60.6 (8.) 113.8 (7.) 126.1 (5.)
 Trefferlage 0.94 mm links, 0.24 mm hoch
 Streuwert 1.40, horizontal: 1.81, vertikal: 0.81

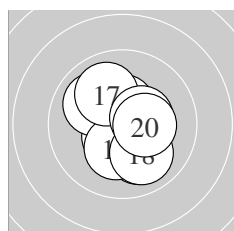

Serie 2:
 10.0 ↘ 10.5 * 10.6 * 10.0 ↖ 10.4 *
 10.3 * 10.0 ↖ 10.0 ↘ 10.4 * 10.3 *
 beste Teiler 87.6 (13.) 108.0 (12.) 126.0 (15.)
 Trefferlage 0.16 mm rechts, 0.21 mm tief
 Streuwert 1.36, horizontal: 1.20, vertikal: 1.49

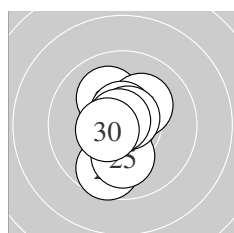

Serie 3:
 10.7 * 9.7 ↓ 10.1 ↖ 10.9 * 10.1 ↓
 10.2 * 10.6 * 10.7 * 10.8 * 10.5 *
 beste Teiler 6.7 (24.) 41.1 (29.) 63.6 (28.)
 Trefferlage 0.24 mm links, 0.06 mm tief
 Streuwert 1.20, horizontal: 0.76, vertikal: 1.52

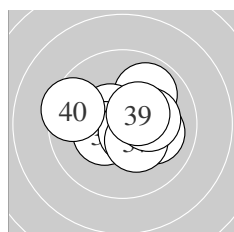

Serie 4:
 10.1 → 9.9 ↗ 10.1 → 10.5 * 10.4 *
 10.7 * 10.4 * 10.2 * 10.4 * 9.5 ←
 beste Teiler 75.6 (36.) 105.1 (34.) 131.1 (39.)
 Trefferlage 0.45 mm rechts, 0.12 mm hoch
 Streuwert 1.46, horizontal: 1.82, vertikal: 0.99

Unterschrift des Schützen

Meyton Elektronik

EYL Rifle – Wertung – offene Klasse

StartNr: 7

StandNr: 141

9. Juni 2018 9:47

MULLER, Océane #1000000239

France / France

Ergebnis: **409.9** (392)
 Serien: 101.5 103.4 102.2 102.8
 Zähler: 32 8 0 0 0 0 0 0 0 0
 Innenzehner: 25
 weiteste: 426 (7), 348 (3), 336 (10)
 beste Teiler 17.2 (11.) 22.8 (6.) 43.4 (37.)
 Trefferlage 0.23 mm rechts, 0.09 mm tief
 Streuwert 1.41, horizontal: 1.53, vertikal: 1.29

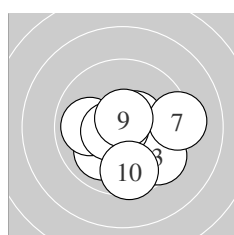
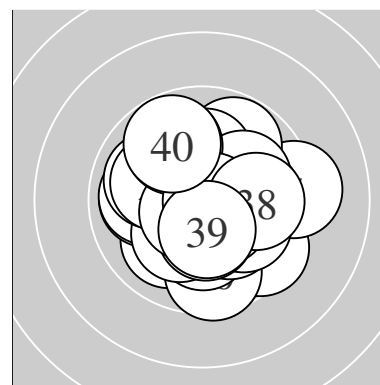

Serie 1:
 10.5 * 10.6 * 9.6 ↘ 10.0 ✓ 9.9 ←
 10.9 * 9.2 → 10.5 * 10.7 * 9.6 ↓
 beste Teiler 22.8 (6.) 68.5 (9.) 79.6 (2.)
 Trefferlage 0.25 mm rechts, 0.63 mm tief
 Streuwert 1.71, horizontal: 2.00, vertikal: 1.35

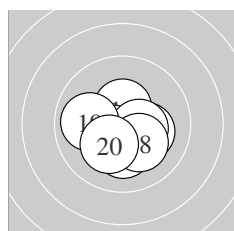

Serie 2:
 10.9 * 10.5 * 10.2 * 10.4 * 10.2 *
 10.5 * 10.4 * 10.2 * 9.9 ← 10.2 *
 beste Teiler 17.2 (11.) 104.2 (16.) 123.0 (12.)
 Trefferlage 0.10 mm rechts, 0.57 mm tief
 Streuwert 1.14, horizontal: 1.31, vertikal: 0.94

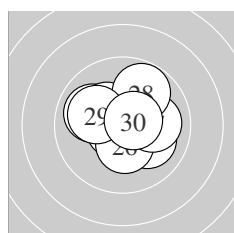

Serie 3:
 10.0 ↖ 10.3 * 10.2 * 10.1 ↘ 10.7 *
 10.4 * 10.0 → 9.8 ↗ 10.1 ↖ 10.6 *
 beste Teiler 64.4 (25.) 90.0 (30.) 148.9 (26.)
 Trefferlage 0.24 mm rechts, 0.27 mm hoch
 Streuwert 1.44, horizontal: 1.69, vertikal: 1.14

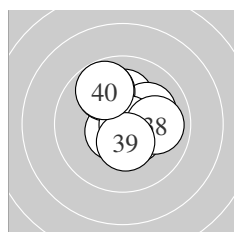

Serie 4:
 10.5 * 10.6 * 10.2 * 10.6 * 10.1 ↗
 9.8 ↘ 10.8 * 10.0 → 10.4 * 9.8 ↘
 beste Teiler 43.4 (37.) 77.8 (32.) 86.5 (34.)
 Trefferlage 0.33 mm rechts, 0.57 mm hoch
 Streuwert 1.33, horizontal: 1.25, vertikal: 1.40

Unterschrift des Schützen

Meyton Elektronik

EYL Rifle – Wertung – offene Klasse

StartNr: 9

StandNr: 143

9. Juni 2018 9:45

VEDEL, Timothée #1000000241

France / France

Ergebnis: **405.2** (388)
 Serien: 100.6 99.3 103.7 101.6
 Zähler: 29 10 1 0 0 0 0 0 0 0
 Innenzehner: 22
 weiteste: 508 (8), 495 (4), 483 (17)
 beste Teiler 49.0 (26.) 63.8 (20.) 66.0 (40.)
 Trefferlage 0.11 mm rechts, 0.23 mm tief
 Streuwert 1.70, horizontal: 2.10, vertikal: 1.16

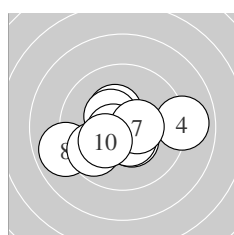
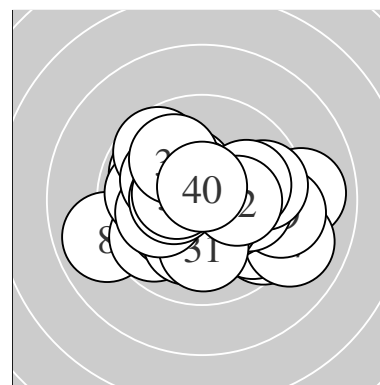

Serie 1:
 10.4 * 10.4 * 10.4 * 9.0 → 10.6 *
 10.5 * 10.5 * 8.9 ← 9.7 ↖ 10.2 *
 beste Teiler 83.3 (5.) 115.6 (6.) 121.0 (7.)
 Trefferlage 0.34 mm links, 0.46 mm tief
 Streuwert 1.95, horizontal: 2.54, vertikal: 1.10

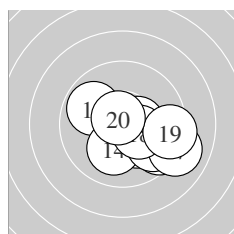

Serie 2:
 10.5 * 9.9 ↖ 10.2 * 10.1 ↓ 9.5 ↘
 9.7 ↘ 9.0 ↘ 10.3 * 9.4 → 10.7 *
 beste Teiler 63.8 (20.) 124.1 (11.) 151.1 (18.)
 Trefferlage 1.42 mm rechts, 0.85 mm tief
 Streuwert 1.73, horizontal: 2.15, vertikal: 1.18

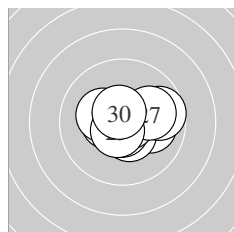

Serie 3:
 10.0 → 10.5 * 9.7 → 10.5 * 10.7 *
 10.8 * 10.0 → 10.3 * 10.6 * 10.6 *
 beste Teiler 49.0 (26.) 68.1 (25.) 82.1 (29.)
 Trefferlage 0.49 mm rechts, 0.00 mm
 Streuwert 1.20, horizontal: 1.56, vertikal: 0.69

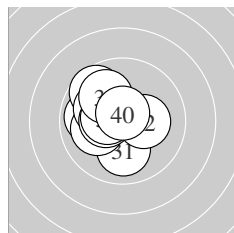

Serie 4:
 10.0 ↓ 10.3 * 9.9 ← 10.1 ← 9.7 ↖
 10.1 ↖ 10.4 * 10.4 * 10.0 ↖ 10.7 *
 beste Teiler 66.0 (40.) 129.5 (38.) 140.0 (37.)
 Trefferlage 1.09 mm links, 0.38 mm hoch
 Streuwert 1.33, horizontal: 1.33, vertikal: 1.33

Unterschrift des Schützen

Meyton Elektronik

EYL Rifle – Wertung – offene Klasse

StartNr: 14

StandNr: 140

9. Juni 2018 9:46

DÉNES, Eszter #1000000238

Hungary / Hungary

Ergebnis: **410.7** (395)
 Serien: 103.5 102.0 101.7 103.5
 Zähler: 35 5 0 0 0 0 0 0 0 0
 Innenzehner: 26
 weiteste: 450 (19), 324 (37), 259 (22)
 beste Teiler 43.0 (2.) 53.8 (40.) 63.2 (32.)
 Trefferlage 0.57 mm links, 0.09 mm hoch
 Streuwert 1.30, horizontal: 1.09, vertikal: 1.49

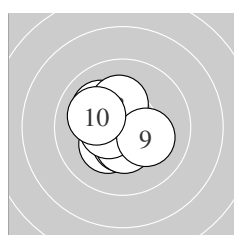
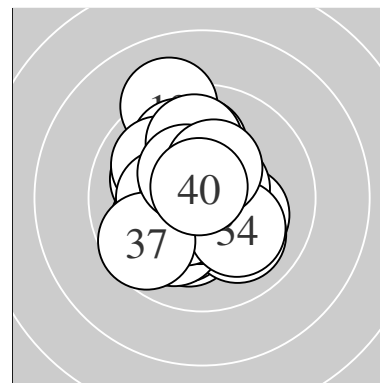

Serie 1:
 10.3 * 10.8 * 10.4 * 10.5 * 10.4 *
 10.1 ↘ 10.5 * 10.2 * 10.2 * 10.1 ↘
 beste Teiler 43.0 (2.) 108.5 (7.) 121.4 (4.)
 Trefferlage 0.49 mm links, 0.00 mm
 Streuwert 1.14, horizontal: 1.08, vertikal: 1.19

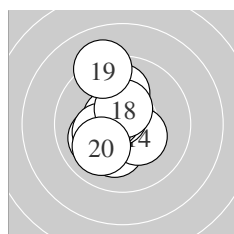

Serie 2:
 10.2 * 10.0 ↑ 10.1 ↙ 10.4 * 10.7 *
 10.6 * 10.3 * 10.5 * 9.2 ↗ 10.0 ↙
 beste Teiler 67.2 (15.) 94.5 (16.) 119.1 (18.)
 Trefferlage 0.74 mm links, 0.27 mm hoch
 Streuwert 1.53, horizontal: 0.98, vertikal: 1.93

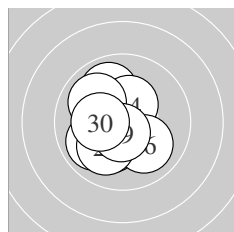

Serie 3:
 9.9 ↖ 9.9 ↙ 10.3 * 10.4 * 10.2 *
 10.0 ↘ 10.0 ↘ 10.1 ↙ 10.6 * 10.3 *
 beste Teiler 81.7 (29.) 143.6 (24.) 157.1 (23.)
 Trefferlage 0.86 mm links, 0.21 mm tief
 Streuwert 1.37, horizontal: 1.20, vertikal: 1.53

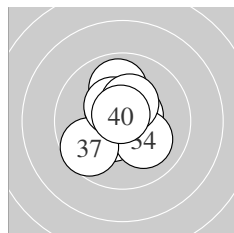

Serie 4:
 10.5 * 10.7 * 10.6 * 10.1 ↘ 10.5 *
 9.9 ↑ 9.7 ↙ 10.4 * 10.4 * 10.7 *
 beste Teiler 53.8 (40.) 63.2 (32.) 99.2 (33.)
 Trefferlage 0.21 mm links, 0.31 mm hoch
 Streuwert 1.26, horizontal: 1.13, vertikal: 1.37

Unterschrift des Schützen

Meyton Elektronik

EYL Rifle – Wertung – offene Klasse

StartNr: 16

StandNr: 142

9. Juni 2018 9:44

MÉSZÁROS, Eszter #1000000240

Hungary / Hungary

Ergebnis: **414.4** (395)
 Serien: 102.8 103.5 104.1 104.0
 Zähler: 35 5 0 0 0 0 0 0 0 0
 Innenzehner: 33
 weiteste: 368 (1), 323 (31), 290 (19)
 beste Teiler 29.0 (36.) 48.3 (23.) 62.6 (35.)
 Trefferlage 0.19 mm rechts, 0.51 mm tief
 Streuwert 1.14, horizontal: 1.23, vertikal: 1.04

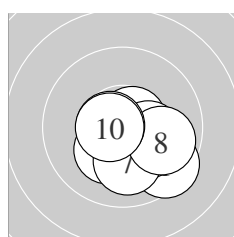
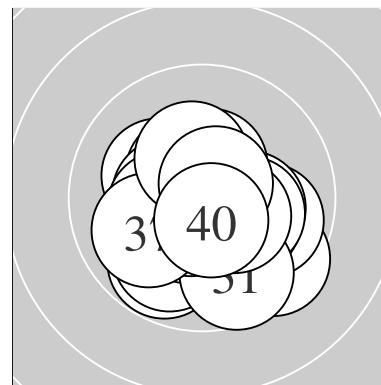

Serie 1:
 9.5 ↘ 10.7 * 10.2 * 10.6 * 10.3 *
 10.3 * 10.1 ↓ 9.9 ↗ 10.6 * 10.6 *
 beste Teiler 75.7 (2.) 80.6 (9.) 85.0 (10.)
 Trefferlage 0.65 mm rechts, 0.90 mm tief
 Streuwert 1.20, horizontal: 1.40, vertikal: 0.94

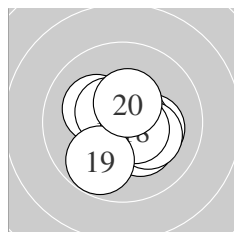

Serie 2:
 10.7 * 10.2 * 10.2 * 10.5 * 10.3 *
 10.6 * 10.2 * 10.6 * 9.8 ✓ 10.4 *
 beste Teiler 75.2 (11.) 80.1 (16.) 94.5 (18.)
 Trefferlage 0.18 mm rechts, 0.27 mm tief
 Streuwert 1.21, horizontal: 1.29, vertikal: 1.11

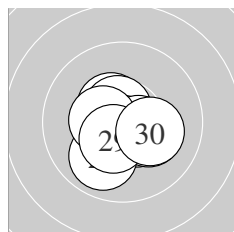

Serie 3:
 10.5 * 10.6 * 10.8 * 10.5 * 9.9 ✓
 10.5 * 10.2 * 10.4 * 10.5 * 10.2 *
 beste Teiler 48.3 (23.) 86.5 (22.) 114.4 (26.)
 Trefferlage 0.11 mm rechts, 0.43 mm tief
 Streuwert 1.05, horizontal: 1.17, vertikal: 0.92

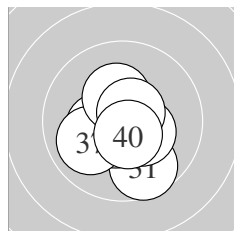

Serie 4:
 9.7 ↘ 10.4 * 10.6 * 10.3 * 10.7 *
 10.8 * 10.0 ↙ 10.3 * 10.6 * 10.6 *
 beste Teiler 29.0 (36.) 62.6 (35.) 78.5 (39.)
 Trefferlage 0.15 mm links, 0.45 mm tief
 Streuwert 1.16, horizontal: 1.10, vertikal: 1.22

Unterschrift des Schützen

Meyton Elektronik

EYL Rifle – Wertung – offene Klasse

StartNr: 17

StandNr: 144

9. Juni 2018 9:44

HAMMERL, Soma Richárd #1000000242

Hungary / Hungary

Ergebnis: **409.9** (392)
 Serien: 101.7 101.8 103.2 103.2
 Zähler: 32 8 0 0 0 0 0 0 0 0
 Innenzehner: 28
 weiteste: 404 (31), 348 (14), 334 (19)
 beste Teiler 54.6 (38.) 73.2 (22.) 75.4 (21.)
 Trefferlage 0.05 mm rechts, 0.12 mm hoch
 Streuwert 1.41, horizontal: 1.53, vertikal: 1.28

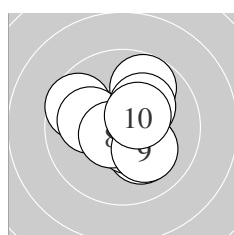
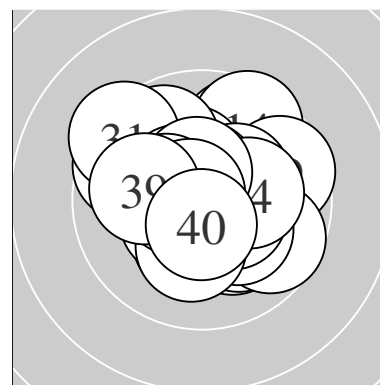

Serie 1:
 9.6 ↘ 9.8 ↗ 10.1 ↘ 10.6 * 10.1 ←
 10.2 * 10.2 * 10.6 * 10.1 ↘ 10.4 *
 beste Teiler 88.4 (8.) 99.7 (4.) 128.4 (10.)
 Trefferlage 0.23 mm rechts, 0.08 mm hoch
 Streuwert 1.55, horizontal: 1.64, vertikal: 1.46

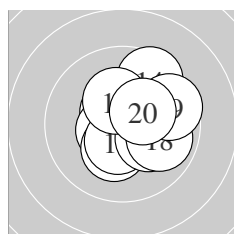

Serie 2:
 10.5 * 10.6 * 10.3 * 9.6 ↗ 10.5 *
 10.2 * 10.3 * 9.9 → 9.6 → 10.3 *
 beste Teiler 100.7 (12.) 104.0 (11.) 118.6 (15.)
 Trefferlage 0.76 mm rechts, 0.23 mm hoch
 Streuwert 1.48, horizontal: 1.50, vertikal: 1.47

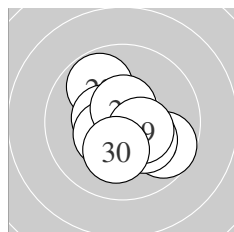

Serie 3:
 10.7 * 10.7 * 9.8 ↘ 10.5 * 9.7 ↘
 10.4 * 10.6 * 10.2 * 10.4 * 10.2 *
 beste Teiler 73.2 (22.) 75.4 (21.) 93.1 (27.)
 Trefferlage 0.00 mm , 0.24 mm tief
 Streuwert 1.33, horizontal: 1.38, vertikal: 1.28

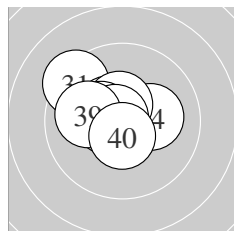

Serie 4:
 9.3 ↘ 10.6 * 10.5 * 10.2 * 10.5 *
 10.3 * 10.5 * 10.7 * 10.0 ← 10.6 *
 beste Teiler 54.6 (38.) 77.6 (32.) 100.0 (40.)
 Trefferlage 0.76 mm links, 0.40 mm hoch
 Streuwert 1.20, horizontal: 1.39, vertikal: 0.99

Unterschrift des Schützen

Meyton Elektronik