

Ergebnis: **609.7** (578)
 Serien: 99.7 100.5 103.1 101.7 102.5 102.2
 Zähler: 38 22 0 0 0 0 0 0 0
 Innenzehner: 32
 weiteste: 383 (60), 363 (8), 337 (2)
 beste Teiler 8.0 (51.) 13.8 (36.) 34.4 (21.)
 Trefferlage 0.14 mm links, 0.22 mm hoch
 Streuwert 1.56, horizontal: 1.68, vertikal: 1.43

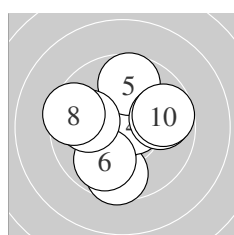

Serie 1:
 10.4 * 9.6 ↓ 10.5 * 10.6 * 9.7 ↑
 9.9 ↙ 10.0 ← 9.5 ← 9.8 → 9.7 →
 beste Teiler 78.7 (4.) 119.2 (3.) 149.2 (1.)
 Trefferlage 0.27 mm links, 0.12 mm tief
 Streuwert 1.94, horizontal: 2.05, vertikal: 1.83

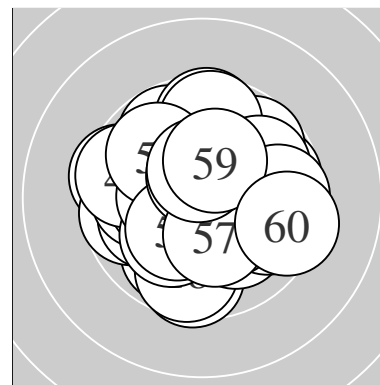
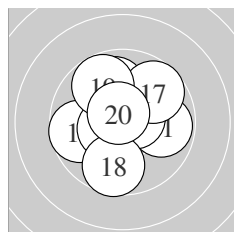

Serie 2:
 9.8 → 9.9 ↑ 10.1 ↘ 9.7 ← 10.5 *
 10.6 * 9.7 ↗ 9.7 ↓ 9.8 ↘ 10.7 *
 beste Teiler 71.5 (20.) 88.6 (16.) 112.4 (15.)
 Trefferlage 0.23 mm links, 0.55 mm hoch
 Streuwert 1.76, horizontal: 1.74, vertikal: 1.79

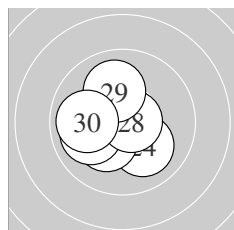

Serie 3:
 10.8 * 10.3 * 10.5 * 10.1 ↘ 10.3 *
 10.5 * 10.0 ← 10.7 * 10.0 ↑ 9.9 ←
 beste Teiler 34.4 (21.) 62.2 (28.) 110.7 (26.)
 Trefferlage 0.87 mm links, 0.06 mm tief
 Streuwert 1.16, horizontal: 1.23, vertikal: 1.08

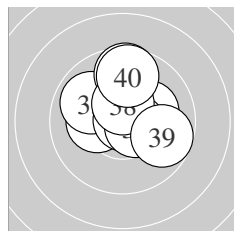

Serie 4:
 10.5 * 10.2 * 9.9 ↘ 10.2 * 9.6 ↑
 10.9 * 10.5 * 10.5 * 9.7 → 9.7 ↑
 beste Teiler 13.8 (36.) 101.3 (37.) 107.0 (31.)
 Trefferlage 0.12 mm rechts, 0.88 mm hoch
 Streuwert 1.51, horizontal: 1.55, vertikal: 1.46

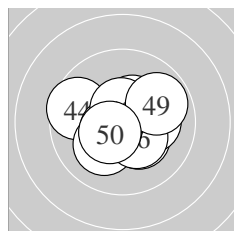

Serie 5:
 10.4 * 10.3 * 10.2 * 9.6 ← 10.1 ↙
 10.4 * 10.6 * 10.6 * 9.8 → 10.5 *
 beste Teiler 94.6 (48.) 96.8 (47.) 118.6 (50.)
 Trefferlage 0.09 mm rechts, 0.07 mm tief
 Streuwert 1.44, horizontal: 1.71, vertikal: 1.09

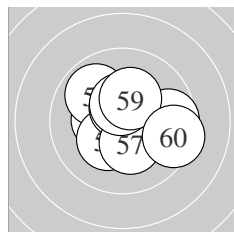

Serie 6:
 10.9 * 9.6 → 10.4 * 9.9 ↘ 10.3 *
 10.6 * 10.3 * 10.5 * 10.3 * 9.4 →
 beste Teiler 8.0 (51.) 97.4 (56.) 120.8 (58.)
 Trefferlage 0.32 mm rechts, 0.17 mm hoch
 Streuwert 1.57, horizontal: 1.85, vertikal: 1.23

Meyton Elektronik

ISSF AR Men Jun – Wertung – Junioren

StandNr: 102

Streicher, Sandro #71

StartNr: 93

18. Januar 2020 13:07

T-Ebbs

Unterschrift des Schützen

Meyton Elektronik

Ergebnis: **623.5** (591)^{QF}
 Serien: 105.7 103.3 103.2 103.4 104.6 103.3
 Zähler: 51 9 0 0 0 0 0 0 0
 Innenzehner: 50
 weiteste: 277 (30), 274 (55), 273 (20)
 beste Teiler 15.6 (7.) 16.1 (43.) 25.0 (49.)
 Trefferlage 0.07 mm rechts, 0.06 mm tief
 Streuwert 1.11, horizontal: 1.20, vertikal: 1.01

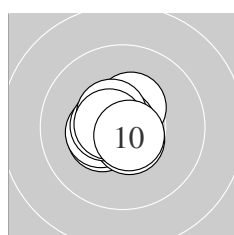
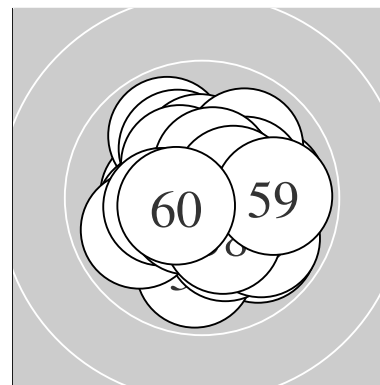

Serie 1:
 10.4 * 10.4 * 10.4 * 10.7 * 10.6 *
 10.5 * 10.9 * 10.5 * 10.6 * 10.7 *
 beste Teiler 15.6 (7.) 65.9 (4.) 67.0 (10.)
 Trefferlage 0.45 mm links, 0.06 mm hoch
 Streuwert 0.69, horizontal: 0.73, vertikal: 0.65

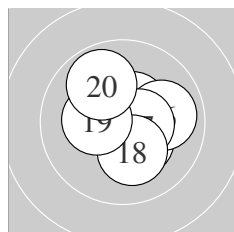

Serie 2:
 10.3 * 10.5 * 10.7 * 10.5 * 10.5 *
 9.9 → 10.5 * 10.2 * 10.3 * 9.9 ↖
 beste Teiler 55.9 (13.) 105.8 (17.) 110.8 (14.)
 Trefferlage 0.08 mm rechts, 0.26 mm hoch
 Streuwert 1.23, horizontal: 1.29, vertikal: 1.16

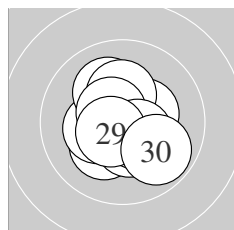

Serie 3:
 10.2 * 10.4 * 10.4 * 10.3 * 10.1 ↖
 10.3 * 10.6 * 10.5 * 10.6 * 9.8 ↘
 beste Teiler 95.0 (27.) 96.6 (29.) 123.5 (28.)
 Trefferlage 0.03 mm links, 0.14 mm tief
 Streuwert 1.25, horizontal: 1.21, vertikal: 1.28

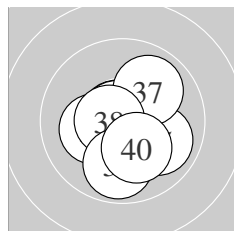

Serie 4:
 10.7 * 10.8 * 10.4 * 10.8 * 9.9 ↘
 10.2 * 9.9 ↗ 10.6 * 9.9 ↓ 10.2 *
 beste Teiler 36.1 (32.) 49.5 (34.) 53.9 (31.)
 Trefferlage 0.19 mm rechts, 0.42 mm tief
 Streuwert 1.26, horizontal: 1.25, vertikal: 1.28

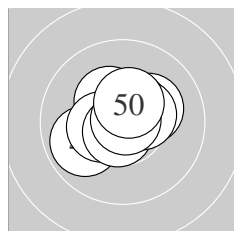

Serie 5:
 10.3 * 10.2 * 10.9 * 9.9 ↙ 10.5 *
 10.4 * 10.7 * 10.4 * 10.9 * 10.4 *
 beste Teiler 16.1 (43.) 25.0 (49.) 68.4 (47.)
 Trefferlage 0.08 mm links, 0.29 mm hoch
 Streuwert 1.03, horizontal: 1.20, vertikal: 0.83

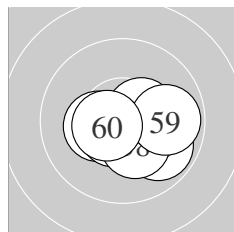

Serie 6:
 10.4 * 10.7 * 10.3 * 10.3 * 9.9 ↘
 10.4 * 10.6 * 10.3 * 9.9 → 10.5 *
 beste Teiler 62.2 (52.) 87.4 (57.) 103.4 (60.)
 Trefferlage 0.74 mm rechts, 0.45 mm tief
 Streuwert 1.08, horizontal: 1.39, vertikal: 0.63

Meyton Elektronik

ISSF AR Men Jun – Wertung – Junioren

StandNr: 103

Rohit, #374

StartNr: 94

18. Januar 2020 13:23

Indian Army

QF – Schütze hat sich fürs Finale qualifiziert

Unterschrift des Schützen

Meyton Elektronik

Ergebnis:	613.9	(589)							
Serien:	103.6	102.7	101.0	103.3	102.6	100.7			
Zähler:	50	9	1	0	0	0	0	0	0
Innenzehner:	35								
weiteste:	531 (21), 371 (56), 359 (46)								
beste Teiler	15.6 (3.)	17.6 (40.)	25.4 (17.)						
Trefferlage	0.31 mm links, 0.11 mm tief								
Streuwert	1.45, horizontal: 1.64, vertikal: 1.23								

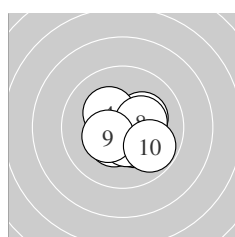
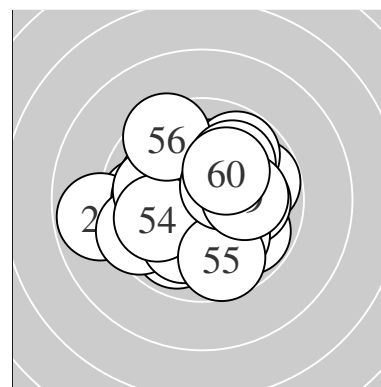

Serie 1:	10.2 *	10.4 *	10.9 *	10.3 *	10.5 *
	10.3 *	10.5 *	10.3 *	10.4 *	9.8 ↘
beste Teiler	15.6 (3.)	109.0 (5.)	119.5 (7.)		
Trefferlage	0.45 mm rechts, 0.40 mm tief				
Streuwert	1.12, horizontal: 1.25, vertikal: 0.97				

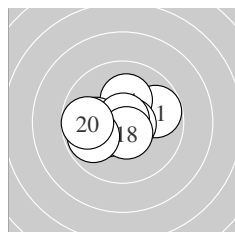

Serie 2:	9.8 →	10.3 *	10.7 *	10.2 *	10.0 ←
	10.7 *	10.9 *	10.6 *	9.8 ←	9.7 ←
beste Teiler	25.4 (17.)	66.2 (16.)	74.9 (13.)		
Trefferlage	0.49 mm links, 0.09 mm tief				
Streuwert	1.43, horizontal: 1.80, vertikal: 0.94				

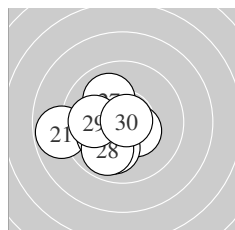

Serie 3:	8.8 ←	10.7 *	10.1 ↙	10.4 *	10.0 ↓
	10.3 *	10.0 ↘	9.9 ↙	10.0 ←	10.8 *
beste Teiler	35.4 (30.)	71.7 (22.)	132.5 (24.)		
Trefferlage	1.30 mm links, 0.47 mm tief				
Streuwert	1.53, horizontal: 1.71, vertikal: 1.32				

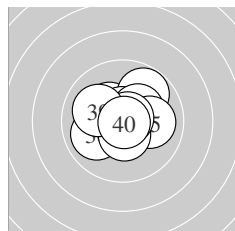

Serie 4:	10.3 *	9.8 ↗	10.7 *	10.3 *	10.0 →
	10.0 ←	10.5 *	10.8 *	10.0 ↖	10.9 *
beste Teiler	17.6 (40.)	50.2 (38.)	71.2 (33.)		
Trefferlage	0.06 mm rechts, 0.37 mm hoch				
Streuwert	1.31, horizontal: 1.52, vertikal: 1.06				

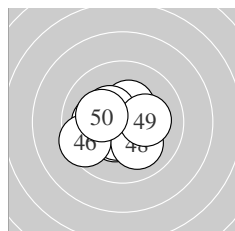

Serie 5:	10.8 *	10.4 *	10.4 *	10.1 ←	10.5 *
	9.5 ←	10.4 *	10.1 ↘	10.2 *	10.2 *
beste Teiler	49.2 (41.)	114.0 (45.)	133.8 (42.)		
Trefferlage	0.58 mm links, 0.22 mm tief				
Streuwert	1.36, horizontal: 1.57, vertikal: 1.10				

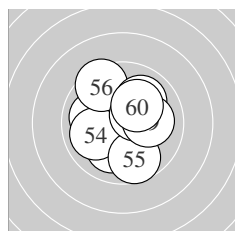

Serie 6:	10.7 *	10.1 ↓	10.0 ←	10.0 ←	9.7 ↓
	9.5 ↘	10.0 ↗	10.4 *	10.1 →	10.2 *
beste Teiler	66.6 (51.)	131.2 (58.)	193.8 (60.)		
Trefferlage	0.00 mm, 0.14 mm hoch				
Streuwert	1.78, horizontal: 1.70, vertikal: 1.85				

Meyton Elektronik

ISSF AR Men Jun – Wertung – Junioren

StandNr: 104

Bailly, Nahtan #375

StartNr: 95

18. Januar 2020 13:31

FRA

Unterschrift des Schützen

Meyton Elektronik

Ergebnis:	584.9	(563)
Serien:	97.3 95.8 97.2 97.7 100.5 96.4	
Zähler:	32 20 7 1 0 0 0 0 0	
Innenzehner:	23	
weiteste:	776 (35), 661 (15), 629 (21)	
beste Teiler	35.9 (34.) 64.8 (42.) 90.2 (24.)	
Trefferlage	0.18 mm links, 0.82 mm tief	
Streuwert	2.38, horizontal: 2.84, vertikal: 1.80	

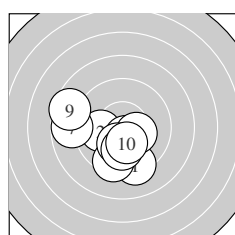
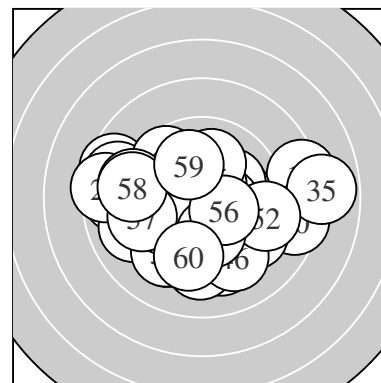

Serie 1:	9.3 ↓	10.0 ←	10.5 *	9.4 ↓	10.3 *
	10.2 *	8.8 ←	10.0 ↓	8.5 ↖	10.3 *
beste Teiler	104.4 (3.)	161.6 (5.)	174.6 (10.)		
Trefferlage	1.15 mm links, 1.36 mm tief				
Streuwert	2.21, horizontal: 2.58, vertikal: 1.76				

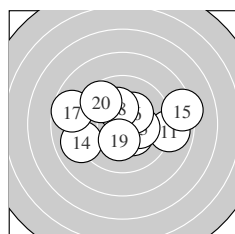

Serie 2:	8.9 →	10.3 *	10.2 *	9.0 ←	8.3 →
	10.3 *	8.7 ←	10.2 *	10.3 *	9.6 ↘
beste Teiler	159.1 (12.)	161.4 (16.)	173.9 (19.)		
Trefferlage	0.22 mm rechts, 0.23 mm hoch				
Streuwert	2.88, horizontal: 3.76, vertikal: 1.58				

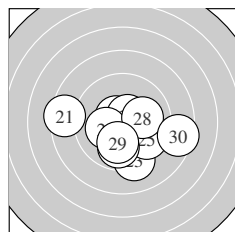

Serie 3:	8.4 ←	10.6 *	9.2 ↓	10.6 *	9.7 ↘
	10.2 *	9.9 ↓	10.1 →	10.0 ↓	8.5 →
beste Teiler	90.2 (24.)	93.0 (22.)	189.8 (26.)		
Trefferlage	0.27 mm rechts, 1.03 mm tief				
Streuwert	2.55, horizontal: 3.19, vertikal: 1.67				

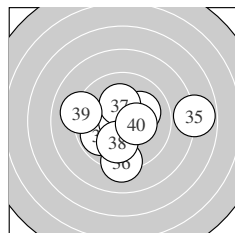

Serie 4:	10.2 *	9.9 ↖	10.1 ↗	10.8 *	7.8 →
	9.2 ↓	10.2 *	10.0 ↓	9.1 ←	10.4 *
beste Teiler	35.9 (34.)	150.0 (40.)	180.5 (37.)		
Trefferlage	0.10 mm rechts, 0.46 mm tief				
Streuwert	2.63, horizontal: 3.25, vertikal: 1.81				

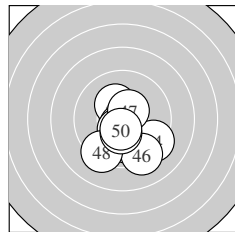

Serie 5:	10.3 *	10.7 *	9.9 ↓	9.3 ↘	10.5 *
	9.2 ↓	10.5 *	9.3 ↖	10.3 *	10.5 *
beste Teiler	64.8 (42.)	110.6 (47.)	111.6 (50.)		
Trefferlage	0.24 mm rechts, 1.40 mm tief				
Streuwert	1.64, horizontal: 1.54, vertikal: 1.74				

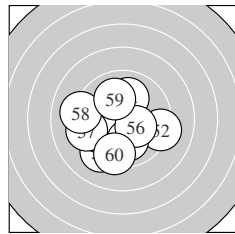

Serie 6:	9.3 ↗	9.2 →	9.8 ↖	10.0 ↑	10.0 ↓
	10.3 *	9.3 ←	9.1 ←	10.0 ↑	9.4 ↓
beste Teiler	162.9 (56.)	229.9 (54.)	231.1 (59.)		
Trefferlage	0.83 mm links, 0.90 mm tief				
Streuwert	2.36, horizontal: 2.62, vertikal: 2.08				

Meyton Elektronik

ISSF AR Men Jun – Wertung – Junioren

StandNr: 105

Rauer, Dominik #77

StartNr: 96

18. Januar 2020 13:23

VSB-NWLZ

Unterschrift des Schützen

Meyton Elektronik

Ergebnis: **627.8** (596)^{QF}
 Serien: 104.1 103.2 104.8 105.7 105.9 104.1
 Zähler: 56 4 0 0 0 0 0 0 0
 Innenzehner: 50
 weiteste: 300 (13), 263 (55), 255 (5)
 beste Teiler 12.2 (26.) 22.5 (2.) 22.8 (50.)
 Trefferlage 0.09 mm links, 0.31 mm hoch
 Streuwert 0.99, horizontal: 0.97, vertikal: 1.01

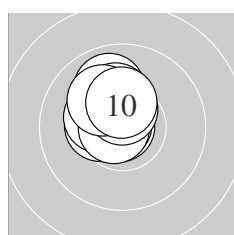
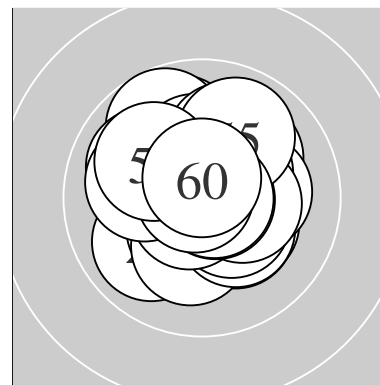

Serie 1:
 10.4 * 10.9 * 10.3 * 10.8 * 9.9 ↗
 10.7 * 10.2 * 10.5 * 10.1 ↖ 10.3 *
 beste Teiler 22.5 (2.) 42.9 (4.) 55.2 (6.)
 Trefferlage 0.67 mm links, 0.94 mm hoch
 Streuwert 0.74, horizontal: 0.55, vertikal: 0.89

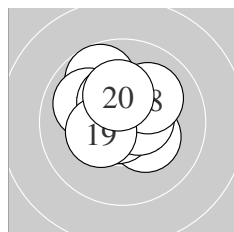

Serie 2:
 10.6 * 10.3 * 9.8 ↗ 10.0 ↖ 10.8 *
 10.5 * 10.4 * 10.1 ↗ 10.4 * 10.3 *
 beste Teiler 47.0 (15.) 79.7 (11.) 102.2 (16.)
 Trefferlage 0.19 mm links, 0.73 mm hoch
 Streuwert 1.20, horizontal: 1.26, vertikal: 1.14

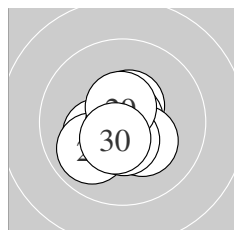

Serie 3:
 10.3 * 10.5 * 10.8 * 9.9 ↗ 10.5 *
 10.9 * 10.3 * 10.5 * 10.6 * 10.5 *
 beste Teiler 12.2 (26.) 36.8 (23.) 95.6 (29.)
 Trefferlage 0.15 mm links, 0.46 mm tief
 Streuwert 0.95, horizontal: 0.96, vertikal: 0.94

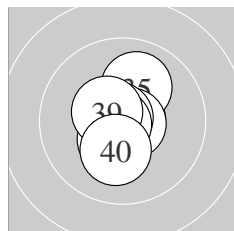

Serie 4:
 10.7 * 10.8 * 10.4 * 10.8 * 10.0 ↗
 10.7 * 10.8 * 10.8 * 10.5 * 10.2 *
 beste Teiler 37.4 (34.) 38.2 (37.) 46.9 (38.)
 Trefferlage 0.16 mm links, 0.01 mm hoch
 Streuwert 0.84, horizontal: 0.58, vertikal: 1.04

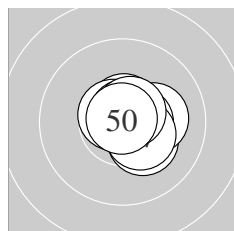

Serie 5:
 10.8 * 10.3 * 10.2 * 10.6 * 10.6 *
 10.7 * 10.4 * 10.8 * 10.6 * 10.9 *
 beste Teiler 22.8 (50.) 47.1 (48.) 47.8 (41.)
 Trefferlage 0.58 mm rechts, 0.09 mm hoch
 Streuwert 0.68, horizontal: 0.74, vertikal: 0.61

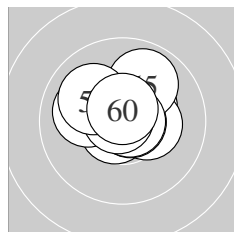

Serie 6:
 10.3 * 10.7 * 10.3 * 10.7 * 9.9 ↗
 10.8 * 10.0 ↖ 10.8 * 10.0 ↖ 10.6 *
 beste Teiler 33.2 (58.) 46.0 (56.) 51.4 (54.)
 Trefferlage 0.01 mm rechts, 0.54 mm hoch
 Streuwert 1.07, horizontal: 1.26, vertikal: 0.85

Meyton Elektronik

ISSF AR Men Jun – Wertung – Junioren

StandNr: 106

Destefanis, Bastien #376

StartNr: 97

18. Januar 2020 13:42

FRA

QF – Schütze hat sich fürs Finale qualifiziert

Unterschrift des Schützen

Meyton Elektronik

Ergebnis:	592.1	(564)
Serien:	101.4 97.8 99.6 96.8 96.8 99.7	
Zähler:	30 27 0 3 0 0 0 0 0 0	
Innenzehner:	21	
weiteste:	929 (40), 875 (50), 765 (12)	
beste Teiler	1.0 (36.) 34.9 (3.) 53.5 (4.)	
Trefferlage	0.41 mm links, 0.53 mm tief	
Streuwert	2.26, horizontal: 2.42, vertikal: 2.09	

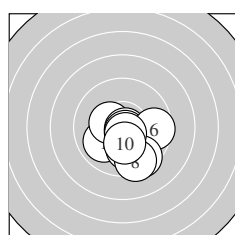
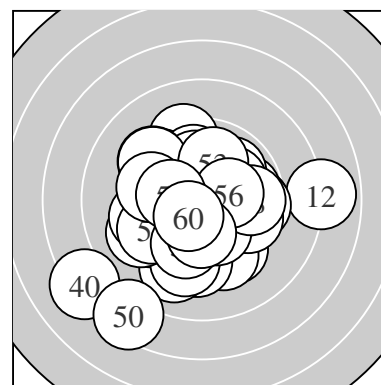

Serie 1:	10.0 ↙	10.4 *	10.8 *	10.7 *	10.0 ↓
	9.6 →	9.5 ↘	9.4 ↘	10.7 *	10.3 *
beste Teiler	34.9 (3.)	53.5 (4.)	75.6 (9.)		
Trefferlage	0.49 mm rechts, 1.33 mm tief				
Streuwert	1.45, horizontal: 1.53, vertikal: 1.35				

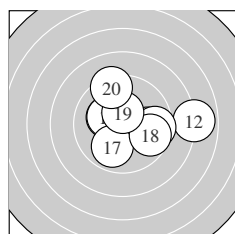

Serie 2:	9.9 →	7.9 →	10.6 *	10.2 *	9.6 →
	10.2 *	9.9 ↓	9.7 →	10.5 *	9.3 ↑
beste Teiler	97.2 (13.)	125.0 (19.)	176.6 (16.)		
Trefferlage	1.02 mm rechts, 0.26 mm hoch				
Streuwert	2.47, horizontal: 3.07, vertikal: 1.66				

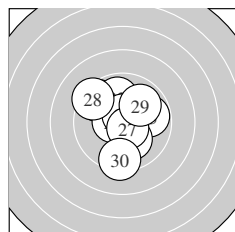

Serie 3:	9.5 ↘	9.9 ↑	10.5 *	10.6 *	9.8 →
	10.1 ↘	10.6 *	9.3 ↘	9.9 ↗	9.4 ↓
beste Teiler	77.1 (24.)	85.1 (27.)	102.0 (23.)		
Trefferlage	0.15 mm links, 0.41 mm hoch				
Streuwert	1.99, horizontal: 1.86, vertikal: 2.12				

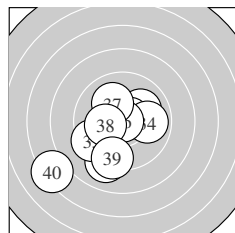

Serie 4:	10.1 ↗	9.1 ↓	10.6 *	9.9 →	9.4 ↙
	10.9 *	10.1 ↘	10.2 *	9.3 ↓	7.2 ↙
beste Teiler	1.0 (36.)	80.7 (33.)	188.9 (38.)		
Trefferlage	1.13 mm links, 1.29 mm tief				
Streuwert	2.70, horizontal: 2.89, vertikal: 2.51				

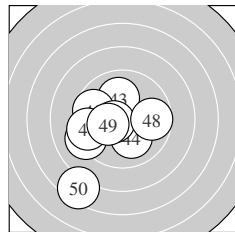

Serie 5:	10.2 *	9.2 ↙	10.1 ↑	10.1 ↓	9.7 ↖
	9.4 ↖	10.6 *	9.7 →	10.3 *	7.5 ↓
beste Teiler	96.4 (47.)	166.6 (49.)	190.8 (41.)		
Trefferlage	1.62 mm links, 1.04 mm tief				
Streuwert	2.49, horizontal: 2.42, vertikal: 2.56				

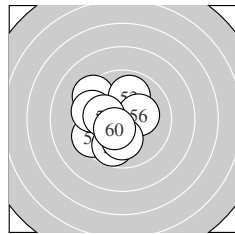

Serie 6:	9.5 ↙	9.4 ↘	9.9 ↑	10.7 *	9.8 ↓
	10.2 *	10.1 ↓	9.6 ↖	10.1 ↖	10.4 *
beste Teiler	63.0 (54.)	135.5 (60.)	176.3 (56.)		
Trefferlage	1.11 mm links, 0.20 mm tief				
Streuwert	1.79, horizontal: 1.76, vertikal: 1.82				

Meyton Elektronik

ISSF AR Men Jun – Wertung – Junioren

StandNr: 107

Schippel, Pascal #76

StartNr: 98

18. Januar 2020 13:33

VSB-NWLZ

Unterschrift des Schützen

Meyton Elektronik

Ergebnis:	617.0	(590)					
Serien:	102.0	102.7	103.0	103.4	102.1	103.8	
Zähler:	50	10	0	0	0	0	0
Innenzehner:	39						
weiteste:	374 (19), 337 (28), 310 (4)						
beste Teiler	29.2 (24.) 43.8 (32.) 50.4 (55.)						
Trefferlage	0.14 mm links, 0.19 mm hoch						
Streuwert	1.32, horizontal: 1.34, vertikal: 1.30						

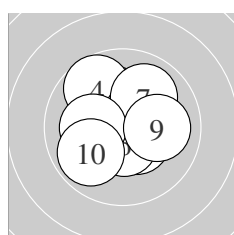
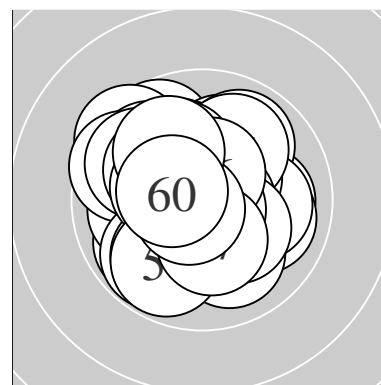

Serie 1:	10.4 *	10.6 *	10.2 *	9.7 ↘	10.5 *
	10.5 *	10.0 ↗	10.2 *	10.0 →	9.9 ↙
beste Teiler	97.0 (2.) 105.5 (6.) 112.0 (5.)				
Trefferlage	0.14 mm links, 0.40 mm hoch				
Streuwert	1.48, horizontal: 1.53, vertikal: 1.42				

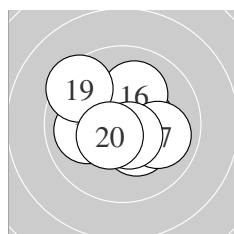

Serie 2:	10.3 *	10.4 *	10.6 *	10.7 *	10.0 ←
	10.1 ↗	10.0 →	10.6 *	9.5 ↘	10.5 *
beste Teiler	58.0 (14.) 87.8 (18.) 99.6 (13.)				
Trefferlage	0.06 mm rechts, 0.08 mm hoch				
Streuwert	1.45, horizontal: 1.65, vertikal: 1.22				

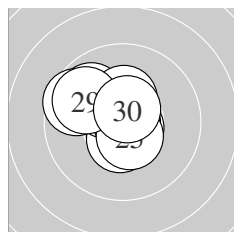

Serie 3:	10.7 *	10.5 *	10.3 *	10.8 *	10.5 *
	9.9 ↘	10.3 *	9.6 ↘	9.8 ↘	10.6 *
beste Teiler	29.2 (24.) 64.4 (21.) 91.0 (30.)				
Trefferlage	0.72 mm links, 0.55 mm hoch				
Streuwert	1.23, horizontal: 1.36, vertikal: 1.08				

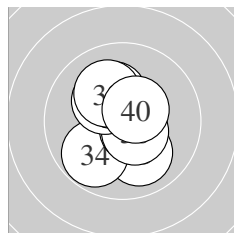

Serie 4:	10.7 *	10.8 *	10.0 ↘	9.8 ↙	10.6 *
	10.5 *	10.2 *	10.2 *	10.1 ↘	10.5 *
beste Teiler	43.8 (32.) 62.4 (31.) 87.6 (35.)				
Trefferlage	0.03 mm links, 0.04 mm tief				
Streuwert	1.26, horizontal: 1.04, vertikal: 1.45				

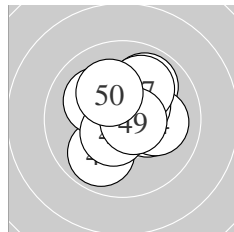

Serie 5:	9.9 ↙	10.3 *	9.9 ↗	10.1 →	10.4 *
	10.1 ↘	10.0 ↗	10.5 *	10.7 *	10.2 *
beste Teiler	73.1 (49.) 109.5 (48.) 132.3 (45.)				
Trefferlage	0.35 mm rechts, 0.42 mm hoch				
Streuwert	1.42, horizontal: 1.40, vertikal: 1.43				

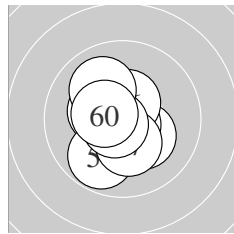

Serie 6:	10.3 *	10.6 *	10.3 *	9.8 ↙	10.8 *
	10.5 *	10.3 *	10.7 *	10.0 ↘	10.5 *
beste Teiler	50.4 (55.) 63.2 (58.) 95.0 (52.)				
Trefferlage	0.41 mm links, 0.27 mm tief				
Streuwert	1.14, horizontal: 0.97, vertikal: 1.30				

Meyton Elektronik

ISSF AR Men Jun – Wertung – Junioren

StandNr: 108

Privratsky, Jiri #10

StartNr: 99

18. Januar 2020 13:34

CZE

Unterschrift des Schützen

Meyton Elektronik

Ergebnis:	624.5	(595) ^{QF}							
Serien:	102.8	103.6	104.2	104.3	104.8	104.8			
Zähler:	55	5	0	0	0	0	0	0	0
Innenzehner:	48								
weiteste:	387	(2), 380	(11), 321	(35)					
beste Teiler	7.8	(42.)	11.6	(59.)	34.3	(17.)			
Trefferlage	0.11	mm links,	0.40	mm hoch					
Streuwert	1.09,	horizontal:	0.87,	vertikal:	1.28				

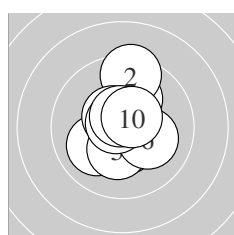
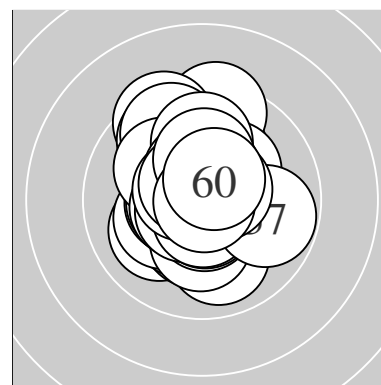

Serie 1:	10.1 ↑	9.4 ↑	10.0 ↙	10.5 *	10.3 *	
	10.1 →	10.5 *	10.7 *	10.6 *	10.6 *	
beste Teiler	57.4	(8.)	82.2	(9.)	99.8	(10.)
Trefferlage	0.04	mm rechts,	0.35	mm hoch		
Streuwert	1.40,	horizontal:	1.02,	vertikal:	1.70	

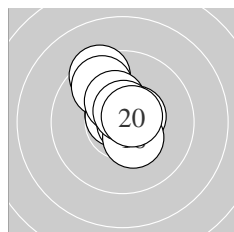

Serie 2:	9.4 ↖	10.6 *	10.5 *	9.7 ↗	10.7 *	
	10.3 *	10.8 *	10.4 *	10.6 *	10.6 *	
beste Teiler	34.3	(17.)	65.2	(15.)	80.1	(12.)
Trefferlage	0.19	mm links,	0.91	mm hoch		
Streuwert	1.13,	horizontal:	0.92,	vertikal:	1.31	

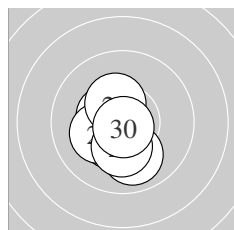

Serie 3:	10.7 *	10.0 ↓	10.4 *	10.5 *	10.5 *	
	10.5 *	10.2 *	10.2 *	10.4 *	10.8 *	
beste Teiler	37.4	(30.)	52.2	(21.)	101.7	(26.)
Trefferlage	0.48	mm links,	0.66	mm tief		
Streuwert	0.89,	horizontal:	0.66,	vertikal:	1.08	

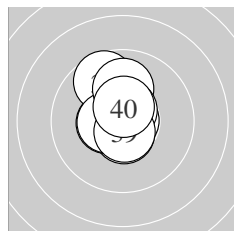

Serie 4:	10.6 *	10.8 *	10.5 *	10.5 *	9.7 ↖	
	10.5 *	10.0 ↑	10.6 *	10.6 *	10.5 *	
beste Teiler	43.2	(32.)	78.2	(39.)	84.1	(38.)
Trefferlage	0.25	mm links,	0.64	mm hoch		
Streuwert	1.01,	horizontal:	0.67,	vertikal:	1.27	

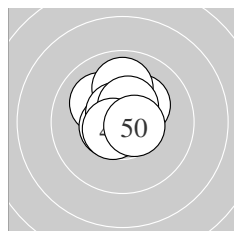

Serie 5:	10.1 ↘	10.9 *	10.2 *	10.7 *	10.0 ↑	
	10.6 *	10.6 *	10.5 *	10.6 *	10.6 *	
beste Teiler	7.8	(42.)	72.5	(44.)	81.8	(47.)
Trefferlage	0.11	mm links,	0.66	mm hoch		
Streuwert	0.91,	horizontal:	0.86,	vertikal:	0.95	

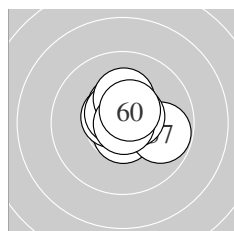

Serie 6:	10.7 *	10.6 *	10.5 *	10.6 *	10.4 *	
	10.2 *	9.8 →	10.6 *	10.9 *	10.5 *	
beste Teiler	11.6	(59.)	72.1	(51.)	89.8	(54.)
Trefferlage	0.29	mm rechts,	0.52	mm hoch		
Streuwert	0.92,	horizontal:	1.00,	vertikal:	0.83	

Meyton Elektronik

ISSF AR Men Jun – Wertung – Junioren

StandNr: 109

Sandeep, #377

StartNr: 100

18. Januar 2020 13:32

Indian Army

QF – Schütze hat sich fürs Finale qualifiziert

Unterschrift des Schützen

Meyton Elektronik

Ergebnis: **617.5** (594)
 Serien: 102.8 103.4 103.3 103.3 101.1 103.6
 Zähler: 54 6 0 0 0 0 0 0 0
 Innenzehner: 43
 weiteste: 352 (49), 311 (46), 293 (2)
 beste Teiler 51.8 (24.) 54.7 (56.) 55.9 (15.)
 Trefferlage 0.07 mm rechts, 0.23 mm hoch
 Streuwert 1.26, horizontal: 1.39, vertikal: 1.12

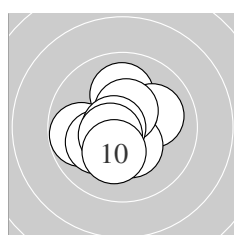
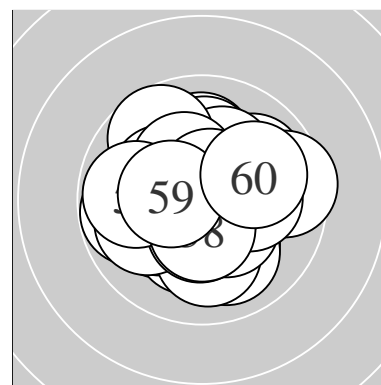

Serie 1:
 10.0 ↑ 9.8 ← 10.5 * 10.1 ↙ 10.1 →
 10.4 * 10.5 * 10.7 * 10.5 * 10.2 *
 beste Teiler 62.1 (8.) 102.6 (9.) 117.6 (7.)
 Trefferlage 0.29 mm links, 0.01 mm tief
 Streuwert 1.33, horizontal: 1.40, vertikal: 1.25

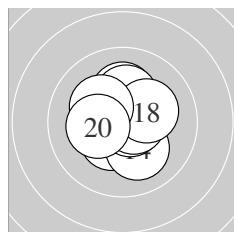

Serie 2:
 10.2 * 10.5 * 10.4 * 10.1 ↘ 10.7 *
 10.2 * 10.6 * 10.2 * 10.2 * 10.3 *
 beste Teiler 55.9 (15.) 78.0 (17.) 114.5 (12.)
 Trefferlage 0.03 mm links, 0.31 mm hoch
 Streuwert 1.17, horizontal: 1.11, vertikal: 1.22

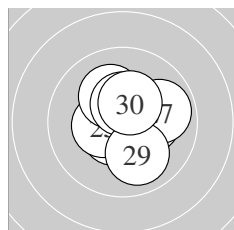

Serie 3:
 10.2 * 10.5 * 10.6 * 10.7 * 10.4 *
 10.2 * 9.9 → 10.4 * 10.0 ↘ 10.4 *
 beste Teiler 51.8 (24.) 91.4 (23.) 101.0 (22.)
 Trefferlage 0.34 mm rechts, 0.31 mm hoch
 Streuwert 1.20, horizontal: 1.22, vertikal: 1.17

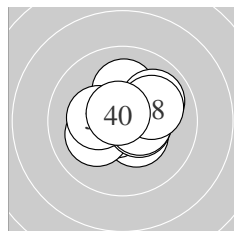

Serie 4:
 10.4 * 10.7 * 10.1 ↙ 10.5 * 10.1 ↑
 9.9 ↗ 10.5 * 10.1 → 10.3 * 10.7 *
 beste Teiler 61.2 (32.) 63.1 (40.) 119.8 (34.)
 Trefferlage 0.32 mm rechts, 0.25 mm hoch
 Streuwert 1.22, horizontal: 1.40, vertikal: 1.00

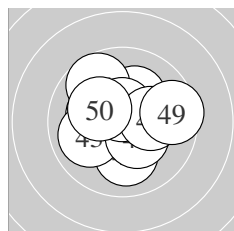

Serie 5:
 10.1 ↓ 10.2 * 10.0 ↙ 10.4 * 10.2 *
 9.7 ↘ 10.6 * 10.2 * 9.5 → 10.2 *
 beste Teiler 87.0 (47.) 143.5 (44.) 181.6 (42.)
 Trefferlage 0.01 mm rechts, 0.33 mm hoch
 Streuwert 1.65, horizontal: 1.87, vertikal: 1.40

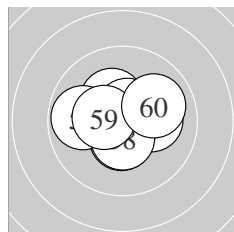

Serie 6:
 10.3 * 10.5 * 10.2 * 9.8 ← 10.6 *
 10.7 * 10.6 * 10.5 * 10.4 * 10.0 →
 beste Teiler 54.7 (56.) 81.9 (57.) 90.8 (55.)
 Trefferlage 0.08 mm rechts, 0.21 mm hoch
 Streuwert 1.21, horizontal: 1.47, vertikal: 0.86

Meyton Elektronik

ISSF AR Men Jun – Wertung – Junioren

StandNr: 111

Mompach, Nicolas #318

StartNr: 102

18. Januar 2020 13:43

FRA

Unterschrift des Schützen

Meyton Elektronik

Ergebnis:	620.1	(591)						
Serien:	105.0	102.3	104.8	103.7	101.5	102.8		
Zähler:	51	9	0	0	0	0	0	0
Innenzehner:	46							
weiteste:	456 (13), 414 (43), 272 (33)							
beste Teiler	30.2 (21.) 33.0 (59.) 36.2 (17.)							
Trefferlage	0.00 mm , 0.25 mm hoch							
Streuwert	1.24, horizontal: 1.23, vertikal: 1.26							

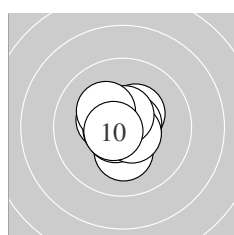
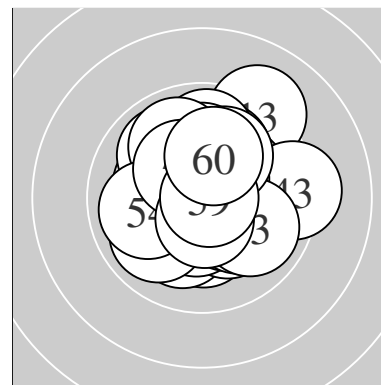

Serie 1:					
	10.2 *	10.4 *	10.4 *	10.7 *	10.6 *
	10.6 *	10.6 *	10.6 *	10.2 *	10.7 *
beste Teiler	70.2 (4.) 75.7 (10.) 76.8 (6.)				
Trefferlage	0.19 mm links, 0.07 mm hoch				
Streuwert	0.88, horizontal: 0.84, vertikal: 0.92				

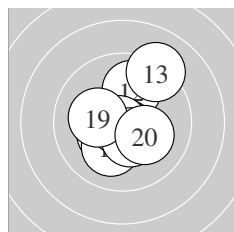

Serie 2:					
	10.3 *	9.9 ↑	9.1 ↗	10.7 *	10.6 *
	10.1 ↘	10.8 *	10.4 *	10.2 *	10.2 *
beste Teiler	36.2 (17.) 62.1 (14.) 89.0 (15.)				
Trefferlage	0.19 mm rechts, 0.01 mm hoch				
Streuwert	1.56, horizontal: 1.33, vertikal: 1.77				

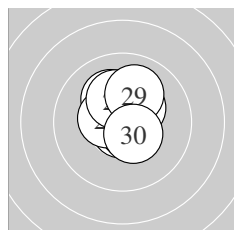

Serie 3:					
	10.8 *	10.7 *	10.8 *	10.2 *	10.4 *
	10.7 *	10.5 *	10.2 *	10.0 ↑	10.5 *
beste Teiler	30.2 (21.) 49.7 (23.) 75.0 (26.)				
Trefferlage	0.12 mm rechts, 0.43 mm hoch				
Streuwert	0.97, horizontal: 0.79, vertikal: 1.13				

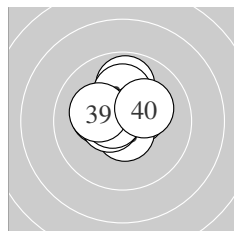

Serie 4:					
	10.7 *	10.3 *	9.9 ↑	10.1 ↑	10.5 *
	10.6 *	10.6 *	10.6 *	10.2 *	10.2 *
beste Teiler	59.5 (31.) 78.1 (38.) 82.9 (36.)				
Trefferlage	0.25 mm links, 0.71 mm hoch				
Streuwert	1.07, horizontal: 1.11, vertikal: 1.03				

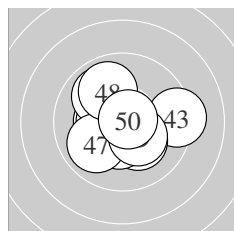

Serie 5:					
	10.4 *	10.4 *	9.3 →	10.2 *	10.4 *
	9.9 ↙	9.9 ↘	9.9 ↘	10.3 *	10.8 *
beste Teiler	45.6 (50.) 129.2 (42.) 136.4 (45.)				
Trefferlage	0.09 mm links, 0.05 mm tief				
Streuwert	1.65, horizontal: 1.88, vertikal: 1.38				

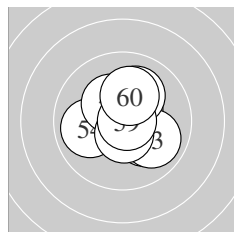

Serie 6:					
	10.1 ↘	10.5 *	9.9 ↘	9.9 ←	10.4 *
	10.3 *	10.1 ↑	10.6 *	10.8 *	10.2 *
beste Teiler	33.0 (59.) 95.7 (58.) 118.1 (52.)				
Trefferlage	0.27 mm rechts, 0.33 mm hoch				
Streuwert	1.31, horizontal: 1.33, vertikal: 1.29				

Meyton Elektronik

ISSF AR Men Jun – Wertung – Junioren

StandNr: 112

Mair, Tobias #5

StartNr: 103

18. Januar 2020 13:34

AUT

Unterschrift des Schützen

Meyton Elektronik

Ergebnis:	599.5	(572)
Serien:	97.7	102.4 99.0 101.2 99.5 99.7
Zähler:	36	20 4 0 0 0 0 0 0 0
Innenzehner:	30	
weiteste:	634	(10), 597 (22), 573 (4)
beste Teiler	60.1	(38.) 65.0 (1.) 65.4 (34.)
Trefferlage	0.17	mm links, 0.75 mm hoch
Streuwert	1.89,	horizontal: 2.27, vertikal: 1.43

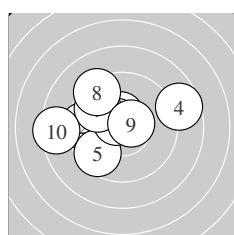
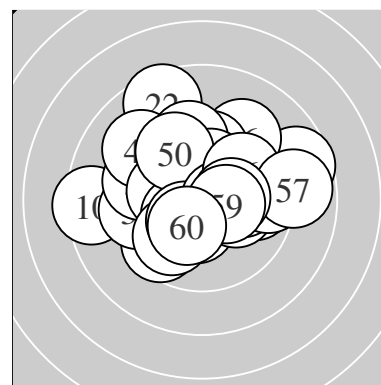

Serie 1:	10.7 *	9.5 ←	10.5 *	8.7 →	9.6 ↘
	10.6 *	9.8 ↖	9.3 ↖	10.6 *	8.4 ←
beste Teiler	65.0	(1.) 77.2 (6.) 89.1 (9.)			
Trefferlage	1.18	mm links, 0.70 mm hoch			
Streuwert	2.46,	horizontal: 3.12, vertikal: 1.55			

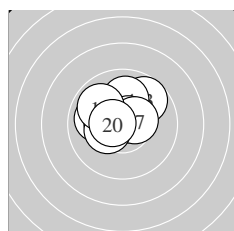

Serie 2:	10.0 ↖	10.3 *	9.7 ↗	10.0 ↑	10.4 *
	10.7 *	10.5 *	10.3 *	9.9 ↖	10.6 *
beste Teiler	69.4	(16.) 97.5 (20.) 121.7 (17.)			
Trefferlage	0.36	mm links, 0.86 mm hoch			
Streuwert	1.27,	horizontal: 1.50, vertikal: 0.99			

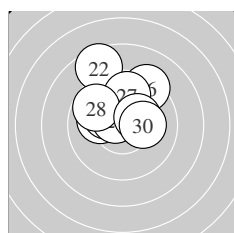

Serie 3:	10.1 ↖	8.6 ↖	10.2 *	10.2 *	10.6 *
	9.3 ↗	9.8 ↑	9.7 ↖	10.3 *	10.2 *
beste Teiler	85.8	(25.) 160.1 (29.) 179.7 (23.)			
Trefferlage	0.25	mm links, 1.81 mm hoch			
Streuwert	1.77,	horizontal: 1.82, vertikal: 1.72			

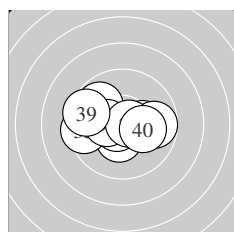

Serie 4:	9.8 ↖	10.4 *	9.5 ←	10.7 *	10.2 *
	9.8 →	10.4 *	10.7 *	9.5 ↖	10.2 *
beste Teiler	60.1	(38.) 65.4 (34.) 142.8 (32.)			
Trefferlage	0.42	mm links, 0.01 mm hoch			
Streuwert	1.75,	horizontal: 2.31, vertikal: 0.88			

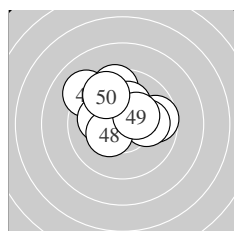

Serie 5:	9.7 →	10.0 →	10.5 *	9.1 ↖	9.6 ↑
	10.1 ↖	10.2 *	10.3 *	10.3 *	9.7 ↖
beste Teiler	115.6	(43.) 152.1 (49.) 153.1 (48.)			
Trefferlage	0.25	mm links, 1.29 mm hoch			
Streuwert	1.75,	horizontal: 2.05, vertikal: 1.39			

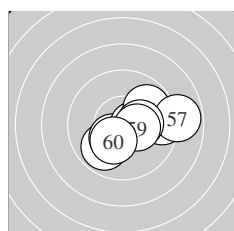

Serie 6:	10.0 →	9.9 ↘	9.4 →	10.3 *	10.5 *
	9.8 ↗	8.8 →	10.3 *	10.4 *	10.3 *
beste Teiler	104.0	(55.) 139.0 (59.) 153.5 (54.)			
Trefferlage	1.42	mm rechts, 0.16 mm tief			
Streuwert	1.73,	horizontal: 2.18, vertikal: 1.11			

Meyton Elektronik

ISSF AR Men Jun – Wertung – Junioren

StandNr: 113

Gugele, Florian #220

StartNr: 104

18. Januar 2020 13:02

VSB-NWLZ

Unterschrift des Schützen

Meyton Elektronik

ISSF AR Men Jun – Wertung – Junioren

StandNr: 114

Danzl, Jakob #282

StartNr: 105

18. Januar 2020 13:18

T – SG Schwaz

Unterschrift des Schützen

Meyton Elektronik

Ergebnis:	592.4	(562)						
Serien:	98.2	98.7	94.0	98.1	101.9	101.5		
Zähler:	30	22	8	0	0	0	0	0
Innenzehner:	25							
weiteste:	725 (21), 576 (4), 562 (20)							
beste Teiler	21.0 (59.) 25.7 (48.) 56.2 (55.)							
Trefferlage	0.51 mm links, 0.20 mm hoch							
Streuwert	2.24, horizontal: 2.76, vertikal: 1.56							

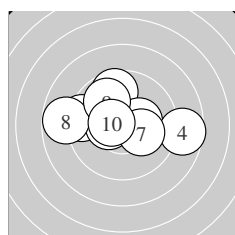
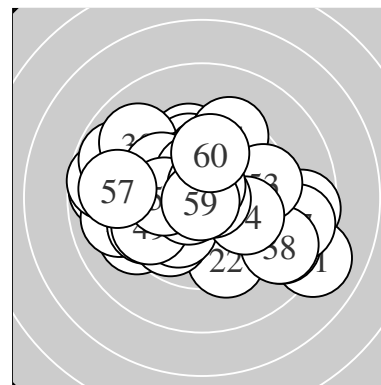

Serie 1:	9.6 ↑	9.4 ←	10.3 *	8.6 →	10.5 *
	10.4 *	10.2 *	8.8 ←	9.9 ↘	10.5 *
beste Teiler	108.4 (10.) 108.7 (5.) 133.3 (6.)				
Trefferlage	0.59 mm links, 0.58 mm hoch				
Streuwert	2.36, horizontal: 3.10, vertikal: 1.22				

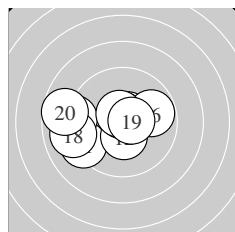

Serie 2:	9.2 ↙	10.4 *	10.6 *	9.1 ←	10.7 *
	9.8 →	10.6 *	9.0 ←	10.6 *	8.7 ←
beste Teiler	64.1 (15.) 81.8 (13.) 85.1 (19.)				
Trefferlage	1.48 mm links, 0.02 mm tief				
Streuwert	2.19, horizontal: 2.90, vertikal: 1.11				

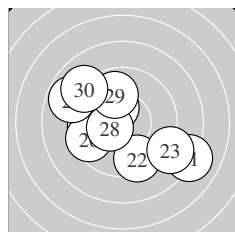

Serie 3:	8.1 ↘	9.5 ↓	8.8 ↘	10.3 *	9.7 ←
	9.5 ↙	8.8 ↖	10.4 *	9.9 ↑	9.0 ↘
beste Teiler	133.0 (28.) 155.2 (24.) 271.5 (29.)				
Trefferlage	0.51 mm links, 0.27 mm tief				
Streuwert	3.14, horizontal: 3.66, vertikal: 2.52				

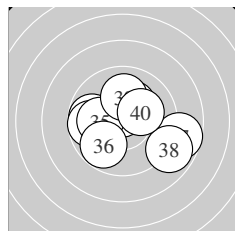

Serie 4:	9.8 ←	10.2 *	9.7 ←	10.7 *	10.1 ←
	9.8 ↙	8.7 →	8.9 ↘	10.0 ↑	10.2 *
beste Teiler	69.8 (34.) 186.3 (32.) 194.0 (40.)				
Trefferlage	0.26 mm rechts, 0.08 mm tief				
Streuwert	2.38, horizontal: 2.95, vertikal: 1.62				

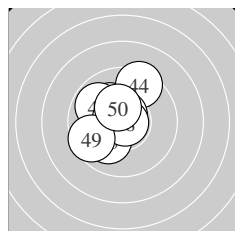

Serie 5:	10.1 ↖	10.2 *	10.1 ↙	9.4 ↑	9.8 ↖
	10.7 *	10.7 *	10.9 *	9.6 ↙	10.4 *
beste Teiler	25.7 (48.) 72.0 (46.) 72.0 (47.)				
Trefferlage	0.88 mm links, 0.65 mm hoch				
Streuwert	1.46, horizontal: 1.34, vertikal: 1.57				

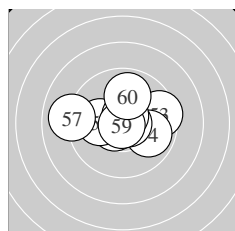

Serie 6:	10.6 *	10.2 *	9.5 →	9.9 ↘	10.7 *
	10.1 ←	9.0 ←	10.7 *	10.9 *	9.9 ↑
beste Teiler	21.0 (59.) 56.2 (55.) 74.3 (58.)				
Trefferlage	0.11 mm rechts, 0.36 mm hoch				
Streuwert	1.82, horizontal: 2.38, vertikal: 0.97				

Meyton Elektronik

ISSF AR Men Jun – Wertung – Junioren

StandNr: 115

Mathis, Elias #79

StartNr: 106

18. Januar 2020 13:20

VSB-NWLZ

Unterschrift des Schützen

Meyton Elektronik

Ergebnis: **611.9** (588)
 Serien: 103.1 101.5 101.4 102.3 104.2 99.4
 Zähler: 49 10 1 0 0 0 0 0 0
 Innenzehner: 34
 weiteste: 627 (59), 464 (21), 391 (15)
 beste Teiler 10.0 (35.) 16.6 (41.) 26.4 (8.)
 Trefferlage 0.14 mm links, 0.07 mm hoch
 Streuwert 1.53, horizontal: 1.68, vertikal: 1.36

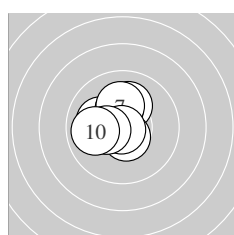
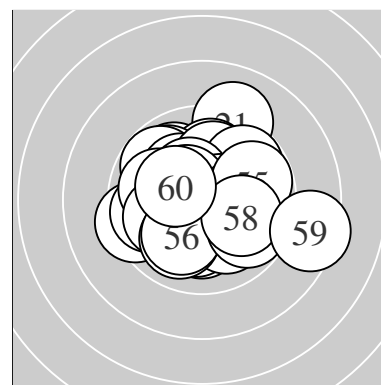

Serie 1:
 10.6 * 10.1 ↑ 10.6 * 10.1 ← 10.1 ↖
 10.3 * 10.2 * 10.8 * 10.4 * 9.9 ←
 beste Teiler 26.4 (8.) 85.9 (1.) 96.2 (3.)
 Trefferlage 0.84 mm links, 0.53 mm hoch
 Streuwert 1.06, horizontal: 1.09, vertikal: 1.03

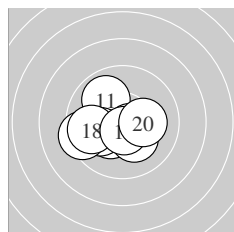

Serie 2:
 9.9 ↘ 10.3 * 10.1 ↙ 10.6 * 9.4 ←
 10.4 * 10.2 * 9.8 ← 10.6 * 10.2 *
 beste Teiler 80.4 (19.) 87.4 (14.) 145.0 (16.)
 Trefferlage 0.64 mm links, 0.56 mm tief
 Streuwert 1.52, horizontal: 1.89, vertikal: 1.01

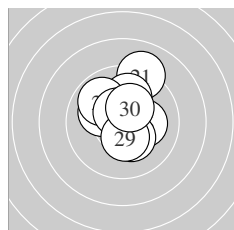

Serie 3:
 9.1 ↑ 10.1 ↖ 10.0 ↑ 9.9 ↘ 10.5 *
 10.2 * 10.3 * 10.5 * 10.4 * 10.4 *
 beste Teiler 104.7 (28.) 112.3 (25.) 140.0 (29.)
 Trefferlage 0.21 mm rechts, 0.97 mm hoch
 Streuwert 1.52, horizontal: 1.31, vertikal: 1.71

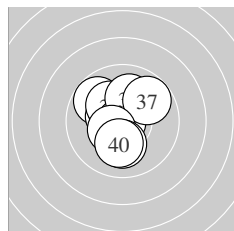

Serie 4:
 9.8 ↘ 10.4 * 10.5 * 10.2 * 10.9 *
 10.1 ↑ 9.8 ↗ 10.4 * 10.1 ↓ 10.1 ↓
 beste Teiler 10.0 (35.) 105.1 (33.) 128.4 (32.)
 Trefferlage 0.41 mm links, 0.33 mm hoch
 Streuwert 1.42, horizontal: 1.24, vertikal: 1.58

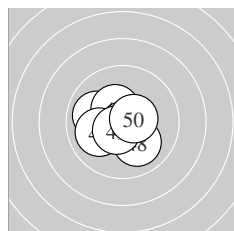

Serie 5:
 10.9 * 10.5 * 10.0 ↖ 10.4 * 10.0 ←
 10.5 * 10.8 * 10.0 ↘ 10.6 * 10.5 *
 beste Teiler 16.6 (41.) 33.5 (47.) 93.0 (49.)
 Trefferlage 0.38 mm links, 0.22 mm tief
 Streuwert 1.10, horizontal: 1.26, vertikal: 0.91

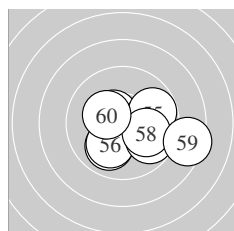

Serie 6:
 10.5 * 10.2 * 10.0 ↙ 10.3 * 9.8 →
 10.1 ↙ 9.8 ↘ 10.0 ↘ 8.4 → 10.3 *
 beste Teiler 118.1 (51.) 166.3 (60.) 167.2 (54.)
 Trefferlage 1.22 mm rechts, 0.62 mm tief
 Streuwert 1.90, horizontal: 2.40, vertikal: 1.21

Meyton Elektronik

ISSF AR Men Jun – Wertung – Junioren

StandNr: 116

Allenbach, Lars #311

StartNr: 107

18. Januar 2020 13:34

SUI

Unterschrift des Schützen

Meyton Elektronik

Ergebnis:	602.2	(579)
Serien:	99.4	99.2 100.8 100.9 102.6 99.3
Zähler:	40	19 1 0 0 0 0 0 0 0
Innenzehner:	28	
weiteste:	595 (33), 480 (55), 474 (12)	
beste Teiler	32.2 (1.)	59.1 (43.) 67.1 (54.)
Trefferlage	0.09 mm rechts,	0.13 mm tief
Streuwert	1.86,	horizontal: 2.06, vertikal: 1.63

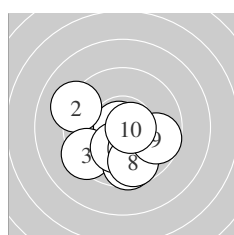
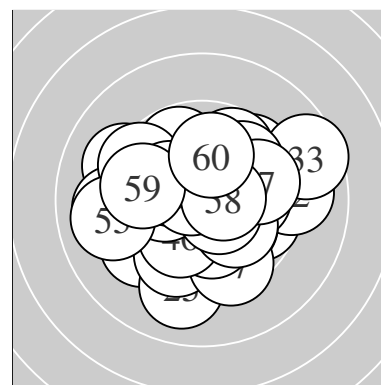

Serie 1:	10.8 *	9.2 ↖	9.4 ↙	9.6 ↓	10.0 ↘
	10.2 *	10.1 ↘	9.7 ↓	9.7 →	10.7 *
beste Teiler	32.2 (1.)	71.2 (10.)	187.8 (6.)		
Trefferlage	0.00 mm , 1.27 mm tief				
Streuwert	1.89, horizontal: 2.19, vertikal: 1.55				

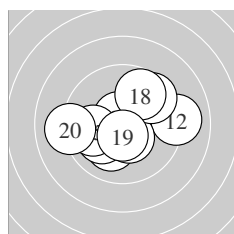

Serie 2:	10.1 ↙	9.1 →	10.7 *	10.1 ↖	9.9 ←
	10.4 *	9.6 ↗	9.7 ↗	10.5 *	9.1 ←
beste Teiler	70.7 (13.)	101.0 (19.)	131.5 (16.)		
Trefferlage	0.09 mm links, 0.04 mm tief				
Streuwert	2.17, horizontal: 2.67, vertikal: 1.52				

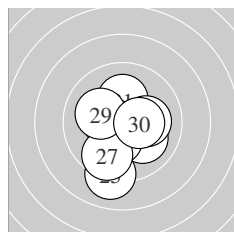

Serie 3:	10.2 *	10.3 *	10.1 ↘	10.3 *	9.1 ↓
	10.5 *	9.7 ↙	10.1 →	10.1 ↖	10.4 *
beste Teiler	124.0 (26.)	146.2 (30.)	154.5 (22.)		
Trefferlage	0.07 mm rechts, 0.77 mm tief				
Streuwert	1.70, horizontal: 1.50, vertikal: 1.88				

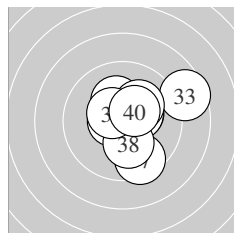

Serie 4:	10.2 *	10.6 *	8.6 ↗	10.3 *	10.4 *
	10.2 *	9.5 ↘	10.2 *	10.5 *	10.4 *
beste Teiler	86.0 (32.)	115.6 (39.)	137.6 (40.)		
Trefferlage	1.04 mm rechts, 0.30 mm hoch				
Streuwert	1.78, horizontal: 1.85, vertikal: 1.70				

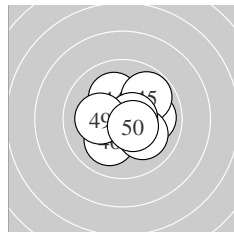

Serie 5:	10.0 →	10.5 *	10.7 *	10.1 ↖	9.8 ↗
	10.1 ↙	10.1 ↘	10.6 *	10.2 *	10.5 *
beste Teiler	59.1 (43.)	84.3 (48.)	105.6 (42.)		
Trefferlage	0.40 mm rechts, 0.02 mm tief				
Streuwert	1.37, horizontal: 1.48, vertikal: 1.25				

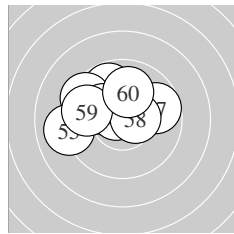

Serie 6:	9.8 ↖	9.5 ↖	10.2 *	10.7 *	9.0 ←
	10.2 *	9.7 →	10.5 *	9.7 ←	10.0 ↑
beste Teiler	67.1 (54.)	113.4 (58.)	189.2 (56.)		
Trefferlage	0.83 mm links, 0.97 mm hoch				
Streuwert	1.89, horizontal: 2.44, vertikal: 1.08				

Meyton Elektronik

ISSF AR Men Jun – Wertung – Junioren

StandNr: 117

Raffelsberger, Tobias #378

StartNr: 108

18. Januar 2020 13:22

OOE – SV Theuerwang

Unterschrift des Schützen

Meyton Elektronik

Ergebnis:	622.1	(593)
Serien:	102.7	103.3 105.2 104.3 104.4 102.2
Zähler:	53	7 0 0 0 0 0 0 0 0
Innenzehner:	44	
weiteste:	393	(9), 343 (60), 315 (54)
beste Teiler	32.2	(33.) 32.3 (25.) 34.1 (16.)
Trefferlage	0.01 mm links, 0.37 mm hoch	
Streuwert	1.19, horizontal: 1.21, vertikal: 1.16	

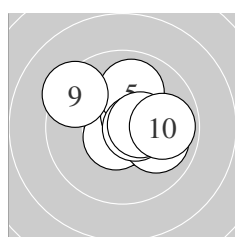
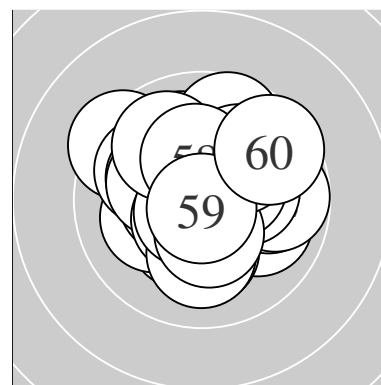

Serie 1:	10.5 *	10.7 *	10.6 *	10.5 *	10.0 ↑
	10.0 ↘	10.6 *	10.5 *	9.4 ↖	9.9 →
beste Teiler	52.4 (2.) 80.7 (3.) 87.2 (7.)				
Trefferlage	0.45 mm rechts, 0.46 mm hoch				
Streuwert	1.42, horizontal: 1.66, vertikal: 1.14				

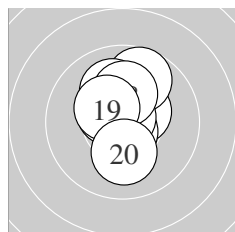

Serie 2:	10.4 *	9.7 ↑	10.7 *	10.5 *	10.4 *
	10.8 *	10.1 ↖	10.2 *	10.4 *	10.1 ↓
beste Teiler	34.1 (16.) 66.9 (13.) 109.4 (14.)				
Trefferlage	0.03 mm links, 0.83 mm hoch				
Streuwert	1.13, horizontal: 0.75, vertikal: 1.42				

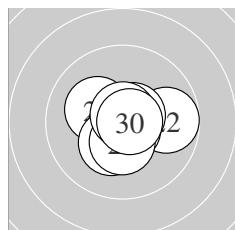

Serie 3:	10.8 *	9.8 →	10.7 *	10.2 *	10.8 *
	10.6 *	10.3 *	10.4 *	10.8 *	10.8 *
beste Teiler	32.3 (25.) 40.0 (21.) 48.0 (30.)				
Trefferlage	0.22 mm rechts, 0.16 mm tief				
Streuwert	1.00, horizontal: 1.20, vertikal: 0.75				

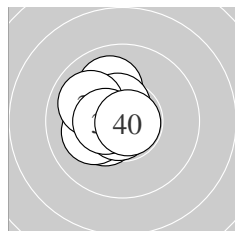

Serie 4:	10.4 *	10.5 *	10.8 *	10.0 ↖	10.5 *
	10.1 ←	10.0 ↖	10.7 *	10.5 *	10.8 *
beste Teiler	32.2 (33.) 37.0 (40.) 52.1 (38.)				
Trefferlage	0.89 mm links, 0.18 mm hoch				
Streuwert	0.88, horizontal: 0.78, vertikal: 0.97				

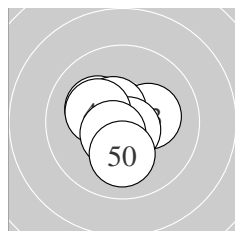

Serie 5:	10.6 *	10.8 *	10.2 *	10.2 *	10.6 *
	10.5 *	10.7 *	10.2 *	10.5 *	10.1 ↓
beste Teiler	49.2 (42.) 63.5 (47.) 77.4 (45.)				
Trefferlage	0.42 mm links, 0.02 mm tief				
Streuwert	0.99, horizontal: 1.01, vertikal: 0.96				

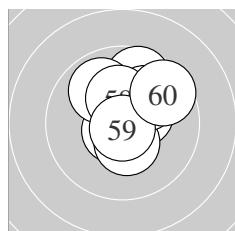

Serie 6:	10.3 *	10.4 *	10.7 *	9.7 ↑	9.9 ↖
	10.4 *	10.1 ↗	10.3 *	10.8 *	9.6 ↗
beste Teiler	35.0 (59.) 75.0 (53.) 137.1 (56.)				
Trefferlage	0.57 mm rechts, 0.98 mm hoch				
Streuwert	1.30, horizontal: 1.21, vertikal: 1.38				

Meyton Elektronik

ISSF AR Men Jun – Wertung – Junioren

StandNr: 118

Satyajeet, Khandil #379

StartNr: 109

18. Januar 2020 13:33

Indian Army

Unterschrift des Schützen

Meyton Elektronik

Ergebnis:	613.0	(588)
Serien:	100.6	101.2 104.2 103.3 100.8 102.9
Zähler:	48	12 0 0 0 0 0 0 0 0
Innenzehner:	40	
weiteste:	454 (2), 417 (41), 390 (50)	
beste Teiler	13.1 (15.)	39.8 (14.) 61.0 (34.)
Trefferlage	0.14 mm links, 0.52 mm hoch	
Streuwert	1.41, horizontal: 1.54, vertikal: 1.28	

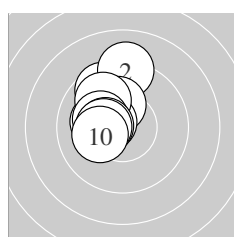
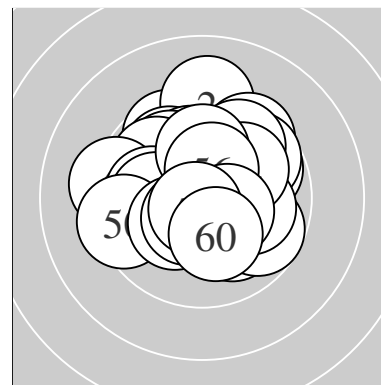

Serie 1:	9.6 ↘	9.1 ↑	10.2 *	10.5 *	10.2 *
	9.9 ↘	10.2 *	10.4 *	10.3 *	10.2 *
beste Teiler	118.3 (4.) 137.4 (8.) 151.0 (9.)				
Trefferlage	1.27 mm links, 1.24 mm hoch				
Streuwert	1.22, horizontal: 0.69, vertikal: 1.58				

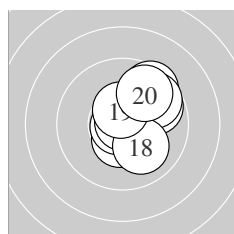

Serie 2:	9.5 ↗	9.8 ↗	10.5 *	10.8 *	10.9 *
	9.8 ↗	9.7 ↗	10.0 ↘	10.5 *	9.7 ↗
beste Teiler	13.1 (15.) 39.8 (14.) 113.0 (19.)				
Trefferlage	1.20 mm rechts, 0.84 mm hoch				
Streuwert	1.39, horizontal: 1.24, vertikal: 1.53				

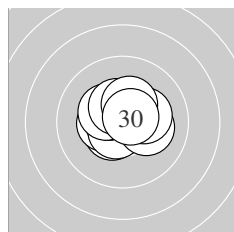

Serie 3:	10.5 *	10.4 *	10.6 *	10.6 *	10.3 *
	10.2 *	10.4 *	10.2 *	10.4 *	10.6 *
beste Teiler	76.5 (30.) 84.7 (23.) 86.2 (24.)				
Trefferlage	0.06 mm links, 0.25 mm hoch				
Streuwert	1.00, horizontal: 1.19, vertikal: 0.76				

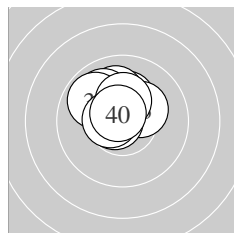

Serie 4:	10.2 *	10.5 *	10.3 *	10.7 *	10.1 ↑
	10.0 ↘	9.9 ↘	10.3 *	10.6 *	10.7 *
beste Teiler	61.0 (34.) 72.2 (40.) 98.7 (39.)				
Trefferlage	0.48 mm links, 1.17 mm hoch				
Streuwert	0.88, horizontal: 0.98, vertikal: 0.76				

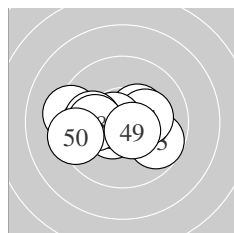

Serie 5:	9.3 ←	10.4 *	9.7 ↘	10.2 *	10.5 *
	10.7 *	10.0 ←	10.1 ←	10.5 *	9.4 ←
beste Teiler	71.1 (46.) 103.4 (49.) 106.4 (45.)				
Trefferlage	0.75 mm links, 0.18 mm tief				
Streuwert	1.74, horizontal: 2.34, vertikal: 0.77				

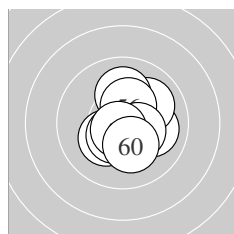

Serie 6:	10.4 *	10.2 *	10.0 →	10.0 ↗	10.1 ↑
	10.4 *	10.5 *	10.4 *	10.7 *	10.2 *
beste Teiler	61.9 (59.) 117.8 (57.) 130.2 (51.)				
Trefferlage	0.48 mm rechts, 0.16 mm tief				
Streuwert	1.22, horizontal: 1.11, vertikal: 1.33				

Meyton Elektronik

ISSF AR Men Jun – Wertung – Junioren

StandNr: 119

Weiler, Kevin #201

StartNr: 110

18. Januar 2020 13:15

T – SSG Innervillgraten

Unterschrift des Schützen

Meyton Elektronik

Ergebnis: **623.1** (592)^{QF}
 Serien: 102.3 104.3 103.5 104.2 105.0 103.8
 Zähler: 52 8 0 0 0 0 0 0 0
 Innenzehner: 46
 weiteste: 349 (12), 308 (24), 299 (56)
 beste Teiler 17.0 (16.) 31.7 (46.) 34.1 (49.)
 Trefferlage 0.02 mm rechts, 0.06 mm tief
 Streuwert 1.18, horizontal: 1.32, vertikal: 1.01

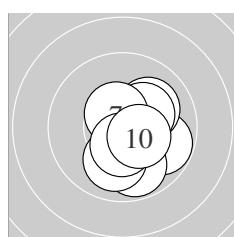
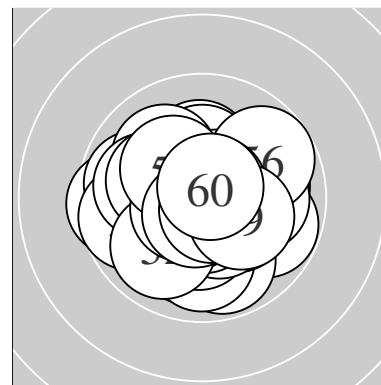

Serie 1:
 9.8 ↘ 10.6 * 10.3 * 9.8 ↘ 10.1 ↗
 10.3 * 10.5 * 10.0 ↓ 10.5 * 10.4 *
 beste Teiler 90.4 (2.) 104.2 (7.) 124.1 (9.)
 Trefferlage 0.88 mm rechts, 0.33 mm tief
 Streuwert 1.25, horizontal: 1.02, vertikal: 1.44

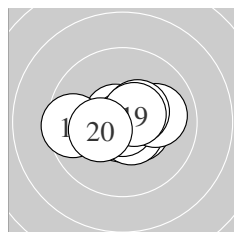

Serie 2:
 10.7 * 9.6 ← 10.7 * 10.5 * 10.6 *
 10.9 * 10.0 → 10.4 * 10.6 * 10.3 *
 beste Teiler 17.0 (16.) 57.0 (13.) 64.4 (11.)
 Trefferlage 0.01 mm rechts, 0.06 mm tief
 Streuwert 1.21, horizontal: 1.62, vertikal: 0.55

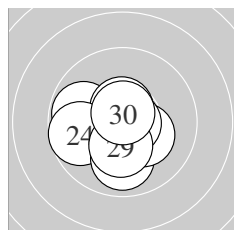

Serie 3:
 9.8 ← 10.6 * 10.8 * 9.7 ← 10.6 *
 9.9 ↓ 10.3 * 10.8 * 10.3 * 10.7 *
 beste Teiler 44.1 (23.) 48.6 (28.) 65.0 (30.)
 Trefferlage 0.34 mm links, 0.39 mm tief
 Streuwert 1.28, horizontal: 1.41, vertikal: 1.12

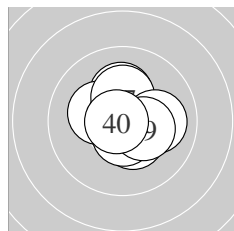

Serie 4:
 10.2 * 10.3 * 10.4 * 10.6 * 10.7 *
 10.6 * 10.3 * 10.0 → 10.3 * 10.8 *
 beste Teiler 43.2 (40.) 52.8 (35.) 93.2 (34.)
 Trefferlage 0.32 mm rechts, 0.22 mm hoch
 Streuwert 1.05, horizontal: 1.09, vertikal: 1.01

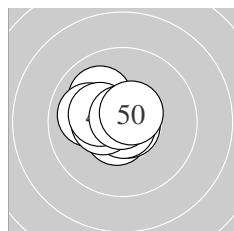

Serie 5:
 10.0 ↖ 10.7 * 10.0 ← 10.6 * 10.8 *
 10.8 * 10.4 * 10.3 * 10.8 * 10.6 *
 beste Teiler 31.7 (46.) 34.1 (49.) 48.6 (45.)
 Trefferlage 0.68 mm links, 0.21 mm hoch
 Streuwert 0.85, horizontal: 0.98, vertikal: 0.69

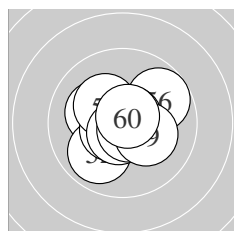

Serie 6:
 10.2 * 9.9 ↗ 10.6 * 10.3 * 10.7 *
 9.8 ↗ 10.7 * 10.7 * 10.2 * 10.7 *
 beste Teiler 58.6 (60.) 63.2 (57.) 65.9 (58.)
 Trefferlage 0.02 mm links, 0.00 mm
 Streuwert 1.26, horizontal: 1.40, vertikal: 1.09

Meyton Elektronik

ISSF AR Men Jun – Wertung – Junioren

StandNr: 120

Einwaller, Dominic #17

StartNr: 111

18. Januar 2020 13:33

AUT

QF – Schütze hat sich fürs Finale qualifiziert

Unterschrift des Schützen

Meyton Elektronik

Ergebnis: **601.5** (573)
 Serien: 101.2 101.2 98.8 99.1 101.6 99.6
 Zähler: 34 25 1 0 0 0 0 0 0
 Innenzehner: 23
 weiteste: 646 (36), 475 (40), 473 (27)
 beste Teiler 4.1 (9.) 26.8 (48.) 45.2 (32.)
 Trefferlage 0.27 mm rechts, 0.16 mm tief
 Streuwert 1.83, horizontal: 2.08, vertikal: 1.55

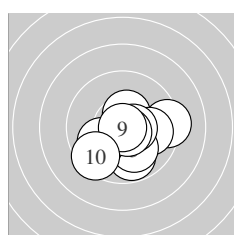
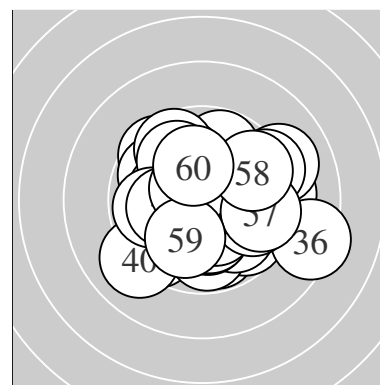

Serie 1:
 9.3 → 10.4 * 9.9 → 9.8 ↘ 10.1 ↘
 10.0 ↙ 10.6 * 10.7 * 10.9 * 9.5 ↙
 beste Teiler 4.1 (9.) 66.4 (8.) 99.5 (7.)
 Trefferlage 0.58 mm rechts, 0.81 mm tief
 Streuwert 1.65, horizontal: 1.93, vertikal: 1.31

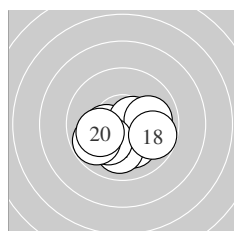

Serie 2:
 10.1 ↘ 10.4 * 10.3 * 10.0 ↓ 10.6 *
 10.0 → 10.1 ↙ 9.8 → 9.8 ↙ 10.1 ←
 beste Teiler 99.0 (15.) 147.1 (12.) 156.7 (13.)
 Trefferlage 0.07 mm rechts, 0.93 mm tief
 Streuwert 1.47, horizontal: 1.87, vertikal: 0.90

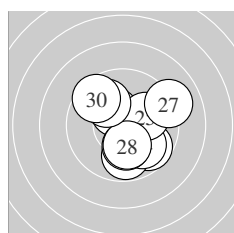

Serie 3:
 10.4 * 9.7 ↘ 9.8 ↓ 9.9 ↘ 10.0 →
 10.2 * 9.1 → 10.2 * 9.9 ↘ 9.6 ↘
 beste Teiler 139.4 (21.) 190.9 (28.) 197.7 (26.)
 Trefferlage 0.70 mm rechts, 0.19 mm tief
 Streuwert 2.04, horizontal: 2.00, vertikal: 2.07

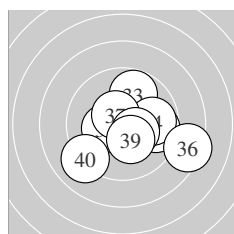

Serie 4:
 9.7 → 10.8 * 9.8 ↑ 9.8 → 10.3 *
 8.4 → 10.5 * 10.4 * 10.3 * 9.1 ↙
 beste Teiler 45.2 (32.) 107.8 (37.) 138.5 (38.)
 Trefferlage 0.90 mm rechts, 0.40 mm tief
 Streuwert 2.23, horizontal: 2.67, vertikal: 1.67

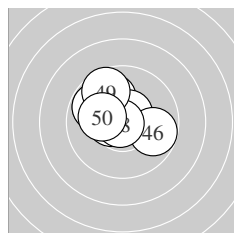

Serie 5:
 10.5 * 10.0 ↖ 10.4 * 10.6 * 9.8 ↖
 9.8 → 9.8 ↖ 10.8 * 9.7 ↖ 10.2 *
 beste Teiler 26.8 (48.) 93.6 (44.) 107.0 (41.)
 Trefferlage 0.86 mm links, 0.85 mm hoch
 Streuwert 1.39, horizontal: 1.60, vertikal: 1.14

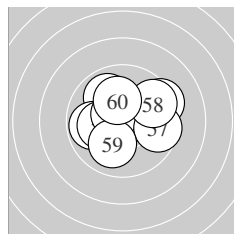

Serie 6:
 9.9 ↖ 9.8 ← 9.4 → 10.4 * 10.1 ←
 10.6 * 9.6 → 9.6 → 10.0 ↓ 10.2 *
 beste Teiler 97.0 (56.) 135.4 (54.) 198.1 (60.)
 Trefferlage 0.26 mm rechts, 0.48 mm hoch
 Streuwert 1.90, horizontal: 2.30, vertikal: 1.39

ISSF AR Men Jun – Wertung – Junioren

StandNr: 121

Kaiser, Elias #154

StartNr: 112

18. Januar 2020 13:27

LIE

Unterschrift des Schützen

Meyton Elektronik

Ergebnis: **617.1** (591)
 Serien: 103.6 101.2 102.6 104.2 102.8 102.7
 Zähler: 51 9 0 0 0 0 0 0 0
 Innenzehner: 43
 weiteste: 354 (49), 344 (18), 325 (30)
 beste Teiler 16.1 (17.) 48.2 (2.) 51.3 (33.)
 Trefferlage 0.07 mm links, 0.18 mm tief
 Streuwert 1.31, horizontal: 1.42, vertikal: 1.18

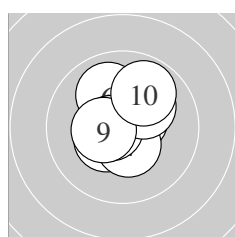
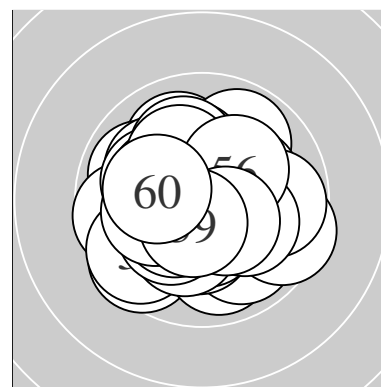

Serie 1:
 10.4 * 10.8 * 10.6 * 10.5 * 10.3 *
 10.0 ↘ 10.6 * 10.1 ↗ 10.4 * 9.9 ↗
 beste Teiler 48.2 (2.) 81.3 (7.) 100.8 (3.)
 Trefferlage 0.05 mm rechts, 0.59 mm hoch
 Streuwert 1.16, horizontal: 1.04, vertikal: 1.26

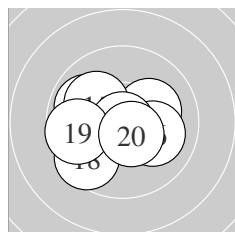

Serie 2:
 9.9 ↖ 10.1 ↖ 10.2 * 10.1 ↖ 10.1 ↖
 10.1 ↗ 10.9 * 9.6 ↖ 9.7 ↖ 10.5 *
 beste Teiler 16.1 (17.) 101.6 (20.) 196.3 (13.)
 Trefferlage 0.90 mm links, 0.36 mm tief
 Streuwert 1.54, horizontal: 1.87, vertikal: 1.12

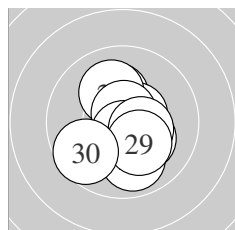

Serie 3:
 10.2 * 10.6 * 10.2 * 10.1 ↖ 10.7 *
 10.6 * 10.4 * 9.9 ↓ 10.2 * 9.7 ↖
 beste Teiler 62.5 (25.) 77.3 (26.) 98.9 (22.)
 Trefferlage 0.18 mm rechts, 0.33 mm tief
 Streuwert 1.39, horizontal: 1.21, vertikal: 1.54

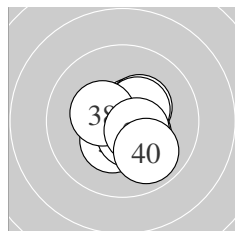

Serie 4:
 10.6 * 10.4 * 10.7 * 10.4 * 10.4 *
 10.5 * 10.4 * 10.4 * 10.5 * 9.9 ↘
 beste Teiler 51.3 (33.) 93.6 (31.) 103.7 (36.)
 Trefferlage 0.53 mm rechts, 0.29 mm tief
 Streuwert 0.97, horizontal: 0.92, vertikal: 1.03

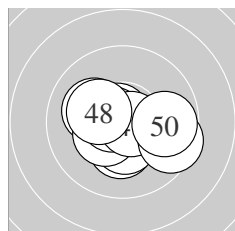

Serie 5:
 10.7 * 10.3 * 10.4 * 10.1 ↖ 10.4 *
 10.7 * 10.7 * 10.2 * 9.5 ↗ 9.8 →
 beste Teiler 56.7 (41.) 59.6 (47.) 73.2 (46.)
 Trefferlage 0.09 mm rechts, 0.32 mm tief
 Streuwert 1.40, horizontal: 1.77, vertikal: 0.89

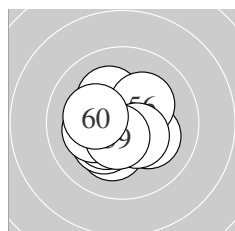

Serie 6:
 10.2 * 10.2 * 10.2 * 10.2 * 10.4 *
 10.2 * 10.2 * 10.4 * 10.5 * 10.2 *
 beste Teiler 101.0 (59.) 130.2 (58.) 146.8 (55.)
 Trefferlage 0.41 mm links, 0.37 mm tief
 Streuwert 1.23, horizontal: 1.32, vertikal: 1.12

Meyton Elektronik

ISSF AR Men Jun – Wertung – Junioren

StandNr: 122

Kupec, Ondrej #380

StartNr: 113

18. Januar 2020 13:11

CZE

Unterschrift des Schützen

Meyton Elektronik

Ergebnis:	616.0	(588)							
Serien:	103.2	102.3	104.2	101.7	101.3	103.3			
Zähler:	48	12	0	0	0	0	0	0	0
Innenzehner:	41								
weiteste:	372 (43), 357 (11), 344 (12)								
beste Teiler	15.2 (18.)	16.7 (57.)	23.6 (8.)						
Trefferlage	0.04 mm rechts, 0.02 mm hoch								
Streuwert	1.38, horizontal: 1.60, vertikal: 1.13								

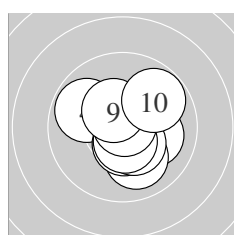
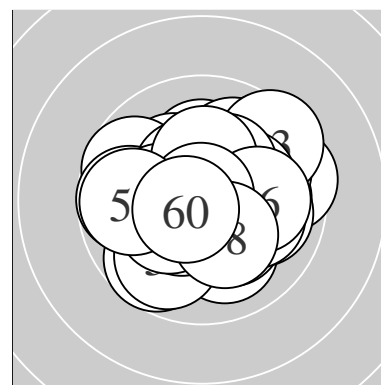

Serie 1:

10.1 →	10.7 *	10.0 ↘	9.8 ↖	10.5 *
10.4 *	10.6 *	10.9 *	10.4 *	9.8 ↗
beste Teiler	23.6 (8.)	52.7 (2.)	99.8 (7.)	
Trefferlage	0.33 mm rechts, 0.10 mm tief			
Streuwert	1.32, horizontal: 1.34, vertikal: 1.29			

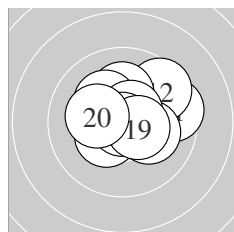

Serie 2:

9.5 →	9.6 ↗	10.2 *	10.2 *	10.2 *
10.4 *	10.6 *	10.9 *	10.5 *	10.2 *
beste Teiler	15.2 (18.)	90.1 (17.)	114.4 (19.)	
Trefferlage	0.53 mm rechts, 0.54 mm hoch			
Streuwert	1.45, horizontal: 1.72, vertikal: 1.10			

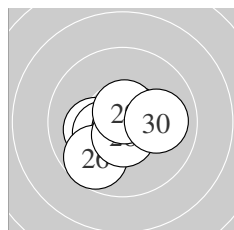

Serie 3:

10.7 *	10.6 *	10.2 *	10.4 *	10.7 *
9.7 ↙	10.6 *	10.6 *	10.7 *	10.0 →
beste Teiler	53.4 (25.)	63.3 (21.)	73.1 (29.)	
Trefferlage	0.08 mm links, 0.45 mm tief			
Streuwert	1.13, horizontal: 1.33, vertikal: 0.88			

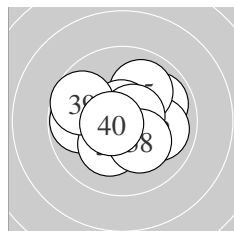

Serie 4:

9.9 ↗	10.0 →	9.8 ←	10.2 *	10.0 ↗
10.7 *	10.6 *	10.2 *	9.7 ↖	10.6 *
beste Teiler	65.6 (36.)	79.0 (40.)	80.5 (37.)	
Trefferlage	0.05 mm rechts, 0.17 mm hoch			
Streuwert	1.59, horizontal: 1.91, vertikal: 1.18			

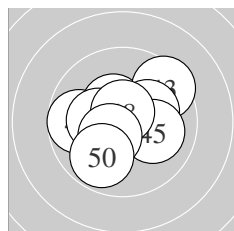

Serie 5:

10.2 *	10.4 *	9.5 ↗	10.2 *	10.1 →
9.7 ←	10.3 *	10.7 *	10.4 *	9.8 ↙
beste Teiler	71.0 (48.)	130.8 (42.)	130.9 (49.)	
Trefferlage	0.28 mm links, 0.10 mm hoch			
Streuwert	1.65, horizontal: 1.94, vertikal: 1.28			

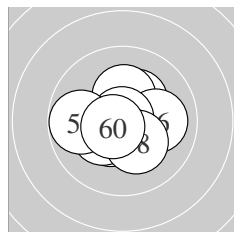

Serie 6:

10.3 *	10.4 *	10.4 *	10.3 *	10.3 *
10.0 →	10.9 *	10.3 *	9.8 ←	10.6 *
beste Teiler	16.7 (57.)	79.7 (60.)	126.8 (53.)	
Trefferlage	0.28 mm links, 0.10 mm tief			
Streuwert	1.26, horizontal: 1.48, vertikal: 1.00			

ISSF AR Men Jun – Wertung – Junioren

StandNr: 123

Kuen, Johannes #199

StartNr: 114

18. Januar 2020 13:39

T – SG Matri

Unterschrift des Schützen

Meyton Elektronik

Ergebnis: **537.8** (511)

Serien: 86.0 92.7 87.7 93.8 94.4 83.2

Zähler: 8 25 19 7 0 1 0 0 0 0

Innenzehner: 7

weiteste: 1311 (58), 893 (27), 893 (60)

beste Teiler 88.1 (46.) 150.6 (15.) 164.2 (56.)

Trefferlage 0.84 mm rechts, 0.11 mm hoch

Streuwert 3.92, horizontal: 4.45, vertikal: 3.30

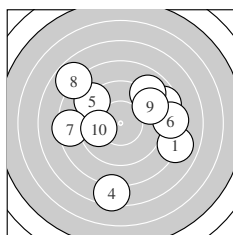
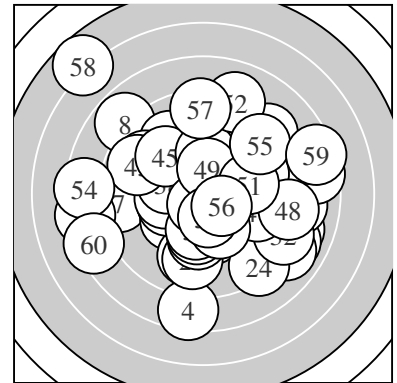

Serie 1:

8.0 ↘	8.6 ↘	8.9 ↗	7.5 ↓	9.2 ↖
8.5 →	8.4 ←	7.8 ↖	9.3 ↗	9.8 ←

beste Teiler 278.6 (10.) 424.6 (9.) 448.8 (5.)

Trefferlage 0.58 mm rechts, 0.40 mm hoch

Streuwert 4.53, horizontal: 5.04, vertikal: 3.95

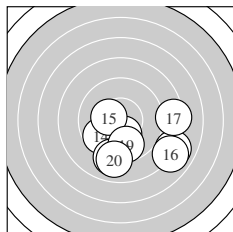

Serie 2:

10.3 *	10.2 *	8.0 ↘	9.7 ↗	10.4 *
8.0 ↘	8.3 →	9.1 ↓	9.7 ↓	9.0 ↓

beste Teiler 150.6 (15.) 175.0 (11.) 178.1 (12.)

Trefferlage 1.44 mm rechts, 2.49 mm tief

Streuwert 2.84, horizontal: 3.55, vertikal: 1.88

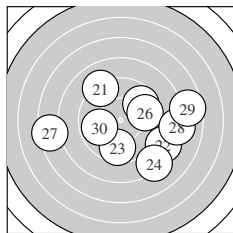

Serie 3:

9.1 ↖	8.5 ↘	9.6 ↓	8.2 ↘	9.7 ↗
9.7 →	7.4 ←	8.1 →	7.6 →	9.8 ←

beste Teiler 276.3 (30.) 316.6 (26.) 322.1 (25.)

Trefferlage 1.60 mm rechts, 0.66 mm tief

Streuwert 4.19, horizontal: 5.21, vertikal: 2.82

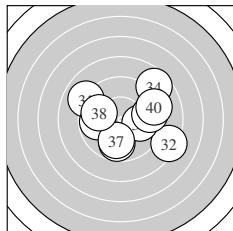

Serie 4:

9.0 ↖	8.3 ↘	9.7 ↓	8.6 ↗	9.8 ←
10.0 →	9.9 ↓	9.8 ←	9.5 →	9.2 →

beste Teiler 245.1 (36.) 270.4 (37.) 278.1 (38.)

Trefferlage 0.94 mm rechts, 0.01 mm tief

Streuwert 3.04, horizontal: 3.57, vertikal: 2.39

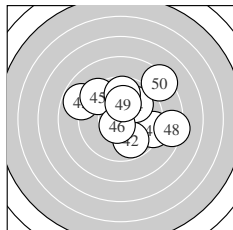

Serie 5:

9.3 →	9.8 ↘	8.8 ↖	9.9 ↗	9.4 ↖
10.6 *	9.7 ↑	8.4 →	10.2 *	8.3 ↗

beste Teiler 88.1 (46.) 193.4 (49.) 255.9 (44.)

Trefferlage 1.07 mm rechts, 1.04 mm hoch

Streuwert 2.92, horizontal: 3.42, vertikal: 2.32

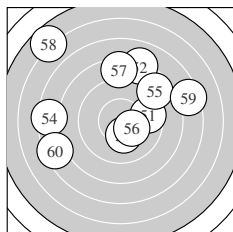

Serie 6:

9.6 →	8.1 ↑	10.2 *	7.4 ←	8.7 ↗
10.3 *	8.4 ↑	5.7 ↖	7.4 →	7.4 ←

beste Teiler 164.2 (56.) 178.1 (53.) 347.9 (51.)

Trefferlage 0.59 mm links, 2.42 mm hoch

Streuwert 5.22, horizontal: 6.05, vertikal: 4.22

Meyton Elektronik

ISSF AR Men Jun – Wertung – Junioren

StandNr: 124

Berthold, Maximilian #73

StartNr: 115

18. Januar 2020 13:13

VSB-NWLZ

Unterschrift des Schützen

Meyton Elektronik

Ergebnis:	623.8	(590) ^{QF}						
Serien:	104.1	103.8	103.7	103.0	105.6	103.6		
Zähler:	50	10	0	0	0	0	0	0
Innenzehner:	48							
weiteste:	295 (5), 285 (28), 277 (18)							
beste Teiler	8.5 (46.)	10.0 (19.)	10.8 (43.)					
Trefferlage	0.03 mm links, 0.00 mm							
Streuwert	1.14, horizontal: 1.19, vertikal: 1.09							

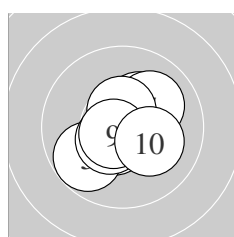
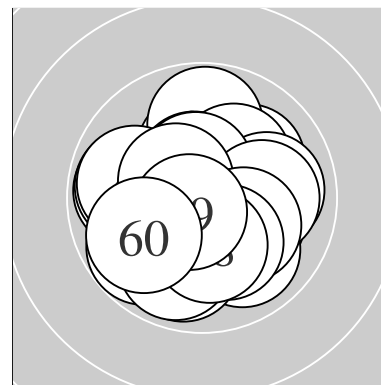

Serie 1:	10.7 *	10.3 *	10.8 *	10.5 *	9.8 ↙
	10.5 *	10.1 ↗	10.5 *	10.7 *	10.2 *
beste Teiler	48.1 (3.)	56.6 (1.)	73.0 (9.)		
Trefferlage	0.09 mm rechts, 0.10 mm tief				
Streuwert	1.18, horizontal: 1.24, vertikal: 1.11				

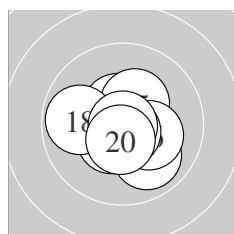

Serie 2:	10.5 *	10.5 *	9.9 ↘	10.5 *	10.3 *
	10.2 *	10.7 *	9.8 ←	10.9 *	10.5 *
beste Teiler	10.0 (19.)	55.9 (17.)	101.9 (20.)		
Trefferlage	0.10 mm rechts, 0.33 mm tief				
Streuwert	1.15, horizontal: 1.28, vertikal: 1.00				

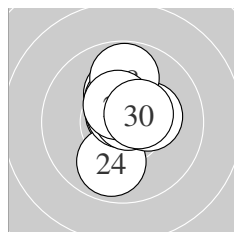

Serie 3:	10.2 *	10.4 *	10.7 *	9.9 ↓	10.7 *
	10.7 *	10.3 *	9.8 ↑	10.5 *	10.5 *
beste Teiler	53.4 (23.)	55.3 (26.)	58.8 (25.)		
Trefferlage	0.13 mm rechts, 0.71 mm hoch				
Streuwert	1.11, horizontal: 0.71, vertikal: 1.40				

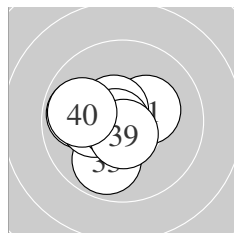

Serie 4:	10.3 *	10.5 *	9.9 ↓	9.9 ←	10.3 *
	10.2 *	10.6 *	10.8 *	10.6 *	9.9 ←
beste Teiler	49.3 (38.)	84.2 (39.)	92.6 (37.)		
Trefferlage	1.02 mm links, 0.17 mm tief				
Streuwert	1.14, horizontal: 1.27, vertikal: 0.99				

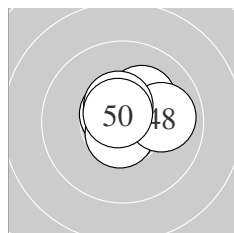

Serie 5:	10.7 *	10.4 *	10.9 *	10.2 *	10.7 *
	10.9 *	10.7 *	9.9 →	10.5 *	10.7 *
beste Teiler	8.5 (46.)	10.8 (43.)	53.0 (45.)		
Trefferlage	0.35 mm rechts, 0.30 mm hoch				
Streuwert	0.84, horizontal: 0.97, vertikal: 0.67				

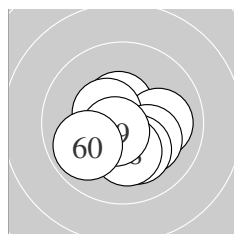

Serie 6:	10.7 *	10.7 *	10.5 *	10.0 →	10.5 *
	10.2 *	10.2 *	10.2 *	10.7 *	9.9 ↙
beste Teiler	51.0 (52.)	57.0 (51.)	74.3 (59.)		
Trefferlage	0.12 mm rechts, 0.39 mm tief				
Streuwert	1.19, horizontal: 1.31, vertikal: 1.07				

Meyton Elektronik

ISSF AR Men Jun – Wertung – Junioren

StandNr: 125

Lucas, Kryzs Lucas #381

StartNr: 116

18. Januar 2020 13:31

FRA

QF – Schütze hat sich fürs Finale qualifiziert

Unterschrift des Schützen

Meyton Elektronik

Ergebnis: **601.2** (575)
 Serien: 100.1 99.2 101.0 100.4 98.9 101.6
 Zähler: 36 23 1 0 0 0 0 0 0 0
 Innenzehner: 24
 weiteste: 512 (41), 491 (36), 407 (11)
 beste Teiler 29.2 (13.) 62.0 (39.) 62.7 (58.)
 Trefferlage 0.40 mm links, 0.21 mm hoch
 Streuwert 1.79, horizontal: 1.90, vertikal: 1.67

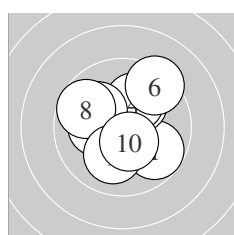
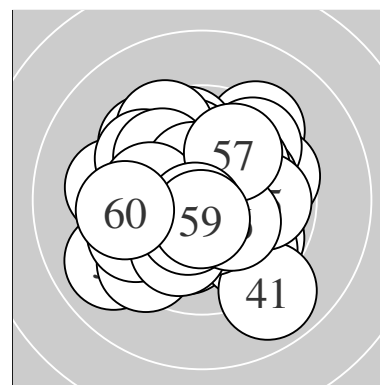

Serie 1:
 9.8 ↘ 10.2 * 10.1 ↗ 10.1 ↗ 10.2 *
 9.3 ↗ 10.1 ↖ 9.7 ↖ 10.1 ↓ 10.5 *
 beste Teiler 120.4 (10.) 193.0 (5.) 197.6 (2.)
 Trefferlage 0.05 mm links, 0.27 mm hoch
 Streuwert 1.85, horizontal: 1.83, vertikal: 1.88

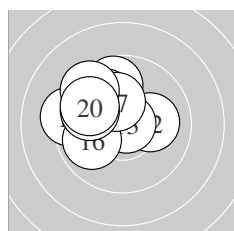

Serie 2:
 9.3 ← 10.1 → 10.8 * 9.7 ↑ 10.0 ↖
 9.9 ↙ 10.2 * 9.9 ↖ 9.5 ↖ 9.8 ↖
 beste Teiler 29.2 (13.) 177.4 (17.) 210.4 (12.)
 Trefferlage 1.40 mm links, 1.11 mm hoch
 Streuwert 1.53, horizontal: 1.76, vertikal: 1.26

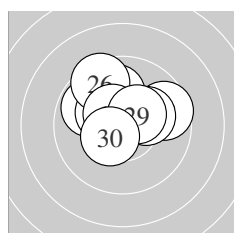

Serie 3:
 9.8 ↖ 9.6 → 10.3 * 10.0 ↑ 10.3 *
 9.5 ↖ 10.2 * 10.5 * 10.4 * 10.4 *
 beste Teiler 116.1 (28.) 128.8 (30.) 136.4 (29.)
 Trefferlage 0.26 mm links, 1.19 mm hoch
 Streuwert 1.44, horizontal: 1.73, vertikal: 1.08

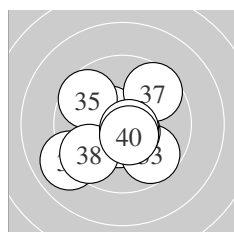

Serie 4:
 10.5 * 10.5 * 9.7 ↘ 10.6 * 9.6 ↖
 9.0 ↙ 9.6 ↗ 9.6 ↙ 10.7 * 10.6 *
 beste Teiler 62.0 (39.) 84.8 (34.) 98.9 (40.)
 Trefferlage 0.45 mm links, 0.52 mm tief
 Streuwert 1.94, horizontal: 2.10, vertikal: 1.76

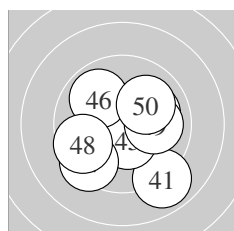

Serie 5:
 8.9 ↘ 10.3 * 10.0 → 10.4 * 10.4 *
 9.9 ↖ 9.4 ↙ 9.6 ↙ 10.0 → 10.0 ↗
 beste Teiler 127.1 (45.) 143.0 (44.) 153.7 (42.)
 Trefferlage 0.03 mm rechts, 0.55 mm tief
 Streuwert 2.09, horizontal: 2.20, vertikal: 1.98

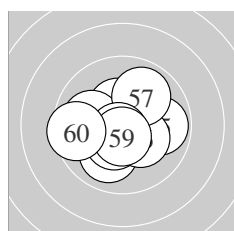

Serie 6:
 10.0 ↓ 10.4 * 10.4 * 10.0 ← 9.8 →
 10.3 * 9.9 ↗ 10.7 * 10.6 * 9.5 ←
 beste Teiler 62.7 (58.) 88.2 (59.) 134.2 (53.)
 Trefferlage 0.28 mm links, 0.24 mm tief
 Streuwert 1.58, horizontal: 1.84, vertikal: 1.26

ISSF AR Men Jun – Wertung – Junioren

StandNr: 126

Giannoni, Jacopo #382

StartNr: 117

18. Januar 2020 13:19

ITA

Unterschrift des Schützen

Meyton Elektronik

Ergebnis:	594.9	(568)
Serien:	100.9 98.0 102.2 101.0 97.4 95.4	
Zähler:	32 24 4 0 0 0 0 0 0	
Innenzehner:	21	
weiteste:	722 (15), 669 (53), 564 (56)	
beste Teiler	4.0 (12.) 8.6 (19.) 27.0 (24.)	
Trefferlage	0.70 mm rechts, 0.10 mm hoch	
Streuwert	2.08, horizontal: 2.40, vertikal: 1.70	

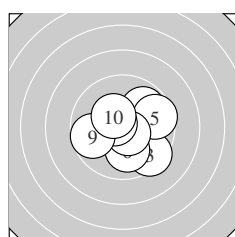
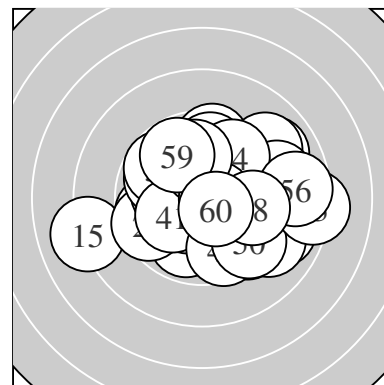

Serie 1:

9.9 ↗	10.1 ↓	9.4 ↘	10.6 *	9.6 →
10.0 ↓	10.6 *	10.6 *	9.7 ←	10.4 *
beste Teiler	83.4 (7.)	86.3 (8.)	87.5 (4.)	
Trefferlage	0.48 mm rechts, 0.50 mm tief			
Streuwert	1.71, horizontal: 1.86, vertikal: 1.56			

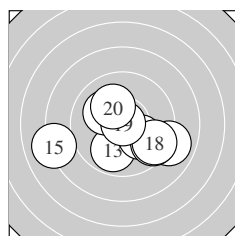

Serie 2:

8.9 ↘	10.9 *	9.9 ↓	10.1 ↘	8.1 ←
9.5 ↘	10.1 ↘	9.5 ↘	10.9 *	10.1 ↘
beste Teiler	4.0 (12.)	8.6 (19.)	201.8 (20.)	
Trefferlage	0.21 mm rechts, 0.86 mm tief			
Streuwert	2.55, horizontal: 3.27, vertikal: 1.52			

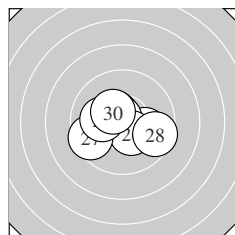

Serie 3:

10.2 *	10.5 *	10.0 ↘	10.8 *	10.7 *
10.4 *	9.5 ←	9.6 ↘	10.1 ←	10.4 *
beste Teiler	27.0 (24.)	52.8 (25.)	114.3 (22.)	
Trefferlage	0.27 mm links, 0.22 mm tief			
Streuwert	1.53, horizontal: 1.97, vertikal: 0.90			

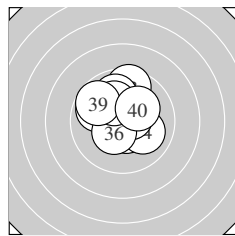

Serie 4:

9.9 ↖	10.5 *	9.6 ↑	10.0 ↘	10.6 *
10.4 *	9.9 ↑	10.2 *	9.7 ↖	10.2 *
beste Teiler	87.2 (35.)	106.9 (32.)	139.0 (36.)	
Trefferlage	0.20 mm links, 0.91 mm hoch			
Streuwert	1.56, horizontal: 1.54, vertikal: 1.58			

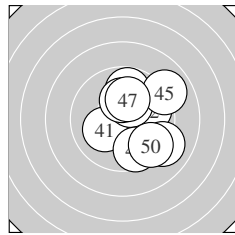

Serie 5:

10.1 ←	9.8 →	10.3 *	9.8 ↑	9.0 ↗
10.2 *	10.1 ↑	9.6 ↓	9.1 ↘	9.4 ↘
beste Teiler	161.6 (43.)	189.2 (46.)	205.1 (47.)	
Trefferlage	1.49 mm rechts, 0.26 mm hoch			
Streuwert	2.13, horizontal: 1.91, vertikal: 2.33			

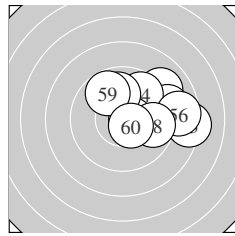

Serie 6:

9.0 ↗	9.1 →	8.3 →	9.7 ↗	10.6 *
8.7 →	10.0 ↑	9.7 →	9.8 ↗	10.5 *
beste Teiler	85.0 (55.)	106.6 (60.)	250.8 (57.)	
Trefferlage	2.52 mm rechts, 1.03 mm hoch			
Streuwert	2.15, horizontal: 2.66, vertikal: 1.48			

Meyton Elektronik

ISSF AR Men Jun – Wertung – Junioren

StandNr: 127

Wirtenberger, Matteo #202

StartNr: 118

18. Januar 2020 13:19

T – SG Absam

Unterschrift des Schützen

Meyton Elektronik

Ergebnis:	618.2	(588)
Serien:	104.1	101.9 105.2 100.8 104.2 102.0
Zähler:	48	12 0 0 0 0 0 0 0 0
Innenzehner:	41	
weiteste:	400 (13), 399 (9), 328 (18)	
beste Teiler	12.0 (50.)	13.8 (30.) 14.3 (22.)
Trefferlage	0.36 mm rechts, 0.30 mm hoch	
Streuwert	1.30, horizontal: 1.45, vertikal: 1.13	

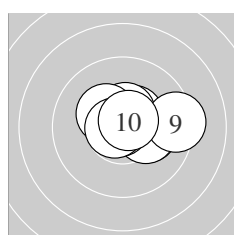
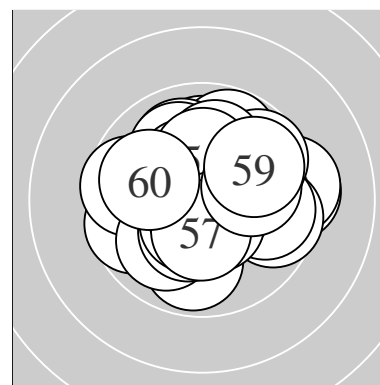

Serie 1:	10.7 *	10.5 *	10.2 *	10.5 *	10.2 *
	10.3 *	10.9 *	10.7 *	9.4 →	10.7 *
beste Teiler	23.5 (7.) 58.3 (8.) 65.9 (10.)				
Trefferlage	0.71 mm rechts, 0.36 mm hoch				
Streuwert	1.13, horizontal: 1.49, vertikal: 0.56				

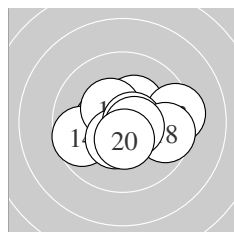

Serie 2:	10.4 *	10.3 *	9.4 →	9.7 ↖	10.4 *
	10.4 *	10.7 *	9.6 →	10.6 *	10.4 *
beste Teiler	73.0 (17.) 93.0 (19.) 127.6 (20.)				
Trefferlage	0.38 mm rechts, 0.17 mm tief				
Streuwert	1.60, horizontal: 2.07, vertikal: 0.93				

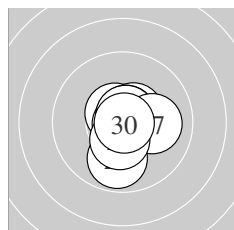

Serie 3:	10.6 *	10.9 *	10.5 *	10.5 *	10.7 *
	10.7 *	10.1 →	9.9 ↓	10.4 *	10.9 *
beste Teiler	13.8 (30.) 14.3 (22.) 55.4 (26.)				
Trefferlage	0.34 mm rechts, 0.18 mm tief				
Streuwert	0.95, horizontal: 0.82, vertikal: 1.06				

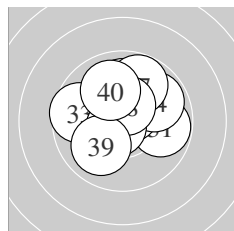

Serie 4:	9.8 →	10.6 *	9.6 ↖	9.8 ↗	10.0 ↑
	10.7 *	9.8 ↑	10.5 *	10.0 ↙	10.0 ↘
beste Teiler	61.7 (36.) 84.2 (32.) 119.0 (38.)				
Trefferlage	0.08 mm rechts, 0.86 mm hoch				
Streuwert	1.63, horizontal: 1.80, vertikal: 1.45				

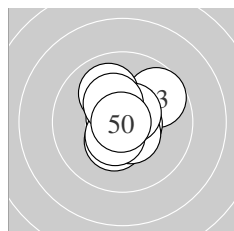

Serie 5:	10.7 *	10.3 *	9.7 ↗	10.7 *	10.5 *
	10.0 ↘	10.5 *	10.6 *	10.3 *	10.9 *
beste Teiler	12.0 (50.) 56.9 (41.) 73.5 (44.)				
Trefferlage	0.09 mm rechts, 0.28 mm hoch				
Streuwert	1.14, horizontal: 1.06, vertikal: 1.22				

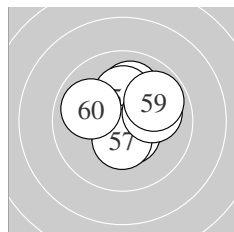

Serie 6:	10.2 *	10.2 *	10.0 ↑	10.8 *	10.2 *
	10.5 *	10.4 *	10.0 →	9.8 ↗	9.9 ↖
beste Teiler	48.4 (54.) 113.3 (56.) 137.0 (57.)				
Trefferlage	0.55 mm rechts, 0.64 mm hoch				
Streuwert	1.31, horizontal: 1.38, vertikal: 1.23				

Meyton Elektronik

ISSF AR Men Jun – Wertung – Junioren

StandNr: 128

Bilek, Ondrej #72

StartNr: 119

18. Januar 2020 13:27

CZE

Unterschrift des Schützen

Meyton Elektronik

Ergebnis:	591.4	(564)
Serien:	97.1 98.6 97.8 101.2 97.6 99.1	
Zähler:	29 26 5 0 0 0 0 0 0 0	
Innenzehner:	24	
weiteste:	672 (1), 625 (27), 607 (11)	
beste Teiler	2.2 (59.) 20.0 (32.) 28.4 (35.)	
Trefferlage	0.71 mm rechts, 0.20 mm hoch	
Streuwert	2.24, horizontal: 2.42, vertikal: 2.04	

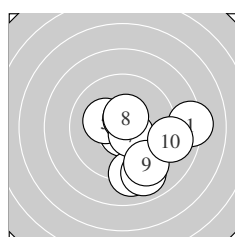
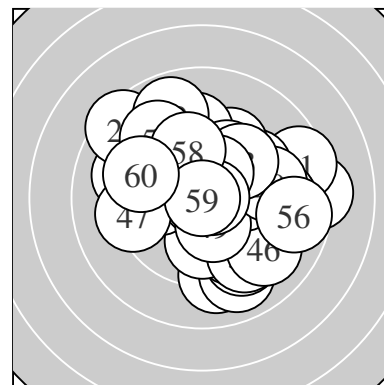

Serie 1:

8.3 →	10.7 *	9.1 ↓	9.0 ↓	10.2 *
10.6 *	10.5 *	10.5 *	9.2 ↓	9.0 →
beste Teiler	64.0 (2.) 90.7 (6.) 105.9 (8.)			
Trefferlage	1.64 mm rechts, 1.24 mm tief			
Streuwert	2.34, horizontal: 2.47, vertikal: 2.20			

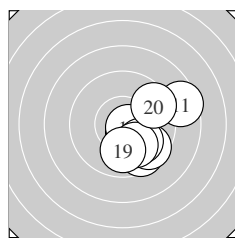

Serie 2:

8.5 →	10.2 *	10.6 *	10.7 *	9.6 ↓
9.6 ↓	10.0 ↘	10.0 ↓	9.9 ↓	9.5 →
beste Teiler	64.0 (14.) 95.2 (13.) 185.6 (12.)			
Trefferlage	1.82 mm rechts, 1.03 mm tief			
Streuwert	1.71, horizontal: 1.67, vertikal: 1.74			

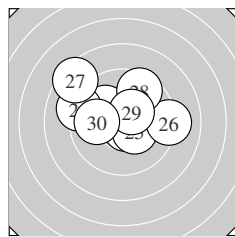

Serie 3:

10.1 ↗	10.1 ↖	10.7 *	9.1 ↖	10.4 *
9.1 →	8.5 ↖	9.5 ↗	10.4 *	9.9 ←
beste Teiler	71.5 (23.) 133.8 (29.) 149.8 (25.)			
Trefferlage	0.35 mm links, 1.13 mm hoch			
Streuwert	2.35, horizontal: 2.90, vertikal: 1.62			

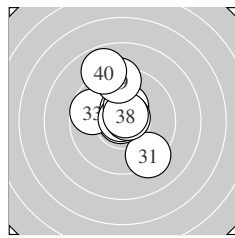

Serie 4:

9.3 ↓	10.9 *	9.7 ↖	10.5 *	10.8 *
10.4 *	10.7 *	10.7 *	9.3 ↑	8.9 ↖
beste Teiler	20.0 (32.) 28.4 (35.) 59.6 (37.)			
Trefferlage	0.20 mm links, 1.02 mm hoch			
Streuwert	1.90, horizontal: 1.45, vertikal: 2.26			

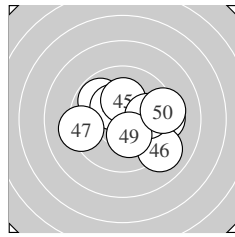

Serie 5:

9.8 ↖	10.3 *	9.9 →	9.4 →	10.2 *
9.1 ↓	9.3 ←	10.0 →	10.3 *	9.3 →
beste Teiler	154.0 (42.) 169.0 (49.) 184.1 (45.)			
Trefferlage	1.01 mm rechts, 0.00 mm			
Streuwert	2.25, horizontal: 2.80, vertikal: 1.53			

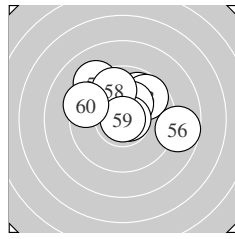

Serie 6:

10.6 *	9.8 ↗	9.7 ↗	10.3 *	9.2 ↖
8.7 →	10.7 *	9.8 ↘	10.9 *	9.4 ↖
beste Teiler	2.2 (59.) 56.1 (57.) 91.7 (51.)			
Trefferlage	0.38 mm rechts, 1.36 mm hoch			
Streuwert	2.05, horizontal: 2.53, vertikal: 1.41			

Meyton Elektronik

ISSF AR Men Jun – Wertung – Junioren

StandNr: 129

Gopp, Manuel #74

StartNr: 120

18. Januar 2020 13:19

VSB-NWLZ

Unterschrift des Schützen

Meyton Elektronik

Ergebnis: **611.3** (584)
 Serien: 102.4 100.5 101.0 101.9 102.3 103.2
 Zähler: 44 16 0 0 0 0 0 0 0
 Innenzehner: 36
 weiteste: 384 (27), 374 (59), 366 (11)
 beste Teiler 31.0 (2.) 41.2 (5.) 48.0 (25.)
 Trefferlage 0.08 mm links, 0.10 mm hoch
 Streuwert 1.52, horizontal: 1.51, vertikal: 1.52

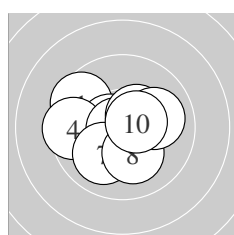
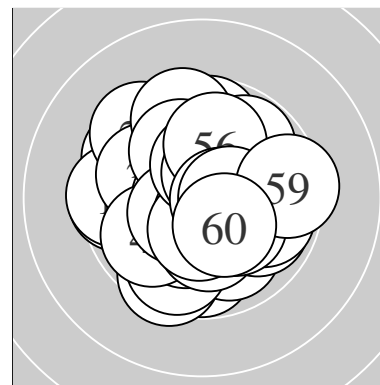

Serie 1:
 9.6 ↖ 10.8 * 10.6 * 9.5 ← 10.8 *
 10.4 * 10.0 ↙ 10.2 * 10.0 → 10.5 *
 beste Teiler 31.0 (2.) 41.2 (5.) 92.2 (3.)
 Trefferlage 0.39 mm links, 0.00 mm
 Streuwert 1.53, horizontal: 1.85, vertikal: 1.12

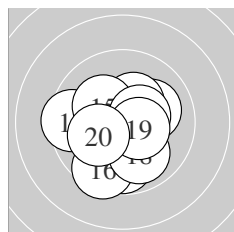

Serie 2:
 9.5 ← 10.1 → 9.8 ↓ 10.3 * 10.2 *
 9.5 ↙ 10.4 * 10.0 ↘ 10.5 * 10.2 *
 beste Teiler 125.7 (19.) 130.6 (17.) 156.7 (14.)
 Trefferlage 0.18 mm links, 0.59 mm tief
 Streuwert 1.75, horizontal: 1.80, vertikal: 1.71

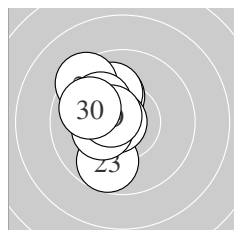

Serie 3:
 10.2 * 9.9 ↖ 9.7 ↙ 10.1 ↗ 10.8 *
 10.3 * 9.4 ↖ 10.1 ↖ 10.6 * 9.9 ↖
 beste Teiler 48.0 (25.) 95.7 (29.) 154.0 (26.)
 Trefferlage 1.38 mm links, 0.80 mm hoch
 Streuwert 1.26, horizontal: 0.74, vertikal: 1.62

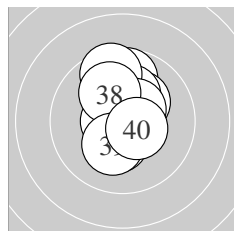

Serie 4:
 10.6 * 9.7 ↑ 10.2 * 10.2 * 9.6 ↗
 10.3 * 10.5 * 10.1 ↖ 10.2 * 10.5 *
 beste Teiler 81.0 (31.) 115.4 (40.) 123.1 (37.)
 Trefferlage 0.02 mm rechts, 0.88 mm hoch
 Streuwert 1.40, horizontal: 0.85, vertikal: 1.78

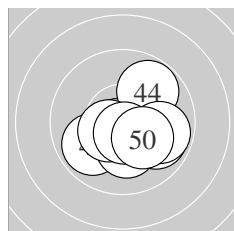

Serie 5:
 9.9 ↘ 10.7 * 10.7 * 9.8 ↗ 9.9 ↖
 10.2 * 10.5 * 10.6 * 9.8 → 10.2 *
 beste Teiler 55.0 (42.) 69.4 (43.) 81.0 (48.)
 Trefferlage 0.50 mm rechts, 0.68 mm tief
 Streuwert 1.35, horizontal: 1.55, vertikal: 1.11

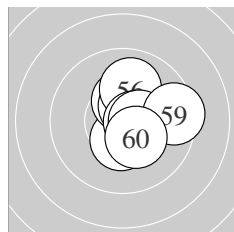

Serie 6:
 10.5 * 10.5 * 10.4 * 10.4 * 10.5 *
 10.0 ↑ 10.6 * 10.5 * 9.5 → 10.3 *
 beste Teiler 85.2 (57.) 118.0 (52.) 120.0 (55.)
 Trefferlage 0.91 mm rechts, 0.21 mm hoch
 Streuwert 1.15, horizontal: 1.08, vertikal: 1.22

Meyton Elektronik

ISSF AR Men Jun – Wertung – Junioren

StandNr: 130

Davis, Michael #321

StartNr: 121

18. Januar 2020 13:33

AUS

Unterschrift des Schützen

Meyton Elektronik

Ergebnis:	609.6	(581)
Serien:	101.2 103.0 102.3 102.8 101.5 98.8	
Zähler:	41 19 0 0 0 0 0 0 0	
Innenzehner:	33	
weiteste:	473 (51), 453 (58), 450 (27)	
beste Teiler	45.4 (17.) 47.7 (11.) 55.2 (24.)	
Trefferlage	0.29 mm rechts, 0.02 mm hoch	
Streuwert	1.59, horizontal: 1.53, vertikal: 1.65	

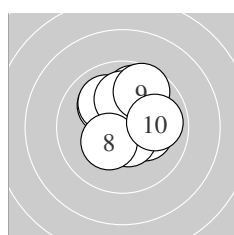
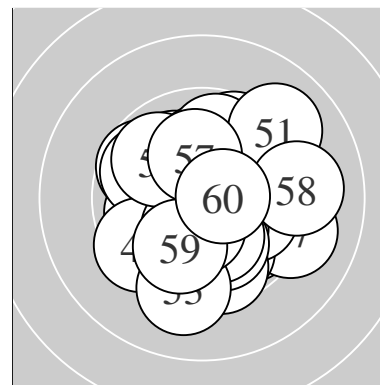

Serie 1:	10.1 ↘	10.0 ↘	10.5 *	9.8 ↑	10.2 *
	10.6 *	10.1 ↑	10.3 *	9.7 ↑	9.9 →
beste Teiler	100.6 (6.)	123.4 (3.)	156.3 (8.)		
Trefferlage	0.40 mm rechts, 1.02 mm hoch				
Streuwert	1.41, horizontal: 1.35, vertikal: 1.47				

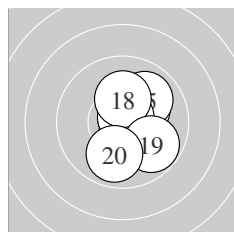

Serie 2:	10.8 *	10.6 *	10.2 *	10.1 ↗	10.0 ↗
	10.6 *	10.8 *	10.2 *	9.8 ↘	9.9 ↓
beste Teiler	45.4 (17.)	47.7 (11.)	89.1 (12.)		
Trefferlage	0.78 mm rechts, 0.25 mm hoch				
Streuwert	1.25, horizontal: 0.92, vertikal: 1.51				

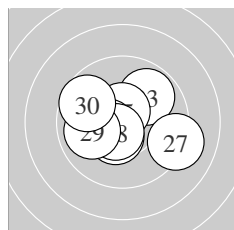

Serie 3:	10.5 *	10.7 *	9.9 ↗	10.7 *	10.6 *
	10.5 *	9.2 ↘	10.6 *	9.9 ←	9.7 ↖
beste Teiler	55.2 (24.)	75.0 (22.)	88.2 (25.)		
Trefferlage	0.26 mm links, 0.01 mm hoch				
Streuwert	1.65, horizontal: 2.03, vertikal: 1.16				

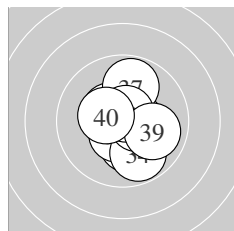

Serie 4:	10.5 *	10.2 *	10.5 *	9.8 ↓	10.5 *
	10.4 *	9.8 ↑	10.7 *	10.0 →	10.4 *
beste Teiler	63.1 (38.)	102.3 (31.)	110.5 (33.)		
Trefferlage	0.42 mm rechts, 0.22 mm tief				
Streuwert	1.31, horizontal: 1.11, vertikal: 1.48				

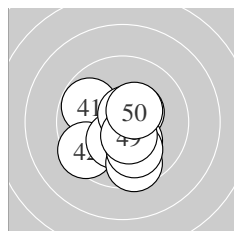

Serie 5:	9.8 ↖	9.5 ↙	10.3 *	10.4 *	9.6 ↓
	10.3 *	10.0 ↓	10.7 *	10.5 *	10.4 *
beste Teiler	66.7 (48.)	119.0 (49.)	130.1 (50.)		
Trefferlage	0.06 mm links, 0.81 mm tief				
Streuwert	1.55, horizontal: 1.51, vertikal: 1.59				

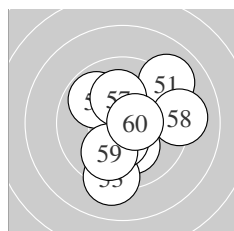

Serie 6:	9.1 ↗	10.2 *	9.2 ↓	10.4 *	10.4 *
	9.8 ↖	10.1 ↑	9.1 →	9.9 ↓	10.6 *
beste Teiler	99.3 (60.)	129.2 (55.)	139.9 (54.)		
Trefferlage	0.45 mm rechts, 0.11 mm tief				
Streuwert	2.19, horizontal: 2.07, vertikal: 2.31				

Meyton Elektronik

ISSF AR Men Jun – Wertung – Junioren

StandNr: 131

Waibel, Kiano #9

StartNr: 122

18. Januar 2020 13:35

AUT

Unterschrift des Schützen

Meyton Elektronik

Ergebnis:	610.1	(590)
Serien:	100.8	101.5 102.2 102.1 102.1 101.4
Zähler:	50	10 0 0 0 0 0 0 0 0
Innenzehner:	34	
weiteste:	496 (45), 462 (4), 454 (8)	
beste Teiler	11.6 (9.)	46.2 (41.) 70.1 (3.)
Trefferlage	0.27 mm rechts,	0.18 mm hoch
Streuwert	1.56, horizontal:	1.71, vertikal: 1.40

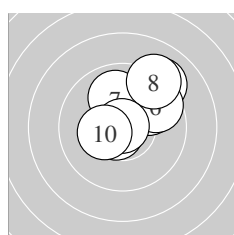
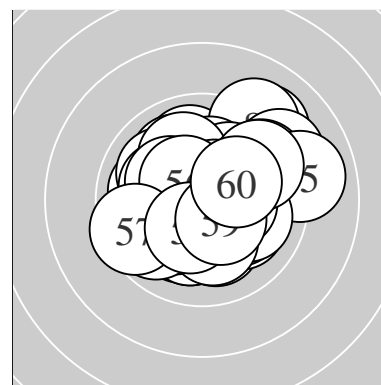

Serie 1:	10.5 *	10.7 *	10.7 *	9.1 ↗	9.9 ↗
	9.6 ↗	10.0 ↕	9.1 ↗	10.9 *	10.3 *
beste Teiler	11.6 (9.)	70.1 (3.)	74.3 (2.)		
Trefferlage	0.69 mm rechts, 1.34 mm hoch				
Streuwert	1.63, horizontal: 1.72, vertikal: 1.54				

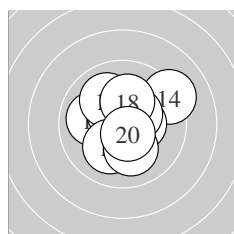

Serie 2:	10.0 ←	10.5 *	10.0 ↘	9.2 ↗	10.1 ↘
	10.4 *	10.4 *	10.2 *	10.1 ↓	10.6 *
beste Teiler	90.8 (20.)	122.2 (12.)	131.2 (17.)		
Trefferlage	0.22 mm rechts, 0.36 mm hoch				
Streuwert	1.63, horizontal: 1.73, vertikal: 1.53				

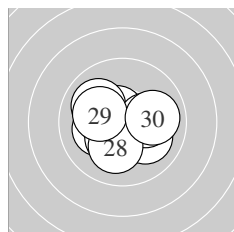

Serie 3:	10.2 *	10.5 *	10.6 *	10.1 ↘	10.3 *
	10.0 ↘	10.2 *	10.1 ↓	10.2 *	10.0 →
beste Teiler	87.4 (23.)	116.8 (22.)	155.8 (25.)		
Trefferlage	0.26 mm links, 0.19 mm tief				
Streuwert	1.42, horizontal: 1.70, vertikal: 1.05				

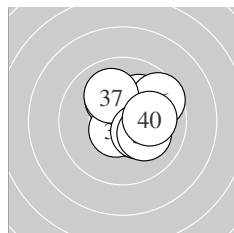

Serie 4:	10.6 *	10.2 *	10.5 *	10.6 *	10.1 ↗
	9.6 ↗	10.0 ↘	10.3 *	10.1 ↘	10.1 →
beste Teiler	90.0 (34.)	95.3 (31.)	112.0 (33.)		
Trefferlage	0.88 mm rechts, 0.44 mm hoch				
Streuwert	1.28, horizontal: 1.31, vertikal: 1.25				

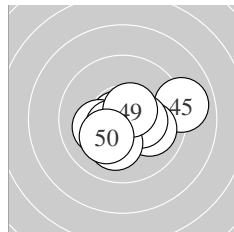

Serie 5:	10.8 *	10.2 *	10.3 *	10.5 *	9.0 →
	10.0 →	10.4 *	10.1 ↓	10.6 *	10.2 *
beste Teiler	46.2 (41.)	95.7 (49.)	105.4 (44.)		
Trefferlage	0.34 mm rechts, 0.52 mm tief				
Streuwert	1.59, horizontal: 2.01, vertikal: 1.00				

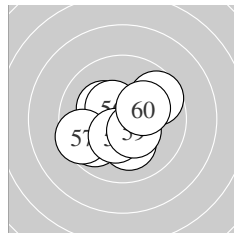

Serie 6:	10.1 ↓	9.8 ↙	9.7 ↗	10.6 *	10.2 *
	10.5 *	9.5 ↙	10.4 *	10.4 *	10.2 *
beste Teiler	77.2 (54.)	125.9 (56.)	133.6 (59.)		
Trefferlage	0.21 mm links, 0.36 mm tief				
Streuwert	1.62, horizontal: 1.86, vertikal: 1.33				

Meyton Elektronik

ISSF AR Men Jun – Wertung – Junioren

StandNr: 132

Gabriel, David #383

StartNr: 123

18. Januar 2020 13:47

SUI

Unterschrift des Schützen

Meyton Elektronik

Ergebnis: **611.1** (587)
 Serien: 101.8 101.2 103.7 102.6 100.6 101.2
 Zähler: 47 13 0 0 0 0 0 0 0
 Innenzehner: 38
 weiteste: 480 (42), 445 (16), 430 (3)
 beste Teiler 17.6 (34.) 48.0 (26.) 62.2 (23.)
 Trefferlage 0.20 mm rechts, 0.64 mm hoch
 Streuwert 1.45, horizontal: 1.53, vertikal: 1.37

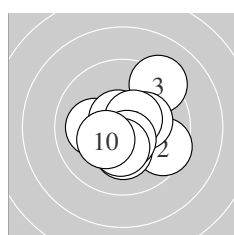
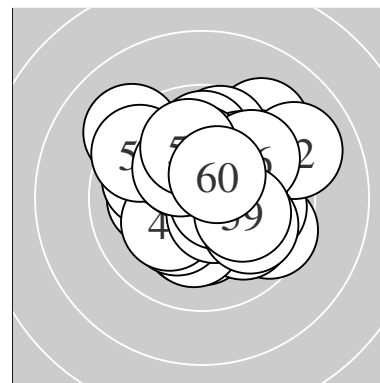

Serie 1:
 10.1 ← 9.6 ↘ 9.2 ↗ 10.3 * 10.7 *
 10.5 * 10.2 * 10.6 * 10.3 * 10.3 *
 beste Teiler 73.5 (5.) 100.9 (8.) 103.6 (6.)
 Trefferlage 0.47 mm rechts, 0.17 mm tief
 Streuwert 1.61, horizontal: 1.67, vertikal: 1.54

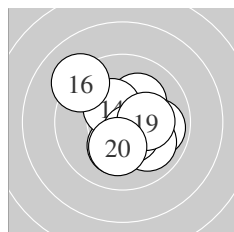

Serie 2:
 10.2 * 10.4 * 10.2 * 10.4 * 9.9 →
 9.2 ↘ 10.0 ↘ 10.5 * 10.2 * 10.2 *
 beste Teiler 109.8 (18.) 138.8 (14.) 144.5 (12.)
 Trefferlage 0.46 mm rechts, 0.06 mm tief
 Streuwert 1.67, horizontal: 1.74, vertikal: 1.60

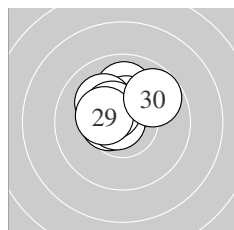

Serie 3:
 10.5 * 10.5 * 10.7 * 10.0 ↑ 10.4 *
 10.8 * 10.1 ↘ 10.5 * 10.4 * 9.8 ↗
 beste Teiler 48.0 (26.) 62.2 (23.) 104.0 (22.)
 Trefferlage 0.33 mm links, 1.00 mm hoch
 Streuwert 0.95, horizontal: 1.09, vertikal: 0.78

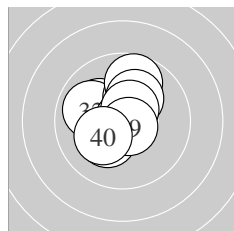

Serie 4:
 10.1 ↘ 9.9 ↘ 10.2 * 10.9 * 10.2 *
 9.7 ↑ 10.2 * 10.5 * 10.7 * 10.2 *
 beste Teiler 17.6 (34.) 63.0 (39.) 106.8 (38.)
 Trefferlage 0.32 mm links, 0.66 mm hoch
 Streuwert 1.31, horizontal: 1.26, vertikal: 1.37

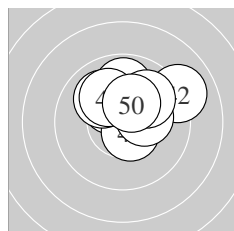

Serie 5:
 10.3 * 9.0 ↗ 9.9 ↑ 10.6 * 10.2 *
 10.0 ↘ 10.3 * 10.1 ↘ 9.9 ↗ 10.3 *
 beste Teiler 97.6 (44.) 157.8 (41.) 161.4 (50.)
 Trefferlage 0.70 mm rechts, 1.41 mm hoch
 Streuwert 1.40, horizontal: 1.72, vertikal: 0.98

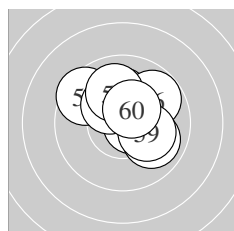

Serie 6:
 10.7 * 9.5 ↘ 10.1 ↑ 10.3 * 10.3 *
 9.8 ↗ 9.9 ↘ 10.0 ↑ 10.2 * 10.4 *
 beste Teiler 75.3 (51.) 128.7 (60.) 162.5 (54.)
 Trefferlage 0.27 mm rechts, 1.01 mm hoch
 Streuwert 1.46, horizontal: 1.63, vertikal: 1.27

Meyton Elektronik

ISSF AR Men Jun – Wertung – Junioren

StandNr: 133

Lee, Zheng Hang #313

StartNr: 124

18. Januar 2020 13:11

SGP

Unterschrift des Schützen

Meyton Elektronik

Ergebnis:	625.0	(598) ^{QF}							
Serien:	104.0	105.3	103.8	103.1	104.6	104.2			
Zähler:	58	2	0	0	0	0	0	0	0
Innenzehner:	49								
weiteste:	266 (21), 255 (33), 249 (22)								
beste Teiler	13.1 (25.) 43.3 (7.) 46.6 (14.)								
Trefferlage	0.19 mm rechts, 0.46 mm hoch								
Streuwert	0.99, horizontal: 1.05, vertikal: 0.92								

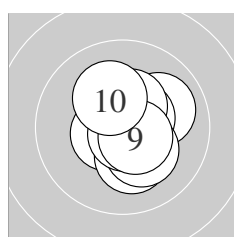
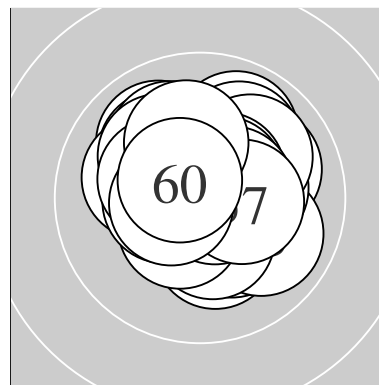

Serie 1:	10.0 ↗	10.5 *	10.5 *	10.6 *	10.2 *
	10.2 *	10.8 *	10.4 *	10.6 *	10.2 *
beste Teiler	43.3 (7.) 97.0 (9.) 98.0 (4.)				
Trefferlage	0.45 mm rechts, 0.12 mm hoch				
Streuwert	1.06, horizontal: 0.90, vertikal: 1.19				

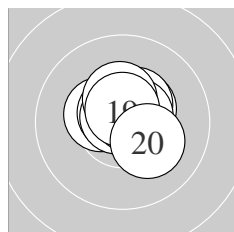

Serie 2:	10.4 *	10.7 *	10.4 *	10.8 *	10.4 *
	10.7 *	10.6 *	10.4 *	10.7 *	10.2 *
beste Teiler	46.6 (14.) 63.4 (16.) 74.4 (12.)				
Trefferlage	0.22 mm rechts, 0.50 mm hoch				
Streuwert	0.76, horizontal: 0.83, vertikal: 0.67				

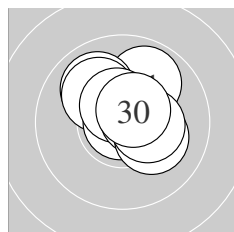

Serie 3:	9.9 ↗	10.0 ↘	10.1 ↘	10.7 *	10.9 *
	10.5 *	10.6 *	10.2 *	10.3 *	10.6 *
beste Teiler	13.1 (25.) 69.0 (24.) 92.0 (27.)				
Trefferlage	0.33 mm rechts, 0.68 mm hoch				
Streuwert	1.10, horizontal: 1.16, vertikal: 1.05				

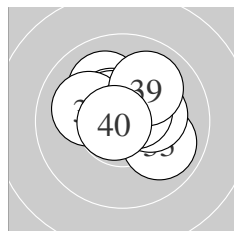

Serie 4:	10.4 *	10.1 ↘	9.9 ↘	10.5 *	10.5 *
	10.3 *	10.1 ↖	10.6 *	10.0 ↗	10.7 *
beste Teiler	51.1 (40.) 95.6 (38.) 101.0 (35.)				
Trefferlage	0.19 mm rechts, 0.70 mm hoch				
Streuwert	1.18, horizontal: 1.36, vertikal: 0.95				

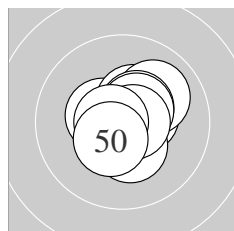

Serie 5:	10.4 *	10.4 *	10.5 *	10.4 *	10.0 ↗
	10.5 *	10.5 *	10.7 *	10.7 *	10.5 *
beste Teiler	62.0 (48.) 69.0 (49.) 108.5 (47.)				
Trefferlage	0.37 mm rechts, 0.25 mm hoch				
Streuwert	0.93, horizontal: 0.95, vertikal: 0.92				

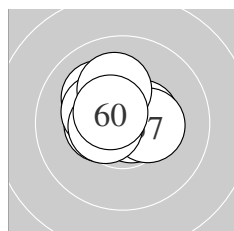

Serie 6:	10.4 *	10.5 *	10.7 *	10.7 *	10.1 ↘
	10.3 *	10.3 *	10.1 ↖	10.5 *	10.6 *
beste Teiler	56.0 (54.) 73.0 (53.) 97.0 (60.)				
Trefferlage	0.37 mm links, 0.51 mm hoch				
Streuwert	0.93, horizontal: 1.08, vertikal: 0.75				

Meyton Elektronik

ISSF AR Men Jun – Wertung – Junioren

StandNr: 134

Wadlegger, Stefan #13

StartNr: 125

18. Januar 2020 13:30

AUT

QF – Schütze hat sich fürs Finale qualifiziert

Unterschrift des Schützen

Meyton Elektronik

Ergebnis: **615.0** (588)
 Serien: 102.5 103.6 101.0 103.9 101.7 102.3
 Zähler: 48 12 0 0 0 0 0 0 0
 Innenzehner: 42
 weiteste: 469 (26), 350 (58), 317 (57)
 beste Teiler 42.9 (12.) 45.1 (47.) 76.3 (60.)
 Trefferlage 0.00 mm , 0.21 mm hoch
 Streuwert 1.39, horizontal: 1.56, vertikal: 1.19

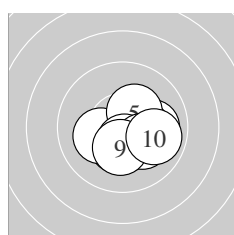
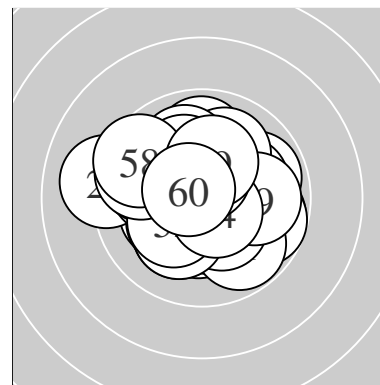

Serie 1:
 10.0 → 10.3 * 10.4 * 10.2 * 10.3 *
 10.4 * 10.5 * 10.2 * 10.3 * 9.9 →
 beste Teiler 119.9 (7.) 145.2 (6.) 150.5 (3.)
 Trefferlage 0.69 mm rechts, 0.73 mm tief
 Streuwert 1.14, horizontal: 1.36, vertikal: 0.87

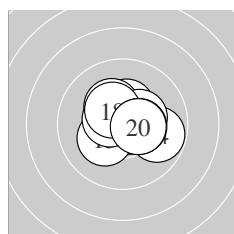

Serie 2:
 10.4 * 10.8 * 10.3 * 9.8 → 10.2 *
 10.5 * 10.4 * 10.4 * 10.4 * 10.4 *
 beste Teiler 42.9 (12.) 109.0 (16.) 127.5 (20.)
 Trefferlage 0.32 mm rechts, 0.23 mm hoch
 Streuwert 1.14, horizontal: 1.35, vertikal: 0.89

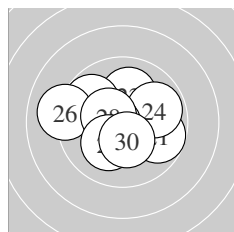

Serie 3:
 9.8 → 10.6 * 10.1 ↑ 9.9 → 9.8 ↖
 9.1 ← 10.6 * 10.5 * 10.2 * 10.4 *
 beste Teiler 77.3 (27.) 92.1 (22.) 123.1 (28.)
 Trefferlage 0.31 mm links, 0.21 mm hoch
 Streuwert 1.83, horizontal: 2.24, vertikal: 1.28

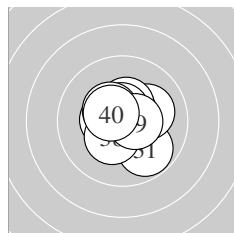

Serie 4:
 9.8 ↘ 10.1 → 10.5 * 10.6 * 10.4 *
 10.6 * 10.4 * 10.4 * 10.6 * 10.5 *
 beste Teiler 84.4 (36.) 96.6 (34.) 99.0 (39.)
 Trefferlage 0.14 mm rechts, 0.18 mm hoch
 Streuwert 1.13, horizontal: 1.16, vertikal: 1.10

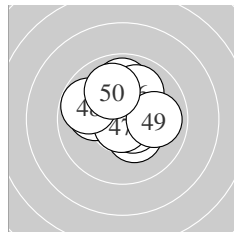

Serie 5:
 10.3 * 10.6 * 10.1 ← 10.3 * 9.9 ↑
 10.0 ↑ 10.8 * 9.8 ← 9.9 → 10.0 ↘
 beste Teiler 45.1 (47.) 96.0 (42.) 157.8 (41.)
 Trefferlage 0.02 mm rechts, 0.79 mm hoch
 Streuwert 1.47, horizontal: 1.59, vertikal: 1.34

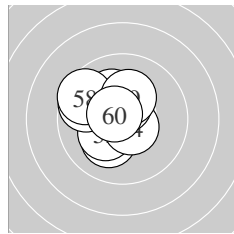

Serie 6:
 10.2 * 10.2 * 10.2 * 10.6 * 10.5 *
 10.5 * 9.7 ↖ 9.6 ↖ 10.2 * 10.6 *
 beste Teiler 76.3 (60.) 93.3 (54.) 108.8 (56.)
 Trefferlage 0.91 mm links, 0.56 mm hoch
 Streuwert 1.27, horizontal: 1.27, vertikal: 1.27

Meyton Elektronik

ISSF AR Men Jun – Wertung – Junioren

StandNr: 135

Chia, Joel #317

StartNr: 126

18. Januar 2020 13:22

SGP

Unterschrift des Schützen

Meyton Elektronik

Ergebnis:	591.3	(566)
Serien:	101.5	97.0 98.5 95.8 98.2 100.3
Zähler:	30	26 4 0 0 0 0 0 0 0
Innenzehner:	21	
weiteste:	687 (10),	583 (18), 568 (46)
beste Teiler	67.2 (4.)	81.5 (9.) 86.0 (52.)
Trefferlage	0.53 mm	rechts, 0.46 mm hoch
Streuwert	2.12,	horizontal: 2.52, vertikal: 1.62

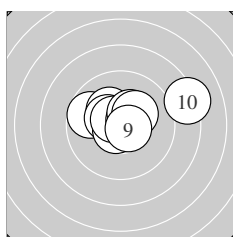
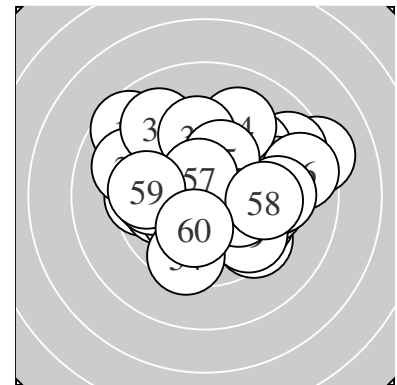

Serie 1:

9.7 ↖	10.2 *	10.4 *	10.7 *	10.6 *
10.6 *	10.3 *	10.2 *	10.6 *	8.2 →
beste Teiler	67.2 (4.)	81.5 (9.)	87.3 (5.)	
Trefferlage	0.39 mm rechts, 0.80 mm hoch			
Streuwert	1.86, horizontal: 2.50, vertikal: 0.83			

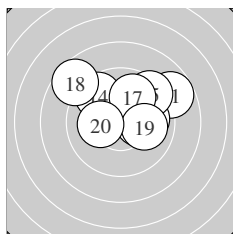

Serie 2:

8.8 ↗	10.2 *	10.0 →	9.6 ↘	9.4 ↗
10.3 *	9.9 ↗	8.6 ↘	10.0 →	10.2 *
beste Teiler	175.2 (16.)	191.9 (12.)	195.1 (20.)	
Trefferlage	0.76 mm rechts, 1.54 mm hoch			
Streuwert	2.24, horizontal: 2.78, vertikal: 1.53			

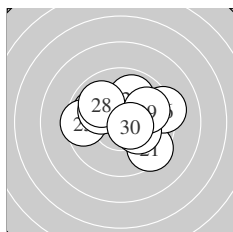

Serie 3:

9.4 ↘	9.9 ↖	9.5 ←	10.1 ↖	9.9 ↗
9.2 →	10.2 *	9.9 ↘	9.8 →	10.6 *
beste Teiler	100.6 (30.)	189.1 (27.)	218.1 (24.)	
Trefferlage	0.34 mm rechts, 0.46 mm hoch			
Streuwert	2.09, horizontal: 2.60, vertikal: 1.42			

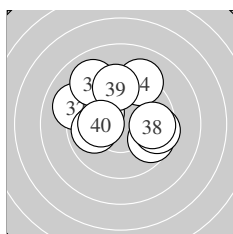

Serie 4:

10.1 ↖	9.1 ↖	9.0 ↘	9.2 ↗	9.9 ←
9.6 ↘	9.5 →	9.7 →	9.5 ↑	10.2 *
beste Teiler	190.0 (40.)	218.6 (31.)	259.1 (35.)	
Trefferlage	0.23 mm links, 1.16 mm hoch			
Streuwert	2.48, horizontal: 2.85, vertikal: 2.06			

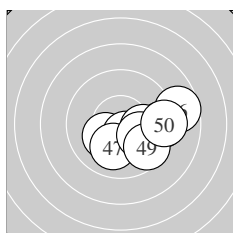

Serie 5:

10.2 *	10.3 *	10.5 *	9.4 →	10.1 →
8.7 →	10.0 ↓	10.1 ↘	9.6 ↘	9.3 →
beste Teiler	112.2 (43.)	167.6 (42.)	185.2 (41.)	
Trefferlage	1.95 mm rechts, 0.78 mm tief			
Streuwert	1.74, horizontal: 2.21, vertikal: 1.09			

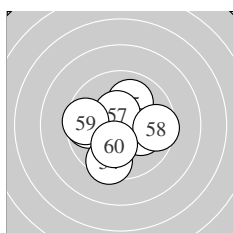

Serie 6:

9.7 ←	10.6 *	10.5 *	9.5 ↓	10.0 ↗
10.1 →	10.5 *	9.6 →	9.6 ←	10.2 *
beste Teiler	86.0 (52.)	112.5 (57.)	123.1 (53.)	
Trefferlage	0.03 mm links, 0.37 mm tief			
Streuwert	1.85, horizontal: 2.12, vertikal: 1.53			

Meyton Elektronik

ISSF AR Men Jun – Wertung – Junioren

StandNr: 136

Greber, Alexander #384

StartNr: 127

18. Januar 2020 13:16

T – SG Fügenberg

Unterschrift des Schützen

Meyton Elektronik

Ergebnis:	615.0	(588)							
Serien:	102.4	103.6	101.8	103.6	102.8	100.8			
Zähler:	48	12	0	0	0	0	0	0	0
Innenzehner:	38								
weiteste:	454 (31), 421 (56), 363 (45)								
beste Teiler	5.0 (33.)	10.1 (8.)	14.8 (47.)						
Trefferlage	0.34 mm links, 0.31 mm hoch								
Streuwert	1.37, horizontal: 1.45, vertikal: 1.27								

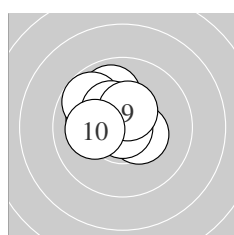
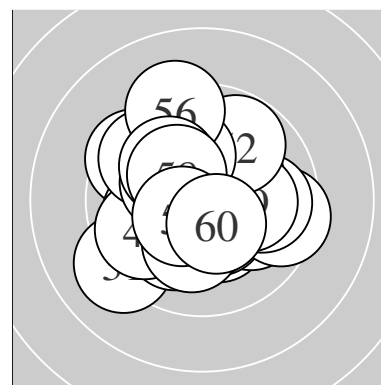

Serie 1:	10.4 *	9.9 ↗	10.4 *	10.1 ↖	10.1 ↖
	9.8 ↘	10.3 *	10.9 *	10.4 *	10.1 ←
beste Teiler	10.1 (8.) 128.0 (9.) 133.9 (1.)				
Trefferlage	0.97 mm links, 0.84 mm hoch				
Streuwert	1.07, horizontal: 1.19, vertikal: 0.94				

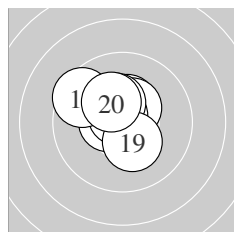

Serie 2:	10.4 *	10.5 *	10.5 *	10.7 *	10.4 *
	10.7 *	9.5 ↘	10.3 *	10.3 *	10.3 *
beste Teiler	61.2 (14.) 61.6 (16.) 102.3 (12.)				
Trefferlage	0.43 mm links, 0.76 mm hoch				
Streuwert	1.04, horizontal: 1.11, vertikal: 0.96				

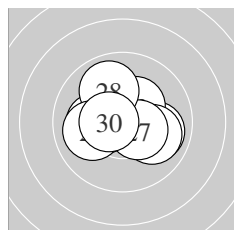

Serie 3:	9.9 ↘	10.4 *	10.3 *	10.0 ↘	10.1 ←
	10.3 *	10.4 *	9.9 ↗	10.0 ←	10.5 *
beste Teiler	103.0 (30.) 129.6 (27.) 131.3 (22.)				
Trefferlage	0.23 mm links, 0.04 mm hoch				
Streuwert	1.43, horizontal: 1.75, vertikal: 1.00				

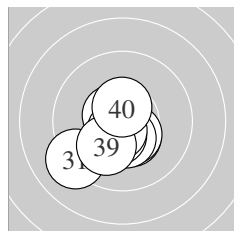

Serie 4:	9.1 ↙	10.4 *	10.9 *	10.6 *	10.5 *
	10.4 *	10.5 *	10.6 *	10.1 ↙	10.5 *
beste Teiler	5.0 (33.) 80.2 (38.) 90.9 (34.)				
Trefferlage	0.48 mm links, 0.84 mm tief				
Streuwert	1.18, horizontal: 1.23, vertikal: 1.12				

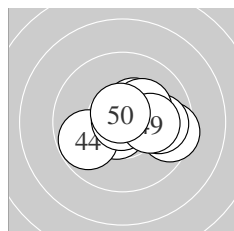

Serie 5:	10.6 *	10.7 *	10.4 *	9.8 ↙	9.5 →
	9.9 →	10.9 *	10.2 *	10.1 →	10.7 *
beste Teiler	14.8 (47.) 69.1 (50.) 71.0 (42.)				
Trefferlage	0.81 mm rechts, 0.05 mm hoch				
Streuwert	1.37, horizontal: 1.77, vertikal: 0.79				

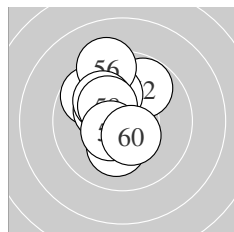

Serie 6:	9.7 ↘	9.8 ↗	10.2 *	10.3 *	10.1 ↗
	9.3 ↗	10.1 ↘	10.3 *	10.5 *	10.5 *
beste Teiler	116.5 (59.) 125.5 (60.) 161.2 (58.)				
Trefferlage	0.77 mm links, 1.00 mm hoch				
Streuwert	1.51, horizontal: 1.13, vertikal: 1.80				

Meyton Elektronik

ISSF AR Men Jun – Wertung – Junioren

StandNr: 137

Rotrekl, Filip #334

StartNr: 128

18. Januar 2020 13:25

CZE

Unterschrift des Schützen

Meyton Elektronik

Ergebnis:	608.4	(584)
Serien:	102.5	100.6 101.7 101.2 101.5 100.9
Zähler:	44	16 0 0 0 0 0 0 0 0
Innenzehner:	31	
weiteste:	478	(14), 356 (47), 350 (32)
beste Teiler	60.4	(45.) 72.8 (44.) 81.1 (2.)
Trefferlage	0.15 mm	links, 0.17 mm hoch
Streuwert	1.58,	horizontal: 1.81, vertikal: 1.31

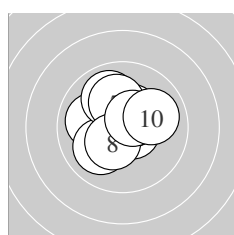
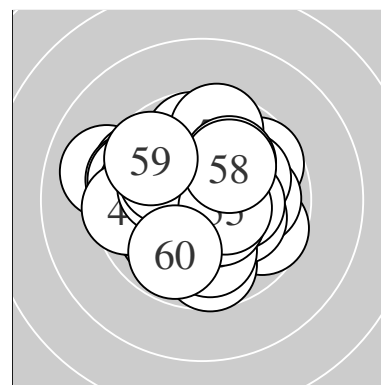

Serie 1:	10.4 *	10.6 *	10.0 ←	10.0 ✓	10.6 *
	9.9 ↘	10.1 ↑	10.4 *	10.5 *	10.0 →
beste Teiler	81.1 (2.) 98.4 (5.) 107.7 (9.)				
Trefferlage	0.11 mm links, 0.51 mm hoch				
Streuwert	1.33, horizontal: 1.41, vertikal: 1.24				

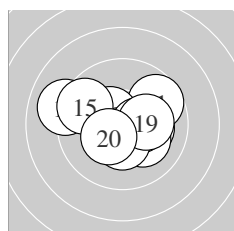

Serie 2:	9.7 ↗	10.2 *	10.5 *	9.0 ←	9.6 ↘
	10.2 *	10.4 *	10.4 *	10.2 *	10.4 *
beste Teiler	124.8 (13.) 128.4 (17.) 143.0 (18.)				
Trefferlage	0.04 mm links, 0.13 mm hoch				
Streuwert	1.87, horizontal: 2.37, vertikal: 1.15				

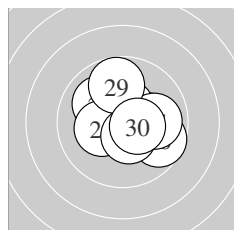

Serie 3:	10.1 →	10.5 *	10.0 ↖	10.4 *	10.3 *
	9.7 ↘	9.9 →	10.5 *	9.8 ↑	10.5 *
beste Teiler	120.3 (22.) 120.8 (28.) 123.4 (30.)				
Trefferlage	0.68 mm rechts, 0.19 mm hoch				
Streuwert	1.48, horizontal: 1.63, vertikal: 1.31				

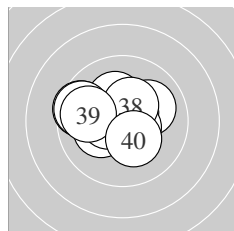

Serie 4:	10.2 *	9.6 ←	10.2 *	10.5 *	9.6 ←
	10.0 ↗	10.6 *	10.4 *	9.8 ←	10.3 *
beste Teiler	99.9 (37.) 116.0 (34.) 141.3 (38.)				
Trefferlage	0.84 mm links, 0.39 mm hoch				
Streuwert	1.53, horizontal: 1.92, vertikal: 1.00				

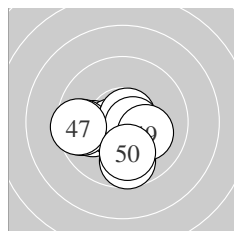

Serie 5:	10.0 ←	10.6 *	9.6 ←	10.7 *	10.7 *
	10.6 *	9.5 ←	9.7 ↓	10.1 ↘	10.0 ↓
beste Teiler	60.4 (45.) 72.8 (44.) 84.8 (46.)				
Trefferlage	0.56 mm links, 0.83 mm tief				
Streuwert	1.52, horizontal: 1.85, vertikal: 1.08				

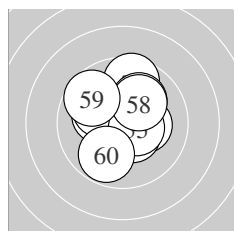

Serie 6:	10.2 *	10.3 *	10.5 *	10.1 ↖	10.5 *
	9.6 ↑	10.1 ↗	10.1 ↗	9.7 ↖	9.8 ✓
beste Teiler	117.3 (55.) 122.6 (53.) 173.7 (52.)				
Trefferlage	0.04 mm links, 0.64 mm hoch				
Streuwert	1.64, horizontal: 1.60, vertikal: 1.69				

Meyton Elektronik

ISSF AR Men Jun – Wertung – Junioren

StandNr: 138

Phang, Ryan #385

StartNr: 129

18. Januar 2020 13:20

SGP

Unterschrift des Schützen

Meyton Elektronik

ISSF AR Men Jun – Wertung – Junioren

StandNr: 140

Massani, Marco #290

StartNr: 131

18. Januar 2020 13:28

T – SG Steinach

Unterschrift des Schützen

Meyton Elektronik

Ergebnis: **621.2** (595)
 Serien: 103.8 102.3 104.8 103.9 103.1 103.3
 Zähler: 55 5 0 0 0 0 0 0 0 0
 Innenzehner: 43
 weiteste: 372 (19), 321 (5), 278 (50)
 beste Teiler 16.7 (21.) 20.0 (46.) 27.0 (49.)
 Trefferlage 0.32 mm rechts, 0.06 mm hoch
 Streuwert 1.17, horizontal: 1.22, vertikal: 1.12

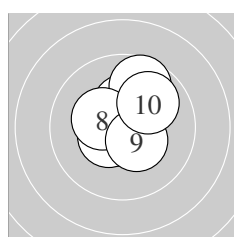
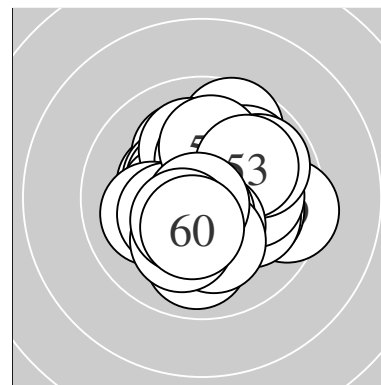

Serie 1:
 10.3 * 10.8 * 10.6 * 10.6 * 9.7 ↗
 10.7 * 10.5 * 10.3 * 10.4 * 9.9 ↗
 beste Teiler 41.9 (2.) 56.7 (6.) 81.8 (3.)
 Trefferlage 0.01 mm rechts, 0.42 mm hoch
 Streuwert 1.19, horizontal: 1.08, vertikal: 1.29

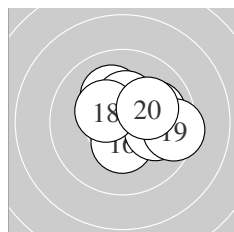

Serie 2:
 10.0 → 10.1 ↖ 10.7 * 10.7 * 10.4 *
 10.4 * 10.0 → 10.4 * 9.5 → 10.1 →
 beste Teiler 59.3 (13.) 74.6 (14.) 144.0 (16.)
 Trefferlage 0.89 mm rechts, 0.43 mm hoch
 Streuwert 1.32, horizontal: 1.57, vertikal: 1.01

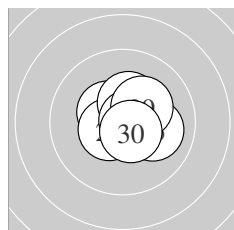

Serie 3:
 10.9 * 10.3 * 10.6 * 10.4 * 10.1 →
 10.5 * 10.4 * 10.7 * 10.3 * 10.6 *
 beste Teiler 16.7 (21.) 54.3 (28.) 78.7 (23.)
 Trefferlage 0.38 mm rechts, 0.16 mm hoch
 Streuwert 0.93, horizontal: 1.09, vertikal: 0.73

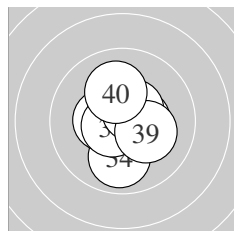

Serie 4:
 10.6 * 10.8 * 10.3 * 9.9 ↓ 10.5 *
 10.4 * 10.6 * 10.5 * 10.2 * 10.1 ↖
 beste Teiler 38.8 (32.) 81.4 (37.) 88.0 (31.)
 Trefferlage 0.14 mm rechts, 0.17 mm tief
 Streuwert 1.12, horizontal: 1.05, vertikal: 1.18

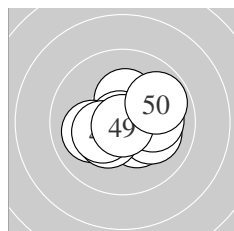

Serie 5:
 10.3 * 10.4 * 10.0 ← 10.1 → 10.4 *
 10.9 * 10.1 → 10.3 * 10.8 * 9.8 ↗
 beste Teiler 20.0 (46.) 27.0 (49.) 147.0 (42.)
 Trefferlage 0.29 mm rechts, 0.14 mm tief
 Streuwert 1.31, horizontal: 1.59, vertikal: 0.95

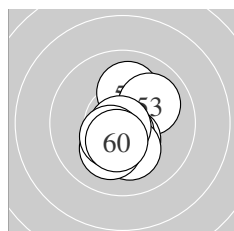

Serie 6:
 10.2 * 10.1 ↑ 10.0 ↗ 10.4 * 10.7 *
 10.2 * 10.8 * 10.1 ↓ 10.4 * 10.4 *
 beste Teiler 35.2 (57.) 72.0 (55.) 129.0 (54.)
 Trefferlage 0.24 mm rechts, 0.32 mm tief
 Streuwert 1.21, horizontal: 0.92, vertikal: 1.44

ISSF AR Men Jun – Wertung – Junioren

StandNr: 141

Gutierrez, Julian #386

StartNr: 132

18. Januar 2020 13:39

ARG

Unterschrift des Schützen

Meyton Elektronik

Ergebnis:	617.2	(589)
Serien:	103.6	100.6 103.4 102.8 104.4 102.4
Zähler:	49	11 0 0 0 0 0 0 0 0
Innenzehner:	40	
weiteste:	416 (19), 372 (34), 346 (12)	
beste Teiler	26.0 (35.)	41.1 (46.) 45.0 (53.)
Trefferlage	0.10 mm rechts, 0.55 mm hoch	
Streuwert	1.31, horizontal: 1.43, vertikal: 1.18	

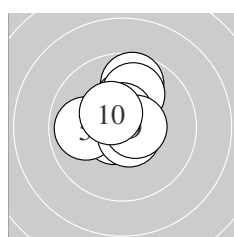
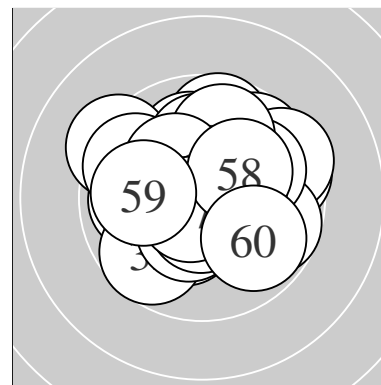

Serie 1:	10.7 *	9.7 ↑	10.7 *	10.3 *	9.9 ←
	10.0 ↑	10.7 *	10.6 *	10.6 *	10.4 *
beste Teiler	62.6 (1.) 70.2 (3.) 73.4 (7.)				
Trefferlage	0.05 mm links, 0.81 mm hoch				
Streuwert	1.15, horizontal: 1.07, vertikal: 1.22				

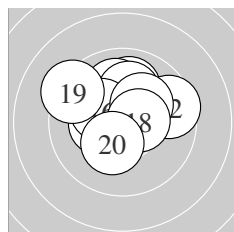

Serie 2:	10.0 ↑	9.6 →	10.3 *	10.0 ↑	10.1 ↑
	10.3 *	10.2 *	10.5 *	9.3 ↘	10.3 *
beste Teiler	113.6 (18.) 160.3 (13.) 165.9 (20.)				
Trefferlage	0.12 mm links, 1.06 mm hoch				
Streuwert	1.61, horizontal: 1.90, vertikal: 1.26				

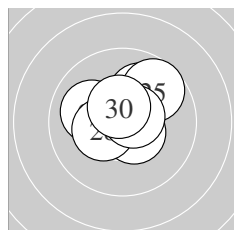

Serie 3:	10.7 *	10.6 *	10.4 *	10.0 ↑	9.7 ↗
	10.5 *	10.0 ←	10.4 *	10.6 *	10.5 *
beste Teiler	60.8 (21.) 84.2 (22.) 85.8 (29.)				
Trefferlage	0.16 mm rechts, 0.75 mm hoch				
Streuwert	1.13, horizontal: 1.29, vertikal: 0.94				

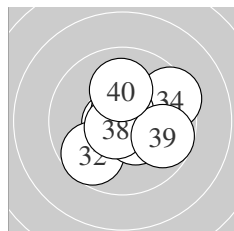

Serie 4:	10.7 *	9.7 ↙	10.5 *	9.5 →	10.8 *
	10.4 *	10.7 *	10.7 *	9.7 →	10.1 ↑
beste Teiler	26.0 (35.) 59.0 (37.) 65.1 (38.)				
Trefferlage	0.48 mm rechts, 0.08 mm tief				
Streuwert	1.48, horizontal: 1.65, vertikal: 1.30				

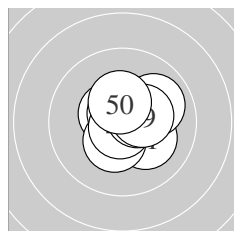

Serie 5:	10.2 *	10.5 *	10.5 *	10.4 *	10.7 *
	10.8 *	10.5 *	10.0 ↗	10.4 *	10.4 *
beste Teiler	41.1 (46.) 68.0 (45.) 108.4 (42.)				
Trefferlage	0.46 mm rechts, 0.28 mm hoch				
Streuwert	0.99, horizontal: 1.05, vertikal: 0.93				

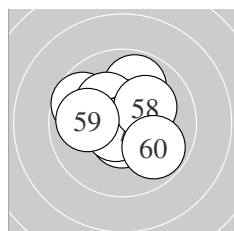

Serie 6:	10.5 *	10.6 *	10.8 *	9.7 ↘	9.9 ↑
	10.2 *	10.7 *	10.2 *	10.0 ←	9.8 ↘
beste Teiler	45.0 (53.) 69.2 (57.) 95.1 (52.)				
Trefferlage	0.29 mm links, 0.49 mm hoch				
Streuwert	1.46, horizontal: 1.62, vertikal: 1.27				

Meyton Elektronik

ISSF AR Men Jun – Wertung – Junioren

StandNr: 142

Gai, Tian Rui #309

StartNr: 133

18. Januar 2020 13:22

SGP

Unterschrift des Schützen

Meyton Elektronik

Ergebnis:	622.8	(592) ^{QF}							
Serien:	103.7	103.9	102.6	103.6	104.1	104.9			
Zähler:	52	8	0	0	0	0	0	0	0
Innenzehner:	50								
weiteste:	440 (26), 376 (47), 356 (9)								
beste Teiler	32.4 (58.) 32.6 (41.) 34.4 (23.)								
Trefferlage	0.14 mm links, 0.15 mm hoch								
Streuwert	1.20, horizontal: 1.44, vertikal: 0.90								

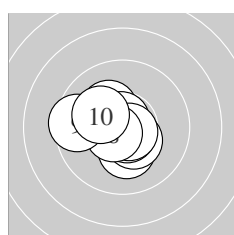
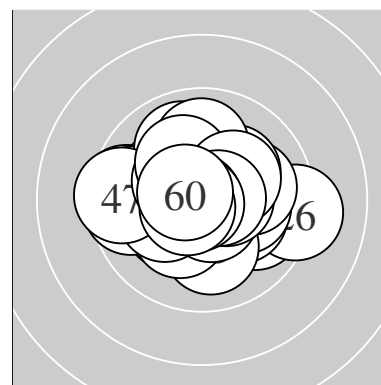

Serie 1:	10.5 *	10.2 *	10.4 *	10.2 *	10.7 *
	10.7 *	10.7 *	10.6 *	9.5 ←	10.2 *
beste Teiler	54.5 (6.) 62.2 (7.) 64.3 (5.)				
Trefferlage	0.59 mm links, 0.02 mm tief				
Streuwert	1.16, horizontal: 1.32, vertikal: 0.98				

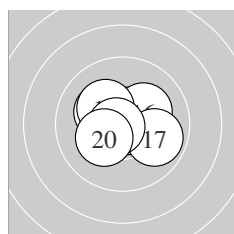

Serie 2:	10.6 *	10.6 *	10.5 *	10.2 *	10.8 *
	10.2 *	9.9 ↘	10.2 *	10.7 *	10.2 *
beste Teiler	49.7 (15.) 53.4 (19.) 76.3 (11.)				
Trefferlage	0.17 mm links, 0.07 mm hoch				
Streuwert	1.14, horizontal: 1.38, vertikal: 0.84				

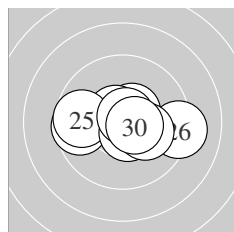

Serie 3:	9.6 ←	10.5 *	10.8 *	10.6 *	9.7 ←
	9.2 →	10.6 *	10.8 *	10.2 *	10.6 *
beste Teiler	34.4 (23.) 50.1 (28.) 83.6 (24.)				
Trefferlage	0.16 mm rechts, 0.04 mm tief				
Streuwert	1.64, horizontal: 2.24, vertikal: 0.58				

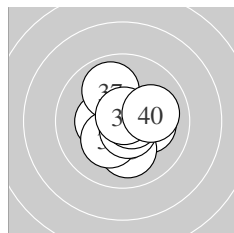

Serie 4:	10.6 *	10.2 *	10.1 ↓	10.4 *	10.3 *
	10.6 *	9.9 ↗	10.7 *	10.8 *	10.0 →
beste Teiler	42.7 (39.) 71.4 (38.) 79.6 (36.)				
Trefferlage	0.18 mm rechts, 0.17 mm tief				
Streuwert	1.23, horizontal: 1.23, vertikal: 1.23				

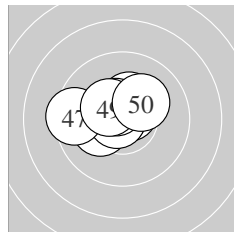

Serie 5:	10.8 *	10.7 *	10.3 *	10.2 *	10.8 *
	10.8 *	9.4 ←	10.5 *	10.4 *	10.2 *
beste Teiler	32.6 (41.) 39.4 (45.) 45.2 (46.)				
Trefferlage	0.56 mm links, 0.49 mm hoch				
Streuwert	1.11, horizontal: 1.43, vertikal: 0.65				

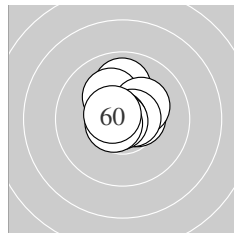

Serie 6:	9.9 ↑	10.5 *	10.6 *	10.2 *	10.2 *
	10.7 *	10.8 *	10.8 *	10.6 *	10.6 *
beste Teiler	32.4 (58.) 36.1 (57.) 75.4 (56.)				
Trefferlage	0.10 mm rechts, 0.57 mm hoch				
Streuwert	0.89, horizontal: 0.86, vertikal: 0.92				

Meyton Elektronik

ISSF AR Men Jun – Wertung – Junioren

StandNr: 143

Kapil, Dev #387

StartNr: 134

18. Januar 2020 13:20

Indian Army

QF – Schütze hat sich fürs Finale qualifiziert

Unterschrift des Schützen

Meyton Elektronik

Ergebnis: **627.4** (598)^{QF}
 Serien: 104.9 104.0 106.0 103.2 104.8 104.5
 Zähler: 58 2 0 0 0 0 0 0 0
 Innenzehner: 51
 weiteste: 303 (15), 276 (5), 246 (32)
 beste Teiler 40.3 (2.) 52.3 (35.) 57.3 (29.)
 Trefferlage 0.18 mm links, 0.22 mm hoch
 Streuwert 0.96, horizontal: 0.82, vertikal: 1.08

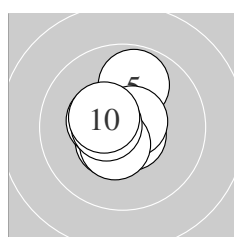
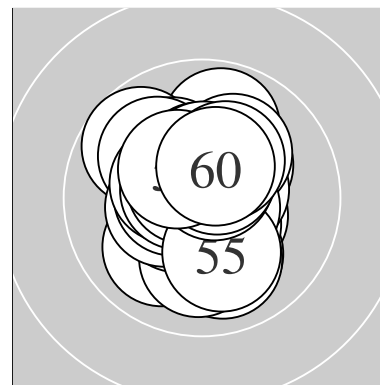

Serie 1:
 10.7 * 10.8 * 10.6 * 10.5 * 9.8 ↑
 10.7 * 10.5 * 10.4 * 10.5 * 10.4 *
 beste Teiler 40.3 (2.) 69.9 (6.) 70.7 (1.)
 Trefferlage 0.35 mm links, 0.15 mm hoch
 Streuwert 0.93, horizontal: 0.77, vertikal: 1.07

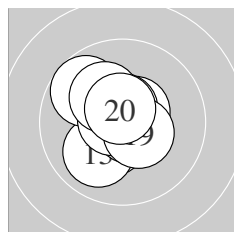

Serie 2:
 10.6 * 10.4 * 10.0 ✓ 10.7 * 9.7 ↘
 10.6 * 10.7 * 10.2 * 10.5 * 10.6 *
 beste Teiler 60.4 (14.) 61.3 (17.) 84.0 (16.)
 Trefferlage 0.42 mm links, 0.19 mm hoch
 Streuwert 1.13, horizontal: 1.05, vertikal: 1.21

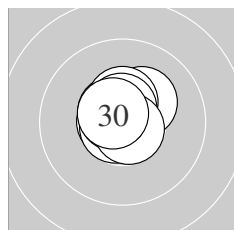

Serie 3:
 10.7 * 10.7 * 10.7 * 10.6 * 10.7 *
 10.3 * 10.4 * 10.6 * 10.7 * 10.6 *
 beste Teiler 57.3 (29.) 58.0 (23.) 66.0 (21.)
 Trefferlage 0.14 mm links, 0.49 mm hoch
 Streuwert 0.59, horizontal: 0.58, vertikal: 0.59

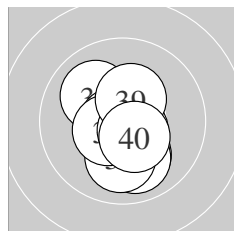

Serie 4:
 10.0 ↓ 10.0 ↓ 10.5 * 10.0 ↘ 10.7 *
 10.0 ↓ 10.5 * 10.6 * 10.4 * 10.5 *
 beste Teiler 52.3 (35.) 86.3 (38.) 109.0 (37.)
 Trefferlage 0.06 mm links, 0.52 mm tief
 Streuwert 1.21, horizontal: 0.90, vertikal: 1.46

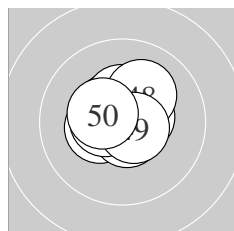

Serie 5:
 10.5 * 10.5 * 10.4 * 10.7 * 10.4 *
 10.7 * 10.5 * 10.1 ↑ 10.6 * 10.4 *
 beste Teiler 63.5 (46.) 68.9 (44.) 80.0 (49.)
 Trefferlage 0.19 mm links, 0.38 mm hoch
 Streuwert 0.87, horizontal: 0.96, vertikal: 0.76

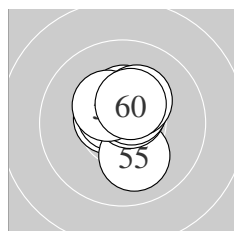

Serie 6:
 10.6 * 10.6 * 10.4 * 10.6 * 10.1 ↓
 10.6 * 10.5 * 10.4 * 10.3 * 10.4 *
 beste Teiler 78.8 (54.) 78.8 (56.) 80.0 (51.)
 Trefferlage 0.07 mm rechts, 0.61 mm hoch
 Streuwert 0.86, horizontal: 0.67, vertikal: 1.01

Meyton Elektronik

QF – Schütze hat sich fürs Finale qualifiziert

Unterschrift des Schützen

Meyton Elektronik