

Ergebnis: **607.6** (580)  
 Serien: 101.9 103.7 101.0 101.1 97.7 102.2  
 Zähler: 42 16 2 0 0 0 0 0 0 0  
 Innenezehner: 31  
 Weitester: 577 (45.), 563 (9.), 472 (28.)  
 beste Teiler: 30.0 (2.), 48.0 (60.), 60.4 (3.)  
 Trefferlage: 0.45 mm rechts, 0.04 mm hoch  
 Streuwert: 1.68, horizontal: 1.90, vertikal: 1.43

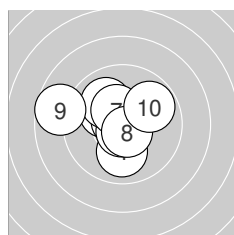
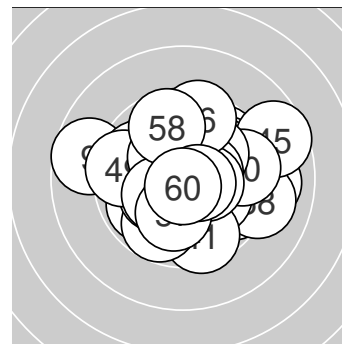

**Serie 1: 101.9 (97)**

10.2* ↖	10.8* →	10.7* ↖	10.0 ↓	10.7* ↓
10.0 ↖	10.4* ↖	10.6* ↘	8.7 ↖	9.8 ↗

beste Teiler: 30.0 (2.), 60.4 (3.), 63.7 (5.)  
 Trefferlage: 0.67 mm links, 0.35 mm hoch  
 Streuwert: 1.70, horizontal: 2.02, vertikal: 1.31

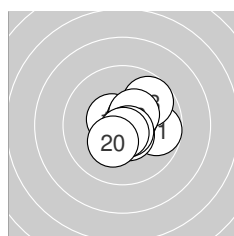

**Serie 2: 103.7 (98)**

9.7 →	10.7* ↘	9.7 ↗	10.5* ↖	10.5* ↗
10.4* ↗	10.5* ↘	10.7* ↘	10.7* ↓	10.3* ↘

beste Teiler: 68.4 (19.), 72.9 (18.), 73.5 (12.)  
 Trefferlage: 0.67 mm rechts, 0.04 mm tief  
 Streuwert: 1.13, horizontal: 1.22, vertikal: 1.05

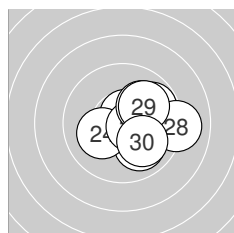

**Serie 3: 101.0 (98)**

10.5* →	10.7* ↑	10.0 ↘	10.2* ↖	10.6* →
9.8 ↗	10.1 ↗	9.1 →	10.0 ↗	10.0 ↘

beste Teiler: 75.5 (22.), 84.1 (25.), 102.6 (21.)  
 Trefferlage: 1.42 mm rechts, 0.03 mm hoch  
 Streuwert: 1.47, horizontal: 1.66, vertikal: 1.25

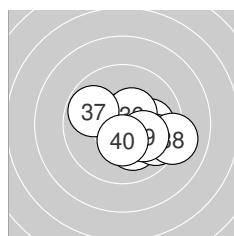

**Serie 4: 101.1 (97)**

10.7* ↖	10.7* ↗	10.1 ↘	10.0 →	9.7 ↘
10.5* ↗	9.8 ↖	9.1 →	10.1 ↘	10.4* ↓

beste Teiler: 61.7 (31.), 72.4 (32.), 123.5 (36.)  
 Trefferlage: 1.05 mm rechts, 0.38 mm tief  
 Streuwert: 1.58, horizontal: 1.94, vertikal: 1.12

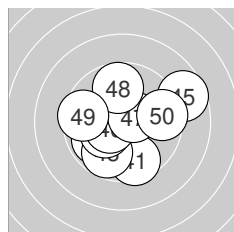

**Serie 5: 97.7 (92)**

9.5 ↓	9.9 ↖	9.8 ↘	10.2* ↖	8.6 →
10.5* ↖	10.5* ↗	9.7 ↑	9.5 ↖	9.5 →

beste Teiler: 104.2 (47.), 122.2 (46.), 178.8 (44.)  
 Trefferlage: 0.06 mm rechts, 0.20 mm tief  
 Streuwert: 2.38, horizontal: 2.69, vertikal: 2.01

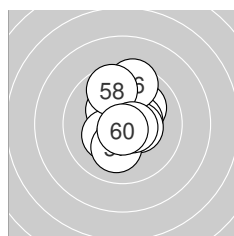

**Serie 6: 102.2 (98)**

10.3* ↖	10.1 ↗	10.4* →	10.3* ↖	10.4* →
9.5 ↑	10.1 ↓	9.7 ↖	10.6* →	10.8* ↓

beste Teiler: 48.0 (60.), 90.7 (59.), 132.6 (53.)  
 Trefferlage: 0.21 mm rechts, 0.54 mm hoch  
 Streuwert: 1.46, horizontal: 1.11, vertikal: 1.74

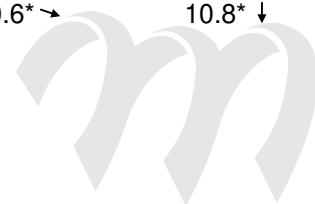

Ergebnis: **603.0** (576)  
 Serien: 100.3 99.7 102.2 100.0 100.7 100.1  
 Zähler: 38 20 2 0 0 0 0 0 0 0  
 Innenezehner: 31  
 Weitestе: 710 (38.), 553 (6.), 455 (55.)  
 beste Teiler: 14.8 (40.), 45.2 (35.), 46.2 (44.)  
 Trefferlage: 0.33 mm links, 0.27 mm hoch  
 Streuwert: 1.86, horizontal: 2.35, vertikal: 1.18

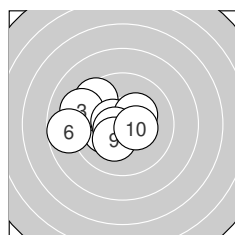
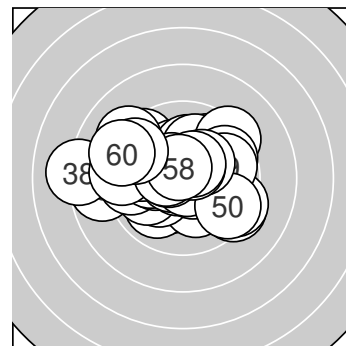

**Serie 1: 100.3 (96)**

9.5 ↘	10.2* ←	9.2 ↖	10.6* ↖	10.5* ←
8.7 ←	10.3* ↗	10.6* ↗	10.3* ↘	10.4* →

beste Teiler: 88.8 (4.), 92.9 (8.), 104.6 (5.)  
 Trefferlage: 1.48 mm links, 0.09 mm hoch  
 Streuwert: 1.76, horizontal: 2.17, vertikal: 1.20

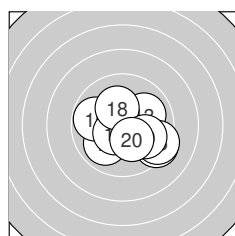

**Serie 2: 99.7 (95)**

9.3 ↘	10.4* →	10.0 →	9.9 ↙	9.4 ↘
9.8 ←	10.5* ↖	10.2* ↖	9.9 →	10.3* ↘

beste Teiler: 111.7 (17.), 149.7 (12.), 173.6 (20.)  
 Trefferlage: 0.79 mm rechts, 0.58 mm tief  
 Streuwert: 1.81, horizontal: 2.19, vertikal: 1.34

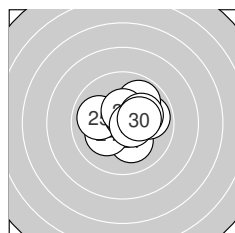

**Serie 3: 102.2 (98)**

10.2* ↘	9.9 →	9.9 ↗	10.2* ↖	10.0 ←
10.6* ↗	10.4* ↑	10.1 →	10.6* →	10.3* →

beste Teiler: 83.1 (26.), 91.2 (29.), 127.0 (27.)  
 Trefferlage: 0.60 mm rechts, 0.35 mm hoch  
 Streuwert: 1.37, horizontal: 1.58, vertikal: 1.13

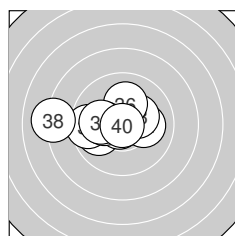

**Serie 4: 100.0 (96)**

9.9 ←	10.1 →	10.3* ↗	9.5 ←	10.8* ↖
10.1 ↑	10.2* ←	8.1 ←	10.1 ←	10.9* ↘

beste Teiler: 14.8 (40.), 45.2 (35.), 169.5 (33.)  
 Trefferlage: 1.35 mm links, 0.17 mm hoch  
 Streuwert: 1.99, horizontal: 2.70, vertikal: 0.81

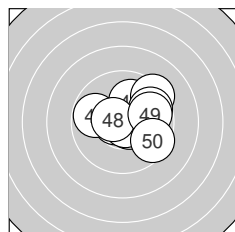

**Serie 5: 100.7 (95)**

10.6* ↘	10.6* ←	9.8 ↖	10.8* ↘	10.0 ↑
9.3 ↗	9.7 ↗	10.6* ←	9.8 →	9.5 ↘

beste Teiler: 46.2 (44.), 76.3 (42.), 86.2 (41.)  
 Trefferlage: 0.90 mm rechts, 0.50 mm hoch  
 Streuwert: 1.71, horizontal: 2.03, vertikal: 1.33

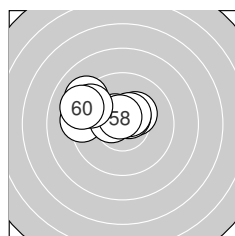

**Serie 6: 100.1 (96)**

10.3* ↗	10.6* ↗	10.5* ↘	10.5* ↗	9.1 ↘
9.3 ←	10.5* ←	10.6* ↖	9.5 ↖	9.2 ↖

beste Teiler: 78.1 (58.), 99.3 (52.), 113.9 (53.)  
 Trefferlage: 1.48 mm links, 1.13 mm hoch  
 Streuwert: 1.60, horizontal: 2.14, vertikal: 0.73

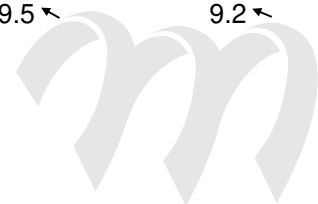

Ergebnis: **620.9** (593)  
 Serien: 103.8 103.7 104.2 103.0 103.9 102.3  
 Zähler: 53 7 0 0 0 0 0 0 0 0  
 Innenezehner: 48  
 Weitestе: 373 (32.), 341 (40.), 326 (54.)  
 beste Teiler: 23.7 (36.), 42.4 (8.), 45.3 (18.)  
 Trefferlage: 0.12 mm links, 0.24 mm hoch  
 Streuwert: 1.18, horizontal: 1.02, vertikal: 1.33

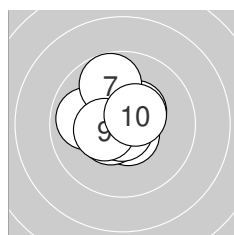
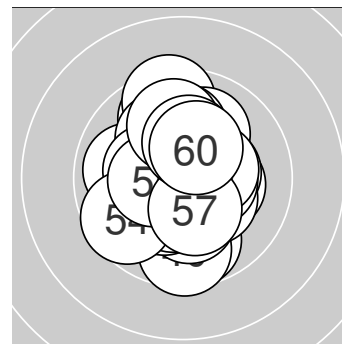

**Serie 1: 103.8 (98)**

10.4* ↗	10.2* ↘	10.7* ←	10.6* ↓	9.9 ←
10.5* ↖	9.8 ↑	10.8* ↓	10.4* ←	10.5* ↗

beste Teiler: 42.4 (8.), 51.7 (3.), 83.7 (4.)  
 Trefferlage: 0.51 mm links, 0.38 mm hoch  
 Streuwert: 1.10, horizontal: 1.09, vertikal: 1.11

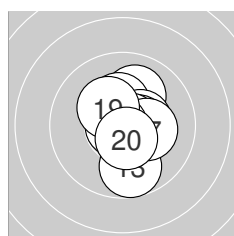

**Serie 2: 103.7 (99)**

10.0 ↑	10.3* ↑	9.7 ↓	10.4* →	10.5* →
10.8* →	10.3* →	10.8* ←	10.3* ↘	10.6* ↓

beste Teiler: 45.3 (18.), 47.6 (16.), 98.7 (20.)  
 Trefferlage: 0.44 mm rechts, 0.09 mm hoch  
 Streuwert: 1.17, horizontal: 0.85, vertikal: 1.42

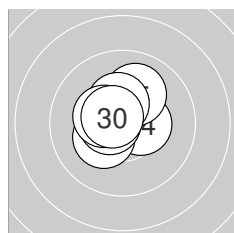

**Serie 3: 104.2 (100)**

10.5* ↘	10.5* ←	10.4* ↗	10.4* →	10.1 ↑
10.3* ↖	10.4* ↑	10.6* ←	10.4* ←	10.6* ↘

beste Teiler: 87.9 (30.), 93.0 (28.), 104.6 (21.)  
 Trefferlage: 0.35 mm links, 0.51 mm hoch  
 Streuwert: 0.94, horizontal: 0.98, vertikal: 0.91

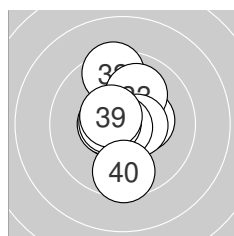

**Serie 4: 103.0 (98)**

10.3* →	9.5 ↑	10.0 ↗	10.5* →	10.6* ←
10.9* ↓	10.5* ←	10.6* ←	10.5* ↘	9.6 ↓

beste Teiler: 23.7 (36.), 83.8 (35.), 90.7 (38.)  
 Trefferlage: 0.07 mm links, 0.29 mm hoch  
 Streuwert: 1.44, horizontal: 0.94, vertikal: 1.80

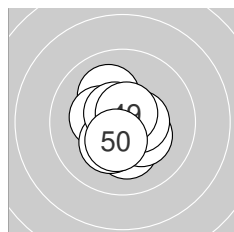

**Serie 5: 103.9 (100)**

10.1 ↘	10.3* ←	10.5* ↓	10.2* ↓	10.3* ↘
10.3* ↖	10.6* ↘	10.5* →	10.7* ↑	10.4* ↓

beste Teiler: 69.8 (49.), 85.0 (47.), 109.1 (43.)  
 Trefferlage: 0.14 mm links, 0.30 mm tief  
 Streuwert: 1.08, horizontal: 0.94, vertikal: 1.20

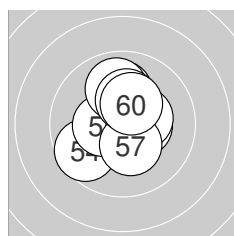

**Serie 6: 102.3 (98)**

10.7* ←	10.4* →	10.0 ↑	9.6 ↖	10.4* ←
10.4* →	10.3* ↓	9.9 ↑	10.3* ↑	10.3* ↑

beste Teiler: 70.2 (51.), 134.4 (52.), 137.2 (55.)  
 Trefferlage: 0.10 mm links, 0.46 mm hoch  
 Streuwert: 1.39, horizontal: 1.25, vertikal: 1.51



**ISSF AR Women Jun**

StandNr: 120

**Cermak, Romina** #179

**Juniorinnen**

Competition

**StartNr: 116**

02.12.2023 16:50

AUT

---

QF

- Schütze hat sich fürs Finale qualifiziert



Ergebnis: **597.5** (570)  
 Serien: 100.8 98.2 99.8 100.9 98.3 99.5  
 Zähler: 34 22 4 0 0 0 0 0 0 0  
 Innenzehner: 25  
 Weitester: 663 (60.), 516 (49.), 514 (30.)  
 beste Teiler: 32.0 (39.), 73.8 (51.), 75.5 (3.)  
 Trefferlage: 0.22 mm rechts, 0.39 mm hoch  
 Streuwert: 1.99, horizontal: 1.62, vertikal: 2.31

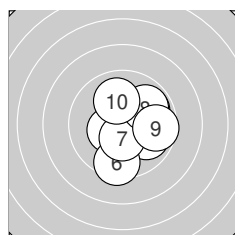
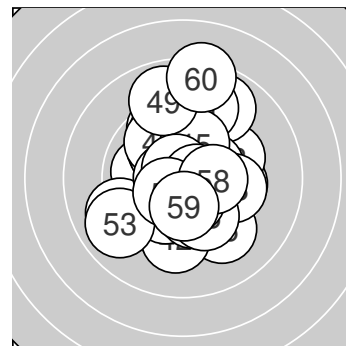

**Serie 1: 100.8 (95)**

9.9 ↗ 10.4\* → 10.7\* ↗ 10.4\* ← 9.9 ↘  
 9.5 ↓ 10.4\* ↓ 9.9 ↗ 9.7 → 10.0 ↑

beste Teiler: 75.5 (3.), 132.0 (7.), 134.2 (4.)  
 Trefferlage: 0.93 mm rechts, 0.07 mm tief  
 Streuwert: 1.65, horizontal: 1.54, vertikal: 1.75

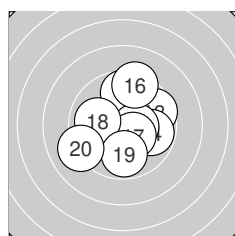

**Serie 2: 98.2 (94)**

10.1 ← 9.7 ↑ 9.6 → 9.8 → 10.4\* →  
 9.3 ↑ 10.4\* ↘ 10.0 ← 9.8 ↓ 9.1 ↙

beste Teiler: 128.5 (15.), 141.4 (17.), 223.9 (11.)  
 Trefferlage: 0.09 mm rechts, 0.12 mm hoch  
 Streuwert: 2.23, horizontal: 2.31, vertikal: 2.15

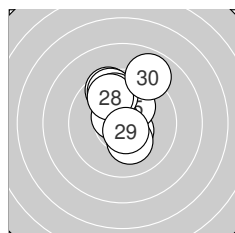

**Serie 3: 99.8 (94)**

10.5\* ↘ 9.6 ↖ 10.2\* ↓ 9.6 ↖ 10.2\* ↗  
 10.5\* ↖ 9.9 ↑ 9.8 ↖ 10.6\* ↓ 8.9 ↗

beste Teiler: 78.3 (29.), 101.4 (26.), 106.8 (21.)  
 Trefferlage: 0.01 mm links, 1.50 mm hoch  
 Streuwert: 1.70, horizontal: 1.26, vertikal: 2.06

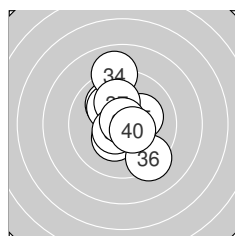

**Serie 4: 100.9 (98)**

10.0 ↘ 10.3\* ↗ 10.1 ↘ 9.0 ↑ 10.2\* →  
 9.3 ↘ 10.1 ↑ 10.6\* ↗ 10.8\* ↑ 10.5\* ↘

beste Teiler: 32.0 (39.), 97.0 (38.), 111.1 (40.)  
 Trefferlage: 0.02 mm links, 0.57 mm hoch  
 Streuwert: 1.84, horizontal: 1.33, vertikal: 2.23

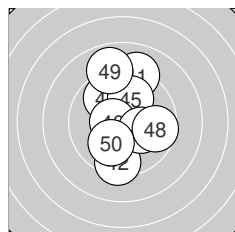

**Serie 5: 98.3 (94)**

9.1 ↑ 9.4 ↓ 9.8 ↖ 10.6\* → 10.0 ↑  
 10.6\* ← 10.2\* ↘ 9.7 → 8.9 ↖ 10.0 ↙

beste Teiler: 88.6 (44.), 97.0 (46.), 195.6 (47.)  
 Trefferlage: 0.25 mm rechts, 0.71 mm hoch  
 Streuwert: 2.28, horizontal: 1.57, vertikal: 2.82

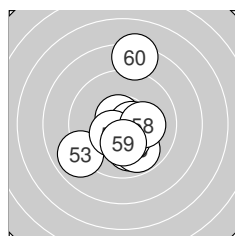

**Serie 6: 99.5 (95)**

10.7\* ↖ 10.0 ↓ 8.9 ↙ 10.6\* → 9.8 ↘  
 10.4\* ↓ 10.4\* ↗ 10.2\* → 10.2\* ↓ 8.3 ↑

beste Teiler: 73.8 (51.), 88.1 (54.), 135.1 (57.)  
 Trefferlage: 0.11 mm rechts, 0.47 mm tief  
 Streuwert: 2.27, horizontal: 1.71, vertikal: 2.72



Ergebnis: **619.9** (593)  
 Serien: 103.5 104.2 103.2 103.8<sup>OF</sup> 101.7 103.5  
 Zähler: 53 7 0 0 0 0 0 0 0 0  
 Innenezehner: 44  
 Weitestе: 312 (45.), 307 (51.), 285 (37.)  
 beste Teiler: 27.0 (34.), 30.5 (10.), 50.0 (39.)  
 Trefferlage: 0.26 mm links, 0.14 mm hoch  
 Streuwert: 1.21, horizontal: 1.37, vertikal: 1.02

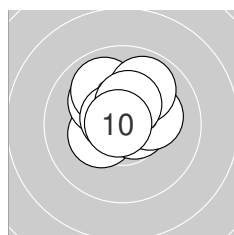
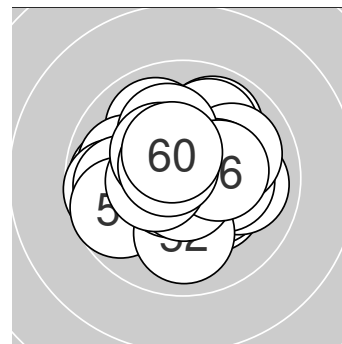

**Serie 1: 103.5 (98)**

10.6* ↗	10.3* ↖	10.1 ↘	10.6* →	10.2* →
9.9 ↘	9.9 ↗	10.7* ↘	10.4* ↑	10.8* ↖

beste Teiler: 30.5 (10.), 74.6 (8.), 79.4 (4.)  
 Trefferlage: 0.02 mm rechts, 0.80 mm hoch  
 Streuwert: 1.09, horizontal: 1.18, vertikal: 1.00

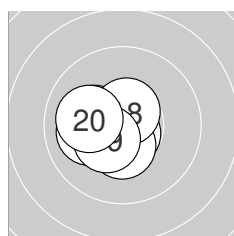

**Serie 2: 104.2 (100)**

10.5* ←	10.7* ↘	10.5* ↗	10.2* ←	10.1 ←
10.4* ↓	10.7* ↖	10.6* ↑	10.4* ↗	10.1 ←

beste Teiler: 63.5 (12.), 72.1 (17.), 94.6 (18.)  
 Trefferlage: 0.91 mm links, 0.18 mm tief  
 Streuwert: 0.85, horizontal: 0.95, vertikal: 0.74

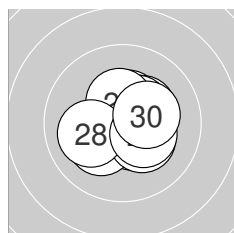

**Serie 3: 103.2 (100)**

10.4* ↑	10.5* ↘	10.2* ↗	10.3* ↗	10.3* ↘
10.4* ↗	10.4* ↑	10.1 ←	10.3* ↘	10.3* →

beste Teiler: 118.6 (22.), 135.0 (26.), 135.1 (21.)  
 Trefferlage: 0.39 mm rechts, 0.05 mm hoch  
 Streuwert: 1.17, horizontal: 1.27, vertikal: 1.07

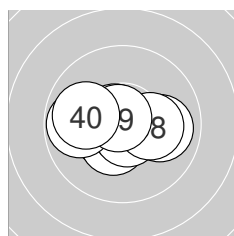

**Serie 4: 103.8 (98)**

10.5* ↖	10.0 →	10.4* ↗	10.8* ↓	10.7* ↘
10.7* ↘	9.8 ←	10.2* →	10.8* ↘	9.9 ←

beste Teiler: 27.0 (34.), 50.0 (39.), 68.4 (36.)  
 Trefferlage: 0.30 mm links, 0.17 mm tief  
 Streuwert: 1.23, horizontal: 1.65, vertikal: 0.56

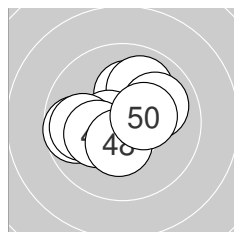

**Serie 5: 101.7 (98)**

10.3* ↗	10.2* ↑	10.0 ↗	10.6* ←	9.7 ←
9.9 ←	10.2* ↖	10.4* ↓	10.0 ↗	10.4* →

beste Teiler: 92.7 (44.), 140.2 (48.), 146.5 (50.)  
 Trefferlage: 0.21 mm links, 0.33 mm hoch  
 Streuwert: 1.53, horizontal: 1.83, vertikal: 1.17

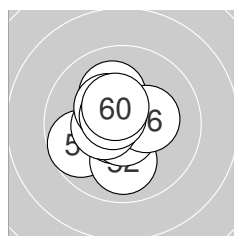

**Serie 6: 103.5 (99)**

9.7 ↖	10.0 ↓	10.7* ↖	10.1 ↘	10.7* ↓
10.3* →	10.5* ←	10.4* ↘	10.6* ↖	10.5* ↑

beste Teiler: 56.1 (55.), 66.2 (53.), 84.5 (59.)  
 Trefferlage: 0.56 mm links, 0.02 mm hoch  
 Streuwert: 1.20, horizontal: 1.10, vertikal: 1.29

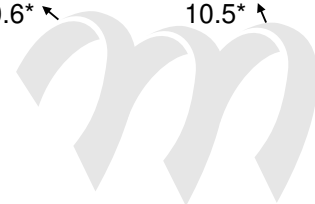

**ISSF AR Women Jun**

StandNr: 122

**Hauschild, Julia** #281

**Juniorinnen**

Competition

**StartNr: 118**

02.12.2023 16:10

T – SG Walchsee

---

QF

– Schütze hat sich fürs Finale qualifiziert



Ergebnis: **590.3** (567)  
 Serien: 93.1 94.6 103.5 96.9 102.1 100.1  
 Zähler: 36 15 9 0 0 0 0 0 0 0  
 Innenezehner: 20  
 Weitester: 728 (17.), 657 (16.), 641 (5.)  
 beste Teiler: 16.4 (60.), 38.0 (41.), 51.4 (26.)  
 Trefferlage: 0.79 mm links, 0.40 mm hoch  
 Streuwert: 2.23, horizontal: 2.56, vertikal: 1.85

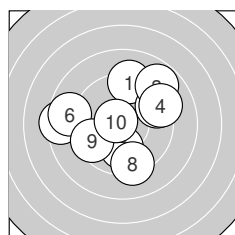
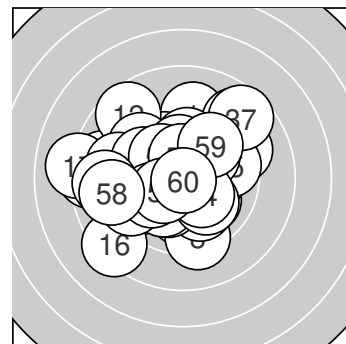

**Serie 1: 93.1 (89)**

9.2 ↑	9.4 ↗	8.8 ↗	9.2 ↗	8.4 ←
8.7 ←	10.0 ↓	9.3 ↓	9.5 ←	10.6* ↘

beste Teiler: 76.9 (10.), 241.2 (7.), 357.9 (9.)  
 Trefferlage: 0.30 mm links, 0.55 mm hoch  
 Streuwert: 3.24, horizontal: 3.69, vertikal: 2.70

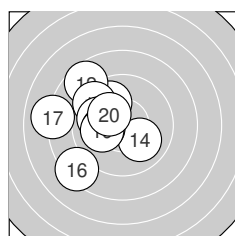

**Serie 2: 94.6 (91)**

9.9 ↘	8.6 ↘	9.5 ↘	10.0 ↘	9.9 ←
8.3 ↗	8.0 ←	10.1 ←	10.1 ←	10.2* ↘

beste Teiler: 178.3 (20.), 202.3 (18.), 218.5 (19.)  
 Trefferlage: 2.61 mm links, 0.47 mm hoch  
 Streuwert: 2.40, horizontal: 2.37, vertikal: 2.43

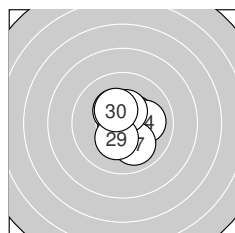

**Serie 3: 103.5 (100)**

10.4* ↓	10.6* ↑	10.4* ↗	10.1 →	10.3* ↘
10.7* ↗	10.0 ↓	10.4* ↑	10.3* ↓	10.3* ↘

beste Teiler: 51.4 (26.), 94.0 (22.), 127.0 (28.)  
 Trefferlage: 0.28 mm rechts, 0.01 mm hoch  
 Streuwert: 1.16, horizontal: 0.99, vertikal: 1.30

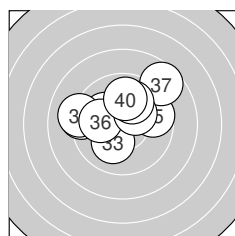

**Serie 4: 96.9 (94)**

9.2 ←	10.1 ↘	10.1 ↘	9.1 ←	9.6 →
10.0 ←	8.6 ↗	10.3* ↗	10.0 ↑	9.9 ↑

beste Teiler: 171.1 (38.), 209.4 (33.), 213.1 (32.)  
 Trefferlage: 0.41 mm links, 1.21 mm hoch  
 Streuwert: 2.32, horizontal: 2.88, vertikal: 1.58

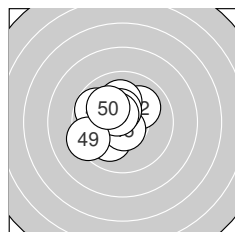

**Serie 5: 102.1 (98)**

10.8* ↓	10.0 ↗	10.1 ↘	10.1 ↑	10.7* ↓
9.8 ↘	10.5* ↑	10.6* ↘	9.4 ←	10.1 ↘

beste Teiler: 38.0 (41.), 73.3 (45.), 99.0 (48.)  
 Trefferlage: 0.83 mm links, 0.38 mm hoch  
 Streuwert: 1.47, horizontal: 1.51, vertikal: 1.43

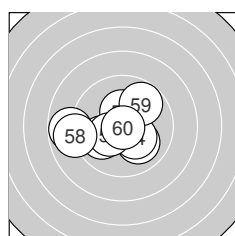

**Serie 6: 100.1 (95)**

10.7* ↑	10.0 ↘	10.4* ↑	10.3* ↘	10.0 ←
8.8 ←	10.3* ↗	8.9 ←	9.8 ↗	10.9* ↓

beste Teiler: 16.4 (60.), 66.0 (51.), 150.4 (53.)  
 Trefferlage: 0.91 mm links, 0.19 mm tief  
 Streuwert: 2.03, horizontal: 2.57, vertikal: 1.29

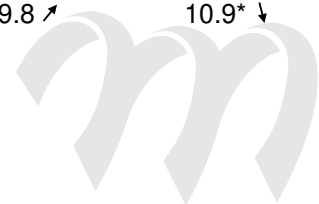



Ergebnis: **623.0** (594)  
 Serien: 104.6 102.4 103.9 103.5<sup>OF</sup> 105.0 103.6  
 Zähler: 54 6 0 0 0 0 0 0 0 0  
 Innenzehner: 47  
 Weitest: 419 (17.), 374 (28.), 296 (32.)  
 beste Teiler: 21.9 (30.), 28.3 (47.), 29.6 (48.)  
 Trefferlage: 0.21 mm links, 0.01 mm hoch  
 Streuwert: 1.17, horizontal: 0.99, vertikal: 1.31

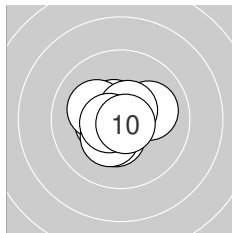
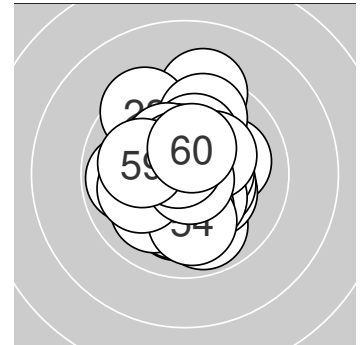

**Serie 1: 104.6 (100)**

10.6* ↗	10.4* ←	10.6* ↘	10.2* ←	10.1 →
10.6* ↗	10.4* ↓	10.3* ↘	10.6* ←	10.8* ↘

beste Teiler: 50.9 (10.), 84.6 (1.), 88.2 (6.)  
 Trefferlage: 0.18 mm links, 0.02 mm tief  
 Streuwert: 1.00, horizontal: 1.14, vertikal: 0.83

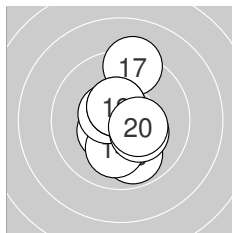

**Serie 2: 102.4 (98)**

10.4* ↖	10.5* ↘	9.9 ↓	10.1 ↓	10.5* ↖
10.3* ↘	9.3 ↑	10.5* ↗	10.5* ↗	10.4* ↘

beste Teiler: 104.9 (18.), 107.2 (19.), 109.1 (15.)  
 Trefferlage: 0.21 mm rechts, 0.12 mm tief  
 Streuwert: 1.50, horizontal: 0.94, vertikal: 1.90

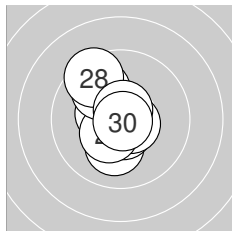

**Serie 3: 103.9 (98)**

10.1 ↓	10.8* ↘	10.4* ←	10.6* ↓	10.6* ↘
10.4* ↖	9.9 ↘	9.5 ↘	10.7* ↑	10.9* ↘

beste Teiler: 21.9 (30.), 43.6 (22.), 71.3 (29.)  
 Trefferlage: 0.44 mm links, 0.17 mm hoch  
 Streuwert: 1.27, horizontal: 0.92, vertikal: 1.53

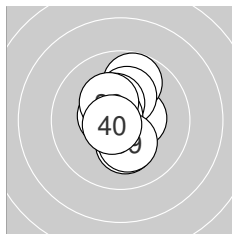

**Serie 4: 103.5 (99)**

10.5* →	9.8 ↑	10.5* ←	10.2* ↑	10.4* ↗
10.2* ↓	10.7* ↖	10.3* ↘	10.2* ↓	10.7* ↖

beste Teiler: 64.8 (37.), 73.3 (40.), 108.1 (33.)  
 Trefferlage: 0.00 mm, 0.42 mm hoch  
 Streuwert: 1.19, horizontal: 0.80, vertikal: 1.47

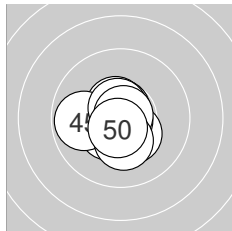

**Serie 5: 105.0 (99)**

10.4* ↘	10.4* ↖	10.7* ↑	10.6* ↖	9.8 ←
10.6* ↗	10.8* ↘	10.8* ↗	10.3* ↓	10.6* ↓

beste Teiler: 28.3 (47.), 29.6 (48.), 66.0 (43.)  
 Trefferlage: 0.30 mm links, 0.24 mm tief  
 Streuwert: 0.94, horizontal: 0.99, vertikal: 0.89

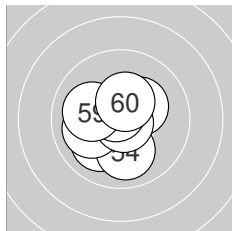

**Serie 6: 103.6 (100)**

10.8* ↘	10.3* ↗	10.0 ↘	10.0 ↓	10.5* ↖
10.0 ←	10.8* ↘	10.7* ↘	10.1 ←	10.4* ↑

beste Teiler: 36.8 (57.), 48.9 (51.), 62.9 (58.)  
 Trefferlage: 0.54 mm links, 0.09 mm tief  
 Streuwert: 1.19, horizontal: 1.19, vertikal: 1.18

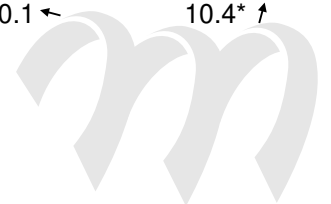

**ISSF AR Women Jun**  
StandNr: 124  
**Baumgartner, Marlene #59**

**Juniorinnen**  
Competition

**StartNr: 120**  
02.12.2023 16:46  
AUT

---

QF – Schütze hat sich fürs Finale qualifiziert



Ergebnis: **0.0** (0)<sub>DNS</sub>  
Serien:  
Zähler: 0 0 0 0 0 0 0 0 0 0 0  
Innenzehner: 0  
Weiteste:  
~~beste Teiler~~ Schütze ist nicht zum Wettkampf angetreten  
Trefferlage: 0.00 mm , 0.00 mm  
Streuwert:

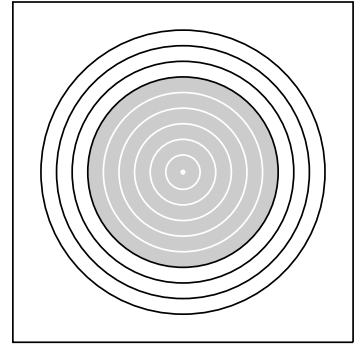

Ergebnis: **617.9** (590)  
 Serien: 102.2 103.7 102.8 103.4 103.3 102.5  
 Zähler: 50 10 0 0 0 0 0 0 0 0  
 Innenzehner: 42  
 Weitester: 345 (5.), 335 (53.), 318 (20.)  
 beste Teiler: 35.6 (23.), 40.1 (42.), 44.2 (41.)  
 Trefferlage: 0.26 mm rechts, 0.01 mm tief  
 Streuwert: 1.29, horizontal: 1.45, vertikal: 1.10

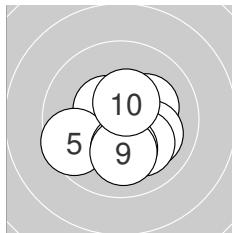
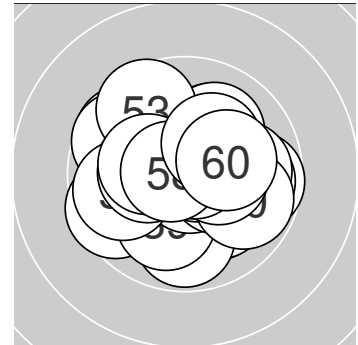

**Serie 1: 102.2 (99)**

10.6* ↑	10.5* ↖	10.2* →	10.3* ↓	9.6 ↙
10.1 ↘	10.1 ↘	10.2* ↓	10.1 ↓	10.5* ↑

beste Teiler: 80.5 (1.), 116.0 (2.), 118.2 (10.)  
 Trefferlage: 0.17 mm rechts, 0.63 mm tief  
 Streuwert: 1.39, horizontal: 1.45, vertikal: 1.31

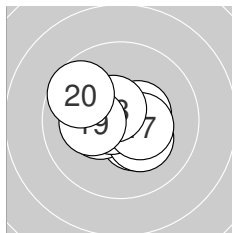

**Serie 2: 103.7 (99)**

10.4* ↘	10.5* →	10.6* ↖	10.4* ←	10.2* ↘
10.7* ←	10.4* ↘	10.6* ↖	10.2* ←	9.7 ↖

beste Teiler: 60.1 (16.), 83.7 (13.), 91.5 (18.)  
 Trefferlage: 0.31 mm links, 0.00 mm  
 Streuwert: 1.18, horizontal: 1.43, vertikal: 0.87

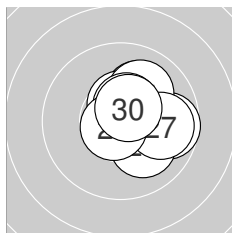

**Serie 3: 102.8 (98)**

9.7 →	10.1 ↗	10.8* ↗	10.5* ↑	10.0 ↗
10.1 ↘	9.9 →	10.5* ↑	10.7* ↗	10.5* ↗

beste Teiler: 35.6 (23.), 59.6 (29.), 102.2 (30.)  
 Trefferlage: 1.04 mm rechts, 0.44 mm hoch  
 Streuwert: 1.12, horizontal: 1.15, vertikal: 1.08

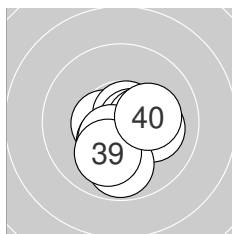

**Serie 4: 103.4 (99)**

10.5* ←	10.7* ↗	10.7* →	10.4* →	10.4* ↙
10.5* ↙	10.1 →	9.8 ↓	10.1 ↙	10.2* →

beste Teiler: 62.4 (32.), 74.0 (33.), 108.3 (31.)  
 Trefferlage: 0.30 mm rechts, 0.67 mm tief  
 Streuwert: 1.12, horizontal: 1.15, vertikal: 1.09

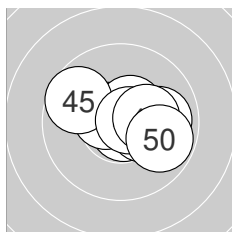

**Serie 5: 103.3 (97)**

10.8* ↘	10.8* ↑	10.5* ↖	10.5* ↗	9.7 ↖
10.3* →	9.9 →	10.7* →	10.3* →	9.8 ↘

beste Teiler: 40.1 (42.), 44.2 (41.), 57.2 (48.)  
 Trefferlage: 0.60 mm rechts, 0.17 mm hoch  
 Streuwert: 1.27, horizontal: 1.65, vertikal: 0.72

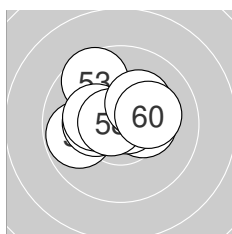

**Serie 6: 102.5 (98)**

9.8 ←	10.3* →	9.6 ↘	10.8* ↗	10.3* ↗
10.3* ←	10.3* ↖	10.7* ←	10.2* ↗	10.2* →

beste Teiler: 48.8 (54.), 64.1 (58.), 151.0 (52.)  
 Trefferlage: 0.21 mm links, 0.59 mm hoch  
 Streuwert: 1.37, horizontal: 1.67, vertikal: 0.98

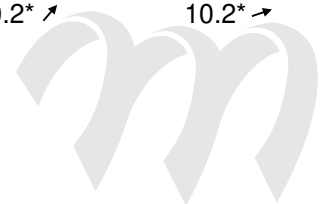

Ergebnis: **619.9** (596)  
 Serien: 103.3 103.9 101.3 102.5<sup>OF</sup> 104.3 104.6  
 Zähler: 56 4 0 0 0 0 0 0 0 0  
 Innenzehner: 47  
 Weitester: 373 (22.), 325 (33.), 296 (28.)  
 beste Teiler: 11.7 (56.), 41.7 (53.), 50.4 (14.)  
 Trefferlage: 0.15 mm rechts, 0.07 mm hoch  
 Streuwert: 1.22, horizontal: 1.15, vertikal: 1.29

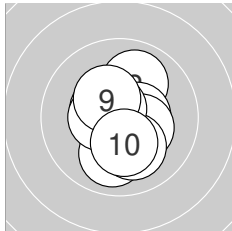
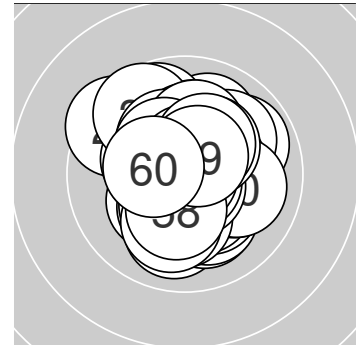

**Serie 1: 103.3 (100)**

10.5* ↖	10.0 ↗	10.0 ↓	10.5* →	10.3* ↘
10.1 ↓	10.7* ↖	10.5* ←	10.4* ↖	10.3* ↓

beste Teiler: 71.2 (7.), 117.3 (4.), 120.3 (1.)  
 Trefferlage: 0.06 mm rechts, 0.21 mm tief  
 Streuwert: 1.26, horizontal: 0.99, vertikal: 1.47

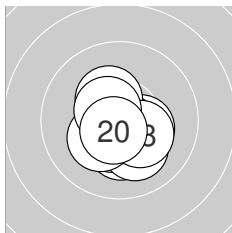

**Serie 2: 103.9 (100)**

10.3* ↘	10.3* ↓	10.4* ↙	10.8* ↘	10.3* ↖
10.1 ↓	10.3* ↗	10.3* ↘	10.5* ↖	10.6* ↗

beste Teiler: 50.4 (14.), 79.4 (20.), 104.3 (19.)  
 Trefferlage: 0.04 mm rechts, 0.64 mm tief  
 Streuwert: 0.98, horizontal: 0.95, vertikal: 1.01

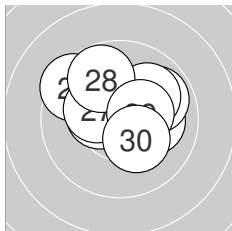

**Serie 3: 101.3 (97)**

10.6* ↗	9.5 ↖	10.1 →	9.9 ↗	10.0 ↗
10.4* ←	10.3* ↖	9.8 ↖	10.4* →	10.3* ↘

beste Teiler: 91.6 (21.), 134.5 (26.), 144.3 (29.)  
 Trefferlage: 0.22 mm rechts, 0.82 mm hoch  
 Streuwert: 1.56, horizontal: 1.87, vertikal: 1.15

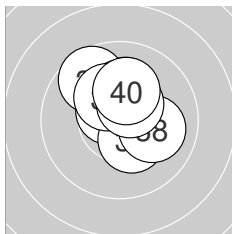

**Serie 4: 102.5 (99)**

10.2* ↗	10.6* ↖	9.7 ↖	10.2* ↗	10.4* ↘
10.4* ↘	10.3* ↖	10.1 →	10.4* ↗	10.2* ↗

beste Teiler: 91.3 (32.), 127.8 (39.), 147.0 (35.)  
 Trefferlage: 0.26 mm rechts, 0.91 mm hoch  
 Streuwert: 1.24, horizontal: 1.15, vertikal: 1.32

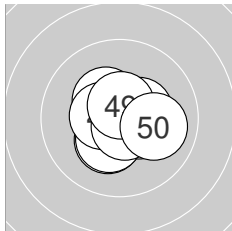

**Serie 5: 104.3 (100)**

10.4* ↘	10.3* ↙	10.7* ↗	10.4* →	10.4* ↖
10.3* ↙	10.5* ←	10.7* ↘	10.6* ↗	10.0 →

beste Teiler: 65.0 (43.), 66.0 (48.), 85.4 (49.)  
 Trefferlage: 0.22 mm rechts, 0.14 mm tief  
 Streuwert: 1.02, horizontal: 1.13, vertikal: 0.89

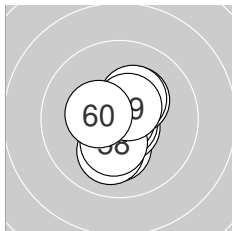

**Serie 6: 104.6 (100)**

10.2* ↓	10.7* ↘	10.8* ↘	10.3* ↗	10.3* ↗
10.9* →	10.1 ↓	10.3* ↓	10.6* ↗	10.4* ←

beste Teiler: 11.7 (56.), 41.7 (53.), 70.2 (52.)  
 Trefferlage: 0.08 mm rechts, 0.27 mm tief  
 Streuwert: 1.04, horizontal: 0.75, vertikal: 1.26

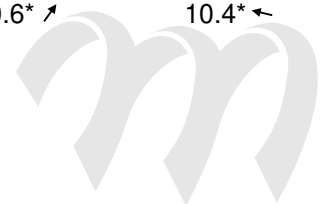

**ISSF AR Women Jun**  
StandNr: 127  
**Lienbacher, Victoria #72**

**Juniorinnen**  
Competition

**StartNr: 123**  
02.12.2023 16:49  
S – Russbach

---

QF

– Schütze hat sich fürs Finale qualifiziert



Ergebnis: **589.7** (564)  
 Serien: 98.6 96.8 95.1 98.4 101.2 99.6  
 Zähler: 27 30 3 0 0 0 0 0 0 0  
 Innenzehner: 20  
 Weitester: 705 (38.), 541 (25.), 526 (28.)  
 beste Teiler: 17.8 (43.), 62.3 (7.), 88.9 (6.)  
 Trefferlage: 0.07 mm rechts, 0.39 mm hoch  
 Streuwert: 2.22, horizontal: 2.48, vertikal: 1.93

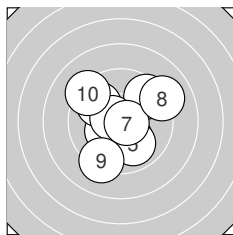
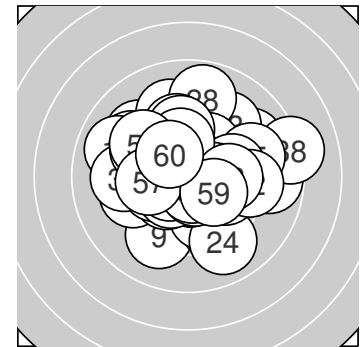

**Serie 1: 98.6 (94)**

10.2\* ↓ 10.3\* ↙ 9.9 ↘ 9.5 ↗ 9.9 ↓  
 10.6\* ↖ 10.7\* → 9.1 ↗ 9.2 ↓ 9.2 ↘  
 beste Teiler: 62.3 (7.), 88.9 (6.), 165.6 (2.)  
 Trefferlage: 0.00 mm, 0.06 mm hoch  
 Streuwert: 2.29, horizontal: 2.32, vertikal: 2.26

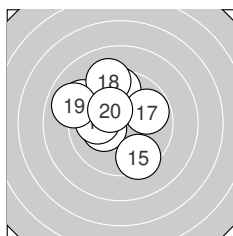

**Serie 2: 96.8 (94)**

9.6 ↑ 9.2 ↘ 10.0 ↖ 10.3\* ↖ 9.4 ↓  
 10.0 ← 9.8 ↗ 9.2 ↑ 9.0 ↖ 10.3\* ↘  
 beste Teiler: 170.2 (20.), 174.5 (14.), 231.6 (16.)  
 Trefferlage: 1.27 mm links, 1.10 mm hoch  
 Streuwert: 2.17, horizontal: 2.24, vertikal: 2.11

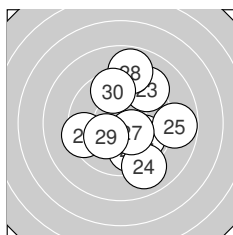

**Serie 3: 95.1 (90)**

9.8 ↓ 9.9 ↘ 9.2 ↗ 9.0 ↓ 8.8 →  
 9.4 ← 10.4\* ↘ 8.8 ↑ 10.2\* ↖ 9.6 ↑  
 beste Teiler: 141.9 (27.), 195.4 (29.), 265.5 (22.)  
 Trefferlage: 0.98 mm rechts, 0.02 mm tief  
 Streuwert: 2.76, horizontal: 2.50, vertikal: 2.99

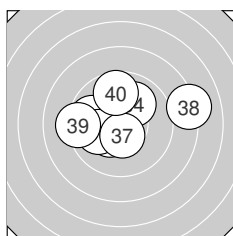

**Serie 4: 98.4 (95)**

10.4\* ↙ 10.2\* ↑ 10.5\* ↑ 10.0 ↗ 9.8 ←  
 10.0 ← 10.5\* ↓ 8.1 → 9.2 ← 9.7 ↑  
 beste Teiler: 111.0 (33.), 115.2 (37.), 149.9 (31.)  
 Trefferlage: 0.27 mm links, 0.72 mm hoch  
 Streuwert: 2.36, horizontal: 2.99, vertikal: 1.46

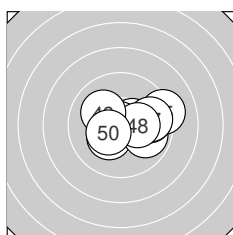

**Serie 5: 101.2 (96)**

10.5\* → 10.3\* ↙ 10.9\* ↘ 9.9 → 9.2 →  
 9.8 → 9.8 → 10.3\* → 10.1 ↖ 10.4\* ↙  
 beste Teiler: 17.8 (43.), 123.9 (41.), 141.8 (50.)  
 Trefferlage: 1.11 mm rechts, 0.11 mm hoch  
 Streuwert: 1.59, horizontal: 2.07, vertikal: 0.88

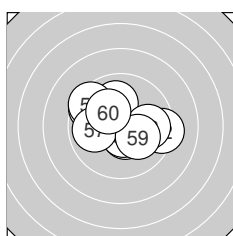

**Serie 6: 99.6 (95)**

10.0 ↑ 9.3 → 10.5\* ↓ 10.6\* ↓ 9.6 ↘  
 9.5 ↘ 9.9 ← 9.9 → 10.1 ↘ 10.2\* ↘  
 beste Teiler: 92.3 (54.), 117.7 (53.), 190.9 (60.)  
 Trefferlage: 0.09 mm links, 0.37 mm hoch  
 Streuwert: 1.99, horizontal: 2.44, vertikal: 1.38

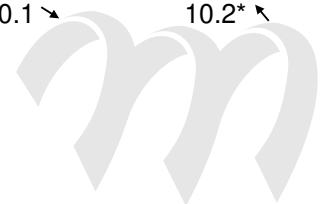

Ergebnis: **605.6** (579)  
 Serien: 103.4 100.8 101.2 99.3 99.1 101.8  
 Zähler: 40 19 1 0 0 0 0 0 0 0  
 Innenezehner: 28  
 Weitestе: 508 (27.), 495 (51.), 443 (40.)  
 beste Teiler: 16.6 (59.), 17.4 (33.), 40.4 (57.)  
 Trefferlage: 0.07 mm rechts, 0.28 mm hoch  
 Streuwert: 1.72, horizontal: 1.77, vertikal: 1.67

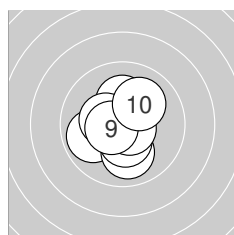
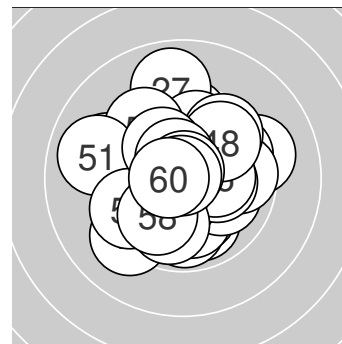

**Serie 1: 103.4 (99)**

9.9 ←	10.5* ↗	10.0 ↓	10.6* ↓	10.4* ↓
10.2* ↑	10.7* ↘	10.4* ←	10.6* ←	10.1 ↗

beste Teiler: 68.2 (7.), 92.1 (4.), 97.7 (9.)  
 Trefferlage: 0.12 mm links, 0.12 mm tief  
 Streuwert: 1.26, horizontal: 1.15, vertikal: 1.36

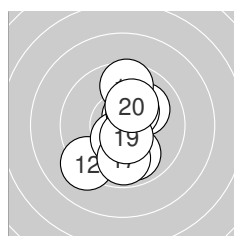

**Serie 2: 100.8 (96)**

10.1 ↗	9.2 ↘	10.6* ↗	9.9 ↓	10.5* ↓
9.6 ↑	9.8 ↓	10.4* ↗	10.5* ↓	10.2* ↗

beste Teiler: 89.8 (13.), 104.0 (19.), 121.0 (15.)  
 Trefferlage: 0.21 mm rechts, 0.22 mm tief  
 Streuwert: 1.78, horizontal: 1.26, vertikal: 2.18

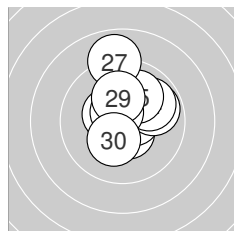

**Serie 3: 101.2 (96)**

10.5* ↓	10.6* →	9.8 →	9.9 ↗	10.0 ↗
10.4* ←	8.9 ↑	10.6* ↘	10.2* ↑	10.3* ↓

beste Teiler: 90.4 (28.), 93.5 (22.), 104.2 (21.)  
 Trefferlage: 0.39 mm rechts, 1.05 mm hoch  
 Streuwert: 1.58, horizontal: 1.31, vertikal: 1.82

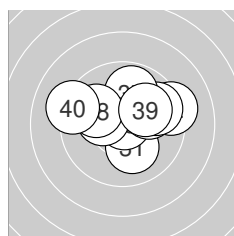

**Serie 4: 99.3 (96)**

10.1 ↓	9.2 →	10.9* ↗	10.3* ←	10.0 →
9.7 ↗	9.9 ↑	10.0 ↘	10.0 ↗	9.2 ←

beste Teiler: 17.4 (33.), 170.5 (34.), 207.4 (31.)  
 Trefferlage: 0.46 mm rechts, 0.85 mm hoch  
 Streuwert: 1.97, horizontal: 2.52, vertikal: 1.18

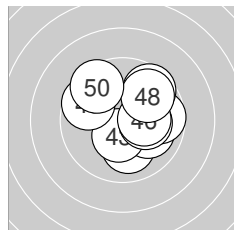

**Serie 5: 99.1 (95)**

10.0 ↓	10.0 ↘	10.4* ↓	9.7 →	10.2* →
10.2* →	9.6 ↗	9.8 ↗	9.7 ←	9.5 ↘

beste Teiler: 133.4 (43.), 182.1 (46.), 194.3 (45.)  
 Trefferlage: 0.83 mm rechts, 0.43 mm hoch  
 Streuwert: 1.87, horizontal: 2.02, vertikal: 1.71

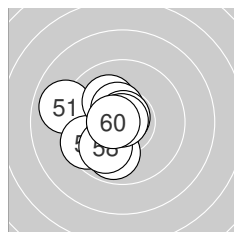

**Serie 6: 101.8 (97)**

9.0 ←	9.6 ↘	10.4* ↗	10.1 ↘	9.9 ↓
10.5* ↘	10.8* ↑	10.0 ↘	10.9* ↘	10.6* ←

beste Teiler: 16.6 (59.), 40.4 (57.), 79.0 (60.)  
 Trefferlage: 1.32 mm links, 0.28 mm tief  
 Streuwert: 1.49, horizontal: 1.49, vertikal: 1.50

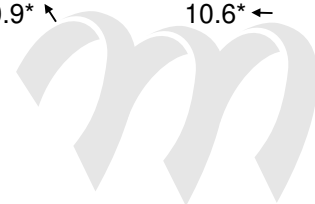



Ergebnis: **610.2** (580)  
 Serien: 101.0 105.1 102.9 101.7 98.6 100.9  
 Zähler: 41 18 1 0 0 0 0 0 0 0  
 Innenezehner: 30  
 Weitestе: 502 (2.), 420 (45.), 409 (60.)  
 beste Teiler: 18.6 (55.), 31.0 (29.), 31.0 (53.)  
 Trefferlage: 0.03 mm rechts, 0.08 mm hoch  
 Streuwert: 1.62, horizontal: 1.97, vertikal: 1.16

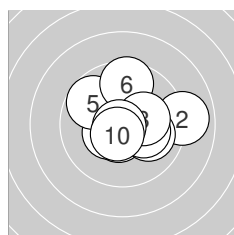
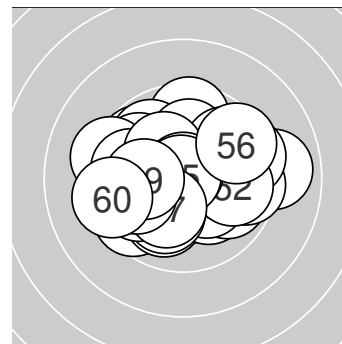

**Serie 1: 101.0 (96)**

10.6* ↓	8.9 →	10.0 →	10.4* ↙	9.7 ↘
9.6 ↑	10.2* →	10.2* →	10.8* ↙	10.6* ↓

beste Teiler: 35.2 (9.), 93.5 (10.), 100.5 (1.)  
 Trefferlage: 0.63 mm rechts, 0.20 mm hoch  
 Streuwert: 1.79, horizontal: 2.10, vertikal: 1.42

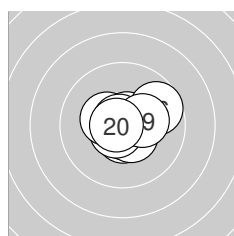

**Serie 2: 105.1 (99)**

10.7* ↗	10.6* ↓	10.7* ↓	10.5* ↘	10.7* ↙
9.7 →	10.4* ↖	10.8* ↘	10.3* →	10.7* ←

beste Teiler: 44.2 (18.), 52.0 (20.), 64.4 (13.)  
 Trefferlage: 0.30 mm rechts, 0.02 mm hoch  
 Streuwert: 1.00, horizontal: 1.19, vertikal: 0.75

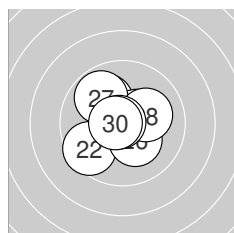

**Serie 3: 102.9 (98)**

10.8* ↓	9.6 ↙	10.0 ↘	10.4* →	10.4* →
10.3* ↘	9.8 ↘	10.1 →	10.8* ←	10.7* ←

beste Teiler: 31.0 (29.), 50.0 (21.), 60.0 (30.)  
 Trefferlage: 0.13 mm links, 0.18 mm hoch  
 Streuwert: 1.43, horizontal: 1.53, vertikal: 1.31

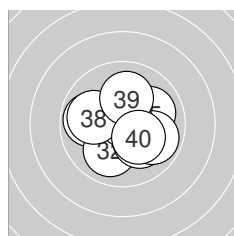

**Serie 4: 101.7 (98)**

9.8 ←	10.0 ↓	10.7* ↗	10.1 ↘	10.0 →
9.9 →	10.8* ↗	10.0 ←	10.1 ↑	10.3* ↘

beste Teiler: 36.8 (37.), 56.4 (33.), 172.5 (40.)  
 Trefferlage: 0.21 mm rechts, 0.11 mm tief  
 Streuwert: 1.57, horizontal: 1.80, vertikal: 1.31

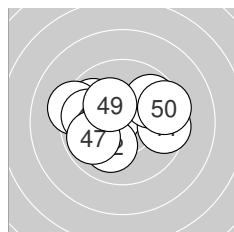

**Serie 5: 98.6 (93)**

10.6* ↘	10.1 ↓	9.8 ↘	9.6 →	9.3 ←
9.8 ←	9.9 ↙	9.8 ↗	10.2* ↘	9.5 →

beste Teiler: 78.2 (41.), 180.4 (49.), 220.0 (42.)  
 Trefferlage: 0.52 mm links, 0.43 mm hoch  
 Streuwert: 2.11, horizontal: 2.71, vertikal: 1.25

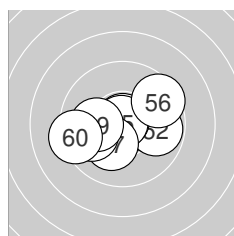

**Serie 6: 100.9 (96)**

10.0 →	9.8 →	10.8* ↑	10.4* ↙	10.9* ↘
9.5 ↗	10.2* ↓	9.9 ←	10.1 ←	9.3 ←

beste Teiler: 18.6 (55.), 31.0 (53.), 128.3 (54.)  
 Trefferlage: 0.27 mm links, 0.23 mm tief  
 Streuwert: 1.82, horizontal: 2.38, vertikal: 0.97



Ergebnis: **619.9** (594)  
 Serien: 103.4 102.9 102.2 103.5 103.3 104.6  
 Zähler: 54 6 0 0 0 0 0 0 0 0  
 Innenezehner: 40  
 Weitest: 347 (48.), 330 (46.), 280 (11.)  
 beste Teiler: 23.7 (42.), 39.0 (31.), 41.4 (45.)  
 Trefferlage: 0.11 mm rechts, 0.28 mm hoch  
 Streuwert: 1.23, horizontal: 1.33, vertikal: 1.12

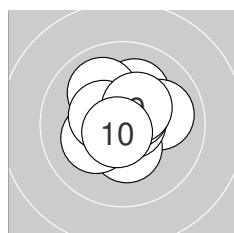
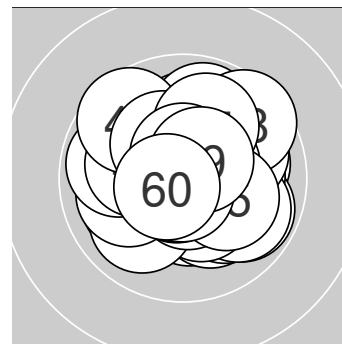

**Serie 1: 103.4 (100)**

10.1 ↗	10.0 →	10.4* ↓	10.7* →	10.0 ↘
10.2* ↖	10.5* ↗	10.4* ↖	10.4* ↗	10.7* ↘

beste Teiler: 51.3 (4.), 61.8 (10.), 102.5 (7.)  
 Trefferlage: 0.09 mm rechts, 0.40 mm hoch  
 Streuwert: 1.18, horizontal: 1.22, vertikal: 1.13

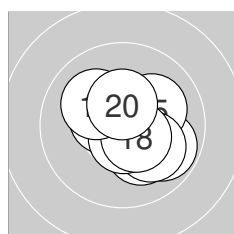

**Serie 2: 102.9 (99)**

9.8 ↘	10.2* ↘	10.5* ↖	10.6* ↗	10.1 ↗
10.1 ↘	10.6* ↓	10.5* ↘	10.1 ↖	10.4* ↑

beste Teiler: 83.2 (17.), 86.9 (14.), 113.4 (18.)  
 Trefferlage: 0.51 mm rechts, 0.08 mm tief  
 Streuwert: 1.27, horizontal: 1.35, vertikal: 1.18

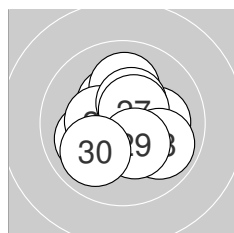

**Serie 3: 102.2 (99)**

10.4* ↘	10.1 ↑	10.0 ↖	10.4* ←	10.1 →
10.4* ↗	10.5* ↗	9.9 ↘	10.4* ↘	10.0 ↘

beste Teiler: 109.2 (27.), 140.2 (26.), 144.4 (21.)  
 Trefferlage: 0.06 mm rechts, 0.04 mm hoch  
 Streuwert: 1.45, horizontal: 1.53, vertikal: 1.36

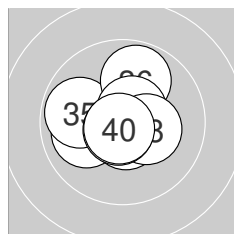

**Serie 4: 103.5 (98)**

10.8* ↓	10.1 ←	10.0 ←	10.6* ↓	9.8 ←
9.8 ↗	10.6* ↗	10.3* →	10.7* ↘	10.8* ↘

beste Teiler: 39.0 (31.), 46.5 (40.), 55.9 (39.)  
 Trefferlage: 0.44 mm links, 0.08 mm hoch  
 Streuwert: 1.25, horizontal: 1.43, vertikal: 1.03

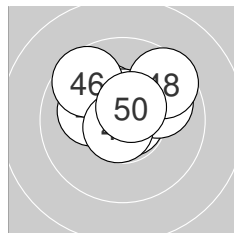

**Serie 5: 103.3 (98)**

10.3* ↘	10.9* →	10.2* ↖	10.6* ↑	10.8* →
9.6 ↖	10.0 →	9.6 ↗	10.7* ↘	10.6* ↗

beste Teiler: 23.7 (42.), 41.4 (45.), 53.8 (49.)  
 Trefferlage: 0.05 mm rechts, 0.91 mm hoch  
 Streuwert: 1.29, horizontal: 1.56, vertikal: 0.96

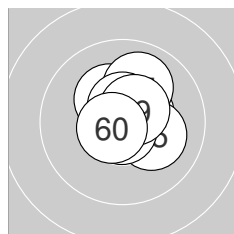

**Serie 6: 104.6 (100)**

10.5* ↗	10.7* ←	10.3* ↘	10.4* →	10.2* ↘
10.8* ↓	10.0 ↗	10.6* ↑	10.5* ↗	10.6* ↘

beste Teiler: 45.2 (56.), 60.0 (52.), 77.4 (60.)  
 Trefferlage: 0.38 mm rechts, 0.36 mm hoch  
 Streuwert: 0.96, horizontal: 0.94, vertikal: 0.98



**ISSF AR Women Jun**

StandNr: 131

**Sidenko, Inna #177**

**Juniorinnen**

Competition

**StartNr: 127**

02.12.2023 16:52

Steiermark

---

QF

– Schütze hat sich fürs Finale qualifiziert



Ergebnis: **612.7** (587)  
 Serien: 103.3 103.3 102.5 100.3 101.2 102.1  
 Zähler: 48 11 1 0 0 0 0 0 0 0  
 Innenezehner: 32  
 Weitester: 540 (42.), 371 (54.), 348 (33.)  
 beste Teiler: 43.1 (9.), 52.7 (26.), 55.3 (7.)  
 Trefferlage: 0.11 mm links, 0.25 mm hoch  
 Streuwert: 1.47, horizontal: 1.75, vertikal: 1.12

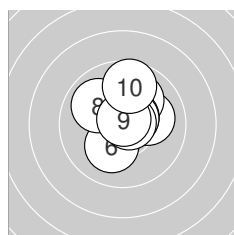
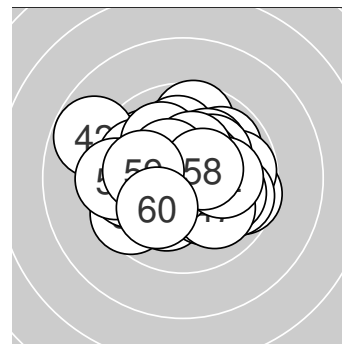

**Serie 1: 103.3 (98)**

10.1 →	10.0 ↗	10.6* ↗	10.6* ↗	10.7* ↖
10.2* ↓	10.7* →	9.9 ↘	10.8* ↑	9.7 ↑

beste Teiler: 43.1 (9.), 55.3 (7.), 73.7 (5.)  
 Trefferlage: 0.24 mm rechts, 0.73 mm hoch  
 Streuwert: 1.24, horizontal: 1.17, vertikal: 1.30

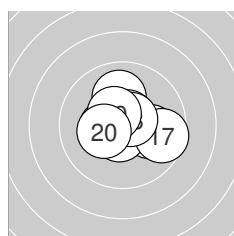

**Serie 2: 103.3 (99)**

10.0 ↑	10.6* ↗	10.4* ←	10.0 →	10.7* ↗
10.6* ↓	9.6 →	10.6* ↗	10.5* ↘	10.3* ←

beste Teiler: 55.6 (15.), 79.2 (12.), 81.6 (18.)  
 Trefferlage: 0.28 mm rechts, 0.19 mm hoch  
 Streuwert: 1.27, horizontal: 1.51, vertikal: 0.98

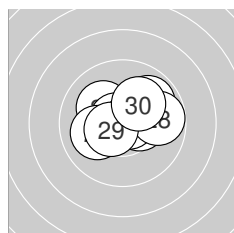

**Serie 3: 102.5 (98)**

10.1 ↘	9.9 ↗	10.4* →	10.2* ↗	10.7* ↖
10.7* →	10.1 ←	9.8 →	10.5* ←	10.1 ↗

beste Teiler: 52.7 (26.), 58.5 (25.), 107.8 (29.)  
 Trefferlage: 0.43 mm rechts, 0.53 mm hoch  
 Streuwert: 1.33, horizontal: 1.66, vertikal: 0.89

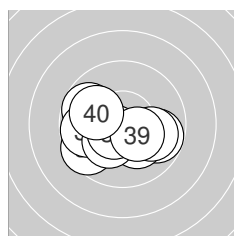

**Serie 4: 100.3 (96)**

9.8 →	9.7 ↖	9.6 ↘	9.8 ←	10.2* ↘
10.0 →	10.2* ↗	10.6* ↘	10.4* ↘	10.0 ↖

beste Teiler: 96.9 (38.), 146.7 (39.), 179.2 (37.)  
 Trefferlage: 0.50 mm links, 0.64 mm tief  
 Streuwert: 1.73, horizontal: 2.23, vertikal: 1.00

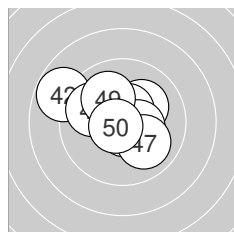

**Serie 5: 101.2 (97)**

10.7* ↓	8.8 ↖	10.1 ↘	10.1 ↗	10.5* ↑
10.4* →	10.0 ↘	9.9 ↖	10.0 ↘	10.7* ↗

beste Teiler: 65.5 (41.), 65.8 (50.), 103.2 (45.)  
 Trefferlage: 0.55 mm links, 0.59 mm hoch  
 Streuwert: 1.72, horizontal: 2.07, vertikal: 1.27

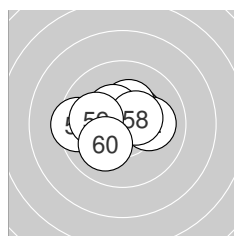

**Serie 6: 102.1 (99)**

10.4* ↗	10.1 →	10.3* ↘	9.5 ←	10.3* ↑
10.4* ←	10.4* ↘	10.5* ↗	10.1 ←	10.1 ↗

beste Teiler: 119.9 (58.), 129.2 (57.), 131.8 (51.)  
 Trefferlage: 0.59 mm links, 0.13 mm hoch  
 Streuwert: 1.42, horizontal: 1.78, vertikal: 0.92



Ergebnis: **596.6** (572)  
 Serien: 98.9 98.3 99.9 101.9 99.7 97.9  
 Zähler: 36 21 2 1 0 0 0 0 0 0  
 Innenezehner: 29  
 Weitestе: 838 (3.), 546 (12.), 542 (23.)  
 beste Teiler: 41.7 (37.), 49.4 (6.), 71.3 (30.)  
 Trefferlage: 0.33 mm rechts, 0.38 mm hoch  
 Streuwert: 2.04, horizontal: 2.29, vertikal: 1.75

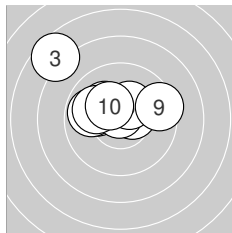
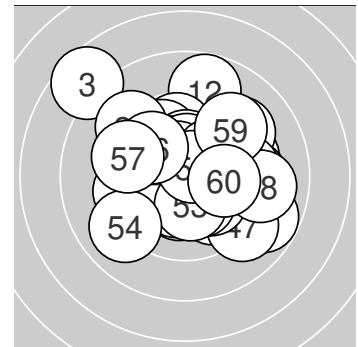

**Serie 1: 98.9 (95)**

10.5* →	10.0 ←	7.6 ↘	9.8 ←	10.2* ↘
10.8* ↑	10.0 ←	10.3* ↗	9.4 →	10.3* ↘

beste Teiler: 49.4 (6.), 116.3 (1.), 153.7 (8.)  
 Trefferlage: 1.03 mm links, 1.38 mm hoch  
 Streuwert: 2.16, horizontal: 2.62, vertikal: 1.58

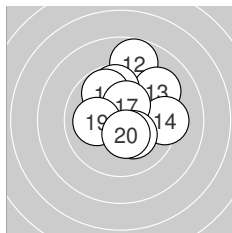

**Serie 2: 98.3 (94)**

10.4* ↗	8.8 ↑	9.2 ↗	9.3 →	9.8 ↑
9.8 ↘	10.3* ↗	10.2* ↘	10.1 ←	10.4* ↓

beste Teiler: 139.2 (20.), 140.3 (11.), 151.5 (17.)  
 Trefferlage: 0.77 mm rechts, 1.31 mm hoch  
 Streuwert: 2.02, horizontal: 1.93, vertikal: 2.11

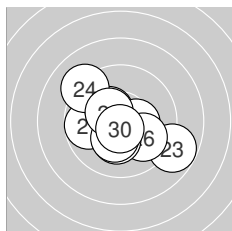

**Serie 3: 99.9 (95)**

9.7 ←	10.4* ↘	8.8 ↘	9.1 ↘	10.4* →
9.9 ↘	10.2* ↓	10.3* ↓	10.4* ↘	10.7* ↓

beste Teiler: 71.3 (30.), 134.6 (29.), 144.3 (22.)  
 Trefferlage: 0.10 mm links, 0.37 mm tief  
 Streuwert: 2.06, horizontal: 2.41, vertikal: 1.65

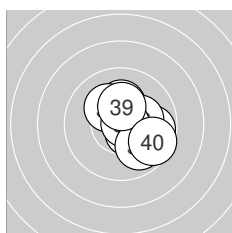

**Serie 4: 101.9 (97)**

10.2* ↑	9.8 →	10.4* ↗	10.5* ↘	10.2* ↘
10.2* →	10.8* →	9.9 ↘	10.3* ↑	9.6 ↘

beste Teiler: 41.7 (37.), 110.3 (34.), 127.0 (33.)  
 Trefferlage: 1.01 mm rechts, 0.18 mm hoch  
 Streuwert: 1.34, horizontal: 1.31, vertikal: 1.38

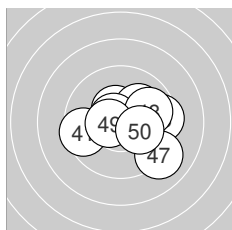

**Serie 5: 99.7 (96)**

9.5 ←	10.4* ↘	10.0 →	10.1 ↗	10.6* ↘
9.5 →	9.1 ↘	9.8 →	10.5* ←	10.2* ↘

beste Teiler: 78.4 (45.), 106.5 (49.), 126.4 (42.)  
 Trefferlage: 0.96 mm rechts, 0.04 mm hoch  
 Streuwert: 1.88, horizontal: 2.30, vertikal: 1.34

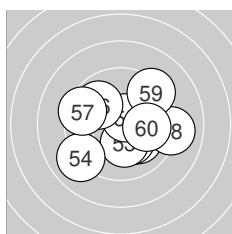

**Serie 6: 97.9 (95)**

10.1 ↘	10.2* ↘	10.2* ↓	9.0 ↗	10.7* ↗
9.9 ↘	9.4 ←	9.1 →	9.3 ↗	10.0 →

beste Teiler: 75.2 (55.), 180.4 (53.), 181.4 (52.)  
 Trefferlage: 0.40 mm rechts, 0.23 mm tief  
 Streuwert: 2.36, horizontal: 2.77, vertikal: 1.85



Ergebnis: **618.7** (589)  
 Serien: 104.5 101.5 104.5 103.8 102.3 102.1  
 Zähler: 49 11 0 0 0 0 0 0 0 0  
 Innenezehner: 42  
 Weitestе: 428 (12.), 411 (55.), 314 (40.)  
 beste Teiler: 26.0 (16.), 44.1 (52.), 46.0 (37.)  
 Trefferlage: 0.15 mm links, 0.05 mm hoch  
 Streuwert: 1.30, horizontal: 1.45, vertikal: 1.14

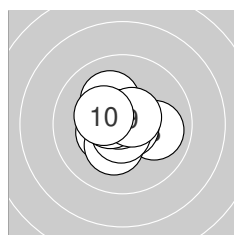
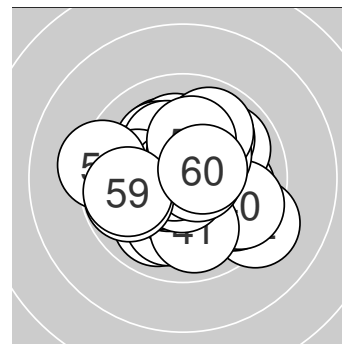

**Serie 1: 104.5 (100)**

10.1 ↖	10.4* ↙	10.0 →	10.3* ↘	10.7* ↗
10.7* ↓	10.8* ↘	10.6* ↖	10.6* ↗	10.3* ↖

beste Teiler: 47.6 (7.), 54.1 (5.), 68.8 (6.)  
 Trefferlage: 0.20 mm links, 0.02 mm hoch  
 Streuwert: 1.05, horizontal: 1.15, vertikal: 0.93

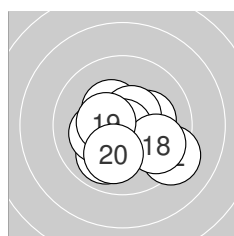

**Serie 2: 101.5 (97)**

10.4* ↖	9.2 ↘	10.2* →	10.6* ↗	9.9 ↘
10.8* ↓	10.2* ↙	9.8 ↘	10.4* ↖	10.0 ↓

beste Teiler: 26.0 (16.), 99.8 (14.), 126.7 (19.)  
 Trefferlage: 0.27 mm rechts, 0.63 mm tief  
 Streuwert: 1.59, horizontal: 1.83, vertikal: 1.30

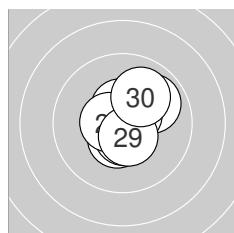

**Serie 3: 104.5 (99)**

10.5* ↘	10.6* ↓	10.6* ↗	9.9 ↗	10.7* ↖
10.6* ↗	10.5* ↑	10.6* ←	10.5* ↓	10.0 ↗

beste Teiler: 67.0 (25.), 93.6 (23.), 95.6 (22.)  
 Trefferlage: 0.32 mm rechts, 0.32 mm hoch  
 Streuwert: 1.02, horizontal: 0.95, vertikal: 1.08

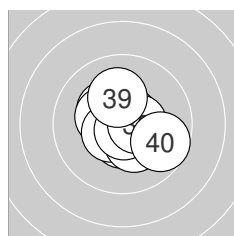

**Serie 4: 103.8 (99)**

10.5* ↓	10.3* ↖	10.4* ↖	10.5* ↙	10.3* ↘
10.7* ↗	10.8* ↓	10.5* →	10.1 ↑	9.7 ↘

beste Teiler: 46.0 (37.), 70.0 (36.), 106.0 (34.)  
 Trefferlage: 0.15 mm rechts, 0.07 mm tief  
 Streuwert: 1.19, horizontal: 1.26, vertikal: 1.11

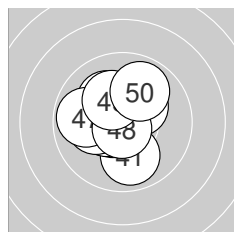

**Serie 5: 102.3 (97)**

9.9 ↓	10.6* ↙	10.5* ←	10.3* ↗	10.1 ↖
10.2* ←	9.8 ←	10.8* ↓	10.2* ↖	9.9 ↗

beste Teiler: 49.2 (48.), 84.7 (42.), 125.9 (43.)  
 Trefferlage: 0.56 mm links, 0.31 mm hoch  
 Streuwert: 1.38, horizontal: 1.33, vertikal: 1.42

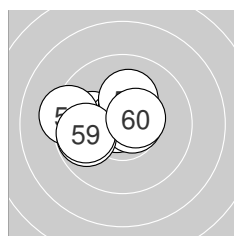

**Serie 6: 102.1 (97)**

10.0 ←	10.8* ↖	10.7* →	10.5* ↗	9.3 ←
9.8 ←	10.5* ↑	10.2* ↑	9.8 ←	10.5* ↗

beste Teiler: 44.1 (52.), 73.2 (53.), 108.7 (60.)  
 Trefferlage: 0.91 mm links, 0.38 mm hoch  
 Streuwert: 1.44, horizontal: 1.85, vertikal: 0.85

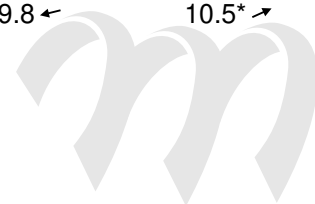

Ergebnis: **619.0** (591)  
 Serien: 103.0 103.0 103.6 103.1<sup>OF</sup> 102.9 103.4  
 Zähler: 51 9 0 0 0 0 0 0 0 0  
 Innenzehner: 42  
 Weitest: 424 (56.), 400 (37.), 336 (40.)  
 beste Teiler: 15.2 (55.), 56.2 (58.), 59.6 (9.)  
 Trefferlage: 0.11 mm rechts, 0.02 mm hoch  
 Streuwert: 1.29, horizontal: 1.11, vertikal: 1.44

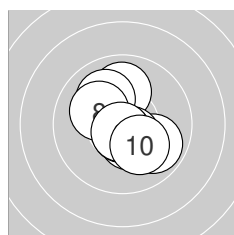
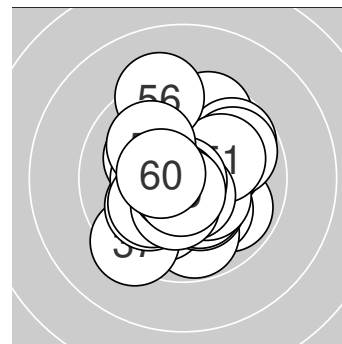

**Serie 1: 103.0 (99)**

10.6* ↖	10.4* ↓	10.0 ↑	9.9 ↘	10.0 ↖
10.5* ↓	10.7* ↓	10.1 ↖	10.7* ↓	10.1 ↖

beste Teiler: 59.6 (9.), 65.4 (7.), 77.9 (1.)  
 Trefferlage: 0.08 mm rechts, 0.04 mm tief  
 Streuwert: 1.31, horizontal: 1.18, vertikal: 1.44

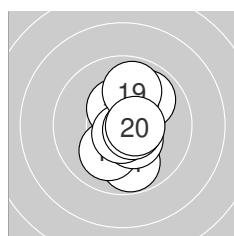

**Serie 2: 103.0 (97)**

9.8 ↓	10.4* ↖	9.9 ↗	10.6* ↓	10.1 ↙
10.4* ↓	10.7* ↓	10.6* ↘	9.9 ↑	10.6* →

beste Teiler: 64.6 (17.), 80.9 (18.), 89.0 (14.)  
 Trefferlage: 0.44 mm rechts, 0.17 mm tief  
 Streuwert: 1.31, horizontal: 0.79, vertikal: 1.68

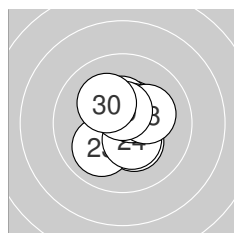

**Serie 3: 103.6 (100)**

10.5* ↑	10.3* ↓	10.0 ↙	10.4* ↓	10.5* ↗
10.4* ↑	10.5* ↗	10.2* →	10.6* ↑	10.2* ↖

beste Teiler: 94.0 (29.), 102.7 (27.), 113.6 (21.)  
 Trefferlage: 0.19 mm rechts, 0.29 mm hoch  
 Streuwert: 1.13, horizontal: 0.99, vertikal: 1.25

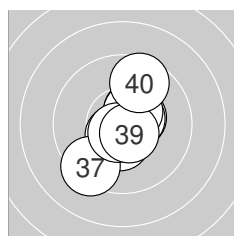

**Serie 4: 103.1 (98)**

10.4* ↗	10.5* ↗	10.5* →	10.5* ↙	10.5* ↗
10.4* ↓	9.4 ↙	10.7* ↙	10.6* ↓	9.6 ↑

beste Teiler: 74.4 (38.), 84.4 (39.), 102.6 (34.)  
 Trefferlage: 0.18 mm rechts, 0.06 mm tief  
 Streuwert: 1.43, horizontal: 1.12, vertikal: 1.68

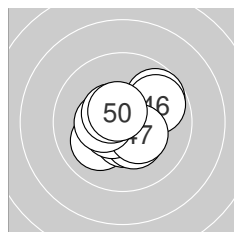

**Serie 5: 102.9 (98)**

10.1 ↙	10.5* ↓	10.3* ↓	10.6* ↙	9.7 ↗
9.8 ↗	10.4* ↘	10.4* ←	10.5* ↖	10.6* ↖

beste Teiler: 89.8 (50.), 94.0 (44.), 109.2 (49.)  
 Trefferlage: 0.19 mm rechts, 0.07 mm tief  
 Streuwert: 1.35, horizontal: 1.51, vertikal: 1.16

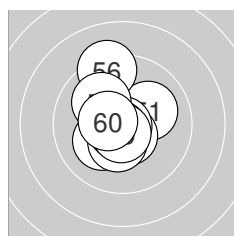

**Serie 6: 103.4 (99)**

10.1 ↗	10.6* ↓	10.2* ↙	10.4* ↓	10.9* ↓
9.3 ↖	10.0 ↖	10.7* ↙	10.7* ↓	10.5* ←

beste Teiler: 15.2 (55.), 56.2 (58.), 68.7 (59.)  
 Trefferlage: 0.39 mm links, 0.21 mm hoch  
 Streuwert: 1.39, horizontal: 1.06, vertikal: 1.66



**ISSF AR Women Jun**

StandNr: 135

**Grosch, Mia** #58

**Juniorinnen**

Competition

**StartNr: 131**

02.12.2023 16:30

AUT

---

QF

– Schütze hat sich fürs Finale qualifiziert





Ergebnis: **598.2** (569)  
 Serien: 99.4 99.5 101.0 100.3 98.3 99.7  
 Zähler: 31 27 2 0 0 0 0 0 0 0  
 Innenzehner: 22  
 Weitester: 537 (28.), 530 (43.), 437 (41.)  
 beste Teiler: 22.2 (45.), 38.2 (24.), 43.2 (29.)  
 Trefferlage: 0.25 mm rechts, 0.33 mm hoch  
 Streuwert: 1.92, horizontal: 2.04, vertikal: 1.80

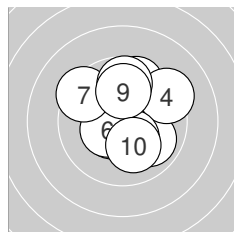
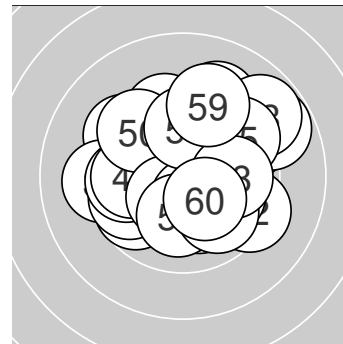

**Serie 1: 99.4 (95)**

10.5* ↙	9.9 ↘	9.7 ↑	9.3 ↗	10.4* ↘
10.4* ↙	9.4 ↘	9.7 ↑	10.0 ↑	10.1 ↘

beste Teiler: 121.0 (1.), 139.1 (6.), 149.9 (5.)  
 Trefferlage: 0.33 mm rechts, 0.66 mm hoch  
 Streuwert: 1.95, horizontal: 1.86, vertikal: 2.05

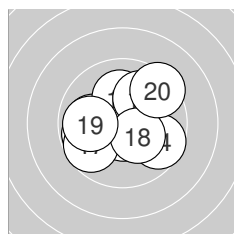

**Serie 2: 99.5 (95)**

10.6* ↓	10.0 ←	10.1 ↑	9.7 ↘	9.8 ←
10.0 ↗	9.7 ↙	10.3* ↘	9.9 ←	9.4 ↗

beste Teiler: 84.1 (11.), 158.3 (18.), 209.3 (13.)  
 Trefferlage: 0.21 mm links, 0.09 mm hoch  
 Streuwert: 1.97, horizontal: 2.27, vertikal: 1.61

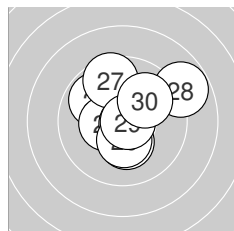

**Serie 3: 101.0 (96)**

10.1 ↑	9.9 ↘	10.4* ←	10.8* ↘	10.3* ↓
10.3* ↓	9.6 ↑	8.8 ↗	10.8* →	10.0 ↗

beste Teiler: 38.2 (24.), 43.2 (29.), 133.2 (23.)  
 Trefferlage: 0.28 mm rechts, 0.77 mm hoch  
 Streuwert: 1.82, horizontal: 1.91, vertikal: 1.73

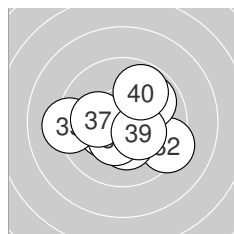

**Serie 4: 100.3 (96)**

10.3* ↙	9.3 ↘	10.3* ↓	10.6* ↓	9.2 ←
10.4* ↙	10.2* ←	9.9 ↗	10.3* ↘	9.8 ↗

beste Teiler: 96.3 (34.), 141.3 (36.), 153.9 (31.)  
 Trefferlage: 0.03 mm rechts, 0.31 mm tief  
 Streuwert: 1.88, horizontal: 2.27, vertikal: 1.39

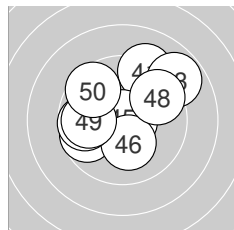

**Serie 5: 98.3 (92)**

9.2 ↑	10.7* →	8.8 ↗	9.7 ←	10.9* ↑
10.2* ↓	9.7 ←	9.6 ↗	9.9 ←	9.6 ↘

beste Teiler: 22.2 (45.), 59.8 (42.), 189.1 (46.)  
 Trefferlage: 0.12 mm links, 0.83 mm hoch  
 Streuwert: 2.29, horizontal: 2.59, vertikal: 1.93

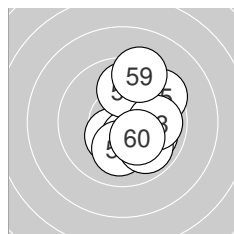

**Serie 6: 99.7 (95)**

10.4* ↙	10.0 ↘	10.4* ↓	10.1 ↓	9.5 ↗
9.9 ↑	9.9 ↘	9.9 →	9.3 ↑	10.3* ↘

beste Teiler: 134.2 (53.), 140.0 (51.), 171.8 (60.)  
 Trefferlage: 1.18 mm rechts, 0.02 mm tief  
 Streuwert: 1.74, horizontal: 1.28, vertikal: 2.10



Ergebnis: **619.7** (592)  
 Serien: 103.4 101.6 103.5 103.0<sup>OF</sup> 104.6 103.6  
 Zähler: 52 8 0 0 0 0 0 0 0 0  
 Innenezehner: 42  
 Weitestе: 400 (20.), 312 (50.), 305 (56.)  
 beste Teiler: 9.4 (53.), 12.2 (49.), 19.2 (57.)  
 Trefferlage: 0.51 mm rechts, 0.10 mm hoch  
 Streuwert: 1.20, horizontal: 1.25, vertikal: 1.14

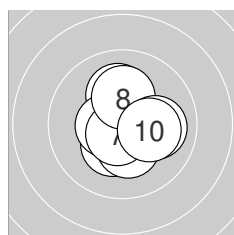
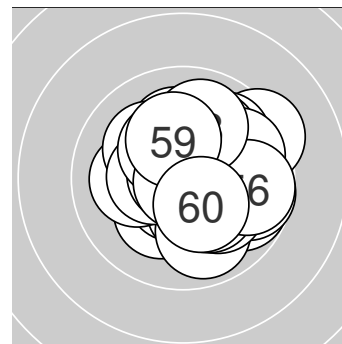

**Serie 1: 103.4 (100)**

10.5\* ↑      10.3\* ↙      10.3\* ↓      10.7\* ←      10.1 ↑  
 10.5\* ←      10.6\* ↙      10.2\* ↑      10.0 →      10.2\* →

beste Teiler: 61.0 (4.), 76.0 (7.), 110.4 (6.)  
 Trefferlage: 0.11 mm rechts, 0.06 mm hoch  
 Streuwert: 1.19, horizontal: 1.12, vertikal: 1.25

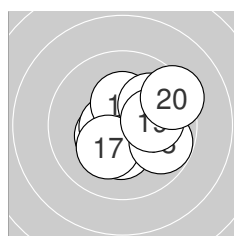

**Serie 2: 101.6 (98)**

10.4\* ↙      10.5\* ↑      10.6\* ←      10.3\* ↑      10.3\* ↓  
 10.0 ↗      10.2\* ↙      9.8 ↘      10.1 →      9.4 ↗

beste Teiler: 83.8 (13.), 105.0 (12.), 136.7 (11.)  
 Trefferlage: 0.70 mm rechts, 0.11 mm hoch  
 Streuwert: 1.52, horizontal: 1.69, vertikal: 1.34

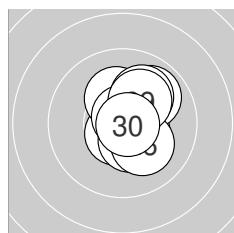

**Serie 3: 103.5 (99)**

10.6\* ↙      10.5\* ↘      10.4\* ↓      10.2\* ↑      9.9 ↗  
 10.1 ↘      10.8\* ↑      10.0 ↗      10.2\* ↗      10.8\* →

beste Teiler: 37.3 (30.), 46.2 (27.), 84.7 (21.)  
 Trefferlage: 0.70 mm rechts, 0.33 mm hoch  
 Streuwert: 1.10, horizontal: 0.81, vertikal: 1.32

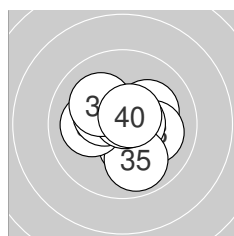

**Serie 4: 103.0 (99)**

10.3\* ↓      10.2\* ↗      10.1 →      10.6\* →      9.9 ↓  
 10.1 ←      10.4\* ↖      10.7\* ↑      10.1 ↖      10.6\* ↗

beste Teiler: 54.1 (38.), 77.1 (34.), 77.9 (40.)  
 Trefferlage: 0.17 mm rechts, 0.04 mm tief  
 Streuwert: 1.29, horizontal: 1.40, vertikal: 1.17

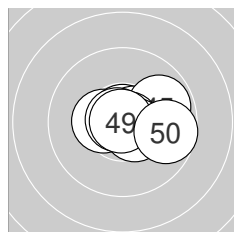

**Serie 5: 104.6 (98)**

10.4\* ←      10.8\* ↑      10.6\* →      10.3\* →      9.8 →  
 10.8\* →      10.5\* ↘      10.8\* ↖      10.9\* ↖      9.7 →

beste Teiler: 12.2 (49.), 39.2 (46.), 41.0 (42.)  
 Trefferlage: 0.74 mm rechts, 0.07 mm hoch  
 Streuwert: 1.02, horizontal: 1.36, vertikal: 0.49

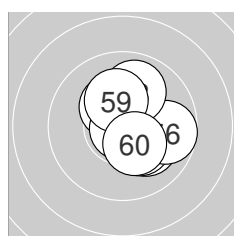

**Serie 6: 103.6 (98)**

10.1 ↘      10.3\* ↖      10.9\* ↓      10.9\* ↘      10.3\* ↘  
 9.7 →      10.9\* ↙      9.9 ↑      10.2\* ↑      10.4\* ↘

beste Teiler: 9.4 (53.), 19.2 (57.), 21.0 (54.)  
 Trefferlage: 0.63 mm rechts, 0.09 mm hoch  
 Streuwert: 1.23, horizontal: 1.13, vertikal: 1.32



**ISSF AR Women Jun**

StandNr: 137

**Alberts, Paula #61**

**Juniorinnen**

Competition

**StartNr: 133**

02.12.2023 16:32

**AUT**

---

QF

- Schütze hat sich fürs Finale qualifiziert



Ergebnis: **603.2** (576)  
 Serien: 99.1 100.2 101.8 101.6 100.2 100.3  
 Zähler: 36 24 0 0 0 0 0 0 0 0  
 Innenzehner: 22  
 Weitestе: 433 (17.), 400 (12.), 398 (13.)  
 beste Teiler: 10.2 (23.), 22.8 (33.), 40.1 (11.)  
 Trefferlage: 0.51 mm rechts, 0.27 mm hoch  
 Streuwert: 1.73, horizontal: 1.92, vertikal: 1.52

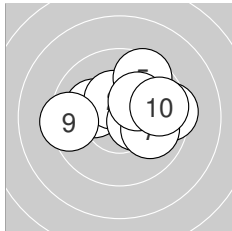
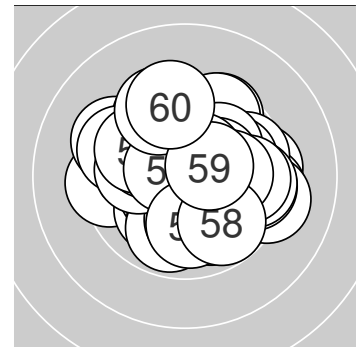

**Serie 1: 99.1 (95)**

10.1 ↖	10.4* ↖	9.4 →	9.9 ↗	9.6 ↗
10.4* →	10.0 ↘	10.2* ↗	9.4 ←	9.7 →

beste Teiler: 129.7 (6.), 141.3 (2.), 182.7 (8.)  
 Trefferlage: 0.94 mm rechts, 0.71 mm hoch  
 Streuwert: 1.85, horizontal: 2.37, vertikal: 1.11

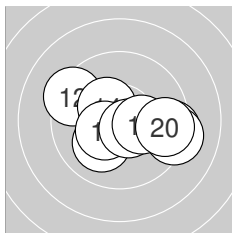

**Serie 2: 100.2 (96)**

10.8* ↓	9.4 ↖	9.4 →	10.4* ↖	10.1 ↗
10.4* ↗	9.2 ↘	10.6* ↘	10.3* →	9.6 →

beste Teiler: 40.1 (11.), 91.9 (18.), 137.8 (16.)  
 Trefferlage: 0.70 mm rechts, 0.34 mm tief  
 Streuwert: 1.97, horizontal: 2.58, vertikal: 1.03

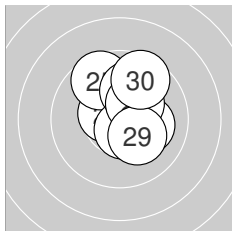

**Serie 3: 101.8 (98)**

10.0 ↖	10.1 →	10.9* ↗	10.5* ↖	9.6 ↖
10.6* ↓	10.0 ↗	10.3* ↗	10.2* ↘	9.6 ↗

beste Teiler: 10.2 (23.), 86.3 (26.), 105.1 (24.)  
 Trefferlage: 0.38 mm rechts, 0.96 mm hoch  
 Streuwert: 1.39, horizontal: 1.18, vertikal: 1.58

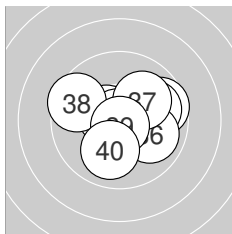

**Serie 4: 101.6 (96)**

10.4* ↗	10.5* ↖	10.9* ↖	9.7 →	9.9 →
9.9 ↘	10.0 ↗	9.5 ↖	10.8* ↓	10.0 ↓

beste Teiler: 22.8 (33.), 43.1 (39.), 109.7 (32.)  
 Trefferlage: 0.55 mm rechts, 0.22 mm hoch  
 Streuwert: 1.61, horizontal: 1.95, vertikal: 1.18

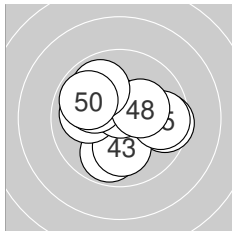

**Serie 5: 100.2 (95)**

9.9 ↓	9.6 →	10.1 ↓	10.0 ←	9.7 →
10.7* ↑	10.1 ↖	10.3* ↗	9.9 ↖	9.9 ↖

beste Teiler: 72.4 (46.), 174.4 (48.), 219.5 (47.)  
 Trefferlage: 0.04 mm links, 0.11 mm hoch  
 Streuwert: 1.87, horizontal: 2.16, vertikal: 1.53

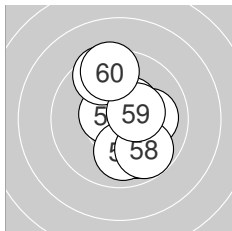

**Serie 6: 100.3 (96)**

9.9 ↓	10.5* ↗	10.1 →	10.0 ↓	10.6* ↖
9.5 ↖	10.0 ↓	9.8 ↘	10.4* →	9.5 ↑

beste Teiler: 95.4 (55.), 123.6 (52.), 134.4 (59.)  
 Trefferlage: 0.52 mm rechts, 0.03 mm tief  
 Streuwert: 1.84, horizontal: 1.21, vertikal: 2.30



Ergebnis: **595.8** (569)  
 Serien: 97.7 102.8 97.0 100.6 97.1 100.6  
 Zähler: 32 25 3 0 0 0 0 0 0 0  
 Innenzehner: 21  
 Weitester: 546 (46.), 521 (23.), 518 (48.)  
 beste Teiler: 71.4 (18.), 71.5 (56.), 73.4 (39.)  
 Trefferlage: 1.03 mm rechts, 0.06 mm hoch  
 Streuwert: 1.90, horizontal: 1.77, vertikal: 2.03

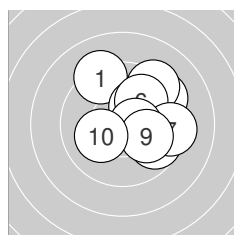
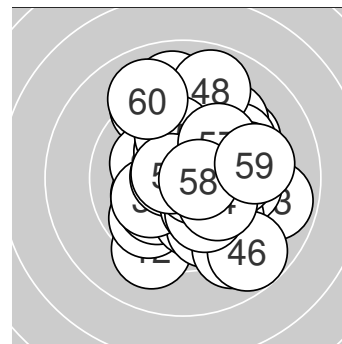

**Serie 1: 97.7 (94)**

9.2 ↘	10.2* ↗	9.7 ↘	9.4 ↗	9.3 ↗
9.9 ↗	9.3 →	10.5* →	10.1 ↘	10.1 ↖

beste Teiler: 108.1 (8.), 183.2 (2.), 205.3 (10.)  
 Trefferlage: 1.46 mm rechts, 0.87 mm hoch  
 Streuwert: 1.95, horizontal: 1.97, vertikal: 1.92

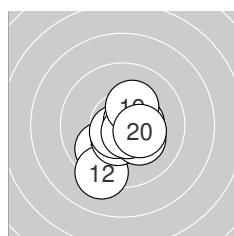

**Serie 2: 102.8 (98)**

9.9 ↖	9.2 ↘	10.4* →	10.5* ↘	10.6* ↖
10.2* ↘	10.7* ↗	10.7* ↘	10.3* ↗	10.3* ↘

beste Teiler: 71.4 (18.), 74.0 (17.), 77.7 (15.)  
 Trefferlage: 0.14 mm rechts, 0.77 mm tief  
 Streuwert: 1.36, horizontal: 1.22, vertikal: 1.48

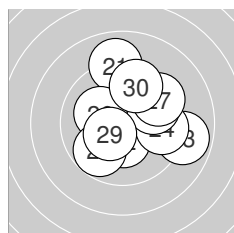

**Serie 3: 97.0 (92)**

9.0 ↑	10.3* ↓	8.9 →	9.6 →	9.8 ↗
10.1 ↖	9.5 ↗	9.8 ↖	10.4* ↖	9.6 ↑

beste Teiler: 140.4 (29.), 151.2 (22.), 205.0 (26.)  
 Trefferlage: 0.97 mm rechts, 0.58 mm hoch  
 Streuwert: 2.35, horizontal: 2.42, vertikal: 2.28

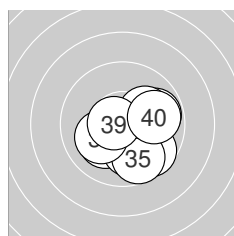

**Serie 4: 100.6 (96)**

10.4* →	9.7 ↘	10.1 ↖	10.1 ↓	9.7 ↘
10.1 ↖	9.8 →	10.1 ↗	10.7* ←	9.9 →

beste Teiler: 73.4 (39.), 146.0 (31.), 207.1 (33.)  
 Trefferlage: 0.88 mm rechts, 0.73 mm tief  
 Streuwert: 1.54, horizontal: 1.68, vertikal: 1.38

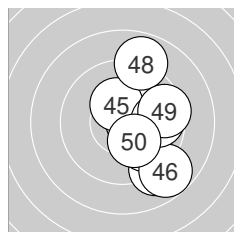

**Serie 5: 97.1 (92)**

9.0 ↘	10.6* →	10.1 ↗	9.9 ↘	10.3* ↑
8.8 ↘	9.8 →	8.9 ↑	9.5 →	10.2* ↘

beste Teiler: 79.1 (42.), 157.4 (45.), 185.3 (50.)  
 Trefferlage: 1.90 mm rechts, 0.25 mm tief  
 Streuwert: 2.15, horizontal: 1.32, vertikal: 2.74

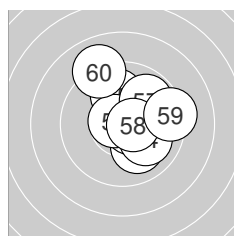

**Serie 6: 100.6 (97)**

10.0 ↘	10.6* ↘	10.6* ↗	10.0 ↘	10.0 ↑
10.7* ←	9.8 ↗	10.6* →	9.3 →	9.0 ↑

beste Teiler: 71.5 (56.), 79.1 (52.), 86.6 (53.)  
 Trefferlage: 0.82 mm rechts, 0.69 mm hoch  
 Streuwert: 1.76, horizontal: 1.66, vertikal: 1.86

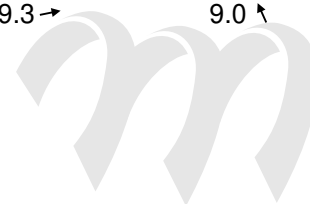

Ergebnis: **592.5** (564)  
 Serien: 100.2 95.5 95.7 101.9 101.5 97.7  
 Zähler: 30 24 6 0 0 0 0 0 0 0  
 Innenezehner: 23  
 Weitester: 592 (15.), 581 (51.), 578 (27.)  
 beste Teiler: 4.4 (46.), 8.5 (12.), 70.4 (56.)  
 Trefferlage: 0.71 mm rechts, 0.04 mm hoch  
 Streuwert: 2.12, horizontal: 2.47, vertikal: 1.71

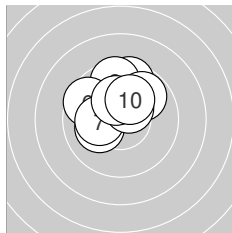
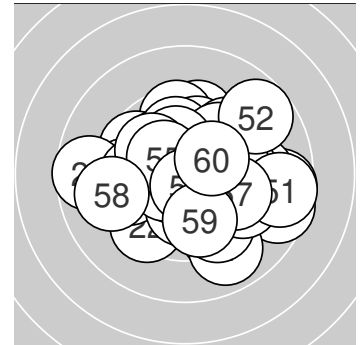

**Serie 1: 100.2 (96)**

9.6 ↑	9.6 ↑	9.8 ↗	10.3* ↑	10.1 ↖
9.6 ↖	10.2* ←	10.5* ↗	10.3* ↑	10.2* ↑

beste Teiler: 124.2 (8.), 152.6 (4.), 174.8 (9.)  
 Trefferlage: 0.32 mm links, 1.55 mm hoch  
 Streuwert: 1.43, horizontal: 1.53, vertikal: 1.33

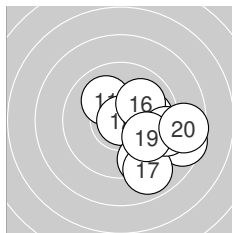

**Serie 2: 95.5 (91)**

10.1 ↘	10.9* ↘	10.0 →	9.3 ↘	8.6 ↘
10.0 ↗	8.9 ↘	9.3 →	9.8 ↘	8.6 →

beste Teiler: 8.5 (12.), 221.6 (11.), 236.3 (16.)  
 Trefferlage: 2.52 mm rechts, 0.95 mm tief  
 Streuwert: 2.11, horizontal: 2.21, vertikal: 2.02

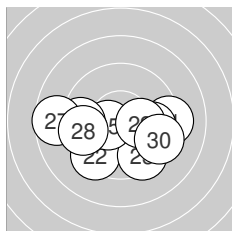

**Serie 3: 95.7 (91)**

9.2 →	9.4 ↗	9.5 ↘	9.8 →	10.5* ↖
9.5 ←	8.6 ←	9.6 ←	10.2* →	9.4 ↘

beste Teiler: 118.5 (25.), 180.8 (29.), 283.2 (24.)  
 Trefferlage: 0.18 mm links, 0.96 mm tief  
 Streuwert: 2.62, horizontal: 3.50, vertikal: 1.22

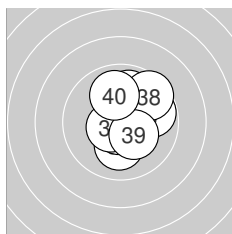

**Serie 4: 101.9 (97)**

10.1 ↓	10.3* ↗	10.6* →	9.9 ↑	10.7* ↓
10.6* ↖	9.8 →	9.6 ↗	10.3* ↘	10.0 ↑

beste Teiler: 70.6 (35.), 98.0 (33.), 99.2 (36.)  
 Trefferlage: 0.77 mm rechts, 0.48 mm hoch  
 Streuwert: 1.44, horizontal: 1.24, vertikal: 1.62

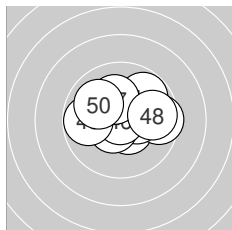

**Serie 5: 101.5 (96)**

9.8 ↗	10.5* ↘	9.6 →	10.4* →	10.5* ↗
10.9* ↖	10.2* ↑	9.8 →	9.8 ←	10.0 ↖

beste Teiler: 4.4 (46.), 101.1 (45.), 110.8 (42.)  
 Trefferlage: 0.43 mm rechts, 0.43 mm hoch  
 Streuwert: 1.63, horizontal: 2.07, vertikal: 1.03

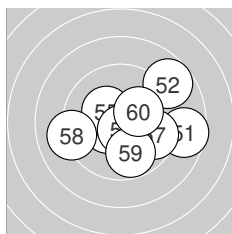

**Serie 6: 97.7 (93)**

8.6 →	8.7 ↗	10.4* ↖	10.2* ↘	10.3* ↖
10.7* ↓	9.7 ↘	9.1 ←	9.8 ↘	10.2* ↗

beste Teiler: 70.4 (56.), 131.0 (53.), 162.4 (55.)  
 Trefferlage: 1.04 mm rechts, 0.29 mm tief  
 Streuwert: 2.41, horizontal: 2.95, vertikal: 1.71

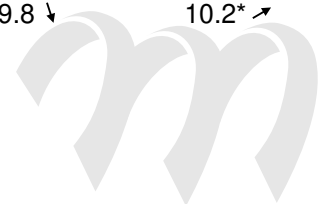

Ergebnis: **609.7** (581)  
 Serien: 100.9 103.0 102.2 100.4 101.6 101.6  
 Zähler: 41 19 0 0 0 0 0 0 0 0  
 Innenzehner: 36  
 Weitester: 494 (17.), 414 (31.), 401 (23.)  
 beste Teiler: 26.3 (56.), 33.2 (48.), 52.6 (28.)  
 Trefferlage: 0.12 mm links, 0.36 mm hoch  
 Streuwert: 1.57, horizontal: 1.76, vertikal: 1.37

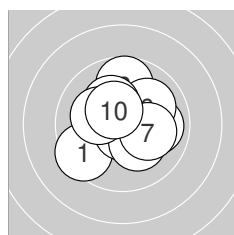
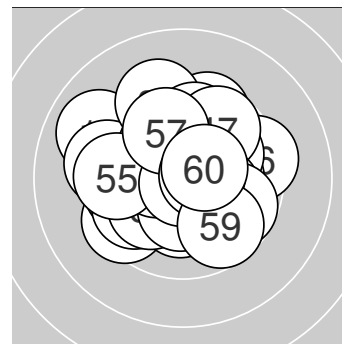

**Serie 1: 100.9 (97)**

9.5 ↙	9.9 →	9.7 ↑	10.7* ↓	10.2* ↘
10.0 ↗	10.1 ↘	10.2* ↖	10.2* ↖	10.4* ↖

beste Teiler: 58.0 (4.), 129.6 (10.), 180.0 (8.)  
 Trefferlage: 0.12 mm rechts, 0.29 mm hoch  
 Streuwert: 1.68, horizontal: 1.79, vertikal: 1.56

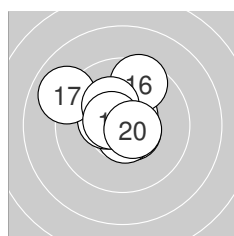

**Serie 2: 103.0 (98)**

10.6* ↘	10.6* ↗	10.7* ↘	10.7* ↓	10.4* ↖
9.6 ↑	9.0 ↖	10.2* ↖	10.6* ↖	10.6* ↘

beste Teiler: 69.0 (13.), 73.7 (14.), 86.0 (20.)  
 Trefferlage: 0.34 mm links, 0.67 mm hoch  
 Streuwert: 1.50, horizontal: 1.65, vertikal: 1.33

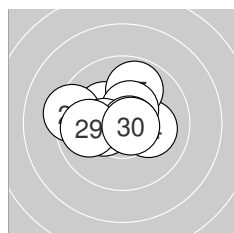

**Serie 3: 102.2 (97)**

10.4* →	10.3* ↖	9.3 ←	10.1 →	9.9 ↑
10.5* ↑	10.4* ↖	10.7* →	9.9 ←	10.7* ↘

beste Teiler: 52.6 (28.), 68.0 (30.), 119.8 (26.)  
 Trefferlage: 0.33 mm links, 0.39 mm hoch  
 Streuwert: 1.52, horizontal: 1.92, vertikal: 0.97

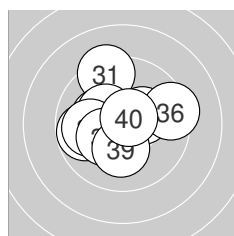

**Serie 4: 100.4 (96)**

9.3 ↑	9.8 ←	10.2* ↖	10.3* ↗	10.3* ↖
9.4 →	9.9 ←	10.3* ↗	10.2* ↓	10.7* ↗

beste Teiler: 70.7 (40.), 157.8 (35.), 167.9 (34.)  
 Trefferlage: 0.55 mm links, 0.37 mm hoch  
 Streuwert: 1.81, horizontal: 2.02, vertikal: 1.56

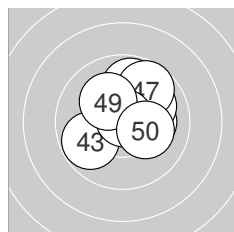

**Serie 5: 101.6 (97)**

10.4* ↑	10.5* ↖	9.8 ↙	10.2* →	9.8 ↑
10.0 ↗	9.7 ↗	10.8* ↑	10.2* ↖	10.2* ↘

beste Teiler: 33.2 (48.), 103.4 (42.), 139.1 (41.)  
 Trefferlage: 0.40 mm rechts, 0.80 mm hoch  
 Streuwert: 1.44, horizontal: 1.55, vertikal: 1.33

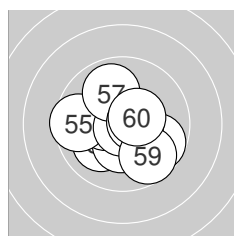

**Serie 6: 101.6 (96)**

10.1 ↙	10.3* ↓	9.7 ↘	10.4* ←	9.6 ←
10.8* ↓	9.9 ↑	10.6* →	9.7 ↘	10.5* ↗

beste Teiler: 26.3 (56.), 100.9 (58.), 124.3 (60.)  
 Trefferlage: 0.07 mm links, 0.37 mm tief  
 Streuwert: 1.63, horizontal: 1.84, vertikal: 1.39

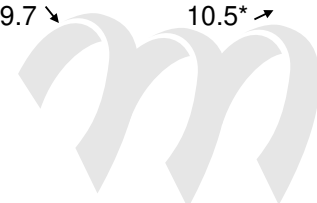

Ergebnis: **0.0** (0)<sub>DNS</sub>  
 Serien:  
 Zähler: 0 0 0 0 0 0 0 0 0 0 0  
 Innenzehner: 0  
 Weitesten:  
 beste Teiler:  
 Trefferlage: 0.00 mm , 0.00 mm  
 Streuwert:

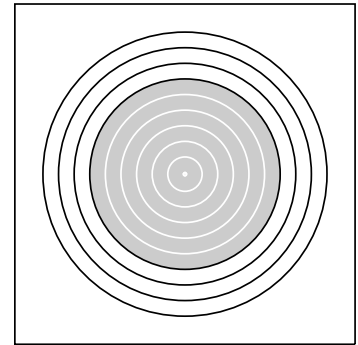



Ergebnis: **589.1** (558)  
 Serien: 98.1 100.3 97.7 98.7 96.6 97.7  
 Zähler: 25 28 7 0 0 0 0 0 0 0  
 Innenezehner: 18  
 Weitester: 706 (53.), 549 (60.), 545 (37.)  
 beste Teiler: 11.3 (14.), 18.9 (36.), 44.3 (56.)  
 Trefferlage: 0.33 mm links, 0.22 mm hoch  
 Streuwert: 2.27, horizontal: 2.48, vertikal: 2.04

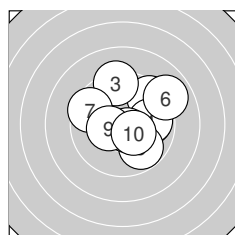
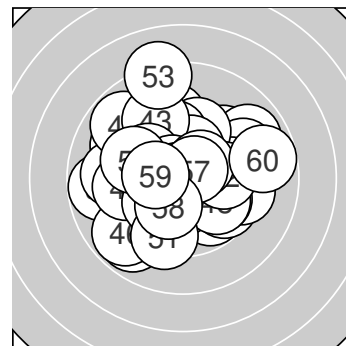

**Serie 1: 98.1 (92)**

9.9 → 9.5 ↗ 9.3 ↑ 9.8 → 9.8 ↘  
 8.9 ↗ 9.5 ↖ 10.6\* ↘ 10.4\* ← 10.4\* ↘  
 beste Teiler: 76.2 (8.), 139.6 (10.), 143.9 (9.)  
 Trefferlage: 1.05 mm rechts, 0.71 mm hoch  
 Streuwert: 2.13, horizontal: 2.29, vertikal: 1.95

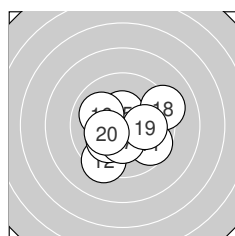

**Serie 2: 100.3 (97)**

9.6 ↘ 9.4 ↙ 10.1 ↘ 10.9\* ↖ 10.5\* ↑  
 10.0 ↖ 10.3\* ↓ 9.2 → 10.1 → 10.2\* ↙  
 beste Teiler: 11.3 (14.), 120.1 (15.), 158.0 (17.)  
 Trefferlage: 0.18 mm rechts, 0.52 mm tief  
 Streuwert: 1.90, horizontal: 2.14, vertikal: 1.63

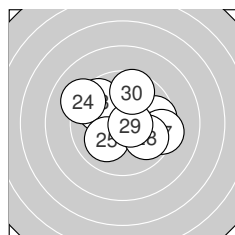

**Serie 3: 97.7 (92)**

9.8 → 9.9 ↖ 9.6 ↖ 9.1 ↖ 10.1 ↙  
 9.7 → 9.4 → 9.9 ↘ 10.6\* → 9.6 ↑  
 beste Teiler: 79.4 (29.), 225.5 (25.), 268.7 (22.)  
 Trefferlage: 0.37 mm rechts, 0.45 mm hoch  
 Streuwert: 2.29, horizontal: 2.76, vertikal: 1.69

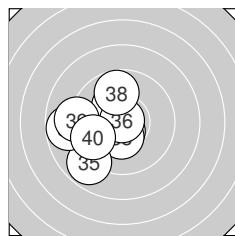

**Serie 4: 98.7 (93)**

10.6\* ↓ 10.5\* ↖ 10.4\* ↓ 10.2\* ↖ 8.9 ↙  
 10.9\* ↖ 8.8 ← 9.7 ↑ 9.1 ← 9.6 ↙  
 beste Teiler: 18.9 (36.), 92.0 (31.), 122.9 (32.)  
 Trefferlage: 1.87 mm links, 0.25 mm tief  
 Streuwert: 1.98, horizontal: 2.03, vertikal: 1.93

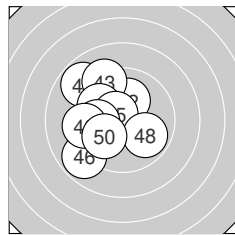

**Serie 5: 96.6 (91)**

8.8 ↖ 10.1 ↑ 9.2 ↖ 9.9 ↖ 10.6\* ↖  
 8.8 ↙ 9.9 ← 9.9 ↘ 9.4 ← 10.0 ↙  
 beste Teiler: 94.9 (45.), 203.0 (42.), 244.4 (50.)  
 Trefferlage: 1.80 mm links, 0.39 mm hoch  
 Streuwert: 2.20, horizontal: 2.02, vertikal: 2.37

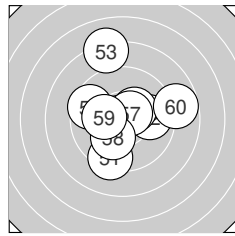

**Serie 6: 97.7 (93)**

9.3 ↙ 9.9 → 8.1 ↑ 9.6 ↖ 10.3\* ↗  
 10.8\* ← 10.6\* ↗ 10.1 ↙ 10.2\* ← 8.8 →  
 beste Teiler: 44.3 (56.), 94.2 (57.), 151.4 (55.)  
 Trefferlage: 0.05 mm rechts, 0.57 mm hoch  
 Streuwert: 2.62, horizontal: 2.52, vertikal: 2.72



Ergebnis: **611.8** (587)  
 Serien: 103.4 103.2 99.9 101.7 101.9 101.7  
 Zähler: 47 13 0 0 0 0 0 0 0 0  
 Innenezehner: 34  
 Weitestе: 409 (51.), 399 (22.), 359 (14.)  
 beste Teiler: 24.3 (4.), 60.8 (25.), 63.7 (9.)  
 Trefferlage: 0.07 mm links, 0.39 mm tief  
 Streuwert: 1.46, horizontal: 1.56, vertikal: 1.36

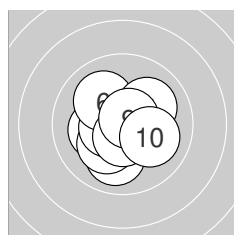
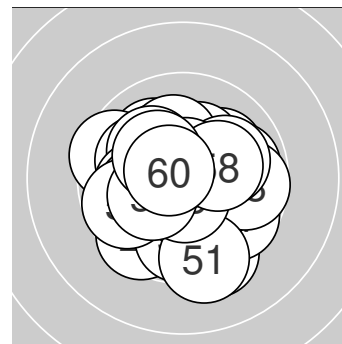

**Serie 1: 103.4 (100)**

10.2\* ←      10.0 ↓      10.2\* ↗      10.9\* ↓      10.5\* ←  
 10.1 ↘      10.1 ↗      10.6\* ↓      10.7\* ↗      10.1 ↘

beste Teiler: 24.3 (4.), 63.7 (9.), 91.0 (8.)  
 Trefferlage: 0.17 mm links, 0.31 mm tief  
 Streuwert: 1.26, horizontal: 1.31, vertikal: 1.21

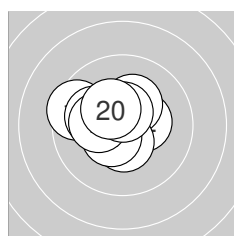

**Serie 2: 103.2 (99)**

10.7\* ↓      10.4\* →      10.3\* ↗      9.5 ←      10.5\* ↓  
 10.1 ←      10.5\* ↗      10.2\* ←      10.6\* ↑      10.4\* ↘

beste Teiler: 72.4 (11.), 98.0 (19.), 117.3 (17.)  
 Trefferlage: 0.67 mm links, 0.32 mm hoch  
 Streuwert: 1.23, horizontal: 1.44, vertikal: 0.97

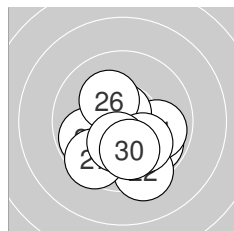

**Serie 3: 99.9 (95)**

9.8 ↘      9.4 ↓      9.8 ←      9.9 →      10.7\* ↑  
 10.2\* ↘      9.6 ↗      10.1 ↘      10.3\* ↓      10.1 ↓

beste Teiler: 60.8 (25.), 161.5 (29.), 184.4 (26.)  
 Trefferlage: 0.22 mm rechts, 1.31 mm tief  
 Streuwert: 1.65, horizontal: 1.77, vertikal: 1.53

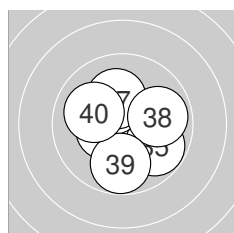

**Serie 4: 101.7 (97)**

10.5\* ←      10.7\* ↘      10.4\* ←      10.1 ↓      9.8 ↘  
 10.3\* ↘      10.2\* ↑      9.9 →      9.8 ↓      10.0 ←

beste Teiler: 66.5 (32.), 122.0 (31.), 130.9 (33.)  
 Trefferlage: 0.09 mm links, 0.14 mm tief  
 Streuwert: 1.57, horizontal: 1.53, vertikal: 1.60

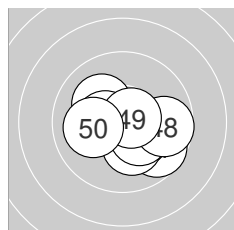

**Serie 5: 101.9 (98)**

9.7 ↘      10.1 ↘      10.3\* ↘      10.4\* ←      10.4\* ↘  
 10.2\* ↓      10.3\* ↘      9.7 →      10.7\* ↗      10.1 ←

beste Teiler: 70.6 (49.), 129.3 (44.), 131.6 (45.)  
 Trefferlage: 0.56 mm rechts, 0.52 mm tief  
 Streuwert: 1.40, horizontal: 1.74, vertikal: 0.96

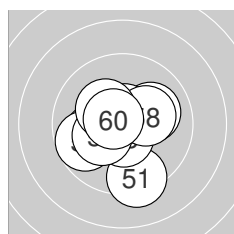

**Serie 6: 101.7 (98)**

9.3 ↓      10.1 ←      10.6\* ↓      9.7 ←      10.3\* ←  
 10.0 →      10.6\* ↑      10.2\* →      10.3\* ↘      10.6\* ↘

beste Teiler: 77.2 (57.), 78.7 (60.), 96.4 (53.)  
 Trefferlage: 0.32 mm links, 0.39 mm tief  
 Streuwert: 1.57, horizontal: 1.62, vertikal: 1.52

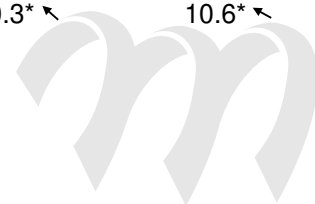

Ergebnis: **594.2** (565)  
 Serien: 99.6 99.5 100.5 96.8 98.0 99.8  
 Zähler: 29 28 2 1 0 0 0 0 0 0  
 Innenezehner: 22  
 Weitester: 764 (40.), 584 (42.), 520 (47.)  
 beste Teiler: 81.7 (29.), 84.7 (20.), 87.9 (7.)  
 Trefferlage: 0.05 mm rechts, 0.08 mm hoch  
 Streuwert: 2.10, horizontal: 2.29, vertikal: 1.88

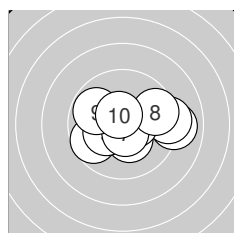
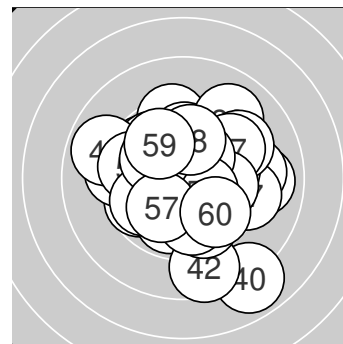

**Serie 1: 99.6 (95)**

9.0 → 9.7 ↙ 10.3\* ↓  
 10.5\* → 10.6\* ↓ 9.6 →  
 beste Teiler: 87.9 (7.), 96.5 (10.), 117.0 (6.)  
 Trefferlage: 0.73 mm rechts, 0.09 mm tief  
 Streuwert: 2.05, horizontal: 2.71, vertikal: 1.02

9.2 → 10.3\* ↙  
 9.8 ↖ 10.6\* ↗

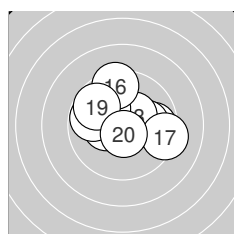

**Serie 2: 99.5 (95)**

9.8 → 10.1 → 10.4\* ↗  
 9.4 ↑ 9.3 → 9.8 ↖  
 beste Teiler: 84.7 (20.), 141.6 (13.), 156.2 (14.)  
 Trefferlage: 0.13 mm rechts, 0.67 mm hoch  
 Streuwert: 1.95, horizontal: 2.35, vertikal: 1.44

10.3\* ← 10.1 ↘  
 9.7 ↖ 10.6\* ↓

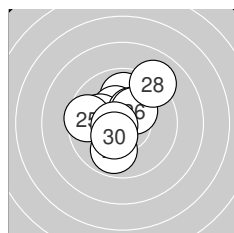

**Serie 3: 100.5 (96)**

9.9 ↑ 10.3\* ↘ 10.1 ↖  
 10.3\* ↗ 9.9 ↓ 9.0 ↗  
 beste Teiler: 81.7 (29.), 142.5 (30.), 144.8 (24.)  
 Trefferlage: 0.37 mm links, 0.71 mm hoch  
 Streuwert: 1.77, horizontal: 1.75, vertikal: 1.80

10.4\* ↗ 9.6 ←  
 10.6\* ← 10.4\* ↗

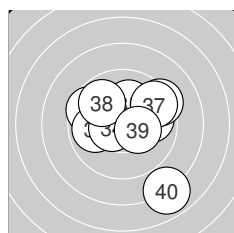

**Serie 4: 96.8 (91)**

9.9 → 9.6 ↖ 9.9 ←  
 9.3 ↗ 9.5 ↗ 9.8 ↖  
 beste Teiler: 107.5 (34.), 156.0 (39.), 207.2 (35.)  
 Trefferlage: 0.67 mm rechts, 0.20 mm hoch  
 Streuwert: 2.64, horizontal: 2.72, vertikal: 2.56

10.5\* ← 10.1 ↑  
 10.3\* → 7.9 ↓

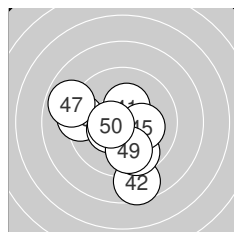

**Serie 5: 98.0 (93)**

10.3\* ↑ 8.6 ↓ 9.7 ↓  
 9.3 ← 8.9 ↖ 10.4\* ↙  
 beste Teiler: 114.5 (50.), 139.7 (48.), 152.8 (41.)  
 Trefferlage: 0.54 mm links, 1.08 mm tief  
 Streuwert: 2.28, horizontal: 2.30, vertikal: 2.26

10.2\* ↓ 10.2\* →  
 9.9 ↓ 10.5\* ←

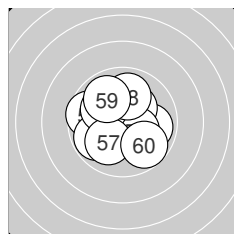

**Serie 6: 99.8 (95)**

9.9 → 9.6 ↖ 9.8 ↙  
 10.1 ↖ 10.0 ↗ 10.0 ↑  
 beste Teiler: 150.4 (55.), 172.2 (54.), 218.0 (56.)  
 Trefferlage: 0.28 mm links, 0.12 mm hoch  
 Streuwert: 1.86, horizontal: 2.02, vertikal: 1.69

10.3\* ↗ 10.4\* ↘  
 9.9 ↖ 9.8 ↓

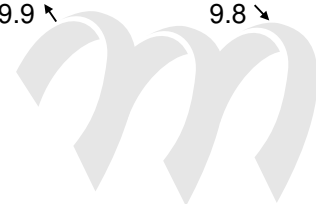

Ergebnis: **606.8** (582)  
 Serien: 97.8 101.6 100.0 103.4 102.3 101.7  
 Zähler: 42 18 0 0 0 0 0 0 0 0  
 Innenzehner: 33  
 Weitester: 480 (25.), 477 (42.), 473 (22.)  
 beste Teiler: 25.4 (41.), 34.1 (53.), 74.1 (34.)  
 Trefferlage: 0.18 mm rechts, 0.06 mm hoch  
 Streuwert: 1.66, horizontal: 1.87, vertikal: 1.43

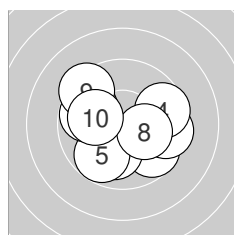
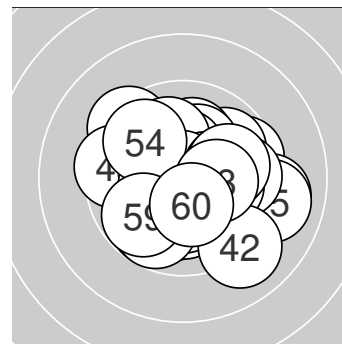

**Serie 1: 97.8 (93)**

9.7 ↘ 9.5 → 10.0 ↓ 9.6 → 9.8 ↙  
 9.8 ↖ 9.8 ← 10.2\* → 9.4 ↖ 10.0 ←

beste Teiler: 186.8 (8.), 226.7 (10.), 230.7 (3.)  
 Trefferlage: 0.20 mm links, 0.13 mm tief  
 Streuwert: 2.22, horizontal: 2.63, vertikal: 1.72

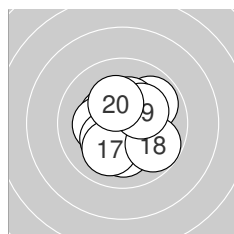

**Serie 2: 101.6 (98)**

9.9 ↗ 10.3\* ↑ 10.1 ↓ 10.4\* ↖ 10.2\* ←  
 10.3\* ↙ 10.1 ↘ 9.8 ↘ 10.2\* ↗ 10.3\* ↑

beste Teiler: 137.8 (14.), 157.4 (12.), 169.1 (20.)  
 Trefferlage: 0.09 mm rechts, 0.09 mm tief  
 Streuwert: 1.53, horizontal: 1.53, vertikal: 1.53

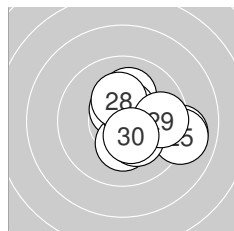

**Serie 3: 100.0 (97)**

10.5\* ↖ 9.1 → 10.2\* ↓ 10.1 ↑ 9.0 →  
 10.2\* ↘ 10.5\* ↑ 10.3\* ↑ 9.7 → 10.4\* ↘

beste Teiler: 104.0 (27.), 105.1 (21.), 135.3 (30.)  
 Trefferlage: 1.43 mm rechts, 0.07 mm tief  
 Streuwert: 1.70, horizontal: 1.96, vertikal: 1.41

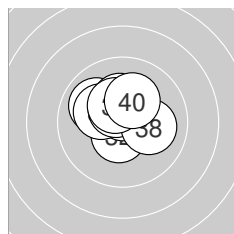

**Serie 4: 103.4 (100)**

10.5\* → 10.5\* ↓ 10.0 ↖ 10.7\* ↑ 10.2\* ↖  
 10.5\* ↖ 10.3\* ↑ 10.1 → 10.4\* ↖ 10.2\* ↑

beste Teiler: 74.1 (34.), 103.0 (31.), 107.2 (32.)  
 Trefferlage: 0.15 mm links, 0.72 mm hoch  
 Streuwert: 1.10, horizontal: 1.25, vertikal: 0.92

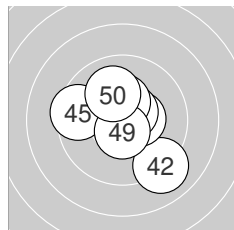

**Serie 5: 102.3 (98)**

10.9\* ↓ 9.0 ↘ 10.5\* ↖ 10.3\* ↖ 9.5 ←  
 10.5\* → 10.6\* ↗ 10.4\* ↑ 10.6\* ↓ 10.0 ↖

beste Teiler: 25.4 (41.), 89.0 (49.), 90.5 (47.)  
 Trefferlage: 0.15 mm links, 0.20 mm hoch  
 Streuwert: 1.67, horizontal: 1.72, vertikal: 1.61

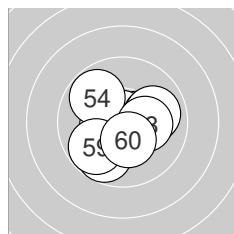

**Serie 6: 101.7 (96)**

10.5\* → 10.5\* ← 10.8\* ↑ 9.8 ↖ 9.8 ↙  
 10.0 → 9.9 → 10.2\* → 9.8 ↙ 10.4\* ↓

beste Teiler: 34.1 (53.), 122.3 (51.), 122.8 (52.)  
 Trefferlage: 0.11 mm rechts, 0.26 mm tief  
 Streuwert: 1.58, horizontal: 1.77, vertikal: 1.37



Ergebnis: **625.1** (595)  
 Serien: 103.8 104.6 104.7 105.0<sup>OF</sup> 102.8 104.2  
 Zähler: 55 5 0 0 0 0 0 0 0 0  
 Innenezehner: 53  
 Weitester: 374 (45.), 323 (46.), 307 (51.)  
 beste Teiler: 40.1 (40.), 41.0 (7.), 42.3 (59.)  
 Trefferlage: 0.02 mm rechts, 0.07 mm hoch  
 Streuwert: 1.07, horizontal: 1.17, vertikal: 0.97

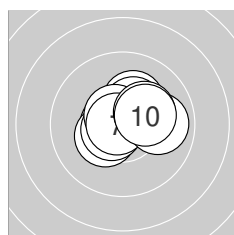
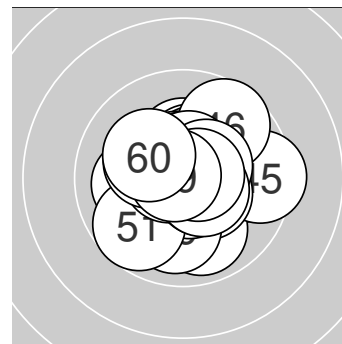

**Serie 1: 103.8 (99)**

10.6* ←	10.2* ↑	10.3* ↙	10.4* ↗	10.6* ↖
10.6* ↘	10.8* ←	9.9 →	10.2* ↗	10.2* ↗

beste Teiler: 41.0 (7.), 84.0 (1.), 85.0 (6.)  
 Trefferlage: 0.34 mm rechts, 0.38 mm hoch  
 Streuwert: 1.06, horizontal: 1.30, vertikal: 0.76

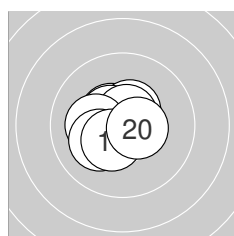

**Serie 2: 104.6 (100)**

10.5* ↙	10.7* ←	10.5* ↘	10.5* ↗	10.5* ↘
10.6* ↑	10.2* ←	10.2* ↙	10.4* ↙	10.5* →

beste Teiler: 68.8 (12.), 76.3 (16.), 109.0 (20.)  
 Trefferlage: 0.57 mm links, 0.00 mm  
 Streuwert: 0.88, horizontal: 0.94, vertikal: 0.81

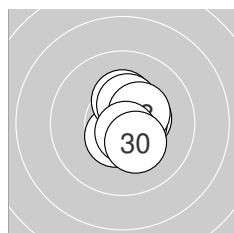

**Serie 3: 104.7 (100)**

10.5* →	10.4* →	10.5* ↙	10.6* →	10.6* ↘
10.3* ↑	10.4* ↑	10.4* ↗	10.7* ↓	10.3* ↘

beste Teiler: 69.8 (29.), 88.1 (25.), 98.3 (24.)  
 Trefferlage: 0.64 mm rechts, 0.09 mm hoch  
 Streuwert: 0.81, horizontal: 0.60, vertikal: 0.98

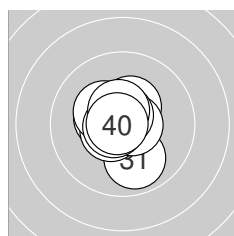

**Serie 4: 105.0 (99)**

9.9 ↓	10.4* ←	10.6* ↙	10.3* ↘	10.4* ↑
10.7* →	10.7* ←	10.7* ↑	10.5* ↖	10.8* ←

beste Teiler: 40.1 (40.), 65.0 (38.), 67.7 (37.)  
 Trefferlage: 0.27 mm links, 0.10 mm hoch  
 Streuwert: 0.94, horizontal: 0.80, vertikal: 1.06

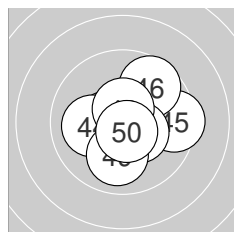

**Serie 5: 102.8 (98)**

10.6* ↙	10.5* ←	10.7* ↙	10.1 ←	9.5 →
9.7 ↗	10.4* ↘	10.6* ↑	10.0 ↓	10.7* ↓

beste Teiler: 68.2 (43.), 74.3 (50.), 94.0 (41.)  
 Trefferlage: 0.25 mm rechts, 0.17 mm tief  
 Streuwert: 1.49, horizontal: 1.67, vertikal: 1.28

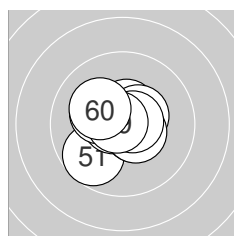

**Serie 6: 104.2 (99)**

9.7 ↙	10.5* ↑	10.7* ←	10.5* ↘	10.4* ↗
10.5* ↘	10.2* ↘	10.7* →	10.8* ←	10.2* ↘

beste Teiler: 42.3 (59.), 68.5 (53.), 74.7 (58.)  
 Trefferlage: 0.24 mm links, 0.05 mm hoch  
 Streuwert: 1.11, horizontal: 1.22, vertikal: 0.99



**ISSF AR Women Jun**

StandNr: 147

**Hillinger, Christina #60**

**Juniorinnen**

Competition

**StartNr: 143**

02.12.2023 16:43

**AUT**

---

QF

- Schütze hat sich fürs Finale qualifiziert

Ergebnis: **601.4** (577)  
 Serien: 103.0 97.5 98.5 97.4 100.8 104.2  
 Zähler: 39 19 2 0 0 0 0 0 0 0  
 Innenezehner: 28  
 Weitester: 561 (11.), 520 (13.), 499 (35.)  
 beste Teiler: 8.0 (3.), 20.8 (55.), 37.2 (51.)  
 Trefferlage: 0.37 mm links, 0.35 mm hoch  
 Streuwert: 1.84, horizontal: 2.15, vertikal: 1.47

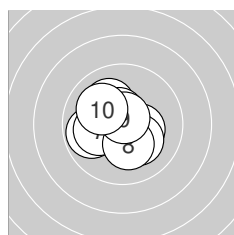
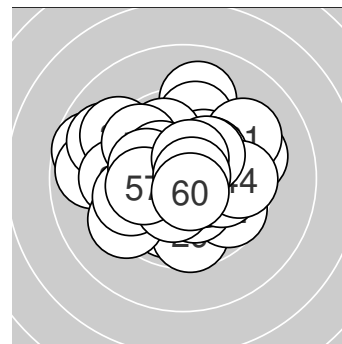

**Serie 1: 103.0 (99)**

10.1 ↖	10.6* ↖	10.9* ↓	10.3* →	9.8 ←
10.2* ↘	10.1 ←	10.2* ↓	10.7* ↑	10.1 ↘

beste Teiler: 8.0 (3.), 57.4 (9.), 100.5 (2.)  
 Trefferlage: 0.46 mm links, 0.02 mm tief  
 Streuwert: 1.29, horizontal: 1.42, vertikal: 1.14

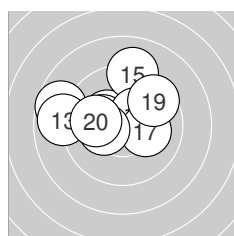

**Serie 2: 97.5 (94)**

8.7 ↖	10.3* ↖	8.9 ←	10.2* ←	9.1 ↑
10.3* ↗	10.1 →	10.3* ←	9.6 ↗	10.0 ←

beste Teiler: 155.1 (16.), 156.2 (12.), 166.1 (18.)  
 Trefferlage: 1.08 mm links, 1.05 mm hoch  
 Streuwert: 2.23, horizontal: 2.79, vertikal: 1.46

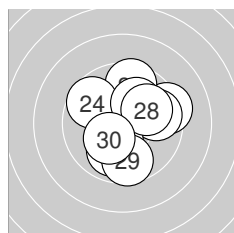

**Serie 3: 98.5 (94)**

9.3 →	9.6 ↑	9.7 →	9.7 ↖	10.1 ↗
9.9 ↓	10.3* ↓	10.0 ↗	9.7 ↓	10.2* ↗

beste Teiler: 171.4 (27.), 176.3 (30.), 211.3 (25.)  
 Trefferlage: 0.60 mm rechts, 0.15 mm hoch  
 Streuwert: 2.07, horizontal: 1.99, vertikal: 2.15

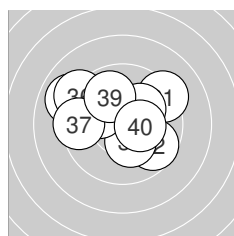

**Serie 4: 97.4 (94)**

9.3 ↗	9.7 ↘	10.3* ↓	10.1 ↖	9.0 ↖
9.2 ↖	9.4 ←	10.2* ↗	9.9 ↖	10.3* →

beste Teiler: 153.7 (40.), 166.0 (33.), 200.6 (38.)  
 Trefferlage: 0.53 mm links, 0.82 mm hoch  
 Streuwert: 2.35, horizontal: 2.90, vertikal: 1.61

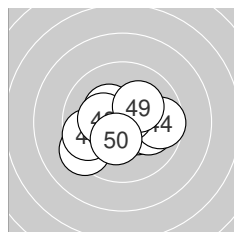

**Serie 5: 100.8 (97)**

9.3 ↖	10.4* ↘	10.0 →	9.6 →	9.7 ←
10.7* ↗	10.3* ↖	10.3* ←	10.2* ↗	10.3* ↓

beste Teiler: 68.6 (46.), 138.6 (42.), 157.6 (50.)  
 Trefferlage: 0.11 mm links, 0.29 mm tief  
 Streuwert: 1.76, horizontal: 2.20, vertikal: 1.17

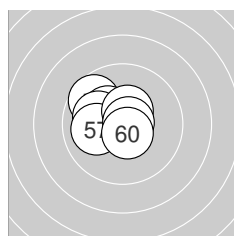

**Serie 6: 104.2 (99)**

10.8* ↓	9.7 ↖	10.6* ↑	10.3* ↖	10.9* ↗
10.1 ←	10.0 ←	10.5* ↑	10.7* →	10.6* ↓

beste Teiler: 20.8 (55.), 37.2 (51.), 52.6 (59.)  
 Trefferlage: 0.64 mm links, 0.43 mm hoch  
 Streuwert: 1.07, horizontal: 1.24, vertikal: 0.87

