

Ergebnis:	<b>623.7</b>	(595)					
Serien:	104.6	104.4	102.6	103.9	105.6	102.6	
Zähler:	55	5	0	0	0	0	0
Innenzehner:	48						
weiteste:	365 (24), 339 (26), 312 (11)						
beste Teiler	17.8 (9.) 24.1 (49.) 29.6 (41.)						
Trefferlage	0.03 mm rechts, 0.05 mm tief						
Streuwert	1.13, horizontal: 1.22, vertikal: 1.03						

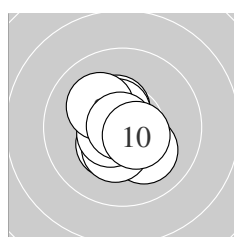

Serie 1:					
	10.4 *	10.4 *	10.7 *	10.5 *	10.1 ↘
	10.4 *	10.6 *	10.1 ↖	10.9 *	10.5 *
beste Teiler	17.8 (9.) 51.2 (3.) 89.8 (7.)				
Trefferlage	0.27 mm links, 0.11 mm tief				
Streuwert	0.96, horizontal: 0.85, vertikal: 1.07				

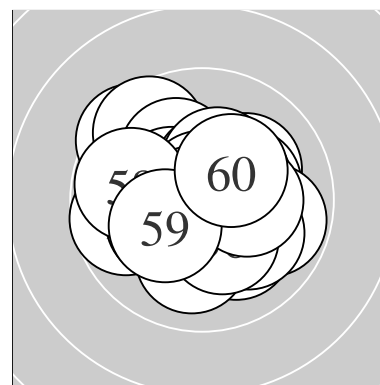
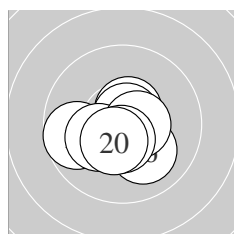

Serie 2:					
	9.7 ←	10.6 *	10.7 *	10.7 *	10.7 *
	10.1 ↘	10.2 *	10.6 *	10.6 *	10.5 *
beste Teiler	51.1 (13.) 51.6 (14.) 54.5 (15.)				
Trefferlage	0.13 mm links, 0.43 mm tief				
Streuwert	1.08, horizontal: 1.30, vertikal: 0.80				

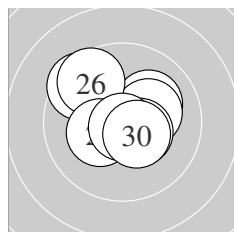

Serie 3:					
	10.6 *	10.1 ↗	10.2 *	9.5 ↖	10.6 *
	9.6 ↖	10.3 *	10.4 *	10.8 *	10.5 *
beste Teiler	33.0 (29.) 98.3 (25.) 99.9 (21.)				
Trefferlage	0.09 mm links, 0.43 mm hoch				
Streuwert	1.46, horizontal: 1.64, vertikal: 1.27				

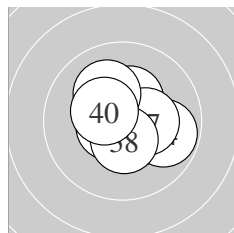

Serie 4:					
	10.6 *	10.5 *	10.6 *	9.8 →	10.7 *
	10.4 *	10.3 *	10.5 *	10.1 ↖	10.4 *
beste Teiler	65.0 (35.) 77.1 (33.) 92.3 (31.)				
Trefferlage	0.33 mm rechts, 0.14 mm hoch				
Streuwert	1.11, horizontal: 1.21, vertikal: 1.00				

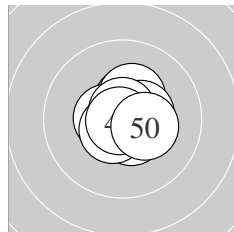

Serie 5:					
	10.8 *	10.5 *	10.5 *	10.3 *	10.5 *
	10.5 *	10.7 *	10.6 *	10.9 *	10.3 *
beste Teiler	24.1 (49.) 29.6 (41.) 51.0 (47.)				
Trefferlage	0.19 mm rechts, 0.13 mm hoch				
Streuwert	0.77, horizontal: 0.79, vertikal: 0.75				

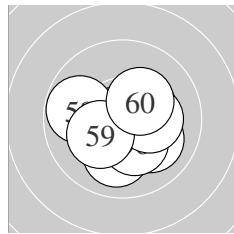

Serie 6:					
	10.1 ↘	10.8 *	10.6 *	10.0 ↓	10.3 *
	10.3 *	10.2 *	9.8 ←	10.2 *	10.3 *
beste Teiler	33.2 (52.) 99.9 (53.) 152.1 (55.)				
Trefferlage	0.15 mm rechts, 0.46 mm tief				
Streuwert	1.33, horizontal: 1.51, vertikal: 1.13				

Meyton Elektronik

**ISSF AR Women Jun – Wertung – Juniorinnen**

**StartNr: 44**

StandNr: 142

19. Januar 2020 9:28

**Ng, Cecilia** #316

SGP

---

\_\_\_\_\_  
Unterschrift des Schützen

Meyton Elektronik

Ergebnis: **612.3** (583)  
 Serien: 104.2 103.8 103.0 97.4 102.9 101.0  
 Zähler: 43 17 0 0 0 0 0 0 0  
 Innenzehner: 34  
 weiteste: 432 (32), 422 (53), 382 (36)  
 beste Teiler 36.4 (45.) 39.5 (4.) 45.6 (22.)  
 Trefferlage 0.10 mm rechts, 0.27 mm hoch  
 Streuwert 1.50, horizontal: 1.76, vertikal: 1.19

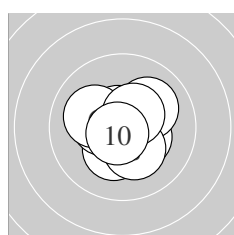
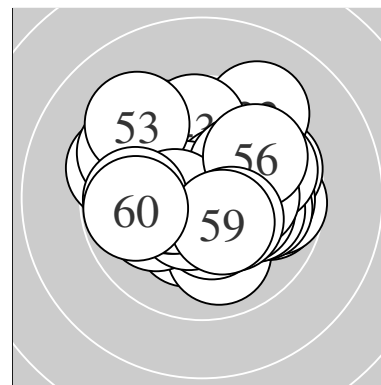

Serie 1:  
 10.6 \* 10.3 \* 10.4 \* 10.8 \* 10.4 \*  
 10.1 ↖ 10.1 ↗ 10.3 \* 10.5 \* 10.7 \*  
 beste Teiler 39.5 (4.) 58.8 (10.) 81.8 (1.)  
 Trefferlage 0.02 mm links, 0.01 mm hoch  
 Streuwert 1.11, horizontal: 1.18, vertikal: 1.02

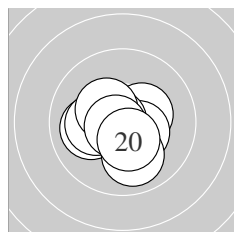

Serie 2:  
 10.4 \* 10.4 \* 10.6 \* 10.7 \* 10.0 ←  
 10.2 \* 10.4 \* 10.0 ↓ 10.7 \* 10.4 \*  
 beste Teiler 54.3 (14.) 58.8 (19.) 83.7 (13.)  
 Trefferlage 0.33 mm links, 0.40 mm tief  
 Streuwert 1.09, horizontal: 1.23, vertikal: 0.92

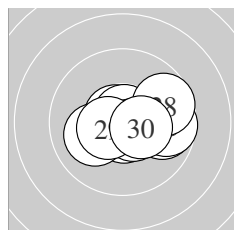

Serie 3:  
 10.7 \* 10.8 \* 9.8 → 10.7 \* 9.7 →  
 10.1 ← 10.6 \* 9.7 ↗ 10.5 \* 10.4 \*  
 beste Teiler 45.6 (22.) 66.8 (21.) 69.7 (24.)  
 Trefferlage 0.76 mm rechts, 0.14 mm tief  
 Streuwert 1.33, horizontal: 1.77, vertikal: 0.65

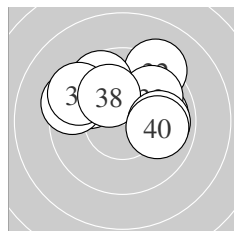

Serie 4:  
 10.0 → 9.2 ↗ 9.9 ↗ 9.8 ↖ 9.7 ↖  
 9.4 ↖ 9.5 ↖ 10.1 ↖ 9.9 → 9.9 →  
 beste Teiler 205.3 (38.) 250.0 (31.) 252.8 (40.)  
 Trefferlage 0.03 mm rechts, 1.48 mm hoch  
 Streuwert 2.04, horizontal: 2.60, vertikal: 1.24

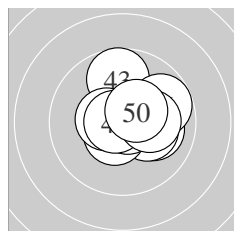

Serie 5:  
 10.1 → 10.2 \* 9.7 ↑ 10.5 \* 10.8 \*  
 9.8 ↗ 10.5 \* 10.7 \* 10.2 \* 10.4 \*  
 beste Teiler 36.4 (45.) 53.0 (48.) 101.7 (44.)  
 Trefferlage 0.73 mm rechts, 0.33 mm hoch  
 Streuwert 1.26, horizontal: 1.36, vertikal: 1.14

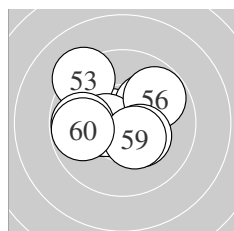

Serie 6:  
 10.6 \* 10.4 \* 9.3 ↖ 10.1 ↗ 10.5 \*  
 9.8 ↗ 10.3 \* 9.8 ← 10.4 \* 9.8 ←  
 beste Teiler 77.6 (51.) 117.9 (55.) 134.8 (52.)  
 Trefferlage 0.56 mm links, 0.36 mm hoch  
 Streuwert 1.68, horizontal: 1.97, vertikal: 1.32

Meyton Elektronik

**ISSF AR Women Jun – Wertung – Juniorinnen**

StandNr: 143

**Goldfaden, Ella #336**

**StartNr: 45**

19. Januar 2020 9:47

Israel

---

Unterschrift des Schützen

Meyton Elektronik

Ergebnis: **618.7** (591)  
 Serien: 105.1 102.5 102.3 102.4 103.8 102.6  
 Zähler: 51 9 0 0 0 0 0 0 0  
 Innenzehner: 46  
 weiteste: 429 (53), 362 (29), 320 (47)  
 beste Teiler 6.4 (45.) 33.9 (36.) 51.0 (25.)  
 Trefferlage 0.17 mm rechts, 0.05 mm tief  
 Streuwert 1.27, horizontal: 1.39, vertikal: 1.15

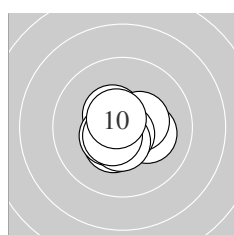
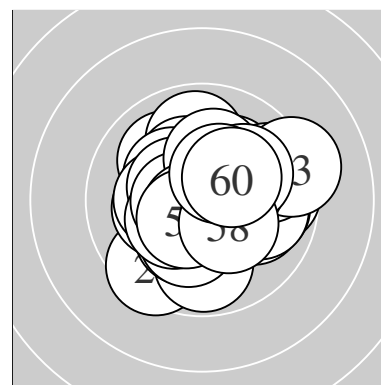

Serie 1:  
 10.7 \* 10.2 \* 10.5 \* 10.4 \* 10.5 \*  
 10.4 \* 10.7 \* 10.5 \* 10.6 \* 10.6 \*  
 beste Teiler 54.4 (7.) 55.4 (1.) 78.6 (10.)  
 Trefferlage 0.11 mm links, 0.24 mm tief  
 Streuwert 0.84, horizontal: 0.95, vertikal: 0.72

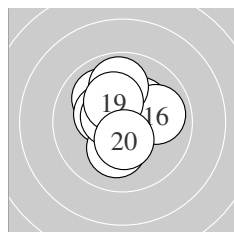

Serie 2:  
 10.3 \* 10.0 ↖ 10.7 \* 10.3 \* 10.2 \*  
 9.9 → 9.9 ↑ 10.5 \* 10.3 \* 10.4 \*  
 beste Teiler 52.6 (13.) 102.0 (18.) 132.4 (20.)  
 Trefferlage 0.16 mm links, 0.49 mm hoch  
 Streuwert 1.33, horizontal: 1.24, vertikal: 1.41

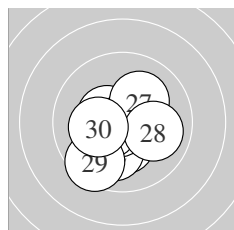

Serie 3:  
 10.3 \* 10.0 ↓ 10.4 \* 10.6 \* 10.7 \*  
 10.5 \* 10.1 ↗ 10.0 → 9.5 ↙ 10.2 \*  
 beste Teiler 51.0 (25.) 80.9 (24.) 119.5 (26.)  
 Trefferlage 0.27 mm links, 0.62 mm tief  
 Streuwert 1.37, horizontal: 1.40, vertikal: 1.34

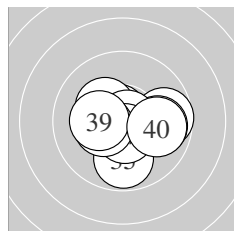

Serie 4:  
 10.7 \* 9.7 → 9.9 → 10.3 \* 9.8 ↓  
 10.8 \* 10.6 \* 10.4 \* 10.3 \* 9.9 →  
 beste Teiler 33.9 (36.) 67.2 (31.) 95.7 (37.)  
 Trefferlage 0.39 mm rechts, 0.30 mm tief  
 Streuwert 1.46, horizontal: 1.78, vertikal: 1.04

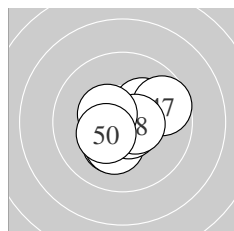

Serie 5:  
 10.2 \* 10.2 \* 10.5 \* 10.7 \* 10.9 \*  
 10.2 \* 9.7 → 10.6 \* 10.4 \* 10.4 \*  
 beste Teiler 6.4 (45.) 69.4 (44.) 96.3 (48.)  
 Trefferlage 0.30 mm rechts, 0.15 mm tief  
 Streuwert 1.19, horizontal: 1.34, vertikal: 1.01

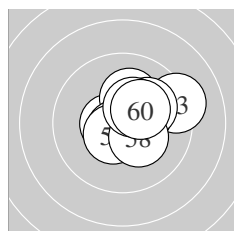

Serie 6:  
 10.6 \* 10.2 \* 9.2 → 10.7 \* 10.5 \*  
 10.3 \* 10.1 ↗ 10.3 \* 10.4 \* 10.3 \*  
 beste Teiler 70.7 (54.) 98.1 (51.) 109.9 (55.)  
 Trefferlage 0.90 mm rechts, 0.48 mm hoch  
 Streuwert 1.27, horizontal: 1.47, vertikal: 1.04

Meyton Elektronik

**ISSF AR Women Jun – Wertung – Juniorinnen**

StandNr: 144

**Mayr, Carmen #16**

**StartNr: 46**

19. Januar 2020 9:14

AUT

---

\_\_\_\_\_  
Unterschrift des Schützen

Meyton Elektronik

Ergebnis:	<b>605.8</b>	(578)							
Serien:	100.0	103.3	99.8	101.7	100.6	100.4			
Zähler:	38	22	0	0	0	0	0	0	0
Innenzehner:	32								
weiteste:	499 (2), 424 (42), 417 (30)								
beste Teiler	15.6 (49.)	60.8 (59.)	64.8 (1.)						
Trefferlage	0.20 mm rechts,	0.08 mm hoch							
Streuwert	1.68, horizontal: 1.75, vertikal: 1.61								

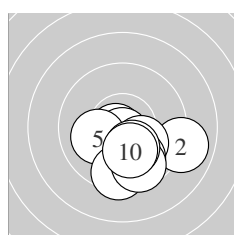
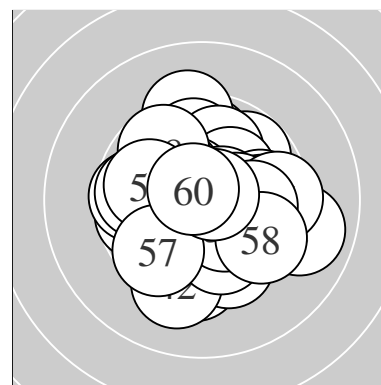

Serie 1:

10.7 *	9.0 →	10.7 *	10.2 *	10.1 ←
9.8 ↘	9.5 ↓	9.6 ↘	10.2 *	10.2 *
beste Teiler	64.8 (1.)	65.0 (3.)	185.6 (9.)	
Trefferlage	0.73 mm rechts, 1.73 mm tief			
Streuwert	1.48, horizontal: 1.78, vertikal: 1.09			

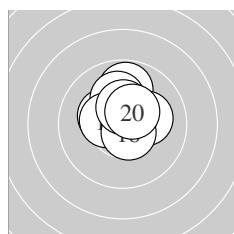

Serie 2:

9.8 ↑	10.2 *	10.5 *	10.3 *	10.1 ↑
10.6 *	10.4 *	10.6 *	10.4 *	10.4 *
beste Teiler	76.2 (16.)	84.6 (18.)	116.3 (13.)	
Trefferlage	0.02 mm rechts, 0.98 mm hoch			
Streuwert	0.98, horizontal: 0.98, vertikal: 0.97			

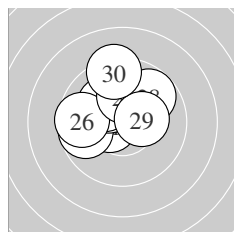

Serie 3:

10.5 *	10.2 *	9.7 ←	10.2 *	10.1 ↘
9.6 ←	10.1 ↑	9.8 ↗	10.3 *	9.3 ↑
beste Teiler	106.7 (21.)	158.9 (29.)	176.6 (24.)	
Trefferlage	0.82 mm links, 1.19 mm hoch			
Streuwert	1.58, horizontal: 1.74, vertikal: 1.41			

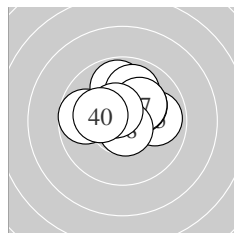

Serie 4:

9.7 ←	9.8 ↑	10.0 ↑	10.5 *	9.9 →
10.2 *	10.2 *	10.7 *	10.5 *	10.2 *
beste Teiler	65.5 (38.)	103.4 (34.)	104.5 (39.)	
Trefferlage	0.00 mm, 0.98 mm hoch			
Streuwert	1.37, horizontal: 1.66, vertikal: 1.00			

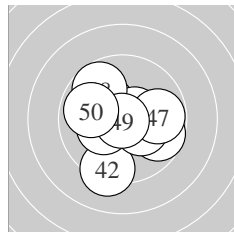

Serie 5:

9.7 →	9.3 ↓	10.2 *	10.5 *	10.3 *
10.3 *	9.8 →	9.7 ↘	10.9 *	9.9 ←
beste Teiler	15.6 (49.)	104.1 (44.)	167.9 (46.)	
Trefferlage	0.03 mm links, 0.18 mm tief			
Streuwert	1.86, horizontal: 1.99, vertikal: 1.72			

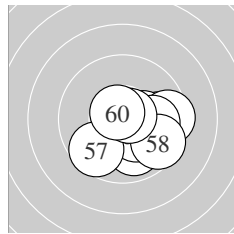

Serie 6:

9.9 ↓	9.8 →	10.3 *	10.3 *	9.5 →
10.0 →	9.6 ↗	9.6 ↘	10.7 *	10.7 *
beste Teiler	60.8 (59.)	68.8 (60.)	167.1 (53.)	
Trefferlage	1.36 mm rechts, 0.73 mm tief			
Streuwert	1.49, horizontal: 1.76, vertikal: 1.15			

Meyton Elektronik

**ISSF AR Women Jun – Wertung – Juniorinnen**

StandNr: 145

**Vanoni, Lorena** #110

**StartNr: 47**

19. Januar 2020 9:39

LIE

---

\_\_\_\_\_  
Unterschrift des Schützen

Meyton Elektronik



Ergebnis:	<b>620.0</b>	(590)					
Serien:	104.6	101.0	102.3	104.2	103.5	104.4	
Zähler:	50	10	0	0	0	0	0
Innenzehner:	45						
weiteste:	475 (14), 377 (36), 301 (20)						
beste Teiler	9.0 (37.) 31.5 (1.) 42.0 (54.)						
Trefferlage	0.17 mm links, 0.00 mm						
Streuwert	1.26, horizontal: 1.39, vertikal: 1.11						

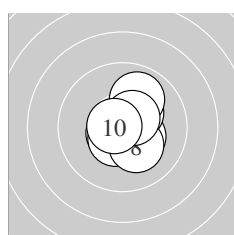
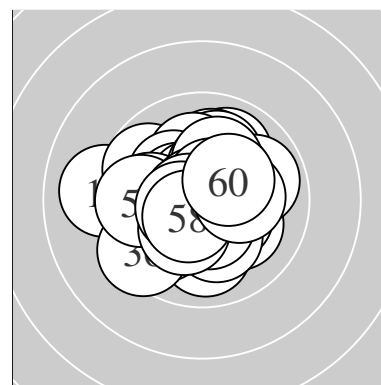

Serie 1:	10.8 *	10.7 *	10.6 *	10.4 *	10.3 *
	10.5 *	9.9 ↗	10.2 *	10.5 *	10.7 *
beste Teiler	31.5 (1.) 67.6 (10.) 73.3 (2.)				
Trefferlage	0.32 mm rechts, 0.01 mm tief				
Streuwert	0.99, horizontal: 0.85, vertikal: 1.12				

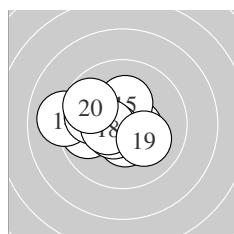

Serie 2:	10.5 *	10.5 *	9.8 ←	9.1 ←	10.3 *
	10.6 *	9.9 ←	10.5 *	10.1 ↘	9.7 ↖
beste Teiler	93.2 (16.) 102.3 (12.) 120.4 (18.)				
Trefferlage	1.14 mm links, 0.02 mm hoch				
Streuwert	1.59, horizontal: 2.01, vertikal: 1.02				

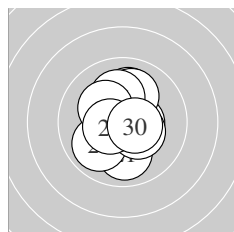

Serie 3:	10.0 ↓	10.5 *	10.1 ↑	10.1 ↑	10.1 ↑
	9.9 ↙	10.2 *	10.4 *	10.5 *	10.5 *
beste Teiler	103.8 (30.) 107.2 (29.) 118.2 (22.)				
Trefferlage	0.00 mm , 0.17 mm hoch				
Streuwert	1.41, horizontal: 1.12, vertikal: 1.64				

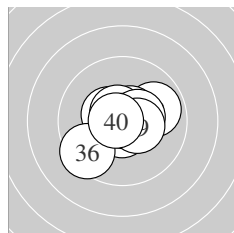

Serie 4:	10.5 *	9.9 →	10.7 *	10.6 *	10.6 *
	9.4 ↙	10.9 *	10.4 *	10.5 *	10.7 *
beste Teiler	9.0 (37.) 55.1 (40.) 74.1 (33.)				
Trefferlage	0.06 mm rechts, 0.04 mm tief				
Streuwert	1.26, horizontal: 1.48, vertikal: 0.99				

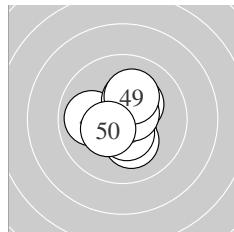

Serie 5:	10.6 *	10.5 *	10.2 *	9.9 ←	10.5 *
	10.3 *	10.3 *	10.6 *	10.2 *	10.4 *
beste Teiler	86.6 (48.) 87.6 (41.) 101.5 (42.)				
Trefferlage	0.04 mm rechts, 0.02 mm tief				
Streuwert	1.18, horizontal: 1.13, vertikal: 1.23				

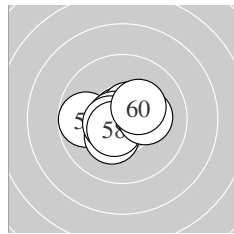

Serie 6:	10.7 *	9.8 ←	10.3 *	10.8 *	10.6 *
	10.7 *	10.5 *	10.5 *	10.2 *	10.3 *
beste Teiler	42.0 (54.) 64.0 (56.) 71.0 (51.)				
Trefferlage	0.34 mm links, 0.08 mm tief				
Streuwert	1.07, horizontal: 1.33, vertikal: 0.71				

Meyton Elektronik

**ISSF AR Women Jun – Wertung – Juniorinnen**

**StartNr: 48**

StandNr: 146

19. Januar 2020 9:53

**Arolfo, Angela #324**

ARG

---

\_\_\_\_\_  
Unterschrift des Schützen

Meyton Elektronik

Ergebnis:	<b>614.2</b>	(583)
Serien:	103.6	102.3 102.9 101.8 101.2 102.4
Zähler:	43	17 0 0 0 0 0 0 0 0
Innenzehner:	39	
weiteste:	415	(22), 393 (55), 363 (49)
beste Teiler	25.4	(2.) 27.2 (25.) 28.0 (26.)
Trefferlage	0.52 mm	rechts, 0.62 mm hoch
Streuwert	1.33,	horizontal: 1.56, vertikal: 1.04

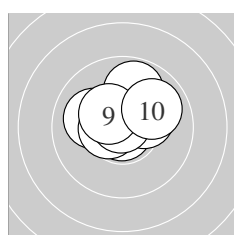
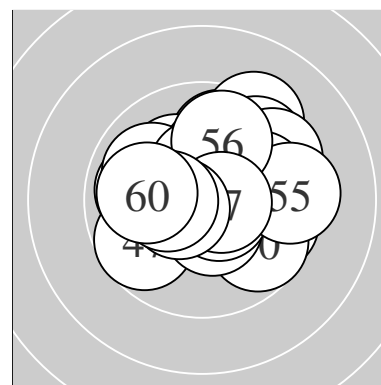

Serie 1:	10.4 *	10.9 *	10.1 ↖	10.5 *	10.3 *
	9.8 ↗	10.5 *	10.8 *	10.4 *	9.9 ↗
beste Teiler	25.4	(2.) 35.1 (8.)	105.4 (7.)		
Trefferlage	0.11 mm	rechts, 0.80 mm hoch			
Streuwert	1.10,	horizontal: 1.32, vertikal: 0.83			

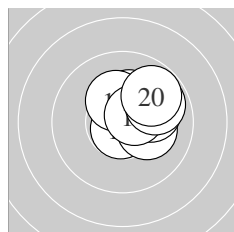

Serie 2:	10.8 *	10.2 *	10.2 *	10.2 *	10.3 *
	10.1 ↗	10.3 *	10.5 *	9.9 ↗	9.8 ↗
beste Teiler	50.0	(11.) 103.0 (18.)	166.9 (17.)		
Trefferlage	1.25 mm	rechts, 0.79 mm hoch			
Streuwert	0.94,	horizontal: 1.02, vertikal: 0.85			

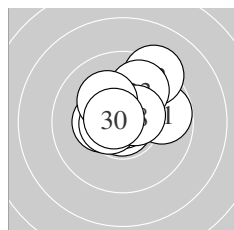

Serie 3:	9.8 ↗	9.3 ↗	9.9 ↗	10.3 *	10.8 *
	10.8 *	10.6 *	10.5 *	10.2 *	10.7 *
beste Teiler	27.2	(25.) 28.0 (26.)	70.0 (30.)		
Trefferlage	0.30 mm	rechts, 0.86 mm hoch			
Streuwert	1.37,	horizontal: 1.50, vertikal: 1.22			

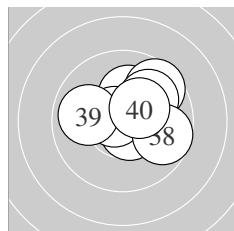

Serie 4:	10.2 *	10.2 *	10.6 *	10.6 *	9.6 ↗
	10.0 ↗	10.7 *	9.7 ↘	9.9 ↖	10.3 *
beste Teiler	68.8	(37.) 85.4 (34.)	90.8 (33.)		
Trefferlage	0.89 mm	rechts, 0.68 mm hoch			
Streuwert	1.36,	horizontal: 1.60, vertikal: 1.06			

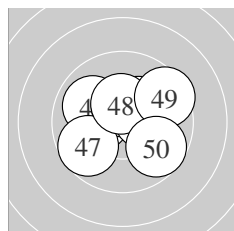

Serie 5:	10.6 *	10.3 *	10.3 *	9.9 ↖	10.5 *
	10.3 *	9.7 ↖	10.4 *	9.5 ↗	9.7 ↘
beste Teiler	99.8	(41.) 116.2 (45.)	135.5 (48.)		
Trefferlage	0.18 mm	rechts, 0.44 mm hoch			
Streuwert	1.65,	horizontal: 1.94, vertikal: 1.28			

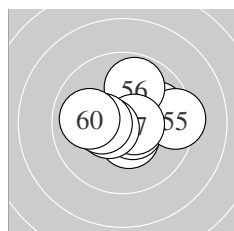

Serie 6:	10.8 *	10.5 *	9.9 ↗	10.6 *	9.4 →
	9.8 ↗	10.6 *	10.5 *	10.3 *	10.0 ↖
beste Teiler	40.1	(51.) 86.7 (57.)	89.3 (54.)		
Trefferlage	0.40 mm	rechts, 0.17 mm hoch			
Streuwert	1.51,	horizontal: 1.88, vertikal: 1.01			

Meyton Elektronik

**ISSF AR Women Jun – Wertung – Juniorinnen**

StandNr: 102

**Wachtler, Manuela** #225

**StartNr: 51**

19. Januar 2020 11:07

T – SG Fügenberg

---

\_\_\_\_\_  
Unterschrift des Schützen

Meyton Elektronik

Ergebnis: **613.2** (584)  
 Serien: 98.4 103.4 102.7 103.8 104.0 100.9  
 Zähler: 45 14 1 0 0 0 0 0 0  
 Innenzehner: 38  
 weiteste: 553 (2), 413 (6), 376 (19)  
 beste Teiler 12.6 (13.) 39.5 (21.) 49.2 (49.)  
 Trefferlage 0.41 mm rechts, 0.10 mm hoch  
 Streuwert 1.47, horizontal: 1.70, vertikal: 1.20

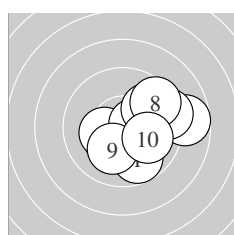
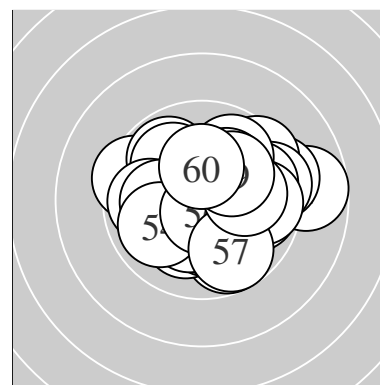

Serie 1:  
 9.8 ↘                      8.7 →                      10.3 \*                      10.3 \*                      10.5 \*  
 9.3 →                      9.9 ↗                      9.5 ↗                      10.1 ↓                      10.0 ↘  
 beste Teiler 107.0 (5.) 163.3 (3.) 167.3 (4.)  
 Trefferlage 1.54 mm rechts, 0.13 mm tief  
 Streuwert 1.97, horizontal: 2.30, vertikal: 1.58

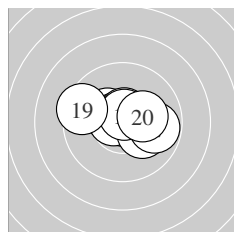

Serie 2:  
 10.3 \*                      10.7 \*                      10.9 \*                      10.6 \*                      10.2 \*  
 10.6 \*                      9.8 →                      10.7 \*                      9.4 ←                      10.2 \*  
 beste Teiler 12.6 (13.) 64.6 (12.) 66.7 (18.)  
 Trefferlage 0.04 mm rechts, 0.31 mm hoch  
 Streuwert 1.35, horizontal: 1.81, vertikal: 0.63

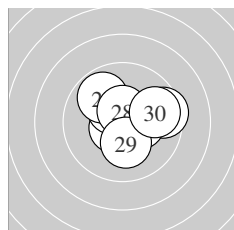

Serie 3:  
 10.8 \*                      10.6 \*                      9.5 →                      10.4 \*                      10.4 \*  
 10.6 \*                      9.8 ↘                      10.6 \*                      10.2 \*                      9.8 →  
 beste Teiler 39.5 (21.) 87.0 (22.) 89.6 (26.)  
 Trefferlage 0.59 mm rechts, 0.42 mm hoch  
 Streuwert 1.39, horizontal: 1.65, vertikal: 1.08

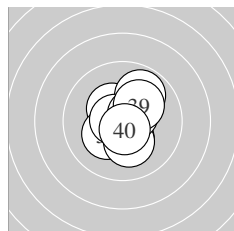

Serie 4:  
 10.3 \*                      10.7 \*                      10.4 \*                      10.2 \*                      10.2 \*  
 9.9 ↗                      10.7 \*                      10.5 \*                      10.2 \*                      10.7 \*  
 beste Teiler 67.8 (37.) 72.8 (32.) 74.2 (40.)  
 Trefferlage 0.27 mm rechts, 0.06 mm hoch  
 Streuwert 1.18, horizontal: 0.98, vertikal: 1.35

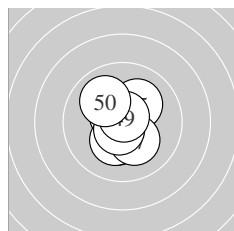

Serie 5:  
 10.6 \*                      10.6 \*                      10.3 \*                      10.4 \*                      10.1 ↗  
 10.3 \*                      10.2 \*                      10.7 \*                      10.8 \*                      10.0 ↘  
 beste Teiler 49.2 (49.) 72.9 (48.) 79.0 (42.)  
 Trefferlage 0.03 mm links, 0.08 mm hoch  
 Streuwert 1.13, horizontal: 0.89, vertikal: 1.32

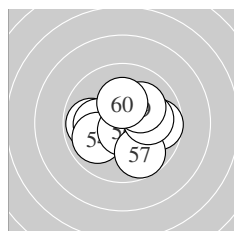

Serie 6:  
 10.7 \*                      9.8 ←                      10.1 ←                      9.9 ↙                      9.7 →  
 10.7 \*                      9.7 ↘                      10.0 →                      10.1 ↗                      10.2 \*  
 beste Teiler 53.6 (51.) 64.0 (56.) 177.0 (60.)  
 Trefferlage 0.08 mm rechts, 0.15 mm tief  
 Streuwert 1.68, horizontal: 2.02, vertikal: 1.24

Meyton Elektronik

**ISSF AR Women Jun – Wertung – Juniorinnen**

StandNr: 103

**Kocher, Jennifer** #339

**StartNr: 52**

19. Januar 2020 11:53

SUI

---

\_\_\_\_\_  
Unterschrift des Schützen

Meyton Elektronik

Ergebnis: **608.3** (583)

Serien: 103.5 103.0 101.5 101.3 101.0 98.0

Zähler: 45 13 2 0 0 0 0 0 0

Innenzehner: 39

weiteste: 570 (26), 551 (55), 500 (53)

beste Teiler 25.6 (1.) 33.8 (49.) 48.6 (41.)

Trefferlage 0.61 mm rechts, 0.35 mm tief

Streuwert 1.60, horizontal: 1.69, vertikal: 1.51

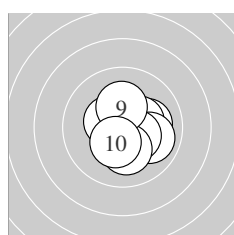
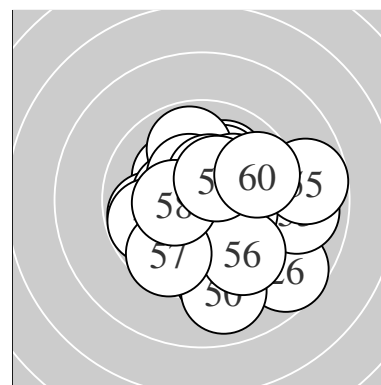

Serie 1:

10.9 *	10.1 →	10.4 *	10.0 ↘	10.4 *
10.5 *	10.2 *	10.4 *	10.2 *	10.4 *

beste Teiler 25.6 (1.) 108.8 (6.) 127.2 (8.)

Trefferlage 0.45 mm rechts, 0.17 mm tief

Streuwert 1.17, horizontal: 1.25, vertikal: 1.08

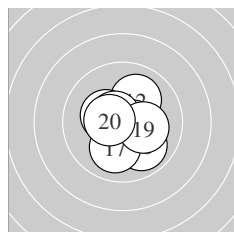

Serie 2:

10.5 *	10.1 ↗	10.6 *	10.3 *	10.3 *
9.9 ↘	10.0 ↓	10.6 *	10.2 *	10.5 *

beste Teiler 81.8 (18.) 91.0 (13.) 106.2 (11.)

Trefferlage 0.37 mm rechts, 0.18 mm tief

Streuwert 1.24, horizontal: 1.23, vertikal: 1.25

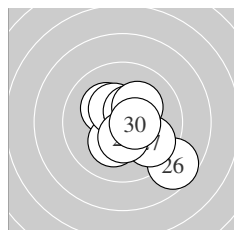

Serie 3:

10.2 *	10.2 *	10.6 *	10.4 *	10.5 *
8.7 ↘	9.8 ↘	10.2 *	10.4 *	10.5 *

beste Teiler 88.6 (23.) 108.6 (30.) 110.6 (25.)

Trefferlage 0.75 mm rechts, 0.32 mm tief

Streuwert 1.69, horizontal: 1.71, vertikal: 1.67

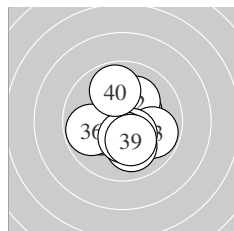

Serie 4:

10.4 *	10.2 *	9.8 ↘	10.4 *	10.2 *
9.8 ←	10.0 ↓	10.4 *	10.2 *	9.9 ↑

beste Teiler 138.1 (34.) 142.2 (38.) 143.7 (31.)

Trefferlage 0.19 mm rechts, 0.37 mm tief

Streuwert 1.57, horizontal: 1.57, vertikal: 1.57

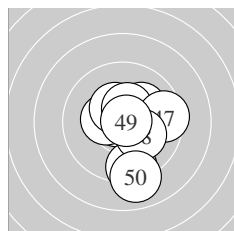

Serie 5:

10.8 *	10.4 *	10.4 *	10.1 ↗	10.4 *
9.4 ↓	9.5 →	10.2 *	10.8 *	9.0 ↓

beste Teiler 33.8 (49.) 48.6 (41.) 126.4 (45.)

Trefferlage 0.68 mm rechts, 0.52 mm tief

Streuwert 1.82, horizontal: 1.43, vertikal: 2.15

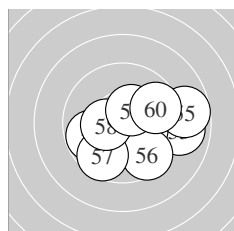

Serie 6:

9.8 ←	10.6 *	9.0 →	10.2 *	8.7 →
9.6 ↘	9.6 ↙	10.4 *	10.4 *	9.7 →

beste Teiler 99.2 (52.) 135.3 (59.) 144.7 (58.)

Trefferlage 1.22 mm rechts, 0.56 mm tief

Streuwert 2.20, horizontal: 2.75, vertikal: 1.46

**ISSF AR Women Jun – Wertung – Juniorinnen**

StandNr: 104

**Baumgartner, Marlene #68**

**StartNr: 53**

19. Januar 2020 11:52

OOE – Priv. SG Enns

---

\_\_\_\_\_  
Unterschrift des Schützen

Meyton Elektronik



Ergebnis: **624.0** (593)<sup>QF</sup>  
 Serien: 103.7 103.1 103.8 105.6 102.0 105.8  
 Zähler: 53 7 0 0 0 0 0 0 0  
 Innenzehner: 48  
 weiteste: 437 (46), 307 (49), 303 (42)  
 beste Teiler 24.3 (39.) 34.0 (33.) 39.8 (10.)  
 Trefferlage 0.15 mm links, 0.04 mm tief  
 Streuwert 1.14, horizontal: 1.24, vertikal: 1.04

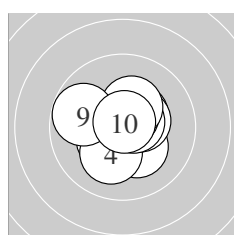
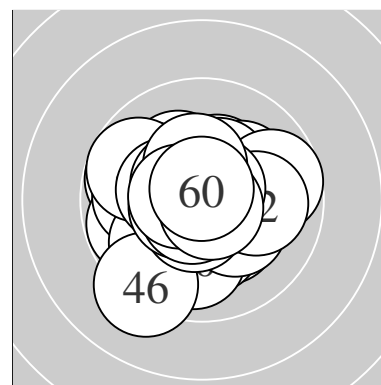

Serie 1:  
 10.4 \* 10.4 \* 10.3 \* 10.1 ↘ 10.4 \*  
 10.6 \* 10.6 \* 10.3 \* 9.8 ↖ 10.8 \*  
 beste Teiler 39.8 (10.) 86.7 (6.) 90.8 (7.)  
 Trefferlage 0.04 mm rechts, 0.11 mm hoch  
 Streuwert 1.19, horizontal: 1.27, vertikal: 1.09

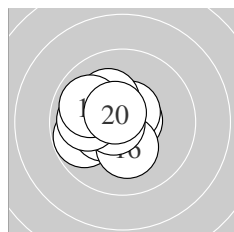

Serie 2:  
 10.7 \* 10.6 \* 10.2 \* 9.8 ↖ 10.4 \*  
 10.2 \* 10.7 \* 10.0 ← 9.9 ↖ 10.6 \*  
 beste Teiler 62.9 (11.) 65.1 (17.) 85.4 (12.)  
 Trefferlage 0.97 mm links, 0.09 mm hoch  
 Streuwert 1.14, horizontal: 1.25, vertikal: 1.02

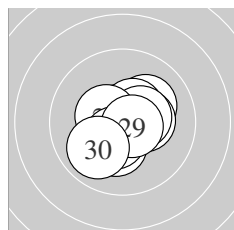

Serie 3:  
 10.1 ↗ 10.3 \* 10.7 \* 10.5 \* 10.4 \*  
 10.5 \* 10.3 \* 10.4 \* 10.7 \* 9.9 ↙  
 beste Teiler 53.7 (23.) 73.4 (29.) 115.1 (24.)  
 Trefferlage 0.16 mm rechts, 0.14 mm tief  
 Streuwert 1.12, horizontal: 1.18, vertikal: 1.05

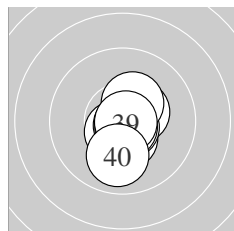

Serie 4:  
 10.6 \* 10.5 \* 10.8 \* 10.5 \* 10.4 \*  
 10.7 \* 10.8 \* 10.4 \* 10.9 \* 10.0 ↓  
 beste Teiler 24.3 (39.) 34.0 (33.) 49.7 (37.)  
 Trefferlage 0.30 mm rechts, 0.28 mm tief  
 Streuwert 0.85, horizontal: 0.49, vertikal: 1.09

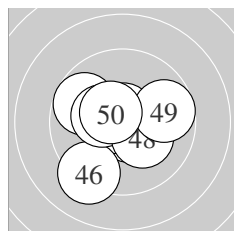

Serie 5:  
 10.7 \* 9.7 ↖ 10.6 \* 10.4 \* 10.7 \*  
 9.2 ↙ 10.3 \* 10.2 \* 9.7 → 10.5 \*  
 beste Teiler 56.2 (41.) 72.0 (45.) 82.8 (43.)  
 Trefferlage 0.45 mm links, 0.11 mm tief  
 Streuwert 1.59, horizontal: 1.75, vertikal: 1.42

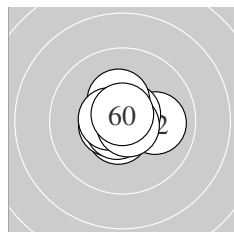

Serie 6:  
 10.6 \* 10.0 → 10.6 \* 10.7 \* 10.7 \*  
 10.8 \* 10.3 \* 10.6 \* 10.7 \* 10.8 \*  
 beste Teiler 41.7 (56.) 48.0 (60.) 51.0 (59.)  
 Trefferlage 0.00 mm, 0.07 mm hoch  
 Streuwert 0.81, horizontal: 0.94, vertikal: 0.66

Meyton Elektronik

**ISSF AR Women Jun – Wertung – Juniorinnen**

StandNr: 105

**Mainetti, Giulia #175**

**StartNr: 54**

19. Januar 2020 11:47

ITA – Accademia

---

QF – Schütze hat sich fürs Finale qualifiziert

\_\_\_\_\_  
Unterschrift des Schützen

Meyton Elektronik

Ergebnis: **618.7** (592)

Serien: 104.6 103.9 102.1 104.3 102.0 101.8

Zähler: 52 8 0 0 0 0 0 0 0

Innenzehner: 46

weiteste: 456 (26), 455 (60), 374 (49)

beste Teiler 9.0 (9.) 14.3 (43.) 47.1 (21.)

Trefferlage 0.07 mm links, 0.31 mm hoch

Streuwert 1.29, horizontal: 1.52, vertikal: 1.00

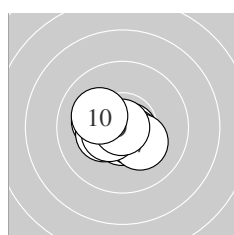
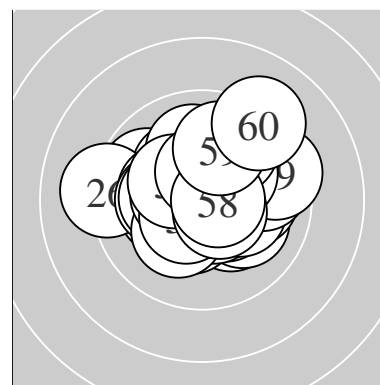

Serie 1:

10.7 *	10.6 *	10.2 *	10.3 *	10.6 *
10.5 *	10.2 *	10.5 *	10.9 *	10.1 ↘

beste Teiler 9.0 (9.) 59.6 (1.) 80.2 (5.)

Trefferlage 0.46 mm links, 0.26 mm tief

Streuwert 0.92, horizontal: 1.14, vertikal: 0.63

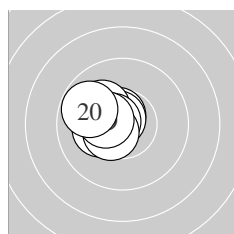

Serie 2:

10.6 *	10.5 *	10.2 *	10.5 *	10.7 *
10.1 ↘	10.6 *	10.5 *	10.4 *	9.8 ↘

beste Teiler 58.0 (15.) 79.7 (11.) 81.7 (17.)

Trefferlage 1.20 mm links, 0.30 mm hoch

Streuwert 0.66, horizontal: 0.68, vertikal: 0.64

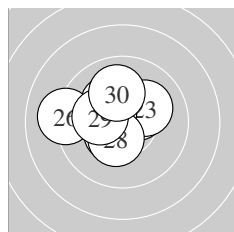

Serie 3:

10.8 *	10.4 *	10.1 ↗	10.2 *	10.5 *
9.1 ←	10.4 *	10.4 *	10.2 *	10.0 ↑

beste Teiler 47.1 (21.) 123.7 (25.) 133.9 (27.)

Trefferlage 0.76 mm links, 0.55 mm hoch

Streuwert 1.42, horizontal: 1.71, vertikal: 1.05

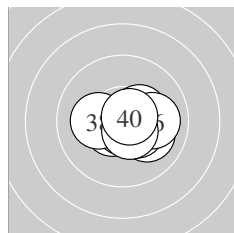

Serie 4:

10.1 ↘	10.6 *	10.4 *	10.6 *	10.4 *
10.0 →	10.7 *	10.2 *	10.6 *	10.7 *

beste Teiler 51.4 (37.) 64.6 (40.) 82.7 (34.)

Trefferlage 0.59 mm rechts, 0.21 mm tief

Streuwert 0.98, horizontal: 1.26, vertikal: 0.57

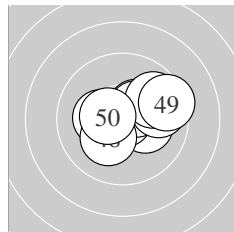

Serie 5:

10.3 *	10.2 *	10.9 *	10.4 *	10.4 *
9.8 →	9.8 ↗	10.2 *	9.5 →	10.5 *

beste Teiler 14.3 (43.) 121.2 (50.) 135.2 (45.)

Trefferlage 0.88 mm rechts, 0.37 mm hoch

Streuwert 1.44, horizontal: 1.83, vertikal: 0.89

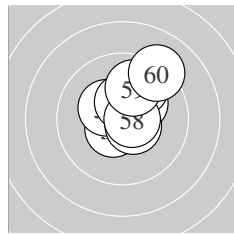

Serie 6:

10.5 *	10.5 *	10.3 *	10.2 *	9.8 ↗
10.4 *	10.5 *	10.6 *	9.9 ↑	9.1 ↗

beste Teiler 76.0 (58.) 102.3 (57.) 110.1 (51.)

Trefferlage 0.50 mm rechts, 1.14 mm hoch

Streuwert 1.33, horizontal: 1.23, vertikal: 1.42

Meyton Elektronik

**ISSF AR Women Jun – Wertung – Juniorinnen**

**StartNr: 55**

StandNr: 106

19. Januar 2020 11:27

**Tan, Natanya Hui Yi #346**

SGP

---

\_\_\_\_\_  
Unterschrift des Schützen

Meyton Elektronik

Ergebnis:	<b>629.4</b>	(597) <sup>QF</sup>							
Serien:	105.1	104.8	104.7	105.5	105.4	103.9			
Zähler:	57	3	0	0	0	0	0	0	0
Innenzehner:	52								
weiteste:	316 (53), 315 (56), 269 (4)								
beste Teiler	15.6 (40.)	16.1 (34.)	18.0 (54.)						
Trefferlage	0.08 mm links, 0.37 mm hoch								
Streuwert	0.94, horizontal: 0.99, vertikal: 0.89								

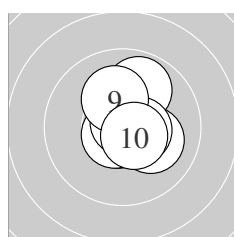
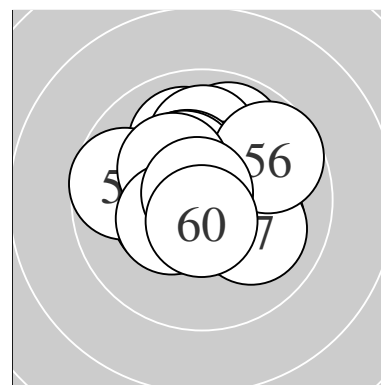

Serie 1:

10.7 *	10.1 ↘	10.8 *	9.9 ↗	10.8 *
10.7 *	10.8 *	10.5 *	10.2 *	10.6 *
beste Teiler	26.1 (5.)	33.7 (7.)	50.9 (3.)	
Trefferlage	0.40 mm rechts, 0.16 mm hoch			
Streuwert	0.97, horizontal: 0.79, vertikal: 1.12			

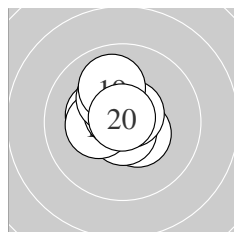

Serie 2:

10.8 *	10.4 *	10.7 *	10.3 *	10.6 *
10.3 *	10.7 *	10.2 *	10.0 ↑	10.8 *
beste Teiler	31.4 (20.)	44.7 (11.)	65.1 (13.)	
Trefferlage	0.39 mm links, 0.40 mm hoch			
Streuwert	0.90, horizontal: 0.84, vertikal: 0.96			

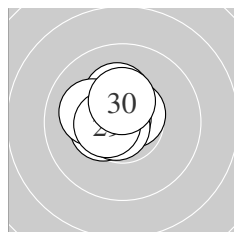

Serie 3:

10.3 *	10.7 *	10.6 *	10.4 *	10.8 *
10.7 *	10.2 *	10.1 ↖	10.5 *	10.4 *
beste Teiler	41.6 (25.)	52.2 (26.)	69.2 (22.)	
Trefferlage	0.65 mm links, 0.47 mm hoch			
Streuwert	0.75, horizontal: 0.81, vertikal: 0.69			

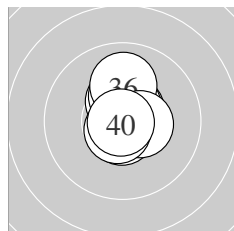

Serie 4:

10.6 *	10.4 *	10.5 *	10.9 *	10.3 *
10.0 ↑	10.7 *	10.5 *	10.7 *	10.9 *
beste Teiler	15.6 (40.)	16.1 (34.)	68.9 (39.)	
Trefferlage	0.14 mm rechts, 0.54 mm hoch			
Streuwert	0.79, horizontal: 0.44, vertikal: 1.03			

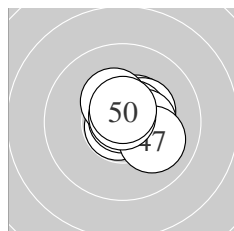

Serie 5:

10.5 *	10.8 *	10.4 *	10.6 *	10.9 *
10.4 *	10.0 ↘	10.4 *	10.8 *	10.6 *
beste Teiler	18.6 (45.)	38.1 (49.)	43.8 (42.)	
Trefferlage	0.52 mm rechts, 0.33 mm hoch			
Streuwert	0.78, horizontal: 0.84, vertikal: 0.72			

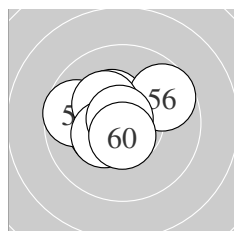

Serie 6:

10.4 *	10.3 *	9.7 ↖	10.9 *	10.8 *
9.7 ↗	10.3 *	10.4 *	10.8 *	10.6 *
beste Teiler	18.0 (54.)	32.4 (55.)	34.4 (59.)	
Trefferlage	0.53 mm links, 0.31 mm hoch			
Streuwert	1.21, horizontal: 1.45, vertikal: 0.91			

Meyton Elektronik

QF – Schütze hat sich fürs Finale qualifiziert

\_\_\_\_\_  
Unterschrift des Schützen

Meyton Elektronik

Ergebnis: **620.9** (591)  
 Serien: 100.7 104.1 103.4 103.9 104.8 104.0  
 Zähler: 51 9 0 0 0 0 0 0 0  
 Innenzehner: 46  
 weiteste: 428 (9), 363 (30), 301 (3)  
 beste Teiler 12.1 (35.) 13.4 (41.) 39.6 (49.)  
 Trefferlage 0.08 mm links, 0.03 mm tief  
 Streuwert 1.24, horizontal: 1.47, vertikal: 0.96

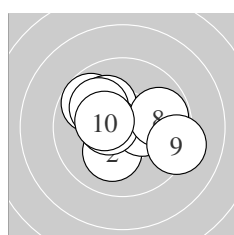
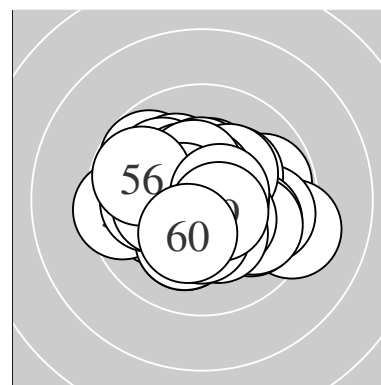

Serie 1:  
 10.4 \* 10.2 \* 9.7 ↘ 10.4 \* 10.1 ↘  
 10.0 ↙ 10.5 \* 9.8 → 9.2 → 10.4 \*  
 beste Teiler 105.0 (7.) 144.8 (10.) 147.6 (1.)  
 Trefferlage 0.08 mm links, 0.19 mm hoch  
 Streuwert 1.77, horizontal: 2.12, vertikal: 1.32

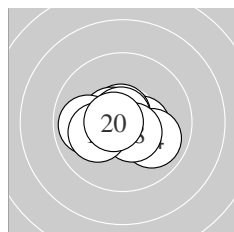

Serie 2:  
 10.4 \* 10.7 \* 10.6 \* 9.9 ↘ 10.5 \*  
 9.9 ← 10.8 \* 10.5 \* 10.1 ← 10.7 \*  
 beste Teiler 42.7 (17.) 64.5 (12.) 68.0 (20.)  
 Trefferlage 0.30 mm links, 0.21 mm tief  
 Streuwert 1.11, horizontal: 1.45, vertikal: 0.60

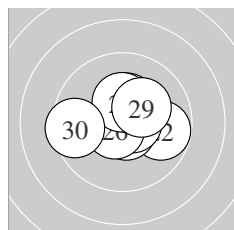

Serie 3:  
 10.7 \* 9.8 → 10.7 \* 10.4 \* 10.7 \*  
 10.6 \* 10.4 \* 10.4 \* 10.2 \* 9.5 ←  
 beste Teiler 68.9 (23.) 72.4 (25.) 73.4 (21.)  
 Trefferlage 0.22 mm rechts, 0.37 mm hoch  
 Streuwert 1.34, horizontal: 1.65, vertikal: 0.93

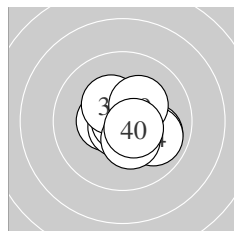

Serie 4:  
 10.0 → 10.4 \* 10.7 \* 9.9 ↘ 10.9 \*  
 10.4 \* 10.3 \* 10.4 \* 10.3 \* 10.6 \*  
 beste Teiler 12.1 (35.) 58.8 (33.) 99.8 (40.)  
 Trefferlage 0.56 mm rechts, 0.09 mm tief  
 Streuwert 1.11, horizontal: 1.23, vertikal: 0.98

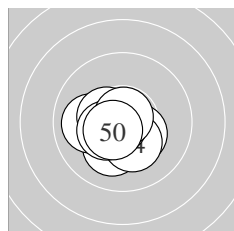

Serie 5:  
 10.9 \* 10.2 \* 10.4 \* 10.3 \* 10.0 ←  
 10.8 \* 10.4 \* 10.4 \* 10.8 \* 10.6 \*  
 beste Teiler 13.4 (41.) 39.6 (49.) 42.4 (46.)  
 Trefferlage 0.48 mm links, 0.48 mm tief  
 Streuwert 0.90, horizontal: 1.02, vertikal: 0.76

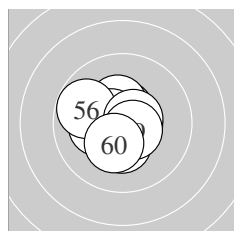

Serie 6:  
 10.6 \* 10.4 \* 10.6 \* 10.2 \* 10.6 \*  
 9.8 ↘ 10.3 \* 10.6 \* 10.6 \* 10.3 \*  
 beste Teiler 78.4 (53.) 85.0 (58.) 92.6 (59.)  
 Trefferlage 0.41 mm links, 0.01 mm hoch  
 Streuwert 1.10, horizontal: 1.17, vertikal: 1.01

Meyton Elektronik

**ISSF AR Women Jun – Wertung – Juniorinnen**

StandNr: 108

**Brabcova, Karolina** #338

**StartNr: 57**

19. Januar 2020 11:42

CZE

---

\_\_\_\_\_  
Unterschrift des Schützen

Meyton Elektronik



Ergebnis:	<b>625.9</b>	(595) <sup>QF</sup>							
Serien:	103.6	104.4	102.8	105.4	105.3	104.4			
Zähler:	55	5	0	0	0	0	0	0	0
Innenzehner:	50								
weiteste:	342 (51), 288 (23), 283 (4)								
beste Teiler	14.3 (36.) 19.9 (19.) 24.1 (57.)								
Trefferlage	0.12 mm rechts, 0.22 mm hoch								
Streuwert	1.06, horizontal: 0.92, vertikal: 1.18								

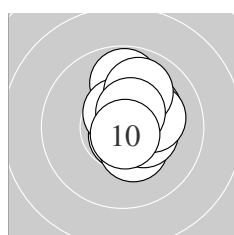
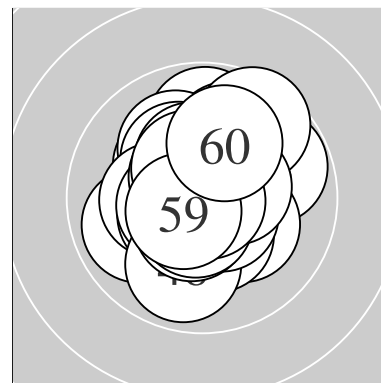

Serie 1:	10.7 *	10.4 *	10.2 *	9.8 ↑	10.6 *
	10.4 *	10.2 *	10.0 ↑	10.5 *	10.8 *
beste Teiler	47.7 (10.) 53.1 (1.) 98.3 (5.)				
Trefferlage	0.69 mm rechts, 0.60 mm hoch				
Streuwert	1.05, horizontal: 0.73, vertikal: 1.29				

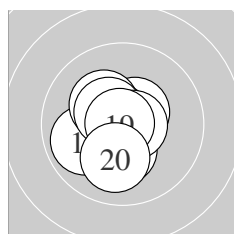

Serie 2:	10.5 *	10.3 *	10.5 *	10.7 *	9.9 ↙
	10.3 *	10.5 *	10.7 *	10.9 *	10.1 ↓
beste Teiler	19.9 (19.) 60.8 (14.) 65.2 (18.)				
Trefferlage	0.51 mm links, 0.11 mm tief				
Streuwert	1.04, horizontal: 0.93, vertikal: 1.13				

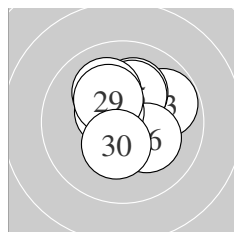

Serie 3:	10.5 *	10.7 *	9.8 ↘	10.1 ↑	10.2 *
	10.2 *	10.1 ↘	10.5 *	10.3 *	10.4 *
beste Teiler	58.1 (22.) 108.4 (28.) 116.7 (21.)				
Trefferlage	0.29 mm rechts, 0.62 mm hoch				
Streuwert	1.23, horizontal: 1.19, vertikal: 1.28				

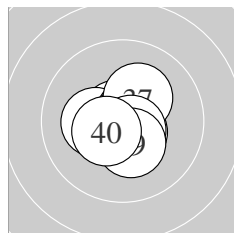

Serie 4:	10.7 *	10.3 *	10.5 *	10.7 *	10.6 *
	10.9 *	10.2 *	10.6 *	10.4 *	10.5 *
beste Teiler	14.3 (36.) 57.3 (31.) 68.0 (34.)				
Trefferlage	0.03 mm rechts, 0.22 mm tief				
Streuwert	0.85, horizontal: 0.86, vertikal: 0.85				

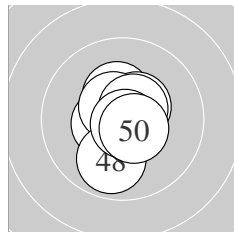

Serie 5:	10.7 *	10.4 *	10.5 *	10.7 *	10.5 *
	10.6 *	10.6 *	9.9 ↓	10.8 *	10.6 *
beste Teiler	36.6 (49.) 54.0 (41.) 56.0 (44.)				
Trefferlage	0.02 mm links, 0.00 mm				
Streuwert	0.93, horizontal: 0.67, vertikal: 1.14				

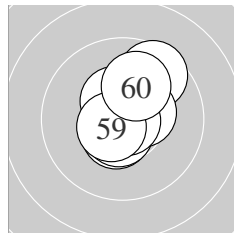

Serie 6:	9.6 ↗	10.8 *	10.5 *	10.5 *	10.6 *
	10.4 *	10.9 *	10.5 *	10.6 *	10.0 ↑
beste Teiler	24.1 (57.) 40.3 (52.) 87.6 (55.)				
Trefferlage	0.24 mm rechts, 0.46 mm hoch				
Streuwert	1.09, horizontal: 0.85, vertikal: 1.29				

Meyton Elektronik

QF – Schütze hat sich fürs Finale qualifiziert

\_\_\_\_\_  
Unterschrift des Schützen

Meyton Elektronik

Ergebnis: **615.9** (586)  
 Serien: 103.5 102.4 103.5 100.4 102.4 103.7  
 Zähler: 46 14 0 0 0 0 0 0 0  
 Innenzehner: 36  
 weiteste: 479 (36), 389 (34), 365 (25)  
 beste Teiler 23.4 (57.) 38.2 (46.) 38.6 (6.)  
 Trefferlage 0.19 mm links, 0.05 mm tief  
 Streuwert 1.43, horizontal: 1.68, vertikal: 1.13

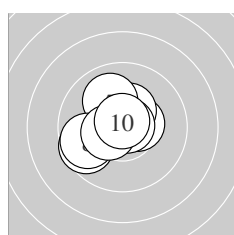
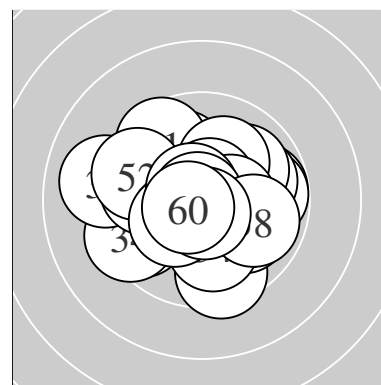

Serie 1:  
 10.5 \* 10.5 \* 10.7 \* 10.4 \* 10.0 ↗  
 10.8 \* 9.6 ← 9.7 ← 10.5 \* 10.8 \*  
 beste Teiler 38.6 (6.) 49.2 (10.) 52.8 (3.)  
 Trefferlage 0.70 mm links, 0.24 mm hoch  
 Streuwert 1.23, horizontal: 1.35, vertikal: 1.08

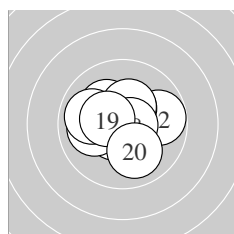

Serie 2:  
 10.6 \* 9.8 → 10.4 \* 10.0 ← 10.2 \*  
 9.9 ← 10.4 \* 10.7 \* 10.4 \* 10.0 ↓  
 beste Teiler 62.6 (18.) 94.7 (11.) 132.1 (19.)  
 Trefferlage 0.24 mm links, 0.23 mm hoch  
 Streuwert 1.41, horizontal: 1.66, vertikal: 1.11

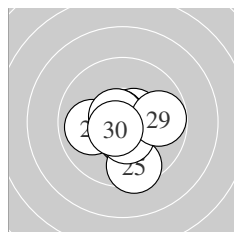

Serie 3:  
 10.0 ← 10.5 \* 10.7 \* 10.5 \* 9.5 ↓  
 10.7 \* 10.7 \* 10.5 \* 9.8 → 10.6 \*  
 beste Teiler 58.6 (26.) 69.4 (27.) 69.6 (23.)  
 Trefferlage 0.20 mm rechts, 0.54 mm tief  
 Streuwert 1.31, horizontal: 1.39, vertikal: 1.23

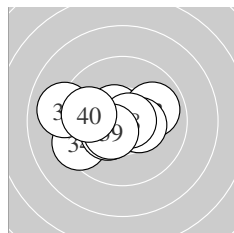

Serie 4:  
 9.8 ← 10.6 \* 9.9 → 9.4 ← 10.3 \*  
 9.0 ← 10.4 \* 10.8 \* 10.4 \* 9.8 ←  
 beste Teiler 50.0 (38.) 96.8 (32.) 127.4 (39.)  
 Trefferlage 1.23 mm links, 0.12 mm tief  
 Streuwert 1.71, horizontal: 2.24, vertikal: 0.90

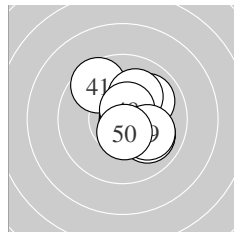

Serie 5:  
 9.6 ↘ 10.0 ↗ 10.1 ↗ 10.0 ↘ 10.0 ↘  
 10.8 \* 10.8 \* 10.6 \* 10.0 ↘ 10.5 \*  
 beste Teiler 38.2 (46.) 43.4 (47.) 84.5 (48.)  
 Trefferlage 0.83 mm rechts, 0.19 mm hoch  
 Streuwert 1.36, horizontal: 1.27, vertikal: 1.45

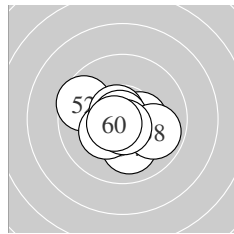

Serie 6:  
 10.6 \* 9.6 ↖ 10.4 \* 10.0 ↓ 10.3 \*  
 10.7 \* 10.9 \* 9.9 ↘ 10.7 \* 10.6 \*  
 beste Teiler 23.4 (57.) 66.0 (59.) 71.4 (56.)  
 Trefferlage 0.03 mm links, 0.36 mm tief  
 Streuwert 1.29, horizontal: 1.55, vertikal: 0.95

Meyton Elektronik

**ISSF AR Women Jun – Wertung – Juniorinnen**

StandNr: 110

**Gabrielli, Nicole #171**

**StartNr: 59**

19. Januar 2020 11:09

ITA – Accademia

---

\_\_\_\_\_  
Unterschrift des Schützen

Meyton Elektronik

Ergebnis: **609.1** (581)  
 Serien: 100.7 102.7 102.0 103.4 100.4 99.9  
 Zähler: 41 19 0 0 0 0 0 0 0  
 Innenzehner: 33  
 weiteste: 426 (4), 422 (54), 402 (55)  
 beste Teiler 35.0 (29.) 53.4 (31.) 61.4 (58.)  
 Trefferlage 0.23 mm links, 0.46 mm hoch  
 Streuwert 1.54, horizontal: 1.68, vertikal: 1.38

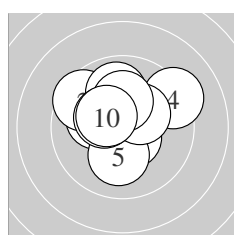
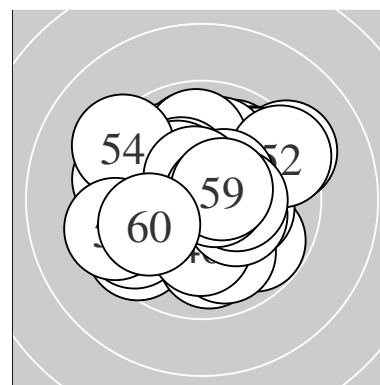

Serie 1:  
 10.1 ↖ 9.6 ↘ 10.6 \* 9.2 ↗ 10.1 ↓  
 9.9 ↑ 10.3 \* 10.2 \* 10.3 \* 10.4 \*  
 beste Teiler 97.4 (3.) 143.6 (10.) 152.5 (9.)  
 Trefferlage 0.25 mm links, 0.88 mm hoch  
 Streuwert 1.64, horizontal: 1.84, vertikal: 1.41

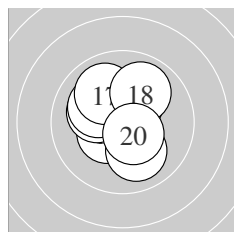

Serie 2:  
 10.7 \* 10.4 \* 10.4 \* 10.1 ↖ 10.6 \*  
 10.1 ↖ 10.0 ↘ 9.9 ↗ 10.0 ↓ 10.5 \*  
 beste Teiler 64.8 (11.) 87.5 (15.) 117.5 (20.)  
 Trefferlage 0.17 mm links, 0.50 mm hoch  
 Streuwert 1.29, horizontal: 1.22, vertikal: 1.36

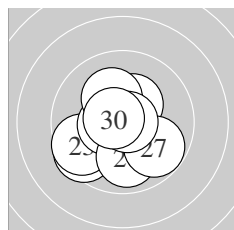

Serie 3:  
 9.5 ↙ 10.4 \* 9.6 ↙ 10.6 \* 10.5 \*  
 9.9 ↓ 9.8 ↘ 10.2 \* 10.8 \* 10.7 \*  
 beste Teiler 35.0 (29.) 70.7 (30.) 86.0 (24.)  
 Trefferlage 0.50 mm links, 0.42 mm tief  
 Streuwert 1.55, horizontal: 1.59, vertikal: 1.51

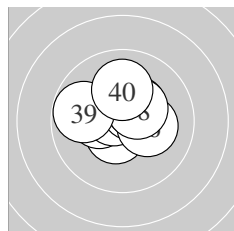

Serie 4:  
 10.7 \* 10.5 \* 10.3 \* 10.6 \* 10.5 \*  
 10.2 \* 10.4 \* 10.4 \* 9.8 ↖ 10.0 ↑  
 beste Teiler 53.4 (31.) 77.1 (34.) 102.0 (32.)  
 Trefferlage 0.16 mm links, 0.55 mm hoch  
 Streuwert 1.16, horizontal: 1.39, vertikal: 0.86

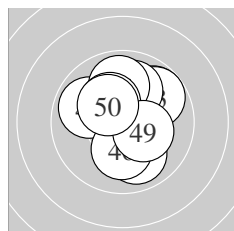

Serie 5:  
 9.9 ↖ 9.8 ↗ 9.8 ↗ 10.0 ↑ 9.9 ↓  
 10.2 \* 9.9 ↑ 10.3 \* 10.3 \* 10.3 \*  
 beste Teiler 164.4 (50.) 165.1 (49.) 166.6 (48.)  
 Trefferlage 0.29 mm rechts, 0.73 mm hoch  
 Streuwert 1.66, horizontal: 1.54, vertikal: 1.76

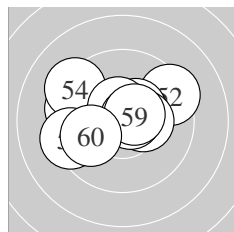

Serie 6:  
 9.5 ↖ 9.4 ↗ 10.4 \* 9.3 ↖ 9.3 ↖  
 10.5 \* 10.3 \* 10.7 \* 10.6 \* 9.9 ↖  
 beste Teiler 61.4 (58.) 98.8 (59.) 104.3 (56.)  
 Trefferlage 0.60 mm links, 0.53 mm hoch  
 Streuwert 1.96, horizontal: 2.51, vertikal: 1.16

Meyton Elektronik

**ISSF AR Women Jun – Wertung – Juniorinnen**

**StartNr: 60**

StandNr: 111

19. Januar 2020 11:46

**Sturny, Kim #340**

SUI

---

\_\_\_\_\_  
Unterschrift des Schützen

Meyton Elektronik

Ergebnis:	<b>614.0</b>	(584)
Serien:	102.5	101.5 103.4 104.2 103.2 99.2
Zähler:	45	14 1 0 0 0 0 0 0 0
Innenzehner:	39	
weiteste:	576	(55), 414 (59), 352 (13)
beste Teiler	15.6	(58.) 35.5 (34.) 37.7 (27.)
Trefferlage	0.15 mm	rechts, 0.07 mm hoch
Streuwert	1.50,	horizontal: 1.74, vertikal: 1.22

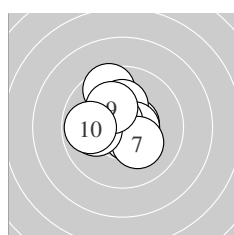
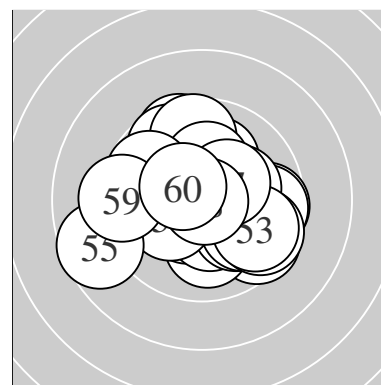

Serie 1:	9.6 ↗	10.6 *	10.2 *	10.6 *	10.6 *
	10.7 *	10.2 *	10.0 ←	10.2 *	9.8 ←
beste Teiler	70.7	(6.) 88.2 (4.) 94.1 (5.)			
Trefferlage	0.40 mm	links, 0.52 mm hoch			
Streuwert	1.38,	horizontal: 1.40, vertikal: 1.36			

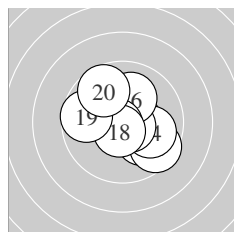

Serie 2:	10.1 ↘	10.5 *	9.5 ↘	9.9 →	10.7 *
	10.1 ↗	10.7 *	10.6 *	9.7 ←	9.7 ↘
beste Teiler	55.1	(17.) 70.3 (15.) 80.9 (18.)			
Trefferlage	0.36 mm	rechts, 0.01 mm tief			
Streuwert	1.66,	horizontal: 1.82, vertikal: 1.49			

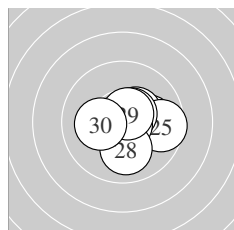

Serie 3:	10.7 *	10.1 →	10.5 *	10.4 *	9.6 →
	10.5 *	10.8 *	10.0 ↓	10.6 *	10.2 *
beste Teiler	37.7	(27.) 56.2 (21.) 83.0 (29.)			
Trefferlage	0.60 mm	rechts, 0.08 mm tief			
Streuwert	1.21,	horizontal: 1.47, vertikal: 0.88			

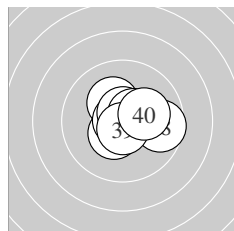

Serie 4:	10.2 *	10.2 *	10.4 *	10.8 *	10.8 *
	10.7 *	10.5 *	9.7 →	10.7 *	10.2 *
beste Teiler	35.5	(34.) 38.6 (35.) 65.0 (39.)			
Trefferlage	0.62 mm	rechts, 0.14 mm hoch			
Streuwert	1.07,	horizontal: 1.31, vertikal: 0.76			

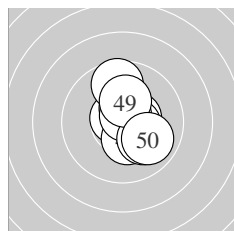

Serie 5:	10.5 *	10.7 *	9.7 ↑	10.5 *	10.5 *
	10.4 *	10.7 *	10.1 ↘	10.2 *	9.9 ↘
beste Teiler	61.3	(47.) 67.7 (42.) 107.4 (45.)			
Trefferlage	0.61 mm	rechts, 0.29 mm hoch			
Streuwert	1.25,	horizontal: 0.89, vertikal: 1.52			

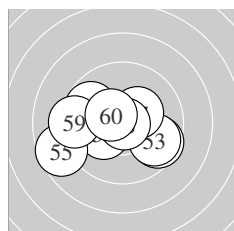

Serie 6:	9.6 ↘	10.4 *	9.7 ↘	10.2 *	8.6 ←
	9.7 ↘	10.3 *	10.9 *	9.3 ←	10.5 *
beste Teiler	15.6	(58.) 120.6 (60.) 132.6 (52.)			
Trefferlage	0.87 mm	links, 0.39 mm tief			
Streuwert	2.12,	horizontal: 2.75, vertikal: 1.19			

**ISSF AR Women Jun – Wertung – Juniorinnen**

StandNr: 112

**Krainz, Anja** #300

**StartNr: 61**

19. Januar 2020 11:45

OÖ – LHA Linz

---

\_\_\_\_\_  
Unterschrift des Schützen

Meyton Elektronik



Ergebnis:	<b>632.8</b>	(598) <sup>QF</sup>
Serien:	105.3	105.3 105.8 106.3 104.7 105.4
Zähler:	58	2 0 0 0 0 0 0 0 0
Innenzehner:	55	
weiteste:	300	(10), 271 (52), 248 (56)
beste Teiler	4.0	(59.) 9.2 (42.) 13.3 (15.)
Trefferlage	0.03 mm links, 0.04 mm tief	
Streuwert	0.88, horizontal: 0.76, vertikal: 1.00	

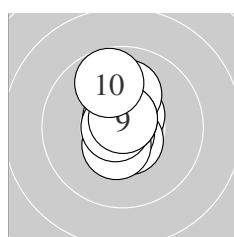
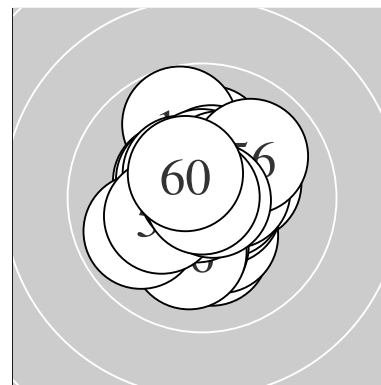

Serie 1:	10.6 *	10.6 *	10.8 *	10.5 *	10.1 ↑
	10.7 *	10.7 *	10.8 *	10.7 *	9.8 ↑
beste Teiler	41.6 (3.) 46.0 (8.) 53.0 (6.)				
Trefferlage	0.10 mm links, 0.49 mm hoch				
Streuwert	0.93, horizontal: 0.43, vertikal: 1.25				

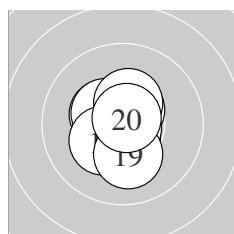

Serie 2:	10.6 *	10.5 *	10.8 *	10.4 *	10.9 *
	10.4 *	10.3 *	10.4 *	10.2 *	10.8 *
beste Teiler	13.3 (15.) 38.8 (13.) 47.7 (20.)				
Trefferlage	0.15 mm links, 0.00 mm				
Streuwert	0.90, horizontal: 0.72, vertikal: 1.04				

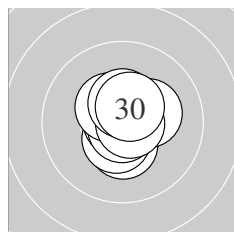

Serie 3:	10.4 *	10.8 *	10.5 *	10.8 *	10.8 *
	10.3 *	10.4 *	10.8 *	10.5 *	10.5 *
beste Teiler	32.0 (24.) 32.3 (22.) 39.1 (25.)				
Trefferlage	0.07 mm rechts, 0.08 mm hoch				
Streuwert	0.79, horizontal: 0.68, vertikal: 0.89				

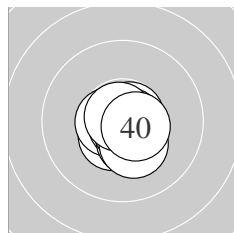

Serie 4:	10.5 *	10.6 *	10.7 *	10.9 *	10.4 *
	10.8 *	10.7 *	10.3 *	10.8 *	10.6 *
beste Teiler	24.0 (34.) 37.5 (39.) 41.9 (36.)				
Trefferlage	0.15 mm rechts, 0.44 mm tief				
Streuwert	0.60, horizontal: 0.57, vertikal: 0.62				

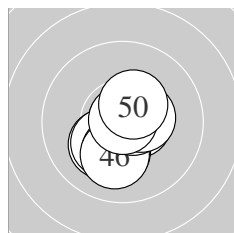

Serie 5:	10.2 *	10.9 *	10.6 *	10.2 *	10.2 *
	10.1 ↓	10.7 *	10.5 *	10.9 *	10.4 *
beste Teiler	9.2 (42.) 14.3 (49.) 68.4 (47.)				
Trefferlage	0.02 mm rechts, 0.51 mm tief				
Streuwert	0.98, horizontal: 0.86, vertikal: 1.09				

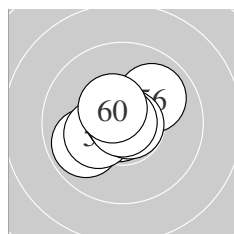

Serie 6:	10.8 *	9.9 ↙	10.3 *	10.6 *	10.8 *
	10.0 ↗	10.8 *	10.8 *	10.9 *	10.5 *
beste Teiler	4.0 (59.) 26.0 (57.) 34.8 (51.)				
Trefferlage	0.17 mm links, 0.12 mm hoch				
Streuwert	1.03, horizontal: 1.19, vertikal: 0.83				

Meyton Elektronik

QF – Schütze hat sich fürs Finale qualifiziert

---

Unterschrift des Schützen

Meyton Elektronik

Ergebnis: **621.6** (592)  
 Serien: 102.2 103.7 103.1 103.8 104.4 104.4  
 Zähler: 52 8 0 0 0 0 0 0 0  
 Innenzehner: 41  
 weiteste: 308 (10), 291 (9), 291 (54)  
 beste Teiler 2.8 (49.) 10.8 (1.) 33.0 (53.)  
 Trefferlage 0.23 mm rechts, 0.31 mm hoch  
 Streuwert 1.18, horizontal: 1.36, vertikal: 0.96

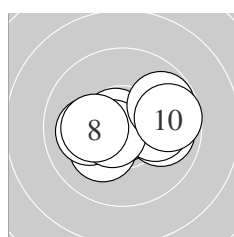
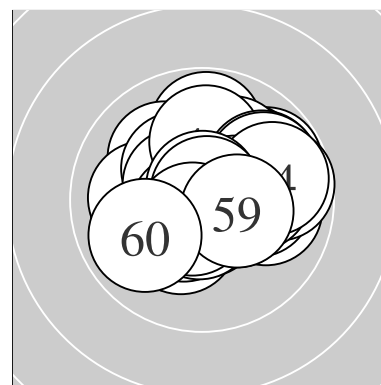

Serie 1:  
 10.9 \*                      10.7 \*                      10.2 \*                      9.9 →                      10.1 →  
 10.1 ←                      10.6 \*                      10.2 \*                      9.8 ↗                      9.7 →  
 beste Teiler 10.8 (1.) 57.4 (2.) 80.4 (7.)  
 Trefferlage 0.37 mm rechts, 0.02 mm tief  
 Streuwert 1.51, horizontal: 2.00, vertikal: 0.73

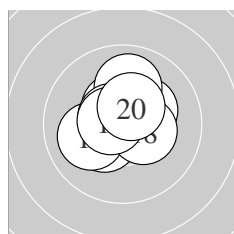

Serie 2:  
 10.5 \*                      10.3 \*                      10.5 \*                      10.1 ←                      10.3 \*  
 10.0 ↑                      10.6 \*                      10.4 \*                      10.6 \*                      10.4 \*  
 beste Teiler 80.0 (19.) 85.7 (17.) 102.6 (11.)  
 Trefferlage 0.08 mm links, 0.48 mm hoch  
 Streuwert 1.09, horizontal: 1.15, vertikal: 1.02

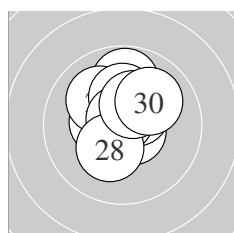

Serie 3:  
 10.4 \*                      9.8 ↑                      10.7 \*                      10.5 \*                      10.1 ↘  
 10.2 \*                      10.8 \*                      10.3 \*                      10.3 \*                      10.0 ↗  
 beste Teiler 43.8 (27.) 74.9 (23.) 123.0 (24.)  
 Trefferlage 0.02 mm rechts, 0.88 mm hoch  
 Streuwert 1.14, horizontal: 1.02, vertikal: 1.25

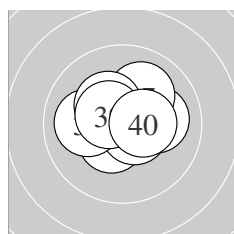

Serie 4:  
 10.6 \*                      10.7 \*                      10.1 →                      10.5 \*                      10.6 \*  
 10.0 ←                      10.1 ↗                      10.3 \*                      10.5 \*                      10.4 \*  
 beste Teiler 54.0 (32.) 90.9 (35.) 91.2 (31.)  
 Trefferlage 0.04 mm links, 0.26 mm hoch  
 Streuwert 1.14, horizontal: 1.36, vertikal: 0.86

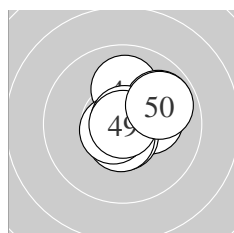

Serie 5:  
 10.8 \*                      10.2 \*                      10.6 \*                      10.0 ↑                      9.9 ↗  
 10.6 \*                      10.7 \*                      10.8 \*                      10.9 \*                      9.9 ↗  
 beste Teiler 2.8 (49.) 33.1 (48.) 37.3 (41.)  
 Trefferlage 0.63 mm rechts, 0.36 mm hoch  
 Streuwert 1.06, horizontal: 1.11, vertikal: 1.01

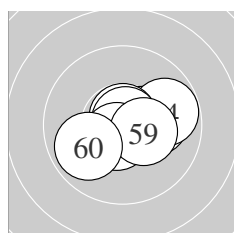

Serie 6:  
 10.1 →                      10.4 \*                      10.8 \*                      9.8 →                      10.8 \*  
 10.8 \*                      10.8 \*                      10.6 \*                      10.4 \*                      9.9 ←  
 beste Teiler 33.0 (53.) 34.6 (57.) 39.4 (55.)  
 Trefferlage 0.51 mm rechts, 0.11 mm tief  
 Streuwert 1.12, horizontal: 1.43, vertikal: 0.67

Meyton Elektronik

**ISSF AR Women Jun – Wertung – Juniorinnen**

StandNr: 114

**Hafner, Lisa #4**

**StartNr: 63**

19. Januar 2020 11:38

AUT

---

\_\_\_\_\_  
Unterschrift des Schützen

Meyton Elektronik

Ergebnis: **605.5** (580)  
 Serien: 102.9 100.7 101.5 100.6 101.7 98.1  
 Zähler: 42 16 2 0 0 0 0 0 0  
 Innenzehner: 33  
 weiteste: 609 (39), 516 (20), 475 (28)  
 beste Teiler 22.0 (16.) 38.0 (14.) 43.1 (1.)  
 Trefferlage 0.14 mm links, 0.03 mm tief  
 Streuwert 1.80, horizontal: 1.98, vertikal: 1.59

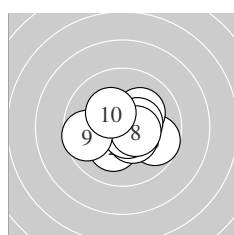
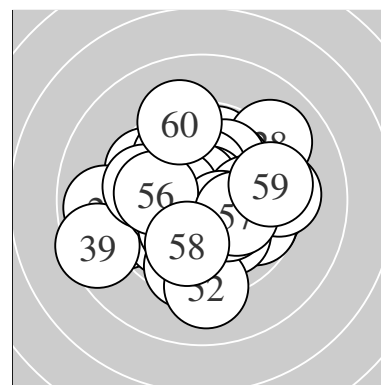

Serie 1:  
 10.8 \* 10.2 \* 9.7 ↘ 10.4 \* 10.2 \*  
 10.7 \* 10.4 \* 10.5 \* 9.7 ← 10.3 \*  
 beste Teiler 43.1 (1.) 68.8 (6.) 121.1 (8.)  
 Trefferlage 0.36 mm rechts, 0.24 mm tief  
 Streuwert 1.38, horizontal: 1.68, vertikal: 0.99

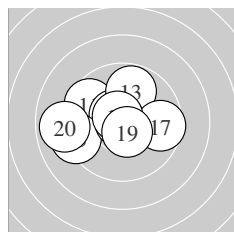

Serie 2:  
 9.6 ↖ 10.6 \* 9.8 ↑ 10.8 \* 9.2 ←  
 10.9 \* 9.6 → 10.7 \* 10.6 \* 8.9 ←  
 beste Teiler 22.0 (16.) 38.0 (14.) 68.0 (18.)  
 Trefferlage 0.94 mm links, 0.27 mm hoch  
 Streuwert 1.97, horizontal: 2.50, vertikal: 1.21

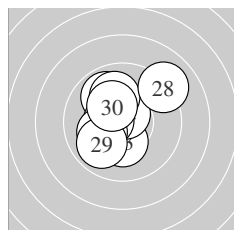

Serie 3:  
 10.8 \* 9.9 ↘ 10.3 \* 10.6 \* 10.0 ↗  
 10.5 \* 10.1 ← 9.1 ↗ 9.9 ↙ 10.3 \*  
 beste Teiler 49.5 (21.) 76.2 (24.) 124.5 (26.)  
 Trefferlage 0.45 mm links, 0.57 mm hoch  
 Streuwert 1.66, horizontal: 1.60, vertikal: 1.71

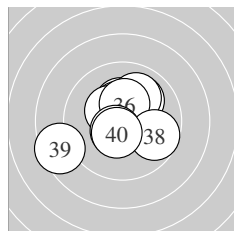

Serie 4:  
 10.3 \* 10.0 ↗ 10.0 ↗ 10.4 \* 10.4 \*  
 10.3 \* 10.5 \* 9.7 ↘ 8.5 ← 10.5 \*  
 beste Teiler 106.4 (37.) 116.2 (40.) 135.7 (34.)  
 Trefferlage 0.28 mm links, 0.36 mm hoch  
 Streuwert 1.93, horizontal: 2.21, vertikal: 1.59

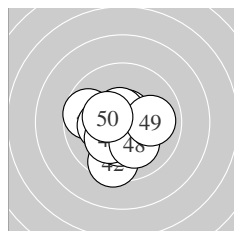

Serie 5:  
 9.7 ← 9.5 ↓ 10.7 \* 10.3 \* 10.6 \*  
 10.2 \* 10.2 \* 10.1 ↘ 10.0 → 10.4 \*  
 beste Teiler 69.7 (43.) 86.3 (45.) 141.6 (50.)  
 Trefferlage 0.49 mm links, 0.60 mm tief  
 Streuwert 1.50, horizontal: 1.54, vertikal: 1.45

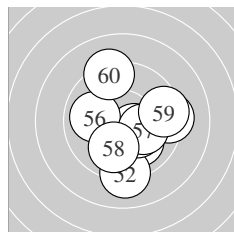

Serie 6:  
 10.0 ↘ 9.1 ↓ 10.3 \* 9.3 → 10.5 \*  
 10.0 ← 10.2 \* 10.0 ↓ 9.5 → 9.2 ↗  
 beste Teiler 123.7 (55.) 168.2 (53.) 197.9 (57.)  
 Trefferlage 0.91 mm rechts, 0.55 mm tief  
 Streuwert 2.18, horizontal: 2.06, vertikal: 2.28

**ISSF AR Women Jun – Wertung – Juniorinnen**

StandNr: 115

**Müssigang, Julia** #184

**StartNr: 64**

19. Januar 2020 11:25

T – SG Thaur

---

Unterschrift des Schützen

---

Meyton Elektronik

Ergebnis:	<b>600.3</b>	(574)							
Serien:	101.1	100.5	100.7	100.1	98.7	99.2			
Zähler:	36	22	2	0	0	0	0	0	0
Innenzehner:	28								
weiteste:	644 (19), 590 (46), 495 (3)								
beste Teiler	18.3 (30.)	57.4 (17.)	64.1 (31.)						
Trefferlage	0.39 mm links, 0.47 mm hoch								
Streuwert	1.90, horizontal: 2.19, vertikal: 1.55								

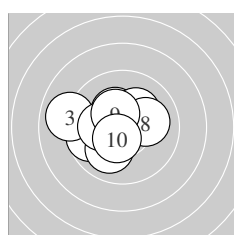
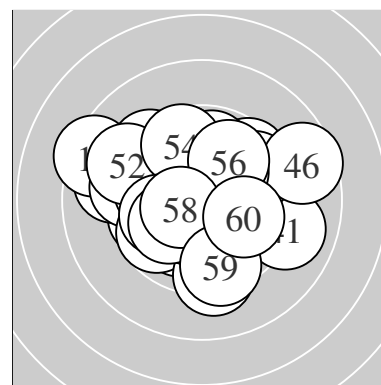

Serie 1:	9.7 ←	10.7 *	9.0 ←	10.3 *	10.0 ↘
	10.2 *	10.2 *	10.1 →	10.4 *	10.5 *
beste Teiler	75.0 (2.) 115.8 (10.) 141.8 (9.)				
Trefferlage	0.90 mm links, 0.22 mm hoch				
Streuwert	1.66, horizontal: 2.03, vertikal: 1.18				

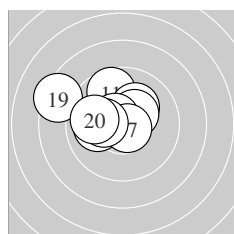

Serie 2:	9.7 ↑	10.2 *	10.4 *	10.3 *	10.0 ←
	10.6 *	10.7 *	10.3 *	8.4 ↖	9.9 ←
beste Teiler	57.4 (17.) 92.9 (16.) 144.5 (13.)				
Trefferlage	1.32 mm links, 0.85 mm hoch				
Streuwert	1.69, horizontal: 2.11, vertikal: 1.14				

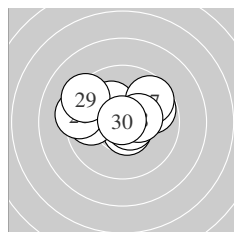

Serie 3:	10.6 *	9.8 ←	10.2 *	10.7 *	9.8 →
	9.3 ←	9.7 ↗	10.4 *	9.3 ↖	10.9 *
beste Teiler	18.3 (30.) 75.5 (24.) 90.7 (21.)				
Trefferlage	0.37 mm links, 0.72 mm hoch				
Streuwert	1.84, horizontal: 2.40, vertikal: 1.00				

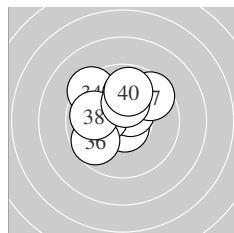

Serie 4:	10.7 *	10.5 *	10.2 *	9.4 ↘	10.0 ↑
	9.7 ↘	9.6 ↗	9.9 ←	10.3 *	9.8 ↑
beste Teiler	64.1 (31.) 109.1 (32.) 169.0 (39.)				
Trefferlage	0.51 mm links, 1.10 mm hoch				
Streuwert	1.68, horizontal: 1.81, vertikal: 1.53				

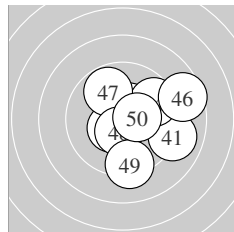

Serie 5:	9.0 →	10.5 *	10.6 *	9.6 ↗	10.4 *
	8.6 →	9.8 ↘	10.5 *	9.3 ↓	10.4 *
beste Teiler	80.1 (43.) 117.7 (48.) 122.5 (42.)				
Trefferlage	1.21 mm rechts, 0.07 mm tief				
Streuwert	2.21, horizontal: 2.39, vertikal: 2.01				

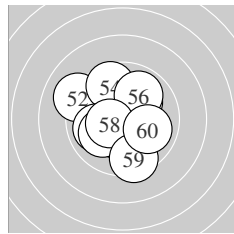

Serie 6:	10.4 *	9.1 ↖	10.1 ↗	9.7 ↑	10.0 ←
	9.9 ↗	10.1 ↘	10.5 *	9.4 ↓	10.0 →
beste Teiler	124.9 (58.) 149.8 (51.) 212.3 (53.)				
Trefferlage	0.49 mm links, 0.03 mm hoch				
Streuwert	2.06, horizontal: 2.03, vertikal: 2.08				

Meyton Elektronik

**ISSF AR Women Jun – Wertung – Juniorinnen**

StandNr: 116

**Alberts, Paula** #391

**StartNr: 65**

19. Januar 2020 11:26

T – SG St. Johann

---

\_\_\_\_\_  
Unterschrift des Schützen

Meyton Elektronik



Ergebnis:	<b>606.0</b>	(580)
Serien:	103.2	100.0 101.2 103.8 99.3 98.5
Zähler:	42	16 2 0 0 0 0 0 0 0
Innenzehner:	30	
weiteste:	613	(51), 572 (47), 447 (53)
beste Teiler	45.1	(8.) 54.3 (46.) 78.3 (32.)
Trefferlage	0.45 mm	links, 0.60 mm hoch
Streuwert	1.61,	horizontal: 1.89, vertikal: 1.26

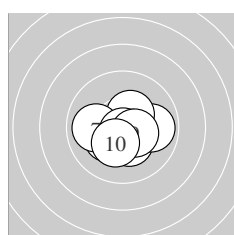
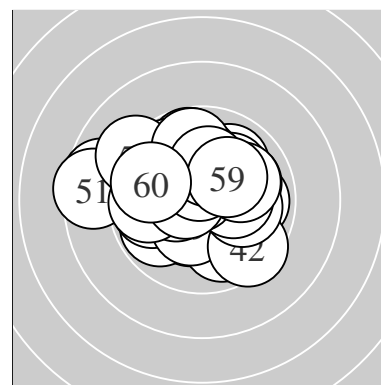

Serie 1:	10.3 *	10.3 *	9.9 →	10.4 *	10.3 *
	10.4 *	10.0 ←	10.8 *	10.5 *	10.3 *
beste Teiler	45.1	(8.) 124.7	(9.) 139.0	(6.)	
Trefferlage	0.11 mm	rechts, 0.44 mm	tief		
Streuwert	1.24,	horizontal: 1.56,	vertikal: 0.80		

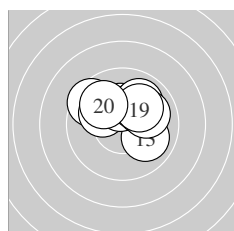

Serie 2:	9.5 ↘	10.1 ↘	10.0 ↘	10.3 *	10.1 ↗
	10.1 ↗	9.9 ↗	10.0 →	10.1 ↗	9.9 ↘
beste Teiler	158.3	(14.) 213.3	(15.) 213.9	(12.)	
Trefferlage	0.35 mm	rechts, 1.27 mm	hoch		
Streuwert	1.51,	horizontal: 1.90,	vertikal: 0.95		

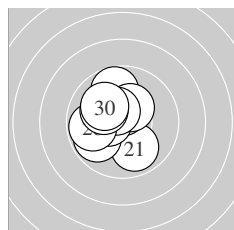

Serie 3:	9.9 ↘	9.8 ↙	10.6 *	9.7 ↑	10.4 *
	10.3 *	10.5 *	9.8 ←	10.1 ↘	10.1 ↘
beste Teiler	98.0	(23.) 119.2	(27.) 135.0	(25.)	
Trefferlage	0.93 mm	links, 0.45 mm	hoch		
Streuwert	1.42,	horizontal: 1.28,	vertikal: 1.55		

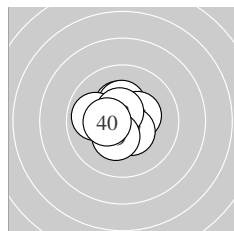

Serie 4:	10.3 *	10.6 *	10.3 *	10.4 *	10.5 *
	9.9 ←	10.5 *	10.6 *	10.3 *	10.4 *
beste Teiler	78.3	(32.) 90.4	(38.) 122.1	(35.)	
Trefferlage	0.47 mm	links, 0.31 mm	hoch		
Streuwert	1.04,	horizontal: 1.11,	vertikal: 0.96		

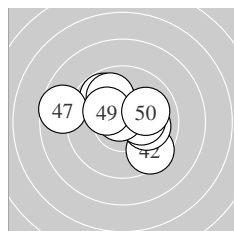

Serie 5:	10.3 *	9.5 ↘	10.0 →	9.8 ↘	10.2 *
	10.7 *	8.7 ←	9.9 ↘	10.2 *	10.0 →
beste Teiler	54.3	(46.) 167.4	(41.) 176.2	(45.)	
Trefferlage	0.22 mm	links, 0.69 mm	hoch		
Streuwert	2.06,	horizontal: 2.53,	vertikal: 1.45		

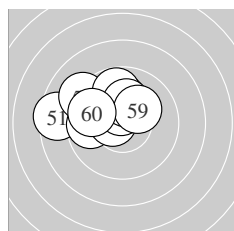

Serie 6:	8.5 ←	9.8 ←	9.2 ↘	10.6 *	10.0 ↑
	10.5 *	9.8 ↑	10.2 *	10.2 *	9.7 ↙
beste Teiler	93.2	(54.) 108.0	(56.) 190.4	(59.)	
Trefferlage	1.56 mm	links, 1.34 mm	hoch		
Streuwert	1.77,	horizontal: 2.29,	vertikal: 1.02		

Meyton Elektronik

**ISSF AR Women Jun – Wertung – Juniorinnen**

**StartNr: 66**

StandNr: 117

19. Januar 2020 11:51

**Mautz, Leonie** #109

LIE

---

\_\_\_\_\_  
Unterschrift des Schützen

Meyton Elektronik

Ergebnis:	<b>616.2</b>	(588)							
Serien:	100.8	103.9	103.2	102.3	101.4	104.6			
Zähler:	48	12	0	0	0	0	0	0	0
Innenzehner:	38								
weiteste:	395 (50), 368 (5), 333 (3)								
beste Teiler	22.0 (43.)	32.2 (10.)	38.6 (54.)						
Trefferlage	0.32 mm links, 0.28 mm hoch								
Streuwert	1.34, horizontal: 1.40, vertikal: 1.27								

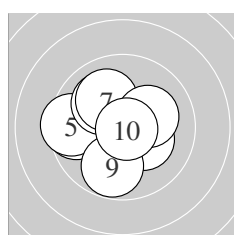
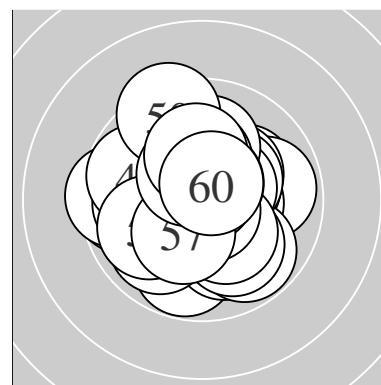

Serie 1:	9.8 ←	10.3 *	9.6 ←	10.7 *	9.5 ←
	10.1 ↖	10.0 ↖	10.2 *	9.8 ↓	10.8 *
beste Teiler	32.2 (10.) 64.4 (4.) 172.5 (2.)				
Trefferlage	1.00 mm links, 0.01 mm hoch				
Streuwert	1.66, horizontal: 1.92, vertikal: 1.34				

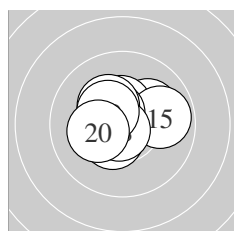

Serie 2:	10.8 *	10.1 ↗	10.5 *	10.4 *	9.9 →
	10.5 *	10.3 *	10.8 *	10.4 *	10.2 *
beste Teiler	47.9 (11.) 48.8 (18.) 104.8 (16.)				
Trefferlage	0.15 mm links, 0.41 mm hoch				
Streuwert	1.13, horizontal: 1.37, vertikal: 0.82				

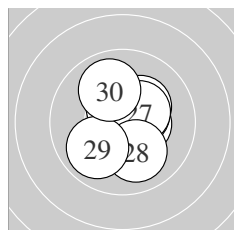

Serie 3:	10.5 *	10.4 *	10.8 *	10.5 *	10.3 *
	10.4 *	10.4 *	10.0 ↓	9.9 ↙	10.0 ↖
beste Teiler	48.7 (23.) 108.8 (24.) 113.3 (21.)				
Trefferlage	0.42 mm rechts, 0.22 mm hoch				
Streuwert	1.22, horizontal: 1.09, vertikal: 1.33				

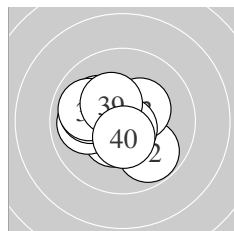

Serie 4:	10.5 *	9.8 ↘	10.4 *	10.0 ←	10.0 ←
	10.1 ↖	9.9 ←	10.7 *	10.4 *	10.5 *
beste Teiler	57.6 (38.) 116.2 (40.) 124.6 (31.)				
Trefferlage	0.70 mm links, 0.04 mm tief				
Streuwert	1.36, horizontal: 1.55, vertikal: 1.15				

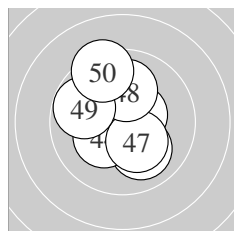

Serie 5:	10.0 ↓	9.9 ↑	10.9 *	10.3 *	10.3 *
	10.5 *	10.3 *	10.0 ↑	9.8 ↖	9.4 ↑
beste Teiler	22.0 (43.) 111.8 (46.) 161.0 (45.)				
Trefferlage	0.24 mm links, 0.70 mm hoch				
Streuwert	1.59, horizontal: 1.29, vertikal: 1.84				

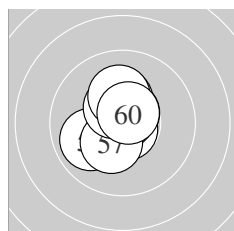

Serie 6:	10.6 *	10.3 *	10.7 *	10.8 *	10.7 *
	9.9 ←	10.3 *	10.5 *	10.2 *	10.6 *
beste Teiler	38.6 (54.) 53.0 (53.) 64.4 (55.)				
Trefferlage	0.27 mm links, 0.41 mm hoch				
Streuwert	0.98, horizontal: 0.82, vertikal: 1.12				

Meyton Elektronik

**ISSF AR Women Jun – Wertung – Juniorinnen**

**StartNr: 68**

StandNr: 119

19. Januar 2020 11:34

**Hitz, Sarina** #359

SUI

---

\_\_\_\_\_  
Unterschrift des Schützen

Meyton Elektronik

Ergebnis:	<b>624.9</b>	(594) <sup>QF</sup>
Serien:	104.6	103.6 103.3 104.6 104.8 104.0
Zähler:	54	6 0 0 0 0 0 0 0 0
Innenzehner:	52	
weiteste:	463 (35), 393 (29), 297 (12)	
beste Teiler	28.4 (7.)	37.9 (28.) 41.6 (49.)
Trefferlage	0.37 mm links, 0.09 mm hoch	
Streuwert	1.09, horizontal: 1.28, vertikal: 0.86	

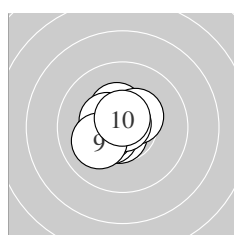
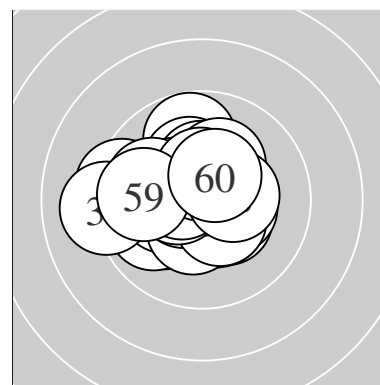

Serie 1:	10.2 *	10.7 *	10.5 *	10.4 *	10.4 *
	10.4 *	10.8 *	10.4 *	10.1 ←	10.7 *
beste Teiler	28.4 (7.) 70.9 (2.) 72.0 (10.)				
Trefferlage	0.67 mm links, 0.00 mm				
Streuwert	0.88, horizontal: 0.90, vertikal: 0.85				

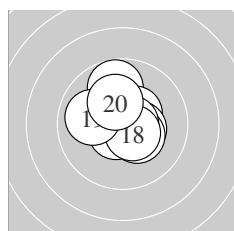

Serie 2:	10.6 *	9.8 ↑	10.4 *	10.4 *	10.4 *
	10.6 *	10.7 *	10.5 *	10.0 ←	10.2 *
beste Teiler	65.1 (17.) 76.5 (11.) 80.0 (16.)				
Trefferlage	0.12 mm rechts, 0.41 mm hoch				
Streuwert	1.18, horizontal: 1.14, vertikal: 1.21				

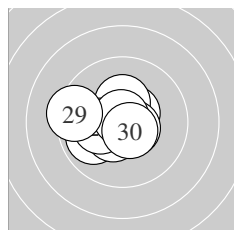

Serie 3:	10.5 *	10.3 *	10.5 *	10.6 *	9.9 ←
	10.5 *	10.2 *	10.8 *	9.4 ←	10.6 *
beste Teiler	37.9 (28.) 89.3 (30.) 92.4 (24.)				
Trefferlage	0.77 mm links, 0.08 mm tief				
Streuwert	1.24, horizontal: 1.52, vertikal: 0.88				

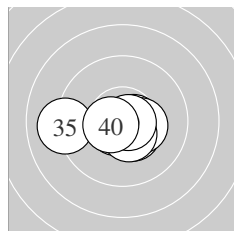

Serie 4:	10.8 *	10.6 *	10.4 *	10.7 *	9.1 ←
	10.7 *	10.4 *	10.5 *	10.8 *	10.6 *
beste Teiler	47.5 (39.) 50.2 (31.) 57.5 (34.)				
Trefferlage	0.18 mm links, 0.44 mm tief				
Streuwert	1.23, horizontal: 1.71, vertikal: 0.32				

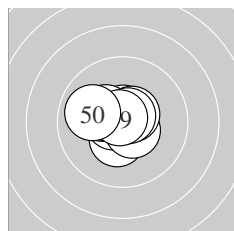

Serie 5:	10.4 *	10.7 *	10.2 *	10.7 *	10.5 *
	10.6 *	10.3 *	10.7 *	10.8 *	9.9 ←
beste Teiler	41.6 (49.) 64.6 (48.) 72.0 (44.)				
Trefferlage	0.48 mm links, 0.23 mm hoch				
Streuwert	0.90, horizontal: 1.06, vertikal: 0.71				

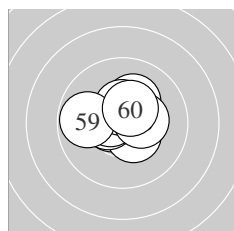

Serie 6:	10.6 *	10.7 *	10.4 *	10.5 *	10.5 *
	10.2 *	10.5 *	10.4 *	9.8 ←	10.4 *
beste Teiler	73.3 (52.) 88.2 (51.) 102.7 (55.)				
Trefferlage	0.24 mm links, 0.46 mm hoch				
Streuwert	1.05, horizontal: 1.27, vertikal: 0.76				

Meyton Elektronik

**ISSF AR Women Jun – Wertung – Juniorinnen**

**StartNr: 69**

StandNr: 120

19. Januar 2020 11:48

**Tan, Fernel** #341

SGP

---

QF – Schütze hat sich fürs Finale qualifiziert

---

Unterschrift des Schützen

Meyton Elektronik

Ergebnis:	<b>597.3</b>	(572)							
Serien:	98.3	99.6	96.0	101.0	101.6	100.8			
Zähler:	35	22	3	0	0	0	0	0	0
Innenzehner:	24								
weiteste:	566 (21), 521 (60), 503 (26)								
beste Teiler	8.5 (59.) 52.4 (42.) 73.9 (57.)								
Trefferlage	0.27 mm rechts, 0.28 mm hoch								
Streuwert	1.99, horizontal: 2.30, vertikal: 1.63								

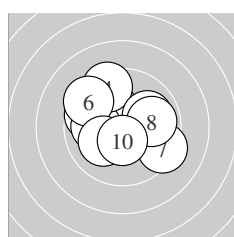
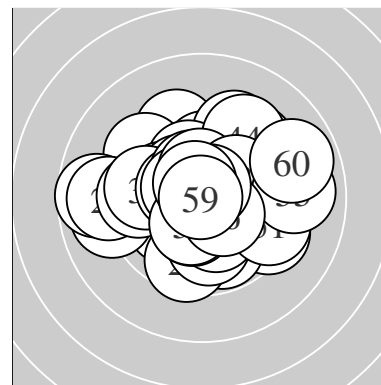

Serie 1:					
	9.7 ↖	10.0 ↗	10.0 ←	9.4 ↗	10.0 →
	9.4 ↖	9.3 ↘	9.9 →	10.1 ↙	10.5 *
beste Teiler	119.0 (10.) 213.4 (9.) 228.6 (2.)				
Trefferlage	0.42 mm links, 0.63 mm hoch				
Streuwert	2.10, horizontal: 2.41, vertikal: 1.74				

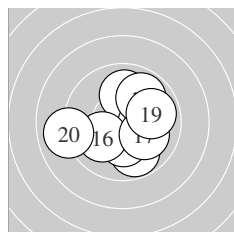

Serie 2:					
	9.8 ↓	10.3 *	10.3 *	10.0 ↑	10.2 *
	10.1 ↙	10.1 ↘	9.9 ↗	9.9 →	9.0 ←
beste Teiler	166.2 (12.) 175.2 (13.) 182.2 (15.)				
Trefferlage	0.38 mm rechts, 0.36 mm tief				
Streuwert	1.96, horizontal: 2.22, vertikal: 1.67				

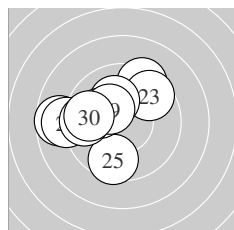

Serie 3:					
	8.7 ←	9.4 ↗	9.6 ↗	10.1 ↗	9.6 ↓
	8.9 ←	10.1 ↖	9.6 ←	10.3 *	9.7 ←
beste Teiler	164.0 (29.) 205.4 (24.) 222.1 (27.)				
Trefferlage	1.78 mm links, 0.71 mm hoch				
Streuwert	2.26, horizontal: 2.62, vertikal: 1.83				

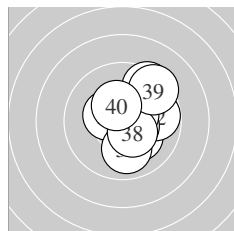

Serie 4:					
	10.2 *	9.8 →	9.4 ↗	10.4 *	10.5 *
	10.5 *	10.0 ↓	10.4 *	9.4 ↗	10.4 *
beste Teiler	113.7 (35.) 114.1 (36.) 131.7 (38.)				
Trefferlage	1.06 mm rechts, 0.35 mm hoch				
Streuwert	1.57, horizontal: 1.35, vertikal: 1.76				

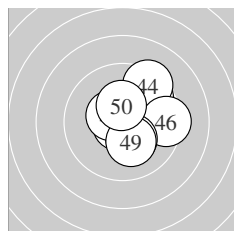

Serie 5:					
	9.7 ↗	10.7 *	10.4 *	9.4 ↗	10.6 *
	9.4 →	10.3 *	10.5 *	10.2 *	10.4 *
beste Teiler	52.4 (42.) 90.4 (45.) 119.0 (48.)				
Trefferlage	0.90 mm rechts, 0.37 mm hoch				
Streuwert	1.58, horizontal: 1.51, vertikal: 1.66				

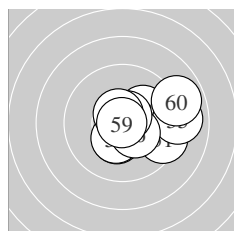

Serie 6:					
	9.4 ↘	10.4 *	10.1 ↗	10.4 *	9.0 →
	10.4 *	10.7 *	10.6 *	10.9 *	8.9 →
beste Teiler	8.5 (59.) 73.9 (57.) 89.8 (58.)				
Trefferlage	1.50 mm rechts, 0.00 mm				
Streuwert	1.77, horizontal: 2.19, vertikal: 1.20				

Meyton Elektronik

**ISSF AR Women Jun – Wertung – Juniorinnen**

**StartNr: 70**

StandNr: 121

19. Januar 2020 11:28

**Hillinger, Christina** #298

OÖ – SG Vorchdorf 1879

---

\_\_\_\_\_  
Unterschrift des Schützen

Meyton Elektronik



Ergebnis:	<b>605.9</b>	(578)
Serien:	102.4	101.1 99.1 102.0 99.5 101.8
Zähler:	38	22 0 0 0 0 0 0 0 0
Innenzehner:	28	
weiteste:	469 (43), 422 (29), 412 (47)	
beste Teiler	79.3 (26.)	79.9 (56.) 80.0 (32.)
Trefferlage	0.04 mm rechts,	0.34 mm hoch
Streuwert	1.65, horizontal:	1.88, vertikal: 1.38

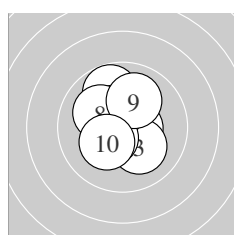
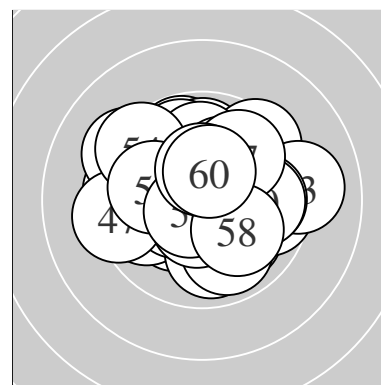

Serie 1:	10.4 *	10.5 *	10.1 ↘	9.8 ↑	10.4 *
	10.4 *	10.4 *	10.1 ↖	10.0 ↗	10.3 *
beste Teiler	102.3 (2.)	129.6 (7.)	130.5 (6.)		
Trefferlage	0.45 mm links, 0.18 mm hoch				
Streuwert	1.33, horizontal: 1.11, vertikal: 1.52				

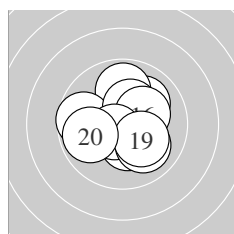

Serie 2:	10.0 ↗	9.9 ↑	9.7 ←	10.3 *	10.3 *
	10.2 *	10.6 *	10.0 ↘	10.2 *	9.9 ←
beste Teiler	90.5 (17.)	152.6 (14.)	156.4 (15.)		
Trefferlage	0.10 mm rechts, 0.10 mm hoch				
Streuwert	1.63, horizontal: 1.75, vertikal: 1.50				

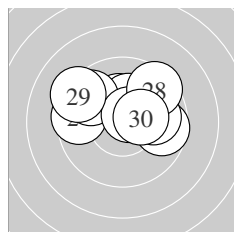

Serie 3:	10.3 *	10.3 *	9.7 →	9.5 ←	9.7 ↖
	10.6 *	9.9 →	9.5 ↗	9.3 ↖	10.3 *
beste Teiler	79.3 (26.)	153.3 (30.)	170.0 (21.)		
Trefferlage	0.07 mm rechts, 1.15 mm hoch				
Streuwert	1.92, horizontal: 2.53, vertikal: 1.01				

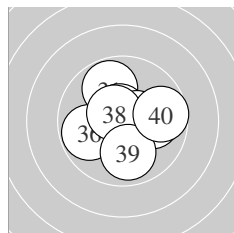

Serie 4:	9.8 ↑	10.6 *	10.0 →	10.5 *	10.6 *
	9.8 ←	10.5 *	10.6 *	9.9 ↓	9.7 →
beste Teiler	80.0 (32.)	93.3 (38.)	98.8 (35.)		
Trefferlage	0.12 mm rechts, 0.00 mm				
Streuwert	1.55, horizontal: 1.71, vertikal: 1.37				

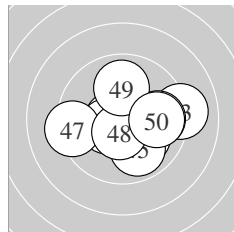

Serie 5:	10.1 ↘	10.6 *	9.1 →	9.8 →	9.9 ↓
	10.4 *	9.3 ←	10.5 *	9.9 ↑	9.9 →
beste Teiler	82.0 (42.)	106.9 (48.)	135.9 (46.)		
Trefferlage	0.66 mm rechts, 0.31 mm tief				
Streuwert	1.99, horizontal: 2.49, vertikal: 1.31				

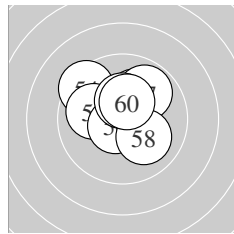

Serie 6:	10.1 ↗	10.4 *	10.5 *	9.4 ↖	10.0 ←
	10.6 *	9.9 ↗	10.1 ↘	10.4 *	10.4 *
beste Teiler	79.9 (56.)	116.2 (53.)	132.9 (52.)		
Trefferlage	0.26 mm links, 0.96 mm hoch				
Streuwert	1.40, horizontal: 1.57, vertikal: 1.21				

Meyton Elektronik

**ISSF AR Women Jun – Wertung – Juniorinnen**

StandNr: 122

**Biechl, Julia** #180

**StartNr: 71**

19. Januar 2020 11:29

T – SG Absam

---

\_\_\_\_\_  
Unterschrift des Schützen

Meyton Elektronik

Ergebnis:	<b>619.2</b>	(591)
Serien:	103.9	102.3 103.8 103.5 103.7 102.0
Zähler:	51	9 0 0 0 0 0 0 0 0
Innenzehner:	44	
weiteste:	344	(52), 321 (48), 313 (10)
beste Teiler	30.3	(55.) 34.4 (15.) 38.6 (9.)
Trefferlage	0.10 mm links, 0.45 mm hoch	
Streuwert	1.21, horizontal: 1.22, vertikal: 1.20	

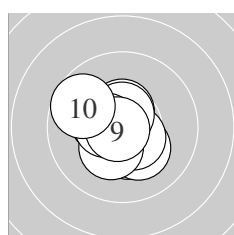
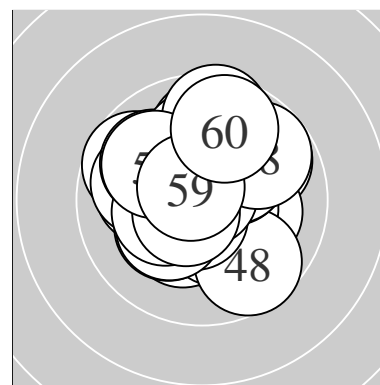

Serie 1:	10.4 *	10.5 *	10.4 *	10.2 *	10.5 *
	10.6 *	10.3 *	10.5 *	10.8 *	9.7 ↖
beste Teiler	38.6 (9.) 89.1 (6.) 105.3 (5.)				
Trefferlage	0.43 mm links, 0.10 mm tief				
Streuwert	1.12, horizontal: 1.15, vertikal: 1.10				

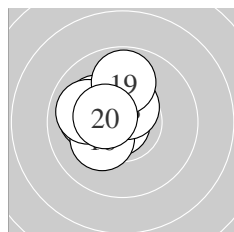

Serie 2:	10.2 *	10.1 ↖	10.3 *	10.1 ←	10.8 *
	10.2 *	9.9 ←	10.5 *	9.8 ↑	10.4 *
beste Teiler	34.4 (15.) 108.5 (18.) 127.4 (20.)				
Trefferlage	1.13 mm links, 0.69 mm hoch				
Streuwert	1.00, horizontal: 0.96, vertikal: 1.03				

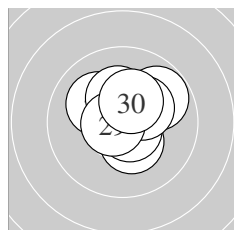

Serie 3:	10.4 *	10.4 *	10.1 ↖	10.3 *	9.8 ↗
	10.8 *	10.7 *	10.3 *	10.7 *	10.3 *
beste Teiler	48.1 (26.) 68.0 (29.) 72.8 (27.)				
Trefferlage	0.39 mm rechts, 0.57 mm hoch				
Streuwert	1.09, horizontal: 1.12, vertikal: 1.07				

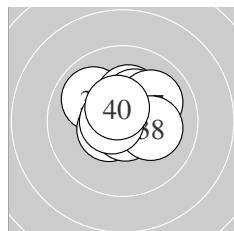

Serie 4:	9.9 ↖	10.5 *	10.3 *	10.3 *	10.6 *
	10.7 *	10.0 ↗	10.1 →	10.6 *	10.5 *
beste Teiler	57.5 (36.) 76.1 (39.) 76.6 (35.)				
Trefferlage	0.20 mm rechts, 0.50 mm hoch				
Streuwert	1.11, horizontal: 1.26, vertikal: 0.94				

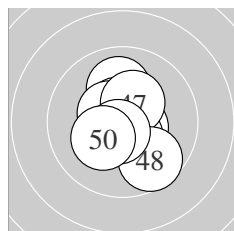

Serie 5:	10.0 ↑	10.6 *	10.6 *	10.5 *	10.5 *
	10.5 *	10.3 *	9.7 ↘	10.7 *	10.3 *
beste Teiler	75.1 (49.) 93.9 (42.) 95.4 (43.)				
Trefferlage	0.15 mm rechts, 0.12 mm tief				
Streuwert	1.22, horizontal: 0.98, vertikal: 1.42				

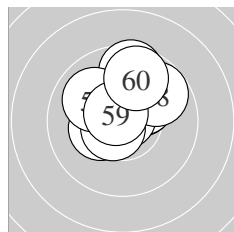

Serie 6:	10.3 *	9.6 ↑	10.3 *	10.2 *	10.8 *
	10.6 *	10.0 ↖	9.8 ↗	10.7 *	9.7 ↑
beste Teiler	30.3 (55.) 71.5 (59.) 84.8 (56.)				
Trefferlage	0.19 mm rechts, 1.19 mm hoch				
Streuwert	1.34, horizontal: 1.36, vertikal: 1.32				

Meyton Elektronik

**ISSF AR Women Jun – Wertung – Juniorinnen**

StandNr: 123

**Kowplos, Katarina #320**

**StartNr: 72**

19. Januar 2020 11:51

AUS

---

\_\_\_\_\_  
Unterschrift des Schützen

Meyton Elektronik

Ergebnis:	<b>624.6</b>	(594) <sup>QF</sup>
Serien:	102.3	104.6 104.4 105.2 104.0 104.1
Zähler:	54	6 0 0 0 0 0 0 0 0
Innenzehner:	52	
weiteste:	365	(29), 341 (5), 320 (51)
beste Teiler	21.9	(23.) 30.5 (45.) 32.2 (8.)
Trefferlage	0.10 mm	rechts, 0.30 mm hoch
Streuwert	1.11,	horizontal: 1.17, vertikal: 1.04

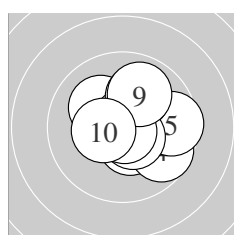
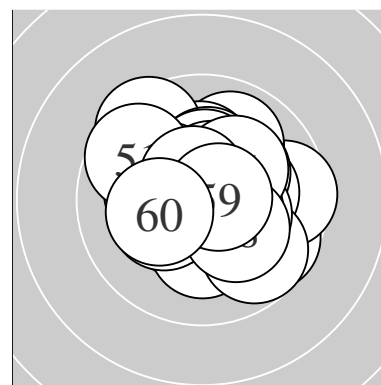

Serie 1:	10.1 ↘	10.5 *	10.8 *	9.7 ↘	9.6 →
	10.0 ↗	10.5 *	10.8 *	9.9 ↗	10.4 *
beste Teiler	32.2	(8.) 45.5 (3.)	101.1 (7.)		
Trefferlage	0.70 mm	rechts, 0.25 mm hoch			
Streuwert	1.43,	horizontal: 1.54, vertikal: 1.31			

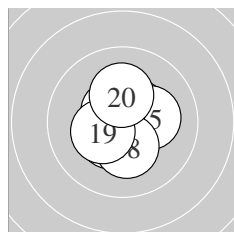

Serie 2:	10.8 *	10.7 *	10.6 *	10.5 *	10.2 *
	10.6 *	10.4 *	10.3 *	10.3 *	10.2 *
beste Teiler	42.2	(11.) 62.5 (12.)	98.3 (16.)		
Trefferlage	0.04 mm	rechts, 0.02 mm hoch			
Streuwert	0.99,	horizontal: 0.90, vertikal: 1.08			

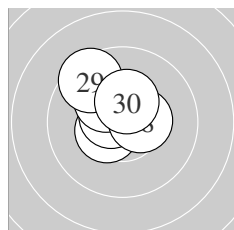

Serie 3:	10.7 *	10.7 *	10.9 *	10.5 *	10.6 *
	10.4 *	10.2 *	10.5 *	9.5 ↘	10.4 *
beste Teiler	21.9	(23.) 54.6 (21.)	55.7 (22.)		
Trefferlage	0.37 mm	links, 0.83 mm hoch			
Streuwert	0.98,	horizontal: 0.97, vertikal: 0.99			

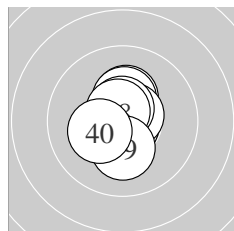

Serie 4:	10.7 *	10.3 *	10.7 *	10.3 *	10.8 *
	10.6 *	10.6 *	10.7 *	10.2 *	10.3 *
beste Teiler	44.5	(35.) 60.8 (31.)	67.1 (33.)		
Trefferlage	0.07 mm	links, 0.23 mm hoch			
Streuwert	0.88,	horizontal: 0.65, vertikal: 1.07			

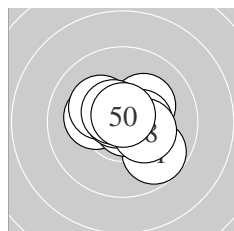

Serie 5:	9.7 ↘	10.2 *	10.2 *	10.2 *	10.8 *
	10.7 *	10.5 *	10.3 *	10.6 *	10.8 *
beste Teiler	30.5	(45.) 49.1 (50.)	60.1 (46.)		
Trefferlage	0.22 mm	rechts, 0.13 mm hoch			
Streuwert	1.17,	horizontal: 1.36, vertikal: 0.94			

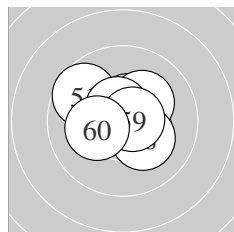

Serie 6:	9.7 ↘	10.8 *	10.5 *	10.7 *	10.5 *
	10.2 *	10.6 *	10.2 *	10.7 *	10.2 *
beste Teiler	44.9	(52.) 57.6 (54.)	70.0 (59.)		
Trefferlage	0.09 mm	rechts, 0.35 mm hoch			
Streuwert	1.15,	horizontal: 1.35, vertikal: 0.91			

QF – Schütze hat sich fürs Finale qualifiziert

\_\_\_\_\_  
Unterschrift des Schützen

Meyton Elektronik

Ergebnis: **612.1** (586)

Serien: 101.7 103.6 101.0 101.5 101.1 103.2

Zähler: 46 14 0 0 0 0 0 0 0

Innenzehner: 33

weiteste: 434 (5), 396 (17), 381 (47)

beste Teiler 28.7 (60.) 34.7 (56.) 39.0 (11.)

Trefferlage 0.03 mm links, 0.01 mm tief

Streuwert 1.52, horizontal: 1.66, vertikal: 1.36

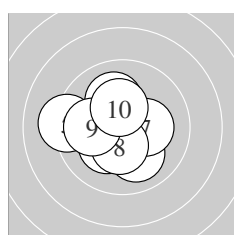
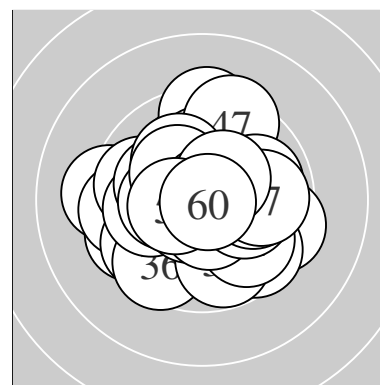

Serie 1:

10.2 *	10.7 *	10.1 ↗	10.5 *	9.2 ←
10.0 ↘	10.3 *	10.4 *	10.0 ←	10.3 *

beste Teiler 63.8 (2.) 122.5 (4.) 145.0 (8.)

Trefferlage 0.67 mm links, 0.26 mm tief

Streuwert 1.52, horizontal: 1.70, vertikal: 1.32

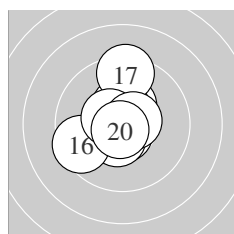

Serie 2:

10.8 *	10.4 *	10.7 *	10.4 *	10.5 *
9.5 ←	9.4 ↑	10.5 *	10.6 *	10.8 *

beste Teiler 39.0 (11.) 47.4 (20.) 70.8 (13.)

Trefferlage 0.34 mm links, 0.41 mm hoch

Streuwert 1.38, horizontal: 1.12, vertikal: 1.59

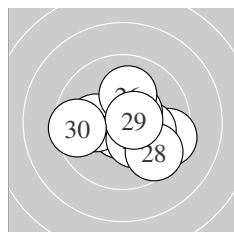

Serie 3:

9.5 →	10.7 *	10.1 →	10.5 *	10.1 ←
10.1 ↑	10.3 *	9.6 ↘	10.6 *	9.5 ←

beste Teiler 63.6 (22.) 89.1 (29.) 115.3 (24.)

Trefferlage 0.51 mm rechts, 0.35 mm tief

Streuwert 1.71, horizontal: 2.08, vertikal: 1.22

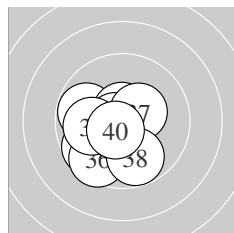

Serie 4:

9.8 ↖	10.6 *	9.7 ↙	10.3 *	10.7 *
9.6 ↙	10.4 *	9.8 ↘	10.0 ←	10.6 *

beste Teiler 57.0 (35.) 77.3 (32.) 89.6 (40.)

Trefferlage 0.95 mm links, 0.78 mm tief

Streuwert 1.42, horizontal: 1.43, vertikal: 1.40

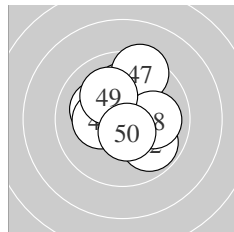

Serie 5:

10.1 ↖	9.8 ↘	10.4 *	10.3 *	10.4 *
10.1 ↑	9.4 ↑	10.0 →	10.1 ↘	10.5 *

beste Teiler 107.5 (50.) 137.0 (43.) 146.2 (45.)

Trefferlage 0.41 mm rechts, 0.58 mm hoch

Streuwert 1.56, horizontal: 1.54, vertikal: 1.58

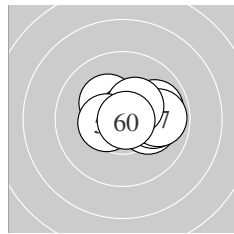

Serie 6:

10.7 *	9.9 →	10.1 →	10.3 *	10.0 →
10.8 *	9.8 →	10.4 *	10.4 *	10.8 *

beste Teiler 28.7 (60.) 34.7 (56.) 64.8 (51.)

Trefferlage 0.81 mm rechts, 0.29 mm hoch

Streuwert 1.15, horizontal: 1.52, vertikal: 0.57

**ISSF AR Women Jun – Wertung – Juniorinnen**

StandNr: 125

**Nagl, Selina** #185

**StartNr: 74**

19. Januar 2020 11:30

T – SG Thaur

---

\_\_\_\_\_  
Unterschrift des Schützen

Meyton Elektronik



Ergebnis: **623.6** (595)  
 Serien: 103.8 105.1 103.3 104.7 103.6 103.1  
 Zähler: 55 5 0 0 0 0 0 0 0 0  
 Innenzehner: 46  
 weiteste: 303 (54), 301 (59), 290 (51)  
 beste Teiler 7.0 (31.) 16.0 (60.) 30.5 (5.)  
 Trefferlage 0.18 mm rechts, 0.39 mm hoch  
 Streuwert 1.08, horizontal: 1.05, vertikal: 1.11

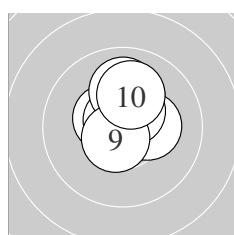
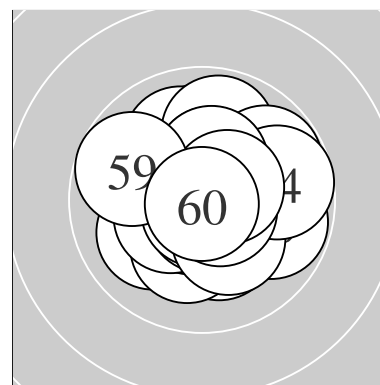

Serie 1:  
 10.1 ↑ 10.5 \* 10.7 \* 10.2 \* 10.8 \*  
 10.3 \* 10.5 \* 10.0 ↑ 10.6 \* 10.1 ↑  
 beste Teiler 30.5 (5.) 57.8 (3.) 85.4 (9.)  
 Trefferlage 0.20 mm rechts, 0.97 mm hoch  
 Streuwert 0.93, horizontal: 0.73, vertikal: 1.09

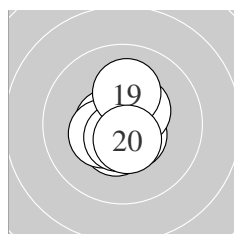

Serie 2:  
 10.7 \* 10.6 \* 10.5 \* 10.7 \* 10.6 \*  
 10.4 \* 10.4 \* 10.6 \* 10.1 ↑ 10.5 \*  
 beste Teiler 65.7 (14.) 75.4 (11.) 91.2 (12.)  
 Trefferlage 0.09 mm links, 0.10 mm tief  
 Streuwert 0.89, horizontal: 0.73, vertikal: 1.02

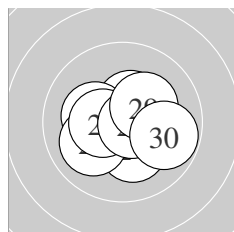

Serie 3:  
 10.6 \* 10.7 \* 10.4 \* 10.2 \* 10.2 \*  
 10.0 ↙ 10.4 \* 10.7 \* 10.3 \* 9.8 ↘  
 beste Teiler 55.4 (22.) 62.5 (28.) 76.0 (21.)  
 Trefferlage 0.14 mm rechts, 0.09 mm tief  
 Streuwert 1.24, horizontal: 1.47, vertikal: 0.95

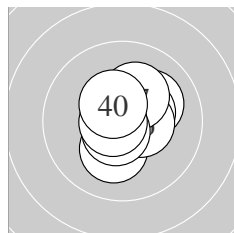

Serie 4:  
 10.9 \* 10.1 ↗ 10.7 \* 10.2 \* 10.4 \*  
 10.5 \* 10.2 \* 10.6 \* 10.7 \* 10.4 \*  
 beste Teiler 7.0 (31.) 61.9 (33.) 63.5 (39.)  
 Trefferlage 0.32 mm rechts, 0.15 mm hoch  
 Streuwert 0.96, horizontal: 0.90, vertikal: 1.01

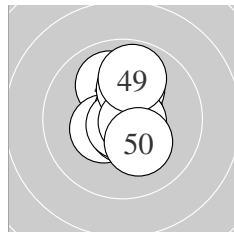

Serie 5:  
 10.1 ↑ 10.0 ↘ 10.4 \* 10.7 \* 10.7 \*  
 10.8 \* 10.1 ↑ 10.7 \* 9.9 ↑ 10.2 \*  
 beste Teiler 42.1 (46.) 63.2 (44.) 66.7 (48.)  
 Trefferlage 0.06 mm rechts, 0.61 mm hoch  
 Streuwert 1.17, horizontal: 0.73, vertikal: 1.49

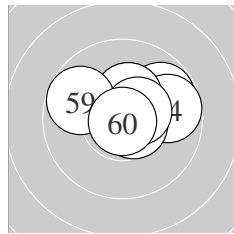

Serie 6:  
 9.8 ↗ 10.4 \* 10.6 \* 9.7 → 10.5 \*  
 10.6 \* 10.4 \* 10.5 \* 9.7 ← 10.9 \*  
 beste Teiler 16.0 (60.) 80.9 (56.) 86.6 (53.)  
 Trefferlage 0.47 mm rechts, 0.80 mm hoch  
 Streuwert 1.21, horizontal: 1.58, vertikal: 0.67

Meyton Elektronik

**ISSF AR Women Jun – Wertung – Juniorinnen**

StandNr: 126

**Thurnwaldova, Sabina #363**

**StartNr: 75**

19. Januar 2020 11:32

CZE

---

Unterschrift des Schützen

Meyton Elektronik

Ergebnis:	<b>620.0</b>	(592)							
Serien:	103.2	104.1	103.5	103.6	102.8	102.8			
Zähler:	52	8	0	0	0	0	0	0	0
Innenzehner:	47								
weiteste:	376 (29), 374 (53), 289 (44)								
beste Teiler	30.0 (39.) 35.9 (22.) 45.6 (2.)								
Trefferlage	0.18 mm links, 0.11 mm hoch								
Streuwert	1.21, horizontal: 1.22, vertikal: 1.21								

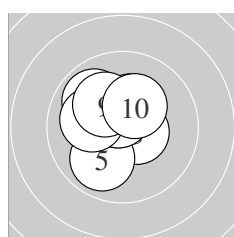
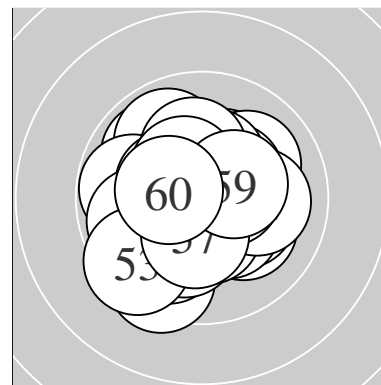

Serie 1:					
	10.3 *	10.8 *	10.5 *	9.9 ↘	9.9 ↙
	10.6 *	10.6 *	10.1 ←	10.2 *	10.3 *
beste Teiler	45.6 (2.) 86.0 (7.) 88.3 (6.)				
Trefferlage	0.52 mm links, 0.62 mm hoch				
Streuwert	1.15, horizontal: 1.12, vertikal: 1.18				

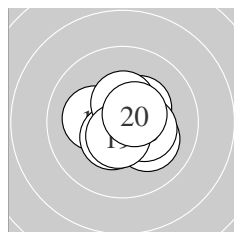

Serie 2:					
	10.5 *	10.3 *	10.7 *	10.1 ↘	10.2 *
	10.3 *	10.4 *	10.4 *	10.6 *	10.6 *
beste Teiler	70.8 (13.) 99.5 (20.) 99.9 (19.)				
Trefferlage	0.21 mm rechts, 0.00 mm				
Streuwert	1.04, horizontal: 1.13, vertikal: 0.94				

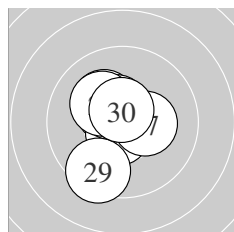

Serie 3:					
	10.2 *	10.8 *	10.5 *	10.6 *	10.4 *
	10.5 *	10.3 *	10.2 *	9.4 ↙	10.6 *
beste Teiler	35.9 (22.) 82.4 (24.) 84.3 (30.)				
Trefferlage	0.50 mm links, 0.20 mm hoch				
Streuwert	1.22, horizontal: 0.96, vertikal: 1.43				

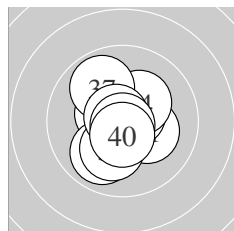

Serie 4:					
	10.2 *	10.5 *	10.6 *	10.3 *	9.9 ↙
	10.1 ↙	9.9 ↘	10.7 *	10.8 *	10.6 *
beste Teiler	30.0 (39.) 53.2 (38.) 87.6 (33.)				
Trefferlage	0.15 mm links, 0.11 mm tief				
Streuwert	1.23, horizontal: 1.07, vertikal: 1.38				

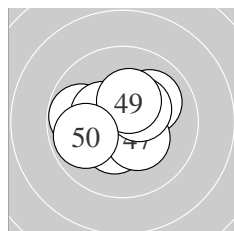

Serie 5:					
	10.0 ↗	10.4 *	10.7 *	9.8 ←	10.6 *
	10.4 *	10.3 *	10.4 *	10.3 *	9.9 ←
beste Teiler	66.7 (43.) 97.5 (45.) 145.4 (48.)				
Trefferlage	0.13 mm links, 0.04 mm hoch				
Streuwert	1.36, horizontal: 1.63, vertikal: 1.03				

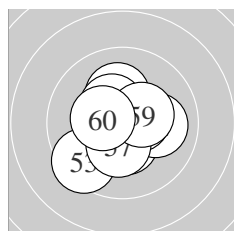

Serie 6:					
	10.4 *	10.0 →	9.5 ↙	10.2 *	10.7 *
	10.5 *	10.3 *	10.4 *	10.4 *	10.4 *
beste Teiler	63.7 (55.) 107.7 (56.) 135.9 (51.)				
Trefferlage	0.01 mm links, 0.09 mm tief				
Streuwert	1.39, horizontal: 1.42, vertikal: 1.36				

Meyton Elektronik

**ISSF AR Women Jun – Wertung – Juniorinnen**

StandNr: 127

**Paravati, Paola** #177

**StartNr: 76**

19. Januar 2020 11:34

ITA – Accademia

---

\_\_\_\_\_  
Unterschrift des Schützen

Meyton Elektronik

Ergebnis: **618.7** (591)  
 Serien: 103.0 102.9 103.9 101.8 104.2 102.9  
 Zähler: 51 9 0 0 0 0 0 0 0  
 Innenzehner: 44  
 weiteste: 381 (14), 326 (39), 323 (35)  
 beste Teiler 9.4 (43.) 29.4 (22.) 36.2 (15.)  
 Trefferlage 0.35 mm rechts, 0.21 mm hoch  
 Streuwert 1.25, horizontal: 1.37, vertikal: 1.11

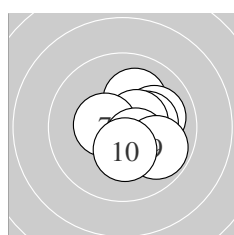
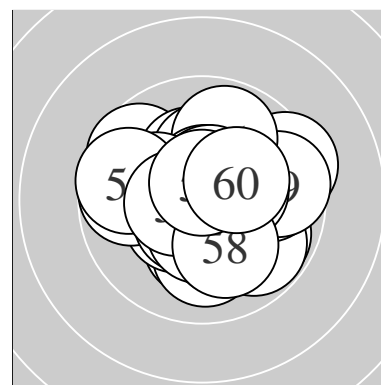

Serie 1:  
 10.1 ↗ 10.0 → 10.3 \* 10.7 \* 10.4 \*  
 10.5 \* 10.5 \* 10.4 \* 9.8 ↘ 10.3 \*  
 beste Teiler 56.5 (4.) 106.2 (6.) 124.0 (7.)  
 Trefferlage 0.95 mm rechts, 0.14 mm tief  
 Streuwert 1.06, horizontal: 1.05, vertikal: 1.06

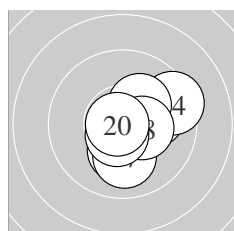

Serie 2:  
 10.5 \* 10.2 \* 10.0 → 9.4 → 10.8 \*  
 10.2 \* 10.0 ↓ 10.4 \* 10.6 \* 10.8 \*  
 beste Teiler 36.2 (15.) 38.0 (20.) 85.0 (19.)  
 Trefferlage 0.83 mm rechts, 0.17 mm tief  
 Streuwert 1.26, horizontal: 1.29, vertikal: 1.22

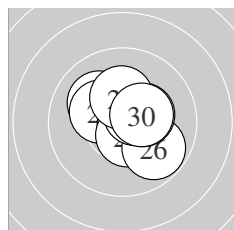

Serie 3:  
 10.1 ↘ 10.8 \* 10.3 \* 10.8 \* 10.6 \*  
 9.8 ↘ 10.5 \* 10.3 \* 10.3 \* 10.4 \*  
 beste Teiler 29.4 (22.) 46.8 (24.) 98.0 (25.)  
 Trefferlage 0.34 mm rechts, 0.28 mm hoch  
 Streuwert 1.14, horizontal: 1.23, vertikal: 1.04

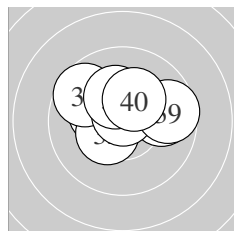

Serie 4:  
 10.3 \* 10.4 \* 10.3 \* 10.4 \* 9.7 ↖  
 9.8 → 10.8 \* 10.2 \* 9.6 → 10.3 \*  
 beste Teiler 48.1 (37.) 132.0 (34.) 136.0 (32.)  
 Trefferlage 0.19 mm rechts, 0.91 mm hoch  
 Streuwert 1.41, horizontal: 1.82, vertikal: 0.81

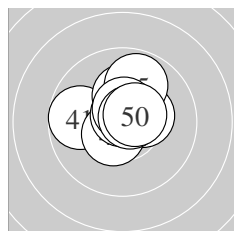

Serie 5:  
 9.7 ← 10.2 \* 10.9 \* 10.4 \* 9.9 ↗  
 10.5 \* 10.8 \* 10.6 \* 10.7 \* 10.5 \*  
 beste Teiler 9.4 (43.) 50.1 (47.) 62.1 (49.)  
 Trefferlage 0.02 mm rechts, 0.65 mm hoch  
 Streuwert 1.10, horizontal: 1.22, vertikal: 0.96

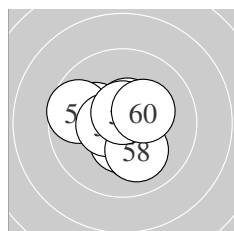

Serie 6:  
 10.3 \* 10.6 \* 10.2 \* 10.4 \* 10.1 ↖  
 9.7 ← 10.5 \* 10.1 ↓ 10.7 \* 10.3 \*  
 beste Teiler 73.0 (59.) 98.6 (52.) 106.7 (57.)  
 Trefferlage 0.20 mm links, 0.27 mm tief  
 Streuwert 1.33, horizontal: 1.43, vertikal: 1.22

Meyton Elektronik

**ISSF AR Women Jun – Wertung – Juniorinnen**

StandNr: 128

**Tashtchiev, Olga** #342

**StartNr: 77**

19. Januar 2020 11:44

Israel

---

\_\_\_\_\_  
Unterschrift des Schützen

Meyton Elektronik

Ergebnis: **602.5** (574)

Serien: 98.1 102.5 100.1 98.2 99.2 104.4

Zähler: 37 20 3 0 0 0 0 0 0 0

Innenzehner: 32

weiteste: 628 (22), 578 (43), 557 (40)

beste Teiler 24.1 (12.) 36.7 (29.) 37.0 (5.)

Trefferlage 0.24 mm rechts, 0.13 mm hoch

Streuwert 1.92, horizontal: 2.34, vertikal: 1.39

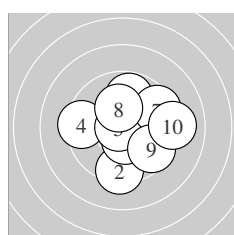
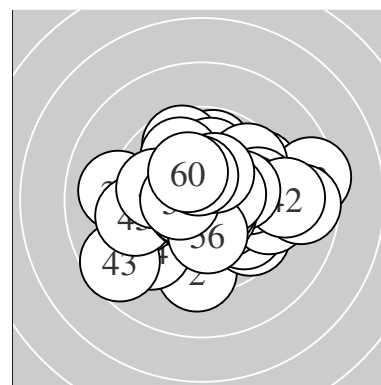

Serie 1:

10.0 →	9.3 ↓	10.4 *	9.4 ←	10.8 *
9.8 ↑	9.5 ↗	10.2 *	9.6 ↘	9.1 →

beste Teiler 37.0 (5.) 126.6 (3.) 183.7 (8.)

Trefferlage 0.89 mm rechts, 0.11 mm tief

Streuwert 2.22, horizontal: 2.42, vertikal: 2.01

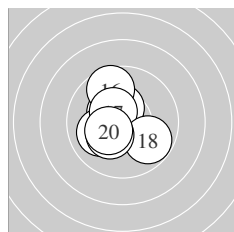

Serie 2:

10.4 *	10.9 *	10.4 *	10.4 *	10.0 ←
9.6 ↖	10.4 *	9.8 ↘	10.3 *	10.3 *

beste Teiler 24.1 (12.) 131.7 (17.) 134.6 (13.)

Trefferlage 0.71 mm links, 0.13 mm hoch

Streuwert 1.33, horizontal: 1.21, vertikal: 1.45

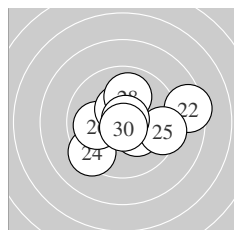

Serie 3:

10.7 *	8.4 →	10.3 *	9.3 ↗	9.4 →
10.0 ←	10.4 *	10.0 ↑	10.8 *	10.8 *

beste Teiler 36.7 (29.) 48.6 (30.) 51.0 (21.)

Trefferlage 0.64 mm rechts, 0.02 mm hoch

Streuwert 2.15, horizontal: 2.67, vertikal: 1.45

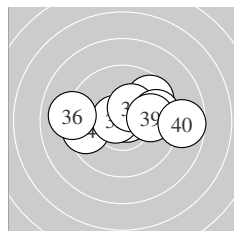

Serie 4:

9.8 →	10.8 *	9.6 ↗	9.5 ←	10.7 *
9.1 ←	10.4 *	9.7 →	9.9 →	8.7 →

beste Teiler 46.8 (32.) 68.4 (35.) 148.9 (37.)

Trefferlage 0.91 mm rechts, 0.48 mm hoch

Streuwert 2.30, horizontal: 3.16, vertikal: 0.78

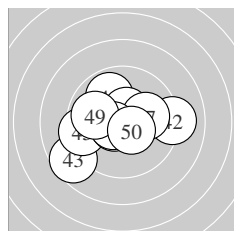

Serie 5:

9.9 ↖	9.1 →	8.6 ↙	10.5 *	9.4 ←
10.6 *	10.1 →	10.6 *	9.9 ←	10.5 *

beste Teiler 91.2 (46.) 96.2 (48.) 106.8 (44.)

Trefferlage 0.58 mm links, 0.12 mm tief

Streuwert 2.24, horizontal: 2.77, vertikal: 1.53

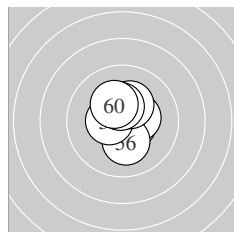

Serie 6:

10.6 *	10.7 *	10.6 *	10.4 *	10.4 *
10.2 *	10.5 *	10.3 *	10.4 *	10.3 *

beste Teiler 60.4 (52.) 78.4 (53.) 96.2 (51.)

Trefferlage 0.31 mm rechts, 0.40 mm hoch

Streuwert 0.94, horizontal: 0.83, vertikal: 1.03

Meyton Elektronik

**ISSF AR Women Jun – Wertung – Juniorinnen**

StandNr: 129

**Thum, Julia** #223

**StartNr: 78**

19. Januar 2020 11:50

T – SG Fügenberg

---

Unterschrift des Schützen

---

Meyton Elektronik



Ergebnis:	<b>606.2</b>	(582)							
Serien:	101.7	100.6	99.5	100.8	101.2	102.4			
Zähler:	43	16	1	0	0	0	0	0	0
Innenzehner:	30								
weiteste:	561	(23),	471	(49),	437	(2)			
beste Teiler	49.4	(8.)	61.7	(32.)	67.7	(20.)			
Trefferlage	0.50 mm links, 0.49 mm hoch								
Streuwert	1.63, horizontal: 1.65, vertikal: 1.61								

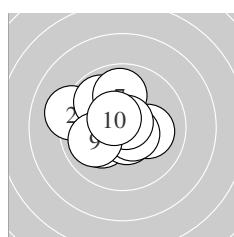
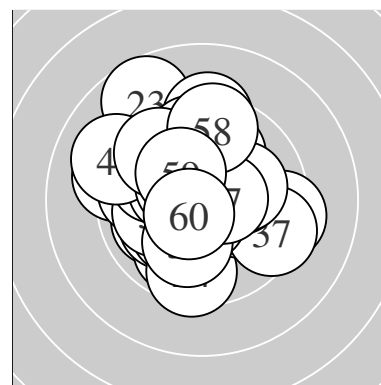

Serie 1:						
	10.1 ↙	9.2 ↖	10.1 →	10.6 *	10.6 *	
	9.9 ↘	9.9 ↑	10.8 *	10.0 ↖	10.5 *	
beste Teiler	49.4	(8.)	91.9	(4.)	99.5	(5.)
Trefferlage	0.73 mm links, 0.30 mm hoch					
Streuwert	1.58, horizontal: 1.80, vertikal: 1.32					

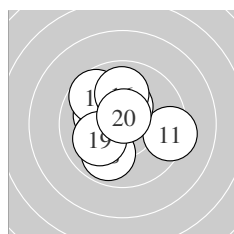

Serie 2:						
	9.4 →	10.2 *	10.4 *	10.1 ↖	9.7 ↘	
	9.9 ↑	10.2 *	9.9 ↙	10.1 ↖	10.7 *	
beste Teiler	67.7	(20.)	148.4	(13.)	194.5	(17.)
Trefferlage	0.61 mm links, 0.08 mm hoch					
Streuwert	1.76, horizontal: 1.83, vertikal: 1.68					

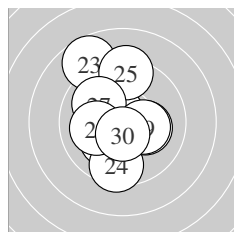

Serie 3:						
	10.6 *	10.2 *	8.7 ↘	9.5 ↓	9.3 ↑	
	10.2 *	10.0 ↘	10.1 ↖	10.3 *	10.6 *	
beste Teiler	87.4	(21.)	99.0	(30.)	175.8	(29.)
Trefferlage	0.53 mm links, 0.38 mm hoch					
Streuwert	2.11, horizontal: 1.56, vertikal: 2.55					

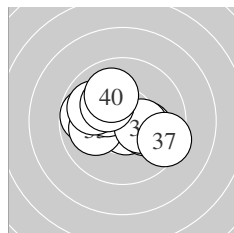

Serie 4:						
	9.8 ↖	10.7 *	10.0 ↖	10.2 *	10.3 *	
	10.3 *	9.4 →	9.9 ↘	10.2 *	10.0 ↘	
beste Teiler	61.7	(32.)	158.6	(36.)	160.2	(35.)
Trefferlage	0.38 mm links, 0.22 mm hoch					
Streuwert	1.69, horizontal: 2.10, vertikal: 1.14					

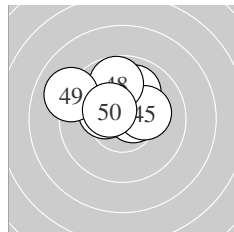

Serie 5:						
	10.1 ↑	10.0 ↗	10.5 *	10.6 *	10.2 *	
	10.2 *	10.3 *	9.8 ↑	9.1 ↖	10.4 *	
beste Teiler	91.3	(44.)	109.6	(43.)	131.4	(50.)
Trefferlage	0.54 mm links, 1.35 mm hoch					
Streuwert	1.36, horizontal: 1.70, vertikal: 0.91					

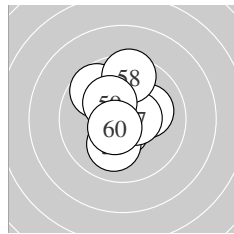

Serie 6:						
	9.7 ↘	10.5 *	10.6 *	10.1 →	10.5 *	
	10.1 ↓	10.5 *	9.5 ↑	10.3 *	10.6 *	
beste Teiler	87.0	(53.)	95.5	(60.)	103.2	(57.)
Trefferlage	0.24 mm links, 0.59 mm hoch					
Streuwert	1.41, horizontal: 1.17, vertikal: 1.62					

Meyton Elektronik

**ISSF AR Women Jun – Wertung – Juniorinnen**

StandNr: 130

**Artoni, Chiara** #172

**StartNr: 79**

19. Januar 2020 11:22

ITA – Accademia

---

\_\_\_\_\_  
Unterschrift des Schützen

Meyton Elektronik

Ergebnis: **576.0** (547)

Serien: 98.7 98.3 94.1 100.4 93.0 91.5

Zähler: 22 30 4 3 0 0 1 0 0 0

Innenzehner: 21

weiteste: 1673 (50), 909 (25), 801 (53)

beste Teiler 47.3 (17.) 48.0 (36.) 49.2 (32.)

Trefferlage 1.02 mm links, 1.13 mm hoch

Streuwert 2.87, horizontal: 3.59, vertikal: 1.89

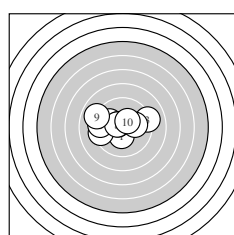
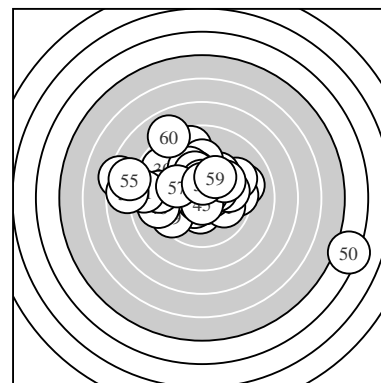

Serie 1:

10.3 *	9.9 ↖	9.1 →	9.4 ←	10.6 *
9.4 ←	10.1 →	10.5 *	9.0 ↖	10.4 *

beste Teiler 93.7 (5.) 107.7 (8.) 138.6 (10.)

Trefferlage 0.91 mm links, 0.47 mm hoch

Streuwert 2.18, horizontal: 2.90, vertikal: 1.05

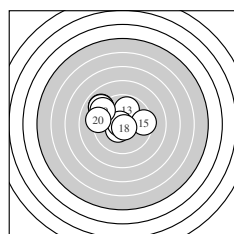

Serie 2:

10.7 *	9.0 ↖	9.9 ↑	9.0 ↖	9.4 →
10.4 *	10.8 *	10.7 *	9.2 ↖	9.2 ←

beste Teiler 47.3 (17.) 61.0 (11.) 63.0 (18.)

Trefferlage 1.20 mm links, 1.13 mm hoch

Streuwert 2.15, horizontal: 2.62, vertikal: 1.52

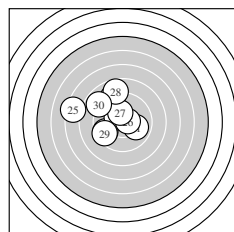

Serie 3:

9.9 ↘	9.6 ←	9.1 ↖	10.4 *	7.3 ←
10.6 *	10.3 *	8.7 ↑	9.4 ←	8.8 ↖

beste Teiler 93.3 (26.) 135.0 (24.) 173.1 (27.)

Trefferlage 2.05 mm links, 1.33 mm hoch

Streuwert 2.81, horizontal: 3.08, vertikal: 2.51

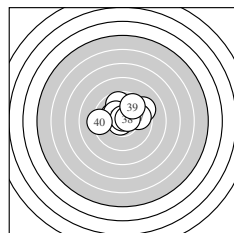

Serie 4:

10.2 *	10.8 *	9.3 ↗	9.7 ↑	10.2 *
10.8 *	9.8 →	10.6 *	9.7 ↗	9.3 ←

beste Teiler 48.0 (36.) 49.2 (32.) 98.4 (38.)

Trefferlage 0.09 mm rechts, 1.12 mm hoch

Streuwert 1.80, horizontal: 2.28, vertikal: 1.11

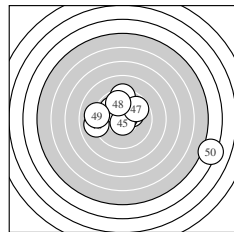

Serie 5:

10.3 *	10.7 *	9.9 ↖	9.3 ↑	10.7 *
9.1 ←	9.8 ↗	9.8 ↑	9.1 ←	4.3 →

beste Teiler 62.0 (45.) 65.1 (42.) 174.4 (41.)

Trefferlage 0.82 mm rechts, 0.47 mm hoch

Streuwert 4.47, horizontal: 5.72, vertikal: 2.67

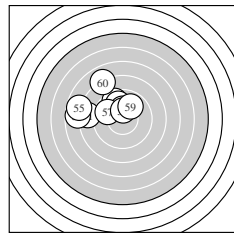

Serie 6:

8.5 ←	9.5 ↖	7.7 ←	9.8 ↑	7.8 ←
10.2 *	9.8 ↖	10.3 *	9.9 ↗	8.0 ↖

beste Teiler 152.2 (58.) 183.0 (56.) 263.8 (59.)

Trefferlage 2.88 mm links, 2.26 mm hoch

Streuwert 2.69, horizontal: 3.39, vertikal: 1.72

Meyton Elektronik

**ISSF AR Women Jun – Wertung – Juniorinnen**

StandNr: 131

**Fankhauser, Lisa** #189

**StartNr: 80**

19. Januar 2020 11:21

T – SG Fügenberg

---

\_\_\_\_\_  
Unterschrift des Schützen

Meyton Elektronik

Ergebnis:	<b>620.8</b>	(591)							
Serien:	105.4	103.6	105.2	101.5	101.7	103.4			
Zähler:	51	9	0	0	0	0	0	0	0
Innenzehner:	45								
weiteste:	439 (42), 384 (38), 340 (41)								
beste Teiler	14.5 (56.) 40.7 (1.) 53.9 (44.)								
Trefferlage	0.18 mm rechts, 0.10 mm hoch								
Streuwert	1.25, horizontal: 1.45, vertikal: 1.00								

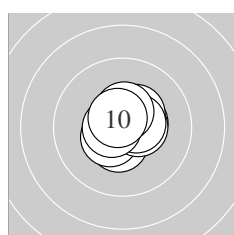
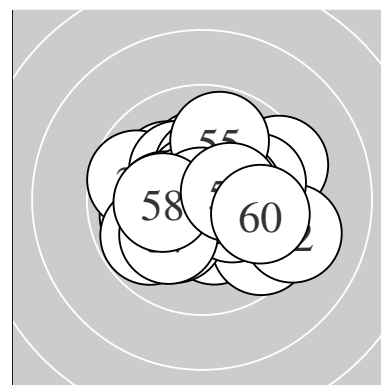

Serie 1:					
	10.8 *	10.5 *	10.5 *	10.5 *	10.5 *
	10.4 *	10.5 *	10.5 *	10.6 *	10.6 *
beste Teiler	40.7 (1.) 79.6 (10.) 82.1 (9.)				
Trefferlage	0.21 mm rechts, 0.19 mm hoch				
Streuwert	0.79, horizontal: 0.83, vertikal: 0.73				

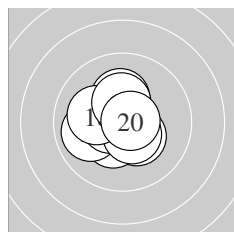

Serie 2:					
	10.5 *	10.3 *	10.4 *	9.9 ↖	10.6 *
	10.5 *	10.2 *	10.1 ↖	10.4 *	10.7 *
beste Teiler	60.8 (20.) 93.7 (15.) 112.2 (11.)				
Trefferlage	0.50 mm links, 0.02 mm hoch				
Streuwert	1.10, horizontal: 1.14, vertikal: 1.06				

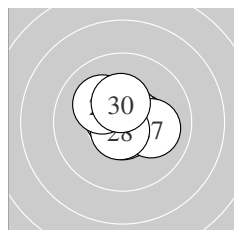

Serie 3:					
	10.7 *	10.7 *	10.7 *	10.4 *	10.7 *
	10.7 *	10.1 →	10.7 *	10.1 ↖	10.4 *
beste Teiler	61.2 (25.) 64.1 (28.) 71.5 (21.)				
Trefferlage	0.20 mm rechts, 0.19 mm hoch				
Streuwert	0.92, horizontal: 1.04, vertikal: 0.77				

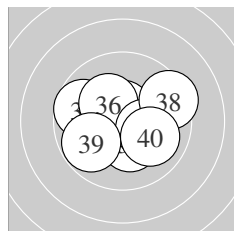

Serie 4:					
	10.3 *	10.7 *	10.5 *	10.6 *	9.7 ↖
	10.3 *	10.2 *	9.4 ↗	9.8 ↖	10.0 ↘
beste Teiler	75.1 (32.) 86.0 (34.) 101.9 (33.)				
Trefferlage	0.09 mm rechts, 0.14 mm hoch				
Streuwert	1.66, horizontal: 1.99, vertikal: 1.25				

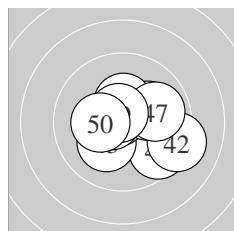

Serie 5:					
	9.6 ↘	9.2 →	10.2 *	10.7 *	10.1 →
	10.4 *	9.9 →	10.6 *	10.7 *	10.3 *
beste Teiler	53.9 (44.) 74.3 (49.) 87.9 (48.)				
Trefferlage	0.68 mm rechts, 0.08 mm tief				
Streuwert	1.63, horizontal: 1.96, vertikal: 1.21				

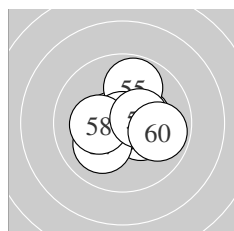

Serie 6:					
	10.6 *	10.4 *	10.7 *	10.4 *	9.8 ↑
	10.9 *	10.1 ↖	10.2 *	10.4 *	9.9 →
beste Teiler	14.5 (56.) 69.8 (53.) 97.0 (51.)				
Trefferlage	0.39 mm rechts, 0.16 mm hoch				
Streuwert	1.27, horizontal: 1.41, vertikal: 1.12				

Meyton Elektronik

**ISSF AR Women Jun – Wertung – Juniorinnen**

**StartNr: 81**

StandNr: 132

19. Januar 2020 11:37

**Alleazard, Justine** #319

FRA

---

\_\_\_\_\_  
Unterschrift des Schützen

Meyton Elektronik

Ergebnis:	<b>610.0</b>	(581)							
Serien:	101.6	101.4	102.7	102.2	99.5	102.6			
Zähler:	41	19	0	0	0	0	0	0	0
Innenzehner:	34								
weiteste:	498 (46), 448 (3), 390 (14)								
beste Teiler	9.0 (8.)	30.0 (36.)	43.5 (4.)						
Trefferlage	0.01 mm rechts, 0.13 mm tief								
Streuwert	1.62, horizontal: 1.80, vertikal: 1.40								

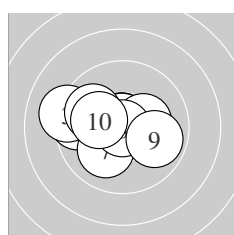
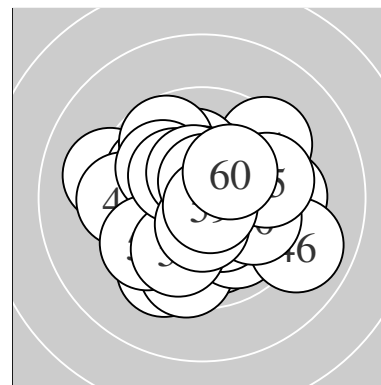

Serie 1:	9.5 ←	10.8 *	9.2 ↖	10.8 *	10.3 *
	9.9 ↖	10.1 ↙	10.9 *	9.9 →	10.2 *
beste Teiler	9.0 (8.)	43.5 (4.)	47.6 (2.)		
Trefferlage	0.94 mm links, 0.17 mm hoch				
Streuwert	1.66, horizontal: 2.17, vertikal: 0.90				

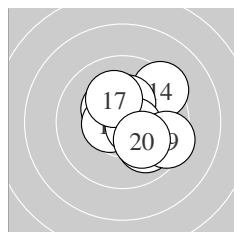

Serie 2:	10.4 *	10.6 *	10.4 *	9.4 ↗	10.3 *
	10.6 *	10.2 *	9.9 ↘	9.5 →	10.1 ↘
beste Teiler	92.0 (16.)	100.9 (12.)	147.0 (11.)		
Trefferlage	0.90 mm rechts, 0.32 mm hoch				
Streuwert	1.55, horizontal: 1.57, vertikal: 1.52				

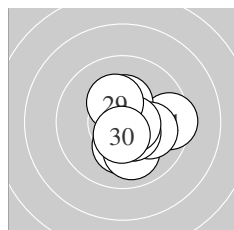

Serie 3:	9.5 →	10.5 *	10.2 *	10.4 *	10.0 ↓
	10.1 →	10.5 *	10.6 *	10.3 *	10.6 *
beste Teiler	78.8 (28.)	100.2 (30.)	104.0 (22.)		
Trefferlage	0.73 mm rechts, 0.47 mm tief				
Streuwert	1.27, horizontal: 1.28, vertikal: 1.26				

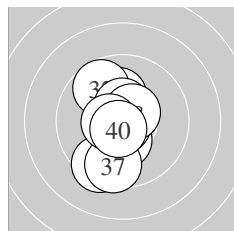

Serie 4:	10.1 ↑	9.7 ↖	10.5 *	9.4 ↙	10.4 *
	10.8 *	9.6 ↓	10.5 *	10.5 *	10.7 *
beste Teiler	30.0 (36.)	70.7 (40.)	101.1 (38.)		
Trefferlage	0.51 mm links, 0.29 mm tief				
Streuwert	1.55, horizontal: 0.81, vertikal: 2.04				

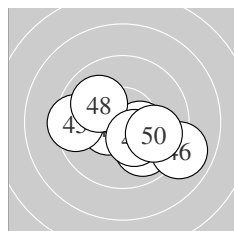

Serie 5:	9.9 ←	10.1 ↖	9.9 ↘	10.5 *	9.5 ←
	9.0 →	10.4 *	10.0 ↖	10.3 *	9.9 →
beste Teiler	116.6 (44.)	150.4 (47.)	156.0 (49.)		
Trefferlage	0.05 mm links, 0.49 mm tief				
Streuwert	2.01, horizontal: 2.60, vertikal: 1.17				

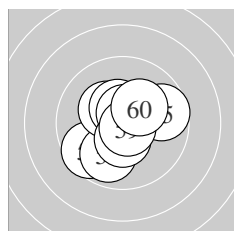

Serie 6:	10.7 *	9.6 ↙	9.9 ↙	10.3 *	9.7 →
	10.4 *	10.5 *	10.6 *	10.7 *	10.2 *
beste Teiler	53.7 (59.)	63.9 (51.)	80.6 (58.)		
Trefferlage	0.03 mm links, 0.04 mm tief				
Streuwert	1.47, horizontal: 1.53, vertikal: 1.41				

Meyton Elektronik

**ISSF AR Women Jun – Wertung – Juniorinnen**

StandNr: 133

**Krainz, Nadja #62**

**StartNr: 82**

19. Januar 2020 11:21

OÖ – LHA Linz

---

\_\_\_\_\_  
Unterschrift des Schützen

Meyton Elektronik



Ergebnis:	<b>618.9</b>	(592)
Serien:	103.4	101.9 104.3 103.5 102.3 103.5
Zähler:	52 8	0 0 0 0 0 0 0 0
Innenzehner:	43	
weiteste:	412 (1), 397 (19), 349 (48)	
beste Teiler	13.0 (26.)	16.5 (25.) 31.9 (33.)
Trefferlage	0.14 mm rechts, 0.05 mm hoch	
Streuwert	1.29, horizontal: 1.39, vertikal: 1.18	

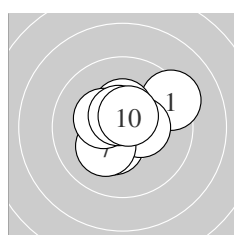
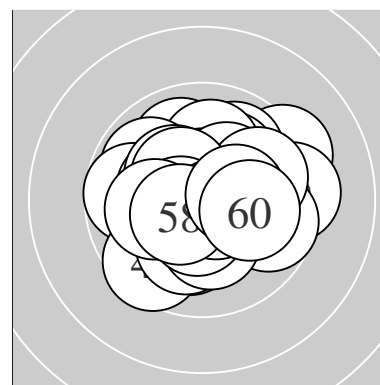

Serie 1:	9.3 ↗	10.4 *	10.4 *	10.6 *	10.6 *
	10.4 *	10.2 *	10.3 *	10.6 *	10.6 *
beste Teiler	77.7 (4.) 91.5 (5.) 92.6 (9.)				
Trefferlage	0.13 mm rechts, 0.33 mm hoch				
Streuwert	1.30, horizontal: 1.49, vertikal: 1.09				

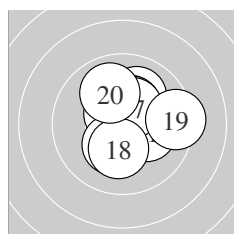

Serie 2:	10.2 *	10.0 ↗	10.6 *	10.3 *	10.4 *
	10.4 *	10.4 *	10.2 *	9.4 →	10.0 ↘
beste Teiler	100.7 (13.) 142.5 (17.) 149.4 (16.)				
Trefferlage	0.59 mm rechts, 0.55 mm hoch				
Streuwert	1.45, horizontal: 1.48, vertikal: 1.43				

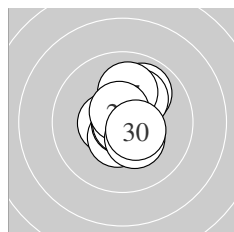

Serie 3:	10.5 *	9.9 ↗	10.5 *	10.1 ↗	10.9 *
	10.9 *	10.0 ↑	10.6 *	10.4 *	10.5 *
beste Teiler	13.0 (26.) 16.5 (25.) 82.5 (28.)				
Trefferlage	0.30 mm rechts, 0.36 mm hoch				
Streuwert	1.08, horizontal: 0.81, vertikal: 1.29				

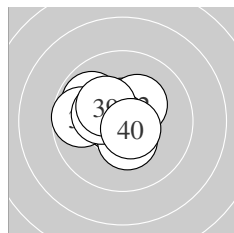

Serie 4:	10.6 *	10.3 *	10.8 *	9.9 ↘	10.6 *
	9.7 ←	10.4 *	10.3 *	10.3 *	10.6 *
beste Teiler	31.9 (33.) 78.6 (35.) 82.7 (40.)				
Trefferlage	0.72 mm links, 0.35 mm hoch				
Streuwert	1.13, horizontal: 1.33, vertikal: 0.89				

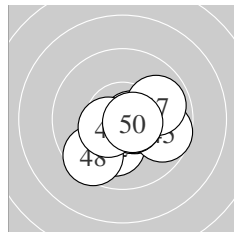

Serie 5:	10.0 →	10.1 ↓	10.6 *	10.7 *	9.7 →
	10.6 *	9.9 →	9.6 ↙	10.5 *	10.6 *
beste Teiler	67.6 (44.) 76.0 (46.) 79.0 (50.)				
Trefferlage	0.69 mm rechts, 0.69 mm tief				
Streuwert	1.37, horizontal: 1.64, vertikal: 1.03				

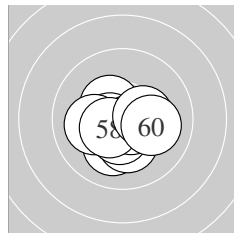

Serie 6:	10.1 ↓	10.2 *	10.4 *	10.5 *	10.6 *
	10.7 *	10.1 ←	10.5 *	10.3 *	10.1 →
beste Teiler	75.1 (56.) 99.6 (55.) 117.0 (54.)				
Trefferlage	0.12 mm links, 0.59 mm tief				
Streuwert	1.11, horizontal: 1.29, vertikal: 0.88				

Meyton Elektronik

**ISSF AR Women Jun – Wertung – Juniorinnen**

StandNr: 134

**Stefankova, Katerina #11**

**StartNr: 83**

19. Januar 2020 11:38

CZE

---

Unterschrift des Schützen

Meyton Elektronik

Ergebnis:	<b>625.1</b>	(596) <sup>QF</sup>
Serien:	104.5	103.3 106.0 104.5 102.1 104.7
Zähler:	56	4 0 0 0 0 0 0 0 0
Innenzehner:	51	
weiteste:	370	(47), 288 (15), 283 (48)
beste Teiler	5.0	(33.) 35.3 (31.) 37.0 (24.)
Trefferlage	0.20 mm	links, 0.00 mm
Streuwert	1.07,	horizontal: 1.06, vertikal: 1.09

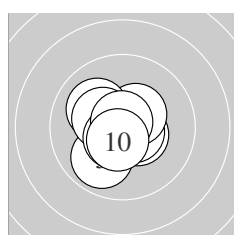
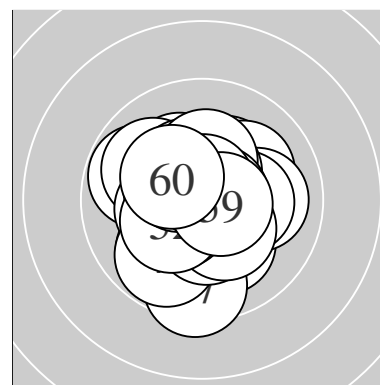

Serie 1:	10.5 *	10.6 *	9.9 ✓	10.4 *	10.7 *
	10.1 ✗	10.3 *	10.6 *	10.8 *	10.6 *
beste Teiler	38.6	(9.) 59.5 (5.)	84.3 (2.)		
Trefferlage	0.34 mm	links, 0.11 mm	tief		
Streuwert	1.04,	horizontal: 1.04, vertikal: 1.03			

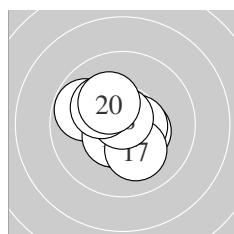

Serie 2:	10.5 *	10.2 *	10.4 *	10.6 *	9.8 ✗
	10.5 *	10.1 ✗	10.8 *	10.2 *	10.2 *
beste Teiler	44.1	(18.) 100.9 (14.)	104.8 (11.)		
Trefferlage	0.51 mm	links, 0.07 mm	hoch		
Streuwert	1.21,	horizontal: 1.32, vertikal: 1.09			

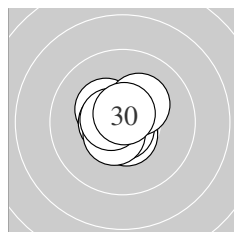

Serie 3:	10.8 *	10.6 *	10.3 *	10.8 *	10.8 *
	10.6 *	10.3 *	10.5 *	10.6 *	10.7 *
beste Teiler	37.0	(24.) 39.2 (21.)	48.1 (25.)		
Trefferlage	0.27 mm	links, 0.05 mm	hoch		
Streuwert	0.71,	horizontal: 0.70, vertikal: 0.72			

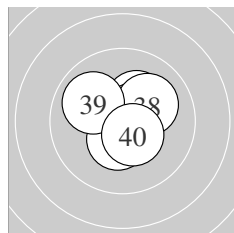

Serie 4:	10.8 *	10.3 *	10.9 *	10.6 *	10.3 *
	10.6 *	10.4 *	10.1 ✗	10.0 ✗	10.5 *
beste Teiler	5.0	(33.) 35.3 (31.)	77.1 (34.)		
Trefferlage	0.26 mm	rechts, 0.42 mm	hoch		
Streuwert	1.01,	horizontal: 1.07, vertikal: 0.94			

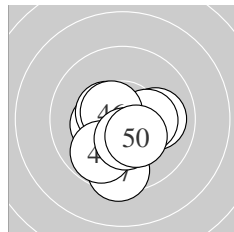

Serie 5:	10.0 →	10.4 *	10.3 *	10.3 *	10.5 *
	10.6 *	9.5 ↓	9.8 ✓	10.4 *	10.3 *
beste Teiler	95.1	(46.) 125.1 (45.)	140.8 (42.)		
Trefferlage	0.04 mm	links, 0.96 mm	tief		
Streuwert	1.35,	horizontal: 1.36, vertikal: 1.34			

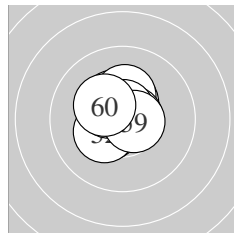

Serie 6:	10.5 *	10.3 *	10.4 *	10.4 *	10.5 *
	10.3 *	10.7 *	10.7 *	10.6 *	10.3 *
beste Teiler	60.2	(58.) 66.2 (57.)	82.9 (59.)		
Trefferlage	0.32 mm	links, 0.49 mm	hoch		
Streuwert	0.85,	horizontal: 0.82, vertikal: 0.88			

Meyton Elektronik

**ISSF AR Women Jun – Wertung – Juniorinnen**

**StartNr: 84**

StandNr: 135

19. Januar 2020 11:40

**Bordet, Jade #307**

FRA

---

QF – Schütze hat sich fürs Finale qualifiziert

---

Unterschrift des Schützen

Meyton Elektronik

Ergebnis: **618.7** (587)

Serien: 103.6 103.4 101.5 102.7 102.9 104.6

Zähler: 47 13 0 0 0 0 0 0 0 0

Innenzehner: 42

weiteste: 446 (29), 392 (39), 357 (34)

beste Teiler 9.4 (58.) 30.0 (60.) 33.1 (2.)

Trefferlage 0.01 mm links, 0.11 mm tief

Streuwert 1.35, horizontal: 1.43, vertikal: 1.26

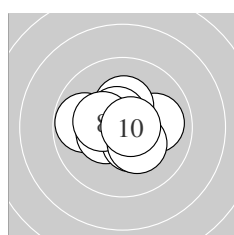
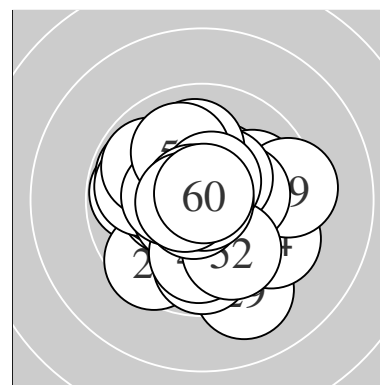

Serie 1:

9.8 ←	10.8 *	10.0 →	10.4 *	10.4 *
10.3 *	10.6 *	10.3 *	10.3 *	10.7 *

beste Teiler 33.1 (2.) 61.1 (10.) 91.7 (7.)

Trefferlage 0.13 mm links, 0.03 mm hoch

Streuwert 1.21, horizontal: 1.48, vertikal: 0.87

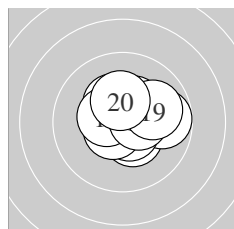

Serie 2:

10.4 *	9.8 →	10.4 *	10.6 *	10.6 *
10.3 *	10.5 *	10.5 *	10.0 →	10.3 *

beste Teiler 85.6 (14.) 91.2 (15.) 121.8 (18.)

Trefferlage 0.57 mm rechts, 0.36 mm hoch

Streuwert 1.16, horizontal: 1.34, vertikal: 0.94

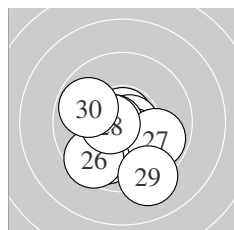

Serie 3:

10.8 *	10.7 *	10.4 *	10.7 *	9.9 ↙
9.6 ↗	9.8 ↘	10.6 *	9.2 ↘	9.8 ↖

beste Teiler 35.0 (21.) 54.4 (22.) 68.6 (24.)

Trefferlage 0.19 mm links, 1.06 mm tief

Streuwert 1.61, horizontal: 1.65, vertikal: 1.58

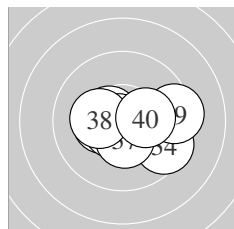

Serie 4:

10.4 *	10.5 *	10.6 *	9.5 ↘	10.5 *
10.8 *	10.4 *	10.3 *	9.4 →	10.3 *

beste Teiler 35.5 (36.) 90.6 (33.) 107.3 (35.)

Trefferlage 0.42 mm rechts, 0.36 mm tief

Streuwert 1.46, horizontal: 1.92, vertikal: 0.77

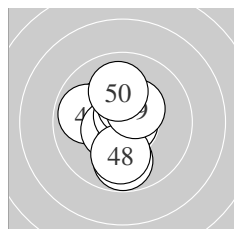

Serie 5:

9.8 ↓	10.3 *	9.9 ←	10.8 *	10.5 *
10.8 *	10.4 *	10.0 ↓	10.4 *	10.0 ↑

beste Teiler 42.2 (44.) 49.2 (46.) 107.6 (45.)

Trefferlage 0.34 mm links, 0.07 mm hoch

Streuwert 1.37, horizontal: 1.02, vertikal: 1.64

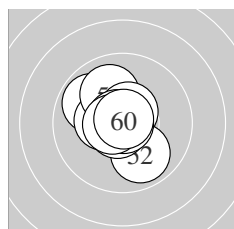

Serie 6:

9.9 ↘	9.9 ↘	10.4 *	10.7 *	10.0 ↗
10.6 *	10.8 *	10.9 *	10.6 *	10.8 *

beste Teiler 9.4 (58.) 30.0 (60.) 49.3 (57.)

Trefferlage 0.43 mm links, 0.23 mm hoch

Streuwert 1.10, horizontal: 1.01, vertikal: 1.18

Meyton Elektronik

**ISSF AR Women Jun – Wertung –**

**Juniorinnen**

**StartNr: 85**

StandNr: 136

19. Januar 2020 11:52

**Shamon, Noor Syaakirah #358**

**SGP**

---

\_\_\_\_\_  
Unterschrift des Schützen

Meyton Elektronik

Ergebnis:	<b>623.7</b>	(593) <sup>QF</sup>						
Serien:	104.0	104.4	102.1	105.1	104.2	103.9		
Zähler:	53	7	0	0	0	0	0	0
Innenzehner:	46							
weiteste:	339 (22), 309 (50), 288 (14)							
beste Teiler	25.0 (18.)	39.2 (51.)	44.0 (30.)					
Trefferlage	0.12 mm rechts, 0.13 mm hoch							
Streuwert	1.12, horizontal: 1.11, vertikal: 1.14							

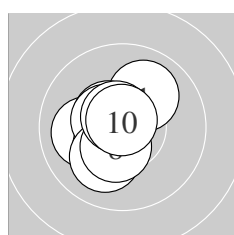
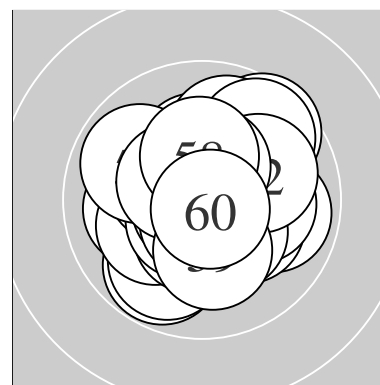

Serie 1:	10.0 ↗	10.0 ←	10.4 *	10.7 *	10.5 *
	10.5 *	10.1 ↘	10.4 *	10.6 *	10.8 *
beste Teiler	45.5 (10.)	70.0 (4.)	77.1 (9.)		
Trefferlage	0.62 mm links, 0.07 mm tief				
Streuwert	1.02, horizontal: 0.90, vertikal: 1.13				

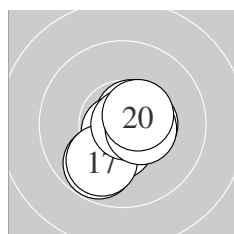

Serie 2:	10.6 *	10.4 *	10.6 *	9.8 ↘	10.7 *
	10.5 *	9.9 ↘	10.9 *	10.5 *	10.5 *
beste Teiler	25.0 (18.)	56.2 (15.)	77.0 (13.)		
Trefferlage	0.03 mm rechts, 0.63 mm tief				
Streuwert	1.02, horizontal: 0.97, vertikal: 1.06				

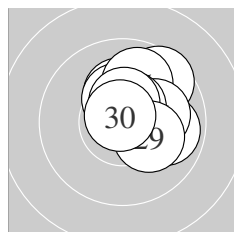

Serie 3:	9.9 →	9.6 ↗	10.2 *	10.4 *	9.9 ↗
	10.1 →	10.5 *	10.5 *	10.2 *	10.8 *
beste Teiler	44.0 (30.)	107.3 (27.)	120.4 (28.)		
Trefferlage	0.93 mm rechts, 0.98 mm hoch				
Streuwert	1.14, horizontal: 1.13, vertikal: 1.15				

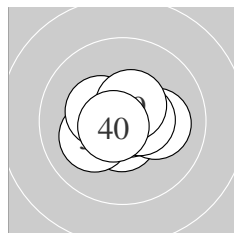

Serie 4:	10.6 *	10.6 *	10.7 *	10.2 *	10.1 →
	10.4 *	10.8 *	10.5 *	10.5 *	10.7 *
beste Teiler	45.0 (37.)	55.3 (33.)	66.7 (40.)		
Trefferlage	0.04 mm rechts, 0.13 mm tief				
Streuwert	0.93, horizontal: 1.14, vertikal: 0.64				

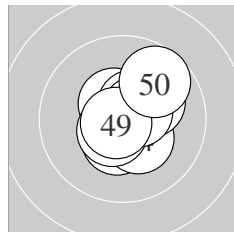

Serie 5:	10.5 *	10.8 *	10.4 *	10.3 *	10.5 *
	10.1 ↗	10.6 *	10.5 *	10.8 *	9.7 ↗
beste Teiler	48.0 (49.)	49.0 (42.)	97.8 (47.)		
Trefferlage	0.47 mm rechts, 0.25 mm hoch				
Streuwert	1.05, horizontal: 0.95, vertikal: 1.14				

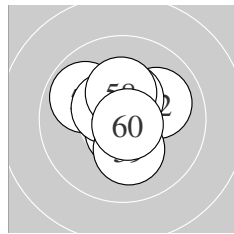

Serie 6:	10.8 *	10.0 ↗	10.4 *	9.9 ↘	10.6 *
	10.4 *	10.5 *	10.3 *	10.2 *	10.8 *
beste Teiler	39.2 (51.)	46.7 (60.)	77.9 (55.)		
Trefferlage	0.08 mm links, 0.42 mm hoch				
Streuwert	1.14, horizontal: 1.13, vertikal: 1.14				

Meyton Elektronik

QF – Schütze hat sich fürs Finale qualifiziert

\_\_\_\_\_  
Unterschrift des Schützen

Meyton Elektronik



Ergebnis: **592.0** (563)

Serien: 98.2 97.6 100.5 97.7 99.9 98.1

Zähler: 26 31 3 0 0 0 0 0 0 0

Innenzehner: 19

weiteste: 651 (60), 570 (31), 567 (16)

beste Teiler 7.8 (29.) 50.0 (42.) 53.2 (55.)

Trefferlage 0.04 mm rechts, 0.38 mm hoch

Streuwert 2.16, horizontal: 2.54, vertikal: 1.69

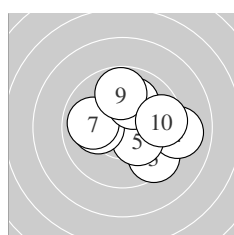
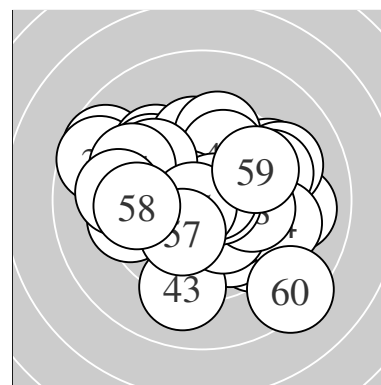

Serie 1:

10.0 →	9.9 →	9.5 ↘	9.0 →	10.3 *
10.1 ←	9.9 ←	10.1 ↑	9.8 ↑	9.6 →

beste Teiler 169.1 (5.) 210.0 (6.) 225.2 (8.)

Trefferlage 1.31 mm rechts, 0.22 mm hoch

Streuwert 1.97, horizontal: 2.34, vertikal: 1.52

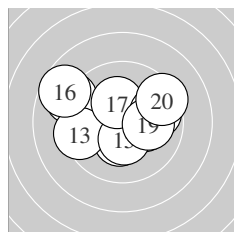

Serie 2:

9.0 ↖	10.3 *	9.4 ←	10.2 *	10.4 *
8.7 ↖	10.3 *	9.8 →	10.1 →	9.4 ↗

beste Teiler 145.5 (15.) 158.3 (12.) 175.4 (17.)

Trefferlage 0.34 mm links, 0.47 mm hoch

Streuwert 2.45, horizontal: 3.09, vertikal: 1.57

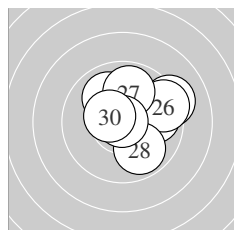

Serie 3:

10.3 *	10.0 ↖	10.5 *	9.9 →	9.2 ↗
9.4 →	9.9 ↑	9.9 ↘	10.9 *	10.5 *

beste Teiler 7.8 (29.) 115.1 (23.) 123.4 (30.)

Trefferlage 1.24 mm rechts, 0.57 mm hoch

Streuwert 1.64, horizontal: 1.80, vertikal: 1.47

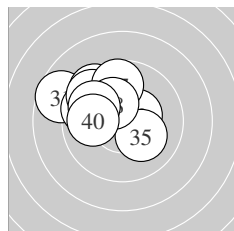

Serie 4:

8.7 ↖	10.4 *	9.5 ↖	9.6 ↖	10.1 ↘
9.6 ↖	9.7 ↑	10.3 *	9.9 ↖	9.9 ←

beste Teiler 128.5 (32.) 174.1 (38.) 202.4 (35.)

Trefferlage 1.69 mm links, 1.32 mm hoch

Streuwert 1.74, horizontal: 2.08, vertikal: 1.31

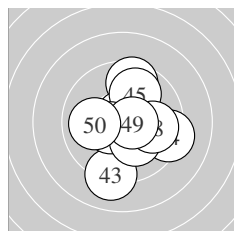

Serie 5:

9.6 ↑	10.8 *	9.1 ↓	9.3 →	9.9 ↑
10.5 *	10.2 *	9.9 →	10.6 *	10.0 ←

beste Teiler 50.0 (42.) 84.3 (49.) 115.3 (46.)

Trefferlage 0.58 mm rechts, 0.21 mm tief

Streuwert 2.01, horizontal: 1.85, vertikal: 2.15

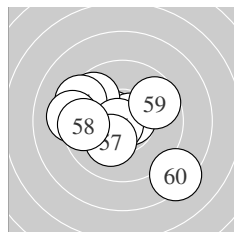

Serie 6:

10.6 *	10.7 *	9.7 ↖	9.4 ↖	10.7 *
9.2 ←	10.2 *	9.6 ←	9.7 →	8.3 ↘

beste Teiler 53.2 (55.) 65.9 (52.) 91.1 (51.)

Trefferlage 0.81 mm links, 0.07 mm tief

Streuwert 2.45, horizontal: 2.86, vertikal: 1.94

**ISSF AR Women Jun – Wertung – Juniorinnen**

StandNr: 139

**Messner, Helena** #170

**StartNr: 88**

19. Januar 2020 11:33

T SG Absam

---

\_\_\_\_\_  
Unterschrift des Schützen

Meyton Elektronik

Ergebnis:	<b>606.5</b>	(583)					
Serien:	99.9	99.5	104.0	101.2	100.5	101.4	
Zähler:	46	11	3	0	0	0	0
Innenzehner:	34						
weiteste:	597 (1), 514 (44), 511 (18)						
beste Teiler	17.0 (30.) 31.2 (46.) 63.6 (29.)						
Trefferlage	0.17 mm rechts, 0.11 mm tief						
Streuwert	1.72, horizontal: 1.52, vertikal: 1.90						

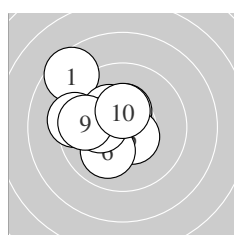
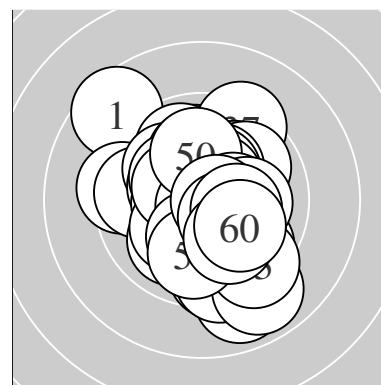

Serie 1:	8.6 ↘	10.4 *	10.3 *	10.4 *	10.5 *
	10.0 ↙	9.4 ←	10.2 *	9.7 ←	10.4 *
beste Teiler	110.3 (5.) 131.7 (2.) 133.0 (10.)				
Trefferlage	1.57 mm links, 0.60 mm hoch				
Streuwert	1.68, horizontal: 1.69, vertikal: 1.66				

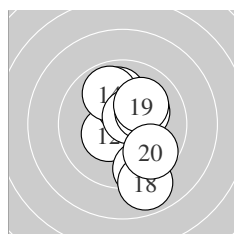

Serie 2:	10.0 ↑	10.4 *	10.3 *	9.9 ↗	10.6 *
	10.2 *	9.4 ↓	8.9 ↓	10.1 ↘	9.7 ↘
beste Teiler	85.6 (15.) 138.4 (12.) 158.2 (13.)				
Trefferlage	0.68 mm rechts, 0.17 mm tief				
Streuwert	2.02, horizontal: 1.24, vertikal: 2.58				

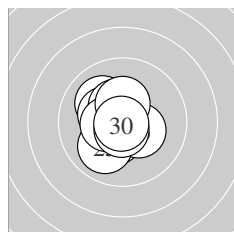

Serie 3:	10.4 *	10.0 ↘	10.3 *	10.4 *	10.0 ↙
	10.4 *	10.5 *	10.4 *	10.7 *	10.9 *
beste Teiler	17.0 (30.) 63.6 (29.) 124.1 (27.)				
Trefferlage	0.58 mm links, 0.01 mm hoch				
Streuwert	1.06, horizontal: 0.90, vertikal: 1.20				

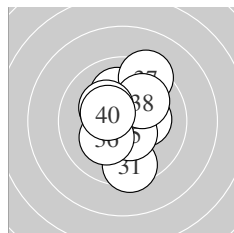

Serie 4:	9.5 ↓	10.2 *	10.7 *	10.1 ↑	10.5 *
	10.2 *	9.3 ↗	10.0 ↗	10.3 *	10.4 *
beste Teiler	65.9 (33.) 115.7 (35.) 138.3 (40.)				
Trefferlage	0.23 mm rechts, 0.39 mm hoch				
Streuwert	1.68, horizontal: 1.28, vertikal: 2.00				

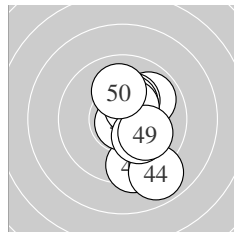

Serie 5:	9.9 ↗	10.3 *	9.4 ↓	8.9 ↘	10.4 *
	10.8 *	10.5 *	10.2 *	10.1 ↘	10.0 ↑
beste Teiler	31.2 (46.) 122.0 (47.) 150.7 (45.)				
Trefferlage	1.07 mm rechts, 0.32 mm tief				
Streuwert	1.77, horizontal: 0.95, vertikal: 2.32				

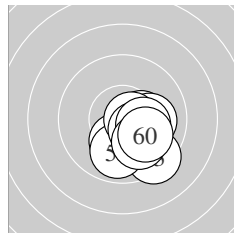

Serie 6:	10.2 *	10.3 *	9.4 ↘	10.1 →	9.9 ↓
	10.7 *	10.4 *	10.3 *	10.0 ↘	10.1 ↘
beste Teiler	71.1 (56.) 135.8 (57.) 151.1 (52.)				
Trefferlage	1.19 mm rechts, 1.20 mm tief				
Streuwert	1.06, horizontal: 1.02, vertikal: 1.10				

Meyton Elektronik

**ISSF AR Women Jun – Wertung – Juniorinnen**

StandNr: 140

**Felderer, Eva #188**

**StartNr: 89**

19. Januar 2020 11:25

T – SG Thaur

---

\_\_\_\_\_  
Unterschrift des Schützen

Meyton Elektronik

Ergebnis: **611.7** (584)  
 Serien: 101.6 101.4 100.7 102.2 102.7 103.1  
 Zähler: 44 16 0 0 0 0 0 0 0  
 Innenzehner: 37  
 weiteste: 474 (23), 409 (7), 396 (30)  
 beste Teiler 32.9 (50.) 42.0 (22.) 43.2 (28.)  
 Trefferlage 0.13 mm rechts, 0.19 mm tief  
 Streuwert 1.52, horizontal: 1.51, vertikal: 1.54

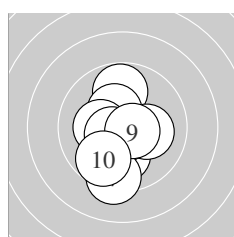
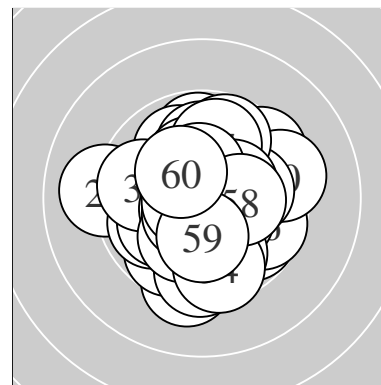

Serie 1:  
 9.8 ↑                      10.4 \*                      10.2 \*                      10.1 ↓                      10.2 \*  
 10.7 \*                      9.3 ↓                      10.5 \*                      10.6 \*                      9.8 ↙  
 beste Teiler 72.8 (6.) 84.8 (9.) 105.1 (8.)  
 Trefferlage 0.31 mm links, 0.66 mm tief  
 Streuwert 1.59, horizontal: 1.10, vertikal: 1.96

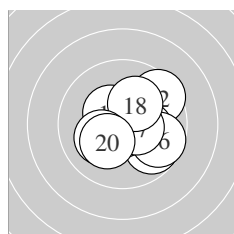

Serie 2:  
 9.8 ↘                      9.5 ↗                      10.2 \*                      10.8 \*                      10.4 \*  
 9.7 ↘                      10.5 \*                      10.2 \*                      10.1 ↙                      10.2 \*  
 beste Teiler 49.2 (14.) 116.9 (17.) 136.5 (15.)  
 Trefferlage 0.81 mm rechts, 0.19 mm tief  
 Streuwert 1.55, horizontal: 1.72, vertikal: 1.35

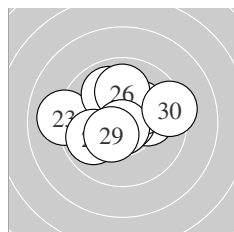

Serie 3:  
 10.1 →                      10.8 \*                      9.1 ←                      10.3 \*                      9.9 ↘  
 10.0 ↑                      9.9 ↙                      10.8 \*                      10.4 \*                      9.4 →  
 beste Teiler 42.0 (22.) 43.2 (28.) 135.8 (29.)  
 Trefferlage 0.16 mm links, 0.50 mm hoch  
 Streuwert 1.89, horizontal: 2.37, vertikal: 1.25

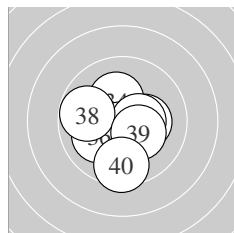

Serie 4:  
 10.5 \*                      10.5 \*                      10.2 \*                      10.2 \*                      10.7 \*  
 10.1 ↙                      10.4 \*                      9.8 ←                      10.3 \*                      9.5 ↓  
 beste Teiler 74.0 (35.) 113.1 (31.) 123.4 (32.)  
 Trefferlage 0.06 mm links, 0.63 mm tief  
 Streuwert 1.42, horizontal: 1.45, vertikal: 1.39

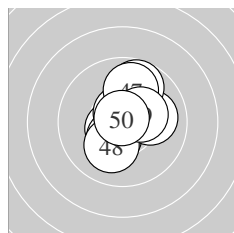

Serie 5:  
 10.6 \*                      10.4 \*                      10.6 \*                      10.3 \*                      10.0 →  
 9.7 ↑                      9.9 ↑                      10.1 ↓                      10.3 \*                      10.8 \*  
 beste Teiler 32.9 (50.) 76.4 (43.) 98.4 (41.)  
 Trefferlage 0.42 mm rechts, 0.45 mm hoch  
 Streuwert 1.30, horizontal: 1.10, vertikal: 1.48

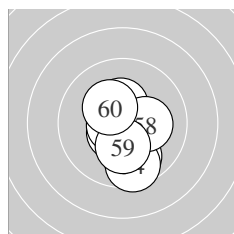

Serie 6:  
 10.5 \*                      10.7 \*                      9.8 ↓                      9.6 ↓                      10.4 \*  
 10.7 \*                      10.7 \*                      10.2 \*                      10.2 \*                      10.3 \*  
 beste Teiler 66.4 (57.) 71.3 (52.) 72.2 (56.)  
 Trefferlage 0.10 mm rechts, 0.62 mm tief  
 Streuwert 1.30, horizontal: 0.93, vertikal: 1.58

Meyton Elektronik

**ISSF AR Women Jun – Wertung – Juniorinnen**

**StartNr: 90**

StandNr: 141

19. Januar 2020 11:44

**Tomaschett, Annina #322**

SUI

---

\_\_\_\_\_  
Unterschrift des Schützen

Meyton Elektronik

Ergebnis:	<b>612.6</b>	(586)							
Serien:	103.3	103.2	101.4	103.1	99.1	102.5			
Zähler:	46	14	0	0	0	0	0	0	0
Innenzehner:	39								
weiteste:	472 (58), 446 (45), 405 (21)								
beste Teiler	17.4 (60.) 64.1 (6.) 64.9 (34.)								
Trefferlage	0.23 mm rechts, 0.08 mm hoch								
Streuwert	1.48, horizontal: 1.64, vertikal: 1.29								

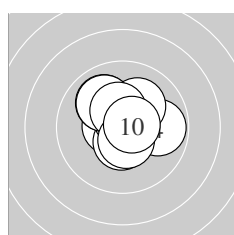
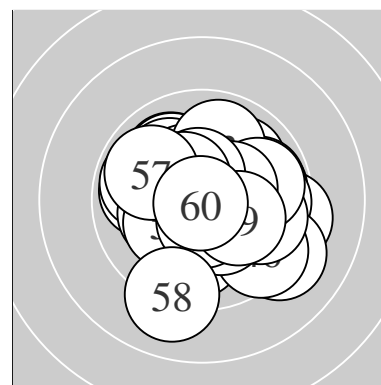

Serie 1:					
	10.6 *	10.5 *	10.0 ↘	9.8 →	10.1 ↗
	10.7 *	10.0 ↘	10.4 *	10.5 *	10.7 *
beste Teiler	64.1 (6.) 75.6 (10.) 97.3 (1.)				
Trefferlage	0.05 mm rechts, 0.55 mm hoch				
Streuwert	1.22, horizontal: 1.30, vertikal: 1.14				

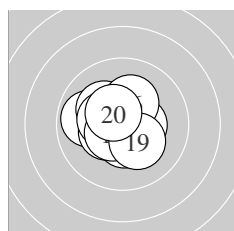

Serie 2:					
	10.4 *	9.9 ←	10.5 *	10.4 *	10.2 *
	10.2 *	10.4 *	10.5 *	10.2 *	10.5 *
beste Teiler	104.2 (18.) 115.8 (20.) 123.7 (13.)				
Trefferlage	0.50 mm links, 0.06 mm hoch				
Streuwert	1.16, horizontal: 1.28, vertikal: 1.02				

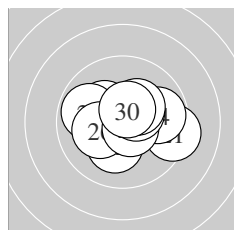

Serie 3:					
	9.3 →	10.2 *	10.2 *	9.8 →	9.9 ←
	10.2 *	10.6 *	10.4 *	10.3 *	10.5 *
beste Teiler	79.0 (27.) 106.6 (30.) 130.9 (28.)				
Trefferlage	0.35 mm rechts, 0.15 mm hoch				
Streuwert	1.62, horizontal: 2.05, vertikal: 1.02				

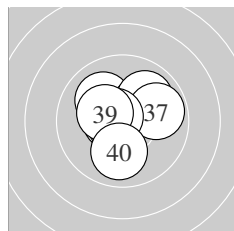

Serie 4:					
	10.1 ↘	10.6 *	10.6 *	10.7 *	10.3 *
	10.0 ↗	9.8 →	10.7 *	10.3 *	10.0 ↓
beste Teiler	64.9 (34.) 70.8 (38.) 83.1 (32.)				
Trefferlage	0.04 mm links, 0.40 mm hoch				
Streuwert	1.31, horizontal: 1.42, vertikal: 1.18				

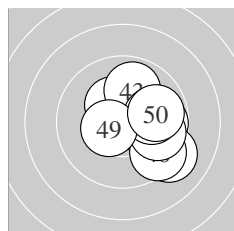

Serie 5:					
	10.2 *	10.3 *	9.9 ↑	9.8 →	9.2 ↘
	9.5 ↘	9.8 →	10.0 →	10.5 *	9.9 →
beste Teiler	118.5 (49.) 155.4 (42.) 183.7 (41.)				
Trefferlage	1.79 mm rechts, 0.16 mm tief				
Streuwert	1.59, horizontal: 1.63, vertikal: 1.56				

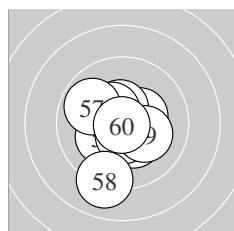

Serie 6:					
	10.2 *	10.3 *	10.4 *	10.5 *	10.6 *
	10.4 *	9.9 ↘	9.1 ↓	10.2 *	10.9 *
beste Teiler	17.4 (60.) 99.2 (55.) 119.5 (54.)				
Trefferlage	0.24 mm links, 0.49 mm tief				
Streuwert	1.54, horizontal: 1.33, vertikal: 1.73				

Meyton Elektronik

**ISSF AR Women Jun – Wertung – Juniorinnen**

StandNr: 142

**Barreira, Noelia** #357

**StartNr: 91**

19. Januar 2020 11:39

SUI – Zürich

---

\_\_\_\_\_  
Unterschrift des Schützen

Meyton Elektronik



Ergebnis: **613.6** (587)

Serien: 101.2 103.5 101.8 101.6 101.4 104.1

Zähler: 47 13 0 0 0 0 0 0 0

Innenzehner: 38

weiteste: 414 (5), 391 (36), 373 (28)

beste Teiler 10.2 (20.) 29.7 (41.) 41.5 (53.)

Trefferlage 0.25 mm links, 0.00 mm

Streuwert 1.44, horizontal: 1.66, vertikal: 1.17

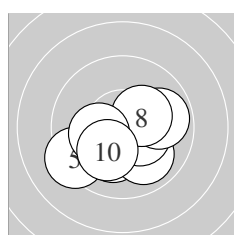
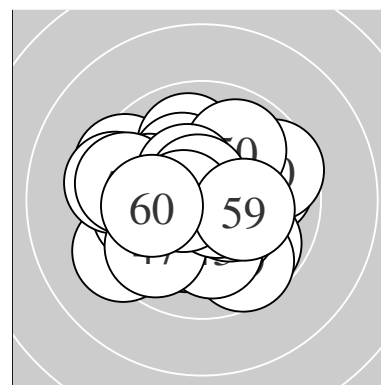

Serie 1:

10.5 *	10.2 *	10.0 ↘	10.3 *	9.3 ↙
10.4 *	9.9 →	10.3 *	10.2 *	10.1 ↙

beste Teiler 124.1 (1.) 140.4 (6.) 162.7 (8.)

Trefferlage 0.26 mm rechts, 0.66 mm tief

Streuwert 1.60, horizontal: 1.92, vertikal: 1.19

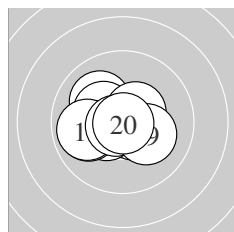

Serie 2:

10.6 *	10.1 ↖	10.4 *	10.3 *	9.9 ←
10.5 *	9.9 ←	10.7 *	10.2 *	10.9 *

beste Teiler 10.2 (20.) 55.4 (18.) 99.5 (11.)

Trefferlage 0.62 mm links, 0.05 mm tief

Streuwert 1.19, horizontal: 1.49, vertikal: 0.79

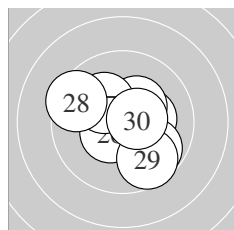

Serie 3:

10.3 *	10.6 *	10.3 *	10.4 *	9.8 ↘
10.5 *	10.2 *	9.5 ↖	9.7 ↘	10.5 *

beste Teiler 93.3 (22.) 108.6 (30.) 117.1 (26.)

Trefferlage 0.11 mm rechts, 0.08 mm hoch

Streuwert 1.61, horizontal: 1.78, vertikal: 1.43

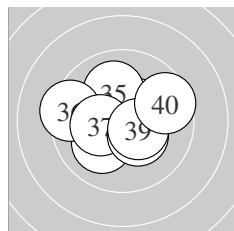

Serie 4:

10.6 *	10.5 *	10.1 ↗	10.4 *	10.0 ↑
9.4 ←	10.3 *	10.3 *	10.4 *	9.6 →

beste Teiler 92.7 (31.) 125.2 (32.) 127.3 (34.)

Trefferlage 0.04 mm rechts, 0.16 mm hoch

Streuwert 1.62, horizontal: 1.97, vertikal: 1.18

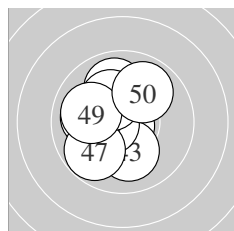

Serie 5:

10.8 *	10.0 ←	10.1 ↓	10.2 *	10.5 *
9.9 ↑	9.8 ↗	10.2 *	10.0 ←	9.9 ↗

beste Teiler 29.7 (41.) 103.0 (45.) 181.4 (44.)

Trefferlage 0.88 mm links, 0.33 mm hoch

Streuwert 1.42, horizontal: 1.27, vertikal: 1.56

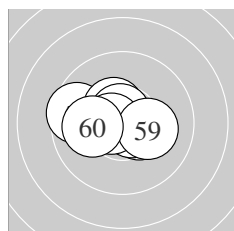

Serie 6:

10.4 *	10.6 *	10.8 *	10.7 *	9.6 ←
10.4 *	10.7 *	10.6 *	10.2 *	10.1 ←

beste Teiler 41.5 (53.) 66.4 (57.) 74.7 (54.)

Trefferlage 0.43 mm links, 0.18 mm hoch

Streuwert 1.16, horizontal: 1.54, vertikal: 0.56

**ISSF AR Women Jun – Wertung – Juniorinnen**

StandNr: 144

**Kovalenko, Vladyslava #362**

**StartNr: 93**

19. Januar 2020 11:33

UKR

---

Unterschrift des Schützen

---

Meyton Elektronik