

Ergebnis: **604.8** (577)
 Serien: 103.9 102.3 100.8 97.5 98.8 101.5
 Zähler: 40 17 3 0 0 0 0 0 0
 Innenzehner: 29
 weiteste: 702 (37), 533 (39), 519 (18)
 beste Teiler 37.0 (31.) 42.1 (6.) 48.2 (15.)
 Trefferlage 0.09 mm rechts, 0.34 mm tief
 Streuwert 1.79, horizontal: 1.94, vertikal: 1.63

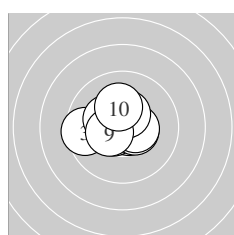

Serie 1:
 10.7 * 10.6 * 9.5 ← 10.5 * 10.3 *
 10.8 * 10.5 * 10.4 * 10.4 * 10.2 *
 beste Teiler 42.1 (6.) 69.6 (1.) 94.4 (2.)
 Trefferlage 0.45 mm links, 0.16 mm hoch
 Streuwert 1.17, horizontal: 1.42, vertikal: 0.84

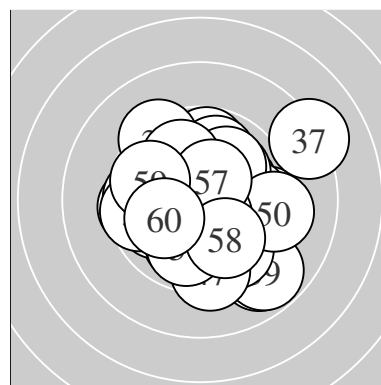
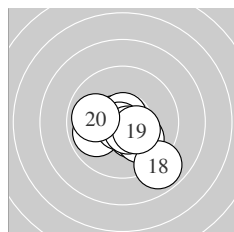

Serie 2:
 10.7 * 10.4 * 9.9 ← 10.7 * 10.8 *
 10.0 ↘ 10.6 * 8.9 ↘ 10.4 * 9.9 ←
 beste Teiler 48.2 (15.) 52.0 (14.) 74.6 (11.)
 Trefferlage 0.16 mm rechts, 0.83 mm tief
 Streuwert 1.57, horizontal: 1.79, vertikal: 1.31

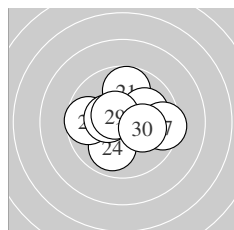

Serie 3:
 9.8 ↑ 10.3 * 10.4 * 10.0 ↓ 9.7 ←
 10.0 ↗ 9.4 → 10.4 * 10.6 * 10.2 *
 beste Teiler 96.2 (29.) 142.1 (28.) 144.8 (23.)
 Trefferlage 0.05 mm links, 0.00 mm
 Streuwert 1.77, horizontal: 2.06, vertikal: 1.41

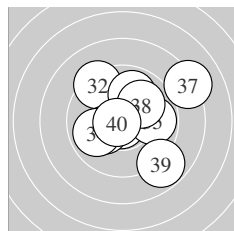

Serie 4:
 10.8 * 9.3 ↘ 10.2 * 9.9 ← 9.8 →
 9.9 ↑ 8.1 ↗ 10.0 ↗ 8.8 ↘ 10.7 *
 beste Teiler 37.0 (31.) 55.5 (40.) 189.1 (33.)
 Trefferlage 0.80 mm rechts, 0.45 mm hoch
 Streuwert 2.56, horizontal: 2.79, vertikal: 2.30

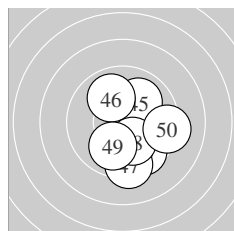

Serie 5:
 10.3 * 10.1 ↘ 10.1 ↓ 9.6 ↘ 10.0 ↗
 10.0 ↘ 9.3 ↓ 10.1 ↓ 10.0 ↓ 9.3 →
 beste Teiler 153.7 (41.) 203.0 (48.) 204.8 (42.)
 Trefferlage 0.94 mm rechts, 1.24 mm tief
 Streuwert 1.73, horizontal: 1.48, vertikal: 1.95

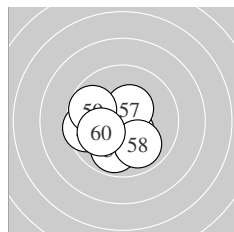

Serie 6:
 9.6 ← 10.3 * 10.4 * 10.5 * 10.7 *
 9.9 ↓ 10.4 * 9.9 ↘ 9.7 ← 10.1 ←
 beste Teiler 55.3 (55.) 111.2 (54.) 130.9 (53.)
 Trefferlage 0.80 mm links, 0.60 mm tief
 Streuwert 1.44, horizontal: 1.59, vertikal: 1.26

Meyton Elektronik

ISSF AR Women Jun – Wertung – Juniorinnen

StandNr: 101

Baumgartner, Marlene #68

StartNr: 1

18. Januar 2020 9:50

OOE – Priv. SG Enns

Unterschrift des Schützen

Meyton Elektronik

Ergebnis: **628.1** (597)^{QF}
 Serien: 105.7 103.8 104.5 104.8 104.7 104.6
 Zähler: 57 3 0 0 0 0 0 0 0 0
 Innenzehner: 52
 weiteste: 263 (9), 263 (30), 259 (58)
 beste Teiler 14.0 (17.) 34.3 (2.) 36.2 (60.)
 Trefferlage 0.08 mm links, 0.03 mm tief
 Streuwert 0.98, horizontal: 1.02, vertikal: 0.94

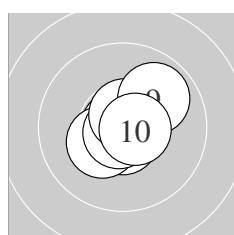
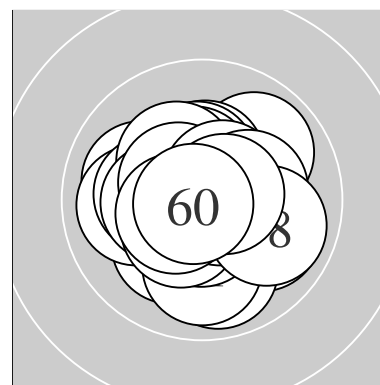

Serie 1:
 10.7 * 10.8 * 10.6 * 10.7 * 10.3 *
 10.7 * 10.8 * 10.6 * 9.9 ↗ 10.6 *
 beste Teiler 34.3 (2.) 41.0 (7.) 51.2 (1.)
 Trefferlage 0.20 mm rechts, 0.08 mm hoch
 Streuwert 0.83, horizontal: 0.87, vertikal: 0.78

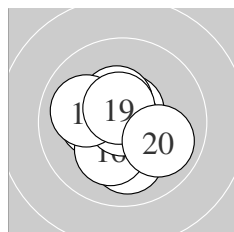

Serie 2:
 10.7 * 10.6 * 10.3 * 10.4 * 10.1 ↓
 10.2 * 10.9 * 10.0 ← 10.6 * 10.0 ↘
 beste Teiler 14.0 (17.) 60.3 (11.) 78.7 (12.)
 Trefferlage 0.20 mm links, 0.08 mm tief
 Streuwert 1.21, horizontal: 1.23, vertikal: 1.19

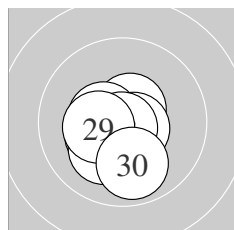

Serie 3:
 10.3 * 10.6 * 10.6 * 10.2 * 10.7 *
 10.5 * 10.6 * 10.8 * 10.3 * 9.9 ↓
 beste Teiler 37.6 (28.) 74.3 (25.) 79.2 (27.)
 Trefferlage 0.32 mm links, 0.63 mm tief
 Streuwert 0.91, horizontal: 0.89, vertikal: 0.94

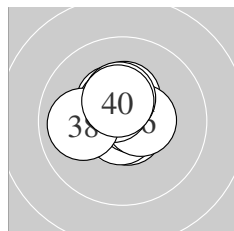

Serie 4:
 10.7 * 10.4 * 10.4 * 10.8 * 10.7 *
 10.5 * 10.5 * 10.0 ← 10.4 * 10.4 *
 beste Teiler 49.4 (34.) 59.3 (31.) 66.3 (35.)
 Trefferlage 0.21 mm links, 0.54 mm hoch
 Streuwert 0.88, horizontal: 0.95, vertikal: 0.80

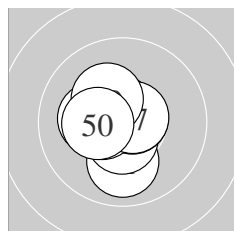

Serie 5:
 10.0 ↓ 10.7 * 10.6 * 10.7 * 10.8 *
 10.4 * 10.7 * 10.2 * 10.3 * 10.3 *
 beste Teiler 46.6 (45.) 65.9 (44.) 68.1 (42.)
 Trefferlage 0.42 mm links, 0.04 mm tief
 Streuwert 0.97, horizontal: 0.90, vertikal: 1.04

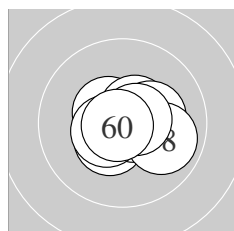

Serie 6:
 10.5 * 10.4 * 10.4 * 10.7 * 10.5 *
 10.5 * 10.3 * 9.9 ↘ 10.6 * 10.8 *
 beste Teiler 36.2 (60.) 70.8 (54.) 85.8 (59.)
 Trefferlage 0.46 mm rechts, 0.06 mm tief
 Streuwert 0.94, horizontal: 1.17, vertikal: 0.62

Meyton Elektronik

QF – Schütze hat sich fürs Finale qualifiziert

Unterschrift des Schützen

Meyton Elektronik

Ergebnis: **619.7** (591)
 Serien: 102.7 102.4 104.0 102.7 103.0 104.9
 Zähler: 51 9 0 0 0 0 0 0 0
 Innenzehner: 46
 weiteste: 394 (40), 332 (16), 309 (10)
 beste Teiler 1.0 (37.) 23.8 (3.) 32.2 (58.)
 Trefferlage 0.03 mm links, 0.37 mm hoch
 Streuwert 1.21, horizontal: 1.36, vertikal: 1.04

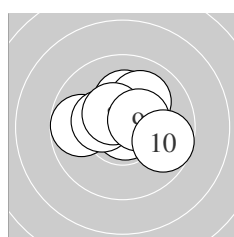
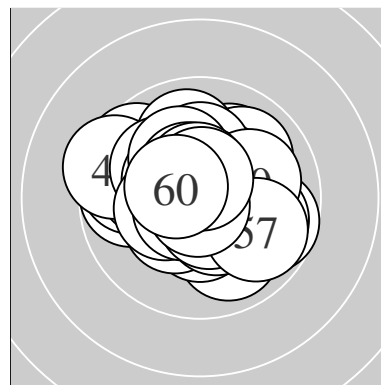

Serie 1:
 9.8 ← 10.5 * 10.9 * 10.3 * 10.2 *
 10.1 ↗ 10.3 * 10.5 * 10.4 * 9.7 →
 beste Teiler 23.8 (3.) 108.3 (2.) 119.0 (8.)
 Trefferlage 0.00 mm , 0.73 mm hoch
 Streuwert 1.32, horizontal: 1.61, vertikal: 0.93

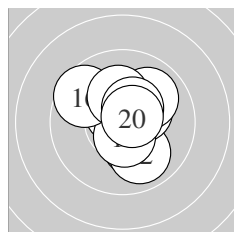

Serie 2:
 10.2 * 9.9 ↘ 10.3 * 10.6 * 10.5 *
 9.6 ↖ 10.0 ↗ 10.2 * 10.5 * 10.6 *
 beste Teiler 80.2 (20.) 85.4 (14.) 101.9 (15.)
 Trefferlage 0.31 mm rechts, 0.35 mm hoch
 Streuwert 1.39, horizontal: 1.30, vertikal: 1.48

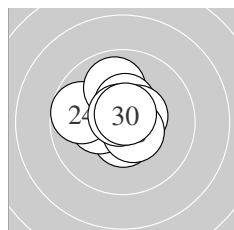

Serie 3:
 10.5 * 10.8 * 10.3 * 9.7 ← 9.9 ↑
 10.4 * 10.5 * 10.5 * 10.7 * 10.7 *
 beste Teiler 50.3 (22.) 56.3 (29.) 61.3 (30.)
 Trefferlage 0.31 mm links, 0.46 mm hoch
 Streuwert 1.08, horizontal: 1.19, vertikal: 0.97

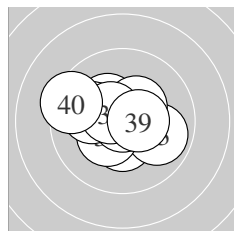

Serie 4:
 10.4 * 10.3 * 9.9 → 10.4 * 10.0 ←
 10.4 * 10.9 * 10.5 * 10.5 * 9.4 ←
 beste Teiler 1.0 (37.) 104.8 (38.) 114.0 (39.)
 Trefferlage 0.43 mm links, 0.14 mm hoch
 Streuwert 1.43, horizontal: 1.77, vertikal: 0.99

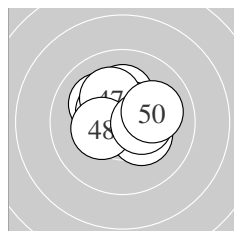

Serie 5:
 10.5 * 10.1 ↖ 10.3 * 10.4 * 10.2 *
 10.6 * 10.2 * 10.3 * 10.4 * 10.0 →
 beste Teiler 87.0 (46.) 105.6 (41.) 138.2 (49.)
 Trefferlage 0.12 mm rechts, 0.58 mm hoch
 Streuwert 1.16, horizontal: 1.36, vertikal: 0.92

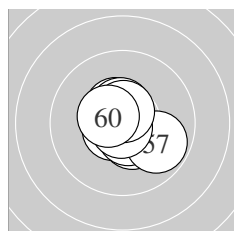

Serie 6:
 10.6 * 10.5 * 10.5 * 10.4 * 10.6 *
 10.6 * 9.8 ↘ 10.8 * 10.6 * 10.5 *
 beste Teiler 32.2 (58.) 79.3 (51.) 82.6 (55.)
 Trefferlage 0.09 mm rechts, 0.00 mm
 Streuwert 0.95, horizontal: 0.96, vertikal: 0.93

Meyton Elektronik

ISSF AR Women Jun – Wertung – Juniorinnen

StandNr: 103

Karasova, Sara #37

StartNr: 3

18. Januar 2020 9:32

CZE

Unterschrift des Schützen

Meyton Elektronik

Ergebnis:	576.0	(552)
Serien:	90.3	97.2 98.9 96.6 96.8 96.2
Zähler:	24	26 8 2 0 0 0 0 0 0
Innenzehner:	15	
weiteste:	953 (2), 820 (4), 664 (8)	
beste Teiler	60.3 (14.)	79.2 (52.) 81.7 (39.)
Trefferlage	1.28 mm links, 0.24 mm tief	
Streuwert	2.60, horizontal: 3.24, vertikal: 1.73	

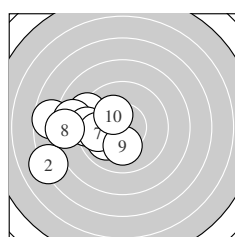
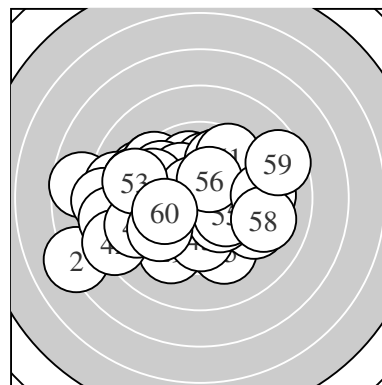

Serie 1:	9.2 ↖	7.1 ↖	10.0 ↖	7.7 ↖	8.6 ↖
	9.3 ←	9.8 ←	8.3 ←	10.1 ↓	10.2 *
beste Teiler	177.8 (10.) 211.0 (9.) 240.8 (3.)				
Trefferlage	4.29 mm links, 0.36 mm tief				
Streuwert	2.45, horizontal: 2.93, vertikal: 1.84				

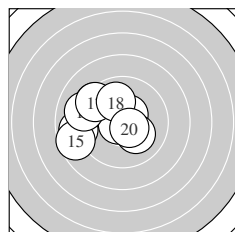

Serie 2:	8.9 ←	9.4 ↖	10.5 *	10.7 *	8.6 ↖
	9.1 ←	9.4 ↖	10.0 ↖	10.1 ↘	10.5 *
beste Teiler	60.3 (14.) 101.4 (20.) 110.4 (13.)				
Trefferlage	1.96 mm links, 0.37 mm hoch				
Streuwert	2.18, horizontal: 2.60, vertikal: 1.65				

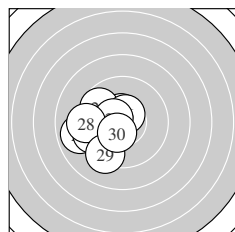

Serie 3:	10.5 *	10.2 *	8.9 ↖	9.7 ↖	9.5 ↖
	10.6 *	10.5 *	9.3 ←	9.3 ↘	10.4 *
beste Teiler	94.5 (26.) 103.7 (21.) 113.4 (27.)				
Trefferlage	2.06 mm links, 0.41 mm tief				
Streuwert	1.65, horizontal: 1.74, vertikal: 1.55				

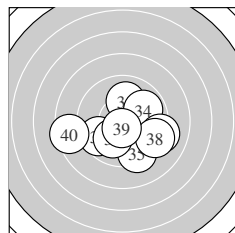

Serie 4:	10.0 ↑	10.4 *	9.6 ↖	9.9 ↗	9.3 ↘
	10.0 ↘	9.1 ↘	9.3 ↘	10.6 *	8.4 ←
beste Teiler	81.7 (39.) 149.8 (32.) 228.6 (31.)				
Trefferlage	0.34 mm rechts, 1.04 mm tief				
Streuwert	2.51, horizontal: 3.12, vertikal: 1.70				

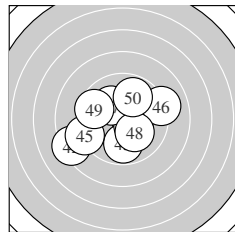

Serie 5:	10.5 *	8.3 ↖	9.8 ↓	10.4 *	9.1 ↖
	9.1 ↗	10.1 ↖	10.1 ↘	9.6 ↖	9.8 ↑
beste Teiler	101.9 (41.) 145.9 (44.) 203.5 (47.)				
Trefferlage	0.55 mm links, 0.34 mm tief				
Streuwert	2.62, horizontal: 3.13, vertikal: 1.97				

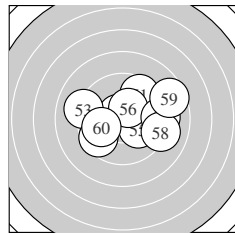

Serie 6:	9.6 ↗	10.6 *	9.1 ↖	9.6 ↖	10.1 ↘
	10.4 *	9.2 →	9.1 ↘	8.6 ↗	9.9 ↖
beste Teiler	79.2 (52.) 142.2 (56.) 208.7 (55.)				
Trefferlage	0.82 mm rechts, 0.28 mm hoch				
Streuwert	2.66, horizontal: 3.36, vertikal: 1.68				

Meyton Elektronik

ISSF AR Women Jun – Wertung – Juniorinnen

StandNr: 104

Eckhard, Tina #335

StartNr: 4

18. Januar 2020 9:23

OOE – SV Theuerwang

Unterschrift des Schützen

Meyton Elektronik

Ergebnis:	617.9	(589)						
Serien:	103.5	104.4	102.0	103.4	102.8	101.8		
Zähler:	49	11	0	0	0	0	0	0
Innenzehner:	46							
weiteste:	388 (27), 383 (38), 342 (56)							
beste Teiler	48.8 (45.)	49.7 (11.)	51.0 (18.)					
Trefferlage	0.05 mm rechts, 0.20 mm hoch							
Streuwert	1.31, horizontal: 1.56, vertikal: 1.01							

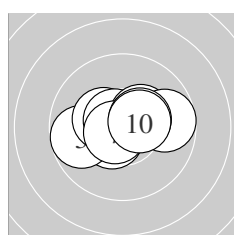
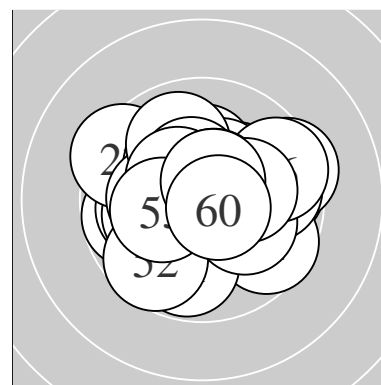

Serie 1:

10.5 *	10.7 *	9.7 ←	10.4 *	10.7 *
10.3 *	10.7 *	9.7 →	10.4 *	10.4 *
beste Teiler	63.2 (2.)	66.2 (7.)	75.1 (5.)	
Trefferlage	0.11 mm rechts, 0.18 mm hoch			
Streuwert	1.26, horizontal: 1.68, vertikal: 0.57			

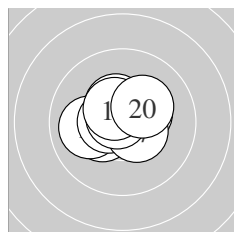

Serie 2:

10.8 *	10.3 *	10.0 ←	10.6 *	10.4 *
10.4 *	10.5 *	10.7 *	10.5 *	10.2 *
beste Teiler	49.7 (11.)	51.0 (18.)	100.0 (14.)	
Trefferlage	0.29 mm links, 0.25 mm hoch			
Streuwert	0.99, horizontal: 1.22, vertikal: 0.69			

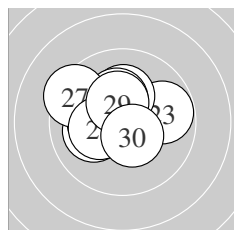

Serie 3:

10.7 *	10.1 ←	9.8 →	10.3 *	10.2 *
10.3 *	9.4 ↖	10.3 *	10.4 *	10.5 *
beste Teiler	54.0 (21.)	119.0 (30.)	144.8 (29.)	
Trefferlage	0.61 mm links, 0.60 mm hoch			
Streuwert	1.43, horizontal: 1.72, vertikal: 1.07			

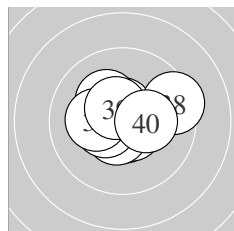

Serie 4:

10.6 *	10.6 *	10.6 *	10.4 *	10.6 *
10.2 *	10.2 *	9.4 →	10.5 *	10.3 *
beste Teiler	77.2 (31.)	86.2 (32.)	87.1 (35.)	
Trefferlage	0.08 mm rechts, 0.19 mm hoch			
Streuwert	1.29, horizontal: 1.60, vertikal: 0.87			

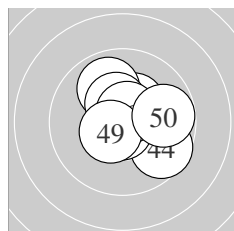

Serie 5:

10.4 *	10.5 *	10.2 *	9.6 ↘	10.8 *
9.9 ↖	10.4 *	10.7 *	10.5 *	9.8 →
beste Teiler	48.8 (45.)	73.3 (48.)	110.2 (49.)	
Trefferlage	0.74 mm rechts, 0.26 mm hoch			
Streuwert	1.33, horizontal: 1.43, vertikal: 1.21			

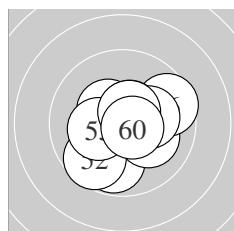

Serie 6:

9.8 ↓	9.7 ↙	10.4 *	10.1 ↘	10.2 *
9.6 →	10.6 *	10.2 *	10.6 *	10.6 *
beste Teiler	77.3 (60.)	92.7 (59.)	95.7 (57.)	
Trefferlage	0.31 mm rechts, 0.28 mm tief			
Streuwert	1.56, horizontal: 1.67, vertikal: 1.43			

Meyton Elektronik

ISSF AR Women Jun – Wertung – Juniorinnen

StandNr: 105

Goldfaden, Ella #336

StartNr: 5

18. Januar 2020 9:43

ISR

Unterschrift des Schützen

Meyton Elektronik

Ergebnis: **620.3** (590)
 Serien: 102.5 102.4 103.4 104.4 103.8 103.8
 Zähler: 50 10 0 0 0 0 0 0 0
 Innenzehner: 45
 weiteste: 354 (27), 327 (8), 288 (14)
 beste Teiler 24.0 (50.) 37.3 (25.) 39.8 (40.)
 Trefferlage 0.06 mm rechts, 0.16 mm hoch
 Streuwert 1.23, horizontal: 1.41, vertikal: 1.01

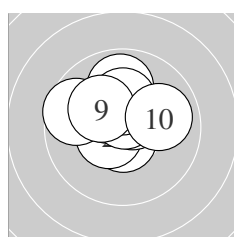
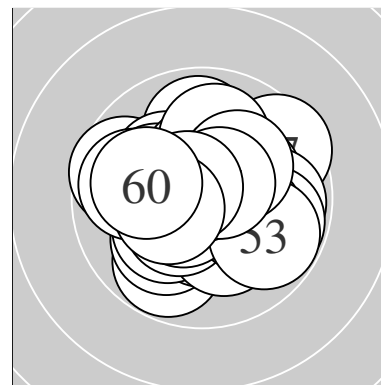

Serie 1:
 10.6 * 10.5 * 10.6 * 10.3 * 10.6 *
 9.9 ↑ 10.3 * 9.6 ← 10.2 * 9.9 →
 beste Teiler 78.1 (1.) 79.4 (5.) 99.0 (3.)
 Trefferlage 0.33 mm links, 0.87 mm hoch
 Streuwert 1.24, horizontal: 1.45, vertikal: 1.00

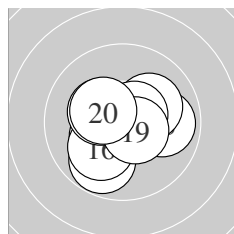

Serie 2:
 10.3 * 10.5 * 9.9 → 9.8 ↙ 10.1 ↗
 10.1 ↘ 10.6 * 10.3 * 10.5 * 10.3 *
 beste Teiler 93.4 (17.) 101.2 (19.) 103.7 (12.)
 Trefferlage 0.17 mm links, 0.31 mm tief
 Streuwert 1.37, horizontal: 1.55, vertikal: 1.15

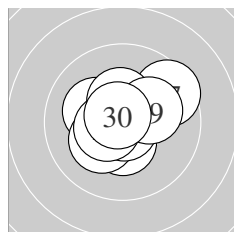

Serie 3:
 10.4 * 10.5 * 10.2 * 10.2 * 10.8 *
 10.5 * 9.5 ↗ 10.4 * 10.2 * 10.7 *
 beste Teiler 37.3 (25.) 56.4 (30.) 105.2 (22.)
 Trefferlage 0.08 mm links, 0.19 mm hoch
 Streuwert 1.28, horizontal: 1.47, vertikal: 1.06

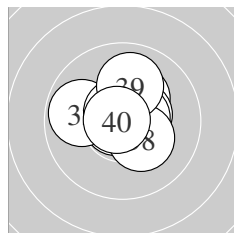

Serie 4:
 10.8 * 9.8 ← 10.2 * 10.5 * 10.7 *
 10.7 * 10.6 * 10.3 * 10.0 ↑ 10.8 *
 beste Teiler 39.8 (40.) 43.5 (31.) 69.2 (36.)
 Trefferlage 0.14 mm rechts, 0.47 mm hoch
 Streuwert 1.07, horizontal: 1.20, vertikal: 0.93

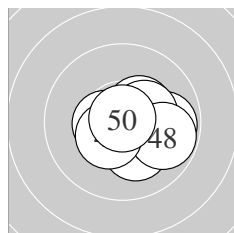

Serie 5:
 10.6 * 10.4 * 9.9 → 10.8 * 10.2 *
 10.3 * 10.5 * 9.8 ↘ 10.4 * 10.9 *
 beste Teiler 24.0 (50.) 39.8 (44.) 87.6 (41.)
 Trefferlage 0.78 mm rechts, 0.28 mm tief
 Streuwert 1.07, horizontal: 1.31, vertikal: 0.76

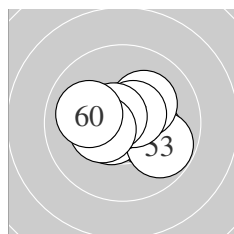

Serie 6:
 10.1 ↘ 10.6 * 9.8 ↘ 10.8 * 10.2 *
 10.6 * 10.6 * 10.7 * 10.4 * 10.0 ←
 beste Teiler 47.5 (54.) 74.4 (58.) 88.4 (56.)
 Trefferlage 0.04 mm rechts, 0.02 mm hoch
 Streuwert 1.22, horizontal: 1.52, vertikal: 0.81

Meyton Elektronik

ISSF AR Women Jun – Wertung – Juniorinnen

StandNr: 106

Hafner, Lisa #4

StartNr: 6

18. Januar 2020 9:54

AUT

Unterschrift des Schützen

Meyton Elektronik

Ergebnis: **615.3** (586)

Serien: 103.7 101.0 103.7 103.7 100.4 102.8

Zähler: 46 14 0 0 0 0 0 0 0 0

Innenzehner: 38

weiteste: 409 (42), 391 (45), 389 (41)

beste Teiler 12.0 (26.) 25.8 (4.) 29.1 (38.)

Trefferlage 0.33 mm rechts, 0.20 mm hoch

Streuwert 1.42, horizontal: 1.47, vertikal: 1.36

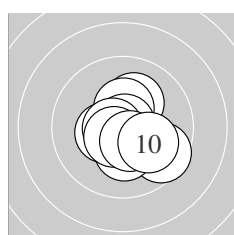
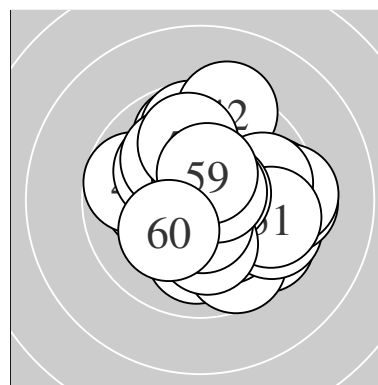

Serie 1:

10.2 *	10.4 *	10.4 *	10.9 *	9.6 ↘
10.7 *	10.3 *	10.6 *	10.5 *	10.1 ↘

beste Teiler 25.8 (4.) 74.5 (6.) 95.6 (8.)

Trefferlage 0.38 mm rechts, 0.36 mm tief

Streuwert 1.23, horizontal: 1.24, vertikal: 1.23

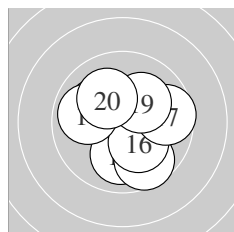

Serie 2:

10.8 *	10.0 ↓	9.7 ↘	10.3 *	10.1 ↘
10.2 *	9.7 →	9.9 ←	10.2 *	10.1 ↘

beste Teiler 44.9 (11.) 157.1 (14.) 190.0 (16.)

Trefferlage 0.26 mm rechts, 0.06 mm tief

Streuwert 1.70, horizontal: 1.76, vertikal: 1.63

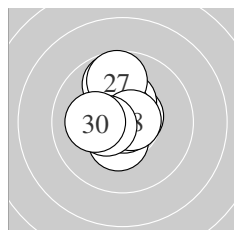

Serie 3:

10.6 *	10.4 *	10.4 *	10.6 *	9.8 ↑
10.9 *	9.7 ↑	10.7 *	10.5 *	10.1 ←

beste Teiler 12.0 (26.) 62.5 (28.) 86.9 (24.)

Trefferlage 0.30 mm links, 0.70 mm hoch

Streuwert 1.15, horizontal: 0.85, vertikal: 1.38

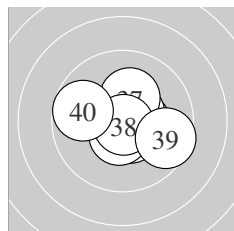

Serie 4:

10.4 *	10.5 *	10.7 *	10.5 *	10.5 *
10.8 *	10.2 *	10.8 *	9.6 ↘	9.7 ←

beste Teiler 29.1 (38.) 37.0 (36.) 54.2 (33.)

Trefferlage 0.36 mm rechts, 0.00 mm

Streuwert 1.26, horizontal: 1.52, vertikal: 0.92

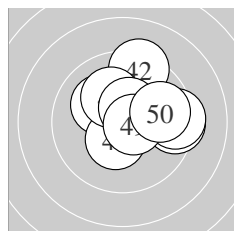

Serie 5:

9.4 →	9.3 ↑	10.8 *	10.1 ↘	9.4 →
10.4 *	10.1 ↘	10.5 *	10.6 *	9.8 →

beste Teiler 38.9 (43.) 83.1 (49.) 115.5 (48.)

Trefferlage 1.02 mm rechts, 0.71 mm hoch

Streuwert 1.70, horizontal: 1.93, vertikal: 1.44

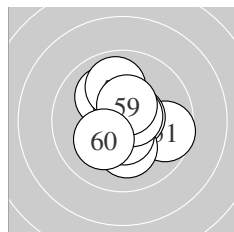

Serie 6:

9.7 →	10.6 *	10.2 *	10.5 *	10.1 ↘
10.5 *	10.6 *	9.9 ↑	10.5 *	10.2 *

beste Teiler 80.9 (57.) 95.5 (52.) 101.5 (54.)

Trefferlage 0.24 mm rechts, 0.21 mm hoch

Streuwert 1.38, horizontal: 1.28, vertikal: 1.46

ISSF AR Women Jun – Wertung – Juniorinnen

StandNr: 107

Tomaschett, Annina #322

StartNr: 7

18. Januar 2020 9:55

SUI

Unterschrift des Schützen

Meyton Elektronik

Ergebnis: **599.6** (572)
 Serien: 101.2 98.3 99.6 101.2 97.6 101.7
 Zähler: 32 28 0 0 0 0 0 0 0
 Innenzehner: 23
 weiteste: 500 (41), 455 (26), 455 (45)
 beste Teiler 39.8 (23.) 39.8 (27.) 42.2 (31.)
 Trefferlage 0.57 mm links, 0.81 mm hoch
 Streuwert 1.77, horizontal: 1.95, vertikal: 1.55

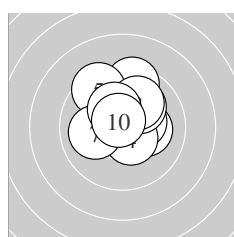
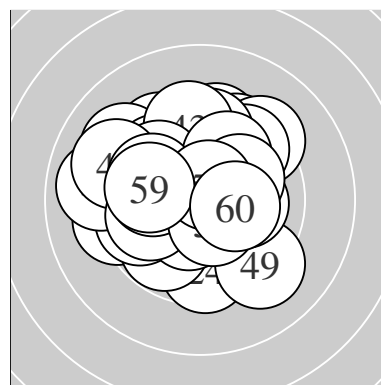

Serie 1:
 9.5 ↑ 10.2 * 10.4 * 10.5 * 9.5 ↘
 10.1 ↗ 10.0 ← 10.0 ↗ 10.3 * 10.7 *
 beste Teiler 66.3 (10.) 114.2 (4.) 150.8 (3.)
 Trefferlage 0.21 mm rechts, 1.14 mm hoch
 Streuwert 1.49, horizontal: 1.47, vertikal: 1.51

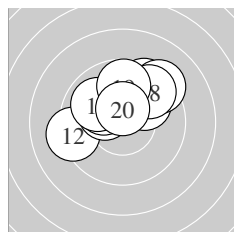

Serie 2:
 10.0 ↗ 9.3 ← 10.3 * 9.5 ↗ 10.2 *
 9.3 ↗ 9.9 ↘ 9.6 ↗ 9.7 ↑ 10.5 *
 beste Teiler 112.0 (20.) 164.5 (13.) 195.8 (15.)
 Trefferlage 0.03 mm links, 1.66 mm hoch
 Streuwert 1.84, horizontal: 2.27, vertikal: 1.28

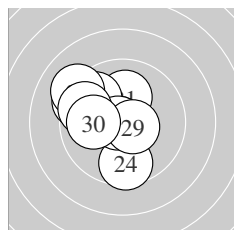

Serie 3:
 10.1 ↑ 9.3 ↘ 10.8 * 9.6 ↓ 9.7 ↘
 9.1 ↘ 10.8 * 9.6 ↘ 10.6 * 10.0 ←
 beste Teiler 39.8 (23.) 39.8 (27.) 92.6 (29.)
 Trefferlage 1.47 mm links, 0.55 mm hoch
 Streuwert 1.76, horizontal: 1.76, vertikal: 1.76

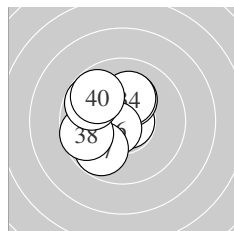

Serie 4:
 10.8 * 10.4 * 10.2 * 10.2 * 9.9 ↘
 10.6 * 9.8 ↗ 9.7 ← 9.8 ↘ 9.8 ↘
 beste Teiler 42.2 (31.) 89.8 (36.) 136.4 (32.)
 Trefferlage 1.22 mm links, 0.50 mm hoch
 Streuwert 1.42, horizontal: 1.38, vertikal: 1.46

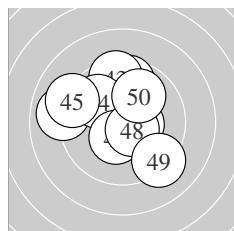

Serie 5:
 9.0 ← 9.6 ↑ 9.5 ↑ 9.9 ↘ 9.1 ↘
 10.5 * 10.4 * 10.5 * 9.2 ↘ 9.9 ↗
 beste Teiler 101.2 (48.) 123.4 (46.) 138.7 (47.)
 Trefferlage 0.55 mm links, 0.81 mm hoch
 Streuwert 2.34, horizontal: 2.52, vertikal: 2.15

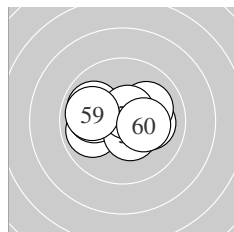

Serie 6:
 10.5 * 9.9 ← 10.0 ← 9.9 ↘ 10.5 *
 10.1 → 10.1 ↗ 10.6 * 9.9 ← 10.2 *
 beste Teiler 84.2 (58.) 106.7 (51.) 123.8 (55.)
 Trefferlage 0.37 mm links, 0.19 mm hoch
 Streuwert 1.50, horizontal: 1.99, vertikal: 0.74

ISSF AR Women Jun – Wertung – Juniorinnen

StandNr: 108

Moser, Johanna #190

StartNr: 8

18. Januar 2020 9:31

T – SG Schwaz

Unterschrift des Schützen

Meyton Elektronik

Ergebnis: **604.1** (575)

Serien: 100.1 102.7 99.8 99.5 99.6 102.4

Zähler: 37 21 2 0 0 0 0 0 0 0

Innenzehner: 35

weiteste: 686 (38), 541 (58), 484 (9)

beste Teiler 44.8 (21.) 48.5 (51.) 53.2 (12.)

Trefferlage 0.02 mm rechts, 0.18 mm hoch

Streuwert 1.86, horizontal: 1.83, vertikal: 1.89

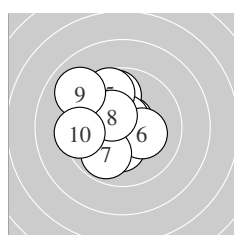
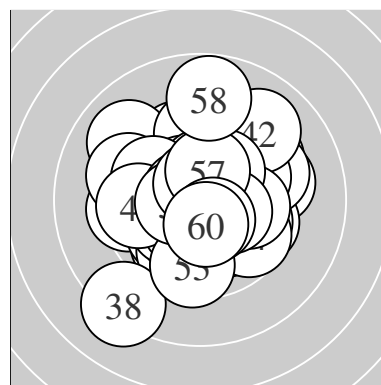

Serie 1:

10.7 *	9.8 ↑	10.7 *	10.3 *	9.7 ↑
10.2 *	9.9 ↙	10.4 *	9.0 ↘	9.4 ←

beste Teiler 66.4 (3.) 69.3 (1.) 139.3 (8.)

Trefferlage 0.96 mm links, 0.59 mm hoch

Streuwert 1.83, horizontal: 1.74, vertikal: 1.92

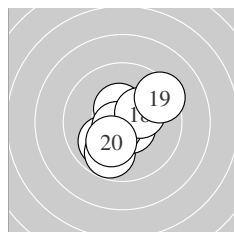

Serie 2:

10.0 ↘	10.7 *	10.5 *	10.5 *	9.8 ↙
10.6 *	10.7 *	10.3 *	9.4 ↗	10.2 *

beste Teiler 53.2 (12.) 64.4 (17.) 84.8 (16.)

Trefferlage 0.01 mm rechts, 0.33 mm tief

Streuwert 1.49, horizontal: 1.47, vertikal: 1.50

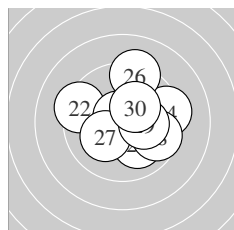

Serie 3:

10.8 *	9.3 ↖	10.0 ↘	9.4 →	10.7 *
9.2 ↑	10.2 *	9.7 ↗	10.2 *	10.3 *

beste Teiler 44.8 (21.) 63.6 (25.) 173.3 (30.)

Trefferlage 0.68 mm rechts, 0.34 mm hoch

Streuwert 1.99, horizontal: 2.21, vertikal: 1.74

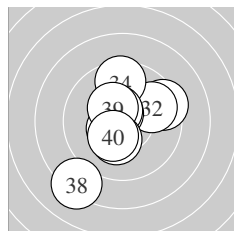

Serie 4:

9.4 ↗	9.8 ↗	10.6 *	9.5 ↑	10.5 *
10.5 *	10.3 *	8.2 ↙	10.4 *	10.3 *

beste Teiler 78.8 (33.) 103.7 (36.) 117.3 (35.)

Trefferlage 0.22 mm links, 0.01 mm tief

Streuwert 2.27, horizontal: 2.07, vertikal: 2.45

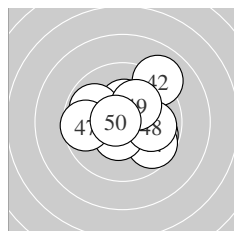

Serie 5:

10.3 *	9.0 ↗	9.8 ↘	9.7 ↘	10.5 *
9.9 ↖	9.6 ←	9.9 →	10.2 *	10.7 *

beste Teiler 63.1 (50.) 120.8 (45.) 154.6 (41.)

Trefferlage 0.54 mm rechts, 0.31 mm hoch

Streuwert 1.98, horizontal: 2.25, vertikal: 1.65

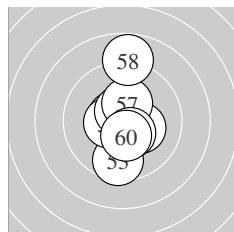

Serie 6:

10.8 *	10.6 *	9.6 ↓	10.3 *	10.5 *
10.6 *	10.3 *	8.8 ↑	10.5 *	10.4 *

beste Teiler 48.5 (51.) 89.4 (52.) 90.2 (56.)

Trefferlage 0.07 mm rechts, 0.21 mm hoch

Streuwert 1.72, horizontal: 0.80, vertikal: 2.29

ISSF AR Women Jun – Wertung – Juniorinnen

StandNr: 109

Larch, Laura #182

StartNr: 9

18. Januar 2020 9:45

T – SG Kramsach

Unterschrift des Schützen

Meyton Elektronik

Ergebnis:	570.5	(546)
Serien:	95.3 95.8 91.9 95.4 93.3 98.8	
Zähler:	17 33 9 1 0 0 0 0 0 0	
Innenzehner:	15	
weiteste:	891 (29), 744 (30), 728 (36)	
beste Teiler	34.0 (56.) 45.6 (40.) 74.3 (39.)	
Trefferlage	0.75 mm rechts, 0.50 mm tief	
Streuwert	2.83, horizontal: 3.05, vertikal: 2.60	

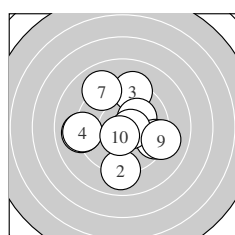
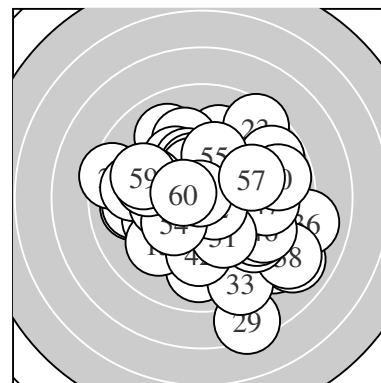

Serie 1:

9.1 ←	9.0 ↓	9.3 ↑	9.1 ←	10.2 *
9.4 →	9.0 ↘	10.6 *	9.1 →	10.5 *

beste Teiler 93.6 (8.) 101.5 (10.) 193.6 (5.)
 Trefferlage 0.04 mm links, 0.07 mm tief
 Streuwert 2.89, horizontal: 3.09, vertikal: 2.67

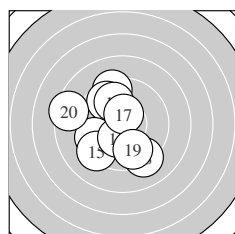

Serie 2:

9.3 ↑	9.7 ↖	9.5 ↙	9.9 ↑	9.3 ↘
10.3 *	10.5 *	9.2 ↘	9.7 ↓	8.4 ←

beste Teiler 115.6 (17.) 163.0 (16.) 268.8 (14.)
 Trefferlage 1.32 mm links, 0.10 mm tief
 Streuwert 2.58, horizontal: 2.40, vertikal: 2.75

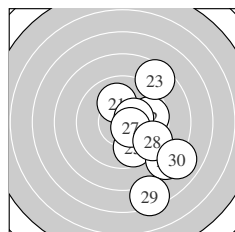

Serie 3:

10.0 ↑	9.7 →	8.5 ↗	10.4 *	9.7 ↓
8.4 ↘	10.5 *	9.3 ↘	7.4 ↓	8.0 ↘

beste Teiler 108.1 (27.) 135.4 (24.) 226.5 (21.)
 Trefferlage 2.69 mm rechts, 1.42 mm tief
 Streuwert 3.02, horizontal: 2.03, vertikal: 3.76

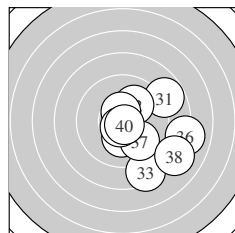

Serie 4:

8.8 ↗	10.1 ↗	8.4 ↓	10.2 *	10.5 *
8.0 →	9.8 ↘	8.1 ↘	10.7 *	10.8 *

beste Teiler 45.6 (40.) 74.3 (39.) 105.9 (35.)
 Trefferlage 2.31 mm rechts, 1.09 mm tief
 Streuwert 2.64, horizontal: 2.71, vertikal: 2.57

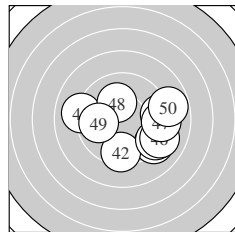

Serie 5:

9.1 ↘	9.5 ↓	9.2 →	9.2 ↘	9.1 ←
9.1 ↘	9.2 →	10.2 *	9.9 ←	8.8 →

beste Teiler 197.0 (48.) 275.5 (49.) 375.5 (42.)
 Trefferlage 1.70 mm rechts, 0.73 mm tief
 Streuwert 2.81, horizontal: 3.48, vertikal: 1.93

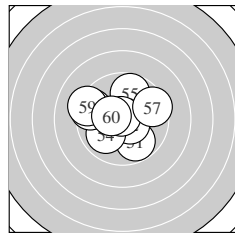

Serie 6:

9.8 ↘	10.5 *	9.5 ↖	9.9 ↘	9.7 ↑
10.8 *	9.5 →	9.4 ←	9.3 ←	10.4 *

beste Teiler 34.0 (56.) 102.6 (52.) 131.7 (60.)
 Trefferlage 0.79 mm links, 0.38 mm hoch
 Streuwert 2.09, horizontal: 2.48, vertikal: 1.60

Meyton Elektronik

ISSF AR Women Jun – Wertung – Juniorinnen

StartNr: 10

StandNr: 110

18. Januar 2020 9:39

Kuranda, Lena #286

T– Ebbser Sportschützen

Unterschrift des Schützen

Meyton Elektronik

Ergebnis:	629.3	(598) ^{QF}						
Serien:	105.9	104.9	104.2	105.0	105.4	103.9		
Zähler:	58	2	0	0	0	0	0	0
Innenzehner:	55							
weiteste:	267 (20), 255 (56), 244 (26)							
beste Teiler	38.2 (32.) 40.3 (53.) 43.2 (4.)							
Trefferlage	0.11 mm links, 0.02 mm hoch							
Streuwert	0.91, horizontal: 0.75, vertikal: 1.04							

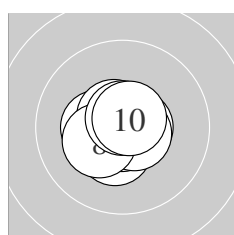
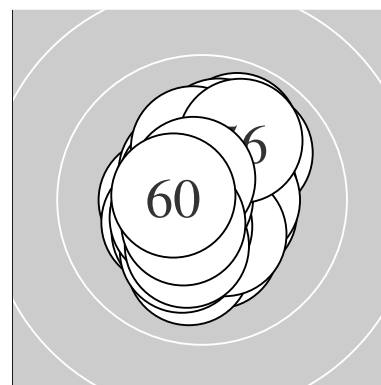

Serie 1:					
	10.6 *	10.4 *	10.4 *	10.8 *	10.6 *
	10.6 *	10.8 *	10.3 *	10.7 *	10.7 *
beste Teiler	43.2 (4.) 47.0 (7.) 55.0 (9.)				
Trefferlage	0.20 mm links, 0.07 mm tief				
Streuwert	0.72, horizontal: 0.79, vertikal: 0.65				

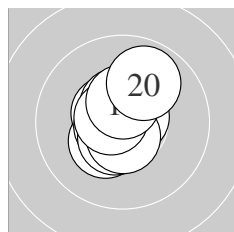

Serie 2:					
	10.3 *	10.7 *	10.5 *	10.7 *	10.5 *
	10.5 *	10.6 *	10.7 *	10.5 *	9.9 ↗
beste Teiler	65.8 (12.) 74.0 (18.) 74.3 (14.)				
Trefferlage	0.21 mm links, 0.25 mm hoch				
Streuwert	0.93, horizontal: 0.71, vertikal: 1.10				

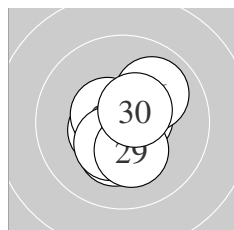

Serie 3:					
	10.7 *	10.5 *	10.5 *	10.3 *	10.6 *
	10.0 ↗	10.5 *	10.4 *	10.2 *	10.5 *
beste Teiler	53.5 (21.) 83.5 (25.) 101.5 (27.)				
Trefferlage	0.02 mm links, 0.26 mm tief				
Streuwert	1.03, horizontal: 0.92, vertikal: 1.13				

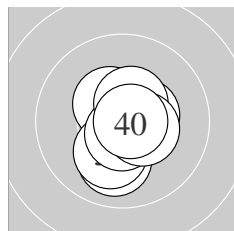

Serie 4:					
	10.0 ↓	10.8 *	10.8 *	10.4 *	10.5 *
	10.2 *	10.6 *	10.5 *	10.4 *	10.8 *
beste Teiler	38.2 (32.) 47.3 (33.) 48.0 (40.)				
Trefferlage	0.17 mm rechts, 0.28 mm tief				
Streuwert	0.93, horizontal: 0.71, vertikal: 1.11				

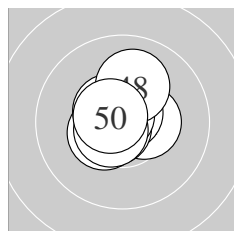

Serie 5:					
	10.4 *	10.7 *	10.7 *	10.7 *	10.4 *
	10.7 *	10.5 *	10.1 ↑	10.6 *	10.6 *
beste Teiler	52.8 (46.) 59.1 (42.) 60.4 (43.)				
Trefferlage	0.25 mm links, 0.32 mm hoch				
Streuwert	0.77, horizontal: 0.74, vertikal: 0.79				

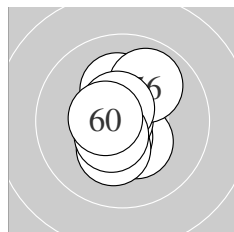

Serie 6:					
	10.4 *	10.5 *	10.8 *	10.2 *	10.2 *
	9.9 ↗	10.3 *	10.6 *	10.5 *	10.5 *
beste Teiler	40.3 (53.) 82.4 (58.) 105.1 (52.)				
Trefferlage	0.16 mm links, 0.20 mm hoch				
Streuwert	1.11, horizontal: 0.73, vertikal: 1.39				

Meyton Elektronik

ISSF AR Women Jun – Wertung – Juniorinnen

StartNr: 11

StandNr: 111

18. Januar 2020 9:39

Muller, Océanne #337

FRA

QF – Schütze hat sich fürs Finale qualifiziert

Unterschrift des Schützen

Meyton Elektronik

Ergebnis: **621.4** (590)
 Serien: 104.1 104.2 103.8 103.9 102.8 102.6
 Zähler: 50 10 0 0 0 0 0 0 0
 Innenzehner: 44
 weiteste: 381 (47), 335 (50), 322 (37)
 beste Teiler 25.1 (49.) 34.0 (1.) 40.6 (52.)
 Trefferlage 0.01 mm links, 0.00 mm
 Streuwert 1.21, horizontal: 1.44, vertikal: 0.93

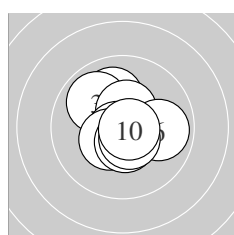
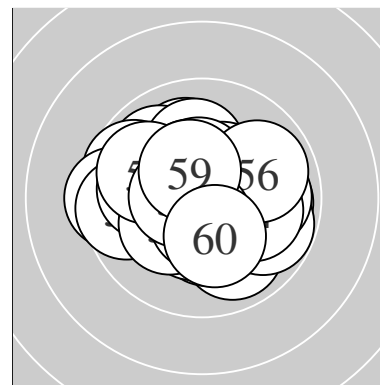

Serie 1:
 10.8 * 10.0 ↗ 9.9 ↘ 10.5 * 10.7 *
 9.9 → 10.4 * 10.5 * 10.6 * 10.8 *
 beste Teiler 34.0 (1.) 50.5 (10.) 53.0 (5.)
 Trefferlage 0.04 mm rechts, 0.16 mm hoch
 Streuwert 1.17, horizontal: 1.19, vertikal: 1.15

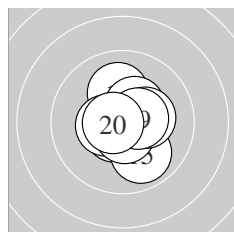

Serie 2:
 10.6 * 10.6 * 10.1 ↑ 10.4 * 9.9 ↘
 10.5 * 10.6 * 10.3 * 10.5 * 10.7 *
 beste Teiler 70.2 (20.) 80.4 (17.) 89.4 (11.)
 Trefferlage 0.29 mm rechts, 0.06 mm hoch
 Streuwert 1.08, horizontal: 0.97, vertikal: 1.18

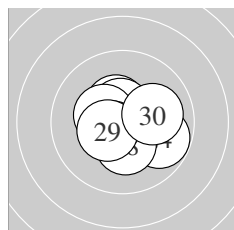

Serie 3:
 10.7 * 10.4 * 10.6 * 9.8 ↘ 10.7 *
 10.4 * 10.5 * 10.3 * 10.4 * 10.0 →
 beste Teiler 53.9 (21.) 71.4 (25.) 97.1 (23.)
 Trefferlage 0.13 mm rechts, 0.17 mm tief
 Streuwert 1.16, horizontal: 1.34, vertikal: 0.94

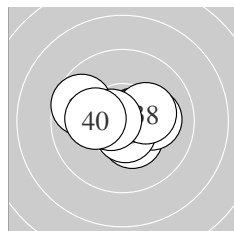

Serie 4:
 10.6 * 10.4 * 10.8 * 10.7 * 10.1 →
 10.6 * 9.7 ↘ 10.2 * 10.6 * 10.2 *
 beste Teiler 44.3 (33.) 74.1 (34.) 82.7 (36.)
 Trefferlage 0.00 mm , 0.01 mm hoch
 Streuwert 1.22, horizontal: 1.60, vertikal: 0.66

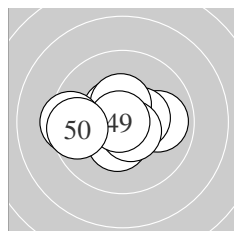

Serie 5:
 9.9 → 10.7 * 10.4 * 10.5 * 10.4 *
 10.4 * 9.4 ← 10.6 * 10.9 * 9.6 ←
 beste Teiler 25.1 (49.) 55.0 (42.) 88.4 (48.)
 Trefferlage 0.36 mm links, 0.02 mm tief
 Streuwert 1.47, horizontal: 1.93, vertikal: 0.75

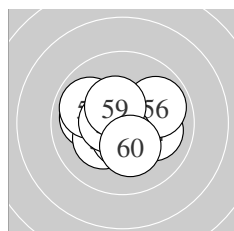

Serie 6:
 10.0 ← 10.8 * 10.2 * 10.0 → 9.9 ↘
 9.9 → 10.6 * 10.6 * 10.4 * 10.2 *
 beste Teiler 40.6 (52.) 97.1 (57.) 98.2 (58.)
 Trefferlage 0.21 mm links, 0.04 mm tief
 Streuwert 1.39, horizontal: 1.68, vertikal: 1.02

ISSF AR Women Jun – Wertung – Juniorinnen

StartNr: 12

StandNr: 112

18. Januar 2020 9:52

Brabcova, Karolina #338

CZE

Unterschrift des Schützen

Meyton Elektronik

Ergebnis:	610.3	(586)
Serien:	102.6 99.5	101.1 103.5 102.0 101.6
Zähler:	46 14 0 0 0 0 0 0 0	
Innenzehner:	34	
weiteste:	447 (20), 413 (16), 409 (25)	
beste Teiler	9.2 (2.) 41.1 (56.) 47.4 (36.)	
Trefferlage	0.08 mm rechts, 0.07 mm hoch	
Streuwert	1.55, horizontal: 1.66, vertikal: 1.42	

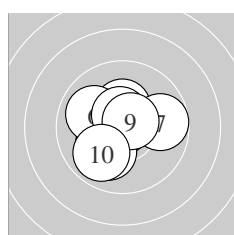
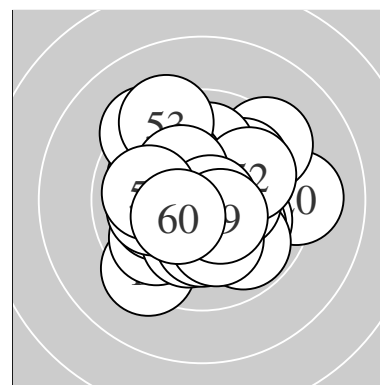

Serie 1:	10.3 *	10.9 *	10.2 *	10.1 ✓	10.2 *
	10.0 ↖	9.8 →	10.6 *	10.6 *	9.9 ✓
beste Teiler	9.2 (2.)	78.6 (9.)	98.2 (8.)		
Trefferlage	0.50 mm links, 0.00 mm				
Streuwert	1.42, horizontal: 1.55, vertikal: 1.28				

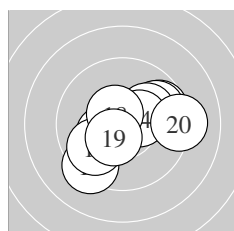

Serie 2:	9.7 →	9.8 →	10.1 →	10.4 *	10.3 *
	9.3 ✓	9.8 ✓	10.5 *	10.4 *	9.2 →
beste Teiler	103.0 (18.)	126.7 (19.)	140.4 (14.)		
Trefferlage	0.57 mm rechts, 0.20 mm tief				
Streuwert	1.99, horizontal: 2.39, vertikal: 1.49				

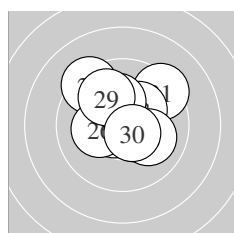

Serie 3:	9.4 ↗	10.5 *	10.2 *	10.7 *	9.3 ↘
	10.2 *	10.2 *	10.1 ↘	9.9 ↘	10.6 *
beste Teiler	75.1 (24.)	99.4 (30.)	115.1 (22.)		
Trefferlage	0.12 mm rechts, 0.81 mm hoch				
Streuwert	1.67, horizontal: 1.78, vertikal: 1.56				

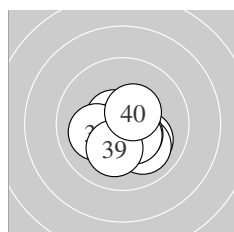

Serie 4:	10.1 ↘	10.0 ↘	10.6 *	10.5 *	10.4 *
	10.8 *	10.4 *	10.1 ←	10.1 ↓	10.5 *
beste Teiler	47.4 (36.)	82.9 (33.)	123.4 (34.)		
Trefferlage	0.14 mm rechts, 0.73 mm tief				
Streuwert	1.07, horizontal: 1.23, vertikal: 0.89				

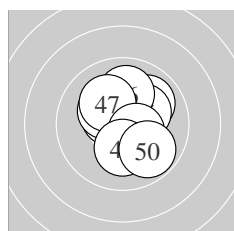

Serie 5:	10.5 *	10.0 ↗	10.3 *	10.4 *	10.2 *
	10.0 ↑	10.1 ↘	10.5 *	10.2 *	9.8 ↘
beste Teiler	112.7 (41.)	123.1 (48.)	137.2 (44.)		
Trefferlage	0.45 mm rechts, 0.31 mm hoch				
Streuwert	1.40, horizontal: 1.29, vertikal: 1.51				

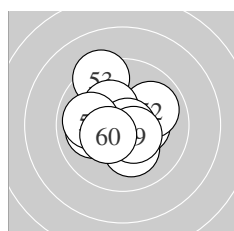

Serie 6:	10.3 *	9.9 →	9.3 ↘	10.3 *	10.0 ←
	10.8 *	10.2 *	9.9 ←	10.5 *	10.4 *
beste Teiler	41.1 (56.)	116.8 (59.)	138.6 (60.)		
Trefferlage	0.29 mm links, 0.25 mm hoch				
Streuwert	1.59, horizontal: 1.65, vertikal: 1.53				

Meyton Elektronik

ISSF AR Women Jun – Wertung – Juniorinnen

StandNr: 113

Kocher, Jennifer #339

StartNr: 13

18. Januar 2020 9:37

SUI

Unterschrift des Schützen

Meyton Elektronik

Ergebnis:	610.8	(581)
Serien:	101.0 102.7 102.6 99.4 102.2 102.9	
Zähler:	43 15 2 0 0 0 0 0 0 0	
Innenzehner:	35	
weiteste:	521 (36), 520 (17), 390 (60)	
beste Teiler	12.2 (42.) 29.2 (55.) 29.9 (12.)	
Trefferlage	0.10 mm links, 0.08 mm hoch	
Streuwert	1.62, horizontal: 1.97, vertikal: 1.19	

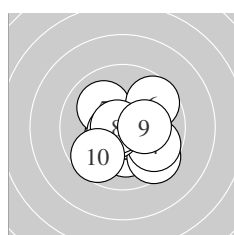
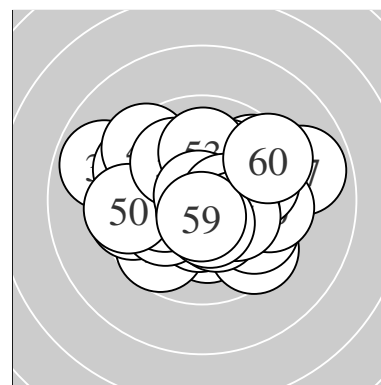

Serie 1:	10.5 *	10.2 *	9.5 ↘	9.8 ↘	10.0 ↘
	9.7 ↗	10.6 *	10.8 *	10.2 *	9.7 ↙
beste Teiler	45.0 (8.)	84.5 (7.)	103.4 (1.)		
Trefferlage	0.40 mm rechts, 0.54 mm tief				
Streuwert	1.70, horizontal: 1.83, vertikal: 1.56				

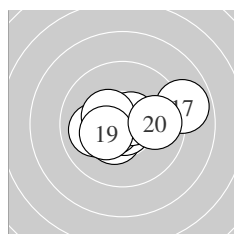

Serie 2:	10.4 *	10.8 *	10.8 *	10.6 *	10.6 *
	10.0 ←	8.9 →	10.4 *	10.3 *	9.9 →
beste Teiler	29.9 (12.)	40.3 (13.)	81.5 (15.)		
Trefferlage	0.20 mm rechts, 0.00 mm				
Streuwert	1.62, horizontal: 2.16, vertikal: 0.76				

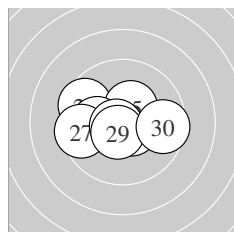

Serie 3:	10.7 *	10.8 *	9.6 ↖	10.6 *	10.4 *
	10.1 ←	9.5 ←	10.7 *	10.6 *	9.6 →
beste Teiler	46.0 (22.)	54.1 (21.)	61.9 (28.)		
Trefferlage	0.40 mm links, 0.06 mm tief				
Streuwert	1.55, horizontal: 2.06, vertikal: 0.78				

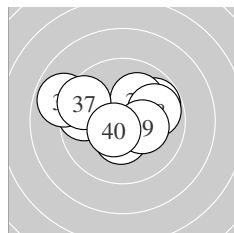

Serie 4:	10.5 *	9.6 ←	10.4 *	9.8 ↗	10.1 ↗
	8.9 ↖	9.5 ↖	9.8 →	10.3 *	10.5 *
beste Teiler	103.9 (40.)	123.2 (31.)	137.7 (33.)		
Trefferlage	0.29 mm links, 0.50 mm hoch				
Streuwert	2.05, horizontal: 2.66, vertikal: 1.15				

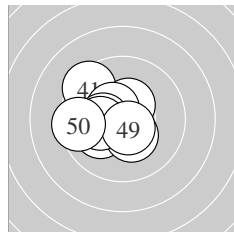

Serie 5:	9.4 ↖	10.9 *	10.4 *	10.1 ↙	10.5 *
	10.3 *	10.3 *	10.2 *	10.6 *	9.5 ←
beste Teiler	12.2 (42.)	88.5 (49.)	116.6 (45.)		
Trefferlage	1.08 mm links, 0.04 mm hoch				
Streuwert	1.36, horizontal: 1.52, vertikal: 1.18				

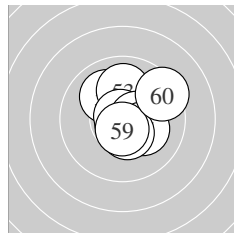

Serie 6:	10.1 ↑	10.0 ↘	10.0 ↑	10.8 *	10.8 *
	10.5 *	10.2 *	10.5 *	10.6 *	9.4 ↗
beste Teiler	29.2 (55.)	44.5 (54.)	84.0 (59.)		
Trefferlage	0.51 mm rechts, 0.55 mm hoch				
Streuwert	1.35, horizontal: 1.27, vertikal: 1.42				

Meyton Elektronik

ISSF AR Women Jun – Wertung – Juniorinnen

StandNr: 114

Biechl, Julia #180

StartNr: 14

18. Januar 2020 9:35

T – SG Absam

Unterschrift des Schützen

Meyton Elektronik

Ergebnis:	607.9	(578)						
Serien:	100.5	100.2	102.4	102.9	101.9	100.0		
Zähler:	39	20	1	0	0	0	0	0
Innenzehner:	31							
weiteste:	513 (40), 473 (14), 409 (53)							
beste Teiler	28.6 (52.) 39.8 (5.) 49.2 (19.)							
Trefferlage	0.13 mm links, 0.07 mm hoch							
Streuwert	1.65, horizontal: 1.83, vertikal: 1.46							

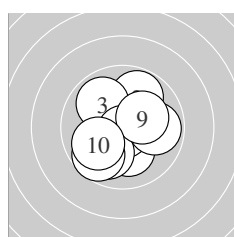
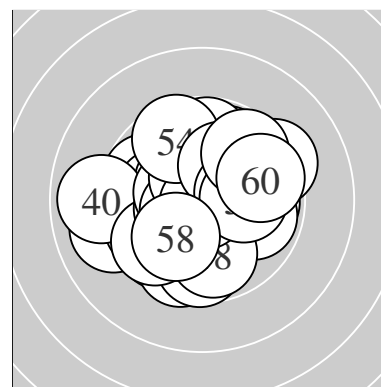

Serie 1:	10.0 ↙	9.8 ↗	9.9 ↘	10.2 *	10.8 *
	10.0 ↘	9.7 ↙	9.9 →	10.2 *	10.0 ↙
beste Teiler	39.8 (5.) 186.0 (9.) 199.3 (4.)				
Trefferlage	0.27 mm links, 0.43 mm tief				
Streuwert	1.75, horizontal: 1.76, vertikal: 1.74				

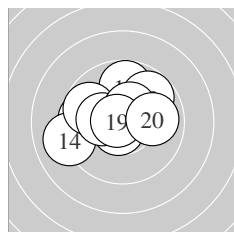

Serie 2:	9.7 ←	9.8 ↑	9.8 ↗	9.1 ←	10.7 *
	9.7 ↘	10.3 *	10.4 *	10.8 *	9.9 →
beste Teiler	49.2 (19.) 68.7 (15.) 132.0 (18.)				
Trefferlage	0.75 mm links, 0.62 mm hoch				
Streuwert	1.86, horizontal: 2.30, vertikal: 1.28				

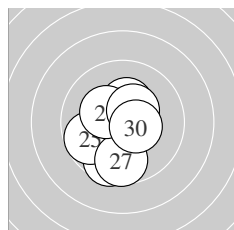

Serie 3:	10.3 *	10.7 *	9.6 ↓	10.6 *	9.7 ↙
	10.6 *	9.7 ↓	10.3 *	10.4 *	10.5 *
beste Teiler	72.0 (22.) 78.3 (26.) 100.7 (24.)				
Trefferlage	0.29 mm links, 0.36 mm tief				
Streuwert	1.48, horizontal: 1.22, vertikal: 1.70				

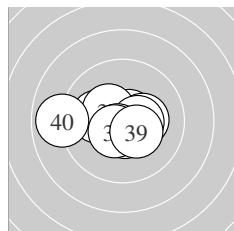

Serie 4:	10.6 *	10.1 ←	10.7 *	10.3 *	10.4 *
	10.4 *	10.6 *	10.5 *	10.4 *	8.9 ←
beste Teiler	68.8 (33.) 89.0 (37.) 95.3 (31.)				
Trefferlage	0.47 mm links, 0.16 mm tief				
Streuwert	1.51, horizontal: 2.03, vertikal: 0.66				

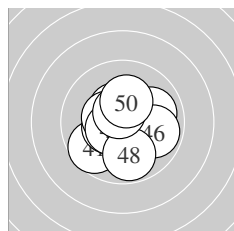

Serie 5:	9.7 ↙	10.4 *	10.4 *	10.0 →	10.4 *
	9.9 →	10.5 *	9.8 ↓	10.6 *	10.2 *
beste Teiler	88.8 (49.) 108.5 (47.) 126.4 (42.)				
Trefferlage	0.08 mm links, 0.18 mm tief				
Streuwert	1.51, horizontal: 1.59, vertikal: 1.43				

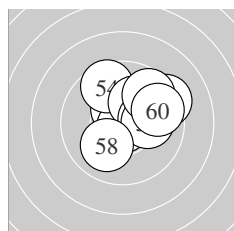

Serie 6:	10.5 *	10.8 *	9.3 ↗	9.6 ↘	10.1 ↗
	10.2 *	10.1 →	10.0 ↙	9.7 ↗	9.7 →
beste Teiler	28.6 (52.) 124.7 (51.) 188.6 (56.)				
Trefferlage	1.07 mm rechts, 0.96 mm hoch				
Streuwert	1.62, horizontal: 1.77, vertikal: 1.45				

ISSF AR Women Jun – Wertung – Juniorinnen

StandNr: 115

Surny, Kim #340

StartNr: 15

18. Januar 2020 9:42

SUI

Unterschrift des Schützen

Meyton Elektronik

Ergebnis:	621.7	(592) ^{QF}							
Serien:	104.5	103.4	102.8	104.4	103.9	102.7			
Zähler:	52	8	0	0	0	0	0	0	0
Innenzehner:	45								
weiteste:	365 (54), 357 (11), 330 (45)								
beste Teiler	19.2 (14.)	22.3 (19.)	29.1 (33.)						
Trefferlage	0.30 mm links, 0.34 mm hoch								
Streuwert	1.17, horizontal: 1.24, vertikal: 1.09								

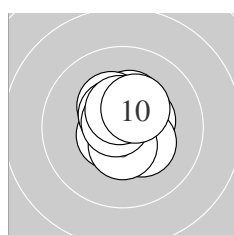
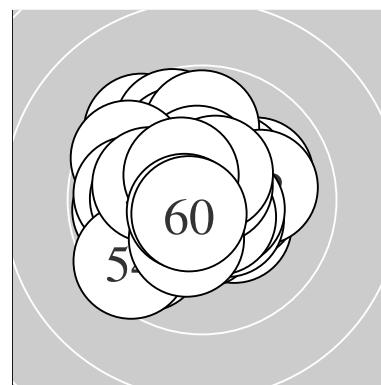

Serie 1:	10.3 *	10.3 *	10.6 *	10.4 *	10.3 *
	10.5 *	10.5 *	10.7 *	10.5 *	10.4 *
beste Teiler	55.2 (8.) 91.8 (3.) 104.0 (7.)				
Trefferlage	0.09 mm rechts, 0.40 mm hoch				
Streuwert	0.89, horizontal: 0.79, vertikal: 0.98				

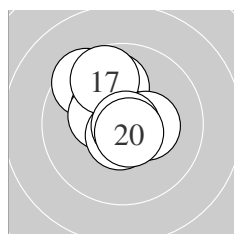

Serie 2:	9.5 ↘	10.3 *	10.0 ↑	10.9 *	10.4 *
	10.7 *	9.7 ↘	10.3 *	10.9 *	10.7 *
beste Teiler	19.2 (14.) 22.3 (19.) 68.4 (20.)				
Trefferlage	0.43 mm links, 0.81 mm hoch				
Streuwert	1.24, horizontal: 1.10, vertikal: 1.37				

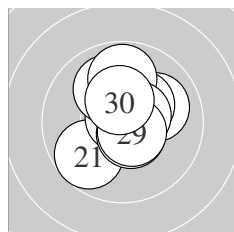

Serie 3:	9.7 ↙	10.0 →	10.8 *	10.0 ↖	10.3 *
	9.8 ↑	10.6 *	10.6 *	10.6 *	10.4 *
beste Teiler	33.8 (23.) 87.6 (29.) 94.0 (28.)				
Trefferlage	0.17 mm rechts, 0.56 mm hoch				
Streuwert	1.33, horizontal: 1.19, vertikal: 1.46				

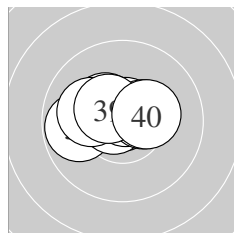

Serie 4:	9.8 ←	10.4 *	10.8 *	10.7 *	10.7 *
	10.7 *	10.4 *	10.1 ←	10.5 *	10.3 *
beste Teiler	29.1 (33.) 58.6 (35.) 61.9 (36.)				
Trefferlage	0.47 mm links, 0.43 mm hoch				
Streuwert	0.99, horizontal: 1.36, vertikal: 0.37				

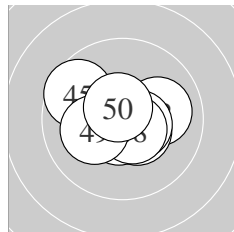

Serie 5:	10.6 *	10.0 →	10.5 *	10.7 *	9.6 ↖
	10.5 *	10.6 *	10.6 *	10.2 *	10.6 *
beste Teiler	67.6 (44.) 78.7 (47.) 81.7 (50.)				
Trefferlage	0.06 mm links, 0.03 mm tief				
Streuwert	1.20, horizontal: 1.48, vertikal: 0.85				

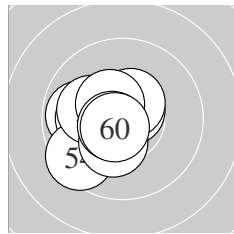

Serie 6:	9.8 ←	10.7 *	10.1 ←	9.5 ↙	10.1 ↖
	10.3 *	10.5 *	10.4 *	10.6 *	10.7 *
beste Teiler	74.2 (60.) 75.7 (52.) 82.3 (59.)				
Trefferlage	1.13 mm links, 0.14 mm tief				
Streuwert	1.17, horizontal: 1.23, vertikal: 1.11				

Meyton Elektronik

QF – Schütze hat sich fürs Finale qualifiziert

Unterschrift des Schützen

Meyton Elektronik

Ergebnis: **603.9** (581)
 Serien: 98.2 101.4 99.4 104.5 101.1 99.3
 Zähler: 43 15 2 0 0 0 0 0 0
 Innenzehner: 32
 weiteste: 640 (21), 623 (18), 487 (47)
 beste Teiler 17.0 (31.) 41.6 (32.) 51.4 (49.)
 Trefferlage 0.61 mm links, 0.35 mm tief
 Streuwert 1.79, horizontal: 2.10, vertikal: 1.40

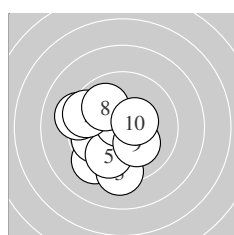
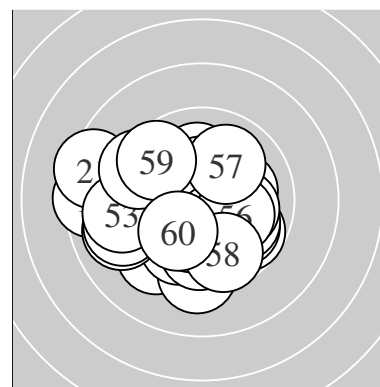

Serie 1:
 9.3 ↙ 9.8 ← 9.3 ↓ 9.2 ↖ 9.8 ↘
 10.7 * 9.5 ↖ 10.0 ↘ 10.2 * 10.4 *
 beste Teiler 55.2 (6.) 127.0 (10.) 199.7 (9.)
 Trefferlage 1.39 mm links, 0.73 mm tief
 Streuwert 1.97, horizontal: 1.86, vertikal: 2.07

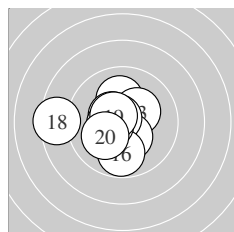

Serie 2:
 10.1 ↑ 10.5 * 10.3 * 10.4 * 10.7 *
 9.8 ↓ 10.5 * 8.5 ← 10.5 * 10.1 ↙
 beste Teiler 56.7 (15.) 104.0 (19.) 119.0 (12.)
 Trefferlage 0.98 mm links, 0.08 mm tief
 Streuwert 1.76, horizontal: 2.04, vertikal: 1.42

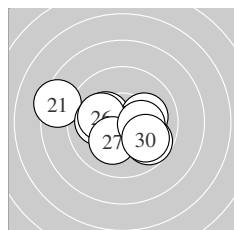

Serie 3:
 8.4 ↖ 10.3 * 10.0 ← 10.1 → 10.5 *
 10.1 ↖ 10.2 * 9.7 ↘ 10.2 * 9.9 ↘
 beste Teiler 124.4 (25.) 171.5 (22.) 177.1 (29.)
 Trefferlage 0.34 mm links, 0.23 mm tief
 Streuwert 2.12, horizontal: 2.76, vertikal: 1.17

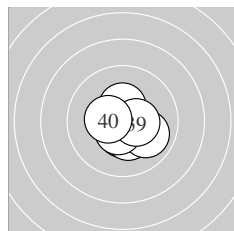

Serie 4:
 10.9 * 10.8 * 10.4 * 10.5 * 10.3 *
 10.3 * 10.0 ↘ 10.5 * 10.4 * 10.4 *
 beste Teiler 17.0 (31.) 41.6 (32.) 101.7 (38.)
 Trefferlage 0.36 mm rechts, 0.38 mm tief
 Streuwert 0.96, horizontal: 1.03, vertikal: 0.89

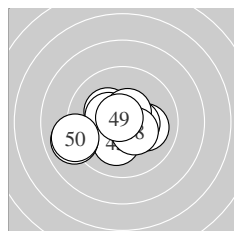

Serie 5:
 10.3 * 10.4 * 10.1 → 10.4 * 10.2 *
 10.5 * 9.0 ← 10.4 * 10.7 * 9.1 ←
 beste Teiler 51.4 (49.) 103.3 (46.) 129.9 (44.)
 Trefferlage 0.76 mm links, 0.37 mm tief
 Streuwert 1.79, horizontal: 2.29, vertikal: 1.08

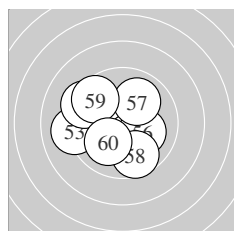

Serie 6:
 10.4 * 10.6 * 9.1 ← 10.3 * 9.4 ↖
 10.1 ↘ 10.0 ↗ 9.7 ↓ 9.6 ↖ 10.1 ↘
 beste Teiler 79.1 (52.) 141.7 (51.) 152.3 (54.)
 Trefferlage 0.59 mm links, 0.30 mm tief
 Streuwert 2.04, horizontal: 2.31, vertikal: 1.74

ISSF AR Women Jun – Wertung – Juniorinnen

StandNr: 117

Patka, Anna #59

StartNr: 17

18. Januar 2020 9:22

T – SG Thierberg

Unterschrift des Schützen

Meyton Elektronik

Ergebnis:	621.0	(592)							
Serien:	102.4	104.2	103.9	103.6	102.1	104.8			
Zähler:	52	8	0	0	0	0	0	0	0
Innenzehner:	47								
weiteste:	447 (48), 436 (6), 322 (8)								
beste Teiler	3.0 (59.)	14.1 (25.)	26.0 (52.)						
Trefferlage	0.42 mm rechts, 0.10 mm tief								
Streuwert	1.22, horizontal: 1.27, vertikal: 1.18								

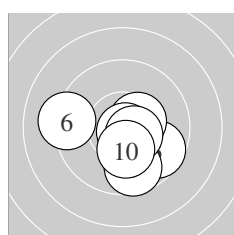
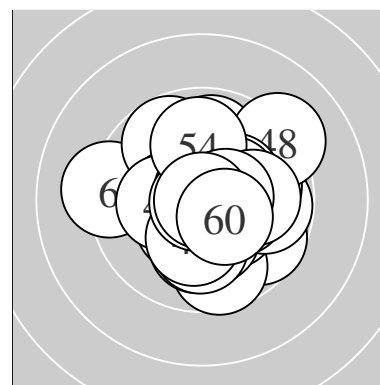

Serie 1:	10.7 *	10.4 *	9.7 ↘	10.7 *	10.4 *
	9.2 ←	10.8 *	9.7 ↓	10.5 *	10.3 *
beste Teiler	40.8 (7.) 65.7 (4.) 74.4 (1.)				
Trefferlage	0.38 mm rechts, 0.80 mm tief				
Streuwert	1.50, horizontal: 1.81, vertikal: 1.10				

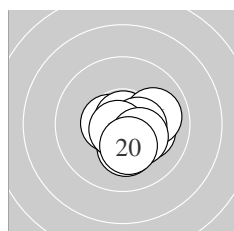

Serie 2:	10.2 *	10.2 *	10.5 *	10.8 *	10.7 *
	10.0 →	10.5 *	10.7 *	10.3 *	10.3 *
beste Teiler	34.3 (14.) 55.1 (18.) 58.1 (15.)				
Trefferlage	0.59 mm rechts, 0.50 mm tief				
Streuwert	0.94, horizontal: 1.07, vertikal: 0.79				

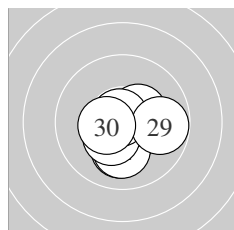

Serie 3:	10.5 *	10.1 ↓	10.5 *	10.1 ↓	10.9 *
	10.4 *	10.4 *	10.8 *	9.8 →	10.4 *
beste Teiler	14.1 (25.) 41.6 (28.) 104.2 (23.)				
Trefferlage	0.07 mm rechts, 0.64 mm tief				
Streuwert	1.09, horizontal: 1.22, vertikal: 0.95				

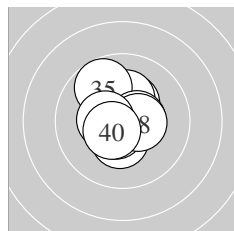

Serie 4:	10.3 *	10.4 *	10.5 *	10.2 *	9.7 ↖
	10.6 *	10.5 *	10.5 *	10.4 *	10.5 *
beste Teiler	89.4 (36.) 103.3 (33.) 111.2 (40.)				
Trefferlage	0.09 mm links, 0.39 mm hoch				
Streuwert	1.12, horizontal: 0.96, vertikal: 1.27				

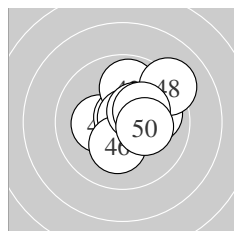

Serie 5:	10.2 *	10.8 *	9.9 ↑	10.8 *	10.0 →
	10.2 *	10.4 *	9.2 ↗	10.3 *	10.3 *
beste Teiler	38.0 (42.) 44.0 (44.) 131.3 (47.)				
Trefferlage	0.86 mm rechts, 0.62 mm hoch				
Streuwert	1.43, horizontal: 1.51, vertikal: 1.34				

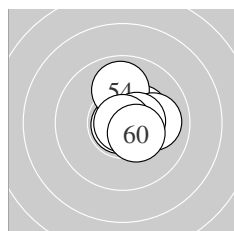

Serie 6:	10.3 *	10.8 *	10.6 *	9.9 ↑	10.7 *
	10.7 *	10.0 →	10.5 *	10.9 *	10.4 *
beste Teiler	3.0 (59.) 26.0 (52.) 59.0 (56.)				
Trefferlage	0.71 mm rechts, 0.34 mm hoch				
Streuwert	0.86, horizontal: 0.80, vertikal: 0.91				

Meyton Elektronik

ISSF AR Women Jun – Wertung – Juniorinnen

StartNr: 18

StandNr: 118

18. Januar 2020 9:43

Tashtchiev, Olga #342

ISR

Unterschrift des Schützen

Meyton Elektronik

Ergebnis: **601.3** (573)
 Serien: 100.2 101.5 100.2 99.3 99.1 101.0
 Zähler: 35 23 2 0 0 0 0 0 0
 Innenzehner: 28
 weiteste: 599 (21), 573 (55), 424 (37)
 beste Teiler 38.1 (15.) 48.2 (53.) 53.1 (17.)
 Trefferlage 0.24 mm rechts, 0.16 mm hoch
 Streuwert 1.86, horizontal: 1.77, vertikal: 1.94

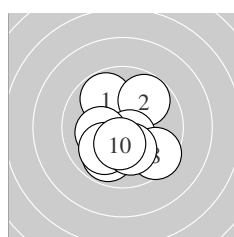
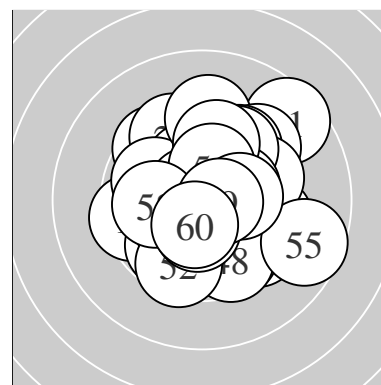

Serie 1:
 9.8 ↘ 9.8 ↗ 10.6 * 9.9 ↙ 10.2 *
 9.9 ↙ 10.0 ↙ 9.5 ↘ 10.1 ↘ 10.4 *
 beste Teiler 96.6 (3.) 145.1 (10.) 192.8 (5.)
 Trefferlage 0.15 mm links, 0.86 mm tief
 Streuwert 1.72, horizontal: 1.61, vertikal: 1.83

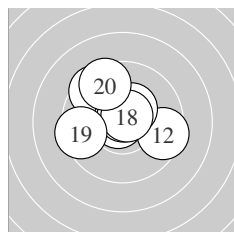

Serie 2:
 10.4 * 9.5 → 10.5 * 9.5 ↘ 10.8 *
 10.4 * 10.7 * 10.7 * 9.5 ← 9.5 ↘
 beste Teiler 38.1 (15.) 53.1 (17.) 65.4 (18.)
 Trefferlage 0.52 mm links, 0.80 mm hoch
 Streuwert 1.67, horizontal: 1.93, vertikal: 1.36

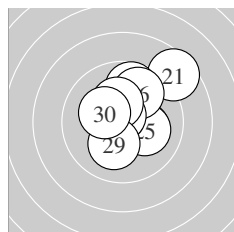

Serie 3:
 8.6 ↗ 10.2 * 10.3 * 9.7 ↑ 10.1 →
 9.8 ↗ 10.7 * 10.3 * 10.2 * 10.3 *
 beste Teiler 62.0 (27.) 166.2 (23.) 170.6 (28.)
 Trefferlage 0.80 mm rechts, 1.09 mm hoch
 Streuwert 1.76, horizontal: 1.70, vertikal: 1.81

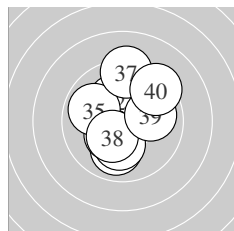

Serie 4:
 9.8 ↗ 10.2 * 10.0 ↓ 10.3 * 9.9 ↘
 10.1 ↓ 9.3 ↑ 10.3 * 10.0 → 9.4 ↗
 beste Teiler 159.2 (38.) 160.6 (34.) 191.2 (32.)
 Trefferlage 0.09 mm rechts, 0.59 mm hoch
 Streuwert 1.99, horizontal: 1.66, vertikal: 2.27

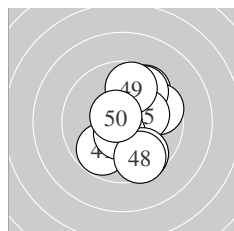

Serie 5:
 9.8 ↙ 9.6 ↗ 9.7 → 9.7 ↗ 10.2 *
 10.5 * 9.7 ↘ 9.6 ↘ 9.7 ↑ 10.6 *
 beste Teiler 77.3 (50.) 103.5 (46.) 191.9 (45.)
 Trefferlage 0.98 mm rechts, 0.14 mm hoch
 Streuwert 1.92, horizontal: 1.44, vertikal: 2.30

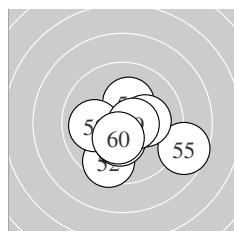

Serie 6:
 10.2 * 9.5 ↙ 10.8 * 10.2 * 8.7 →
 10.4 * 10.2 * 10.0 ← 10.6 * 10.4 *
 beste Teiler 48.2 (53.) 92.5 (59.) 134.4 (60.)
 Trefferlage 0.25 mm rechts, 0.77 mm tief
 Streuwert 1.82, horizontal: 2.16, vertikal: 1.41

ISSF AR Women Jun – Wertung – Juniorinnen

StandNr: 119

Messner, Helena #170

StartNr: 19

18. Januar 2020 9:37

T – SG Absam

Unterschrift des Schützen

Meyton Elektronik

Ergebnis:	624.6	(596) ^{QF}							
Serien:	105.1	103.0	103.7	103.0	104.6	105.2			
Zähler:	56	4	0	0	0	0	0	0	0
Innenzehner:	49								
weiteste:	315 (34), 293 (18), 271 (60)								
beste Teiler	33.1 (42.)	44.1 (9.)	45.6 (59.)						
Trefferlage	0.03 mm rechts, 0.67 mm hoch								
Streuwert	0.98, horizontal: 1.11, vertikal: 0.82								

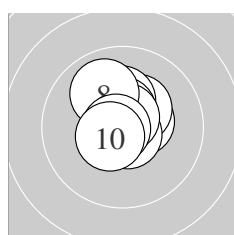
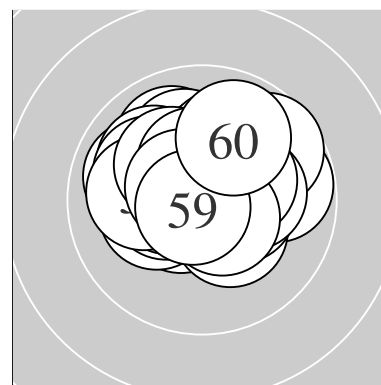

Serie 1:	10.5 *	10.3 *	10.3 *	10.8 *	10.5 *
	10.7 *	10.7 *	10.0 ↘	10.8 *	10.5 *
beste Teiler	44.1 (9.)	46.2 (4.)	55.4 (6.)		
Trefferlage	0.05 mm links, 0.60 mm hoch				
Streuwert	0.83, horizontal: 0.73, vertikal: 0.93				

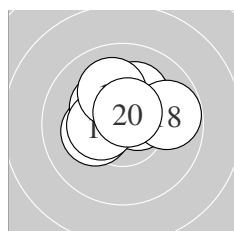

Serie 2:	10.2 *	10.6 *	10.3 *	10.5 *	10.3 *
	10.2 *	10.4 *	9.8 →	10.1 ↗	10.6 *
beste Teiler	82.4 (20.)	97.8 (12.)	111.8 (14.)		
Trefferlage	0.00 mm, 0.81 mm hoch				
Streuwert	1.17, horizontal: 1.44, vertikal: 0.80				

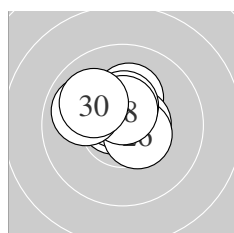

Serie 3:	10.2 *	10.7 *	10.6 *	10.2 *	10.6 *
	10.5 *	10.4 *	10.6 *	9.9 ↖	10.0 ↖
beste Teiler	65.1 (22.)	91.4 (23.)	94.3 (25.)		
Trefferlage	0.42 mm links, 0.81 mm hoch				
Streuwert	0.95, horizontal: 1.14, vertikal: 0.70				

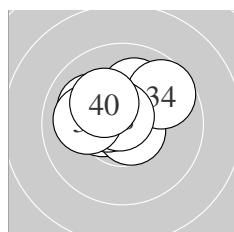

Serie 4:	10.1 ↗	10.4 *	10.7 *	9.7 ↗	10.5 *
	10.6 *	10.1 ↖	10.7 *	10.0 ←	10.2 *
beste Teiler	53.4 (38.)	69.2 (33.)	97.4 (36.)		
Trefferlage	0.47 mm links, 0.80 mm hoch				
Streuwert	1.16, horizontal: 1.43, vertikal: 0.79				

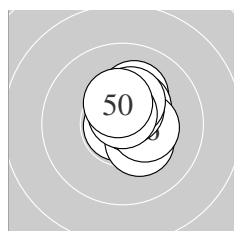

Serie 5:	10.1 ↗	10.8 *	10.3 *	10.7 *	10.4 *
	10.4 *	10.5 *	10.3 *	10.7 *	10.4 *
beste Teiler	33.1 (42.)	65.0 (49.)	68.4 (44.)		
Trefferlage	0.51 mm rechts, 0.63 mm hoch				
Streuwert	0.77, horizontal: 0.58, vertikal: 0.92				

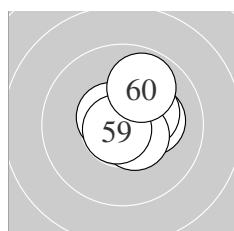

Serie 6:	10.8 *	10.8 *	10.8 *	10.6 *	10.5 *
	10.2 *	10.3 *	10.5 *	10.8 *	9.9 ↗
beste Teiler	45.6 (59.)	47.1 (52.)	47.8 (53.)		
Trefferlage	0.63 mm rechts, 0.37 mm hoch				
Streuwert	0.82, horizontal: 0.80, vertikal: 0.84				

Meyton Elektronik

QF – Schütze hat sich fürs Finale qualifiziert

Unterschrift des Schützen

Meyton Elektronik

Ergebnis: **588.8** (561)

Serien: 101.2 99.9 94.2 98.2 98.1 97.2

Zähler: 30 22 7 1 0 0 0 0 0 0

Innenzehner: 22

weiteste: 770 (26), 749 (15), 646 (51)

beste Teiler 12.0 (12.) 37.3 (20.) 62.8 (11.)

Trefferlage 0.14 mm rechts, 0.41 mm tief

Streuwert 2.36, horizontal: 2.93, vertikal: 1.61

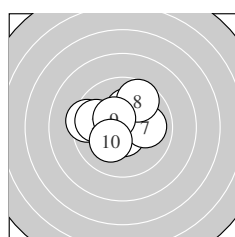
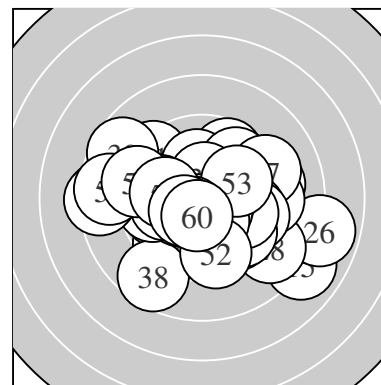

Serie 1:

9.4 ←	9.8 ←	10.2 *	10.7 *	10.6 *
10.2 *	10.0 →	9.7 ↗	10.4 *	10.2 *

beste Teiler 72.2 (4.) 85.8 (5.) 128.0 (9.)

Trefferlage 0.29 mm links, 0.48 mm hoch

Streuwert 1.65, horizontal: 1.97, vertikal: 1.23

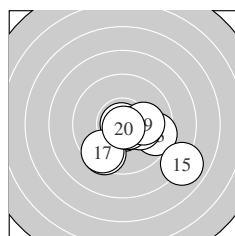

Serie 2:

10.7 *	10.9 *	9.5 ↘	10.2 *	8.0 ↘
9.5 ↙	9.5 ↙	10.7 *	10.1 →	10.8 *

beste Teiler 12.0 (12.) 37.3 (20.) 62.8 (11.)

Trefferlage 1.03 mm rechts, 1.29 mm tief

Streuwert 2.07, horizontal: 2.51, vertikal: 1.50

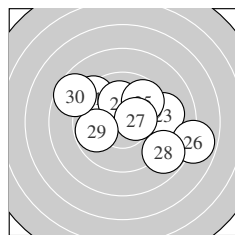

Serie 3:

9.3 ↘	10.3 *	9.2 →	10.1 ↑	9.7 ↗
7.9 →	10.4 *	8.8 ↘	9.8 ←	8.7 ↖

beste Teiler 141.8 (27.) 175.2 (22.) 211.7 (24.)

Trefferlage 1.00 mm rechts, 0.53 mm hoch

Streuwert 3.07, horizontal: 3.84, vertikal: 2.03

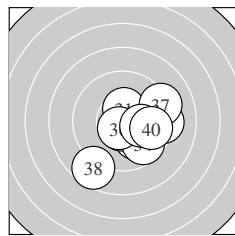

Serie 4:

10.4 *	10.0 ↘	10.6 *	9.7 ↘	9.3 →
10.6 *	9.2 →	8.6 ↙	10.1 →	9.7 →

beste Teiler 84.5 (36.) 90.7 (33.) 127.8 (31.)

Trefferlage 1.32 mm rechts, 0.90 mm tief

Streuwert 2.06, horizontal: 2.24, vertikal: 1.87

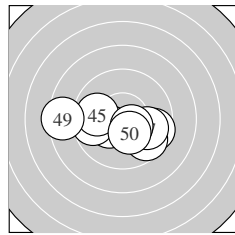

Serie 5:

9.6 →	9.9 ↘	10.3 *	9.7 ←	9.9 ←
9.6 ↘	9.9 →	10.5 *	8.4 ←	10.3 *

beste Teiler 120.2 (48.) 160.8 (43.) 161.4 (50.)

Trefferlage 0.15 mm links, 0.89 mm tief

Streuwert 2.27, horizontal: 3.11, vertikal: 0.78

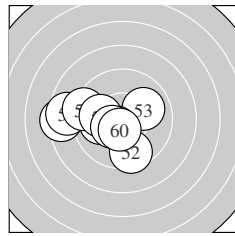

Serie 6:

8.4 ←	9.5 ↓	10.0 ↗	8.6 ←	10.0 ←
10.5 *	9.3 ←	10.0 ←	10.4 *	10.5 *

beste Teiler 112.1 (56.) 116.4 (60.) 138.8 (59.)

Trefferlage 2.01 mm links, 0.38 mm tief

Streuwert 2.19, horizontal: 2.79, vertikal: 1.33

Meyton Elektronik

ISSF AR Women Jun – Wertung – Juniorinnen

StandNr: 121

Schmidt, Selina #343

StartNr: 21

18. Januar 2020 9:29

OOE – SV Theuerwang

Unterschrift des Schützen

Meyton Elektronik

Ergebnis: **606.6** (580)

Serien: 99.9 100.8 97.7 101.9 103.0 103.3

Zähler: 40 20 0 0 0 0 0 0 0 0

Innenzehner: 31

weiteste: 484 (12), 465 (26), 463 (27)

beste Teiler 36.1 (54.) 47.0 (44.) 62.6 (51.)

Trefferlage 0.06 mm links, 0.02 mm hoch

Streuwert 1.72, horizontal: 2.06, vertikal: 1.29

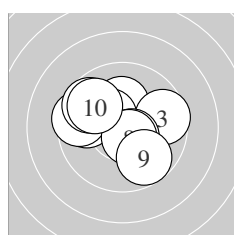
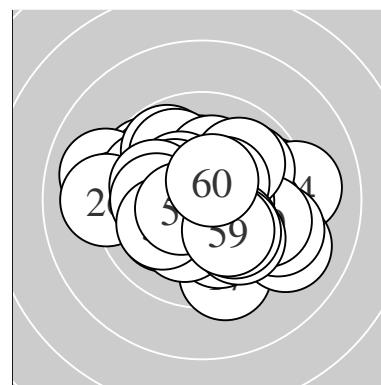

Serie 1:

10.2 *	10.4 *	9.6 →	9.8 ←	9.5 ←
10.5 *	9.7 ↖	10.6 *	9.8 ↓	9.8 ↗

beste Teiler 97.6 (8.) 104.6 (6.) 140.7 (2.)

Trefferlage 0.62 mm links, 0.42 mm hoch

Streuwert 1.85, horizontal: 2.22, vertikal: 1.38

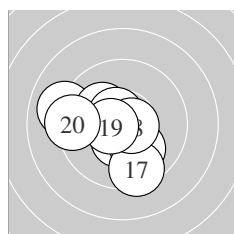

Serie 2:

10.4 *	9.0 ←	10.0 ↓	10.2 *	10.6 *
10.6 *	9.4 ↓	10.7 *	10.6 *	9.3 ←

beste Teiler 72.1 (18.) 90.9 (15.) 91.4 (16.)

Trefferlage 1.00 mm links, 0.38 mm tief

Streuwert 1.78, horizontal: 2.02, vertikal: 1.51

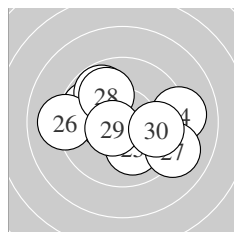

Serie 3:

9.8 ↖	10.4 *	9.8 ↖	9.1 →	10.1 ↓
9.1 ←	9.1 ↘	9.9 ↖	10.6 *	9.8 →

beste Teiler 95.1 (29.) 136.7 (22.) 219.8 (25.)

Trefferlage 0.03 mm links, 0.10 mm hoch

Streuwert 2.39, horizontal: 3.01, vertikal: 1.55

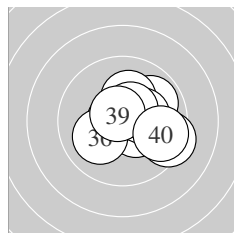

Serie 4:

10.7 *	10.4 *	9.9 ↗	9.4 ↘	10.2 *
10.1 ↖	10.3 *	10.5 *	10.7 *	9.7 →

beste Teiler 66.0 (31.) 71.8 (39.) 112.0 (38.)

Trefferlage 0.99 mm rechts, 0.08 mm hoch

Streuwert 1.47, horizontal: 1.72, vertikal: 1.16

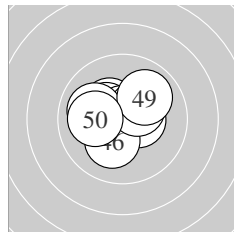

Serie 5:

10.4 *	10.3 *	10.4 *	10.8 *	10.4 *
10.2 *	10.4 *	10.0 ←	10.0 ↗	10.1 ←

beste Teiler 47.0 (44.) 126.2 (45.) 146.2 (47.)

Trefferlage 0.23 mm links, 0.47 mm hoch

Streuwert 1.26, horizontal: 1.51, vertikal: 0.94

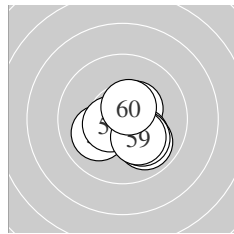

Serie 6:

10.7 *	10.4 *	10.1 ↖	10.8 *	10.1 ↓
9.9 ↓	10.5 *	10.1 ↓	10.2 *	10.5 *

beste Teiler 36.1 (54.) 62.6 (51.) 106.8 (60.)

Trefferlage 0.55 mm rechts, 0.55 mm tief

Streuwert 1.13, horizontal: 1.20, vertikal: 1.06

Meyton Elektronik

ISSF AR Women Jun – Wertung – Juniorinnen

StandNr: 122

Kathrein, Johanna #344

StartNr: 22

18. Januar 2020 9:24

T – SG Hötting

Unterschrift des Schützen

Meyton Elektronik

Ergebnis: **622.6** (594)^{QF}
 Serien: 103.3 103.9 102.8 102.8 104.5 105.3
 Zähler: 54 6 0 0 0 0 0 0 0
 Innenzehner: 41
 weiteste: 382 (23), 312 (33), 292 (1)
 beste Teiler 23.7 (24.) 30.0 (44.) 30.4 (39.)
 Trefferlage 0.18 mm rechts, 0.05 mm hoch
 Streuwert 1.17, horizontal: 1.22, vertikal: 1.11

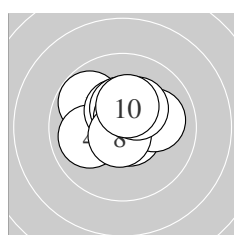
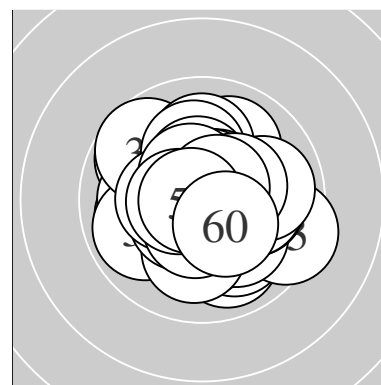

Serie 1:
 9.8 ↘ 10.7 * 10.0 → 10.0 ← 10.4 *
 10.4 * 10.7 * 10.7 * 10.3 * 10.3 *
 beste Teiler 63.5 (8.) 72.1 (2.) 75.1 (7.)
 Trefferlage 0.12 mm links, 0.65 mm hoch
 Streuwert 1.19, horizontal: 1.39, vertikal: 0.93

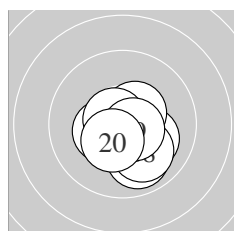

Serie 2:
 10.8 * 10.5 * 9.9 ↘ 10.4 * 10.1 ↘
 10.5 * 10.7 * 10.0 ↘ 10.6 * 10.4 *
 beste Teiler 41.1 (11.) 66.7 (17.) 83.1 (19.)
 Trefferlage 0.33 mm rechts, 0.76 mm tief
 Streuwert 0.98, horizontal: 1.01, vertikal: 0.95

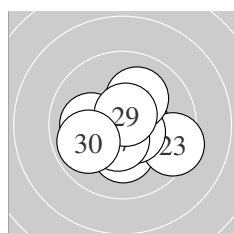

Serie 3:
 10.5 * 10.2 * 9.4 ↘ 10.9 * 10.6 *
 10.1 ↗ 10.5 * 10.1 ← 10.6 * 9.9 ←
 beste Teiler 23.7 (24.) 76.9 (29.) 93.8 (25.)
 Trefferlage 0.14 mm rechts, 0.30 mm tief
 Streuwert 1.45, horizontal: 1.71, vertikal: 1.12

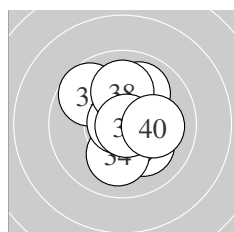

Serie 4:
 10.1 ↘ 10.6 * 9.7 ↘ 10.1 ↓ 10.6 *
 10.0 ↗ 10.8 * 10.0 ↑ 10.8 * 10.1 →
 beste Teiler 30.4 (39.) 31.3 (37.) 93.1 (35.)
 Trefferlage 0.33 mm rechts, 0.19 mm hoch
 Streuwert 1.40, horizontal: 1.23, vertikal: 1.56

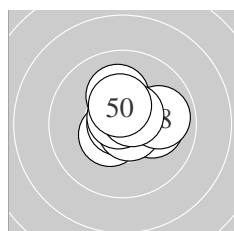

Serie 5:
 10.5 * 10.1 → 10.7 * 10.8 * 10.7 *
 10.1 ↑ 10.7 * 9.9 → 10.6 * 10.4 *
 beste Teiler 30.0 (44.) 51.7 (43.) 56.0 (47.)
 Trefferlage 0.38 mm rechts, 0.41 mm hoch
 Streuwert 0.98, horizontal: 1.12, vertikal: 0.81

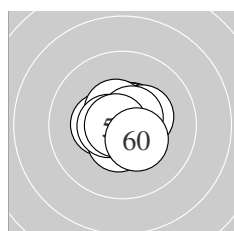

Serie 6:
 10.6 * 10.6 * 10.3 * 10.4 * 10.5 *
 10.5 * 10.6 * 10.6 * 10.8 * 10.4 *
 beste Teiler 47.0 (59.) 83.0 (58.) 83.2 (52.)
 Trefferlage 0.01 mm rechts, 0.15 mm hoch
 Streuwert 0.83, horizontal: 0.91, vertikal: 0.74

ISSF AR Women Jun – Wertung – Juniorinnen

StartNr: 23

StandNr: 123

18. Januar 2020 9:23

Ng, Cecilia #316

SGP

QF – Schütze hat sich fürs Finale qualifiziert

Unterschrift des Schützen

Meyton Elektronik

Ergebnis:	598.4	(568)
Serien:	98.1	100.3 97.6 101.2 102.9 98.3
Zähler:	32 24 4 0 0 0 0 0 0	
Innenzehner:	22	
weiteste:	658 (2), 649 (28), 532 (20)	
beste Teiler	5.0 (49.) 56.3 (53.) 83.2 (15.)	
Trefferlage	0.39 mm rechts, 0.48 mm hoch	
Streuwert	1.93, horizontal: 2.09, vertikal: 1.75	

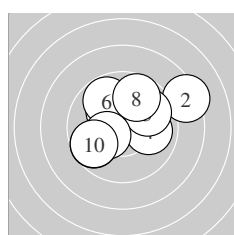
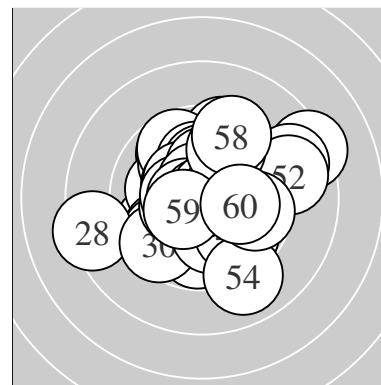

Serie 1:	10.2 *	8.3 ↗	10.5 *	10.0 →	9.9 ↗
	9.8 ↘	9.7 ↙	9.7 ↑	10.3 *	9.7 ↙
beste Teiler	103.4 (3.)	165.9 (9.)	188.8 (1.)		
Trefferlage	0.22 mm rechts, 0.75 mm hoch				
Streuwert	2.31, horizontal: 2.78, vertikal: 1.72				

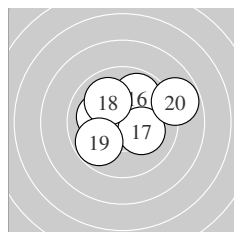

Serie 2:	10.1 ←	9.9 ↗	10.4 *	10.6 *	10.6 *
	9.9 ↗	10.2 *	10.0 ↘	9.8 ↙	8.8 →
beste Teiler	83.2 (15.)	95.5 (14.)	134.1 (13.)		
Trefferlage	0.60 mm rechts, 0.80 mm hoch				
Streuwert	1.80, horizontal: 2.15, vertikal: 1.36				

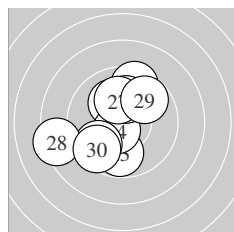

Serie 3:	9.5 ↑	10.1 ↘	9.8 ↓	10.6 *	10.1 ↑
	9.7 ↙	10.1 ↑	8.4 ↙	9.8 ↗	9.5 ↙
beste Teiler	93.6 (24.)	207.7 (22.)	212.6 (27.)		
Trefferlage	0.97 mm links, 0.14 mm hoch				
Streuwert	2.35, horizontal: 2.30, vertikal: 2.40				

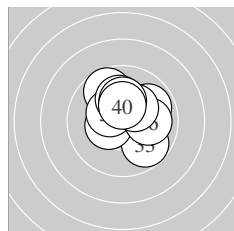

Serie 4:	9.7 ↘	9.9 ↗	9.8 ↘	10.4 *	10.4 *
	10.0 →	10.1 ↑	10.3 *	10.2 *	10.4 *
beste Teiler	138.8 (34.)	142.8 (35.)	148.0 (40.)		
Trefferlage	0.37 mm rechts, 0.89 mm hoch				
Streuwert	1.48, horizontal: 1.54, vertikal: 1.42				

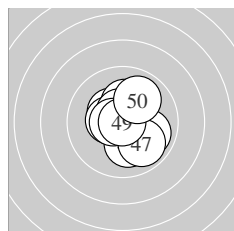

Serie 5:	10.1 ↓	10.4 *	10.4 *	10.2 *	10.6 *
	9.9 →	9.9 ↘	10.6 *	10.9 *	9.9 ↗
beste Teiler	5.0 (49.)	90.0 (48.)	93.9 (45.)		
Trefferlage	0.26 mm rechts, 0.08 mm hoch				
Streuwert	1.34, horizontal: 1.24, vertikal: 1.43				

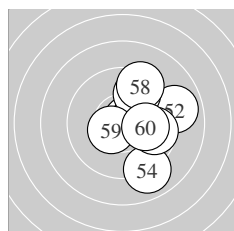

Serie 6:	9.9 →	8.9 →	10.7 *	9.0 ↓	10.4 *
	9.7 →	9.7 ↑	9.4 ↑	10.5 *	10.1 →
beste Teiler	56.3 (53.)	125.1 (59.)	128.7 (55.)		
Trefferlage	1.87 mm rechts, 0.22 mm hoch				
Streuwert	1.90, horizontal: 1.59, vertikal: 2.16				

Meyton Elektronik

ISSF AR Women Jun – Wertung – Juniorinnen

StandNr: 124

Lintner, Sarah #187

StartNr: 24

18. Januar 2020 9:58

T – SG Schwaz

Unterschrift des Schützen

Meyton Elektronik

Ergebnis: **626.1** (598)^{QF}
 Serien: 104.2 105.2 105.0 104.1 103.8 103.8
 0.0
 Zähler: 58 2 0 0 0 0 0 0 0 0
 Innenzehner: 53
 weiteste: 300 (50), 296 (36), 243 (24)
 beste Teiler 8.5 (31.) 8.9 (23.) 26.3 (56.)
 Trefferlage 0.06 mm rechts, 0.12 mm hoch
 Streuwert 1.02, horizontal: 1.11, vertikal: 0.91

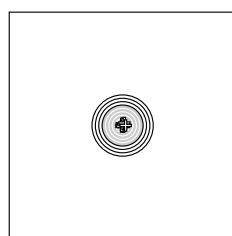
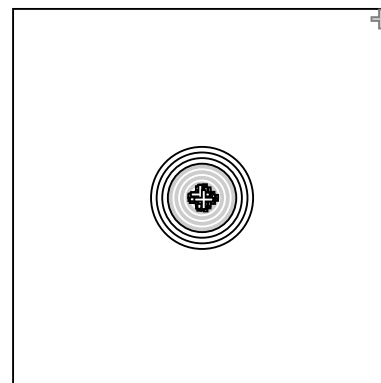

Serie 1:
 10.5 * 10.6 * 10.6 * 10.4 * 10.5 *
 10.5 * 10.7 * 10.4 * 10.0 ↗ 10.0 →
 beste Teiler 71.6 (7.) 91.7 (3.) 97.8 (2.)
 Trefferlage 0.29 mm rechts, 0.39 mm hoch
 Streuwert 0.99, horizontal: 1.03, vertikal: 0.96

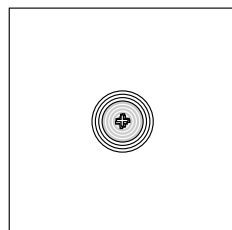

Serie 2:
 10.8 * 10.5 * 10.6 * 10.3 * 10.5 *
 10.6 * 10.4 * 10.4 * 10.4 * 10.7 *
 beste Teiler 48.3 (11.) 74.0 (20.) 93.5 (13.)
 Trefferlage 0.10 mm rechts, 0.38 mm hoch
 Streuwert 0.80, horizontal: 0.80, vertikal: 0.80

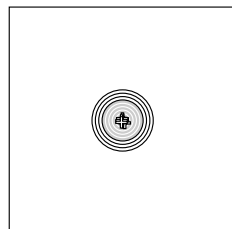

Serie 3:
 10.4 * 10.7 * 10.9 * 10.0 ↘ 10.5 *
 10.5 * 10.4 * 10.7 * 10.6 * 10.3 *
 beste Teiler 8.9 (23.) 64.2 (28.) 70.7 (22.)
 Trefferlage 0.13 mm links, 0.40 mm tief
 Streuwert 0.92, horizontal: 0.73, vertikal: 1.07

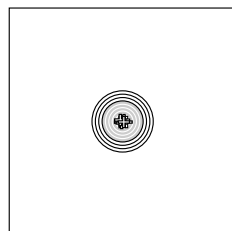

Serie 4:
 10.9 * 10.2 * 10.6 * 10.8 * 10.3 *
 9.8 → 10.4 * 10.4 * 10.1 ↖ 10.6 *
 beste Teiler 8.5 (31.) 38.4 (34.) 90.0 (33.)
 Trefferlage 0.05 mm links, 0.01 mm tief
 Streuwert 1.19, horizontal: 1.53, vertikal: 0.69

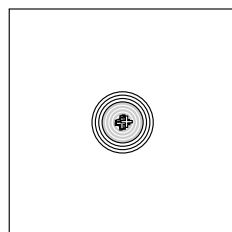

Serie 5:
 10.2 * 10.4 * 10.4 * 10.3 * 10.5 *
 10.5 * 10.5 * 10.6 * 10.6 * 9.8 →
 beste Teiler 84.6 (49.) 89.4 (48.) 104.6 (47.)
 Trefferlage 0.27 mm rechts, 0.01 mm hoch
 Streuwert 1.14, horizontal: 1.33, vertikal: 0.91

Meyton Elektronik

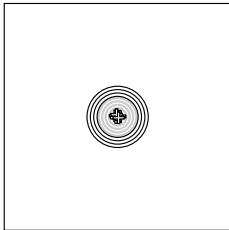

Serie 6:

10.2 *	10.7 *	10.3 *	10.3 *	10.2 *
10.8 *	10.1 ↖	10.4 *	10.3 *	10.5 *

beste Teiler 26.3 (56.) 63.2 (52.) 106.0 (60.)

Trefferlage 0.11 mm links, 0.40 mm hoch

Streuwert 1.10, horizontal: 1.25, vertikal: 0.94

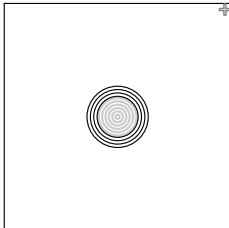

Serie 7:

0.0+ ↗
AST.NSC

beste Teiler

Trefferlage 0.00 mm , 0.00 mm

Streuwert 0.00, horizontal: 0.00, vertikal: 0.00

AST – Treffer wurde nach Ende der Schießzeit abgegeben
 NSC – Treffer wurde vermessen, geht aber nicht in die Wertung ein
 QF – Schütze hat sich fürs Finale qualifiziert

Unterschrift des Schützen

Ergebnis: **596.7** (573)
 Serien: 102.2 97.9 98.7 99.1 98.7 100.1
 Zähler: 37 19 4 0 0 0 0 0 0
 Innenzehner: 24
 weiteste: 677 (13), 605 (35), 533 (48)
 beste Teiler 34.1 (40.) 43.4 (54.) 56.2 (9.)
 Trefferlage 0.23 mm links, 0.44 mm tief
 Streuwert 2.01, horizontal: 2.03, vertikal: 1.99

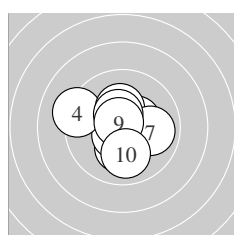
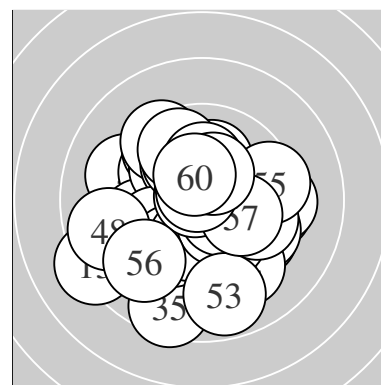

Serie 1:
 10.2 * 10.4 * 10.6 * 9.2 ↖ 10.4 *
 10.3 * 9.9 → 10.5 * 10.7 * 10.0 ↓
 beste Teiler 56.2 (9.) 90.4 (3.) 124.5 (8.)
 Trefferlage 0.16 mm links, 0.12 mm tief
 Streuwert 1.56, horizontal: 1.69, vertikal: 1.41

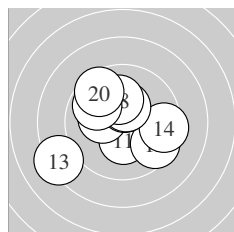

Serie 2:
 10.3 * 9.5 ↘ 8.2 ↙ 9.4 → 10.2 *
 10.4 * 10.4 * 10.1 ↑ 9.8 ↖ 9.6 ↖
 beste Teiler 132.2 (16.) 140.4 (17.) 160.1 (11.)
 Trefferlage 0.51 mm links, 0.17 mm hoch
 Streuwert 2.40, horizontal: 2.74, vertikal: 2.01

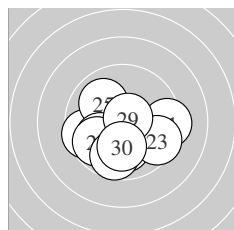

Serie 3:
 9.3 → 10.0 ↓ 9.5 ↘ 9.6 ↙ 10.0 ↖
 10.0 ↙ 9.8 ↙ 9.7 ↓ 10.7 * 10.1 ↓
 beste Teiler 62.0 (29.) 221.1 (30.) 231.2 (22.)
 Trefferlage 0.23 mm links, 1.14 mm tief
 Streuwert 1.95, horizontal: 2.36, vertikal: 1.43

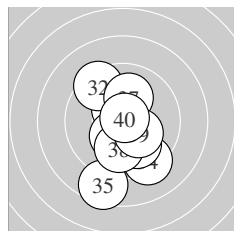

Serie 4:
 10.5 * 9.4 ↖ 10.3 * 9.3 ↘ 8.5 ↓
 10.0 ↘ 10.1 ↑ 10.0 ↓ 10.2 * 10.8 *
 beste Teiler 34.1 (40.) 119.4 (31.) 155.0 (33.)
 Trefferlage 0.00 mm, 0.96 mm tief
 Streuwert 2.16, horizontal: 1.43, vertikal: 2.71

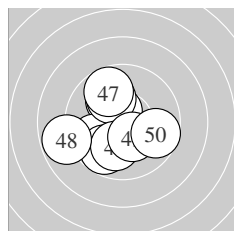

Serie 5:
 10.1 ↖ 10.5 * 9.8 ↙ 10.0 ↖ 9.8 ↙
 10.0 ↓ 9.7 ↖ 8.8 ↙ 10.3 * 9.7 →
 beste Teiler 109.1 (42.) 161.6 (49.) 223.1 (41.)
 Trefferlage 0.99 mm links, 0.24 mm tief
 Streuwert 2.03, horizontal: 2.10, vertikal: 1.97

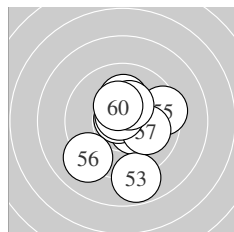

Serie 6:
 10.2 * 10.4 * 8.8 ↓ 10.8 * 9.4 →
 9.1 ↙ 10.0 → 10.7 * 10.3 * 10.4 *
 beste Teiler 43.4 (54.) 56.8 (58.) 129.8 (52.)
 Trefferlage 0.45 mm rechts, 0.36 mm tief
 Streuwert 2.05, horizontal: 1.80, vertikal: 2.27

Meyton Elektronik

ISSF AR Women Jun – Wertung – Juniorinnen

StandNr: 126

Kubista, Lea #345

StartNr: 26

18. Januar 2020 9:25

OOE – SV Theuerwang

Unterschrift des Schützen

Meyton Elektronik

Ergebnis:	593.6	(569)
Serien:	95.7 98.7 98.3 100.0 98.3 102.6	
Zähler:	32 25 3 0 0 0 0 0 0 0	
Innenzehner:	25	
weiteste:	589 (25), 535 (3), 534 (31)	
beste Teiler	23.2 (51.) 58.0 (34.) 93.2 (48.)	
Trefferlage	0.47 mm links, 0.03 mm tief	
Streuwert	2.08, horizontal: 2.35, vertikal: 1.77	

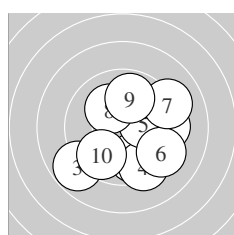
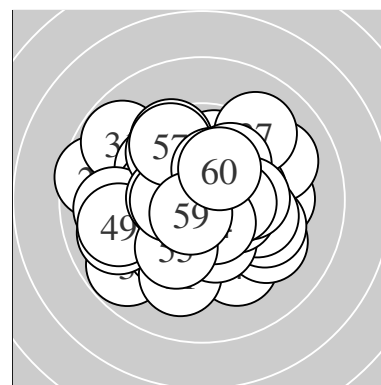

Serie 1:	9.4 →	9.8 ↓	8.8 ↙	9.4 ↓	10.2 *
	9.3 ↘	9.1 ↗	10.1 ↖	9.9 ↑	9.7 ↙
beste Teiler	192.2 (5.)	203.6 (8.)	269.9 (9.)		
Trefferlage	0.96 mm rechts, 0.77 mm tief				
Streuwert	2.54, horizontal: 2.67, vertikal: 2.40				

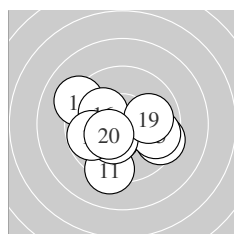

Serie 2:	9.3 ↓	10.5 *	9.5 ↘	9.2 ↖	9.7 →
	10.1 ↖	10.3 *	9.8 ↙	10.0 →	10.3 *
beste Teiler	124.9 (12.)	154.4 (20.)	158.1 (17.)		
Trefferlage	0.36 mm links, 0.70 mm tief				
Streuwert	2.11, horizontal: 2.48, vertikal: 1.66				

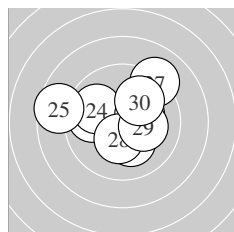

Serie 3:	9.9 ↖	9.8 ↖	10.2 *	9.9 ↖	8.6 ↖
	10.3 *	9.1 ↗	10.3 *	10.2 *	10.0 ↗
beste Teiler	154.7 (28.)	169.5 (26.)	191.0 (29.)		
Trefferlage	0.51 mm links, 0.59 mm hoch				
Streuwert	2.23, horizontal: 2.73, vertikal: 1.59				

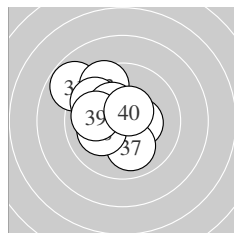

Serie 4:	8.8 ↖	10.4 *	9.5 ↖	10.7 *	9.7 ↖
	10.3 *	10.0 ↓	10.1 ↙	10.0 ↖	10.5 *
beste Teiler	58.0 (34.)	106.8 (40.)	143.7 (32.)		
Trefferlage	1.10 mm links, 0.68 mm hoch				
Streuwert	1.77, horizontal: 1.79, vertikal: 1.74				

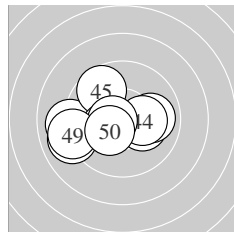

Serie 5:	10.2 *	9.0 ↖	9.9 →	10.2 *	9.7 ↖
	10.3 *	9.0 ↖	10.6 *	9.1 ↖	10.3 *
beste Teiler	93.2 (48.)	156.5 (50.)	170.8 (46.)		
Trefferlage	1.32 mm links, 0.36 mm tief				
Streuwert	2.11, horizontal: 2.73, vertikal: 1.19				

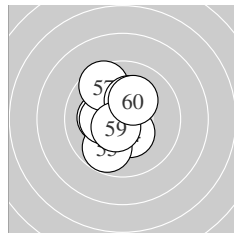

Serie 6:	10.9 *	10.4 *	10.2 *	10.4 *	9.8 ↙
	10.3 *	9.6 ↖	10.2 *	10.6 *	10.2 *
beste Teiler	23.2 (51.)	94.3 (59.)	131.1 (52.)		
Trefferlage	0.51 mm links, 0.33 mm hoch				
Streuwert	1.39, horizontal: 1.09, vertikal: 1.63				

Meyton Elektronik

ISSF AR Women Jun – Wertung – Juniorinnen

StandNr: 123

Zass, Zoe #192

StartNr: 27

18. Januar 2020 11:18

T – SG Westendorf

Unterschrift des Schützen

Meyton Elektronik

Ergebnis: **621.4** (589)
 Serien: 105.2 102.2 104.6 102.8 103.0 103.6
 Zähler: 49 11 0 0 0 0 0 0 0
 Innenzehner: 44
 weiteste: 359 (19), 345 (31), 316 (15)
 beste Teiler 20.3 (9.) 41.4 (1.) 45.8 (44.)
 Trefferlage 0.16 mm links, 0.02 mm tief
 Streuwert 1.24, horizontal: 1.38, vertikal: 1.09

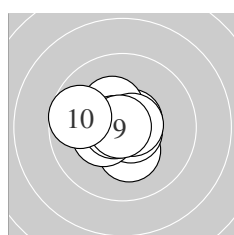
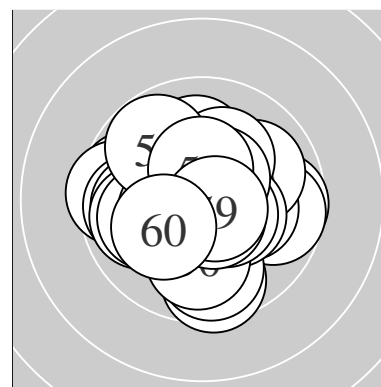

Serie 1:
 10.8 * 10.3 * 10.7 * 10.7 * 10.4 *
 10.3 * 10.7 * 10.7 * 10.9 * 9.7 ←
 beste Teiler 20.3 (9.) 41.4 (1.) 60.0 (8.)
 Trefferlage 0.38 mm links, 0.00 mm
 Streuwert 0.99, horizontal: 1.15, vertikal: 0.81

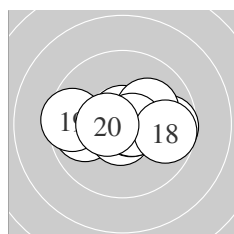

Serie 2:
 9.9 ← 10.7 * 10.7 * 10.7 * 9.7 →
 10.1 ↗ 10.7 * 9.7 → 9.5 ← 10.5 *
 beste Teiler 51.1 (13.) 60.4 (14.) 68.1 (17.)
 Trefferlage 0.17 mm rechts, 0.01 mm tief
 Streuwert 1.61, horizontal: 2.21, vertikal: 0.51

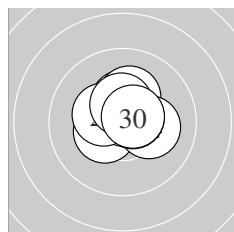

Serie 3:
 10.4 * 10.2 * 10.4 * 10.2 * 10.6 *
 10.7 * 10.6 * 10.4 * 10.5 * 10.6 *
 beste Teiler 54.1 (26.) 76.9 (27.) 80.9 (25.)
 Trefferlage 0.14 mm rechts, 0.59 mm hoch
 Streuwert 0.86, horizontal: 0.95, vertikal: 0.76

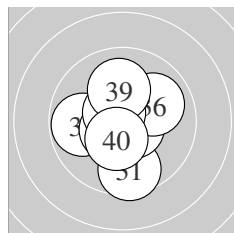

Serie 4:
 9.6 ↓ 10.5 * 9.8 ← 10.6 * 10.7 *
 10.0 ↗ 10.5 * 10.6 * 10.1 ↑ 10.4 *
 beste Teiler 69.0 (35.) 85.0 (34.) 86.2 (38.)
 Trefferlage 0.20 mm links, 0.22 mm tief
 Streuwert 1.42, horizontal: 1.28, vertikal: 1.54

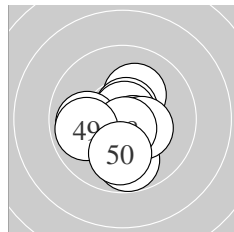

Serie 5:
 9.8 ↓ 10.2 * 10.7 * 10.8 * 10.6 *
 9.9 ← 10.4 * 10.7 * 9.9 ← 10.0 ↓
 beste Teiler 45.8 (44.) 69.3 (48.) 75.2 (43.)
 Trefferlage 0.13 mm links, 0.53 mm tief
 Streuwert 1.36, horizontal: 1.34, vertikal: 1.37

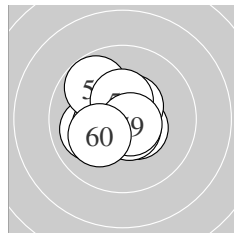

Serie 6:
 10.5 * 10.6 * 10.0 ← 10.5 * 10.5 *
 10.4 * 9.8 ↘ 10.4 * 10.7 * 10.2 *
 beste Teiler 67.6 (59.) 84.8 (52.) 112.4 (55.)
 Trefferlage 0.56 mm links, 0.05 mm hoch
 Streuwert 1.15, horizontal: 1.21, vertikal: 1.09

Meyton Elektronik

ISSF AR Women Jun – Wertung – Juniorinnen

StartNr: 28

StandNr: 128

18. Januar 2020 9:51

Stefankova, Katerina #11

CZE

Unterschrift des Schützen

Meyton Elektronik

Ergebnis: **622.7** (593)^{QF}
 Serien: 102.8 104.4 104.9 102.1 104.8 103.7
 Zähler: 53 7 0 0 0 0 0 0 0 0
 Innenzehner: 47
 weiteste: 406 (32), 343 (42), 285 (26)
 beste Teiler 5.0 (47.) 29.6 (22.) 38.9 (46.)
 Trefferlage 0.01 mm links, 0.19 mm hoch
 Streuwert 1.15, horizontal: 1.32, vertikal: 0.96

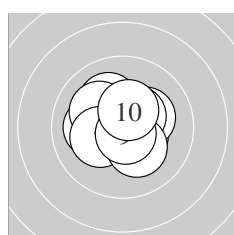
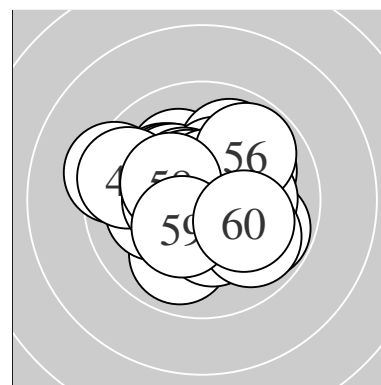

Serie 1:
 10.4 * 10.1 ← 10.2 * 10.4 * 10.1 ↗
 10.1 ↘ 10.2 * 10.2 * 10.7 * 10.4 *
 beste Teiler 54.1 (9.) 126.3 (4.) 132.0 (1.)
 Trefferlage 0.11 mm links, 0.23 mm hoch
 Streuwert 1.24, horizontal: 1.39, vertikal: 1.06

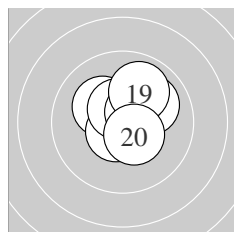

Serie 2:
 10.8 * 10.7 * 10.7 * 10.2 * 10.6 *
 10.5 * 10.5 * 10.0 ↗ 9.9 ↗ 10.5 *
 beste Teiler 41.0 (11.) 51.4 (12.) 56.0 (13.)
 Trefferlage 0.28 mm rechts, 0.36 mm hoch
 Streuwert 1.02, horizontal: 0.99, vertikal: 1.05

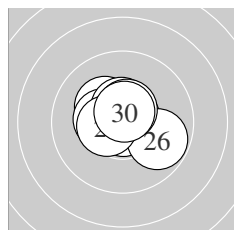

Serie 3:
 10.7 * 10.8 * 10.7 * 10.3 * 10.4 *
 9.8 ↘ 10.5 * 10.5 * 10.6 * 10.6 *
 beste Teiler 29.6 (22.) 51.8 (23.) 59.1 (21.)
 Trefferlage 0.00 mm , 0.29 mm hoch
 Streuwert 0.98, horizontal: 1.16, vertikal: 0.75

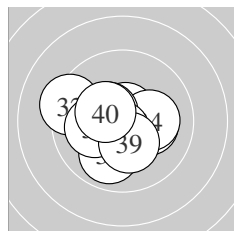

Serie 4:
 10.2 * 9.3 ← 10.7 * 10.2 * 10.4 *
 9.9 ↘ 10.6 * 10.1 ← 10.3 * 10.4 *
 beste Teiler 63.5 (33.) 77.7 (37.) 127.2 (35.)
 Trefferlage 0.49 mm links, 0.22 mm tief
 Streuwert 1.48, horizontal: 1.78, vertikal: 1.12

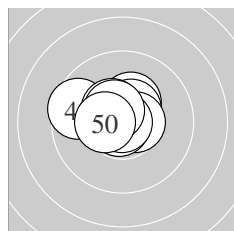

Serie 5:
 10.3 * 9.6 ← 10.7 * 10.5 * 10.6 *
 10.8 * 10.9 * 10.5 * 10.5 * 10.4 *
 beste Teiler 5.0 (47.) 38.9 (46.) 67.1 (43.)
 Trefferlage 0.46 mm links, 0.53 mm hoch
 Streuwert 0.95, horizontal: 1.21, vertikal: 0.58

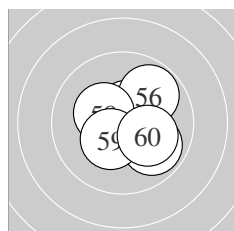

Serie 6:
 10.6 * 10.6 * 10.8 * 10.6 * 10.6 *
 9.8 ↗ 9.9 ↘ 10.3 * 10.4 * 10.1 ↘
 beste Teiler 42.0 (53.) 79.4 (54.) 86.5 (52.)
 Trefferlage 0.67 mm rechts, 0.04 mm tief
 Streuwert 1.13, horizontal: 1.16, vertikal: 1.10

Meyton Elektronik

QF – Schütze hat sich fürs Finale qualifiziert

Unterschrift des Schützen

Meyton Elektronik

Ergebnis:	602.3	(574)
Serien:	99.2	100.9 99.4 99.3 101.4 102.1
Zähler:	36 22 2 0 0 0 0 0 0	
Innenzehner:	31	
weiteste:	713 (7), 637 (34), 499 (30)	
beste Teiler	35.0 (53.) 80.6 (44.) 83.0 (18.)	
Trefferlage	0.03 mm links, 0.08 mm tief	
Streuwert	1.92, horizontal: 2.22, vertikal: 1.57	

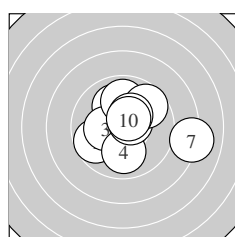
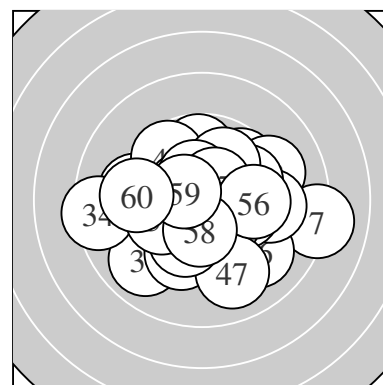

Serie 1:	9.7 ↙	10.0 ↖	10.3 *	10.0 ↓	9.9 ↑
	10.6 *	8.1 →	9.7 ↗	10.4 *	10.5 *
beste Teiler	92.6 (6.)	105.4 (10.)	146.1 (9.)		
Trefferlage	0.64 mm rechts, 0.40 mm hoch				
Streuwert	2.23, horizontal: 2.66, vertikal: 1.71				

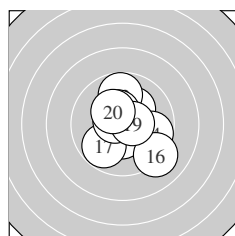

Serie 2:	10.2 *	9.8 ↑	10.4 *	9.7 →	10.4 *
	9.1 ↘	9.8 ↙	10.6 *	10.6 *	10.3 *
beste Teiler	83.0 (18.)	99.1 (19.)	129.1 (15.)		
Trefferlage	0.39 mm rechts, 0.01 mm tief				
Streuwert	1.78, horizontal: 1.69, vertikal: 1.87				

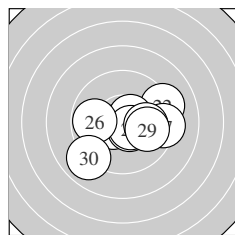

Serie 3:	10.5 *	9.2 →	10.6 *	10.5 *	10.6 *
	9.8 ←	9.3 →	10.0 →	9.9 →	9.0 ↘
beste Teiler	97.6 (23.)	99.2 (25.)	101.8 (24.)		
Trefferlage	0.81 mm rechts, 0.44 mm tief				
Streuwert	2.07, horizontal: 2.61, vertikal: 1.33				

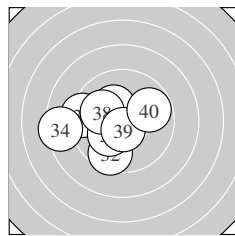

Serie 4:	10.6 *	9.6 ↙	9.3 ←	8.4 ←	10.4 *
	10.3 *	10.2 *	10.1 ↖	10.6 *	9.8 →
beste Teiler	87.1 (39.)	95.4 (31.)	131.9 (35.)		
Trefferlage	1.50 mm links, 0.26 mm tief				
Streuwert	1.97, horizontal: 2.39, vertikal: 1.42				

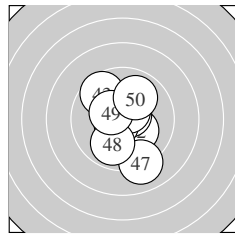

Serie 5:	10.5 *	10.2 *	9.6 ↘	10.6 *	10.6 *
	10.6 *	9.1 ↘	9.9 ↙	10.4 *	9.9 ↗
beste Teiler	80.6 (44.)	89.0 (45.)	98.0 (46.)		
Trefferlage	0.13 mm rechts, 0.10 mm tief				
Streuwert	1.75, horizontal: 1.29, vertikal: 2.12				

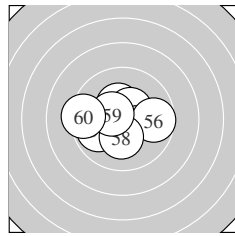

Serie 6:	10.6 *	10.1 ↙	10.8 *	10.4 *	10.5 *
	9.7 →	9.9 ↙	10.2 *	10.5 *	9.4 ←
beste Teiler	35.0 (53.)	86.1 (51.)	120.3 (59.)		
Trefferlage	0.68 mm links, 0.08 mm tief				
Streuwert	1.53, horizontal: 1.92, vertikal: 0.99				

Meyton Elektronik

ISSF AR Women Jun – Wertung – Juniorinnen

StandNr: 130

Krainz, Nadja #62

StartNr: 30

18. Januar 2020 9:22

OOE – LHA Linz

Unterschrift des Schützen

Meyton Elektronik

Ergebnis:	616.9	(588)							
Serien:	101.5	105.0	102.5	103.5	101.9	102.5			
Zähler:	48	12	0	0	0	0	0	0	0
Innenzehner:	41								
weiteste:	383 (27), 380 (47), 362 (56)								
beste Teiler	18.0 (31.)	24.5 (52.)	26.9 (18.)						
Trefferlage	0.10 mm rechts, 0.49 mm hoch								
Streuwert	1.33, horizontal: 1.60, vertikal: 1.00								

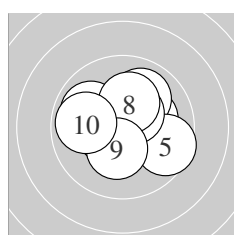
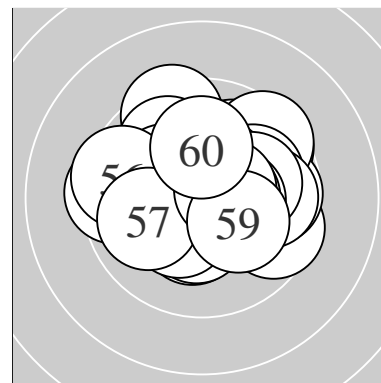

Serie 1:	10.2 *	10.0 ↗	10.5 *	10.5 *	9.6 ↘
	10.4 *	9.9 ↖	10.2 *	10.3 *	9.9 ←
beste Teiler	113.2 (4.)	123.0 (3.)	128.8 (6.)		
Trefferlage	0.04 mm rechts, 0.47 mm hoch				
Streuwert	1.55, horizontal: 1.83, vertikal: 1.22				

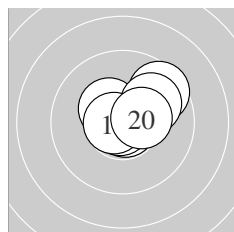

Serie 2:	10.7 *	10.8 *	10.8 *	10.8 *	9.6 ↗
	10.4 *	10.0 ↗	10.8 *	10.7 *	10.4 *
beste Teiler	26.9 (18.)	30.5 (13.)	33.0 (14.)		
Trefferlage	0.48 mm rechts, 0.51 mm hoch				
Streuwert	1.00, horizontal: 1.18, vertikal: 0.78				

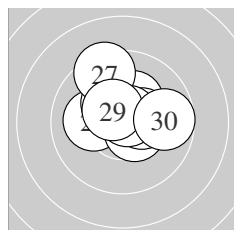

Serie 3:	10.1 ←	10.5 *	10.3 *	10.6 *	10.3 *
	10.4 *	9.4 ↖	10.7 *	10.5 *	9.7 →
beste Teiler	57.6 (28.)	89.0 (24.)	108.8 (22.)		
Trefferlage	0.18 mm rechts, 0.86 mm hoch				
Streuwert	1.33, horizontal: 1.49, vertikal: 1.15				

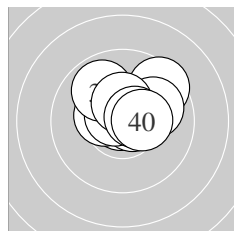

Serie 4:	10.9 *	9.5 ↗	10.4 *	10.7 *	10.7 *
	10.0 ↗	9.9 ↖	10.4 *	10.6 *	10.4 *
beste Teiler	18.0 (31.)	69.2 (35.)	72.0 (34.)		
Trefferlage	0.43 mm rechts, 0.82 mm hoch				
Streuwert	1.18, horizontal: 1.41, vertikal: 0.89				

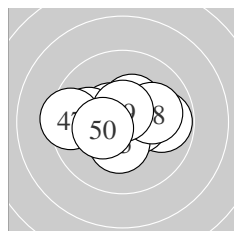

Serie 5:	10.4 *	9.8 →	10.5 *	10.5 *	10.3 *
	10.0 ←	9.4 ←	10.1 →	10.6 *	10.3 *
beste Teiler	81.0 (49.)	107.1 (43.)	108.4 (44.)		
Trefferlage	0.21 mm links, 0.18 mm hoch				
Streuwert	1.54, horizontal: 2.04, vertikal: 0.76				

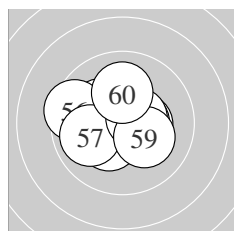

Serie 6:	10.4 *	10.9 *	10.5 *	10.3 *	10.2 *
	9.5 ←	9.9 ←	10.5 *	10.2 *	10.1 ↑
beste Teiler	24.5 (52.)	108.1 (58.)	119.0 (53.)		
Trefferlage	0.33 mm links, 0.09 mm hoch				
Streuwert	1.45, horizontal: 1.74, vertikal: 1.07				

Meyton Elektronik

ISSF AR Women Jun – Wertung – Juniorinnen

StartNr: 31

StandNr: 131

18. Januar 2020 9:41

Tan, Natanya Hui Yi #346

SGP

Unterschrift des Schützen

Meyton Elektronik

Ergebnis: **611.2** (586)
 Serien: 100.7 101.7 102.1 101.2 103.9 101.6
 Zähler: 46 14 0 0 0 0 0 0 0
 Innenzehner: 29
 weiteste: 406 (59), 396 (9), 332 (40)
 beste Teiler 32.0 (13.) 43.2 (46.) 45.6 (50.)
 Trefferlage 0.12 mm rechts, 0.01 mm tief
 Streuwert 1.49, horizontal: 1.71, vertikal: 1.24

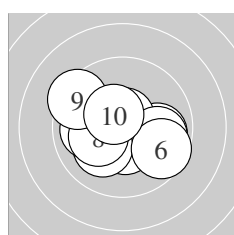
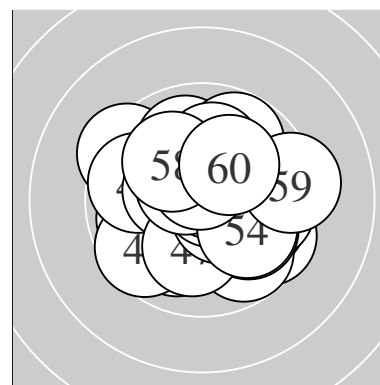

Serie 1:
 9.9 → 10.7 * 10.4 * 9.9 → 10.1 ↙
 9.6 ↘ 10.0 ← 10.2 * 9.4 ↖ 10.5 *
 beste Teiler 71.5 (2.) 116.4 (10.) 131.5 (3.)
 Trefferlage 0.13 mm links, 0.26 mm tief
 Streuwert 1.79, horizontal: 2.24, vertikal: 1.19

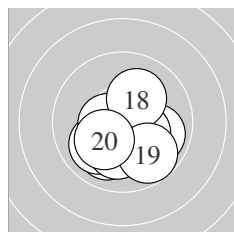

Serie 2:
 10.0 ↙ 10.0 ↘ 10.8 * 9.9 → 10.1 ↓
 10.5 * 10.3 * 10.1 ↗ 9.8 ↘ 10.2 *
 beste Teiler 32.0 (13.) 110.5 (16.) 157.4 (17.)
 Trefferlage 0.10 mm rechts, 0.91 mm tief
 Streuwert 1.38, horizontal: 1.49, vertikal: 1.27

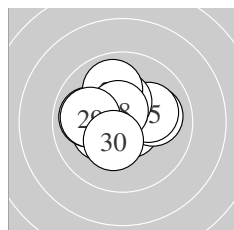

Serie 3:
 10.7 * 10.0 → 10.3 * 9.9 ← 10.1 →
 10.3 * 9.9 ↖ 10.6 * 10.0 ← 10.3 *
 beste Teiler 66.7 (21.) 92.1 (28.) 153.1 (26.)
 Trefferlage 0.36 mm links, 0.42 mm hoch
 Streuwert 1.38, horizontal: 1.62, vertikal: 1.09

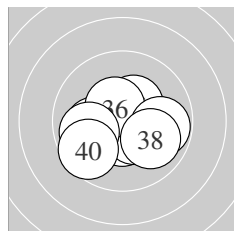

Serie 4:
 10.5 * 10.1 ← 10.4 * 10.0 → 10.4 *
 10.5 * 9.8 → 10.0 ↘ 9.9 ← 9.6 ↙
 beste Teiler 114.0 (31.) 119.9 (36.) 132.5 (33.)
 Trefferlage 0.11 mm rechts, 0.53 mm tief
 Streuwert 1.60, horizontal: 2.01, vertikal: 1.02

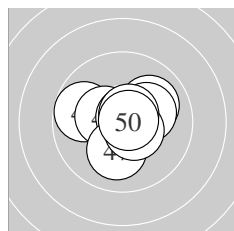

Serie 5:
 9.8 ↖ 10.0 ↗ 10.6 * 10.2 * 10.4 *
 10.8 * 10.1 ↓ 10.5 * 10.7 * 10.8 *
 beste Teiler 43.2 (46.) 45.6 (50.) 74.8 (49.)
 Trefferlage 0.17 mm rechts, 0.10 mm hoch
 Streuwert 1.22, horizontal: 1.44, vertikal: 0.96

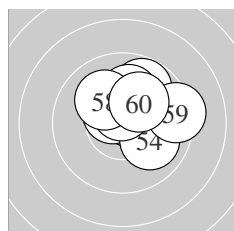

Serie 6:
 10.7 * 10.3 * 10.5 * 10.0 ↘ 9.8 ↗
 10.6 * 10.1 ↗ 10.1 ↘ 9.3 → 10.2 *
 beste Teiler 67.8 (51.) 91.3 (56.) 101.1 (53.)
 Trefferlage 0.83 mm rechts, 1.08 mm hoch
 Streuwert 1.30, horizontal: 1.50, vertikal: 1.06

ISSF AR Women Jun – Wertung – Juniorinnen

StandNr: 132

Wachtler, Manuela #225

StartNr: 32

18. Januar 2020 9:11

T – SG Fügenberg

Unterschrift des Schützen

Meyton Elektronik

Ergebnis:	611.3	(586)							
Serien:	101.4	101.6	101.9	101.9	100.9	103.6			
Zähler:	47	12	1	0	0	0	0	0	0
Innenzehner:	38								
weiteste:	651 (45), 459 (17), 398 (40)								
beste Teiler	12.8 (22.)	21.5 (59.)	27.7 (32.)						
Trefferlage	0.35 mm rechts, 0.24 mm hoch								
Streuwert	1.56, horizontal: 1.70, vertikal: 1.40								

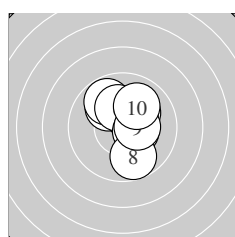
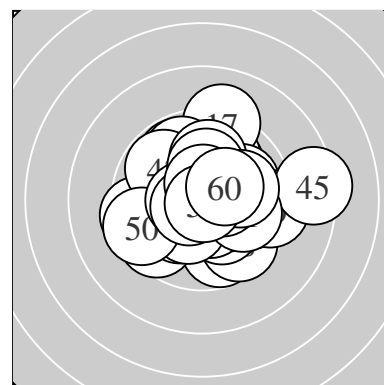

Serie 1:	10.0 ↘	9.8 ↘	10.4 *	10.2 *	10.2 *
	10.2 *	10.4 *	9.8 ↘	10.4 *	10.0 ↗
beste Teiler	129.6 (3.)	133.4 (7.)	142.0 (9.)		
Trefferlage	0.48 mm rechts, 0.90 mm hoch				
Streuwert	1.39, horizontal: 1.16, vertikal: 1.58				

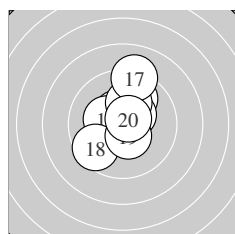

Serie 2:	9.9 ↗	10.5 *	10.5 *	10.3 *	10.4 *
	10.1 ↗	9.1 ↗	9.6 ↙	10.5 *	10.7 *
beste Teiler	75.6 (20.)	109.4 (13.)	118.5 (12.)		
Trefferlage	0.07 mm links, 0.91 mm hoch				
Streuwert	1.60, horizontal: 1.29, vertikal: 1.85				

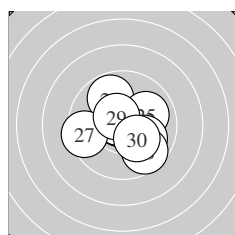

Serie 3:	10.8 *	10.9 *	10.7 *	9.8 ↘	10.0 →
	10.0 ↘	9.4 ←	9.6 ↘	10.5 *	10.2 *
beste Teiler	12.8 (22.)	44.2 (21.)	52.6 (23.)		
Trefferlage	0.14 mm rechts, 0.09 mm tief				
Streuwert	1.66, horizontal: 1.86, vertikal: 1.44				

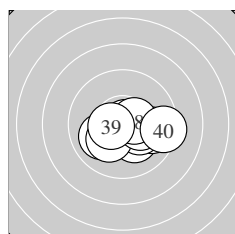

Serie 4:	10.0 ↙	10.8 *	10.2 *	9.8 →	10.2 *
	10.2 *	10.3 *	10.5 *	10.5 *	9.4 →
beste Teiler	27.7 (32.)	112.7 (39.)	115.9 (38.)		
Trefferlage	0.82 mm rechts, 0.60 mm tief				
Streuwert	1.40, horizontal: 1.88, vertikal: 0.62				

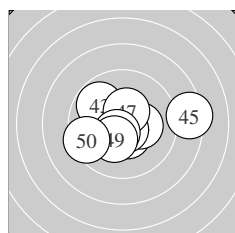

Serie 5:	10.5 *	10.7 *	9.8 ↘	10.3 *	8.3 →
	10.7 *	10.4 *	10.5 *	10.3 *	9.4 ←
beste Teiler	52.2 (42.)	59.9 (46.)	101.7 (48.)		
Trefferlage	0.16 mm rechts, 0.19 mm tief				
Streuwert	2.04, horizontal: 2.65, vertikal: 1.15				

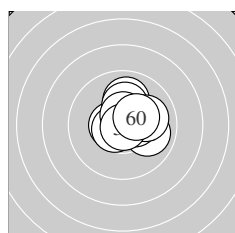

Serie 6:	10.0 →	10.5 *	10.0 ↑	10.5 *	10.6 *
	10.2 *	10.0 →	10.6 *	10.9 *	10.3 *
beste Teiler	21.5 (59.)	84.5 (55.)	96.1 (58.)		
Trefferlage	0.60 mm rechts, 0.54 mm hoch				
Streuwert	1.08, horizontal: 1.15, vertikal: 1.00				

Meyton Elektronik

ISSF AR Women Jun – Wertung – Juniorinnen

StandNr: 101

Barreira, Noelia #357

StartNr: 48

18. Januar 2020 11:37

SUI – Zürich

Unterschrift des Schützen

Meyton Elektronik

Ergebnis: **604.1** (577)
 Serien: 97.3 101.6 100.8 101.1 103.0 100.3
 Zähler: 37 23 0 0 0 0 0 0 0
 Innenzehner: 30
 weiteste: 478 (20), 476 (22), 441 (2)
 beste Teiler 25.6 (50.) 32.5 (44.) 53.0 (33.)
 Trefferlage 0.23 mm rechts, 0.50 mm hoch
 Streuwert 1.73, horizontal: 1.82, vertikal: 1.64

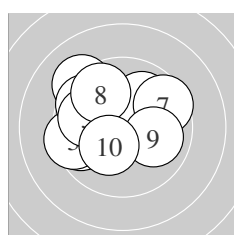
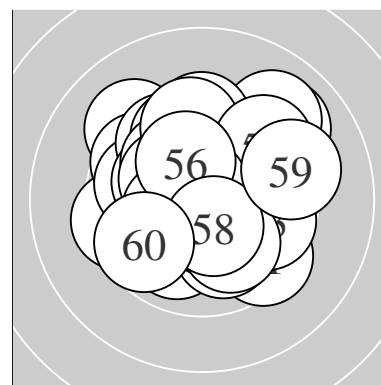

Serie 1:
 9.6 ← 9.2 ↘ 9.4 ← 9.6 ↘ 9.9 ←
 10.0 ↗ 9.6 ↗ 9.7 ↘ 10.0 → 10.3 *
 beste Teiler 170.0 (10.) 240.8 (6.) 242.2 (9.)
 Trefferlage 1.10 mm links, 0.77 mm hoch
 Streuwert 2.11, horizontal: 2.48, vertikal: 1.66

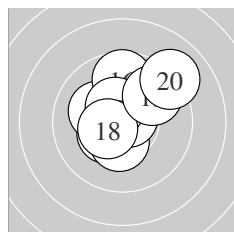

Serie 2:
 10.4 * 10.4 * 10.4 * 10.7 * 10.2 *
 9.7 ↑ 10.5 * 10.5 * 9.8 ↗ 9.0 ↗
 beste Teiler 53.1 (14.) 122.6 (18.) 125.2 (17.)
 Trefferlage 0.04 mm rechts, 0.89 mm hoch
 Streuwert 1.62, horizontal: 1.65, vertikal: 1.59

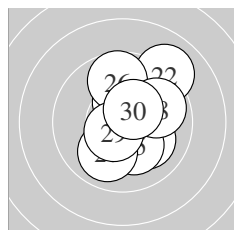

Serie 3:
 10.4 * 9.0 ↗ 10.4 * 10.1 ↘ 10.2 *
 9.7 ↑ 10.0 ↙ 9.9 ↗ 10.6 * 10.5 *
 beste Teiler 96.2 (29.) 124.1 (30.) 140.7 (23.)
 Trefferlage 0.82 mm rechts, 0.47 mm hoch
 Streuwert 1.70, horizontal: 1.40, vertikal: 1.96

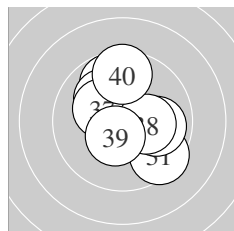

Serie 4:
 9.5 ↘ 10.7 * 10.7 * 9.8 ↑ 10.1 ↘
 9.9 → 10.2 * 10.2 * 10.5 * 9.5 ↑
 beste Teiler 53.0 (33.) 58.4 (32.) 124.7 (39.)
 Trefferlage 0.27 mm rechts, 0.41 mm hoch
 Streuwert 1.71, horizontal: 1.58, vertikal: 1.83

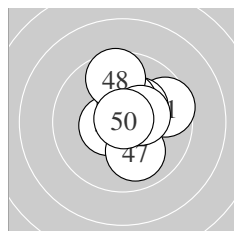

Serie 5:
 9.6 → 10.5 * 10.3 * 10.8 * 10.3 *
 10.6 * 10.0 ↘ 9.6 ↑ 10.4 * 10.9 *
 beste Teiler 25.6 (50.) 32.5 (44.) 88.0 (46.)
 Trefferlage 0.64 mm rechts, 0.61 mm hoch
 Streuwert 1.28, horizontal: 1.16, vertikal: 1.38

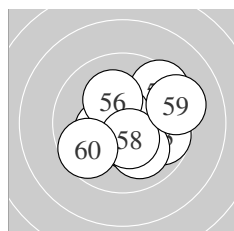

Serie 6:
 9.5 ↗ 10.4 * 9.7 → 10.7 * 10.4 *
 10.2 * 10.0 ↘ 10.4 * 9.3 → 9.7 ←
 beste Teiler 56.3 (54.) 128.9 (58.) 133.1 (52.)
 Trefferlage 0.70 mm rechts, 0.15 mm tief
 Streuwert 1.84, horizontal: 2.07, vertikal: 1.58

ISSF AR Women Jun – Wertung – Juniorinnen

StandNr: 102

Müssigang, Julia #184

StartNr: 49

18. Januar 2020 11:18

T – SG Thaur

Unterschrift des Schützen

Meyton Elektronik

Ergebnis: **607.9** (582)
 Serien: 100.9 100.7 100.9 101.1 101.7 102.6
 Zähler: 44 14 2 0 0 0 0 0 0
 Innenzehner: 36
 weiteste: 593 (14), 504 (26), 488 (46)
 beste Teiler 11.7 (57.) 23.6 (48.) 40.2 (45.)
 Trefferlage 0.07 mm rechts, 1.17 mm hoch
 Streuwert 1.52, horizontal: 1.55, vertikal: 1.49

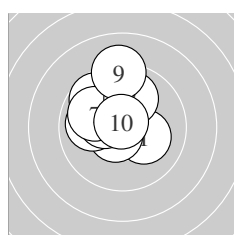
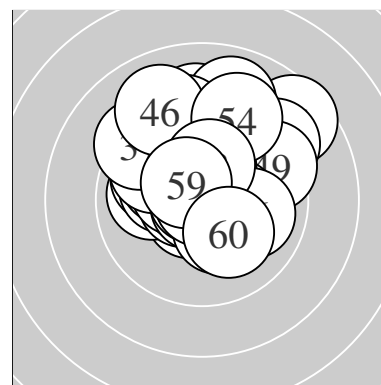

Serie 1:
 10.2 * 10.6 * 10.3 * 9.7 ↘ 10.0 ←
 10.3 * 9.9 ↘ 10.0 ↑ 9.1 ↑ 10.8 *
 beste Teiler 46.5 (10.) 86.3 (2.) 153.0 (6.)
 Trefferlage 0.79 mm links, 1.14 mm hoch
 Streuwert 1.48, horizontal: 1.37, vertikal: 1.58

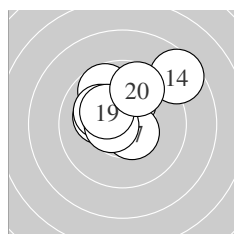

Serie 2:
 10.2 * 10.8 * 10.2 * 8.6 ↗ 9.7 ↘
 10.1 ↘ 10.5 * 10.6 * 10.3 * 9.7 ↑
 beste Teiler 47.8 (12.) 91.4 (18.) 102.8 (17.)
 Trefferlage 0.08 mm links, 1.32 mm hoch
 Streuwert 1.71, horizontal: 1.93, vertikal: 1.47

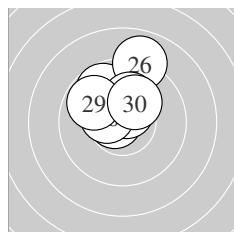

Serie 3:
 10.7 * 10.1 ↘ 10.6 * 10.3 * 9.7 ↘
 8.9 ↑ 10.2 * 10.4 * 9.8 ↘ 10.2 *
 beste Teiler 64.3 (21.) 94.9 (23.) 137.4 (28.)
 Trefferlage 0.35 mm links, 1.74 mm hoch
 Streuwert 1.27, horizontal: 1.24, vertikal: 1.31

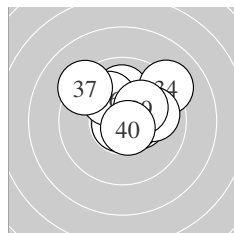

Serie 4:
 10.0 ↑ 10.4 * 10.6 * 9.1 ↗ 10.8 *
 10.1 ↘ 9.3 ↘ 9.9 → 10.2 * 10.7 *
 beste Teiler 40.3 (35.) 70.6 (40.) 86.7 (33.)
 Trefferlage 0.55 mm rechts, 1.04 mm hoch
 Streuwert 1.62, horizontal: 1.88, vertikal: 1.31

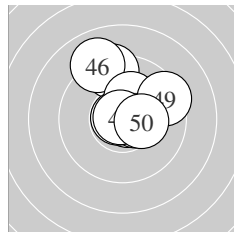

Serie 5:
 10.8 * 10.5 * 9.3 ↑ 10.5 * 10.8 *
 9.0 ↘ 10.2 * 10.9 * 9.4 → 10.3 *
 beste Teiler 23.6 (48.) 40.2 (45.) 41.9 (41.)
 Trefferlage 0.47 mm rechts, 1.19 mm hoch
 Streuwert 1.61, horizontal: 1.50, vertikal: 1.72

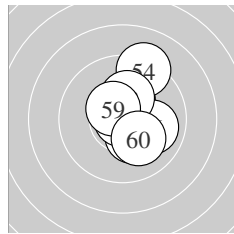

Serie 6:
 10.6 * 10.3 * 10.5 * 9.2 ↑ 10.3 *
 10.0 → 10.9 * 10.2 * 10.5 * 10.1 ↘
 beste Teiler 11.7 (57.) 78.8 (51.) 105.6 (53.)
 Trefferlage 0.63 mm rechts, 0.58 mm hoch
 Streuwert 1.37, horizontal: 0.97, vertikal: 1.67

Meyton Elektronik

ISSF AR Women Jun – Wertung – Juniorinnen

StandNr: 103

Krainz, Anja #300

StartNr: 50

18. Januar 2020 11:38

OÖ – LHA Linz

Unterschrift des Schützen

Meyton Elektronik

Ergebnis:	596.7	(570)							
Serien:	98.9	99.2	100.8	98.2	100.6	99.0			
Zähler:	34	22	4	0	0	0	0	0	0
Innenzehner:	22								
weiteste:	617 (13), 557 (55), 556 (5)								
beste Teiler	26.4 (57.)	52.8 (37.)	81.9 (45.)						
Trefferlage	0.61 mm links, 0.02 mm tief								
Streuwert	1.96, horizontal: 2.22, vertikal: 1.66								

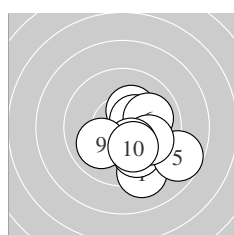
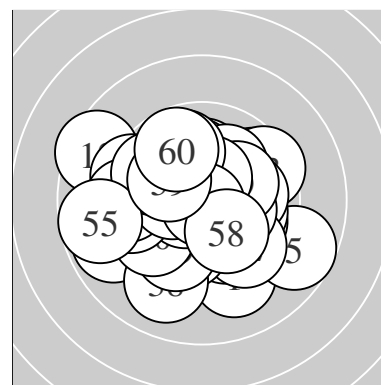

Serie 1:	9.2 ↘	9.9 ↘	10.3 *	10.4 *	8.7 ↘
	10.0 →	9.9 ↘	10.3 *	10.0 ↙	10.2 *
beste Teiler	126.9 (4.)	163.2 (8.)	167.2 (3.)		
Trefferlage	1.42 mm rechts, 1.17 mm tief				
Streuwert	1.71, horizontal: 1.71, vertikal: 1.70				

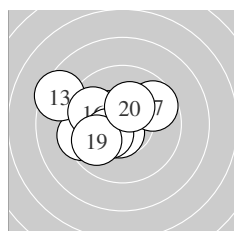

Serie 2:	9.5 ←	10.2 *	8.5 ↖	10.4 *	10.6 *
	9.8 ↖	9.7 →	10.3 *	9.9 ↙	10.3 *
beste Teiler	82.2 (15.)	144.4 (14.)	151.9 (18.)		
Trefferlage	1.56 mm links, 0.31 mm hoch				
Streuwert	1.89, horizontal: 2.30, vertikal: 1.36				

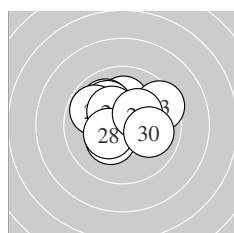

Serie 3:	10.1 ↑	10.0 ↖	9.5 →	10.3 *	10.1 ↖
	9.8 ↖	10.3 *	10.4 *	10.3 *	10.0 →
beste Teiler	146.2 (28.)	155.4 (27.)	165.4 (24.)		
Trefferlage	0.16 mm links, 0.83 mm hoch				
Streuwert	1.59, horizontal: 1.88, vertikal: 1.24				

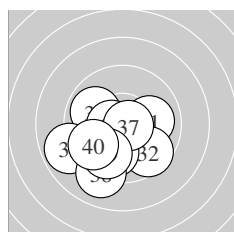

Serie 4:	10.0 →	9.6 ↘	9.9 ↖	9.9 ↓	8.9 ↙
	10.6 *	10.7 *	9.1 ↓	9.8 ↓	9.7 ↙
beste Teiler	52.8 (37.)	99.7 (36.)	239.6 (31.)		
Trefferlage	0.97 mm links, 1.48 mm tief				
Streuwert	1.97, horizontal: 2.22, vertikal: 1.68				

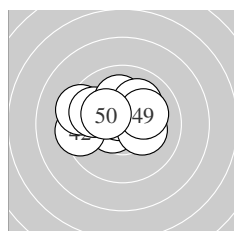

Serie 5:	10.6 *	9.4 ←	9.4 ↖	9.8 ↖	10.6 *
	10.1 ↑	10.1 ↗	10.2 *	10.1 →	10.3 *
beste Teiler	81.9 (45.)	96.2 (41.)	173.2 (50.)		
Trefferlage	0.81 mm links, 0.73 mm hoch				
Streuwert	1.63, horizontal: 2.10, vertikal: 0.95				

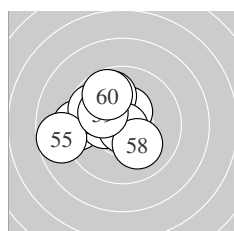

Serie 6:	9.3 ←	10.4 *	10.3 *	9.8 ↖	8.7 ←
	9.8 ↖	10.8 *	10.1 ↘	10.1 ↖	9.7 ↖
beste Teiler	26.4 (57.)	126.5 (52.)	157.6 (53.)		
Trefferlage	1.60 mm links, 0.60 mm hoch				
Streuwert	1.78, horizontal: 2.04, vertikal: 1.46				

Meyton Elektronik

ISSF AR Women Jun – Wertung – Juniorinnen

StartNr: 52

StandNr: 105

18. Januar 2020 11:43

Mautz, Leonie #109

LIE

Unterschrift des Schützen

Meyton Elektronik

Ergebnis: **619.3** (597)
 Serien: 103.7 103.4 103.5 102.8 103.2 102.7
 Zähler: 57 3 0 0 0 0 0 0 0 0
 Innenzehner: 43
 weiteste: 346 (51), 303 (16), 286 (59)
 beste Teiler 12.7 (20.) 51.4 (42.) 58.2 (19.)
 Trefferlage 0.00 mm , 0.06 mm hoch
 Streuwert 1.23, horizontal: 1.46, vertikal: 0.94

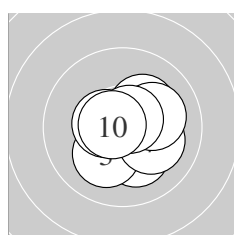
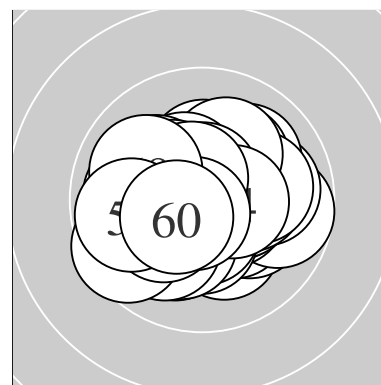

Serie 1:
 10.2 * 10.7 * 10.1 ✓ 10.2 * 10.5 *
 10.4 * 10.1 ↘ 10.1 → 10.7 * 10.7 *
 beste Teiler 64.4 (2.) 68.7 (9.) 70.8 (10.)
 Trefferlage 0.54 mm rechts, 0.07 mm tief
 Streuwert 1.09, horizontal: 1.16, vertikal: 1.02

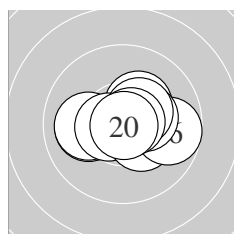

Serie 2:
 10.0 ← 10.3 * 10.0 ← 10.6 * 10.4 *
 9.7 → 10.4 * 10.4 * 10.7 * 10.9 *
 beste Teiler 12.7 (20.) 58.2 (19.) 93.9 (14.)
 Trefferlage 0.30 mm rechts, 0.07 mm hoch
 Streuwert 1.27, horizontal: 1.68, vertikal: 0.62

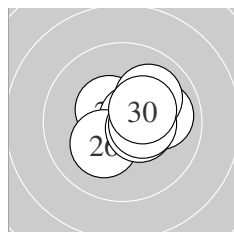

Serie 3:
 10.6 * 10.5 * 10.3 * 10.7 * 10.0 →
 10.2 * 10.5 * 10.0 ↗ 10.4 * 10.3 *
 beste Teiler 74.0 (24.) 77.6 (21.) 118.3 (27.)
 Trefferlage 0.85 mm rechts, 0.30 mm hoch
 Streuwert 1.00, horizontal: 1.15, vertikal: 0.82

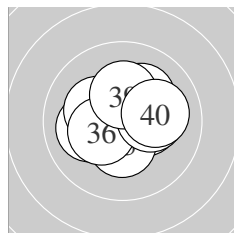

Serie 4:
 10.1 ← 10.2 * 10.4 * 10.6 * 10.4 *
 10.3 * 10.2 * 10.2 * 10.3 * 10.1 →
 beste Teiler 99.4 (34.) 148.0 (35.) 148.1 (33.)
 Trefferlage 0.23 mm rechts, 0.26 mm hoch
 Streuwert 1.29, horizontal: 1.53, vertikal: 0.99

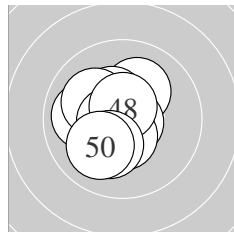

Serie 5:
 10.1 ↗ 10.7 * 10.4 * 10.0 ← 10.1 ↘
 10.5 * 10.6 * 10.6 * 10.2 * 10.0 ✓
 beste Teiler 51.4 (42.) 81.2 (47.) 83.0 (48.)
 Trefferlage 0.66 mm links, 0.03 mm hoch
 Streuwert 1.16, horizontal: 1.07, vertikal: 1.25

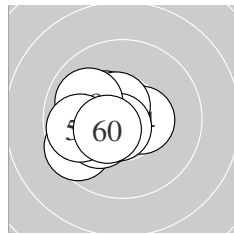

Serie 6:
 9.6 ↙ 10.2 * 10.4 * 10.5 * 10.6 *
 10.4 * 10.7 * 10.0 ↘ 9.8 ← 10.5 *
 beste Teiler 63.8 (57.) 95.7 (55.) 120.2 (54.)
 Trefferlage 1.26 mm links, 0.22 mm tief
 Streuwert 1.10, horizontal: 1.24, vertikal: 0.95

Meyton Elektronik

ISSF AR Women Jun – Wertung – Juniorinnen

StandNr: 106

Kowplos, Katarina #320

StartNr: 53

18. Januar 2020 11:46

AUS

Unterschrift des Schützen

Meyton Elektronik

Ergebnis: **598.5** (573)

Serien: 100.1 100.6 97.8 100.8 98.8 100.4

Zähler: 37 19 4 0 0 0 0 0 0 0

Innenzehner: 29

weiteste: 720 (25), 659 (52), 567 (41)

beste Teiler 27.0 (45.) 36.4 (60.) 40.7 (55.)

Trefferlage 0.30 mm rechts, 0.05 mm hoch

Streuwert 2.05, horizontal: 1.83, vertikal: 2.25

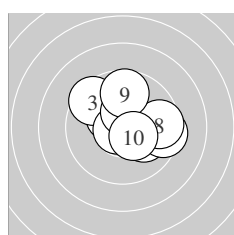
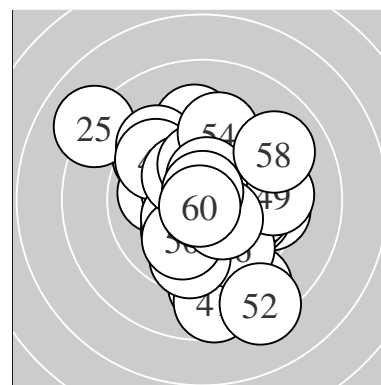

Serie 1:

9.9 ↘	10.4 *	9.5 ↘	10.1 ↘	9.4 →
10.7 *	10.4 *	9.6 →	9.7 ↑	10.4 *

beste Teiler 53.2 (6.) 127.9 (10.) 142.5 (7.)

Trefferlage 0.45 mm rechts, 0.77 mm hoch

Streuwert 1.81, horizontal: 2.11, vertikal: 1.46

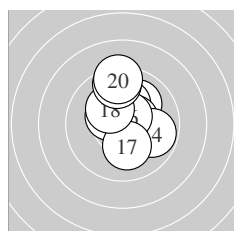

Serie 2:

10.0 ↗	10.2 *	10.5 *	9.8 ↘	10.4 *
10.6 *	10.1 ↓	10.2 *	9.5 ↑	9.3 ↑

beste Teiler 87.3 (16.) 112.9 (13.) 141.8 (15.)

Trefferlage 0.30 mm rechts, 1.20 mm hoch

Streuwert 1.56, horizontal: 1.21, vertikal: 1.85

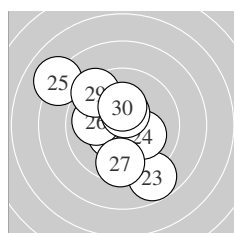

Serie 3:

10.6 *	10.4 *	8.8 ↘	10.1 ↘	8.1 ↘
10.0 ←	9.6 ↓	10.5 *	9.4 ↘	10.3 *

beste Teiler 84.1 (21.) 110.8 (28.) 128.0 (22.)

Trefferlage 0.74 mm links, 0.11 mm hoch

Streuwert 2.58, horizontal: 2.45, vertikal: 2.70

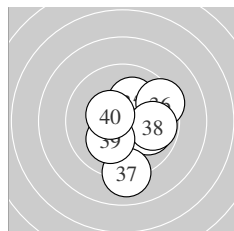

Serie 4:

10.7 *	10.5 *	10.5 *	10.0 ↘	10.2 *
9.4 ↗	9.1 ↓	9.8 →	10.2 *	10.4 *

beste Teiler 68.9 (31.) 112.6 (33.) 117.1 (32.)

Trefferlage 0.90 mm rechts, 0.62 mm tief

Streuwert 1.70, horizontal: 1.54, vertikal: 1.85

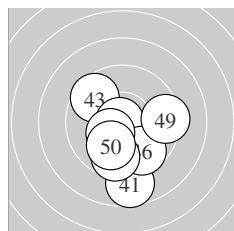

Serie 5:

8.7 ↓	10.1 ↓	9.6 ↘	10.5 *	10.8 *
9.7 ↘	10.3 *	9.7 ↓	9.4 →	10.0 ↙

beste Teiler 27.0 (45.) 117.1 (44.) 151.5 (47.)

Trefferlage 0.14 mm rechts, 1.52 mm tief

Streuwert 1.98, horizontal: 1.79, vertikal: 2.15

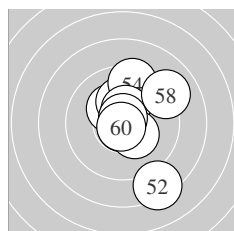

Serie 6:

10.3 *	8.3 ↘	10.2 *	9.4 ↑	10.8 *
10.5 *	10.3 *	9.0 ↗	10.8 *	10.8 *

beste Teiler 36.4 (60.) 40.7 (55.) 46.0 (59.)

Trefferlage 0.80 mm rechts, 0.38 mm hoch

Streuwert 2.16, horizontal: 1.61, vertikal: 2.60

ISSF AR Women Jun – Wertung – Juniorinnen

StandNr: 107

Felderer, Eva #188

StartNr: 54

18. Januar 2020 11:35

T – SG Thaur

Unterschrift des Schützen

Meyton Elektronik

Ergebnis:	615.0	(589)						
Serien:	103.4	103.9	104.0	100.7	102.1	100.9		
Zähler:	50	9	1	0	0	0	0	0
Innenzehner:	40							
weiteste:	548	(31),	487	(51),	389	(42)		
beste Teiler	13.3	(16.)	32.8	(10.)	42.5	(35.)		
Trefferlage	0.22 mm links, 0.66 mm hoch							
Streuwert	1.39, horizontal: 1.47, vertikal: 1.30							

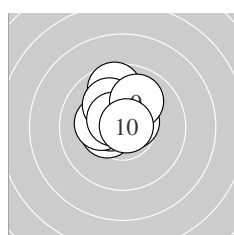
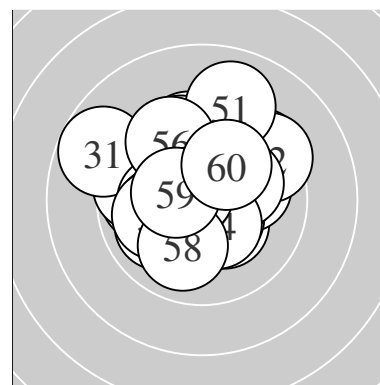

Serie 1:	10.5 *	10.4 *	9.7 ↑	10.5 *	10.2 *
	10.1 ↘	10.6 *	10.6 *	10.0 ↗	10.8 *
beste Teiler	32.8 (10.) 93.5 (7.) 99.8 (8.)				
Trefferlage	0.36 mm links, 0.96 mm hoch				
Streuwert	1.05, horizontal: 1.00, vertikal: 1.09				

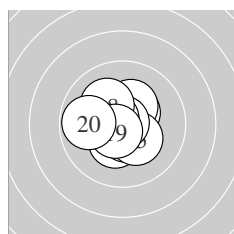

Serie 2:	10.4 *	10.3 *	10.3 *	10.6 *	10.3 *
	10.9 *	10.6 *	10.1 ↘	10.6 *	9.8 ←
beste Teiler	13.3 (16.) 83.4 (19.) 96.7 (14.)				
Trefferlage	0.32 mm links, 0.05 mm hoch				
Streuwert	1.13, horizontal: 1.18, vertikal: 1.07				

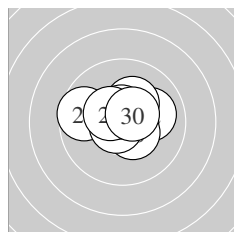

Serie 3:	10.6 *	10.0 →	10.7 *	9.6 ←	10.3 *
	10.5 *	10.7 *	10.6 *	10.5 *	10.5 *
beste Teiler	52.4 (23.) 62.9 (27.) 76.5 (21.)				
Trefferlage	0.02 mm rechts, 0.45 mm hoch				
Streuwert	1.13, horizontal: 1.45, vertikal: 0.69				

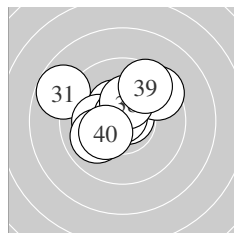

Serie 4:	8.8 ↙	10.4 *	10.8 *	10.2 *	10.8 *
	10.0 ↙	9.5 ↗	10.3 *	9.6 ↗	10.3 *
beste Teiler	42.5 (35.) 49.8 (33.) 136.6 (32.)				
Trefferlage	0.58 mm links, 0.88 mm hoch				
Streuwert	1.86, horizontal: 2.21, vertikal: 1.43				

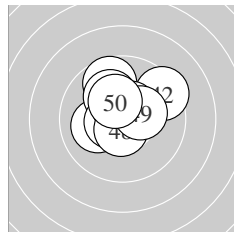

Serie 5:	10.1 ←	9.4 ↗	9.7 ↘	10.1 ↘	10.6 *
	10.5 *	10.5 *	10.6 *	10.3 *	10.3 *
beste Teiler	87.1 (48.) 98.7 (45.) 105.9 (47.)				
Trefferlage	0.07 mm links, 0.91 mm hoch				
Streuwert	1.39, horizontal: 1.53, vertikal: 1.23				

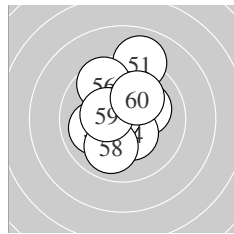

Serie 6:	9.0 ↑	10.5 *	10.2 *	10.4 *	10.0 ←
	9.6 ↘	10.7 *	10.0 ↓	10.4 *	10.1 ↗
beste Teiler	74.7 (57.) 105.8 (52.) 134.8 (59.)				
Trefferlage	0.05 mm links, 0.70 mm hoch				
Streuwert	1.75, horizontal: 1.45, vertikal: 2.01				

Meyton Elektronik

ISSF AR Women Jun – Wertung – Juniorinnen

StartNr: 55

StandNr: 108

18. Januar 2020 11:57

Shamon, Noor Syaakirah #358

SGP

Unterschrift des Schützen

Meyton Elektronik

Ergebnis: **619.9** (592)
 Serien: 102.7 101.9 101.6 105.1 103.8 104.8
 Zähler: 53 6 1 0 0 0 0 0 0
 Innenzehner: 45
 weiteste: 561 (13), 356 (22), 287 (47)
 beste Teiler 24.0 (36.) 30.8 (54.) 33.5 (48.)
 Trefferlage 0.12 mm rechts, 0.22 mm hoch
 Streuwert 1.27, horizontal: 1.44, vertikal: 1.07

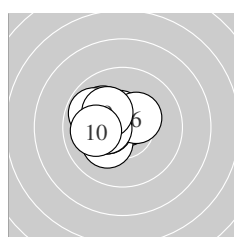
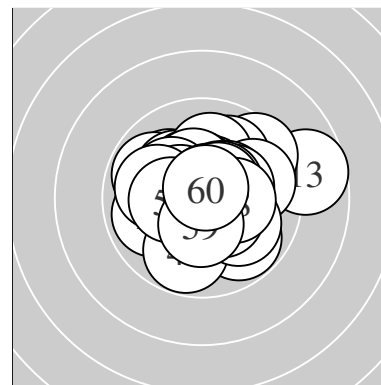

Serie 1:
 10.7 * 10.2 * 10.5 * 10.4 * 10.1 ↖
 10.4 * 10.4 * 9.8 ↖ 10.2 * 10.0 ←
 beste Teiler 73.2 (1.) 101.6 (3.) 136.3 (4.)
 Trefferlage 1.07 mm links, 0.44 mm hoch
 Streuwert 1.04, horizontal: 1.17, vertikal: 0.88

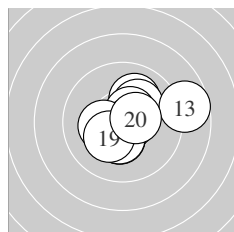

Serie 2:
 10.0 ↗ 10.1 ↗ 8.7 → 10.5 * 10.7 *
 10.4 * 10.3 * 10.4 * 10.3 * 10.5 *
 beste Teiler 52.4 (15.) 109.8 (14.) 119.5 (20.)
 Trefferlage 0.67 mm rechts, 0.15 mm hoch
 Streuwert 1.65, horizontal: 1.95, vertikal: 1.28

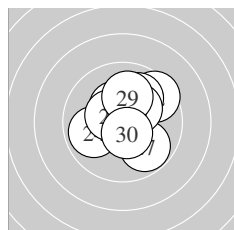

Serie 3:
 10.4 * 9.5 ↗ 10.7 * 9.9 ← 10.0 ↗
 10.5 * 9.8 ↘ 10.3 * 10.0 ↑ 10.5 *
 beste Teiler 63.7 (23.) 103.2 (30.) 122.6 (26.)
 Trefferlage 0.44 mm rechts, 0.59 mm hoch
 Streuwert 1.53, horizontal: 1.55, vertikal: 1.51

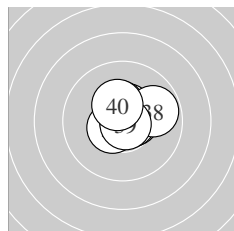

Serie 4:
 10.5 * 10.5 * 10.6 * 10.5 * 10.4 *
 10.9 * 10.7 * 9.8 → 10.8 * 10.4 *
 beste Teiler 24.0 (36.) 37.4 (39.) 67.3 (37.)
 Trefferlage 0.46 mm rechts, 0.41 mm hoch
 Streuwert 0.86, horizontal: 0.99, vertikal: 0.70

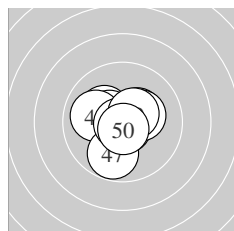

Serie 5:
 10.7 * 10.4 * 10.2 * 10.3 * 10.4 *
 10.0 ← 9.8 ↓ 10.8 * 10.5 * 10.7 *
 beste Teiler 33.5 (48.) 54.2 (41.) 61.2 (50.)
 Trefferlage 0.21 mm links, 0.01 mm hoch
 Streuwert 1.20, horizontal: 1.28, vertikal: 1.11

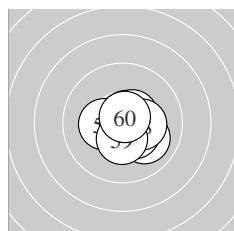

Serie 6:
 10.7 * 10.0 ↘ 10.3 * 10.8 * 10.5 *
 10.4 * 10.7 * 10.3 * 10.4 * 10.7 *
 beste Teiler 30.8 (54.) 56.3 (60.) 59.0 (57.)
 Trefferlage 0.48 mm rechts, 0.27 mm tief
 Streuwert 0.88, horizontal: 0.98, vertikal: 0.76

Meyton Elektronik

ISSF AR Women Jun – Wertung – Juniorinnen

StandNr: 109

Hitz, Sarina #359

StartNr: 56

18. Januar 2020 11:33

SUI

Unterschrift des Schützen

Meyton Elektronik

Ergebnis:	621.6	(593)
Serien:	102.8	105.5 104.4 102.0 102.6 104.3
Zähler:	53	7 0 0 0 0 0 0 0 0
Innenzehner:	51	
weiteste:	463	(43), 431 (31), 381 (48)
beste Teiler	13.0	(20.) 15.2 (13.) 31.1 (1.)
Trefferlage	0.01 mm links, 0.15 mm hoch	
Streuwert	1.26, horizontal: 1.35, vertikal: 1.15	

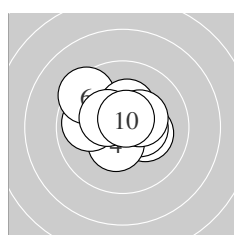
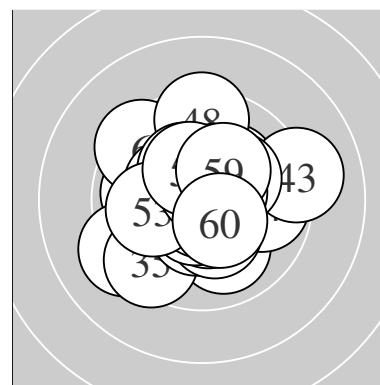

Serie 1:	10.8 *	10.2 *	10.4 *	10.4 *	9.9 ←
	9.4 ↘	10.3 *	10.4 *	10.3 *	10.7 *
beste Teiler	31.1 (1.) 72.2 (10.) 136.2 (3.)				
Trefferlage	0.20 mm links, 0.49 mm hoch				
Streuwert	1.35, horizontal: 1.61, vertikal: 1.04				

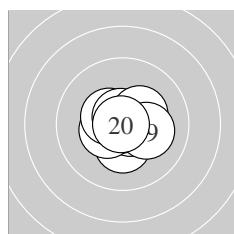

Serie 2:	10.3 *	10.7 *	10.9 *	10.4 *	10.6 *
	10.5 *	10.7 *	10.3 *	10.2 *	10.9 *
beste Teiler	13.0 (20.) 15.2 (13.) 60.4 (17.)				
Trefferlage	0.18 mm rechts, 0.04 mm tief				
Streuwert	0.86, horizontal: 0.98, vertikal: 0.73				

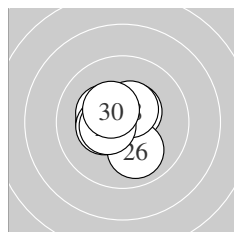

Serie 3:	10.4 *	10.7 *	10.3 *	10.5 *	10.7 *
	10.0 ↓	10.4 *	10.5 *	10.5 *	10.4 *
beste Teiler	53.7 (25.) 65.0 (22.) 116.9 (28.)				
Trefferlage	0.47 mm links, 0.02 mm tief				
Streuwert	0.99, horizontal: 1.00, vertikal: 0.98				

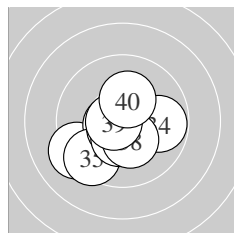

Serie 4:	9.2 ↙	10.6 *	10.6 *	9.8 →	9.5 ↘
	10.6 *	10.4 *	10.3 *	10.7 *	10.3 *
beste Teiler	69.2 (39.) 76.0 (33.) 84.8 (36.)				
Trefferlage	0.51 mm links, 0.81 mm tief				
Streuwert	1.53, horizontal: 1.73, vertikal: 1.29				

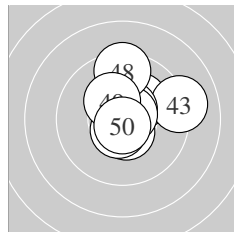

Serie 5:	10.2 *	10.5 *	9.1 →	10.6 *	10.5 *
	10.6 *	10.7 *	9.4 ↑	10.3 *	10.7 *
beste Teiler	51.0 (50.) 62.4 (47.) 91.7 (46.)				
Trefferlage	0.56 mm rechts, 0.76 mm hoch				
Streuwert	1.45, horizontal: 1.49, vertikal: 1.41				

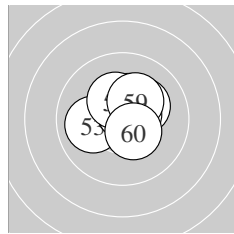

Serie 6:	10.8 *	10.4 *	10.0 ←	10.2 *	10.6 *
	10.6 *	10.7 *	10.3 *	10.3 *	10.4 *
beste Teiler	39.3 (51.) 62.6 (57.) 84.5 (55.)				
Trefferlage	0.31 mm rechts, 0.52 mm hoch				
Streuwert	0.96, horizontal: 1.08, vertikal: 0.82				

Meyton Elektronik

ISSF AR Women Jun – Wertung – Juniorinnen

StartNr: 57

StandNr: 110

18. Januar 2020 11:47

Arolfo, Angela #324

ARG

Unterschrift des Schützen

Meyton Elektronik

Ergebnis: **598.6** (572)

Serien: 100.5 100.7 100.3 98.9 100.4 97.8

Zähler: 35 22 3 0 0 0 0 0 0 0

Innenzehner: 28

weiteste: 609 (53), 522 (60), 501 (18)

beste Teiler 51.3 (24.) 58.6 (7.) 60.1 (25.)

Trefferlage 0.28 mm links, 0.06 mm tief

Streuwert 1.97, horizontal: 2.28, vertikal: 1.59

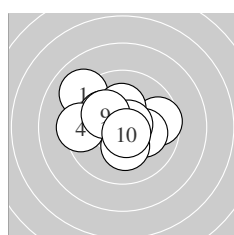
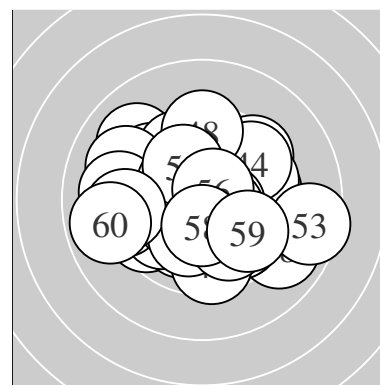

Serie 1:

9.1 ↘	9.6 →	10.1 ↘	9.4 ←	10.2 *
10.2 *	10.7 *	10.3 *	10.2 *	10.7 *

beste Teiler 58.6 (7.) 64.6 (10.) 175.6 (8.)

Trefferlage 0.46 mm links, 0.51 mm hoch

Streuwert 1.87, horizontal: 2.26, vertikal: 1.37

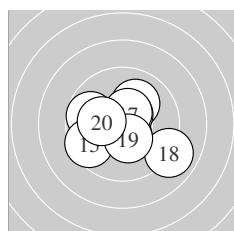

Serie 2:

10.5 *	10.4 *	10.1 ↗	9.7 ↖	9.5 ↖
10.5 *	10.5 *	8.9 ↘	10.4 *	10.2 *

beste Teiler 102.0 (16.) 112.4 (11.) 114.1 (17.)

Trefferlage 0.17 mm links, 0.24 mm tief

Streuwert 1.86, horizontal: 2.20, vertikal: 1.44

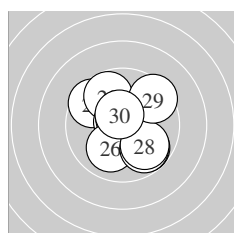

Serie 3:

9.6 ↘	9.8 ↘	9.8 ↘	10.7 *	10.7 *
10.0 ↙	9.8 ↘	9.9 ↘	9.5 ↗	10.5 *

beste Teiler 51.3 (24.) 60.1 (25.) 102.2 (30.)

Trefferlage 0.27 mm rechts, 0.07 mm hoch

Streuwert 1.91, horizontal: 1.84, vertikal: 1.97

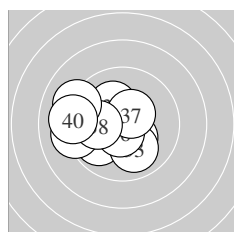

Serie 4:

9.9 ↙	10.3 *	10.0 ↘	9.2 ←	10.2 *
10.6 *	10.5 *	10.0 ←	9.1 ↖	9.1 ←

beste Teiler 81.3 (36.) 122.1 (37.) 160.0 (32.)

Trefferlage 1.59 mm links, 0.18 mm tief

Streuwert 1.87, horizontal: 2.26, vertikal: 1.39

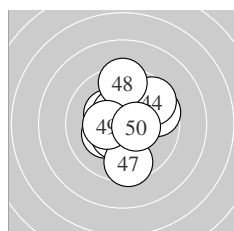

Serie 5:

9.6 →	10.3 *	10.5 *	9.6 ↗	10.2 *
10.5 *	9.5 ↓	9.4 ↑	10.4 *	10.4 *

beste Teiler 116.7 (43.) 121.7 (46.) 126.3 (50.)

Trefferlage 0.20 mm rechts, 0.32 mm hoch

Streuwert 1.83, horizontal: 1.68, vertikal: 1.98

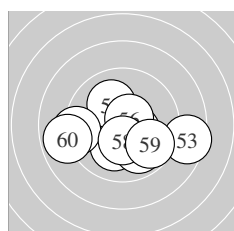

Serie 6:

10.1 ↙	10.1 ↘	8.5 →	10.4 *	9.9 ↘
10.6 *	9.2 ←	10.4 *	9.7 ↘	8.9 ←

beste Teiler 84.1 (56.) 126.4 (54.) 142.0 (58.)

Trefferlage 0.05 mm rechts, 0.84 mm tief

Streuwert 2.42, horizontal: 3.18, vertikal: 1.27

Meyton Elektronik

ISSF AR Women Jun – Wertung – Juniorinnen

StartNr: 58

StandNr: 111

18. Januar 2020 11:30

Schrödl, Julia #360

T – Ebbser Sportschützen

Unterschrift des Schützen

Meyton Elektronik

Ergebnis:	604.8	(579)							
Serien:	101.3	101.1	100.0	101.5	100.7	100.2			
Zähler:	40	19	1	0	0	0	0	0	0
Innenzehner:	28								
weiteste:	579 (52), 471 (12), 465 (34)								
beste Teiler	35.3 (30.)	40.3 (48.)	42.5 (39.)						
Trefferlage	0.13 mm rechts, 0.77 mm hoch								
Streuwert	1.70, horizontal: 1.59, vertikal: 1.80								

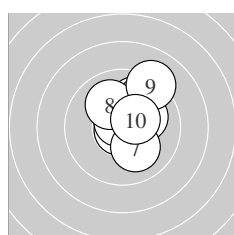
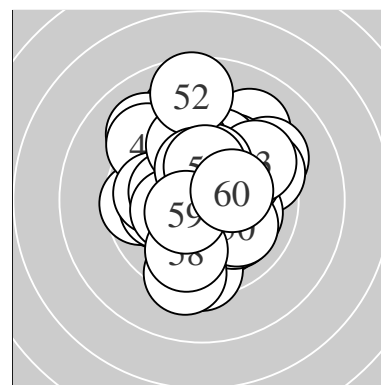

Serie 1:	10.8 *	9.9 ↗	10.4 *	10.7 *	9.8 ↗
	10.1 ↗	10.1 ↘	10.0 ↘	9.1 ↗	10.4 *
beste Teiler	43.9 (1.)	59.4 (4.)	136.0 (10.)		
Trefferlage	0.78 mm rechts, 1.19 mm hoch				
Streuwert	1.37, horizontal: 1.16, vertikal: 1.56				

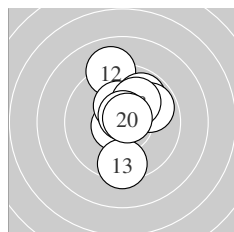

Serie 2:	10.7 *	9.1 ↑	9.4 ↓	10.5 *	10.3 *
	9.8 ↗	9.8 ↗	10.1 ↗	10.7 *	10.7 *
beste Teiler	56.7 (20.)	60.0 (19.)	69.8 (11.)		
Trefferlage	0.39 mm rechts, 0.94 mm hoch				
Streuwert	1.69, horizontal: 1.08, vertikal: 2.12				

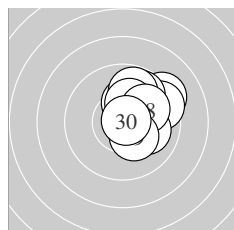

Serie 3:	10.2 *	9.3 ↗	9.5 ↗	9.8 ↗	9.8 ↗
	10.2 *	10.1 ↘	10.0 ↗	10.3 *	10.8 *
beste Teiler	35.3 (30.)	162.7 (29.)	178.8 (21.)		
Trefferlage	1.59 mm rechts, 1.17 mm hoch				
Streuwert	1.26, horizontal: 1.17, vertikal: 1.35				

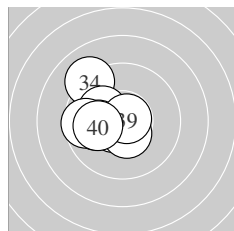

Serie 4:	10.0 ←	10.7 *	10.6 *	9.1 ↘	10.1 ↘
	10.1 ←	10.5 *	9.6 ←	10.8 *	10.0 ←
beste Teiler	42.5 (39.)	53.0 (32.)	100.8 (33.)		
Trefferlage	1.54 mm links, 0.13 mm hoch				
Streuwert	1.33, horizontal: 1.34, vertikal: 1.32				

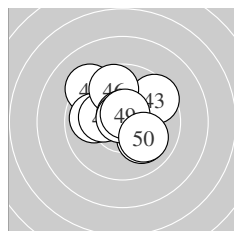

Serie 5:	10.0 ↘	9.3 ↘	9.5 ↗	9.9 ←	10.2 *
	9.7 ↑	10.7 *	10.8 *	10.6 *	10.0 ↘
beste Teiler	40.3 (48.)	61.3 (47.)	76.2 (49.)		
Trefferlage	0.16 mm links, 0.76 mm hoch				
Streuwert	1.75, horizontal: 1.94, vertikal: 1.55				

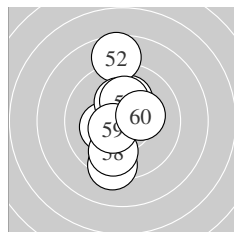

Serie 6:	10.2 *	8.6 ↑	10.3 *	9.3 ↓	10.3 *
	10.7 *	10.2 *	9.8 ↓	10.5 *	10.3 *
beste Teiler	73.7 (56.)	110.6 (59.)	169.5 (60.)		
Trefferlage	0.24 mm links, 0.42 mm hoch				
Streuwert	2.03, horizontal: 0.95, vertikal: 2.71				

Meyton Elektronik

ISSF AR Women Jun – Wertung – Juniorinnen

StartNr: 59

StandNr: 112

18. Januar 2020 11:19

Hillinger, Christina #298

OÖ – SG Vorchdorf 1879

Unterschrift des Schützen

Meyton Elektronik

Ergebnis: **608.8** (580)

Serien: 100.6 103.3 100.3 101.5 102.8 100.3

Zähler: 41 18 1 0 0 0 0 0 0 0

Innenzehner: 32

weiteste: 566 (56), 495 (1), 452 (5)

beste Teiler 38.6 (20.) 42.6 (29.) 48.0 (26.)

Trefferlage 0.09 mm rechts, 0.33 mm hoch

Streuwert 1.65, horizontal: 1.83, vertikal: 1.46

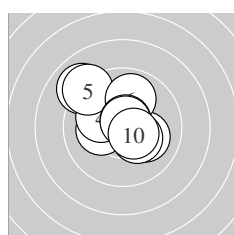
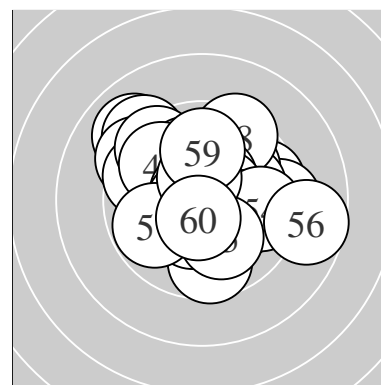

Serie 1:

9.0 ↘	10.2 *	10.1 →	10.1 ↖	9.1 ↘
9.9 ↑	10.3 *	10.7 *	10.7 *	10.5 *

beste Teiler 57.2 (9.) 66.3 (8.) 112.5 (10.)

Trefferlage 0.50 mm links, 0.86 mm hoch

Streuwert 1.81, horizontal: 1.95, vertikal: 1.66

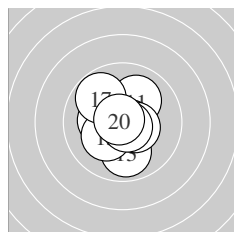

Serie 2:

10.1 ↗	10.4 *	9.9 ↓	10.2 *	10.2 *
10.7 *	9.8 ↘	10.5 *	10.7 *	10.8 *

beste Teiler 38.6 (20.) 56.5 (19.) 67.2 (16.)

Trefferlage 0.31 mm links, 0.01 mm hoch

Streuwert 1.30, horizontal: 1.20, vertikal: 1.39

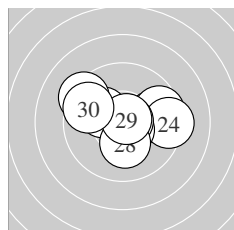

Serie 3:

9.9 →	10.2 *	9.6 →	9.3 →	10.6 *
10.8 *	9.3 ↘	10.2 *	10.8 *	9.6 ↖

beste Teiler 42.6 (29.) 48.0 (26.) 87.9 (25.)

Trefferlage 0.32 mm rechts, 0.35 mm hoch

Streuwert 1.95, horizontal: 2.53, vertikal: 1.10

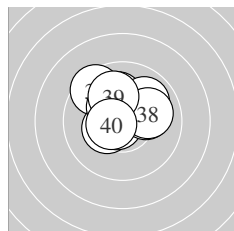

Serie 4:

9.5 ↘	10.4 *	10.1 ↑	10.7 *	10.3 *
9.9 ↗	10.1 →	10.0 →	10.0 ↑	10.5 *

beste Teiler 57.8 (34.) 103.5 (40.) 150.7 (32.)

Trefferlage 0.12 mm links, 1.00 mm hoch

Streuwert 1.41, horizontal: 1.61, vertikal: 1.17

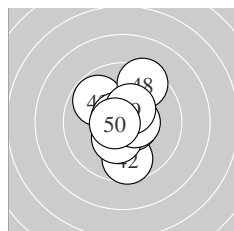

Serie 5:

10.7 *	9.6 ↓	9.8 ↘	10.6 *	10.4 *
10.5 *	10.7 *	9.4 ↑	10.4 *	10.7 *

beste Teiler 52.9 (41.) 65.4 (47.) 70.0 (50.)

Trefferlage 0.09 mm rechts, 0.11 mm hoch

Streuwert 1.50, horizontal: 1.12, vertikal: 1.81

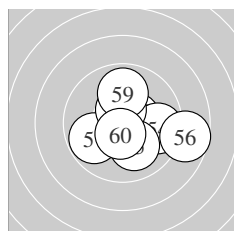

Serie 6:

10.5 *	10.4 *	10.1 →	9.7 →	10.1 ↓
8.7 →	9.8 ↖	10.5 *	9.9 ↑	10.6 *

beste Teiler 98.0 (60.) 115.1 (51.) 118.9 (58.)

Trefferlage 1.05 mm rechts, 0.37 mm tief

Streuwert 1.82, horizontal: 2.17, vertikal: 1.40

ISSF AR Women Jun – Wertung – Juniorinnen

StandNr: 113

Nagl, Selina #185

StartNr: 60

18. Januar 2020 11:29

T – SG Thaur

Unterschrift des Schützen

Meyton Elektronik

Ergebnis: **602.4** (575)

Serien: 98.6 101.1 100.8 99.9 100.7 101.3

Zähler: 39 18 2 1 0 0 0 0 0 0

Innenzehner: 31

weiteste: 868 (8), 564 (38), 554 (6)

beste Teiler 50.2 (20.) 58.5 (56.) 58.8 (1.)

Trefferlage 0.29 mm links, 0.32 mm hoch

Streuwert 1.91, horizontal: 2.29, vertikal: 1.44

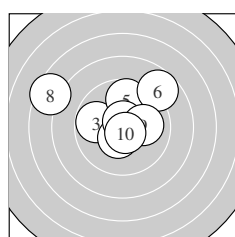
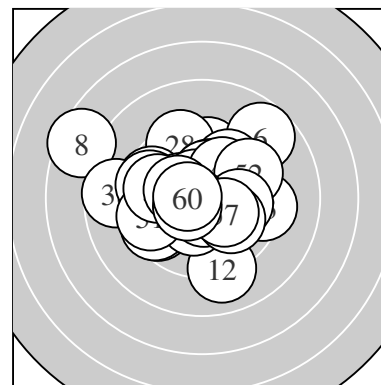

Serie 1:

10.7 *	10.3 *	9.8 ←	10.5 *	9.7 ↑
8.7 ↗	10.7 *	7.5 ↖	10.0 →	10.7 *

beste Teiler 58.8 (1.) 63.1 (7.) 69.3 (10.)

Trefferlage 0.38 mm links, 1.12 mm hoch

Streuwert 2.59, horizontal: 3.17, vertikal: 1.84

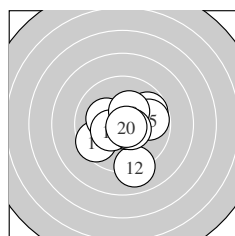

Serie 2:

9.8 ↗	9.0 ↓	10.7 *	9.6 ↙	9.8 →
10.2 *	10.4 *	10.3 *	10.5 *	10.8 *

beste Teiler 50.2 (20.) 63.2 (13.) 103.2 (19.)

Trefferlage 0.32 mm rechts, 0.47 mm tief

Streuwert 1.81, horizontal: 1.85, vertikal: 1.76

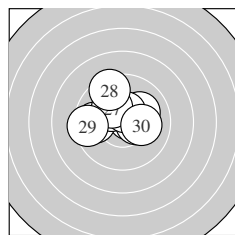

Serie 3:

10.7 *	9.7 ←	10.1 ↗	10.3 *	10.4 *
10.5 *	10.2 *	9.4 ↘	9.4 ←	10.1 →

beste Teiler 73.9 (21.) 112.0 (26.) 149.6 (25.)

Trefferlage 0.42 mm links, 0.77 mm hoch

Streuwert 1.67, horizontal: 2.03, vertikal: 1.21

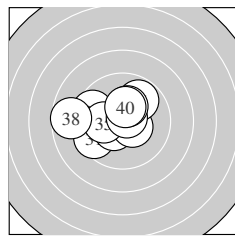

Serie 4:

9.5 ↙	10.4 *	10.5 *	9.6 ↖	10.1 ←
9.8 ↗	10.7 *	8.7 ←	10.3 *	10.3 *

beste Teiler 60.9 (37.) 123.6 (33.) 135.7 (32.)

Trefferlage 1.09 mm links, 0.36 mm hoch

Streuwert 1.90, horizontal: 2.36, vertikal: 1.29

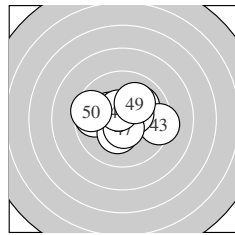

Serie 5:

10.0 ↗	10.3 *	9.3 →	9.7 ←	10.3 *
10.4 *	10.6 *	10.5 *	10.1 ↗	9.5 ←

beste Teiler 96.7 (47.) 103.3 (48.) 130.1 (46.)

Trefferlage 0.04 mm links, 0.33 mm hoch

Streuwert 1.76, horizontal: 2.26, vertikal: 1.05

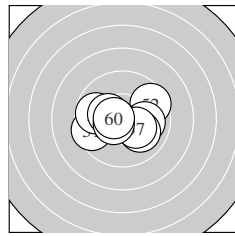

Serie 6:

9.5 ←	9.6 ↗	10.0 →	10.0 ↘	9.8 ←
10.7 *	10.3 *	10.3 *	10.5 *	10.6 *

beste Teiler 58.5 (56.) 96.4 (60.) 111.5 (59.)

Trefferlage 0.14 mm links, 0.18 mm tief

Streuwert 1.71, horizontal: 2.24, vertikal: 0.93

ISSF AR Women Jun – Wertung – Juniorinnen

StandNr: 114

Vanoni, Lorena #110

StartNr: 61

18. Januar 2020 11:32

LIE

Unterschrift des Schützen

Meyton Elektronik

Ergebnis: **616.8** (590)
 Serien: 103.9 102.6 102.5 101.6 102.6 103.6
 Zähler: 50 10 0 0 0 0 0 0 0
 Innenzehner: 41
 weiteste: 377 (26), 328 (36), 315 (43)
 beste Teiler 44.9 (30.) 45.9 (53.) 48.0 (8.)
 Trefferlage 0.67 mm links, 0.17 mm hoch
 Streuwert 1.24, horizontal: 1.37, vertikal: 1.10

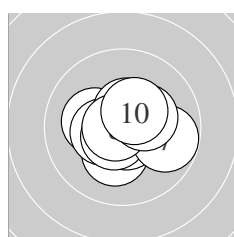
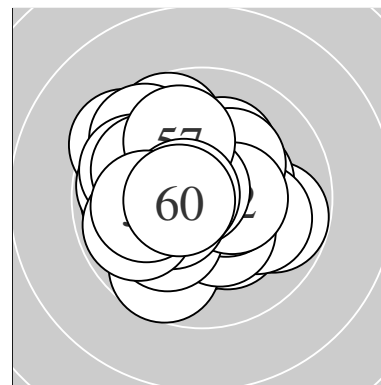

Serie 1:
 10.2 * 10.2 * 10.7 * 10.4 * 10.6 *
 10.5 * 9.8 ↗ 10.8 * 10.3 * 10.4 *
 beste Teiler 48.0 (8.) 67.2 (3.) 84.2 (5.)
 Trefferlage 0.09 mm rechts, 0.08 mm tief
 Streuwert 1.15, horizontal: 1.37, vertikal: 0.89

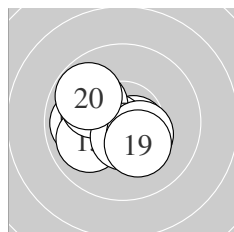

Serie 2:
 10.6 * 9.9 ← 10.2 * 10.7 * 10.0 ↙
 10.1 ↘ 10.6 * 10.4 * 10.3 * 9.8 ↘
 beste Teiler 69.3 (14.) 86.8 (11.) 98.3 (17.)
 Trefferlage 0.85 mm links, 0.19 mm tief
 Streuwert 1.28, horizontal: 1.50, vertikal: 1.02

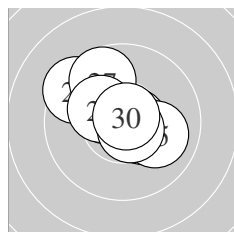

Serie 3:
 10.7 * 10.1 ↘ 10.4 * 10.4 * 10.0 →
 9.4 ↘ 9.7 ↘ 10.3 * 10.7 * 10.8 *
 beste Teiler 44.9 (30.) 72.1 (21.) 72.2 (29.)
 Trefferlage 0.36 mm links, 0.65 mm hoch
 Streuwert 1.43, horizontal: 1.63, vertikal: 1.20

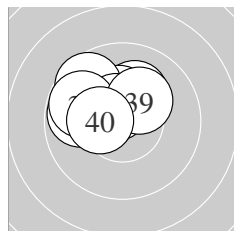

Serie 4:
 9.8 ← 10.4 * 10.2 * 10.4 * 10.4 *
 9.6 ↘ 10.5 * 9.8 ↘ 10.2 * 10.3 *
 beste Teiler 103.3 (37.) 134.4 (32.) 137.4 (35.)
 Trefferlage 0.99 mm links, 1.11 mm hoch
 Streuwert 1.10, horizontal: 1.38, vertikal: 0.71

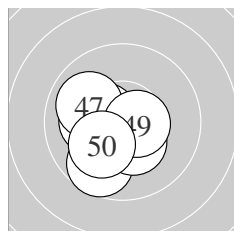

Serie 5:
 10.2 * 10.5 * 9.7 ↘ 10.6 * 10.4 *
 10.1 ← 10.0 ↘ 10.4 * 10.6 * 10.1 ↙
 beste Teiler 96.7 (49.) 100.9 (44.) 109.5 (42.)
 Trefferlage 0.90 mm links, 0.54 mm tief
 Streuwert 1.15, horizontal: 1.18, vertikal: 1.12

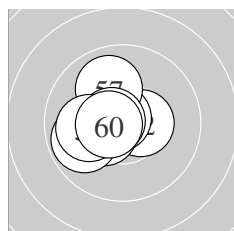

Serie 6:
 10.4 * 10.5 * 10.8 * 10.4 * 10.4 *
 9.8 ↙ 10.0 ↘ 10.7 * 10.0 ← 10.6 *
 beste Teiler 45.9 (53.) 74.1 (58.) 92.5 (60.)
 Trefferlage 1.03 mm links, 0.07 mm hoch
 Streuwert 0.96, horizontal: 1.03, vertikal: 0.89

Meyton Elektronik

ISSF AR Women Jun – Wertung – Juniorinnen

StandNr: 115

Rossiter, Victoria #304

StartNr: 62

18. Januar 2020 11:50

AUS

Unterschrift des Schützen

Meyton Elektronik

Ergebnis:	620.4	(594)						
Serien:	101.9	104.3	104.4	102.5	104.8	102.5		
Zähler:	54	6	0	0	0	0	0	0
Innenzehner:	47							
weiteste:	367 (5), 346 (51), 324 (1)							
beste Teiler	31.7 (20.)	42.2 (46.)	53.5 (11.)					
Trefferlage	0.70 mm rechts, 0.30 mm hoch							
Streuwert	1.09, horizontal: 1.03, vertikal: 1.15							

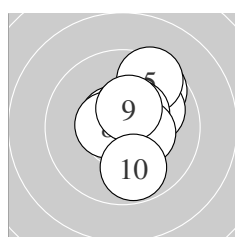
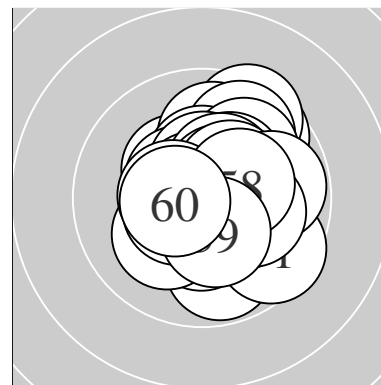

Serie 1:	9.7 ↗	10.6 *	10.0 ↗	10.5 *	9.5 ↗
	10.4 *	10.4 *	10.6 *	10.4 *	9.8 ↓
beste Teiler	83.8 (2.)	100.1 (8.)	111.8 (4.)		
Trefferlage	0.80 mm rechts, 0.77 mm hoch				
Streuwert	1.36, horizontal: 1.07, vertikal: 1.60				

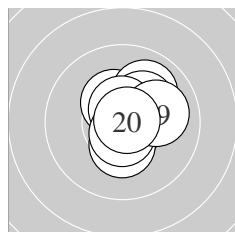

Serie 2:	10.7 *	10.4 *	10.7 *	10.3 *	10.0 ↗
	10.2 *	10.6 *	10.6 *	10.0 →	10.8 *
beste Teiler	31.7 (20.)	53.5 (11.)	59.4 (13.)		
Trefferlage	0.53 mm rechts, 0.29 mm hoch				
Streuwert	0.99, horizontal: 0.88, vertikal: 1.09				

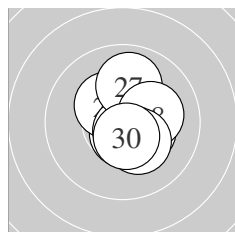

Serie 3:	10.7 *	10.6 *	10.6 *	10.4 *	10.3 *
	10.7 *	10.0 ↑	10.2 *	10.3 *	10.6 *
beste Teiler	62.9 (26.)	72.7 (21.)	77.0 (23.)		
Trefferlage	0.53 mm rechts, 0.10 mm hoch				
Streuwert	1.00, horizontal: 0.80, vertikal: 1.16				

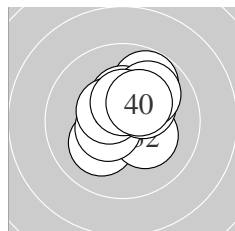

Serie 4:	10.1 ↘	10.2 *	9.8 ↗	10.5 *	10.4 *
	10.5 *	10.3 *	10.0 ↗	10.4 *	10.3 *
beste Teiler	109.1 (34.)	113.4 (36.)	126.0 (39.)		
Trefferlage	0.40 mm rechts, 0.71 mm hoch				
Streuwert	1.24, horizontal: 1.20, vertikal: 1.28				

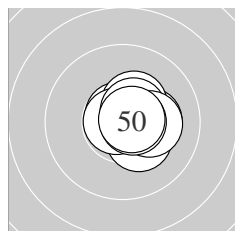

Serie 5:	10.3 *	10.7 *	10.3 *	10.2 *	10.4 *
	10.8 *	10.5 *	10.2 *	10.7 *	10.7 *
beste Teiler	42.2 (46.)	54.3 (42.)	64.2 (50.)		
Trefferlage	0.84 mm rechts, 0.13 mm hoch				
Streuwert	0.70, horizontal: 0.78, vertikal: 0.61				

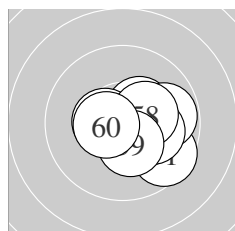

Serie 6:	9.6 ↘	10.4 *	10.3 *	10.5 *	9.8 →
	10.6 *	10.1 →	10.3 *	10.4 *	10.5 *
beste Teiler	79.1 (56.)	110.7 (60.)	119.4 (54.)		
Trefferlage	1.07 mm rechts, 0.18 mm tief				
Streuwert	1.18, horizontal: 1.39, vertikal: 0.91				

Meyton Elektronik

ISSF AR Women Jun – Wertung – Juniorinnen

StartNr: 63

StandNr: 116

18. Januar 2020 11:36

Arnold, Sandra #310

SUI

Unterschrift des Schützen

Meyton Elektronik

Ergebnis:	606.6	(579)							
Serien:	101.3	104.1	95.8	102.0	100.9	102.5			
Zähler:	42	15	3	0	0	0	0	0	0
Innenzehner:	35								
weiteste:	577 (41), 537 (26), 533 (28)								
beste Teiler	17.0 (38.)	18.0 (45.)	43.4 (16.)						
Trefferlage	0.42 mm rechts,	0.05 mm hoch							
Streuwert	1.75, horizontal: 2.15, vertikal: 1.22								

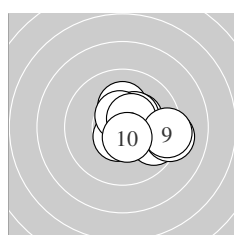
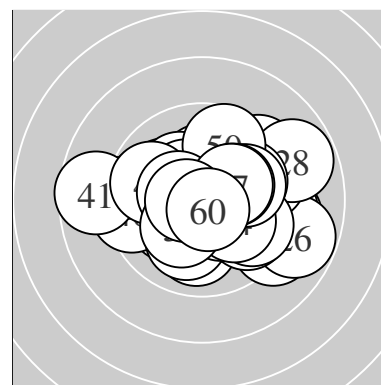

Serie 1:

10.3 *	10.2 *	10.4 *	10.6 *	9.7 ↘
9.2 →	10.5 *	10.5 *	9.3 →	10.6 *
beste Teiler	94.3 (4.)	100.7 (10.)	108.1 (7.)	
Trefferlage	1.40 mm rechts, 0.11 mm hoch			
Streuwert	1.44, horizontal: 1.72, vertikal: 1.09			

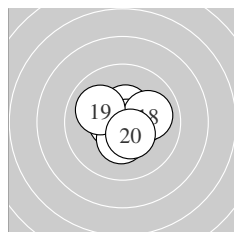

Serie 2:

10.6 *	10.7 *	10.3 *	10.5 *	10.5 *
10.8 *	10.3 *	10.0 →	10.0 ↖	10.4 *
beste Teiler	43.4 (16.)	53.2 (12.)	82.2 (11.)	
Trefferlage	0.33 mm rechts, 0.00 mm			
Streuwert	1.05, horizontal: 1.21, vertikal: 0.87			

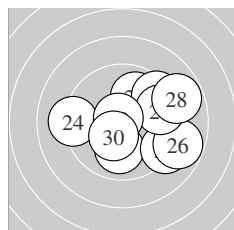

Serie 3:

9.9 ↗	9.4 ↗	10.0 ↓	9.2 ←	9.1 ↘
8.8 →	9.5 →	8.8 →	10.7 *	10.4 *
beste Teiler	53.7 (29.)	149.4 (30.)	243.8 (23.)	
Trefferlage	1.53 mm rechts, 0.02 mm hoch			
Streuwert	2.55, horizontal: 3.04, vertikal: 1.94			

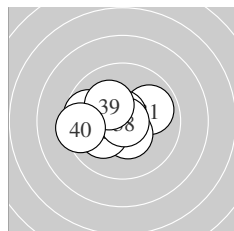

Serie 4:

9.9 →	10.7 *	10.4 *	10.1 ↖	10.3 *
9.7 ←	10.4 *	10.9 *	10.2 *	9.4 ←
beste Teiler	17.0 (38.)	56.7 (32.)	126.8 (33.)	
Trefferlage	0.94 mm links, 0.25 mm hoch			
Streuwert	1.43, horizontal: 1.79, vertikal: 0.95			

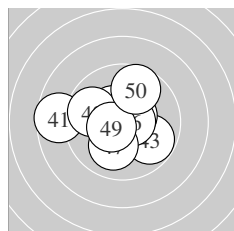

Serie 5:

8.6 ←	10.4 *	9.8 ↘	10.5 *	10.9 *
10.7 *	10.0 ↓	9.8 ←	10.5 *	9.7 ↗
beste Teiler	18.0 (45.)	73.1 (46.)	105.3 (44.)	
Trefferlage	0.61 mm links, 0.17 mm hoch			
Streuwert	1.92, horizontal: 2.31, vertikal: 1.41			

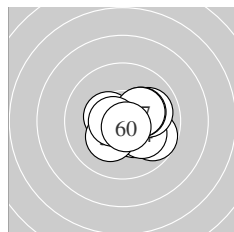

Serie 6:

10.4 *	9.7 ↘	10.4 *	10.1 ↘	10.0 →
10.2 *	10.2 *	10.2 *	10.6 *	10.7 *
beste Teiler	61.9 (60.)	85.0 (59.)	135.0 (51.)	
Trefferlage	0.81 mm rechts, 0.27 mm tief			
Streuwert	1.23, horizontal: 1.46, vertikal: 0.93			

ISSF AR Women Jun – Wertung – Juniorinnen

StandNr: 117

Vogl, Jana #224

StartNr: 64

18. Januar 2020 11:18

T – SG Wattens

Unterschrift des Schützen

Meyton Elektronik

Ergebnis: **590.9** (565)
 Serien: 89.4 98.1 101.0 101.7 99.7 101.0
 Zähler: 33 23 3 0 0 0 1 0 0 0
 Innenzehner: 23
 weiteste: 1572 (1), 603 (53), 598 (2)
 beste Teiler 48.3 (30.) 91.0 (54.) 91.4 (25.)
 Trefferlage 0.17 mm links, 0.70 mm hoch
 Streuwert 2.43, horizontal: 1.84, vertikal: 2.89

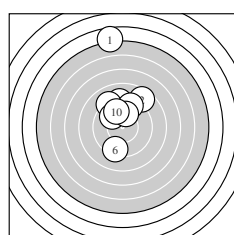
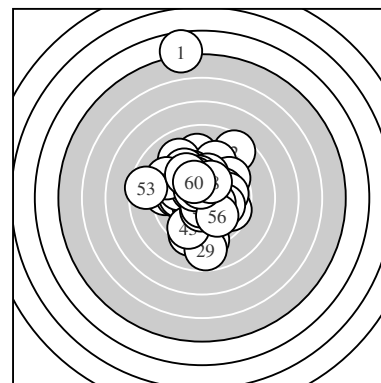

Serie 1:
 4.7 ↑ 8.6 ↗ 9.1 ↑ 9.6 ↖ 9.1 ↖
 9.3 ↓ 9.9 ↘ 9.3 ↑ 10.0 ↑ 9.8 ↖
 beste Teiler 240.6 (9.) 263.7 (7.) 298.0 (10.)
 Trefferlage 0.53 mm links, 3.90 mm hoch
 Streuwert 3.63, horizontal: 1.83, vertikal: 4.79

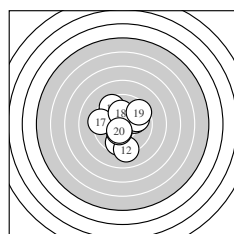

Serie 2:
 9.6 ↓ 9.2 ↓ 10.1 → 9.9 → 10.3 *
 9.5 ↘ 9.4 ← 10.2 * 9.5 ↗ 10.4 *
 beste Teiler 127.4 (20.) 152.7 (15.) 200.2 (18.)
 Trefferlage 0.00 mm , 0.11 mm tief
 Streuwert 2.25, horizontal: 2.09, vertikal: 2.41

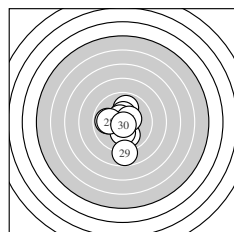

Serie 3:
 9.9 ↑ 10.0 ↓ 9.9 ← 10.4 * 10.6 *
 10.4 * 10.2 * 10.0 ← 8.8 ↓ 10.8 *
 beste Teiler 48.3 (30.) 91.4 (25.) 126.5 (26.)
 Trefferlage 0.22 mm links, 0.44 mm tief
 Streuwert 1.83, horizontal: 1.28, vertikal: 2.24

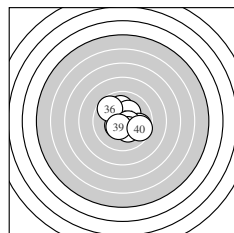

Serie 4:
 10.5 * 10.5 * 10.0 ↑ 10.3 * 9.8 →
 9.7 ↘ 10.5 * 10.3 * 10.5 * 9.6 →
 beste Teiler 106.9 (37.) 107.0 (32.) 120.1 (31.)
 Trefferlage 0.55 mm rechts, 0.04 mm hoch
 Streuwert 1.54, horizontal: 1.65, vertikal: 1.43

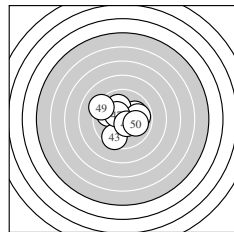

Serie 5:
 10.1 ↘ 9.9 ↖ 9.6 ↓ 10.0 → 10.1 ↑
 9.9 → 10.4 * 10.5 * 9.2 ↖ 10.0 →
 beste Teiler 109.9 (48.) 131.3 (47.) 201.0 (41.)
 Trefferlage 0.26 mm links, 0.42 mm hoch
 Streuwert 1.91, horizontal: 2.16, vertikal: 1.62

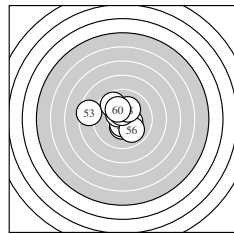

Serie 6:
 10.4 * 10.4 * 8.5 ← 10.6 * 10.5 *
 10.0 ↓ 10.5 * 10.2 * 9.7 ↖ 10.2 *
 beste Teiler 91.0 (54.) 110.7 (57.) 113.2 (55.)
 Trefferlage 0.56 mm links, 0.43 mm hoch
 Streuwert 1.84, horizontal: 2.15, vertikal: 1.48

ISSF AR Women Jun – Wertung – Juniorinnen

StandNr: 118

Ohler, Laura #361

StartNr: 65

18. Januar 2020 11:20
OOE – SV Theuerwang

Unterschrift des Schützen

Meyton Elektronik

Ergebnis: **612.2** (585)

Serien: 102.4 103.2 101.8 102.9 99.1 102.8

Zähler: 46 13 1 0 0 0 0 0 0 0

Innenzehner: 39

weiteste: 502 (44), 440 (26), 402 (49)

beste Teiler 7.2 (13.) 19.4 (5.) 49.3 (2.)

Trefferlage 0.47 mm links, 0.05 mm tief

Streuwert 1.52, horizontal: 1.82, vertikal: 1.13

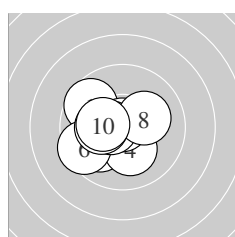
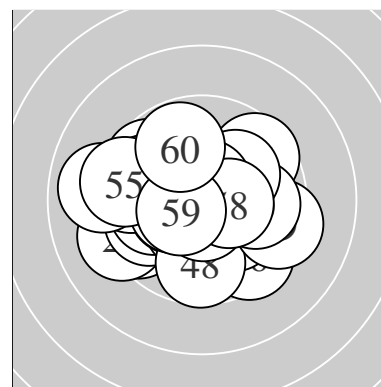

Serie 1:

9.7 ↘	10.8 *	10.0 ↙	10.2 *	10.9 *
9.5 ↙	10.6 *	10.2 *	10.2 *	10.3 *

beste Teiler 19.4 (5.) 49.3 (2.) 98.1 (7.)

Trefferlage 1.02 mm links, 0.21 mm tief

Streuwert 1.36, horizontal: 1.53, vertikal: 1.15

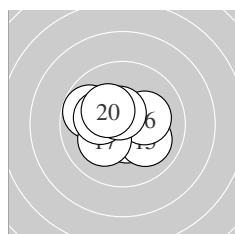

Serie 2:

10.5 *	10.5 *	10.9 *	9.8 ↖	10.0 ↗
10.2 *	10.2 *	10.2 *	10.6 *	10.3 *

beste Teiler 7.2 (13.) 96.8 (19.) 103.1 (11.)

Trefferlage 0.45 mm links, 0.08 mm hoch

Streuwert 1.27, horizontal: 1.53, vertikal: 0.94

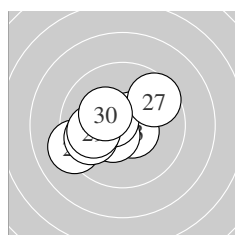

Serie 3:

10.6 *	10.6 *	10.6 *	10.5 *	10.6 *
9.2 ↙	9.6 ↗	9.8 ↙	10.0 ↙	10.3 *

beste Teiler 78.2 (21.) 86.4 (22.) 95.7 (23.)

Trefferlage 0.85 mm links, 0.14 mm tief

Streuwert 1.59, horizontal: 1.93, vertikal: 1.14

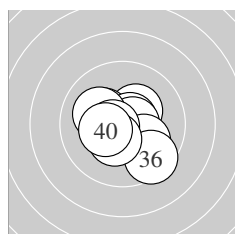

Serie 4:

10.3 *	10.3 *	10.7 *	10.6 *	10.0 ↗
9.5 ↘	10.1 ↖	10.6 *	10.4 *	10.4 *

beste Teiler 73.2 (33.) 84.0 (34.) 85.8 (38.)

Trefferlage 0.02 mm rechts, 0.30 mm tief

Streuwert 1.37, horizontal: 1.51, vertikal: 1.22

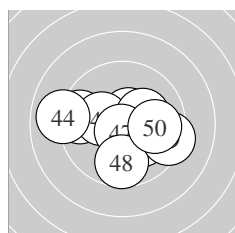

Serie 5:

10.6 *	9.5 ↖	10.2 *	8.9 ↖	10.1 ↗
10.2 *	10.7 *	9.7 ↓	9.3 ↗	9.9 →

beste Teiler 60.2 (47.) 92.9 (41.) 179.4 (43.)

Trefferlage 0.02 mm links, 0.33 mm tief

Streuwert 2.15, horizontal: 2.75, vertikal: 1.27

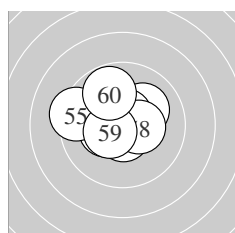

Serie 6:

10.6 *	10.1 ↗	10.4 *	10.3 *	9.4 ↖
10.7 *	10.6 *	10.4 *	10.5 *	9.8 ↖

beste Teiler 61.4 (56.) 81.3 (57.) 83.2 (51.)

Trefferlage 0.53 mm links, 0.55 mm hoch

Streuwert 1.35, horizontal: 1.58, vertikal: 1.06

ISSF AR Women Jun – Wertung – Juniorinnen

StandNr: 119

Kovalenko, Vladyslava #362

StartNr: 66

18. Januar 2020 11:44

UKR

Unterschrift des Schützen

Meyton Elektronik

Ergebnis: **616.4** (585)
 Serien: 102.7 101.4 102.4 104.4 102.0 103.5
 Zähler: 45 15 0 0 0 0 0 0 0
 Innenzehner: 40
 weiteste: 396 (19), 386 (57), 349 (17)
 beste Teiler 29.0 (53.) 31.2 (20.) 39.2 (36.)
 Trefferlage 0.00 mm , 0.02 mm hoch
 Streuwert 1.37, horizontal: 1.47, vertikal: 1.27

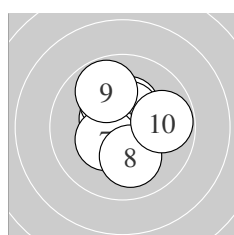
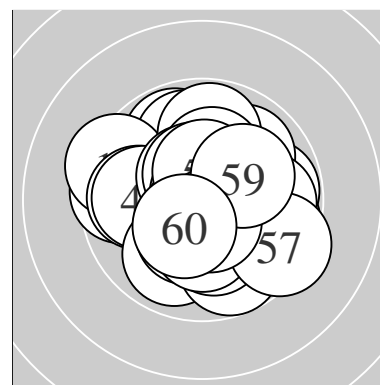

Serie 1:
 10.5 * 10.6 * 10.4 * 10.1 ↖ 10.5 *
 10.5 * 10.4 * 10.1 ↓ 9.8 ↖ 9.8 →
 beste Teiler 78.7 (2.) 107.8 (1.) 114.7 (6.)
 Trefferlage 0.01 mm rechts, 0.37 mm hoch
 Streuwert 1.35, horizontal: 1.25, vertikal: 1.44

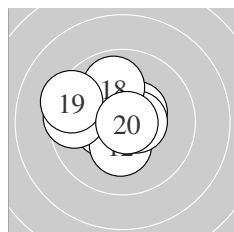

Serie 2:
 10.4 * 10.3 * 9.7 ↖ 10.5 * 10.6 *
 10.2 * 9.6 ← 9.9 ↖ 9.4 ↖ 10.8 *
 beste Teiler 31.2 (20.) 98.0 (15.) 120.4 (14.)
 Trefferlage 1.10 mm links, 0.56 mm hoch
 Streuwert 1.49, horizontal: 1.77, vertikal: 1.15

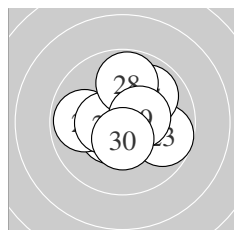

Serie 3:
 10.6 * 10.5 * 9.7 ↘ 10.6 * 9.9 ←
 10.5 * 9.9 ↗ 9.8 ↑ 10.4 * 10.5 *
 beste Teiler 89.8 (21.) 90.9 (24.) 114.7 (22.)
 Trefferlage 0.12 mm rechts, 0.24 mm hoch
 Streuwert 1.46, horizontal: 1.63, vertikal: 1.26

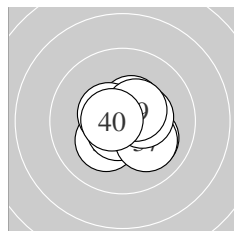

Serie 4:
 10.1 ↘ 10.5 * 10.2 * 10.7 * 10.5 *
 10.8 * 10.1 ↘ 10.4 * 10.5 * 10.6 *
 beste Teiler 39.2 (36.) 69.4 (34.) 77.5 (40.)
 Trefferlage 0.35 mm rechts, 0.19 mm tief
 Streuwert 1.02, horizontal: 1.13, vertikal: 0.91

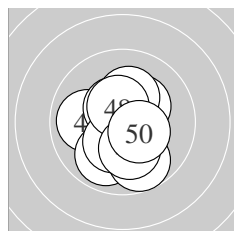

Serie 5:
 9.9 ← 9.9 ↙ 10.5 * 10.3 * 9.8 ↓
 10.3 * 10.2 * 10.5 * 10.2 * 10.4 *
 beste Teiler 116.7 (48.) 118.3 (43.) 138.0 (50.)
 Trefferlage 0.07 mm links, 0.39 mm tief
 Streuwert 1.45, horizontal: 1.22, vertikal: 1.64

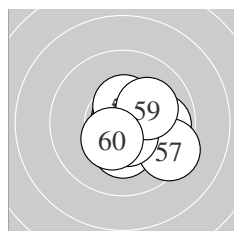

Serie 6:
 9.9 → 10.3 * 10.8 * 10.8 * 10.7 *
 10.5 * 9.4 ↘ 10.6 * 10.1 ↗ 10.4 *
 beste Teiler 29.0 (53.) 49.0 (54.) 75.1 (55.)
 Trefferlage 0.72 mm rechts, 0.44 mm tief
 Streuwert 1.24, horizontal: 1.39, vertikal: 1.06

Meyton Elektronik

ISSF AR Women Jun – Wertung – Juniorinnen

StandNr: 120

Mayr, Carmen #16

StartNr: 67

18. Januar 2020 11:17

AUT

Unterschrift des Schützen

Meyton Elektronik

Ergebnis: **624.4** (597)^{QF}
 Serien: 104.3 104.4 103.7 104.2 104.2 103.6
 Zähler: 57 3 0 0 0 0 0 0 0 0
 Innenzehner: 51
 weiteste: 318 (10), 318 (22), 285 (40)
 beste Teiler 10.0 (16.) 39.0 (47.) 40.1 (42.)
 Trefferlage 0.02 mm links, 0.30 mm hoch
 Streuwert 1.06, horizontal: 1.21, vertikal: 0.89

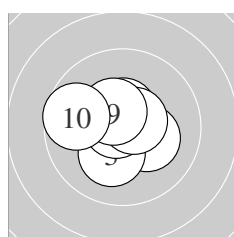
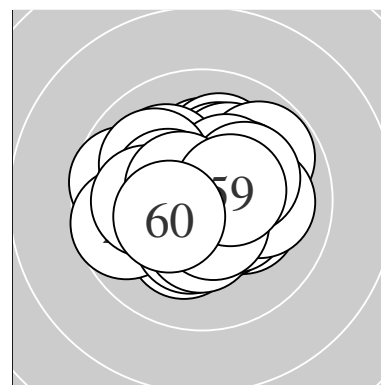

Serie 1:
 10.7 * 10.2 * 10.2 * 10.6 * 10.5 *
 10.5 * 10.8 * 10.6 * 10.5 * 9.7 ←
 beste Teiler 45.8 (7.) 74.3 (1.) 87.0 (4.)
 Trefferlage 0.37 mm links, 0.21 mm hoch
 Streuwert 1.08, horizontal: 1.22, vertikal: 0.92

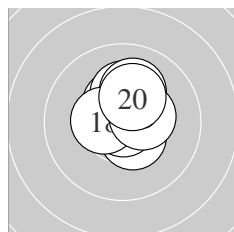

Serie 2:
 10.6 * 10.4 * 10.2 * 10.5 * 10.6 *
 10.9 * 10.1 ↑ 10.5 * 10.4 * 10.2 *
 beste Teiler 10.0 (16.) 83.8 (11.) 87.8 (15.)
 Trefferlage 0.28 mm rechts, 0.62 mm hoch
 Streuwert 0.90, horizontal: 0.72, vertikal: 1.05

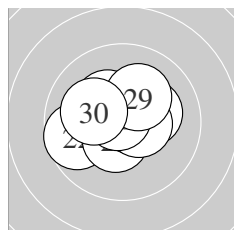

Serie 3:
 10.7 * 9.7 ← 10.5 * 10.2 * 10.7 *
 10.3 * 10.5 * 10.8 * 10.2 * 10.1 ←
 beste Teiler 46.6 (28.) 58.0 (21.) 62.9 (25.)
 Trefferlage 0.22 mm links, 0.31 mm hoch
 Streuwert 1.21, horizontal: 1.47, vertikal: 0.88

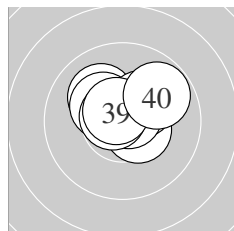

Serie 4:
 10.7 * 10.5 * 10.5 * 10.1 ↘ 10.3 *
 10.3 * 10.7 * 10.7 * 10.6 * 9.8 ↗
 beste Teiler 57.2 (37.) 70.0 (31.) 72.9 (38.)
 Trefferlage 0.09 mm rechts, 0.68 mm hoch
 Streuwert 1.00, horizontal: 1.23, vertikal: 0.72

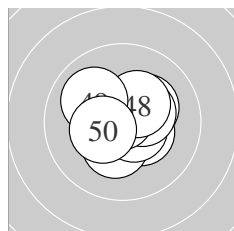

Serie 5:
 10.4 * 10.8 * 10.2 * 10.3 * 10.6 *
 10.4 * 10.8 * 10.3 * 10.0 ↘ 10.4 *
 beste Teiler 39.0 (47.) 40.1 (42.) 88.6 (45.)
 Trefferlage 0.20 mm rechts, 0.10 mm hoch
 Streuwert 1.07, horizontal: 1.17, vertikal: 0.96

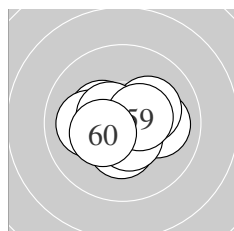

Serie 6:
 10.4 * 10.0 → 10.2 * 10.5 * 10.4 *
 10.5 * 10.1 ← 10.6 * 10.5 * 10.4 *
 beste Teiler 99.4 (58.) 102.0 (56.) 106.9 (54.)
 Trefferlage 0.12 mm links, 0.08 mm tief
 Streuwert 1.18, horizontal: 1.49, vertikal: 0.75

Meyton Elektronik

ISSF AR Women Jun – Wertung – Juniorinnen

StartNr: 68

StandNr: 121

18. Januar 2020 11:35

Thurnwaldova, Sabina #363

CZE

QF – Schütze hat sich fürs Finale qualifiziert

Unterschrift des Schützen

Meyton Elektronik

Ergebnis:	592.5	(561)
Serien:	99.0 99.5 99.4 97.1 99.5 98.0	
Zähler:	26 29 5 0 0 0 0 0 0	
Innenzehner:	20	
weiteste:	629 (33), 568 (3), 513 (38)	
beste Teiler	18.9 (36.) 43.8 (41.) 78.6 (12.)	
Trefferlage	0.03 mm links, 0.31 mm hoch	
Streuwert	2.15, horizontal: 2.63, vertikal: 1.52	

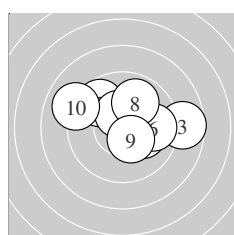
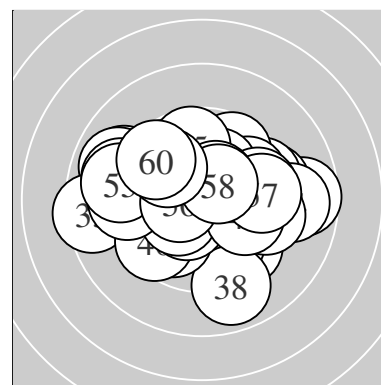

Serie 1:	10.5 *	9.7 ↘	8.7 →	10.5 *	10.1 ↘
	9.8 →	10.4 *	9.9 ↑	10.4 *	9.0 ↖
beste Teiler	110.3 (1.)	124.0 (4.)	129.9 (7.)		
Trefferlage	0.73 mm rechts, 0.62 mm hoch				
Streuwert	2.13, horizontal: 2.73, vertikal: 1.29				

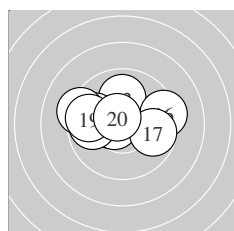

Serie 2:	10.4 *	10.6 *	10.0 ↑	9.9 ↖	9.8 ←
	9.4 →	9.8 ↘	9.3 ↖	9.7 ↖	10.6 *
beste Teiler	78.6 (12.)	82.6 (20.)	132.0 (11.)		
Trefferlage	0.85 mm links, 0.54 mm hoch				
Streuwert	1.93, horizontal: 2.57, vertikal: 0.91				

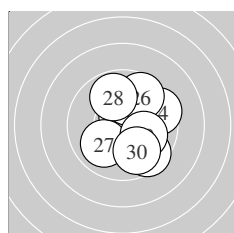

Serie 3:	10.6 *	9.5 ↘	10.4 *	9.5 →	10.0 ↑
	9.7 ↑	10.0 ↙	9.8 ↖	10.1 ↘	9.8 ↘
beste Teiler	83.0 (21.)	149.7 (23.)	221.8 (29.)		
Trefferlage	0.94 mm rechts, 0.32 mm hoch				
Streuwert	1.83, horizontal: 1.54, vertikal: 2.09				

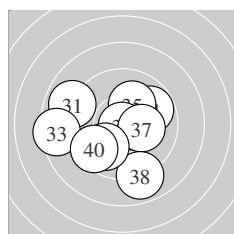

Serie 4:	8.9 ↖	10.5 *	8.4 ←	9.8 ↗	10.1 ↑
	10.9 *	10.2 *	8.9 ↓	9.9 ↙	9.5 ↙
beste Teiler	18.9 (36.)	101.9 (32.)	182.9 (37.)		
Trefferlage	0.74 mm links, 0.58 mm tief				
Streuwert	2.59, horizontal: 2.99, vertikal: 2.11				

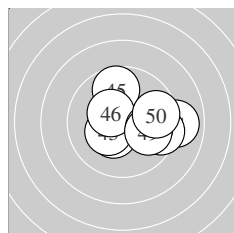

Serie 5:	10.8 *	10.4 *	10.3 *	8.9 →	9.7 ↑
	10.4 *	9.5 →	9.9 →	9.9 →	9.7 →
beste Teiler	43.8 (41.)	140.6 (46.)	146.0 (42.)		
Trefferlage	1.25 mm rechts, 0.03 mm hoch				
Streuwert	1.89, horizontal: 2.34, vertikal: 1.28				

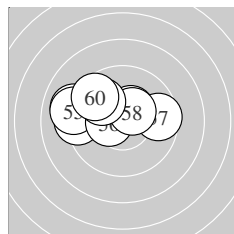

Serie 6:	9.0 ↖	9.3 ←	10.4 *	10.3 *	9.1 ←
	10.4 *	9.6 →	10.4 *	9.9 ↘	9.6 ↘
beste Teiler	127.8 (56.)	129.4 (58.)	135.0 (53.)		
Trefferlage	1.55 mm links, 0.94 mm hoch				
Streuwert	1.95, horizontal: 2.66, vertikal: 0.76				

Meyton Elektronik

ISSF AR Women Jun – Wertung – Juniorinnen

StandNr: 122

Vogl, Jasmin #70

StartNr: 69

18. Januar 2020 11:20

T – SG Wattens

Unterschrift des Schützen

Meyton Elektronik