

Ergebnis: **408.9** (393)
 Serien: 104.6 101.4 101.5 101.4
 Zähler: 33 7 0 0 0 0 0 0 0 0
 Innenzehner: 25
 weiteste: 402 (11), 355 (15), 336 (34)
 beste Teiler 47.0 (9.) 47.7 (2.) 77.5 (27.)
 Trefferlage 0.14 mm rechts, 0.24 mm hoch
 Streuwert 1.42, horizontal: 1.53, vertikal: 1.30

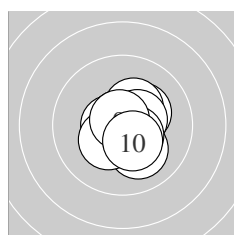

Serie 1:
 10.3 * 10.8 * 10.3 * 10.1 ↘ 10.5 *
 10.6 * 10.5 * 10.3 * 10.8 * 10.4 *
 beste Teiler 47.0 (9.) 47.7 (2.) 90.0 (6.)
 Trefferlage 0.36 mm rechts, 0.13 mm tief
 Streuwert 0.96, horizontal: 0.90, vertikal: 1.01

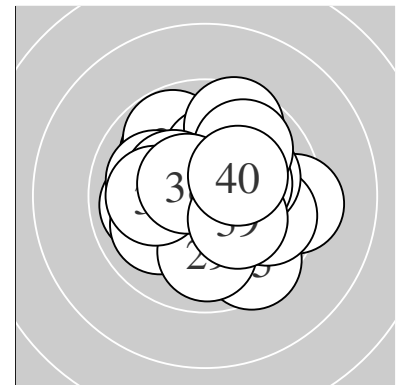
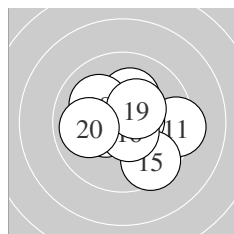

Serie 2:
 9.3 → 10.4 * 10.6 * 10.4 * 9.5 ↘
 10.6 * 10.2 * 10.1 ↖ 10.4 * 9.9 ←
 beste Teiler 86.2 (16.) 90.6 (13.) 130.6 (14.)
 Trefferlage 0.22 mm rechts, 0.03 mm tief
 Streuwert 1.67, horizontal: 1.98, vertikal: 1.30

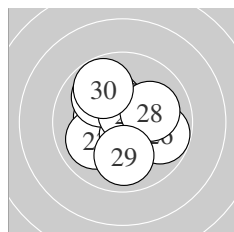

Serie 3:
 10.3 * 10.4 * 10.0 ↙ 10.5 * 10.0 ↖
 9.8 → 10.6 * 10.1 → 10.0 ↓ 9.8 ↖
 beste Teiler 77.5 (27.) 106.4 (24.) 148.6 (22.)
 Trefferlage 0.13 mm links, 0.20 mm hoch
 Streuwert 1.60, horizontal: 1.62, vertikal: 1.57

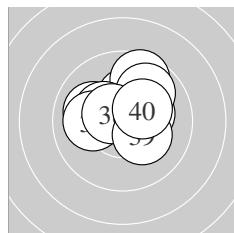

Serie 4:
 10.2 * 10.0 ↖ 10.2 * 9.6 ↗ 10.3 *
 10.1 ← 9.9 ↗ 10.6 * 10.2 * 10.3 *
 beste Teiler 97.9 (38.) 158.3 (35.) 173.7 (40.)
 Trefferlage 0.13 mm rechts, 0.93 mm hoch
 Streuwert 1.42, horizontal: 1.64, vertikal: 1.15

Unterschrift des Schützen

Meyton Elektronik

Ergebnis: **396.9** (380)
 Serien: 97.7 99.2 100.9 99.1
 Zähler: 21 18 1 0 0 0 0 0 0 0
 Innenzehner: 15
 weiteste: 620 (40), 486 (19), 474 (11)
 beste Teiler 44.4 (15.) 70.8 (4.) 71.2 (36.)
 Trefferlage 0.22 mm links, 0.09 mm hoch
 Streuwert 2.09, horizontal: 2.43, vertikal: 1.70

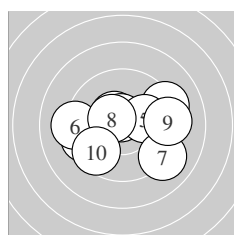
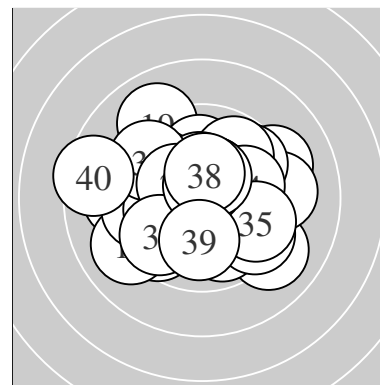

Serie 1:
 10.5 * 9.2 ↗ 9.5 ← 10.7 * 10.1 →
 9.2 ← 9.1 ↘ 10.5 * 9.3 → 9.6 ↙
 beste Teiler 70.8 (4.) 117.6 (8.) 119.2 (1.)
 Trefferlage 0.16 mm rechts, 0.15 mm tief
 Streuwert 2.49, horizontal: 3.18, vertikal: 1.53

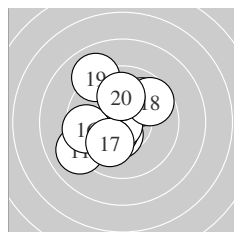

Serie 2:
 9.1 ↙ 10.5 * 10.5 * 9.9 ↗ 10.8 *
 9.6 ← 10.1 ↙ 9.7 ↗ 9.0 ↘ 10.0 ↑
 beste Teiler 44.4 (15.) 117.6 (13.) 120.6 (12.)
 Trefferlage 0.83 mm links, 0.29 mm hoch
 Streuwert 2.12, horizontal: 2.07, vertikal: 2.17

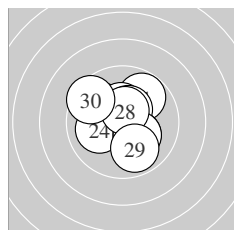

Serie 3:
 9.8 ↗ 9.9 ↘ 10.4 * 10.1 ← 10.2 *
 10.4 * 10.2 * 10.5 * 9.9 ↓ 9.5 ↘
 beste Teiler 109.2 (28.) 128.8 (26.) 144.7 (23.)
 Trefferlage 0.11 mm links, 0.41 mm hoch
 Streuwert 1.68, horizontal: 1.72, vertikal: 1.64

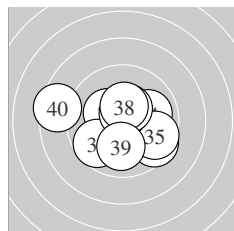

Serie 4:
 10.3 * 9.7 ↙ 9.5 ↘ 10.0 → 9.6 ↘
 10.7 * 10.4 * 10.4 * 10.0 ↓ 8.5 ←
 beste Teiler 71.2 (36.) 128.4 (37.) 138.7 (38.)
 Trefferlage 0.09 mm links, 0.18 mm tief
 Streuwert 2.24, horizontal: 2.76, vertikal: 1.56

Unterschrift des Schützen

Meyton Elektronik

Ergebnis: **413.0** (391)
 Serien: 103.5 102.7 101.7 105.1
 Zähler: 31 9 0 0 0 0 0 0 0 0
 Innenzehner: 30
 weiteste: 332 (40), 316 (16), 303 (11)
 beste Teiler 14.4 (32.) 39.2 (35.) 55.5 (30.)
 Trefferlage 0.03 mm links, 0.07 mm hoch
 Streuwert 1.28, horizontal: 1.45, vertikal: 1.07

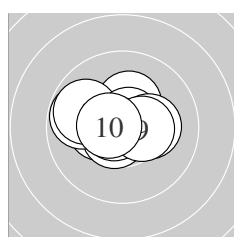
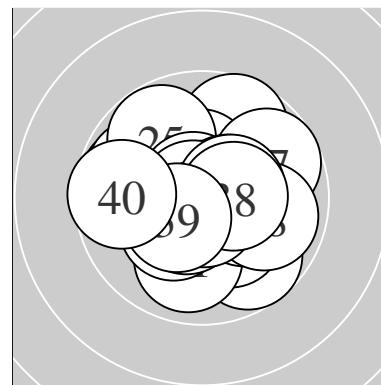

Serie 1:
 10.3 * 10.3 * 10.6 * 9.8 ↖ 9.9 ↖
 10.7 * 10.2 * 10.7 * 10.4 * 10.6 *
 beste Teiler 58.4 (8.) 64.6 (6.) 82.0 (3.)
 Trefferlage 0.49 mm links, 0.32 mm hoch
 Streuwert 1.18, horizontal: 1.53, vertikal: 0.66

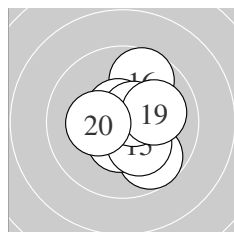

Serie 2:
 9.7 ↘ 10.5 * 10.6 * 10.5 * 10.2 *
 9.7 ↗ 10.6 * 10.6 * 10.0 → 10.3 *
 beste Teiler 81.1 (17.) 89.2 (13.) 95.0 (18.)
 Trefferlage 0.51 mm rechts, 0.00 mm
 Streuwert 1.35, horizontal: 1.25, vertikal: 1.45

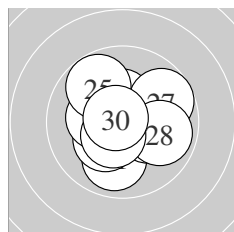

Serie 3:
 9.9 ↓ 10.3 * 10.4 * 10.3 * 9.8 ↗
 10.2 * 9.7 ↗ 9.9 → 10.5 * 10.7 *
 beste Teiler 55.5 (30.) 111.8 (29.) 143.4 (23.)
 Trefferlage 0.06 mm rechts, 0.00 mm
 Streuwert 1.57, horizontal: 1.66, vertikal: 1.47

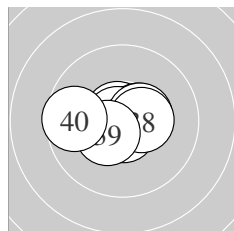

Serie 4:
 10.7 * 10.9 * 10.6 * 10.5 * 10.8 *
 10.7 * 10.5 * 10.4 * 10.4 * 9.6 ←
 beste Teiler 14.4 (32.) 39.2 (35.) 60.6 (31.)
 Trefferlage 0.21 mm links, 0.02 mm tief
 Streuwert 1.02, horizontal: 1.36, vertikal: 0.45

Unterschrift des Schützen

Meyton Elektronik

Ergebnis: **414.5** (396)
 Serien: 104.9 102.3 103.2 104.1
 Zähler: 36 4 0 0 0 0 0 0 0 0
 Innenzehner: 32
 weiteste: 374 (37), 373 (16), 355 (17)
 beste Teiler 37.3 (6.) 40.0 (33.) 40.2 (5.)
 Trefferlage 0.31 mm links, 0.13 mm hoch
 Streuwert 1.21, horizontal: 1.19, vertikal: 1.23

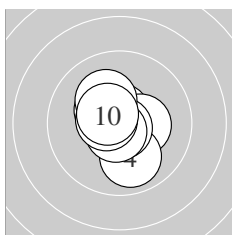
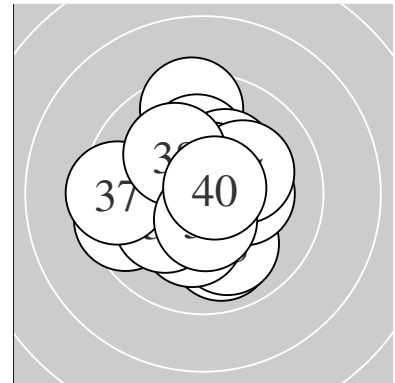

Serie 1:
 10.7 * 10.3 * 10.4 * 9.9 ↘ 10.8 *
 10.8 * 10.2 * 10.7 * 10.6 * 10.5 *
 beste Teiler 37.3 (6.) 40.2 (5.) 64.0 (1.)
 Trefferlage 0.19 mm links, 0.03 mm hoch
 Streuwert 0.98, horizontal: 0.85, vertikal: 1.10

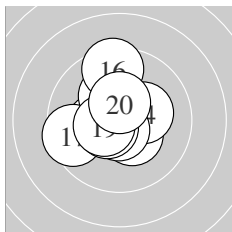

Serie 2:
 10.3 * 10.2 * 10.4 * 10.3 * 10.7 *
 9.5 ↑ 9.5 ← 10.5 * 10.5 * 10.4 *
 beste Teiler 71.2 (15.) 103.7 (18.) 118.2 (19.)
 Trefferlage 0.57 mm links, 0.31 mm hoch
 Streuwert 1.46, horizontal: 1.39, vertikal: 1.53

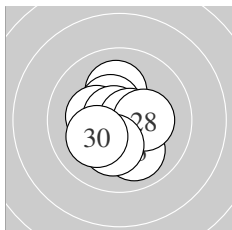

Serie 3:
 10.1 ↑ 10.5 * 10.0 ↘ 10.3 * 10.8 *
 10.2 * 10.7 * 10.3 * 10.2 * 10.1 ↙
 beste Teiler 48.8 (25.) 74.2 (27.) 124.8 (22.)
 Trefferlage 0.21 mm links, 0.31 mm tief
 Streuwert 1.25, horizontal: 1.11, vertikal: 1.37

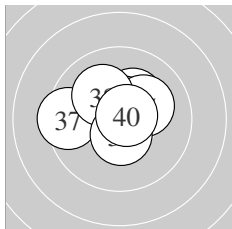

Serie 4:
 10.3 * 10.6 * 10.8 * 10.7 * 10.2 *
 10.7 * 9.5 ← 10.1 ↘ 10.5 * 10.7 *
 beste Teiler 40.0 (33.) 53.1 (36.) 57.2 (40.)
 Trefferlage 0.27 mm links, 0.50 mm hoch
 Streuwert 1.19, horizontal: 1.48, vertikal: 0.81

Unterschrift des Schützen

Meyton Elektronik

Ergebnis: **411.4** (395)
 Serien: 102.1 102.6 102.9 103.8
 Zähler: 35 5 0 0 0 0 0 0 0 0
 Innenzehner: 26
 weiteste: 316 (5), 306 (18), 300 (20)
 beste Teiler 28.2 (17.) 65.7 (16.) 72.1 (35.)
 Trefferlage 0.12 mm rechts, 0.02 mm tief
 Streuwert 1.30, horizontal: 1.12, vertikal: 1.45

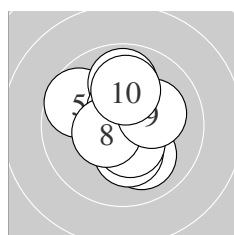
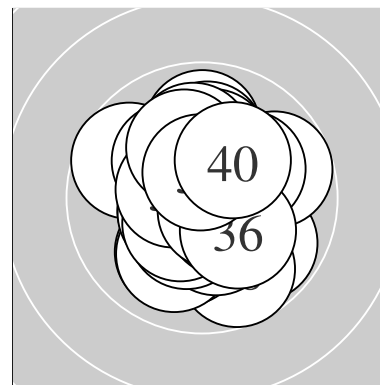

Serie 1:
 10.6 * 10.0 ↘ 10.2 * 10.5 * 9.7 ↖
 9.9 ↑ 10.6 * 10.5 * 10.1 → 10.0 ↑
 beste Teiler 95.6 (1.) 99.3 (7.) 113.2 (8.)
 Trefferlage 0.08 mm rechts, 0.21 mm hoch
 Streuwert 1.47, horizontal: 1.28, vertikal: 1.64

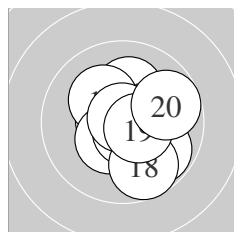

Serie 2:
 10.1 ↑ 9.8 ↘ 10.6 * 10.2 * 10.4 *
 10.7 * 10.8 * 9.7 ↘ 10.5 * 9.8 →
 beste Teiler 28.2 (17.) 65.7 (16.) 79.1 (13.)
 Trefferlage 0.51 mm rechts, 0.17 mm tief
 Streuwert 1.40, horizontal: 1.34, vertikal: 1.46

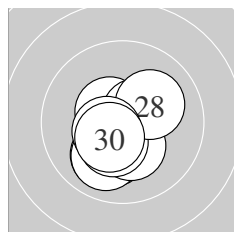

Serie 3:
 10.2 * 10.0 ↙ 10.0 ↙ 10.5 * 10.5 *
 10.3 * 10.4 * 10.1 → 10.5 * 10.4 *
 beste Teiler 106.6 (24.) 107.3 (25.) 117.8 (29.)
 Trefferlage 0.29 mm links, 0.81 mm tief
 Streuwert 1.11, horizontal: 1.00, vertikal: 1.22

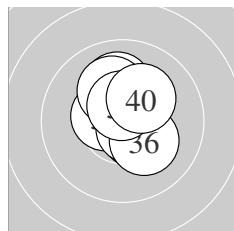

Serie 4:
 10.6 * 10.1 ↑ 10.5 * 10.5 * 10.7 *
 10.2 * 10.3 * 10.1 ↘ 10.6 * 10.2 *
 beste Teiler 72.1 (35.) 89.0 (31.) 99.1 (39.)
 Trefferlage 0.18 mm rechts, 0.67 mm hoch
 Streuwert 1.02, horizontal: 0.81, vertikal: 1.19

Unterschrift des Schützen

Meyton Elektronik

Ergebnis: **413.5** (395)
 Serien: 103.3 102.9 104.3 103.0
 Zähler: 35 5 0 0 0 0 0 0 0 0
 Innenzehner: 32
 weiteste: 373 (17), 290 (33), 265 (16)
 beste Teiler 35.1 (24.) 48.2 (13.) 58.2 (29.)
 Trefferlage 0.10 mm links, 0.23 mm hoch
 Streuwert 1.20, horizontal: 1.45, vertikal: 0.88

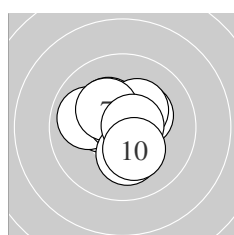
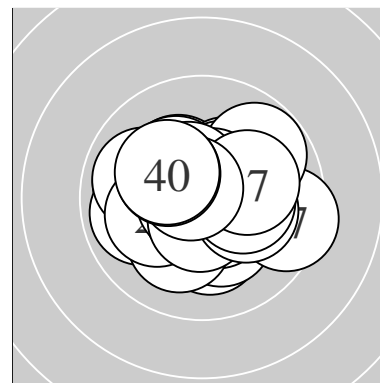

Serie 1:
 10.4 * 9.9 ← 10.3 * 10.3 * 10.7 *
 10.3 * 10.3 * 10.2 * 10.7 * 10.2 *
 beste Teiler 61.3 (5.) 71.8 (9.) 150.5 (1.)
 Trefferlage 0.19 mm links, 0.29 mm hoch
 Streuwert 1.20, horizontal: 1.26, vertikal: 1.14

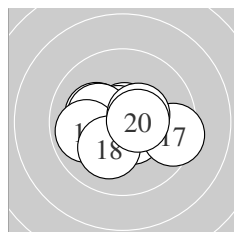

Serie 2:
 10.7 * 10.5 * 10.8 * 10.2 * 10.2 *
 9.9 ← 9.5 → 10.1 ↙ 10.5 * 10.5 *
 beste Teiler 48.2 (13.) 59.4 (11.) 101.5 (12.)
 Trefferlage 0.08 mm links, 0.14 mm tief
 Streuwert 1.42, horizontal: 1.83, vertikal: 0.84

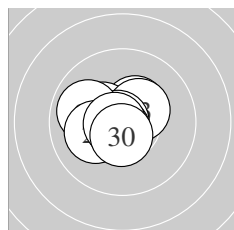

Serie 3:
 10.4 * 10.3 * 10.4 * 10.8 * 10.4 *
 9.9 ← 10.1 ← 10.7 * 10.7 * 10.6 *
 beste Teiler 35.1 (24.) 58.2 (29.) 59.9 (28.)
 Trefferlage 0.65 mm links, 0.09 mm hoch
 Streuwert 0.97, horizontal: 1.17, vertikal: 0.71

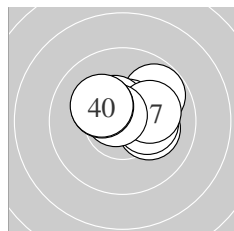

Serie 4:
 10.5 * 10.2 * 9.8 ↗ 10.6 * 10.5 *
 10.2 * 10.1 → 10.7 * 10.2 * 10.2 *
 beste Teiler 63.7 (38.) 85.0 (34.) 117.3 (35.)
 Trefferlage 0.51 mm rechts, 0.69 mm hoch
 Streuwert 1.12, horizontal: 1.44, vertikal: 0.67

Unterschrift des Schützen

Meyton Elektronik

Ergebnis: **413.5** (393)
 Serien: 103.1 102.1 103.7 104.6
 Zähler: 33 7 0 0 0 0 0 0 0 0
 Innenzehner: 29
 weiteste: 403 (23), 366 (20), 345 (14)
 beste Teiler 32.8 (34.) 43.9 (33.) 56.7 (6.)
 Trefferlage 0.00 mm , 0.33 mm hoch
 Streuwert 1.26, horizontal: 1.35, vertikal: 1.15

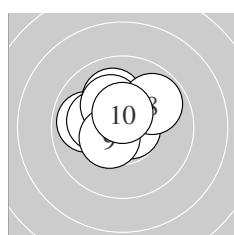
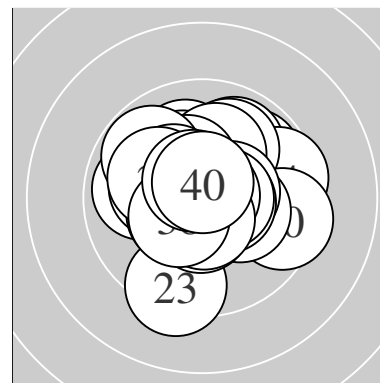

Serie 1:
 10.5 * 9.9 ← 10.2 * 10.7 * 10.1 ↑
 10.7 * 10.2 * 9.8 ↗ 10.5 * 10.5 *
 beste Teiler 56.7 (6.) 59.9 (4.) 105.0 (10.)
 Trefferlage 0.57 mm links, 0.74 mm hoch
 Streuwert 1.12, horizontal: 1.31, vertikal: 0.88

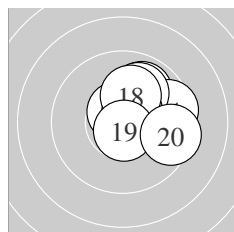

Serie 2:
 9.9 ↗ 10.5 * 10.7 * 9.6 → 10.6 *
 10.0 ↗ 10.5 * 10.1 ↑ 10.7 * 9.5 →
 beste Teiler 63.7 (19.) 73.4 (13.) 84.9 (15.)
 Trefferlage 1.21 mm rechts, 0.81 mm hoch
 Streuwert 1.18, horizontal: 1.28, vertikal: 1.07

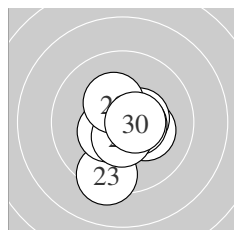

Serie 3:
 10.7 * 10.2 * 9.3 ↓ 10.5 * 10.5 *
 10.7 * 10.4 * 10.5 * 10.3 * 10.6 *
 beste Teiler 57.6 (26.) 65.5 (21.) 93.0 (30.)
 Trefferlage 0.15 mm rechts, 0.54 mm tief
 Streuwert 1.19, horizontal: 1.02, vertikal: 1.35

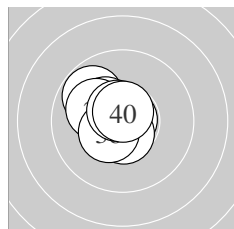

Serie 4:
 9.8 ↘ 10.3 * 10.8 * 10.8 * 10.6 *
 10.5 * 10.1 ↘ 10.4 * 10.6 * 10.7 *
 beste Teiler 32.8 (34.) 43.9 (33.) 69.0 (40.)
 Trefferlage 0.78 mm links, 0.35 mm hoch
 Streuwert 0.86, horizontal: 0.86, vertikal: 0.86

Unterschrift des Schützen

Meyton Elektronik

Ergebnis: **412.3** (398)
 Serien: 103.8 104.3 102.2 102.0
 Zähler: 38 2 0 0 0 0 0 0 0 0
 Innenzehner: 26
 weiteste: 324 (38), 278 (35), 249 (28)
 beste Teiler 25.5 (14.) 43.0 (11.) 70.1 (10.)
 Trefferlage 0.32 mm rechts, 0.24 mm hoch
 Streuwert 1.23, horizontal: 1.30, vertikal: 1.16

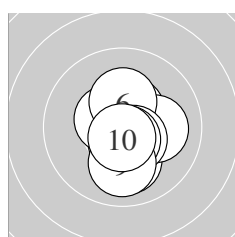
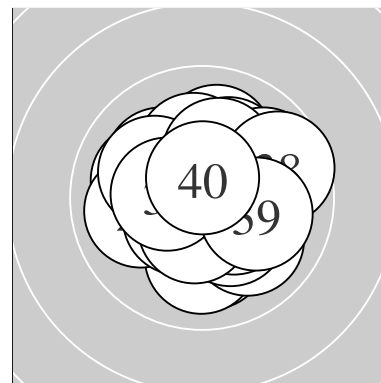

Serie 1:
 10.5 * 10.5 * 10.1 ↓ 10.1 → 10.5 *
 10.3 * 10.5 * 10.6 * 10.0 ↓ 10.7 *
 beste Teiler 70.1 (10.) 86.3 (8.) 106.9 (7.)
 Trefferlage 0.29 mm rechts, 0.48 mm tief
 Streuwert 1.08, horizontal: 0.79, vertikal: 1.30

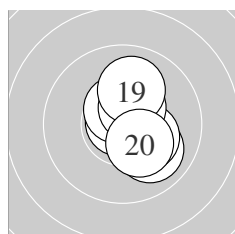

Serie 2:
 10.8 * 10.5 * 10.6 * 10.9 * 10.0 ↘
 10.3 * 10.5 * 10.4 * 10.0 ↑ 10.3 *
 beste Teiler 25.5 (14.) 43.0 (11.) 97.7 (13.)
 Trefferlage 0.54 mm rechts, 0.31 mm hoch
 Streuwert 1.01, horizontal: 0.74, vertikal: 1.23

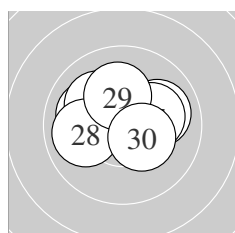

Serie 3:
 10.4 * 10.4 * 10.0 → 10.0 ← 10.5 *
 10.1 ↖ 10.2 * 10.0 ← 10.2 * 10.4 *
 beste Teiler 118.2 (25.) 132.5 (22.) 150.0 (30.)
 Trefferlage 0.04 mm links, 0.61 mm hoch
 Streuwert 1.36, horizontal: 1.76, vertikal: 0.79

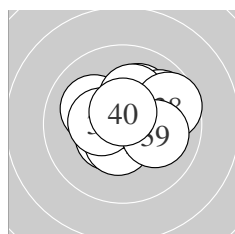

Serie 4:
 10.1 ↗ 10.5 * 10.1 ↖ 10.5 * 9.8 ↗
 10.2 * 10.4 * 9.7 → 10.1 → 10.6 *
 beste Teiler 80.0 (40.) 118.8 (34.) 121.7 (32.)
 Trefferlage 0.48 mm rechts, 0.53 mm hoch
 Streuwert 1.41, horizontal: 1.68, vertikal: 1.08

Unterschrift des Schützen

Meyton Elektronik

Ergebnis: **416.8** (398)
 Serien: 103.3 104.0 105.1 104.4 0.0
 Zähler: 38 2 0 0 0 0 0 0 0 0
 Innenzehner: 35
 weiteste: 309 (4), 276 (2), 232 (32)
 beste Teiler 7.0 (3.) 36.7 (15.) 40.1 (16.)
 Trefferlage 0.20 mm rechts, 0.04 mm tief
 Streuwert 1.05, horizontal: 1.16, vertikal: 0.92

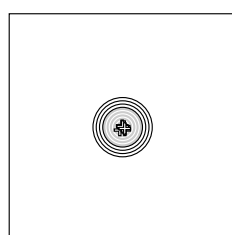
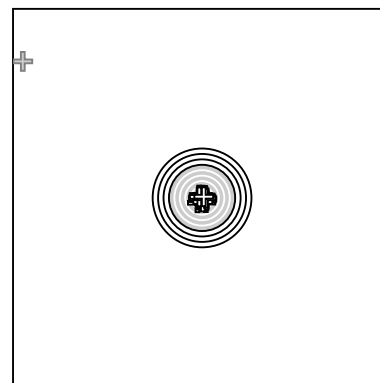

Serie 1:
 10.5 * 9.8 ↘ 10.9 * 9.7 ✓ 10.6 *
 10.4 * 10.4 * 10.1 ↘ 10.7 * 10.2 *
 beste Teiler 7.0 (3.) 55.5 (9.) 100.6 (5.)
 Trefferlage 0.46 mm rechts, 0.45 mm tief
 Streuwert 1.23, horizontal: 1.25, vertikal: 1.22

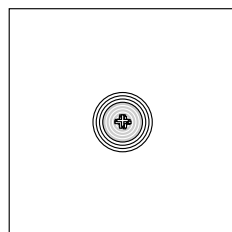

Serie 2:
 10.2 * 10.2 * 10.3 * 10.1 → 10.8 *
 10.8 * 10.3 * 10.4 * 10.4 * 10.5 *
 beste Teiler 36.7 (15.) 40.1 (16.) 119.0 (20.)
 Trefferlage 0.04 mm rechts, 0.40 mm hoch
 Streuwert 1.06, horizontal: 1.30, vertikal: 0.74

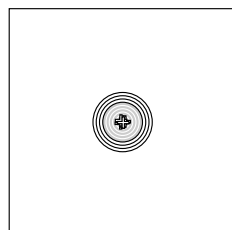

Serie 3:
 10.5 * 10.7 * 10.4 * 10.2 * 10.7 *
 10.7 * 10.3 * 10.7 * 10.2 * 10.7 *
 beste Teiler 58.8 (30.) 62.2 (22.) 63.8 (25.)
 Trefferlage 0.00 mm , 0.04 mm hoch
 Streuwert 0.91, horizontal: 1.12, vertikal: 0.64

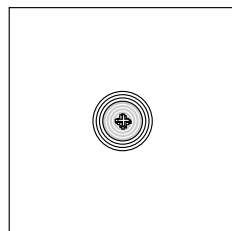

Serie 4:
 10.7 * 10.0 ↘ 10.7 * 10.5 * 10.6 *
 10.5 * 10.2 * 10.4 * 10.2 * 10.6 *
 beste Teiler 59.4 (33.) 71.0 (31.) 82.5 (35.)
 Trefferlage 0.32 mm rechts, 0.16 mm tief
 Streuwert 1.00, horizontal: 1.09, vertikal: 0.91

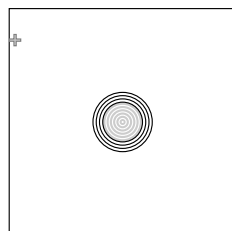

Serie 5:
 0.0F ↘
NSC
 beste Teiler
 Trefferlage 0.00 mm , 0.00 mm
 Streuwert 0.00, horizontal: 0.00, vertikal: 0.00

NSC – Treffer wurde vermessen, geht aber nicht in die Wertung ein

Meyton Elektronik

ISSF AR Mixed Jun – Wertung –

Junioren_m/w

StartNr: 72

StandNr: 131

7. Dezember 2018 16:52

Denes, Eszter #191

HUN / HUN 1

Unterschrift des Schützen

Meyton Elektronik

Ergebnis: **410.0** (392)
 Serien: 103.9 100.6 102.5 103.0
 Zähler: 33 6 1 0 0 0 0 0 0 0
 Innenzehner: 25
 weiteste: 526 (16), 294 (35), 281 (5)
 beste Teiler 51.4 (2.) 63.8 (3.) 74.4 (27.)
 Trefferlage 0.23 mm links, 0.34 mm hoch
 Streuwert 1.37, horizontal: 1.22, vertikal: 1.51

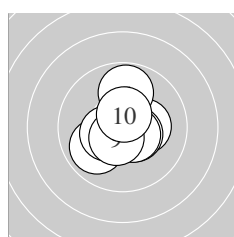
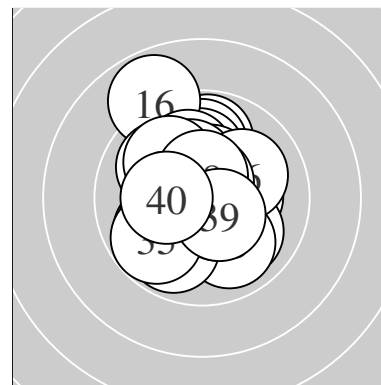

Serie 1:
 9.9 ↙ 10.7 * 10.7 * 10.3 * 9.8 ↑
 10.5 * 10.5 * 10.4 * 10.6 * 10.5 *
 beste Teiler 51.4 (2.) 63.8 (3.) 99.4 (9.)
 Trefferlage 0.01 mm links, 0.09 mm tief
 Streuwert 1.17, horizontal: 1.12, vertikal: 1.21

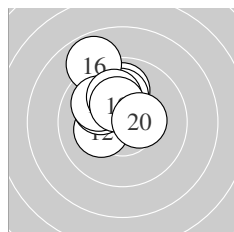

Serie 2:
 10.6 * 10.2 * 9.9 ↑ 10.1 ↑ 10.1 ↘
 8.8 ↘ 10.0 ↘ 10.1 ↘ 10.4 * 10.4 *
 beste Teiler 87.0 (11.) 136.7 (20.) 150.5 (19.)
 Trefferlage 0.77 mm links, 1.60 mm hoch
 Streuwert 1.31, horizontal: 1.15, vertikal: 1.45

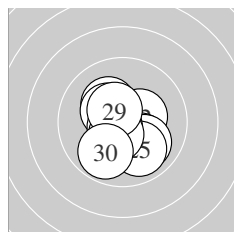

Serie 3:
 10.2 * 10.4 * 10.1 ↘ 10.0 ↘ 9.9 ↘
 10.3 * 10.7 * 10.5 * 10.5 * 9.9 ↙
 beste Teiler 74.4 (27.) 111.8 (28.) 118.4 (29.)
 Trefferlage 0.03 mm rechts, 0.52 mm tief
 Streuwert 1.34, horizontal: 1.27, vertikal: 1.40

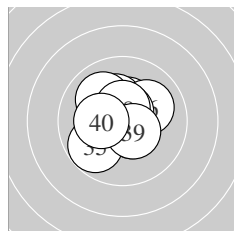

Serie 4:
 10.4 * 10.5 * 10.3 * 10.0 ↘ 9.8 ↙
 10.1 ↗ 10.6 * 10.5 * 10.5 * 10.3 *
 beste Teiler 80.0 (37.) 106.0 (38.) 111.7 (32.)
 Trefferlage 0.18 mm links, 0.40 mm hoch
 Streuwert 1.28, horizontal: 1.32, vertikal: 1.24

Unterschrift des Schützen

Meyton Elektronik

Ergebnis: **417.2** (399)
 Serien: 103.0 104.9 104.8 104.5
 Zähler: 39 1 0 0 0 0 0 0 0 0
 Innenzehner: 35
 weiteste: 308 (10), 229 (6), 218 (7)
 beste Teiler 10.0 (26.) 27.4 (28.) 29.4 (37.)
 Trefferlage 0.05 mm rechts, 0.14 mm tief
 Streuwert 1.02, horizontal: 1.05, vertikal: 1.00

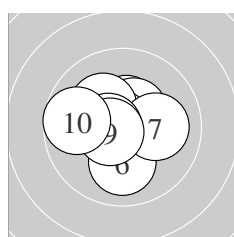
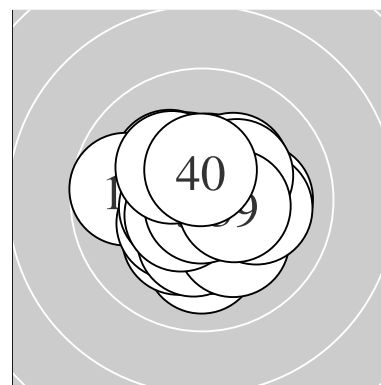

Serie 1:
 10.5 * 10.4 * 10.7 * 10.2 * 10.2 *
 10.0 ↓ 10.1 → 10.6 * 10.6 * 9.7 ←
 beste Teiler 54.2 (3.) 88.6 (9.) 96.0 (8.)
 Trefferlage 0.34 mm links, 0.01 mm tief
 Streuwert 1.31, horizontal: 1.37, vertikal: 1.23

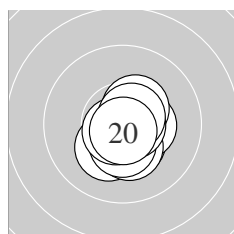

Serie 2:
 10.4 * 10.4 * 10.4 * 10.2 * 10.3 *
 10.4 * 10.7 * 10.7 * 10.6 * 10.8 *
 beste Teiler 45.1 (20.) 62.3 (18.) 64.3 (17.)
 Trefferlage 0.31 mm rechts, 0.51 mm tief
 Streuwert 0.78, horizontal: 0.66, vertikal: 0.87

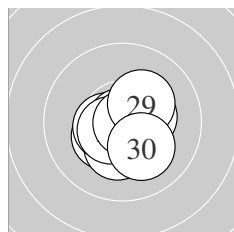

Serie 3:
 10.4 * 10.5 * 10.4 * 10.3 * 10.5 *
 10.9 * 10.6 * 10.8 * 10.3 * 10.1 ↘
 beste Teiler 10.0 (26.) 27.4 (28.) 94.8 (27.)
 Trefferlage 0.06 mm rechts, 0.46 mm tief
 Streuwert 0.93, horizontal: 0.96, vertikal: 0.90

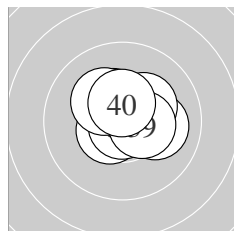

Serie 4:
 10.6 * 10.1 → 10.3 * 10.4 * 10.7 *
 10.5 * 10.8 * 10.2 * 10.4 * 10.5 *
 beste Teiler 29.4 (37.) 67.2 (35.) 96.1 (31.)
 Trefferlage 0.18 mm rechts, 0.41 mm hoch
 Streuwert 0.96, horizontal: 1.11, vertikal: 0.76

Unterschrift des Schützen

Meyton Elektronik

Ergebnis: **412.4** (397)
 Serien: 103.5 102.9 102.4 103.6
 Zähler: 37 3 0 0 0 0 0 0 0 0
 Innenzehner: 30
 weiteste: 356 (30), 348 (25), 298 (36)
 beste Teiler 49.0 (40.) 53.6 (34.) 70.7 (26.)
 Trefferlage 0.28 mm rechts, 0.16 mm hoch
 Streuwert 1.24, horizontal: 1.30, vertikal: 1.17

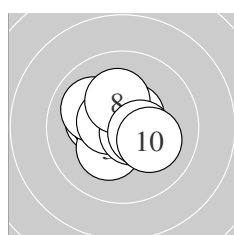
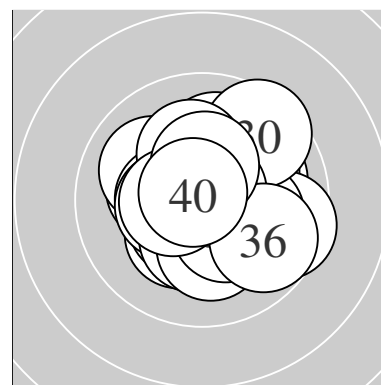

Serie 1:
 10.2 * 10.4 * 10.3 * 10.0 ↘ 10.6 *
 10.6 * 10.7 * 10.2 * 10.4 * 10.1 ↘
 beste Teiler 73.4 (7.) 98.7 (5.) 100.4 (6.)
 Trefferlage 0.29 mm links, 0.20 mm hoch
 Streuwert 1.15, horizontal: 1.31, vertikal: 0.97

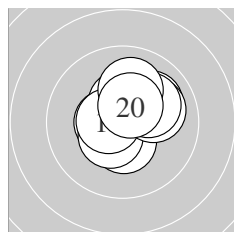

Serie 2:
 10.0 ↗ 10.5 * 10.4 * 10.5 * 10.0 →
 10.1 ↗ 10.4 * 10.6 * 10.0 ↑ 10.4 *
 beste Teiler 96.3 (18.) 111.0 (12.) 123.9 (14.)
 Trefferlage 0.39 mm rechts, 0.58 mm hoch
 Streuwert 1.16, horizontal: 1.21, vertikal: 1.10

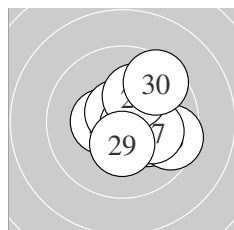

Serie 3:
 10.4 * 10.7 * 10.6 * 10.2 * 9.6 →
 10.7 * 10.1 ↘ 10.2 * 10.4 * 9.5 ↗
 beste Teiler 70.7 (26.) 73.6 (22.) 77.4 (23.)
 Trefferlage 0.96 mm rechts, 0.13 mm hoch
 Streuwert 1.35, horizontal: 1.39, vertikal: 1.32

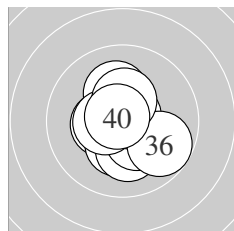

Serie 4:
 10.4 * 10.3 * 10.2 * 10.7 * 10.3 *
 9.8 ↘ 10.2 * 10.5 * 10.4 * 10.8 *
 beste Teiler 49.0 (40.) 53.6 (34.) 119.2 (38.)
 Trefferlage 0.06 mm rechts, 0.25 mm tief
 Streuwert 1.21, horizontal: 1.13, vertikal: 1.30

Unterschrift des Schützen

Meyton Elektronik

Ergebnis: **413.2** (393)
 Serien: 100.9 104.2 103.9 104.2
 Zähler: 33 7 0 0 0 0 0 0 0 0
 Innenzehner: 31
 weiteste: 367 (7), 328 (5), 297 (26)
 beste Teiler 17.4 (25.) 45.0 (20.) 47.9 (38.)
 Trefferlage 0.36 mm links, 0.30 mm tief
 Streuwert 1.23, horizontal: 1.31, vertikal: 1.15

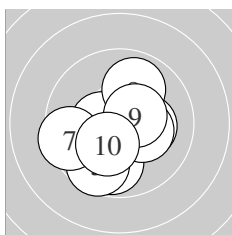
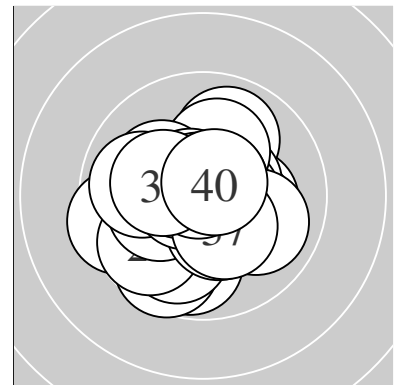

Serie 1:
 10.2 * 9.8 ↓ 10.3 * 10.3 * 9.6 ↙
 10.5 * 9.5 ← 9.9 ↑ 10.5 * 10.3 *
 beste Teiler 122.1 (9.) 125.0 (6.) 159.5 (4.)
 Trefferlage 0.36 mm links, 0.66 mm tief
 Streuwert 1.63, horizontal: 1.70, vertikal: 1.55

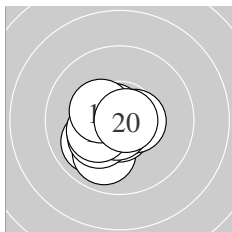

Serie 2:
 10.0 ↙ 9.9 ↙ 10.7 * 10.2 * 10.5 *
 10.7 * 10.7 * 10.3 * 10.4 * 10.8 *
 beste Teiler 45.0 (20.) 57.8 (16.) 61.0 (17.)
 Trefferlage 0.64 mm links, 0.61 mm tief
 Streuwert 0.93, horizontal: 0.96, vertikal: 0.89

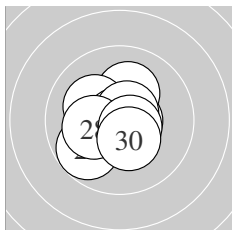

Serie 3:
 10.3 * 10.6 * 10.2 * 10.2 * 10.9 *
 9.8 ↙ 10.7 * 10.2 * 10.6 * 10.4 *
 beste Teiler 17.4 (25.) 72.8 (27.) 80.0 (22.)
 Trefferlage 0.22 mm links, 0.07 mm hoch
 Streuwert 1.22, horizontal: 1.21, vertikal: 1.22

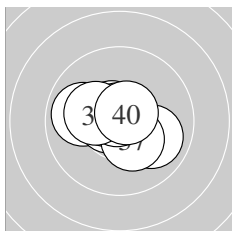

Serie 4:
 9.9 ← 10.7 * 10.5 * 10.0 ↘ 10.5 *
 10.6 * 10.3 * 10.8 * 10.2 * 10.7 *
 beste Teiler 47.9 (38.) 74.0 (32.) 75.2 (40.)
 Trefferlage 0.21 mm links, 0.01 mm tief
 Streuwert 1.13, horizontal: 1.40, vertikal: 0.75

Unterschrift des Schützen

Ergebnis: **414.8** (396)
 Serien: 102.6 103.7 103.9 104.6
 Zähler: 36 4 0 0 0 0 0 0 0 0
 Innenzehner: 30
 weiteste: 281 (3), 262 (40), 254 (11)
 beste Teiler 19.7 (38.) 51.1 (21.) 57.9 (31.)
 Trefferlage 0.11 mm rechts, 0.16 mm hoch
 Streuwert 1.14, horizontal: 1.30, vertikal: 0.94

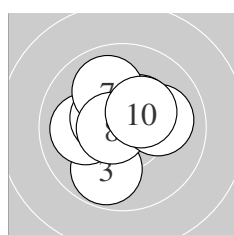
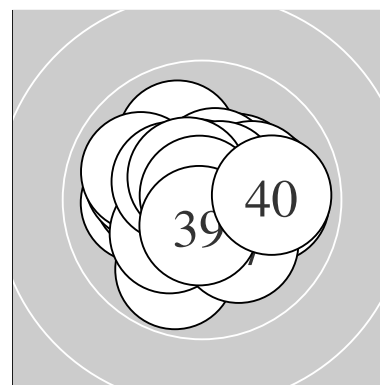

Serie 1:
 10.5 * 10.3 * 9.8 ↙ 10.0 ← 10.4 *
 10.5 * 10.0 ↖ 10.7 * 10.0 → 10.4 *
 beste Teiler 66.2 (8.) 119.8 (1.) 121.3 (6.)
 Trefferlage 0.38 mm links, 0.35 mm hoch
 Streuwert 1.34, horizontal: 1.40, vertikal: 1.27

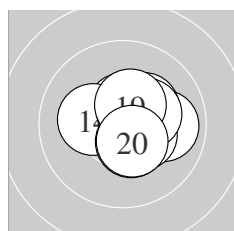

Serie 2:
 9.9 → 10.6 * 10.4 * 10.2 * 10.6 *
 10.5 * 10.3 * 10.3 * 10.4 * 10.5 *
 beste Teiler 90.5 (15.) 97.0 (12.) 122.6 (20.)
 Trefferlage 0.69 mm rechts, 0.18 mm hoch
 Streuwert 1.01, horizontal: 1.14, vertikal: 0.87

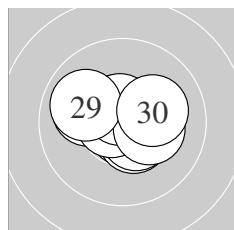

Serie 3:
 10.7 * 10.6 * 10.5 * 10.5 * 10.0 ↖
 10.7 * 10.6 * 10.3 * 9.9 ↖ 10.1 →
 beste Teiler 51.1 (21.) 69.0 (26.) 80.8 (27.)
 Trefferlage 0.05 mm links, 0.13 mm hoch
 Streuwert 1.14, horizontal: 1.42, vertikal: 0.76

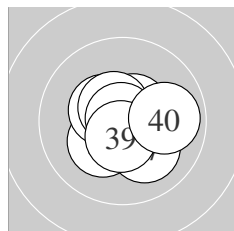

Serie 4:
 10.7 * 10.2 * 10.7 * 10.4 * 10.6 *
 10.5 * 10.1 ↘ 10.9 * 10.6 * 9.9 →
 beste Teiler 19.7 (38.) 57.9 (31.) 65.6 (33.)
 Trefferlage 0.20 mm rechts, 0.01 mm tief
 Streuwert 1.05, horizontal: 1.16, vertikal: 0.92

Unterschrift des Schützen

Meyton Elektronik

Ergebnis: **405.5** (388)
 Serien: 100.9 101.8 100.0 102.8
 Zähler: 28 12 0 0 0 0 0 0 0 0
 Innenzehner: 22
 weiteste: 450 (26), 446 (1), 412 (22)
 beste Teiler 73.9 (34.) 74.8 (18.) 80.6 (35.)
 Trefferlage 0.02 mm rechts, 0.02 mm tief
 Streuwert 1.62, horizontal: 1.73, vertikal: 1.51

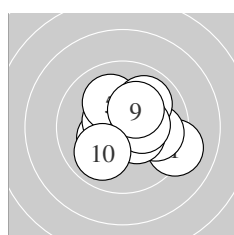
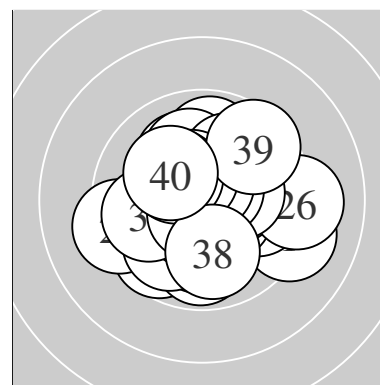

Serie 1:
 9.2 → 9.9 → 10.3 * 10.5 * 10.1 ↗
 10.4 * 10.0 ↗ 10.3 * 10.3 * 9.9 ↘
 beste Teiler 109.5 (4.) 130.3 (6.) 154.9 (8.)
 Trefferlage 0.72 mm rechts, 0.03 mm hoch
 Streuwert 1.67, horizontal: 1.91, vertikal: 1.38

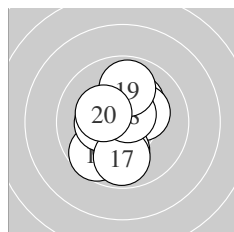

Serie 2:
 10.2 * 10.5 * 10.3 * 9.7 ↘ 10.1 ↓
 10.3 * 9.8 ↓ 10.7 * 9.9 ↑ 10.3 *
 beste Teiler 74.8 (18.) 109.6 (12.) 159.3 (16.)
 Trefferlage 0.11 mm links, 0.04 mm tief
 Streuwert 1.55, horizontal: 1.21, vertikal: 1.83

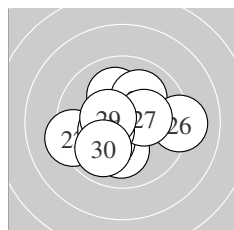

Serie 3:
 10.1 ↓ 9.3 ← 10.1 ↗ 10.0 ↗ 10.2 *
 9.2 → 10.3 * 10.4 * 10.5 * 9.9 ↘
 beste Teiler 119.9 (29.) 146.6 (28.) 172.5 (27.)
 Trefferlage 0.24 mm links, 0.31 mm tief
 Streuwert 1.94, horizontal: 2.28, vertikal: 1.52

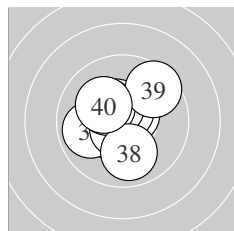

Serie 4:
 10.6 * 10.5 * 9.9 ← 10.7 * 10.6 *
 10.5 * 10.3 * 9.9 ↓ 9.6 ↗ 10.2 *
 beste Teiler 73.9 (34.) 80.6 (35.) 86.6 (31.)
 Trefferlage 0.27 mm links, 0.24 mm hoch
 Streuwert 1.40, horizontal: 1.37, vertikal: 1.44

Unterschrift des Schützen

Meyton Elektronik

Ergebnis: **414.4** (397)
 Serien: 103.1 103.8 102.7 104.8
 Zähler: 37 3 0 0 0 0 0 0 0 0
 Innenzehner: 32
 weiteste: 313 (1), 309 (24), 254 (8)
 beste Teiler 24.5 (6.) 34.3 (22.) 68.0 (40.)
 Trefferlage 0.19 mm links, 0.02 mm hoch
 Streuwert 1.14, horizontal: 1.15, vertikal: 1.13

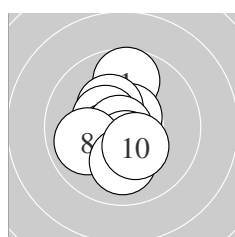
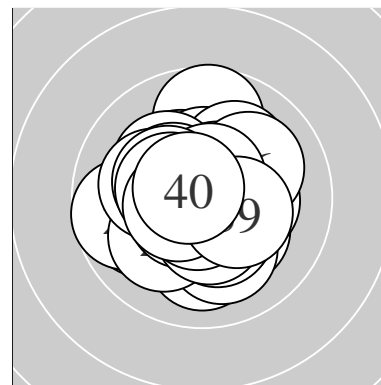

Serie 1:
 9.7 ↑ 10.6 * 10.3 * 10.4 * 10.5 *
 10.9 * 10.5 * 9.9 ← 10.0 ↓ 10.3 *
 beste Teiler 24.5 (6.) 79.7 (2.) 110.1 (5.)
 Trefferlage 0.38 mm links, 0.06 mm tief
 Streuwert 1.28, horizontal: 0.95, vertikal: 1.55

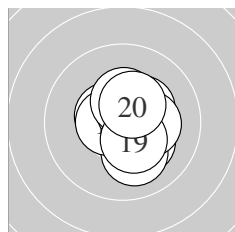

Serie 2:
 10.5 * 10.2 * 10.1 ↓ 10.3 * 10.6 *
 10.6 * 10.3 * 10.4 * 10.4 * 10.4 *
 beste Teiler 90.9 (16.) 92.0 (15.) 107.5 (11.)
 Trefferlage 0.51 mm rechts, 0.00 mm
 Streuwert 1.04, horizontal: 0.90, vertikal: 1.16

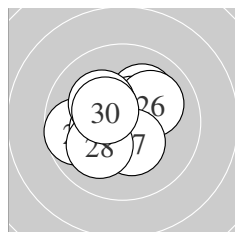

Serie 3:
 10.1 ↗ 10.8 * 10.5 * 9.7 ← 10.4 *
 10.1 ↗ 10.4 * 10.1 ↗ 10.2 * 10.4 *
 beste Teiler 34.3 (22.) 103.0 (23.) 140.6 (30.)
 Trefferlage 0.40 mm links, 0.20 mm hoch
 Streuwert 1.35, horizontal: 1.53, vertikal: 1.14

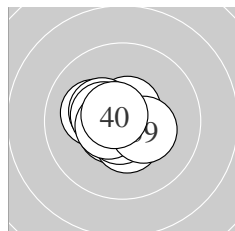

Serie 4:
 10.6 * 10.2 * 10.4 * 10.6 * 10.3 *
 10.7 * 10.4 * 10.6 * 10.3 * 10.7 *
 beste Teiler 68.0 (40.) 68.6 (36.) 82.8 (34.)
 Trefferlage 0.49 mm links, 0.06 mm tief
 Streuwert 0.85, horizontal: 0.99, vertikal: 0.69

Unterschrift des Schützen

Meyton Elektronik

Ergebnis: **411.2** (394)
 Serien: 104.6 103.1 101.4 102.1
 Zähler: 34 6 0 0 0 0 0 0 0 0
 Innenzehner: 28
 weiteste: 387 (22), 368 (33), 351 (24)
 beste Teiler 7.6 (23.) 9.4 (1.) 28.6 (7.)
 Trefferlage 0.18 mm links, 0.04 mm hoch
 Streuwert 1.36, horizontal: 1.54, vertikal: 1.15

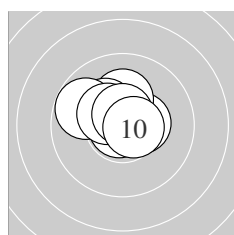
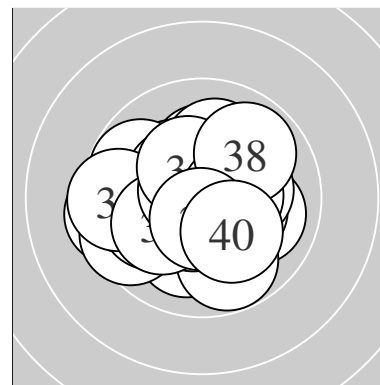

Serie 1:
 10.9 * 10.4 * 10.2 * 10.6 * 10.3 *
 9.8 ↖ 10.8 * 10.4 * 10.6 * 10.6 *
 beste Teiler 9.4 (1.) 28.6 (7.) 80.0 (9.)
 Trefferlage 0.40 mm links, 0.64 mm hoch
 Streuwert 0.93, horizontal: 1.13, vertikal: 0.67

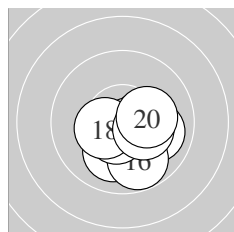

Serie 2:
 10.4 * 10.1 ↓ 10.0 → 10.7 * 10.6 *
 9.8 ↓ 10.6 * 10.4 * 10.3 * 10.2 *
 beste Teiler 65.7 (14.) 91.6 (15.) 94.4 (17.)
 Trefferlage 0.68 mm rechts, 0.80 mm tief
 Streuwert 1.06, horizontal: 1.17, vertikal: 0.92

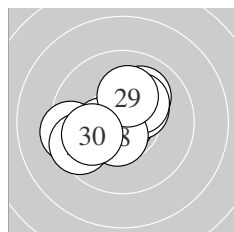

Serie 3:
 10.0 ↗ 9.4 ← 10.9 * 9.5 ← 10.3 *
 10.4 * 10.2 * 10.5 * 10.2 * 10.0 ←
 beste Teiler 7.6 (23.) 105.1 (28.) 149.9 (26.)
 Trefferlage 0.69 mm links, 0.13 mm hoch
 Streuwert 1.60, horizontal: 1.87, vertikal: 1.28

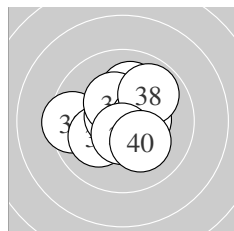

Serie 4:
 10.1 ↑ 10.2 * 9.5 ← 10.1 ← 10.7 *
 10.4 * 10.4 * 9.9 ↗ 10.6 * 10.2 *
 beste Teiler 66.8 (35.) 93.1 (39.) 133.4 (37.)
 Trefferlage 0.34 mm links, 0.21 mm hoch
 Streuwert 1.51, horizontal: 1.73, vertikal: 1.25

Unterschrift des Schützen

Meyton Elektronik

Ergebnis: **411.8** (393)
 Serien: 104.3 102.7 102.5 102.3
 Zähler: 33 7 0 0 0 0 0 0 0 0
 Innenzehner: 31
 weiteste: 318 (15), 299 (21), 293 (36)
 beste Teiler 47.1 (27.) 72.6 (14.) 72.9 (29.)
 Trefferlage 0.63 mm links, 0.67 mm hoch
 Streuwert 1.09, horizontal: 1.19, vertikal: 0.98

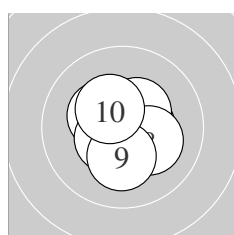
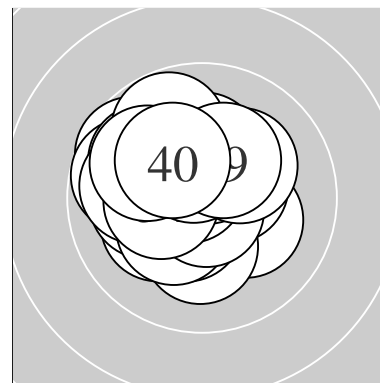

Serie 1:
 10.3 * 10.6 * 10.6 * 10.5 * 10.6 *
 10.5 * 10.4 * 10.2 * 10.2 * 10.4 *
 beste Teiler 79.2 (2.) 92.6 (3.) 99.0 (5.)
 Trefferlage 0.12 mm rechts, 0.16 mm hoch
 Streuwert 1.00, horizontal: 1.01, vertikal: 0.99

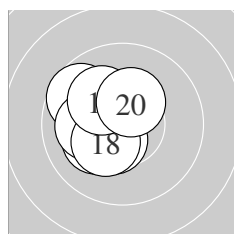

Serie 2:
 10.5 * 10.2 * 10.3 * 10.7 * 9.7 ↖
 10.5 * 10.1 ← 10.3 * 10.1 ↘ 10.3 *
 beste Teiler 72.6 (14.) 118.5 (16.) 124.9 (11.)
 Trefferlage 1.13 mm links, 0.38 mm hoch
 Streuwert 1.03, horizontal: 0.93, vertikal: 1.13

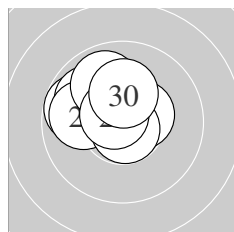

Serie 3:
 9.8 ↖ 9.9 ↖ 10.6 * 10.2 * 10.5 *
 9.9 ← 10.8 * 9.9 ↘ 10.7 * 10.2 *
 beste Teiler 47.1 (27.) 72.9 (29.) 96.5 (23.)
 Trefferlage 0.87 mm links, 0.92 mm hoch
 Streuwert 1.14, horizontal: 1.40, vertikal: 0.81

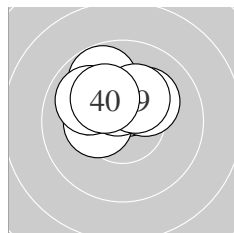

Serie 4:
 10.3 * 10.4 * 10.5 * 10.3 * 10.4 *
 9.8 ↘ 10.2 * 9.9 ↖ 10.3 * 10.2 *
 beste Teiler 125.6 (33.) 128.4 (32.) 132.1 (35.)
 Trefferlage 0.64 mm links, 1.22 mm hoch
 Streuwert 0.95, horizontal: 1.15, vertikal: 0.69

Unterschrift des Schützen

Meyton Elektronik

Ergebnis: **406.0** (389)
 Serien: 100.7 101.6 102.0 101.7
 Zähler: 29 11 0 0 0 0 0 0 0 0
 Innenzehner: 25
 weiteste: 468 (4), 457 (35), 431 (10)
 beste Teiler 52.3 (29.) 54.4 (37.) 64.4 (8.)
 Trefferlage 0.20 mm rechts, 0.49 mm hoch
 Streuwert 1.57, horizontal: 1.87, vertikal: 1.21

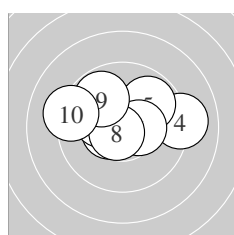
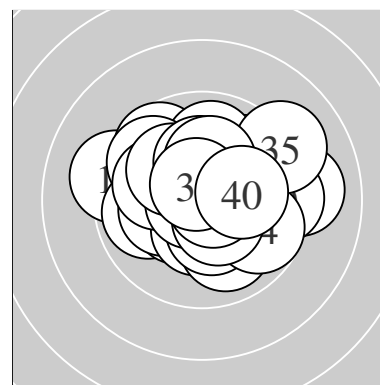

Serie 1:
 10.5 * 10.5 * 10.5 * 9.1 → 9.8 ↗
 10.4 * 10.2 * 10.7 * 9.8 ↘ 9.2 ←
 beste Teiler 64.4 (8.) 112.9 (2.) 115.4 (1.)
 Trefferlage 0.09 mm links, 0.77 mm hoch
 Streuwert 1.82, horizontal: 2.41, vertikal: 0.90

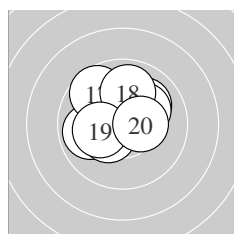

Serie 2:
 9.9 ← 10.2 * 10.0 ↗ 10.2 * 10.7 *
 10.4 * 9.7 ↘ 9.9 ↑ 10.2 * 10.4 *
 beste Teiler 68.1 (15.) 144.2 (16.) 145.0 (20.)
 Trefferlage 0.41 mm links, 0.71 mm hoch
 Streuwert 1.45, horizontal: 1.61, vertikal: 1.27

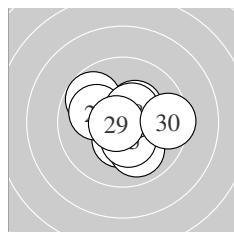

Serie 3:
 10.4 * 10.4 * 10.2 * 10.0 ↘ 10.4 *
 9.8 ↘ 10.1 ← 10.5 * 10.7 * 9.5 →
 beste Teiler 52.3 (29.) 117.9 (28.) 143.8 (21.)
 Trefferlage 0.37 mm rechts, 0.09 mm tief
 Streuwert 1.56, horizontal: 1.80, vertikal: 1.29

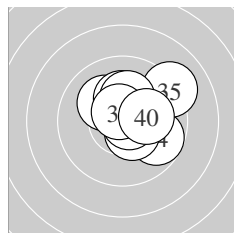

Serie 4:
 10.1 ↘ 10.2 * 10.4 * 9.7 ↘ 9.1 ↗
 10.5 * 10.7 * 10.2 * 10.6 * 10.2 *
 beste Teiler 54.4 (37.) 80.0 (39.) 121.3 (36.)
 Trefferlage 0.95 mm rechts, 0.58 mm hoch
 Streuwert 1.42, horizontal: 1.53, vertikal: 1.31

Unterschrift des Schützen

Meyton Elektronik

Ergebnis: **411.3** (388)
 Serien: 102.7 102.4 103.5 102.7
 Zähler: 28 12 0 0 0 0 0 0 0 0
 Innenzehner: 25
 weiteste: 418 (16), 328 (15), 313 (17)
 beste Teiler 22.0 (18.) 38.8 (38.) 51.6 (13.)
 Trefferlage 0.24 mm rechts, 0.45 mm hoch
 Streuwert 1.34, horizontal: 1.64, vertikal: 0.96

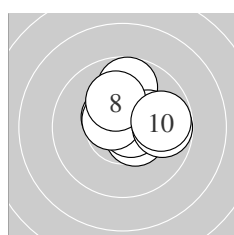
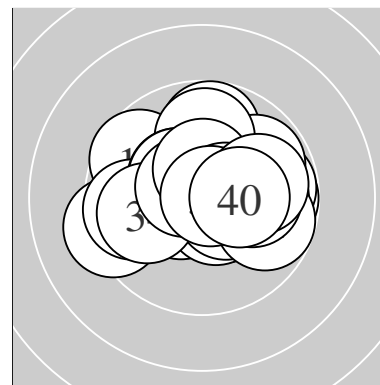

Serie 1:
 10.7 * 10.5 * 10.5 * 9.8 ↑ 10.2 *
 10.7 * 10.6 * 10.1 † 9.8 → 9.8 →
 beste Teiler 63.0 (6.) 74.6 (1.) 95.6 (7.)
 Trefferlage 0.82 mm rechts, 0.64 mm hoch
 Streuwert 1.24, horizontal: 1.39, vertikal: 1.07

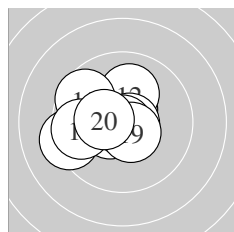

Serie 2:
 10.6 * 10.1 † 10.7 * 10.5 * 9.6 ↘
 9.3 ← 9.7 ← 10.9 * 10.6 * 10.4 *
 beste Teiler 22.0 (18.) 51.6 (13.) 96.3 (11.)
 Trefferlage 1.02 mm links, 0.15 mm hoch
 Streuwert 1.44, horizontal: 1.72, vertikal: 1.10

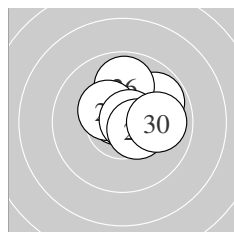

Serie 3:
 10.5 * 10.7 * 10.7 * 9.8 ↗ 10.4 *
 9.9 ↑ 10.4 * 10.7 * 10.5 * 9.9 →
 beste Teiler 52.8 (28.) 61.8 (23.) 64.3 (22.)
 Trefferlage 0.51 mm rechts, 0.81 mm hoch
 Streuwert 1.05, horizontal: 1.18, vertikal: 0.90

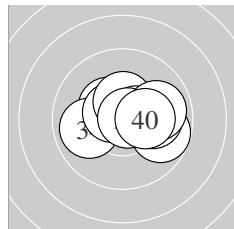

Serie 4:
 10.4 * 9.8 → 10.1 → 9.9 ← 10.6 *
 10.4 * 10.5 * 10.8 * 9.9 → 10.3 *
 beste Teiler 38.8 (38.) 90.1 (35.) 106.5 (37.)
 Trefferlage 0.64 mm rechts, 0.20 mm hoch
 Streuwert 1.32, horizontal: 1.73, vertikal: 0.68

Unterschrift des Schützen

Meyton Elektronik

Ergebnis: **405.6** (385)
 Serien: 102.5 102.4 101.1 99.6
 Zähler: 25 15 0 0 0 0 0 0 0 0
 Innenzehner: 19
 weiteste: 429 (34), 418 (38), 385 (37)
 beste Teiler 41.6 (12.) 43.4 (15.) 49.2 (22.)
 Trefferlage 0.05 mm links, 0.31 mm hoch
 Streuwert 1.66, horizontal: 1.63, vertikal: 1.69

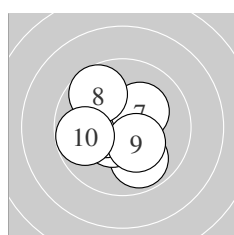
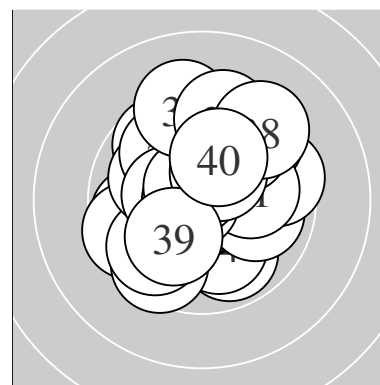

Serie 1:
 10.7 * 9.9 ↘ 10.5 * 10.6 * 10.4 *
 10.4 * 10.2 * 9.7 ↘ 10.3 * 9.8 ←
 beste Teiler 70.2 (1.) 89.8 (4.) 113.8 (3.)
 Trefferlage 0.56 mm links, 0.00 mm
 Streuwert 1.39, horizontal: 1.39, vertikal: 1.38

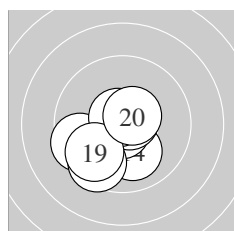

Serie 2:
 10.0 ↙ 10.8 * 9.5 ← 10.1 ↘ 10.8 *
 9.5 ↙ 10.7 * 10.7 * 9.7 ↙ 10.6 *
 beste Teiler 41.6 (12.) 43.4 (15.) 59.4 (17.)
 Trefferlage 0.67 mm links, 1.00 mm tief
 Streuwert 1.34, horizontal: 1.39, vertikal: 1.28

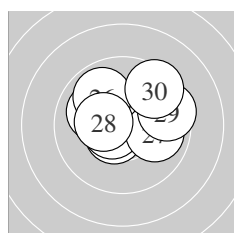

Serie 3:
 10.6 * 10.8 * 10.0 ↖ 10.6 * 9.9 →
 9.9 ↘ 9.9 → 10.4 * 9.5 → 9.5 ↗
 beste Teiler 49.2 (22.) 87.3 (24.) 97.0 (21.)
 Trefferlage 0.39 mm rechts, 0.62 mm hoch
 Streuwert 1.68, horizontal: 2.08, vertikal: 1.15

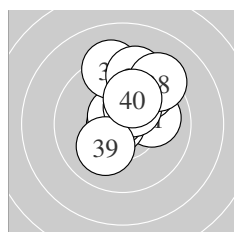

Serie 4:
 10.0 → 10.7 * 10.7 * 9.2 ↑ 9.7 ↗
 10.4 * 9.4 ↑ 9.3 ↗ 10.1 ↙ 10.1 ↑
 beste Teiler 52.0 (32.) 75.0 (33.) 148.0 (36.)
 Trefferlage 0.60 mm rechts, 1.63 mm hoch
 Streuwert 1.63, horizontal: 1.37, vertikal: 1.85

Unterschrift des Schützen

Meyton Elektronik

Ergebnis: **410.9** (391)
 Serien: 100.8 103.0 103.4 103.7
 Zähler: 31 9 0 0 0 0 0 0 0 0
 Innenzehner: 27
 weiteste: 432 (3), 315 (33), 309 (5)
 beste Teiler 42.7 (13.) 44.4 (8.) 49.4 (2.)
 Trefferlage 0.25 mm rechts, 0.06 mm tief
 Streuwert 1.36, horizontal: 1.27, vertikal: 1.44

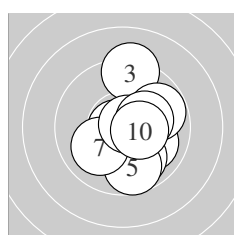
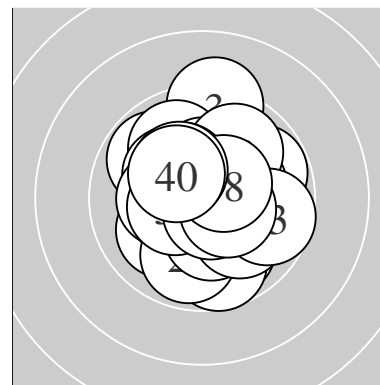

Serie 1:
 10.0 ↘ 10.8 * 9.2 ↑ 9.9 ↘ 9.7 ↘
 9.8 ↗ 10.0 ↙ 10.8 * 10.2 * 10.4 *
 beste Teiler 44.4 (8.) 49.4 (2.) 133.0 (10.)
 Trefferlage 0.84 mm rechts, 0.20 mm tief
 Streuwert 1.70, horizontal: 1.28, vertikal: 2.04

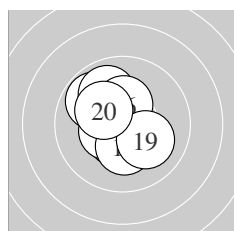

Serie 2:
 9.8 ↖ 9.9 ↖ 10.8 * 10.6 * 10.5 *
 10.4 * 10.4 * 10.3 * 10.1 ↘ 10.2 *
 beste Teiler 42.7 (13.) 82.2 (14.) 113.5 (15.)
 Trefferlage 0.42 mm links, 0.17 mm hoch
 Streuwert 1.27, horizontal: 1.14, vertikal: 1.39

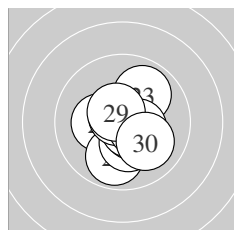

Serie 3:
 10.3 * 9.9 ↓ 9.9 ↗ 10.3 * 10.5 *
 10.7 * 10.7 * 10.5 * 10.6 * 10.0 ↘
 beste Teiler 58.7 (27.) 75.0 (26.) 91.8 (29.)
 Trefferlage 0.29 mm rechts, 0.40 mm tief
 Streuwert 1.23, horizontal: 1.10, vertikal: 1.35

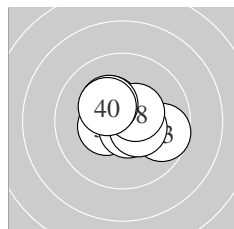

Serie 4:
 10.4 * 10.6 * 9.7 ↗ 10.5 * 10.7 *
 10.3 * 10.4 * 10.5 * 10.3 * 10.3 *
 beste Teiler 73.4 (35.) 94.5 (32.) 102.4 (34.)
 Trefferlage 0.30 mm rechts, 0.17 mm hoch
 Streuwert 1.15, horizontal: 1.39, vertikal: 0.85

Unterschrift des Schützen

Meyton Elektronik

Ergebnis: **410.1** (391)
 Serien: 102.0 102.1 102.8 103.2
 Zähler: 31 9 0 0 0 0 0 0 0 0
 Innenzehner: 25
 weiteste: 463 (13), 435 (20), 330 (38)
 beste Teiler 4.2 (25.) 35.8 (19.) 53.7 (28.)
 Trefferlage 0.29 mm links, 0.59 mm hoch
 Streuwert 1.36, horizontal: 1.50, vertikal: 1.20

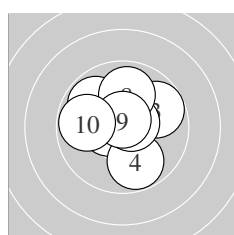
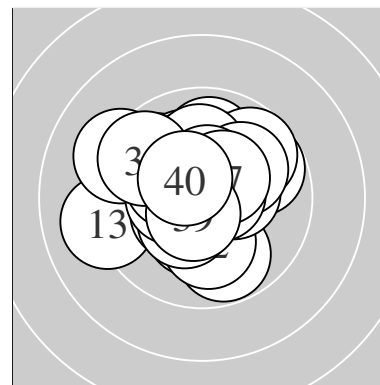

Serie 1:
 10.4 * 10.5 * 9.8 ↗ 9.8 ↘ 9.8 ↖
 10.7 * 10.6 * 9.9 ↑ 10.7 * 9.8 ←
 beste Teiler 59.0 (9.) 60.9 (6.) 76.4 (7.)
 Trefferlage 0.22 mm links, 0.54 mm hoch
 Streuwert 1.50, horizontal: 1.61, vertikal: 1.38

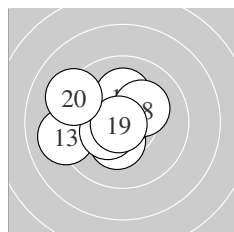

Serie 2:
 10.7 * 10.7 * 9.1 ← 10.3 * 10.6 *
 10.4 * 10.1 ↑ 10.2 * 10.8 * 9.2 ↖
 beste Teiler 35.8 (19.) 60.5 (11.) 65.4 (12.)
 Trefferlage 0.85 mm links, 0.33 mm hoch
 Streuwert 1.59, horizontal: 1.89, vertikal: 1.22

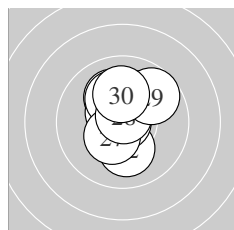

Serie 3:
 10.1 ↗ 10.1 ↓ 10.1 ↖ 10.5 * 10.9 *
 10.2 * 10.4 * 10.7 * 9.7 ↗ 10.1 ↑
 beste Teiler 4.2 (25.) 53.7 (28.) 104.6 (24.)
 Trefferlage 0.03 mm rechts, 0.80 mm hoch
 Streuwert 1.25, horizontal: 0.98, vertikal: 1.48

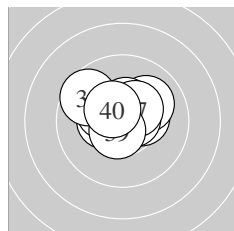

Serie 4:
 10.3 * 10.4 * 10.3 * 10.0 ↗ 10.5 *
 10.6 * 10.4 * 9.6 ↖ 10.6 * 10.5 *
 beste Teiler 80.0 (36.) 85.9 (39.) 123.3 (40.)
 Trefferlage 0.14 mm links, 0.68 mm hoch
 Streuwert 1.17, horizontal: 1.46, vertikal: 0.76

Unterschrift des Schützen

Meyton Elektronik

Ergebnis: **405.6** (387)
 Serien: 102.3 100.9 100.8 101.6
 Zähler: 27 13 0 0 0 0 0 0 0 0
 Innenzehner: 21
 weiteste: 397 (16), 372 (15), 349 (27)
 beste Teiler 49.0 (20.) 50.9 (4.) 66.4 (18.)
 Trefferlage 0.05 mm links, 0.29 mm hoch
 Streuwert 1.60, horizontal: 1.53, vertikal: 1.66

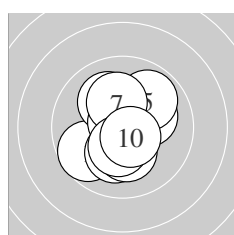
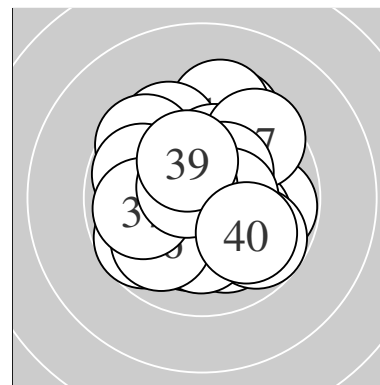

Serie 1:
 9.7 ↙ 10.2 * 10.1 ↘ 10.8 * 9.9 ↗
 10.2 * 10.2 * 10.2 * 10.4 * 10.6 *
 beste Teiler 50.9 (4.) 92.4 (10.) 144.3 (9.)
 Trefferlage 0.07 mm links, 0.07 mm tief
 Streuwert 1.48, horizontal: 1.31, vertikal: 1.63

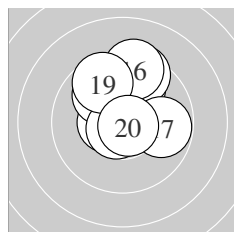

Serie 2:
 10.7 * 10.5 * 9.9 ↑ 10.0 ↘ 9.5 ↑
 9.4 ↑ 9.8 → 10.7 * 9.6 ↘ 10.8 *
 beste Teiler 49.0 (20.) 66.4 (18.) 69.1 (11.)
 Trefferlage 0.24 mm rechts, 1.35 mm hoch
 Streuwert 1.58, horizontal: 1.39, vertikal: 1.76

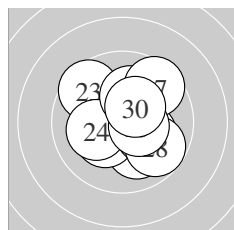

Serie 3:
 10.1 ↘ 10.3 * 9.6 ↘ 10.1 ← 10.2 *
 10.2 * 9.6 ↗ 9.8 ↘ 10.5 * 10.4 *
 beste Teiler 123.4 (29.) 146.3 (30.) 170.0 (22.)
 Trefferlage 0.45 mm rechts, 0.14 mm hoch
 Streuwert 1.73, horizontal: 1.75, vertikal: 1.71

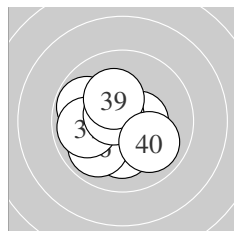

Serie 4:
 10.2 * 10.5 * 10.4 * 9.8 ↘ 10.1 ←
 9.9 ↙ 9.9 ← 10.6 * 10.2 * 10.0 ↘
 beste Teiler 82.4 (38.) 115.0 (32.) 127.7 (33.)
 Trefferlage 0.84 mm links, 0.25 mm tief
 Streuwert 1.41, horizontal: 1.54, vertikal: 1.25

Unterschrift des Schützen

Meyton Elektronik

Ergebnis: **409.1** (391)
 Serien: 101.0 103.4 103.1 101.6
 Zähler: 31 9 0 0 0 0 0 0 0 0
 Innenzehner: 25
 weiteste: 363 (3), 358 (6), 340 (31)
 beste Teiler 27.0 (35.) 29.8 (22.) 55.8 (24.)
 Trefferlage 0.22 mm links, 0.21 mm tief
 Streuwert 1.43, horizontal: 1.56, vertikal: 1.28

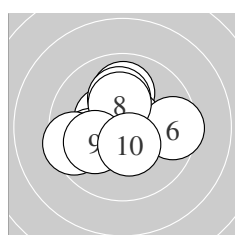
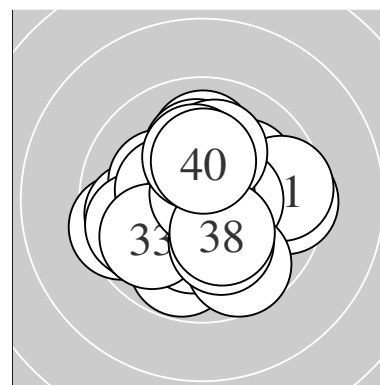

Serie 1:
 10.4 * 10.0 ← 9.5 ← 10.0 ↑ 10.7 *
 9.5 → 10.1 ↑ 10.3 * 10.1 ← 10.4 *
 beste Teiler 67.2 (5.) 131.6 (10.) 136.4 (1.)
 Trefferlage 0.46 mm links, 0.28 mm hoch
 Streuwert 1.68, horizontal: 1.92, vertikal: 1.40

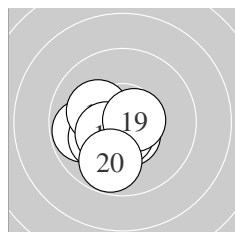

Serie 2:
 9.8 ← 10.6 * 10.2 * 10.7 * 10.2 *
 10.5 * 10.6 * 10.4 * 10.6 * 9.8 ↓
 beste Teiler 57.3 (14.) 83.1 (19.) 85.0 (17.)
 Trefferlage 0.74 mm links, 0.76 mm tief
 Streuwert 1.02, horizontal: 1.12, vertikal: 0.90

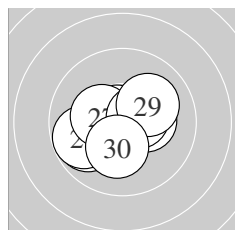

Serie 3:
 9.8 ← 10.8 * 9.8 ← 10.7 * 10.3 *
 10.6 * 10.3 * 10.5 * 10.1 ↗ 10.2 *
 beste Teiler 29.8 (22.) 55.8 (24.) 81.6 (26.)
 Trefferlage 0.29 mm links, 0.24 mm tief
 Streuwert 1.30, horizontal: 1.58, vertikal: 0.93

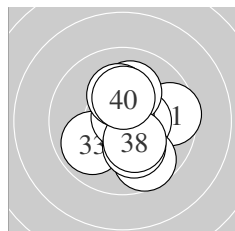

Serie 4:
 9.6 → 10.5 * 9.9 ← 9.7 ↓ 10.8 *
 10.2 * 10.1 ↑ 10.3 * 10.2 * 10.3 *
 beste Teiler 27.0 (35.) 123.0 (32.) 165.1 (38.)
 Trefferlage 0.60 mm rechts, 0.12 mm tief
 Streuwert 1.56, horizontal: 1.42, vertikal: 1.69

Unterschrift des Schützen

Meyton Elektronik

Ergebnis: **411.8** (393)
 Serien: 102.4 102.9 103.6 102.9
 Zähler: 33 7 0 0 0 0 0 0 0 0
 Innenzehner: 24
 weiteste: 344 (37), 297 (8), 289 (27)
 beste Teiler 19.8 (25.) 27.4 (35.) 48.5 (40.)
 Trefferlage 0.14 mm links, 0.04 mm hoch
 Streuwert 1.33, horizontal: 1.44, vertikal: 1.22

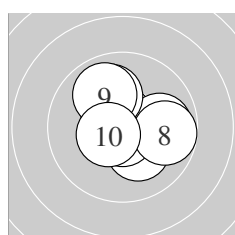
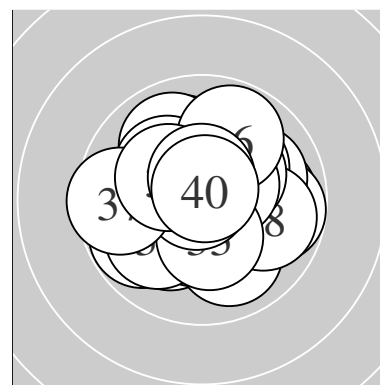

Serie 1:
 10.6 * 10.1 ↗ 10.7 * 10.2 * 10.7 *
 9.9 → 10.0 ↗ 9.8 → 9.9 ↗ 10.5 *
 beste Teiler 51.0 (5.) 66.7 (3.) 91.9 (1.)
 Trefferlage 0.18 mm rechts, 0.48 mm hoch
 Streuwert 1.41, horizontal: 1.52, vertikal: 1.29

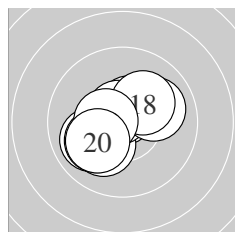

Serie 2:
 10.5 * 10.0 ↙ 10.7 * 10.1 ↙ 10.7 *
 10.1 ↙ 10.0 → 10.2 * 10.5 * 10.1 ↙
 beste Teiler 66.0 (13.) 73.9 (15.) 110.9 (11.)
 Trefferlage 0.44 mm links, 0.06 mm tief
 Streuwert 1.31, horizontal: 1.46, vertikal: 1.15

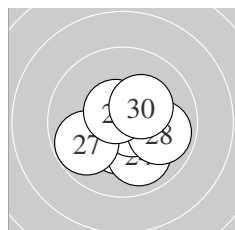

Serie 3:
 10.6 * 10.4 * 10.4 * 10.0 ↘ 10.9 *
 10.7 * 9.8 ↙ 9.9 → 10.6 * 10.3 *
 beste Teiler 19.8 (25.) 68.4 (26.) 85.0 (21.)
 Trefferlage 0.25 mm rechts, 0.62 mm tief
 Streuwert 1.21, horizontal: 1.35, vertikal: 1.05

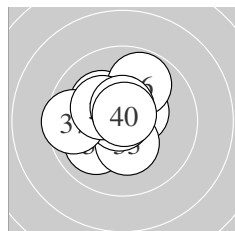

Serie 4:
 10.5 * 10.0 ↙ 10.3 * 10.2 * 10.8 *
 9.8 ↗ 9.6 ← 10.3 * 10.6 * 10.8 *
 beste Teiler 27.4 (35.) 48.5 (40.) 95.0 (39.)
 Trefferlage 0.58 mm links, 0.39 mm hoch
 Streuwert 1.34, horizontal: 1.44, vertikal: 1.23

Unterschrift des Schützen

Meyton Elektronik