

Ergebnis: **395.7** (378)
 Serien: 102.3 98.1 100.3 95.0
 Zähler: 21 16 3 0 0 0 0 0 0 0
 Innenzehner: 16
 weiteste: 655 (35), 604 (16), 523 (20)
 beste Teiler 30.8 (30.) 68.0 (2.) 82.1 (9.)
 Trefferlage 0.92 mm links, 0.46 mm hoch
 Streuwert 2.03, horizontal: 2.22, vertikal: 1.82

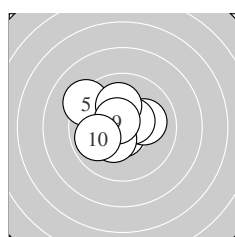

Serie 1:
 10.2 * 10.7 * 10.1 → 10.6 * 9.2 ↘
 10.5 * 10.1 ↑ 10.4 * 10.6 * 9.9 ←
 beste Teiler 68.0 (2.) 82.1 (9.) 91.2 (4.)
 Trefferlage 0.69 mm links, 0.41 mm hoch
 Streuwert 1.42, horizontal: 1.58, vertikal: 1.24

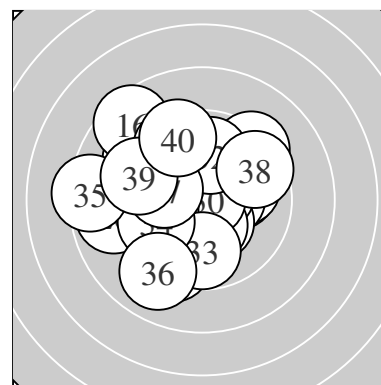
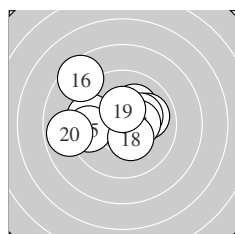

Serie 2:
 9.7 ← 10.1 ↗ 10.0 → 10.2 * 9.6 ←
 8.5 ↘ 10.4 * 10.3 * 10.4 * 8.9 ←
 beste Teiler 143.0 (19.) 145.3 (17.) 152.1 (18.)
 Trefferlage 0.83 mm links, 0.72 mm hoch
 Streuwert 2.28, horizontal: 2.78, vertikal: 1.62

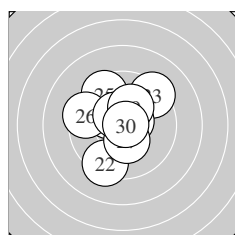

Serie 3:
 10.3 * 9.3 ↙ 9.3 ↗ 10.6 * 9.5 ↘
 9.5 ← 10.3 * 10.5 * 10.2 * 10.8 *
 beste Teiler 30.8 (30.) 90.3 (24.) 117.5 (28.)
 Trefferlage 0.38 mm links, 0.58 mm hoch
 Streuwert 1.91, horizontal: 1.81, vertikal: 2.01

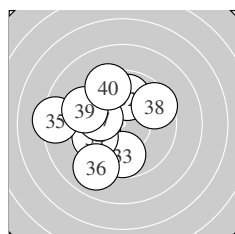

Serie 4:
 9.9 ← 9.9 ↑ 9.8 ↓ 9.8 ← 8.3 ←
 9.0 ↙ 10.0 ← 9.5 ↗ 9.4 ↘ 9.4 ↘
 beste Teiler 228.5 (37.) 251.8 (31.) 264.3 (32.)
 Trefferlage 1.79 mm links, 0.14 mm hoch
 Streuwert 2.52, horizontal: 2.59, vertikal: 2.44

Unterschrift des Schützen

Meyton Elektronik

Ergebnis: **389.2** (370)
 Serien: 96.5 97.9 96.9 97.9
 Zähler: 13 24 3 0 0 0 0 0 0 0
 Innenzehner: 9
 weiteste: 571 (40), 525 (14), 521 (3)
 beste Teiler 60.9 (9.) 79.9 (22.) 104.0 (11.)
 Trefferlage 0.56 mm rechts, 0.84 mm tief
 Streuwert 2.27, horizontal: 2.54, vertikal: 1.97

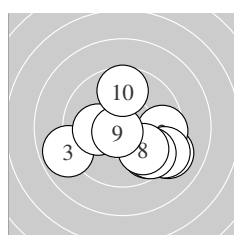
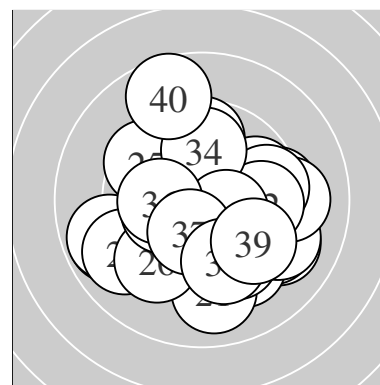

Serie 1:
 9.1 ↘ 9.6 → 8.9 ← 9.7 ↘ 9.2 ↘
 10.1 ← 9.6 ↘ 9.9 ↘ 10.7 * 9.7 ↑
 beste Teiler 60.9 (9.) 216.0 (6.) 263.1 (8.)
 Trefferlage 1.01 mm rechts, 1.07 mm tief
 Streuwert 2.35, horizontal: 2.84, vertikal: 1.74

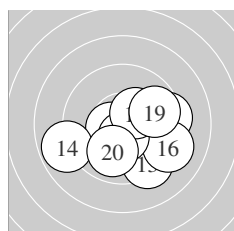

Serie 2:
 10.5 * 9.4 → 9.3 ↘ 8.9 ← 10.1 →
 9.2 ↘ 10.5 * 10.4 * 9.7 → 9.9 ↓
 beste Teiler 104.0 (11.) 112.2 (17.) 147.5 (18.)
 Trefferlage 0.94 mm rechts, 0.83 mm tief
 Streuwert 2.21, horizontal: 2.71, vertikal: 1.55

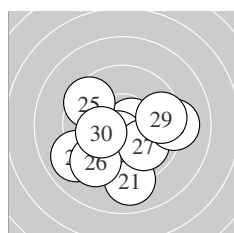

Serie 3:
 9.0 ↓ 10.6 * 9.0 ← 10.5 * 9.5 ↘
 9.4 ↙ 9.9 ↘ 9.2 → 9.6 → 10.2 *
 beste Teiler 79.9 (22.) 108.0 (24.) 198.2 (30.)
 Trefferlage 0.04 mm links, 1.12 mm tief
 Streuwert 2.43, horizontal: 2.80, vertikal: 2.01

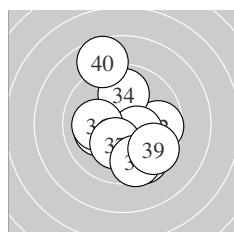

Serie 4:
 9.6 ↘ 9.7 → 10.1 ← 9.9 ↑ 10.4 *
 10.1 ← 10.2 * 9.6 ↓ 9.6 ↘ 8.7 ↑
 beste Teiler 142.7 (35.) 180.3 (37.) 210.8 (33.)
 Trefferlage 0.34 mm rechts, 0.35 mm tief
 Streuwert 2.33, horizontal: 1.95, vertikal: 2.64

Unterschrift des Schützen

Meyton Elektronik

Ergebnis: **415.7** (397)
 Serien: 103.1 104.2 103.4 105.0
 Zähler: 37 3 0 0 0 0 0 0 0 0
 Innenzehner: 32
 weiteste: 311 (8), 272 (17), 267 (30)
 beste Teiler 6.3 (11.) 11.4 (20.) 50.2 (21.)
 Trefferlage 0.14 mm rechts, 0.34 mm hoch
 Streuwert 1.10, horizontal: 1.17, vertikal: 1.02

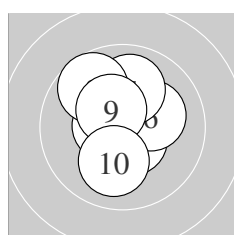
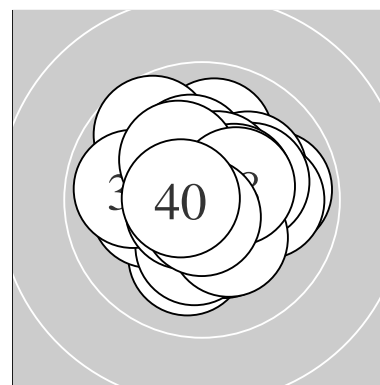

Serie 1:
 10.7 * 10.6 * 10.7 * 10.1 ↑ 10.6 *
 10.2 * 10.0 ↑ 9.7 ↘ 10.4 * 10.1 ↓
 beste Teiler 60.0 (1.) 60.0 (3.) 96.4 (5.)
 Trefferlage 0.16 mm links, 0.69 mm hoch
 Streuwert 1.25, horizontal: 1.00, vertikal: 1.46

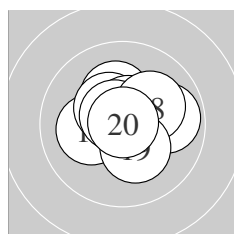

Serie 2:
 10.9 * 10.2 * 10.2 * 10.4 * 10.6 *
 10.7 * 9.9 → 10.1 ↗ 10.3 * 10.9 *
 beste Teiler 6.3 (11.) 11.4 (20.) 75.0 (16.)
 Trefferlage 0.18 mm rechts, 0.39 mm hoch
 Streuwert 1.14, horizontal: 1.33, vertikal: 0.91

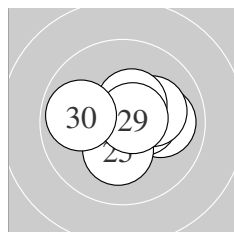

Serie 3:
 10.8 * 10.0 → 10.4 * 10.4 * 10.2 *
 10.4 * 10.2 * 10.4 * 10.7 * 9.9 ←
 beste Teiler 50.2 (21.) 68.7 (29.) 126.5 (28.)
 Trefferlage 0.61 mm rechts, 0.14 mm hoch
 Streuwert 1.16, horizontal: 1.43, vertikal: 0.79

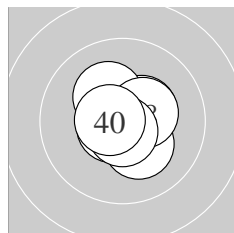

Serie 4:
 10.6 * 10.4 * 10.6 * 10.7 * 10.2 *
 10.6 * 10.2 * 10.4 * 10.7 * 10.6 *
 beste Teiler 65.0 (39.) 67.0 (34.) 76.4 (33.)
 Trefferlage 0.03 mm links, 0.15 mm hoch
 Streuwert 0.86, horizontal: 0.87, vertikal: 0.84

Unterschrift des Schützen

Meyton Elektronik

Ergebnis: **417.2** (397)
 Serien: 105.7 104.3 105.0 102.2
 Zähler: 37 3 0 0 0 0 0 0 0 0
 Innenzehner: 32
 weiteste: 404 (39), 263 (33), 254 (1)
 beste Teiler 10.0 (21.) 21.0 (36.) 34.4 (27.)
 Trefferlage 0.46 mm rechts, 0.32 mm hoch
 Streuwert 1.03, horizontal: 1.18, vertikal: 0.85

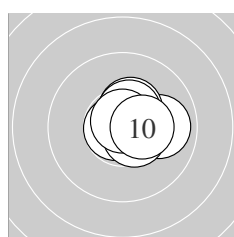
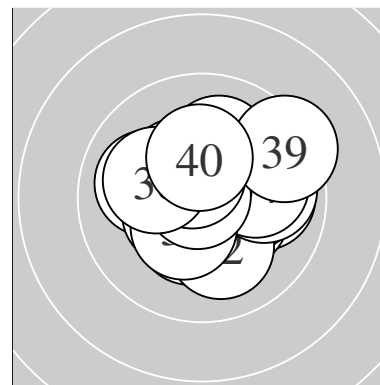

Serie 1:
 9.9 → 10.4 * 10.8 * 10.7 * 10.8 *
 10.8 * 10.6 * 10.5 * 10.8 * 10.4 *
 beste Teiler 43.0 (9.) 43.9 (5.) 47.3 (3.)
 Trefferlage 0.67 mm rechts, 0.24 mm hoch
 Streuwert 0.69, horizontal: 0.82, vertikal: 0.55

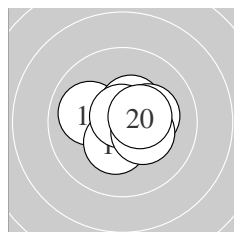

Serie 2:
 10.8 * 10.4 * 10.0 ← 10.5 * 10.5 *
 10.4 * 10.8 * 10.2 * 10.3 * 10.4 *
 beste Teiler 37.2 (11.) 42.7 (17.) 109.0 (14.)
 Trefferlage 0.46 mm rechts, 0.16 mm hoch
 Streuwert 1.00, horizontal: 1.23, vertikal: 0.72

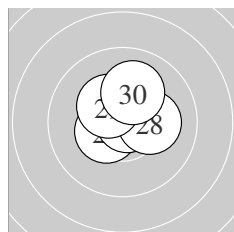

Serie 3:
 10.9 * 10.5 * 10.4 * 10.5 * 10.6 *
 10.6 * 10.8 * 10.2 * 10.4 * 10.1 ↑
 beste Teiler 10.0 (21.) 34.4 (27.) 88.2 (26.)
 Trefferlage 0.18 mm rechts, 0.60 mm hoch
 Streuwert 0.83, horizontal: 0.88, vertikal: 0.78

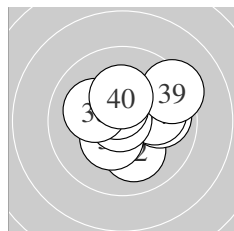

Serie 4:
 10.7 * 10.1 ↓ 9.9 → 10.0 → 10.4 *
 10.9 * 10.5 * 10.1 ← 9.3 ↗ 10.3 *
 beste Teiler 21.0 (36.) 56.8 (31.) 104.3 (37.)
 Trefferlage 0.52 mm rechts, 0.29 mm hoch
 Streuwert 1.50, horizontal: 1.72, vertikal: 1.24

Unterschrift des Schützen

Meyton Elektronik

Ergebnis: **417.8** (398)
 Serien: 104.2 105.0 104.0 104.6
 Zähler: 38 2 0 0 0 0 0 0 0 0
 Innenzehner: 34
 weiteste: 355 (23), 280 (1), 231 (39)
 beste Teiler 5.0 (16.) 13.0 (28.) 43.9 (26.)
 Trefferlage 0.01 mm links, 0.14 mm hoch
 Streuwert 1.03, horizontal: 1.18, vertikal: 0.86

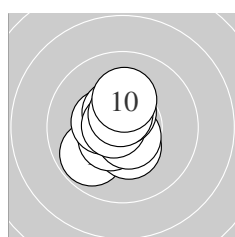
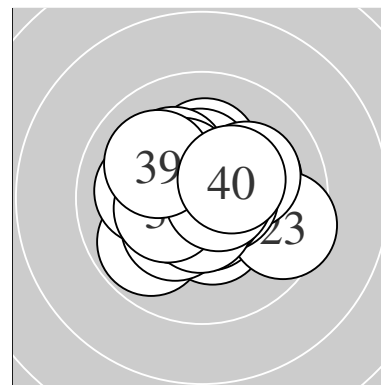

Serie 1:
 9.8 ↙ 10.4 * 10.5 * 10.6 * 10.4 *
 10.5 * 10.7 * 10.5 * 10.6 * 10.2 *
 beste Teiler 61.9 (7.) 78.2 (4.) 91.2 (9.)
 Trefferlage 0.45 mm links, 0.07 mm hoch
 Streuwert 1.02, horizontal: 0.82, vertikal: 1.20

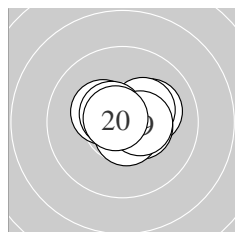

Serie 2:
 10.6 * 10.1 ↗ 10.3 * 10.3 * 10.6 *
 10.9 * 10.4 * 10.6 * 10.5 * 10.7 *
 beste Teiler 5.0 (16.) 55.9 (20.) 82.5 (18.)
 Trefferlage 0.41 mm rechts, 0.23 mm hoch
 Streuwert 0.84, horizontal: 1.07, vertikal: 0.53

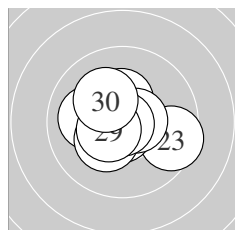

Serie 3:
 10.4 * 10.1 ← 9.5 ↘ 10.7 * 10.6 *
 10.8 * 10.3 * 10.9 * 10.5 * 10.2 *
 beste Teiler 13.0 (28.) 43.9 (26.) 59.2 (24.)
 Trefferlage 0.19 mm links, 0.02 mm tief
 Streuwert 1.26, horizontal: 1.51, vertikal: 0.94

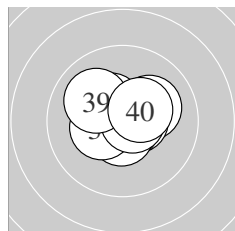

Serie 4:
 10.6 * 10.1 ↗ 10.6 * 10.8 * 10.4 *
 10.6 * 10.4 * 10.7 * 10.0 ↘ 10.4 *
 beste Teiler 49.6 (34.) 69.0 (38.) 84.3 (31.)
 Trefferlage 0.16 mm rechts, 0.28 mm hoch
 Streuwert 0.99, horizontal: 1.19, vertikal: 0.75

Unterschrift des Schützen

Meyton Elektronik

Ergebnis: **416.6** (397)
 Serien: 103.8 104.7 103.9 104.2
 Zähler: 37 3 0 0 0 0 0 0 0 0
 Innenzehner: 30
 weiteste: 350 (32), 342 (8), 268 (21)
 beste Teiler 13.3 (27.) 21.0 (39.) 31.0 (40.)
 Trefferlage 0.06 mm rechts, 0.05 mm hoch
 Streuwert 1.14, horizontal: 1.16, vertikal: 1.12

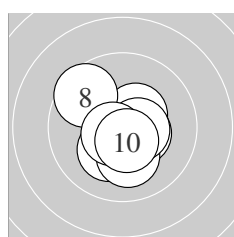
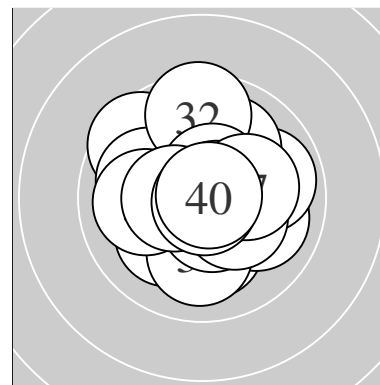

Serie 1:
 10.2 * 10.6 * 10.7 * 10.5 * 10.4 *
 10.1 ↓ 10.5 * 9.6 ↖ 10.6 * 10.6 *
 beste Teiler 75.2 (3.) 84.0 (9.) 85.5 (2.)
 Trefferlage 0.08 mm rechts, 0.26 mm tief
 Streuwert 1.20, horizontal: 1.18, vertikal: 1.22

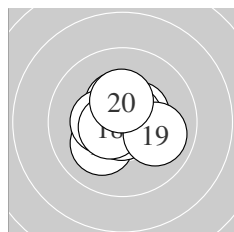

Serie 2:
 10.5 * 10.8 * 10.4 * 10.7 * 10.1 ↙
 10.4 * 10.8 * 10.6 * 10.0 → 10.4 *
 beste Teiler 43.2 (12.) 45.7 (17.) 65.1 (14.)
 Trefferlage 0.05 mm links, 0.10 mm hoch
 Streuwert 1.04, horizontal: 1.14, vertikal: 0.93

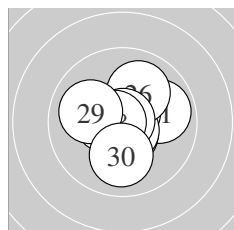

Serie 3:
 9.9 → 10.6 * 10.6 * 10.5 * 10.7 *
 10.0 ↗ 10.9 * 10.7 * 10.0 ← 10.0 ↓
 beste Teiler 13.3 (27.) 58.0 (28.) 66.7 (25.)
 Trefferlage 0.06 mm rechts, 0.07 mm hoch
 Streuwert 1.23, horizontal: 1.29, vertikal: 1.17

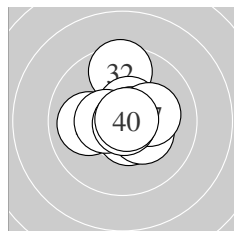

Serie 4:
 10.6 * 9.6 ↑ 10.0 ← 10.6 * 10.3 *
 10.7 * 10.2 * 10.5 * 10.9 * 10.8 *
 beste Teiler 21.0 (39.) 31.0 (40.) 63.3 (36.)
 Trefferlage 0.14 mm rechts, 0.30 mm hoch
 Streuwert 1.22, horizontal: 1.21, vertikal: 1.24

Unterschrift des Schützen

Meyton Elektronik

Ergebnis: **422.3** (400)
 Serien: 105.4 105.2 106.2 105.5
 Zähler: 40 0 0 0 0 0 0 0 0 0
 Innenzehner: 39
 weiteste: 224 (15), 197 (25), 182 (13)
 beste Teiler 20.2 (36.) 31.0 (28.) 33.1 (7.)
 Trefferlage 0.02 mm links, 0.35 mm hoch
 Streuwert 0.75, horizontal: 0.80, vertikal: 0.70

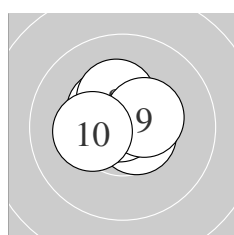
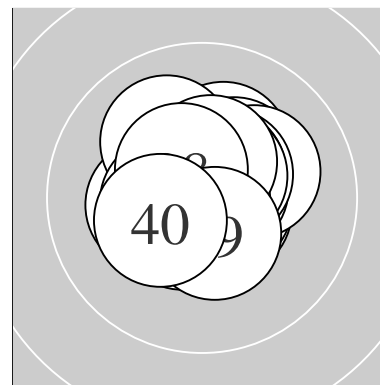

Serie 1:
 10.8 * 10.6 * 10.4 * 10.6 * 10.6 *
 10.6 * 10.8 * 10.3 * 10.4 * 10.3 *
 beste Teiler 33.1 (7.) 45.1 (1.) 82.0 (2.)
 Trefferlage 0.21 mm links, 0.41 mm hoch
 Streuwert 0.75, horizontal: 0.90, vertikal: 0.58

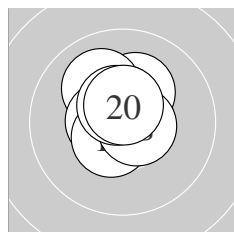

Serie 2:
 10.8 * 10.6 * 10.2 * 10.6 * 10.1 ↖
 10.6 * 10.5 * 10.6 * 10.6 * 10.6 *
 beste Teiler 39.6 (11.) 76.0 (12.) 82.9 (18.)
 Trefferlage 0.06 mm links, 0.61 mm hoch
 Streuwert 0.78, horizontal: 0.71, vertikal: 0.85

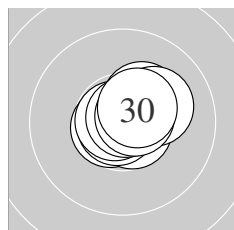

Serie 3:
 10.7 * 10.3 * 10.7 * 10.7 * 10.2 *
 10.8 * 10.8 * 10.8 * 10.7 * 10.5 *
 beste Teiler 31.0 (28.) 37.7 (26.) 44.5 (27.)
 Trefferlage 0.42 mm rechts, 0.29 mm hoch
 Streuwert 0.65, horizontal: 0.75, vertikal: 0.53

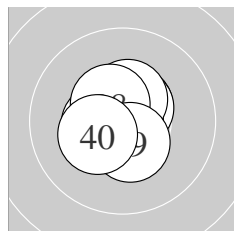

Serie 4:
 10.5 * 10.5 * 10.7 * 10.7 * 10.6 *
 10.9 * 10.4 * 10.5 * 10.4 * 10.3 *
 beste Teiler 20.2 (36.) 57.3 (34.) 71.3 (33.)
 Trefferlage 0.24 mm links, 0.09 mm hoch
 Streuwert 0.78, horizontal: 0.75, vertikal: 0.80

Unterschrift des Schützen

Ergebnis: **413.8** (397)
 Serien: 103.0 104.0 103.5 103.3
 Zähler: 37 3 0 0 0 0 0 0 0 0
 Innenzehner: 31
 weiteste: 280 (32), 266 (3), 255 (36)
 beste Teiler 61.7 (37.) 62.4 (19.) 70.2 (26.)
 Trefferlage 0.29 mm rechts, 0.20 mm tief
 Streuwert 1.15, horizontal: 1.20, vertikal: 1.09

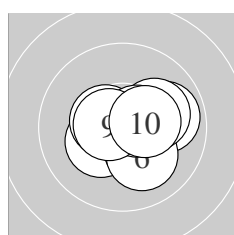
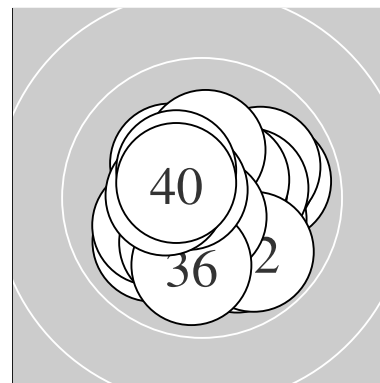

Serie 1:
 10.2 * 10.3 * 9.9 → 10.3 * 10.5 *
 10.1 ↘ 10.1 → 10.6 * 10.6 * 10.4 *
 beste Teiler 85.5 (9.) 96.7 (8.) 114.2 (5.)
 Trefferlage 0.70 mm rechts, 0.26 mm tief
 Streuwert 1.17, horizontal: 1.33, vertikal: 0.97

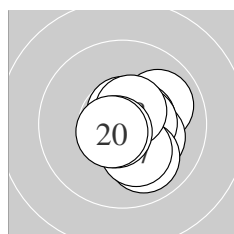

Serie 2:
 10.0 → 10.7 * 10.5 * 10.2 * 10.5 *
 10.0 ↘ 10.2 * 10.6 * 10.7 * 10.6 *
 beste Teiler 62.4 (19.) 73.0 (12.) 82.4 (20.)
 Trefferlage 0.77 mm rechts, 0.23 mm tief
 Streuwert 0.99, horizontal: 0.91, vertikal: 1.06

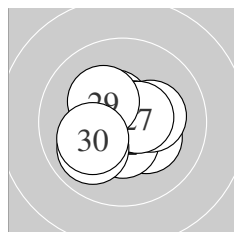

Serie 3:
 10.2 * 10.4 * 10.6 * 10.2 * 10.5 *
 10.7 * 10.6 * 10.0 ↙ 10.2 * 10.1 ↙
 beste Teiler 70.2 (26.) 81.5 (23.) 99.6 (27.)
 Trefferlage 0.11 mm links, 0.09 mm tief
 Streuwert 1.18, horizontal: 1.30, vertikal: 1.03

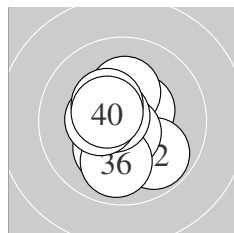

Serie 4:
 10.5 * 9.8 ↘ 10.2 * 10.2 * 10.7 *
 9.9 ↓ 10.7 * 10.4 * 10.4 * 10.5 *
 beste Teiler 61.7 (37.) 73.0 (35.) 112.0 (40.)
 Trefferlage 0.18 mm links, 0.24 mm tief
 Streuwert 1.24, horizontal: 1.03, vertikal: 1.43

Unterschrift des Schützen

Meyton Elektronik

Ergebnis: **407.2** (389)
 Serien: 100.5 101.8 102.2 102.7
 Zähler: 29 11 0 0 0 0 0 0 0 0
 Innenzehner: 22
 weiteste: 430 (22), 371 (34), 349 (13)
 beste Teiler 40.3 (17.) 51.6 (28.) 52.0 (29.)
 Trefferlage 0.32 mm rechts, 0.44 mm hoch
 Streuwert 1.49, horizontal: 1.48, vertikal: 1.50

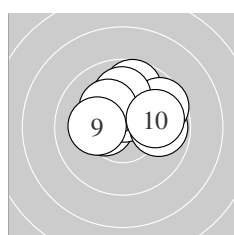
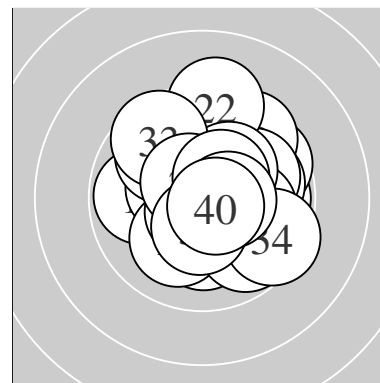

Serie 1:
 10.4 * 10.2 * 10.5 * 9.8 → 9.7 ↑
 9.6 ↗ 10.0 ↑ 10.2 * 10.2 * 9.9 →
 beste Teiler 109.4 (3.) 139.0 (1.) 184.0 (8.)
 Trefferlage 0.39 mm rechts, 1.21 mm hoch
 Streuwert 1.46, horizontal: 1.79, vertikal: 1.04

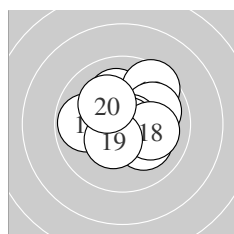

Serie 2:
 10.1 ↑ 10.1 ↘ 9.6 ↗ 10.0 → 9.8 ←
 10.7 * 10.8 * 10.1 → 10.4 * 10.2 *
 beste Teiler 40.3 (17.) 56.3 (16.) 139.0 (19.)
 Trefferlage 0.39 mm rechts, 0.43 mm hoch
 Streuwert 1.54, horizontal: 1.70, vertikal: 1.36

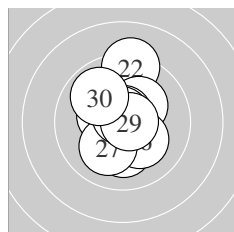

Serie 3:
 10.4 * 9.2 ↑ 10.2 * 10.1 ↓ 10.7 *
 10.2 * 10.1 ↙ 10.7 * 10.7 * 9.9 ↘
 beste Teiler 51.6 (28.) 52.0 (29.) 59.1 (25.)
 Trefferlage 0.05 mm links, 0.38 mm hoch
 Streuwert 1.54, horizontal: 1.06, vertikal: 1.90

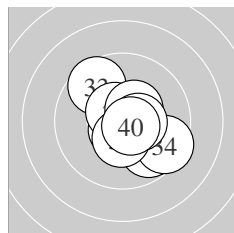

Serie 4:
 10.6 * 9.8 ↘ 9.6 ↘ 9.5 ↘ 10.6 *
 10.6 * 10.4 * 10.4 * 10.5 * 10.7 *
 beste Teiler 73.5 (40.) 76.0 (35.) 82.7 (31.)
 Trefferlage 0.54 mm rechts, 0.25 mm tief
 Streuwert 1.44, horizontal: 1.45, vertikal: 1.43

Unterschrift des Schützen

Meyton Elektronik

Ergebnis: **414.4** (397)
 Serien: 101.3 104.1 104.9 104.1
 Zähler: 37 3 0 0 0 0 0 0 0 0
 Innenzehner: 31
 weiteste: 343 (4), 314 (5), 268 (7)
 beste Teiler 44.0 (30.) 48.7 (26.) 56.5 (38.)
 Trefferlage 0.20 mm links, 0.37 mm hoch
 Streuwert 1.14, horizontal: 1.11, vertikal: 1.18

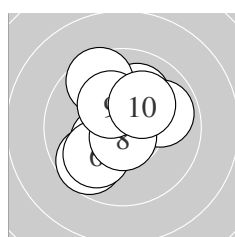
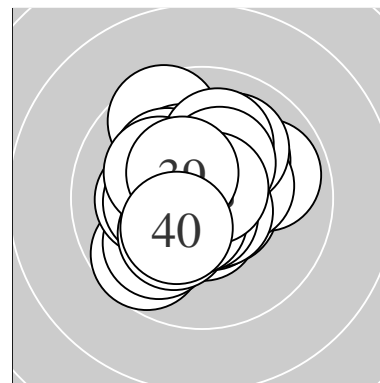

Serie 1:
 10.1 ↗ 10.5 * 10.3 * 9.6 ↘ 9.7 ↙
 10.0 ↖ 9.9 → 10.7 * 10.3 * 10.2 *
 beste Teiler 65.0 (8.) 102.0 (2.) 153.4 (3.)
 Trefferlage 0.33 mm links, 0.42 mm hoch
 Streuwert 1.63, horizontal: 1.51, vertikal: 1.74

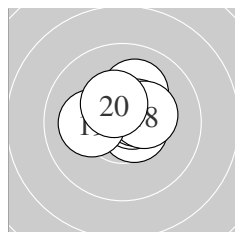

Serie 2:
 10.5 * 10.1 ↗ 10.5 * 10.5 * 10.6 *
 10.6 * 10.5 * 10.3 * 10.1 ← 10.4 *
 beste Teiler 78.4 (16.) 89.5 (15.) 109.0 (17.)
 Trefferlage 0.09 mm rechts, 0.67 mm hoch
 Streuwert 0.92, horizontal: 1.11, vertikal: 0.69

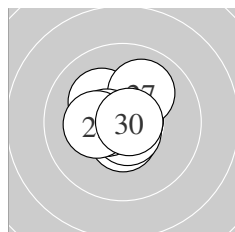

Serie 3:
 10.5 * 10.6 * 10.5 * 10.2 * 10.7 *
 10.8 * 10.0 ↗ 10.5 * 10.3 * 10.8 *
 beste Teiler 44.0 (30.) 48.7 (26.) 72.8 (25.)
 Trefferlage 0.32 mm links, 0.26 mm hoch
 Streuwert 0.93, horizontal: 0.97, vertikal: 0.89

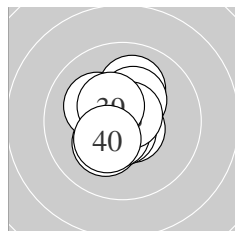

Serie 4:
 10.6 * 10.2 * 10.1 ↗ 10.7 * 10.2 *
 10.3 * 10.6 * 10.7 * 10.4 * 10.3 *
 beste Teiler 56.5 (38.) 69.0 (34.) 79.3 (31.)
 Trefferlage 0.27 mm links, 0.12 mm hoch
 Streuwert 1.06, horizontal: 0.86, vertikal: 1.23

Unterschrift des Schützen

Meyton Elektronik

Ergebnis: **417.1** (398)
 Serien: 103.5 104.5 104.6 104.5
 Zähler: 38 2 0 0 0 0 0 0 0 0
 Innenzehner: 35
 weiteste: 370 (1), 271 (27), 216 (3)
 beste Teiler 10.4 (2.) 38.6 (17.) 41.2 (11.)
 Trefferlage 0.06 mm rechts, 0.19 mm hoch
 Streuwert 1.05, horizontal: 1.19, vertikal: 0.89

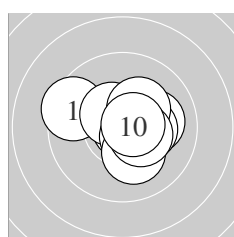
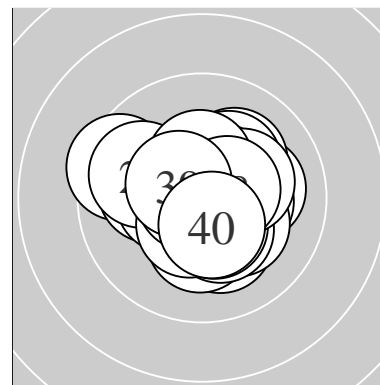

Serie 1:
 9.5 ↙ 10.9 * 10.1 → 10.3 * 10.5 *
 10.3 * 10.6 * 10.2 * 10.4 * 10.7 *
 beste Teiler 10.4 (2.) 75.1 (10.) 89.8 (7.)
 Trefferlage 0.41 mm rechts, 0.09 mm hoch
 Streuwert 1.30, horizontal: 1.58, vertikal: 0.95

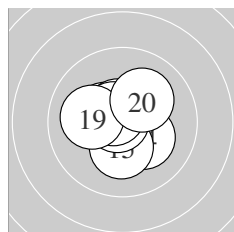

Serie 2:
 10.8 * 10.4 * 10.6 * 10.2 * 10.3 *
 10.6 * 10.8 * 10.6 * 10.1 ← 10.1 ↗
 beste Teiler 38.6 (17.) 41.2 (11.) 78.4 (13.)
 Trefferlage 0.10 mm links, 0.14 mm hoch
 Streuwert 1.03, horizontal: 1.12, vertikal: 0.94

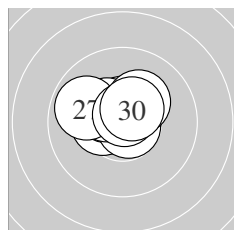

Serie 3:
 10.8 * 10.4 * 10.4 * 10.6 * 10.7 *
 10.4 * 9.9 ↙ 10.2 * 10.7 * 10.5 *
 beste Teiler 46.5 (21.) 51.0 (25.) 54.5 (29.)
 Trefferlage 0.33 mm links, 0.61 mm hoch
 Streuwert 0.90, horizontal: 1.14, vertikal: 0.55

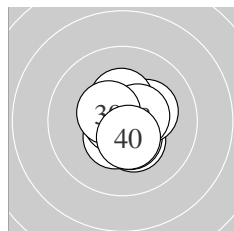

Serie 4:
 10.5 * 10.3 * 10.4 * 10.5 * 10.2 *
 10.7 * 10.4 * 10.5 * 10.5 * 10.5 *
 beste Teiler 51.0 (36.) 108.3 (31.) 111.9 (38.)
 Trefferlage 0.28 mm rechts, 0.07 mm tief
 Streuwert 0.93, horizontal: 0.81, vertikal: 1.03

Unterschrift des Schützen

Meyton Elektronik

Ergebnis: **418.2** (398)
 Serien: 102.7 104.9 105.2 105.4
 Zähler: 38 2 0 0 0 0 0 0 0 0
 Innenzehner: 33
 weiteste: 306 (2), 287 (4), 249 (3)
 beste Teiler 12.5 (27.) 13.0 (31.) 36.3 (38.)
 Trefferlage 0.20 mm links, 0.24 mm tief
 Streuwert 1.00, horizontal: 1.13, vertikal: 0.85

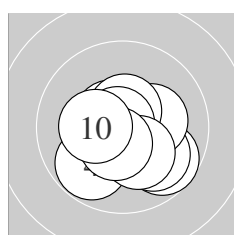
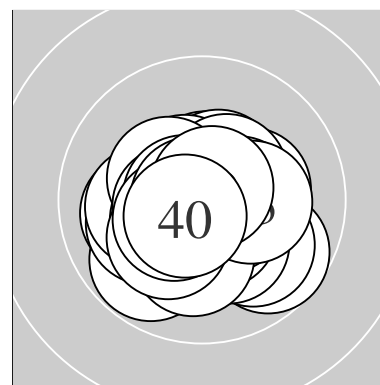

Serie 1:
 10.6 * 9.7 ↘ 10.0 ↘ 9.8 ✓ 10.2 *
 10.6 * 10.8 * 10.2 * 10.5 * 10.3 *
 beste Teiler 37.2 (7.) 94.9 (1.) 99.8 (6.)
 Trefferlage 0.21 mm rechts, 0.59 mm tief
 Streuwert 1.34, horizontal: 1.48, vertikal: 1.18

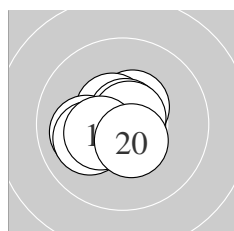

Serie 2:
 10.7 * 10.8 * 10.5 * 10.5 * 10.0 ←
 10.1 ← 10.7 * 10.7 * 10.4 * 10.5 *
 beste Teiler 49.6 (12.) 53.7 (18.) 55.3 (17.)
 Trefferlage 0.52 mm links, 0.04 mm hoch
 Streuwert 0.89, horizontal: 1.03, vertikal: 0.73

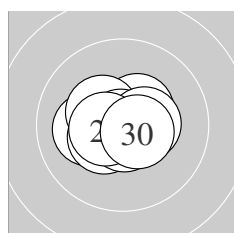

Serie 3:
 10.1 ← 10.4 * 10.7 * 10.5 * 10.7 *
 10.4 * 10.9 * 10.4 * 10.5 * 10.6 *
 beste Teiler 12.5 (27.) 56.4 (23.) 61.0 (25.)
 Trefferlage 0.22 mm links, 0.00 mm
 Streuwert 0.87, horizontal: 1.10, vertikal: 0.57

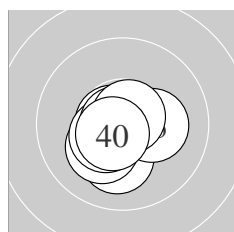

Serie 4:
 10.9 * 10.1 ↓ 10.2 * 10.7 * 10.7 *
 10.2 * 10.5 * 10.8 * 10.7 * 10.6 *
 beste Teiler 13.0 (31.) 36.3 (38.) 57.6 (35.)
 Trefferlage 0.27 mm links, 0.43 mm tief
 Streuwert 0.80, horizontal: 0.85, vertikal: 0.75

Unterschrift des Schützen

Meyton Elektronik

Ergebnis: **411.8** (391)
 Serien: 102.4 102.4 102.9 104.1
 Zähler: 31 9 0 0 0 0 0 0 0 0
 Innenzehner: 31
 weiteste: 391 (24), 358 (1), 347 (18)
 beste Teiler 35.8 (8.) 57.3 (40.) 69.0 (34.)
 Trefferlage 0.77 mm rechts, 0.29 mm tief
 Streuwert 1.20, horizontal: 1.27, vertikal: 1.13

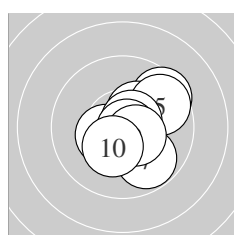
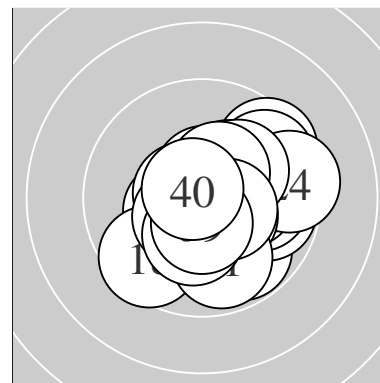

Serie 1:
 9.5 ↗ 10.3 * 10.5 * 10.4 * 9.7 ↗
 10.6 * 9.8 ↘ 10.8 * 10.5 * 10.3 *
 beste Teiler 35.8 (8.) 80.2 (6.) 102.5 (3.)
 Trefferlage 0.88 mm rechts, 0.05 mm tief
 Streuwert 1.36, horizontal: 1.32, vertikal: 1.40

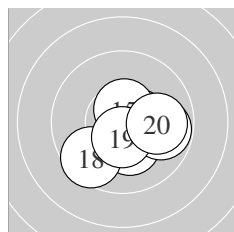

Serie 2:
 10.5 * 10.4 * 10.2 * 10.6 * 10.6 *
 10.3 * 9.8 → 9.6 ↙ 10.5 * 9.9 →
 beste Teiler 94.7 (15.) 98.8 (14.) 108.2 (11.)
 Trefferlage 0.79 mm rechts, 0.71 mm tief
 Streuwert 1.26, horizontal: 1.47, vertikal: 1.01

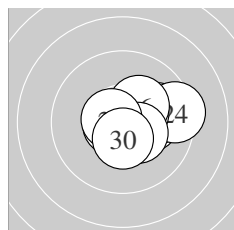

Serie 3:
 10.2 * 9.9 → 10.5 * 9.4 → 10.4 *
 10.3 * 10.7 * 10.4 * 10.6 * 10.5 *
 beste Teiler 72.1 (27.) 83.6 (29.) 112.9 (23.)
 Trefferlage 1.13 mm rechts, 0.08 mm hoch
 Streuwert 1.14, horizontal: 1.43, vertikal: 0.75

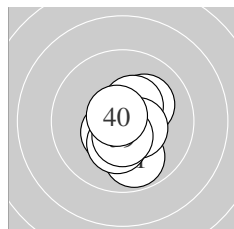

Serie 4:
 9.8 ↘ 10.5 * 10.2 * 10.7 * 10.5 *
 10.4 * 10.3 * 10.5 * 10.5 * 10.7 *
 beste Teiler 57.3 (40.) 69.0 (34.) 111.0 (39.)
 Trefferlage 0.29 mm rechts, 0.50 mm tief
 Streuwert 1.03, horizontal: 0.80, vertikal: 1.21

Unterschrift des Schützen

Ergebnis: **401.3** (387)
 Serien: 102.2 102.8 104.2 92.1
 Zähler: 36 3 0 0 0 0 0 0 0 0
 Innenzehner: 26
 weiteste: 335 (13), 261 (14), 260 (3)
 beste Teiler 42.9 (20.) 70.0 (2.) 70.2 (33.)
 Trefferlage 0.11 mm rechts, 0.04 mm tief
 Streuwert 1.27, horizontal: 1.22, vertikal: 1.31

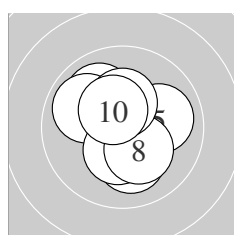
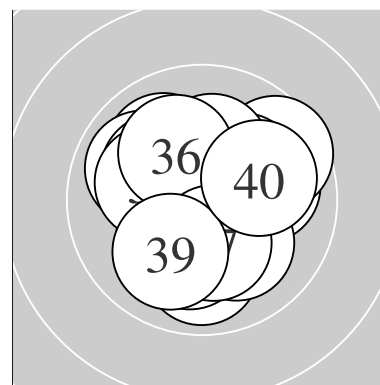

Serie 1:
 10.0 ↘ 10.7 * 9.9 ↘ 10.2 * 10.0 →
 10.1 ↓ 10.4 * 10.2 * 10.3 * 10.4 *
 beste Teiler 70.0 (2.) 128.0 (10.) 150.2 (7.)
 Trefferlage 0.10 mm links, 0.01 mm hoch
 Streuwert 1.41, horizontal: 1.30, vertikal: 1.52

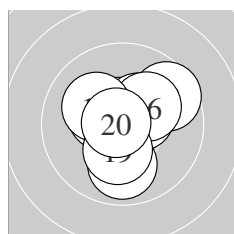

Serie 2:
 10.6 * 10.5 * 9.6 ↗ 9.9 ↓ 10.4 *
 10.2 * 10.4 * 10.1 ↘ 10.3 * 10.8 *
 beste Teiler 42.9 (20.) 83.2 (11.) 123.9 (12.)
 Trefferlage 0.24 mm rechts, 0.27 mm hoch
 Streuwert 1.37, horizontal: 1.37, vertikal: 1.37

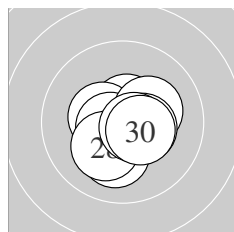

Serie 3:
 10.7 * 10.6 * 10.4 * 10.6 * 10.1 ↓
 10.2 * 10.4 * 10.2 * 10.6 * 10.4 *
 beste Teiler 71.3 (21.) 79.2 (29.) 85.2 (24.)
 Trefferlage 0.17 mm rechts, 0.37 mm tief
 Streuwert 0.98, horizontal: 1.04, vertikal: 0.90

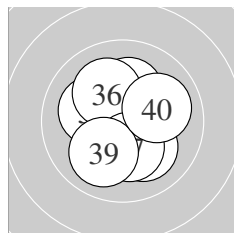

Serie 4:
 10.1 ↖ 10.6 * 10.7 * 10.2 * 10.1 ↘
 10.1 ↘ 10.3 * 0.0F^{MIS} 10.0 ✓ 10.0 →
 beste Teiler 70.2 (33.) 87.3 (32.) 172.9 (37.)
 Trefferlage 0.12 mm rechts, 0.11 mm tief
 Streuwert 1.41, horizontal: 1.31, vertikal: 1.50

MIS – Treffer wurde manuell eingefügt, da der Schütze die Scheibe verfehlt hat

Unterschrift des Schützen

Meyton Elektronik

Ergebnis: **418.2** (398)
 Serien: 104.1 105.2 104.0 104.9
 Zähler: 38 2 0 0 0 0 0 0 0 0
 Innenzehner: 35
 weiteste: 288 (38), 272 (22), 237 (21)
 beste Teiler 32.5 (5.) 37.1 (25.) 43.6 (39.)
 Trefferlage 0.04 mm rechts, 0.08 mm hoch
 Streuwert 1.01, horizontal: 1.05, vertikal: 0.96

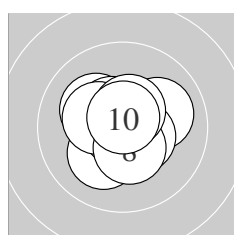
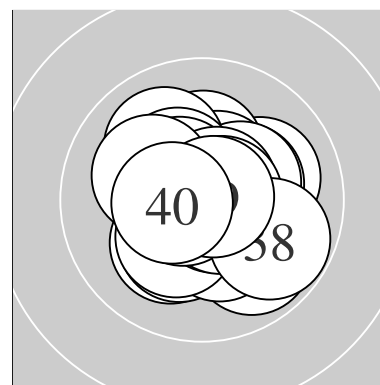

Serie 1:
 10.2 * 10.0 → 10.2 * 10.5 * 10.8 *
 10.5 * 10.3 * 10.4 * 10.5 * 10.7 *
 beste Teiler 32.5 (5.) 60.1 (10.) 108.6 (9.)
 Trefferlage 0.12 mm links, 0.14 mm hoch
 Streuwert 1.09, horizontal: 1.18, vertikal: 0.98

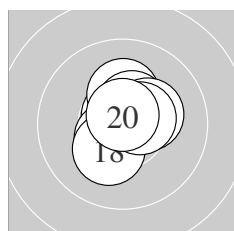

Serie 2:
 10.8 * 10.7 * 10.2 * 10.7 * 10.5 *
 10.5 * 10.3 * 10.3 * 10.5 * 10.7 *
 beste Teiler 45.8 (11.) 55.4 (14.) 57.0 (20.)
 Trefferlage 0.08 mm rechts, 0.25 mm hoch
 Streuwert 0.86, horizontal: 0.76, vertikal: 0.96

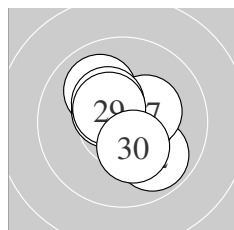

Serie 3:
 10.0 ↘ 9.9 ↘ 10.6 * 10.5 * 10.8 *
 10.7 * 10.3 * 10.4 * 10.5 * 10.3 *
 beste Teiler 37.1 (25.) 51.2 (26.) 87.6 (23.)
 Trefferlage 0.15 mm rechts, 0.19 mm hoch
 Streuwert 1.14, horizontal: 1.10, vertikal: 1.19

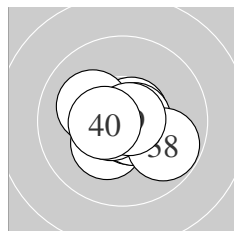

Serie 4:
 10.7 * 10.7 * 10.3 * 10.1 ↘ 10.7 *
 10.6 * 10.7 * 9.8 ↘ 10.8 * 10.5 *
 beste Teiler 43.6 (39.) 65.0 (35.) 70.9 (31.)
 Trefferlage 0.07 mm rechts, 0.24 mm tief
 Streuwert 1.02, horizontal: 1.24, vertikal: 0.74

Unterschrift des Schützen

Ergebnis: **413.1** (394)
 Serien: 103.3 103.2 103.2 103.4
 Zähler: 34 6 0 0 0 0 0 0 0 0
 Innenzehner: 28
 weiteste: 330 (12), 329 (5), 305 (26)
 beste Teiler 35.6 (19.) 63.1 (37.) 68.5 (20.)
 Trefferlage 0.09 mm rechts, 0.15 mm hoch
 Streuwert 1.24, horizontal: 1.30, vertikal: 1.18

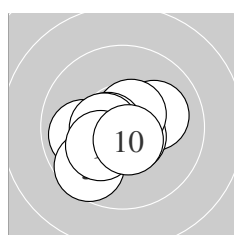
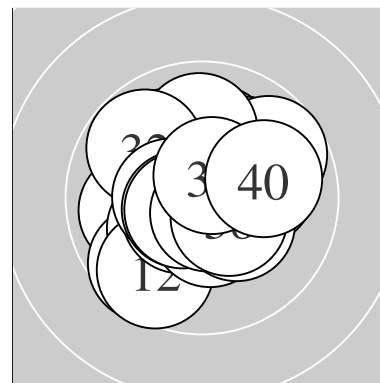

Serie 1:
 9.9 ← 10.1 → 10.6 * 10.6 * 9.6 ↙
 10.6 * 10.6 * 10.5 * 10.2 * 10.6 *
 beste Teiler 80.6 (6.) 82.1 (3.) 88.6 (10.)
 Trefferlage 0.53 mm links, 0.45 mm tief
 Streuwert 1.20, horizontal: 1.39, vertikal: 0.96

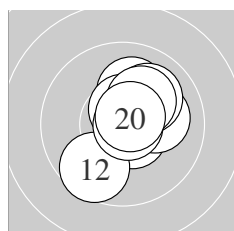

Serie 2:
 10.6 * 9.6 ↘ 10.1 → 10.1 ↑ 10.5 *
 10.0 ↗ 10.6 * 10.2 * 10.8 * 10.7 *
 beste Teiler 35.6 (19.) 68.5 (20.) 86.9 (11.)
 Trefferlage 0.57 mm rechts, 0.46 mm hoch
 Streuwert 1.23, horizontal: 1.04, vertikal: 1.39

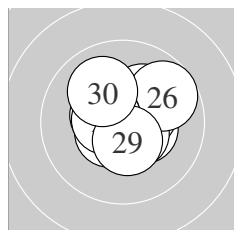

Serie 3:
 10.2 * 10.4 * 10.4 * 10.5 * 10.5 *
 9.7 ↗ 10.5 * 10.5 * 10.5 * 10.0 ↘
 beste Teiler 103.2 (25.) 104.2 (28.) 105.4 (24.)
 Trefferlage 0.31 mm rechts, 0.32 mm hoch
 Streuwert 1.21, horizontal: 1.32, vertikal: 1.09

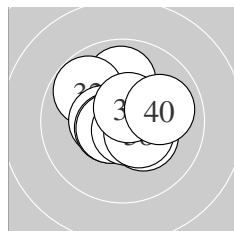

Serie 4:
 9.9 ↑ 9.8 ↖ 10.3 * 10.5 * 10.6 *
 10.6 * 10.7 * 10.4 * 10.6 * 10.0 →
 beste Teiler 63.1 (37.) 87.1 (36.) 94.0 (39.)
 Trefferlage 0.02 mm rechts, 0.29 mm hoch
 Streuwert 1.27, horizontal: 1.34, vertikal: 1.19

Unterschrift des Schützen

Meyton Elektronik

Ergebnis: **411.8** (395)
 Serien: 103.5 102.7 101.8 103.8
 Zähler: 35 5 0 0 0 0 0 0 0 0
 Innenzehner: 29
 weiteste: 454 (25), 326 (1), 259 (5)
 beste Teiler 33.3 (38.) 41.1 (27.) 47.1 (29.)
 Trefferlage 0.10 mm links, 0.52 mm hoch
 Streuwert 1.25, horizontal: 0.99, vertikal: 1.46

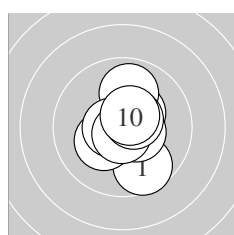
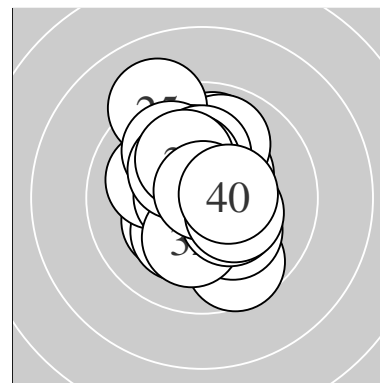

Serie 1:
 9.6 ↘ 10.3 * 10.4 * 10.4 * 9.9 ↑
 10.5 * 10.6 * 10.8 * 10.5 * 10.5 *
 beste Teiler 50.6 (8.) 81.0 (7.) 101.2 (9.)
 Trefferlage 0.36 mm rechts, 0.14 mm hoch
 Streuwert 1.23, horizontal: 0.89, vertikal: 1.48

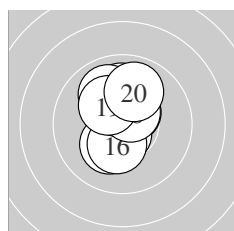

Serie 2:
 10.0 ↑ 10.0 ↖ 10.5 * 10.7 * 10.2 *
 10.3 * 10.4 * 10.5 * 10.2 * 9.9 ↑
 beste Teiler 73.1 (14.) 107.3 (18.) 110.8 (13.)
 Trefferlage 0.21 mm links, 0.78 mm hoch
 Streuwert 1.20, horizontal: 0.74, vertikal: 1.53

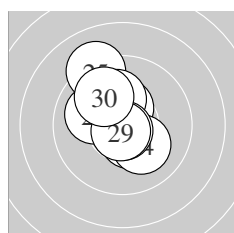

Serie 3:
 10.4 * 10.1 ↖ 10.5 * 10.1 ↘ 9.1 ↖
 10.1 ↑ 10.8 * 10.0 ↖ 10.8 * 9.9 ↖
 beste Teiler 41.1 (27.) 47.1 (29.) 116.7 (23.)
 Trefferlage 0.59 mm links, 0.78 mm hoch
 Streuwert 1.47, horizontal: 1.21, vertikal: 1.69

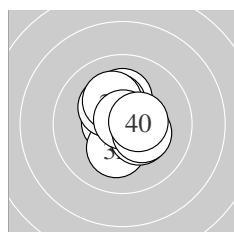

Serie 4:
 10.6 * 10.2 * 10.3 * 10.2 * 10.3 *
 10.2 * 10.4 * 10.8 * 10.3 * 10.5 *
 beste Teiler 33.3 (38.) 86.4 (31.) 120.2 (40.)
 Trefferlage 0.01 mm rechts, 0.38 mm hoch
 Streuwert 1.11, horizontal: 0.95, vertikal: 1.25

Unterschrift des Schützen

Meyton Elektronik

Ergebnis: **411.9** (395)
 Serien: 102.7 104.3 102.3 102.6
 Zähler: 36 3 1 0 0 0 0 0 0
 Innenzehner: 27
 weiteste: 503 (4), 405 (1), 350 (21)
 beste Teiler 10.8 (35.) 13.6 (2.) 52.8 (14.)
 Trefferlage 0.37 mm rechts, 0.02 mm tief
 Streuwert 1.34, horizontal: 1.63, vertikal: 0.95

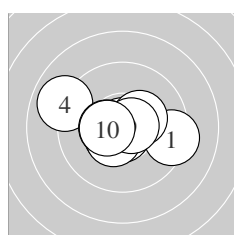
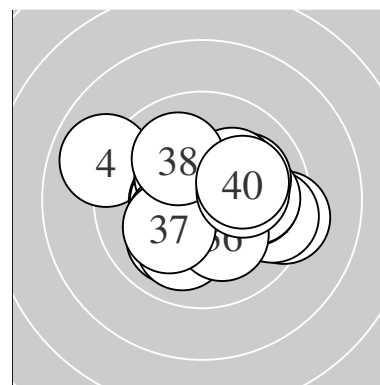

Serie 1:
 9.3 → 10.9 * 10.3 * 8.9 ↖ 10.7 *
 10.4 * 10.5 * 10.5 * 10.7 * 10.5 *
 beste Teiler 13.6 (2.) 60.1 (5.) 71.0 (9.)
 Trefferlage 0.28 mm links, 0.03 mm tief
 Streuwert 1.67, horizontal: 2.20, vertikal: 0.86

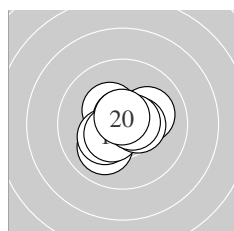

Serie 2:
 10.3 * 10.6 * 10.1 → 10.7 * 10.0 ↙
 10.3 * 10.5 * 10.5 * 10.6 * 10.7 *
 beste Teiler 52.8 (14.) 57.3 (20.) 81.3 (12.)
 Trefferlage 0.02 mm links, 0.01 mm tief
 Streuwert 1.06, horizontal: 1.18, vertikal: 0.93

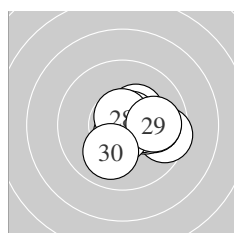

Serie 3:
 9.6 → 10.0 → 10.2 * 10.3 * 10.4 *
 10.6 * 10.6 * 10.7 * 9.9 → 10.0 ↙
 beste Teiler 69.3 (28.) 78.0 (26.) 81.2 (27.)
 Trefferlage 1.23 mm rechts, 0.14 mm tief
 Streuwert 1.17, horizontal: 1.38, vertikal: 0.91

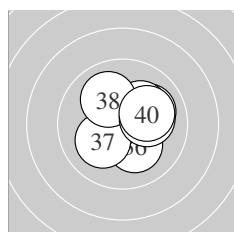

Serie 4:
 10.5 * 10.0 → 10.5 * 10.2 * 10.9 *
 10.2 * 10.1 ↙ 10.0 ↘ 10.1 → 10.1 →
 beste Teiler 10.8 (35.) 106.8 (33.) 116.0 (31.)
 Trefferlage 0.57 mm rechts, 0.09 mm hoch
 Streuwert 1.29, horizontal: 1.36, vertikal: 1.22

Unterschrift des Schützen