

Ergebnis:	592.2	(559)					
Serien:	99.9	99.7	96.2	94.8	103.0	98.6	
Zähler:	29	23	7	0	1	0	0
Innenzehner:	22						
weiteste:	1177 (39), 658 (27), 648 (20)						
beste Teiler	33.5 (58.) 35.8 (43.) 47.4 (41.)						
Trefferlage	0.27 mm links, 0.31 mm hoch						
Streuwert	2.34, horizontal: 2.34, vertikal: 2.34						

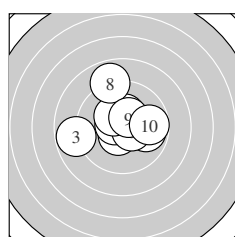

Serie 1:	10.5 *	10.3 *	8.8 ←	9.9 →	10.6 *
	10.5 *	10.3 *	8.9 ↑	10.4 *	9.7 →
beste Teiler	92.4 (5.) 106.9 (1.) 111.0 (6.)				
Trefferlage	0.14 mm links, 0.63 mm hoch				
Streuwert	2.08, horizontal: 2.34, vertikal: 1.78				

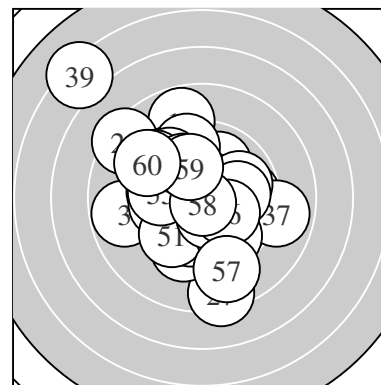
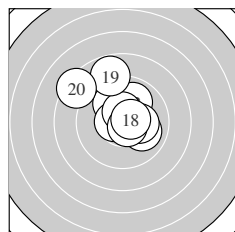

Serie 2:	10.0 ↖	9.9 ↗	10.0 ↘	10.6 *	10.5 *
	10.2 *	10.7 *	10.6 *	8.8 ↑	8.4 ↗
beste Teiler	74.2 (17.) 95.1 (14.) 97.4 (18.)				
Trefferlage	0.21 mm links, 1.32 mm hoch				
Streuwert	2.09, horizontal: 2.15, vertikal: 2.02				

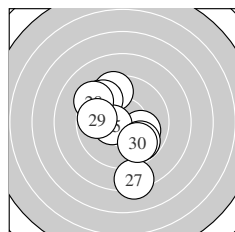

Serie 3:	9.6 ↖	10.0 ↘	9.5 ↑	9.6 ↖	10.5 *
	9.8 ↘	8.3 ↓	9.3 ↖	9.8 ←	9.8 ↘
beste Teiler	121.0 (25.) 226.0 (22.) 285.0 (30.)				
Trefferlage	0.58 mm links, 0.07 mm tief				
Streuwert	2.63, horizontal: 2.13, vertikal: 3.04				

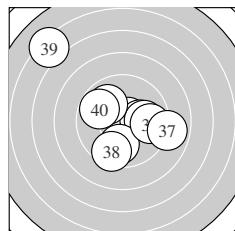

Serie 4:	10.7 *	10.2 *	10.0 →	9.9 ↖	9.9 ↓
	9.7 →	8.9 →	9.5 ↓	6.2 ↖	9.8 ↖
beste Teiler	75.2 (31.) 194.5 (32.) 244.1 (33.)				
Trefferlage	0.11 mm links, 0.48 mm hoch				
Streuwert	3.48, horizontal: 3.74, vertikal: 3.21				

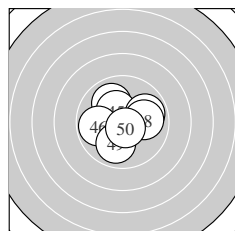

Serie 5:	10.8 *	10.7 *	10.8 *	10.0 ↖	10.4 *
	9.8 ←	9.9 →	10.0 →	9.9 ↓	10.7 *
beste Teiler	35.8 (43.) 47.4 (41.) 68.8 (42.)				
Trefferlage	0.02 mm rechts, 0.12 mm hoch				
Streuwert	1.43, horizontal: 1.61, vertikal: 1.23				

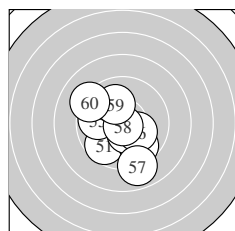

Serie 6:	9.7 ↗	9.7 ↘	9.8 ↖	10.4 *	9.8 ←
	10.2 *	8.9 ↓	10.8 *	10.1 ↑	9.2 ↖
beste Teiler	33.5 (58.) 128.8 (54.) 195.5 (56.)				
Trefferlage	0.63 mm links, 0.62 mm tief				
Streuwert	2.18, horizontal: 2.08, vertikal: 2.27				

Meyton Elektronik

ISSF AR Women – Wertung – Frauen

StandNr: 101

Anlanger, Beatrice Carina #117

StartNr: 1

21. Januar 2020 9:18

OOE – SV Laakirchen

Unterschrift des Schützen

Meyton Elektronik

Ergebnis: **622.7** (593)
 Serien: 105.9 104.1 103.2 103.0 102.9 103.6
 Zähler: 53 7 0 0 0 0 0 0 0
 Innenzehner: 49
 weiteste: 366 (50), 361 (22), 338 (45)
 beste Teiler 21.0 (5.) 35.7 (46.) 36.6 (26.)
 Trefferlage 0.02 mm rechts, 0.00 mm
 Streuwert 1.17, horizontal: 1.45, vertikal: 0.80

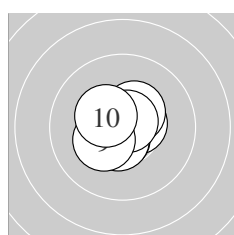
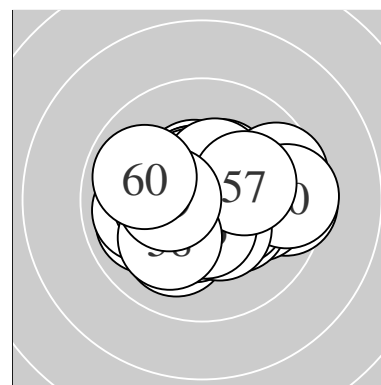

Serie 1:
 10.6 * 10.6 * 10.4 * 10.8 * 10.9 *
 10.6 * 10.6 * 10.7 * 10.3 * 10.4 *
 beste Teiler 21.0 (5.) 42.4 (4.) 52.2 (8.)
 Trefferlage 0.20 mm links, 0.07 mm tief
 Streuwert 0.74, horizontal: 0.75, vertikal: 0.73

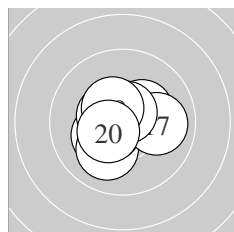

Serie 2:
 10.3 * 10.5 * 10.1 ✓ 10.5 * 10.3 *
 10.7 * 10.0 → 10.7 * 10.5 * 10.5 *
 beste Teiler 69.3 (16.) 74.0 (18.) 107.3 (14.)
 Trefferlage 0.23 mm links, 0.05 mm tief
 Streuwert 1.12, horizontal: 1.26, vertikal: 0.95

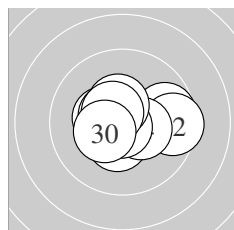

Serie 3:
 9.7 → 9.5 → 10.4 * 10.4 * 10.4 *
 10.8 * 10.5 * 10.5 * 10.6 * 10.4 *
 beste Teiler 36.6 (26.) 100.4 (29.) 105.9 (27.)
 Trefferlage 0.27 mm rechts, 0.03 mm hoch
 Streuwert 1.37, horizontal: 1.78, vertikal: 0.76

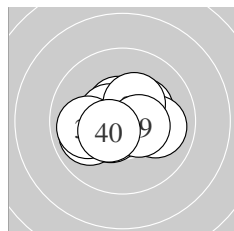

Serie 4:
 10.5 * 10.5 * 10.5 * 9.9 ← 10.3 *
 9.9 ← 10.0 → 10.4 * 10.5 * 10.5 *
 beste Teiler 102.1 (32.) 102.4 (33.) 111.9 (31.)
 Trefferlage 0.21 mm links, 0.00 mm
 Streuwert 1.28, horizontal: 1.62, vertikal: 0.80

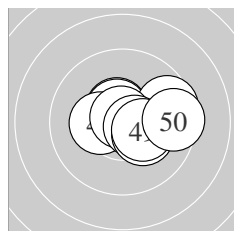

Serie 5:
 10.4 * 10.5 * 10.6 * 10.3 * 9.6 →
 10.8 * 10.6 * 10.3 * 10.3 * 9.5 →
 beste Teiler 35.7 (46.) 91.7 (47.) 93.4 (43.)
 Trefferlage 0.93 mm rechts, 0.09 mm hoch
 Streuwert 1.26, horizontal: 1.64, vertikal: 0.69

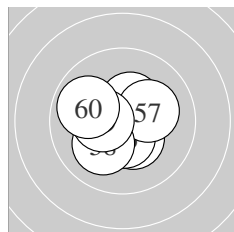

Serie 6:
 10.7 * 10.4 * 10.6 * 10.4 * 10.4 *
 10.5 * 10.2 * 10.1 ✓ 10.4 * 9.9 ←
 beste Teiler 56.0 (51.) 91.2 (53.) 115.6 (56.)
 Trefferlage 0.39 mm links, 0.00 mm
 Streuwert 1.17, horizontal: 1.32, vertikal: 1.00

Meyton Elektronik

ISSF AR Women – Wertung – Frauen

StandNr: 102

Simon, Julia #405

StartNr: 2

21. Januar 2020 9:53

GER

Unterschrift des Schützen

Meyton Elektronik

Ergebnis:	626.6	(596)							
Serien:	104.7	103.3	103.1	105.8	103.9	105.8			
Zähler:	56	4	0	0	0	0	0	0	0
Innenzehner:	52								
weiteste:	366	(17),	347	(22),	282	(11)			
beste Teiler	14.4	(16.)	31.1	(33.)	32.0	(60.)			
Trefferlage	0.09 mm links, 0.08 mm hoch								
Streuwert	1.05, horizontal: 1.17, vertikal: 0.90								

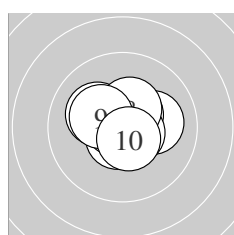
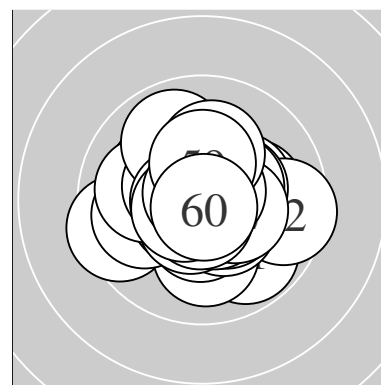

Serie 1:					
	10.6 *	10.6 *	10.1 →	10.5 *	10.8 *
	10.6 *	10.2 *	10.4 *	10.3 *	10.6 *
beste Teiler	47.5 (5.) 79.6 (2.) 82.7 (6.)				
Trefferlage	0.08 mm rechts, 0.31 mm hoch				
Streuwert	0.95, horizontal: 1.13, vertikal: 0.73				

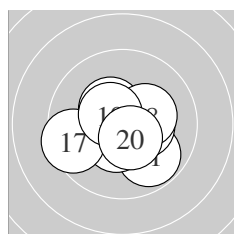

Serie 2:					
	9.8 ↘	10.4 *	10.4 *	10.5 *	10.5 *
	10.9 *	9.5 ←	10.3 *	10.5 *	10.5 *
beste Teiler	14.4 (16.) 101.5 (14.) 109.6 (19.)				
Trefferlage	0.12 mm links, 0.26 mm tief				
Streuwert	1.34, horizontal: 1.58, vertikal: 1.04				

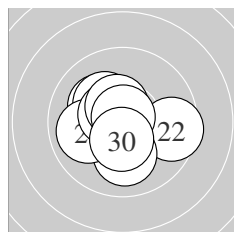

Serie 3:					
	10.7 *	9.6 →	10.1 ↓	10.2 *	10.2 *
	10.0 ←	10.5 *	10.5 *	10.8 *	10.5 *
beste Teiler	36.2 (29.) 70.4 (21.) 105.4 (27.)				
Trefferlage	0.35 mm links, 0.05 mm tief				
Streuwert	1.37, horizontal: 1.56, vertikal: 1.15				

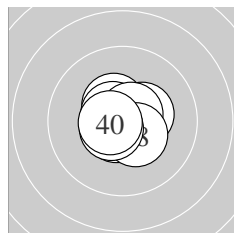

Serie 4:					
	10.6 *	10.4 *	10.8 *	10.8 *	10.4 *
	10.6 *	10.6 *	10.4 *	10.6 *	10.6 *
beste Teiler	31.1 (33.) 34.7 (34.) 76.0 (37.)				
Trefferlage	0.05 mm links, 0.03 mm hoch				
Streuwert	0.72, horizontal: 0.78, vertikal: 0.65				

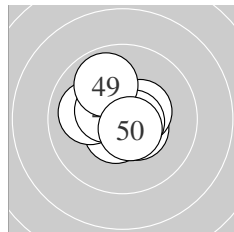

Serie 5:					
	10.6 *	10.5 *	10.3 *	10.5 *	10.0 ←
	10.4 *	10.4 *	10.7 *	9.9 ↗	10.6 *
beste Teiler	72.5 (48.) 86.2 (50.) 99.3 (41.)				
Trefferlage	0.21 mm links, 0.26 mm hoch				
Streuwert	1.12, horizontal: 1.26, vertikal: 0.95				

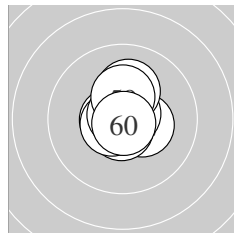

Serie 6:					
	10.7 *	10.4 *	10.7 *	10.7 *	10.6 *
	10.6 *	10.8 *	10.2 *	10.3 *	10.8 *
beste Teiler	32.0 (60.) 39.6 (57.) 57.4 (54.)				
Trefferlage	0.09 mm rechts, 0.19 mm hoch				
Streuwert	0.77, horizontal: 0.64, vertikal: 0.89				

Meyton Elektronik

ISSF AR Women – Wertung – Frauen

StandNr: 103

Brazdova, Lucie #472

StartNr: 3

21. Januar 2020 9:42

CZE

Unterschrift des Schützen

Meyton Elektronik

Ergebnis: **604.4** (577)

Serien: 100.7 100.0 99.6 102.5 100.5 101.1

Zähler: 38 21 1 0 0 0 0 0 0 0

Innenzehner: 32

weiteste: 557 (19), 475 (49), 440 (52)

beste Teiler 52.3 (18.) 56.6 (60.) 63.2 (50.)

Trefferlage 0.01 mm rechts, 0.03 mm hoch

Streuwert 1.78, horizontal: 1.91, vertikal: 1.65

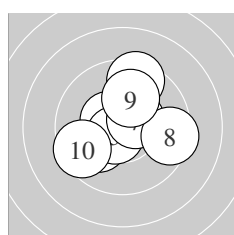
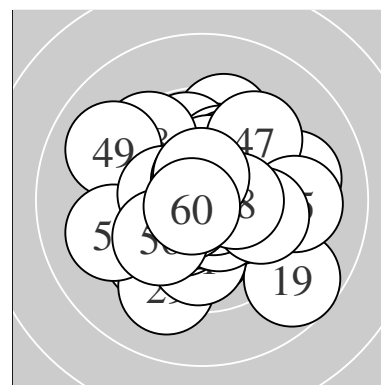

Serie 1:

10.1 ↙	10.4 *	10.2 *	10.5 *	10.6 *
9.4 ↑	10.5 *	9.5 →	10.0 ↑	9.5 ↙

beste Teiler 85.5 (5.) 115.6 (7.) 118.9 (4.)

Trefferlage 0.05 mm rechts, 0.58 mm hoch

Streuwert 1.78, horizontal: 1.86, vertikal: 1.69

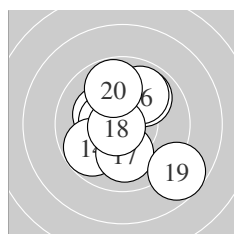

Serie 2:

10.5 *	10.2 *	10.5 *	9.8 ↙	9.9 ↗
9.9 ↗	10.0 ↓	10.7 *	8.7 ↘	9.8 ↑

beste Teiler 52.3 (18.) 120.2 (13.) 125.0 (11.)

Trefferlage 0.03 mm links, 0.01 mm hoch

Streuwert 2.02, horizontal: 1.94, vertikal: 2.09

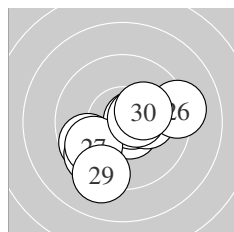

Serie 3:

10.6 *	9.7 ↙	10.6 *	9.6 ↙	10.2 *
9.2 →	9.8 ↙	10.5 *	9.2 ↓	10.2 *

beste Teiler 76.2 (23.) 82.8 (21.) 111.1 (28.)

Trefferlage 0.11 mm rechts, 0.80 mm tief

Streuwert 1.98, horizontal: 2.28, vertikal: 1.64

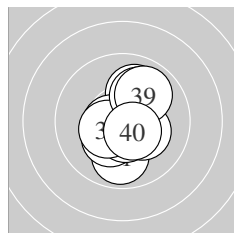

Serie 4:

9.9 ↓	10.3 *	10.3 *	10.6 *	10.0 ↑
10.6 *	10.4 *	10.0 ↑	9.9 ↗	10.5 *

beste Teiler 90.4 (36.) 99.4 (34.) 109.6 (40.)

Trefferlage 0.30 mm rechts, 0.12 mm tief

Streuwert 1.37, horizontal: 1.06, vertikal: 1.63

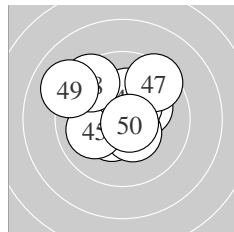

Serie 5:

10.2 *	10.4 *	10.4 *	10.4 *	10.0 ↙
10.3 *	9.5 ↗	9.5 ↘	9.1 ↘	10.7 *

beste Teiler 63.2 (50.) 132.9 (42.) 133.8 (43.)

Trefferlage 0.29 mm links, 0.83 mm hoch

Streuwert 1.83, horizontal: 2.06, vertikal: 1.57

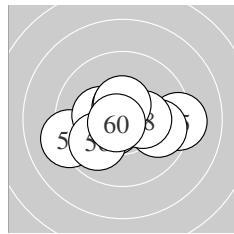

Serie 6:

10.6 *	9.2 ↙	10.3 *	10.6 *	9.2 →
9.9 ↙	9.8 →	10.3 *	10.5 *	10.7 *

beste Teiler 56.6 (60.) 90.0 (54.) 95.6 (51.)

Trefferlage 0.05 mm links, 0.28 mm tief

Streuwert 1.84, horizontal: 2.43, vertikal: 0.92

Meyton Elektronik

ISSF AR Women – Wertung – Frauen

StandNr: 104

Babenko, Mariia #475

StartNr: 4

21. Januar 2020 9:40

HSG

Unterschrift des Schützen

Meyton Elektronik

Ergebnis:	629.4	(598) ^{QF}
Serien:	103.4	105.2 104.2 105.8 105.8 105.0
Zähler:	58	2 0 0 0 0 0 0 0 0
Innenzehner:	58	
weiteste:	297 (8), 289 (4), 199 (13)	
beste Teiler	29.7 (16.)	52.8 (36.) 53.6 (23.)
Trefferlage	0.09 mm rechts, 0.01 mm tief	
Streuwert	0.92, horizontal: 1.04, vertikal: 0.78	

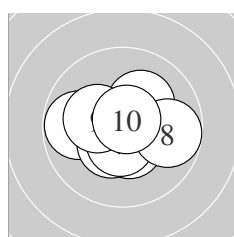
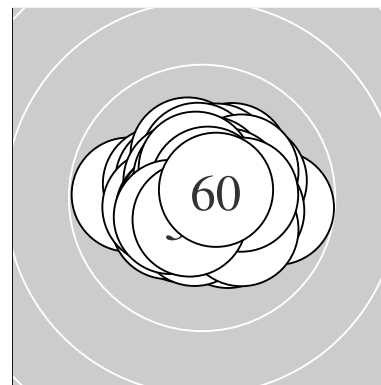

Serie 1:	10.7 *	10.4 *	10.5 *	9.8 ←	10.4 *
	10.2 *	10.6 *	9.8 →	10.3 *	10.7 *
beste Teiler	57.2 (10.) 75.8 (1.) 99.1 (7.)				
Trefferlage	0.26 mm links, 0.15 mm tief				
Streuwert	1.30, horizontal: 1.63, vertikal: 0.84				

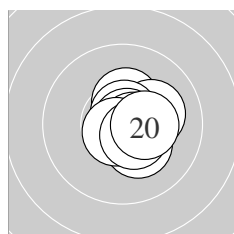

Serie 2:	10.5 *	10.4 *	10.2 *	10.3 *	10.7 *
	10.8 *	10.7 *	10.7 *	10.5 *	10.4 *
beste Teiler	29.7 (16.) 64.6 (18.) 64.9 (15.)				
Trefferlage	0.70 mm rechts, 0.05 mm hoch				
Streuwert	0.74, horizontal: 0.68, vertikal: 0.79				

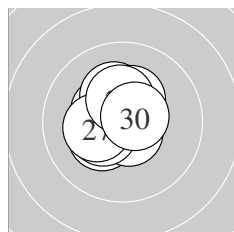

Serie 3:	10.3 *	10.6 *	10.7 *	10.4 *	10.4 *
	10.2 *	10.3 *	10.3 *	10.4 *	10.6 *
beste Teiler	53.6 (23.) 76.8 (22.) 88.5 (30.)				
Trefferlage	0.42 mm links, 0.36 mm hoch				
Streuwert	0.94, horizontal: 0.90, vertikal: 0.99				

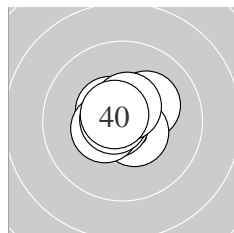

Serie 4:	10.7 *	10.5 *	10.2 *	10.7 *	10.5 *
	10.7 *	10.5 *	10.7 *	10.6 *	10.7 *
beste Teiler	52.8 (36.) 57.5 (38.) 68.2 (40.)				
Trefferlage	0.01 mm rechts, 0.12 mm hoch				
Streuwert	0.76, horizontal: 0.86, vertikal: 0.63				

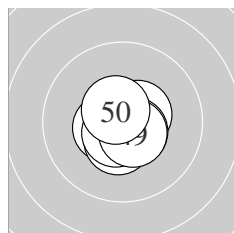

Serie 5:	10.6 *	10.5 *	10.6 *	10.7 *	10.5 *
	10.6 *	10.5 *	10.6 *	10.6 *	10.6 *
beste Teiler	68.5 (44.) 83.5 (46.) 85.8 (43.)				
Trefferlage	0.07 mm rechts, 0.34 mm tief				
Streuwert	0.68, horizontal: 0.70, vertikal: 0.66				

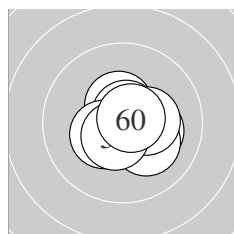

Serie 6:	10.5 *	10.7 *	10.2 *	10.7 *	10.7 *
	10.2 *	10.4 *	10.3 *	10.6 *	10.7 *
beste Teiler	56.4 (55.) 60.5 (54.) 63.6 (60.)				
Trefferlage	0.47 mm rechts, 0.16 mm tief				
Streuwert	0.86, horizontal: 0.97, vertikal: 0.73				

Meyton Elektronik

ISSF AR Women – Wertung – Frauen

StandNr: 105

Brabcova, Aneta #29

StartNr: 5

21. Januar 2020 9:49

CZE

QF – Schütze hat sich fürs Finale qualifiziert

Unterschrift des Schützen

Meyton Elektronik

Ergebnis:	629.5	(597) ^{QF}							
Serien:	106.2	105.0	104.9	105.2	103.8	104.4			
Zähler:	57	3	0	0	0	0	0	0	0
Innenzehner:	52								
weiteste:	295 (24), 294 (36), 258 (43)								
beste Teiler	18.4 (53.)	20.1 (38.)	21.5 (40.)						
Trefferlage	0.32 mm links, 0.17 mm hoch								
Streuwert	0.93, horizontal: 0.84, vertikal: 1.01								

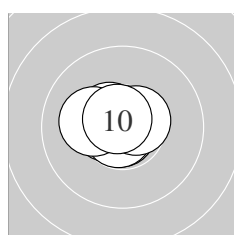
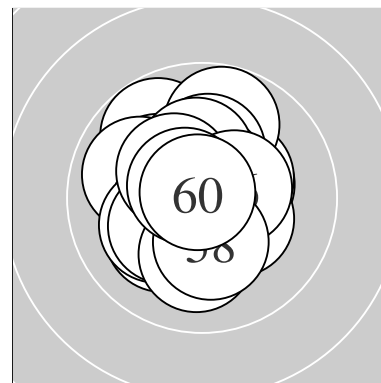

Serie 1:	10.8 *	10.8 *	10.8 *	10.4 *	10.6 *
	10.8 *	10.5 *	10.6 *	10.2 *	10.7 *
beste Teiler	34.1 (3.)	34.7 (2.)	46.4 (6.)		
Trefferlage	0.50 mm links, 0.20 mm hoch				
Streuwert	0.61, horizontal: 0.78, vertikal: 0.37				

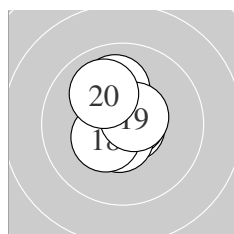

Serie 2:	10.7 *	10.6 *	10.7 *	10.7 *	10.7 *
	10.0 ↑	10.6 *	10.4 *	10.6 *	10.0 ↘
beste Teiler	53.4 (13.)	60.1 (15.)	60.4 (14.)		
Trefferlage	0.20 mm links, 0.32 mm hoch				
Streuwert	0.91, horizontal: 0.66, vertikal: 1.10				

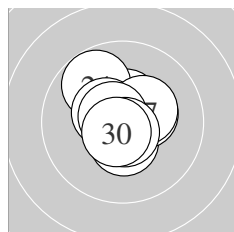

Serie 3:	10.8 *	10.5 *	10.5 *	9.8 ↘	10.4 *
	10.5 *	10.3 *	10.7 *	10.7 *	10.7 *
beste Teiler	27.2 (21.)	66.4 (29.)	73.9 (28.)		
Trefferlage	0.06 mm links, 0.36 mm hoch				
Streuwert	1.00, horizontal: 0.96, vertikal: 1.04				

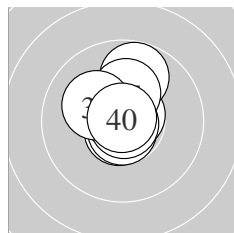

Serie 4:	10.7 *	10.7 *	10.7 *	10.5 *	10.6 *
	9.8 ↑	10.2 *	10.9 *	10.2 *	10.9 *
beste Teiler	20.1 (38.)	21.5 (40.)	60.0 (32.)		
Trefferlage	0.18 mm links, 0.65 mm hoch				
Streuwert	0.91, horizontal: 0.70, vertikal: 1.08				

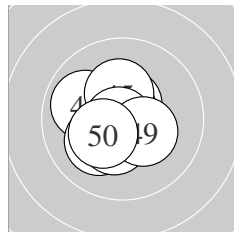

Serie 5:	10.6 *	10.8 *	9.9 ↘	10.3 *	10.3 *
	10.8 *	10.1 ↙	10.4 *	10.3 *	10.3 *
beste Teiler	31.0 (46.)	44.0 (42.)	99.9 (41.)		
Trefferlage	0.57 mm links, 0.17 mm tief				
Streuwert	1.08, horizontal: 1.06, vertikal: 1.10				

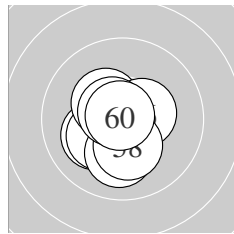

Serie 6:	10.1 ↙	10.6 *	10.9 *	10.2 *	10.4 *
	10.4 *	10.1 ↓	10.3 *	10.6 *	10.8 *
beste Teiler	18.4 (53.)	28.4 (60.)	82.4 (59.)		
Trefferlage	0.42 mm links, 0.33 mm tief				
Streuwert	1.00, horizontal: 0.89, vertikal: 1.10				

ISSF AR Women – Wertung – Frauen

StandNr: 107

Martinez, Gabriela #469

StartNr: 7

21. Januar 2020 9:54

MEX

QF – Schütze hat sich fürs Finale qualifiziert

Unterschrift des Schützen

Meyton Elektronik

Ergebnis: **614.2** (587)
 Serien: 102.6 102.6 102.5 102.0 103.4 101.1
 Zähler: 47 13 0 0 0 0 0 0 0
 Innenzehner: 37
 weiteste: 494 (20), 381 (40), 355 (10)
 beste Teiler 12.0 (9.) 34.0 (17.) 44.3 (58.)
 Trefferlage 0.38 mm rechts, 0.05 mm tief
 Streuwert 1.43, horizontal: 1.58, vertikal: 1.27

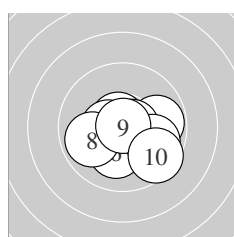
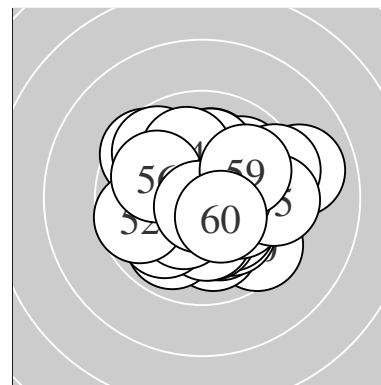

Serie 1:
 10.5 * 9.8 → 10.7 * 10.7 * 10.5 *
 10.2 * 9.9 ↘ 9.9 ← 10.9 * 9.5 ↘
 beste Teiler 12.0 (9.) 71.3 (3.) 74.0 (4.)
 Trefferlage 0.50 mm rechts, 0.59 mm tief
 Streuwert 1.42, horizontal: 1.75, vertikal: 0.99

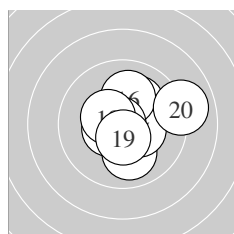

Serie 2:
 10.1 ↗ 10.8 * 10.0 ↓ 10.5 * 10.4 *
 10.1 ↑ 10.8 * 10.4 * 10.5 * 9.0 →
 beste Teiler 34.0 (17.) 46.0 (12.) 109.1 (19.)
 Trefferlage 0.59 mm rechts, 0.12 mm hoch
 Streuwert 1.53, horizontal: 1.68, vertikal: 1.35

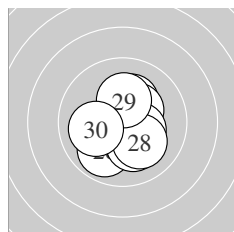

Serie 3:
 10.2 * 10.7 * 10.4 * 10.3 * 10.4 *
 9.9 ↙ 10.2 * 10.1 ↘ 10.2 * 10.1 ←
 beste Teiler 61.1 (22.) 145.3 (25.) 148.1 (23.)
 Trefferlage 0.28 mm rechts, 0.28 mm tief
 Streuwert 1.34, horizontal: 1.22, vertikal: 1.46

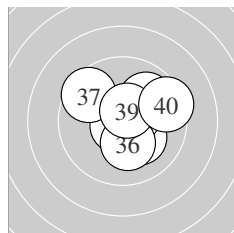

Serie 4:
 10.7 * 10.5 * 10.4 * 10.2 * 10.5 *
 10.2 * 9.6 ↖ 9.9 ↗ 10.6 * 9.4 →
 beste Teiler 55.9 (31.) 92.7 (39.) 105.1 (35.)
 Trefferlage 0.75 mm rechts, 0.32 mm hoch
 Streuwert 1.47, horizontal: 1.63, vertikal: 1.30

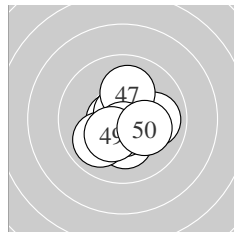

Serie 5:
 10.5 * 10.2 * 10.7 * 10.0 ↖ 10.0 →
 10.8 * 10.1 ↑ 10.6 * 10.3 * 10.2 *
 beste Teiler 49.7 (46.) 74.5 (43.) 84.1 (48.)
 Trefferlage 0.17 mm rechts, 0.27 mm tief
 Streuwert 1.25, horizontal: 1.26, vertikal: 1.25

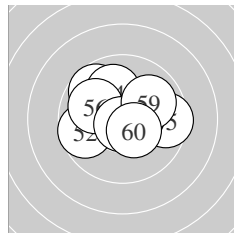

Serie 6:
 10.6 * 9.7 ← 9.7 ↖ 10.0 ↑ 9.5 →
 10.0 ↖ 10.5 * 10.8 * 9.9 ↗ 10.4 *
 beste Teiler 44.3 (58.) 99.0 (51.) 111.0 (57.)
 Trefferlage 0.00 mm , 0.37 mm hoch
 Streuwert 1.71, horizontal: 2.08, vertikal: 1.24

Meyton Elektronik

ISSF AR Women – Wertung – Frauen

StandNr: 108

Gleeson,, Katie #479

StartNr: 8

21. Januar 2020 9:58

GBR

Unterschrift des Schützen

Meyton Elektronik

Ergebnis:	623.7	(593)					
Serien:	105.5	104.9	104.0	102.5	102.9	103.9	
Zähler:	53	7	0	0	0	0	0
Innenzehner:	45						
weiteste:	435 (35), 365 (38), 359 (5)						
beste Teiler	8.9 (32.) 39.1 (49.) 41.4 (37.)						
Trefferlage	0.23 mm links, 0.20 mm hoch						
Streuwert	1.16, horizontal: 1.30, vertikal: 1.00						

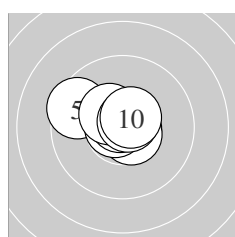
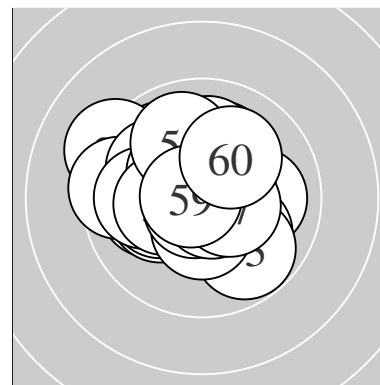

Serie 1:	10.7 *	10.7 *	10.8 *	10.6 *	9.5 ↘
	10.7 *	10.8 *	10.4 *	10.7 *	10.6 *
beste Teiler	43.8 (7.) 50.9 (3.) 55.0 (6.)				
Trefferlage	0.31 mm links, 0.41 mm hoch				
Streuwert	0.92, horizontal: 1.19, vertikal: 0.54				

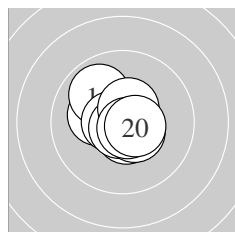

Serie 2:	10.5 *	10.2 *	10.6 *	9.9 ↘	10.6 *
	10.8 *	10.5 *	10.5 *	10.7 *	10.6 *
beste Teiler	47.5 (16.) 56.0 (19.) 78.0 (15.)				
Trefferlage	0.24 mm links, 0.17 mm hoch				
Streuwert	0.95, horizontal: 0.99, vertikal: 0.91				

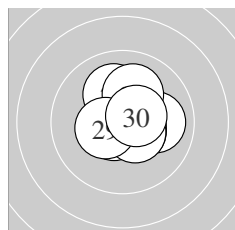

Serie 3:	10.0 →	10.7 *	10.5 *	10.1 ↗	10.6 *
	10.1 ↗	10.6 *	10.5 *	10.4 *	10.5 *
beste Teiler	74.0 (22.) 84.2 (25.) 100.9 (27.)				
Trefferlage	0.49 mm rechts, 0.21 mm hoch				
Streuwert	1.05, horizontal: 1.06, vertikal: 1.04				

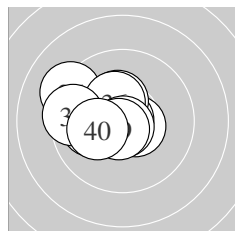

Serie 4:	10.6 *	10.9 *	10.3 *	10.0 ←	9.2 ↘
	10.3 *	10.8 *	9.5 ←	10.7 *	10.2 *
beste Teiler	8.9 (32.) 41.4 (37.) 65.3 (39.)				
Trefferlage	1.17 mm links, 0.31 mm hoch				
Streuwert	1.35, horizontal: 1.63, vertikal: 0.99				

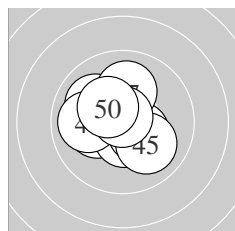

Serie 5:	10.2 *	10.5 *	10.7 *	10.4 *	10.0 ↘
	10.0 ↘	10.1 ↗	9.9 ←	10.8 *	10.3 *
beste Teiler	39.1 (49.) 66.6 (43.) 108.6 (42.)				
Trefferlage	0.40 mm links, 0.18 mm hoch				
Streuwert	1.29, horizontal: 1.40, vertikal: 1.17				

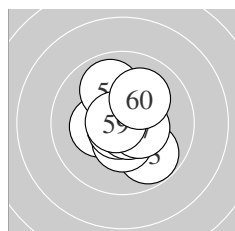

Serie 6:	10.7 *	10.3 *	9.8 ↘	10.4 *	10.7 *
	10.7 *	10.5 *	9.9 ↗	10.8 *	10.1 ↗
beste Teiler	49.4 (59.) 51.8 (55.) 60.1 (56.)				
Trefferlage	0.20 mm rechts, 0.06 mm tief				
Streuwert	1.22, horizontal: 1.08, vertikal: 1.34				

Meyton Elektronik

ISSF AR Women – Wertung – Frauen

StandNr: 109

Engler, Tal #471

StartNr: 9

21. Januar 2020 9:46

ISR

Unterschrift des Schützen

Meyton Elektronik

Ergebnis: **622.6** (593)

Serien: 102.6 105.5 102.9 103.1 104.8 103.7

Zähler: 53 7 0 0 0 0 0 0 0

Innenzehner: 44

weiteste: 315 (25), 296 (55), 290 (33)

beste Teiler 20.0 (46.) 29.4 (16.) 31.6 (30.)

Trefferlage 0.18 mm links, 0.17 mm hoch

Streuwert 1.15, horizontal: 1.37, vertikal: 0.87

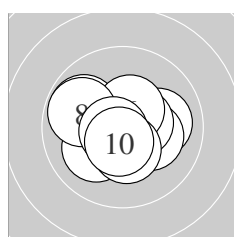
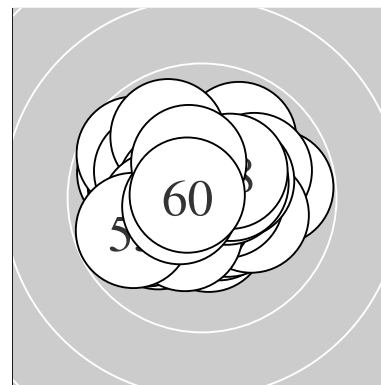

Serie 1:

10.0 →	9.8 ↖	10.1 ↙	10.2 *	10.5 *
10.5 *	10.4 *	9.8 ↖	10.7 *	10.6 *

beste Teiler 65.7 (9.) 96.7 (10.) 110.1 (5.)

Trefferlage 0.18 mm links, 0.06 mm tief

Streuwert 1.39, horizontal: 1.70, vertikal: 0.99

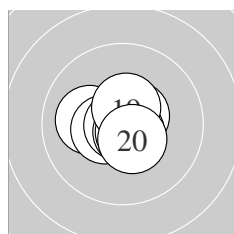

Serie 2:

10.7 *	10.4 *	10.1 ←	10.6 *	10.5 *
10.8 *	10.7 *	10.7 *	10.5 *	10.5 *

beste Teiler 29.4 (16.) 57.6 (11.) 58.8 (17.)

Trefferlage 0.27 mm links, 0.00 mm

Streuwert 0.81, horizontal: 0.96, vertikal: 0.61

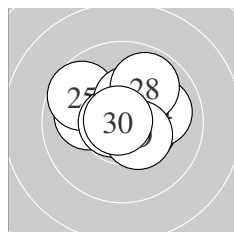

Serie 3:

10.1 ←	10.4 *	10.5 *	10.0 →	9.7 ↖
10.7 *	10.4 *	9.9 ↗	10.4 *	10.8 *

beste Teiler 31.6 (30.) 64.0 (26.) 117.8 (23.)

Trefferlage 0.11 mm rechts, 0.63 mm hoch

Streuwert 1.32, horizontal: 1.59, vertikal: 0.97

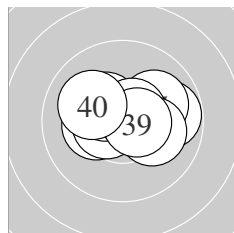

Serie 4:

10.3 *	10.5 *	9.8 →	10.4 *	10.0 →
10.7 *	10.6 *	10.1 ↘	10.6 *	10.1 ↖

beste Teiler 70.0 (36.) 82.2 (37.) 94.4 (39.)

Trefferlage 0.30 mm rechts, 0.32 mm hoch

Streuwert 1.27, horizontal: 1.69, vertikal: 0.61

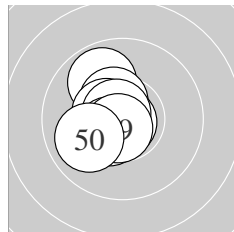

Serie 5:

9.9 ↘	10.4 *	10.6 *	10.6 *	10.5 *
10.9 *	10.7 *	10.5 *	10.7 *	10.0 ←

beste Teiler 20.0 (46.) 53.9 (47.) 66.6 (49.)

Trefferlage 0.84 mm links, 0.10 mm hoch

Streuwert 0.86, horizontal: 0.60, vertikal: 1.05

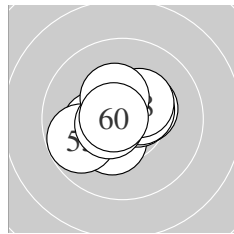

Serie 6:

10.4 *	10.2 *	10.3 *	10.5 *	9.8 ←
10.4 *	10.6 *	10.4 *	10.4 *	10.7 *

beste Teiler 59.0 (60.) 93.4 (57.) 104.7 (54.)

Trefferlage 0.25 mm links, 0.07 mm hoch

Streuwert 1.16, horizontal: 1.35, vertikal: 0.93

Meyton Elektronik

ISSF AR Women – Wertung – Frauen

StandNr: 110

Rossiter, Victoria #304

StartNr: 10

21. Januar 2020 9:51

AUS

Unterschrift des Schützen

Meyton Elektronik

Ergebnis: **629.6** (597)^{QF}
 Serien: 104.9 104.9 104.0 106.0 105.0 104.8
 Zähler: 57 3 0 0 0 0 0 0 0 0
 Innenzehner: 53
 weiteste: 271 (23), 268 (28), 254 (13)
 beste Teiler 1.4 (27.) 3.1 (37.) 9.8 (56.)
 Trefferlage 0.23 mm rechts, 0.17 mm hoch
 Streuwert 0.92, horizontal: 1.05, vertikal: 0.76

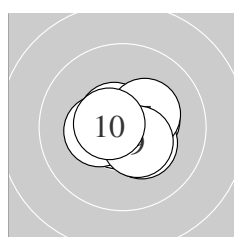
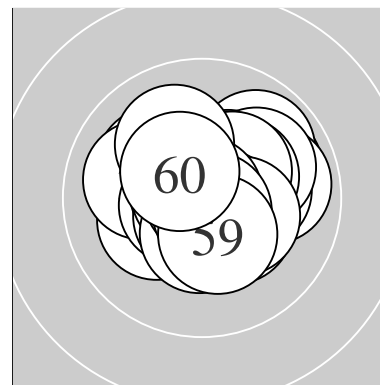

Serie 1:
 10.6 * 10.8 * 10.5 * 10.6 * 10.4 *
 10.3 * 10.3 * 10.4 * 10.4 * 10.6 *
 beste Teiler 50.2 (2.) 77.8 (4.) 85.7 (1.)
 Trefferlage 0.32 mm rechts, 0.16 mm tief
 Streuwert 0.85, horizontal: 1.02, vertikal: 0.64

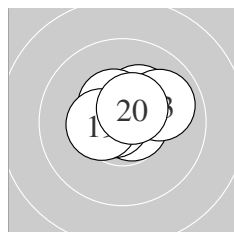

Serie 2:
 10.7 * 10.3 * 9.9 ↗ 10.6 * 10.7 *
 10.7 * 10.6 * 10.5 * 10.4 * 10.5 *
 beste Teiler 56.0 (16.) 61.9 (11.) 73.1 (15.)
 Trefferlage 0.14 mm rechts, 0.60 mm hoch
 Streuwert 0.83, horizontal: 1.04, vertikal: 0.55

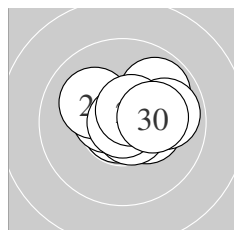

Serie 3:
 10.3 * 10.8 * 9.9 ↗ 10.6 * 10.1 ↘
 10.7 * 10.9 * 9.9 → 10.6 * 10.2 *
 beste Teiler 1.4 (27.) 41.8 (22.) 71.0 (26.)
 Trefferlage 0.61 mm rechts, 0.37 mm hoch
 Streuwert 1.12, horizontal: 1.40, vertikal: 0.73

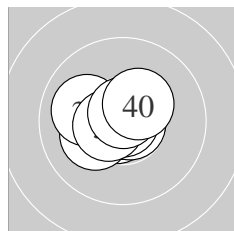

Serie 4:
 10.7 * 10.8 * 10.9 * 10.2 * 10.0 ↘
 10.8 * 10.9 * 10.6 * 10.7 * 10.4 *
 beste Teiler 3.1 (37.) 16.7 (33.) 49.0 (32.)
 Trefferlage 0.31 mm links, 0.03 mm hoch
 Streuwert 0.82, horizontal: 1.02, vertikal: 0.57

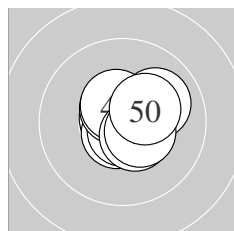

Serie 5:
 10.7 * 10.6 * 10.7 * 10.6 * 10.6 *
 10.5 * 10.0 ↗ 10.5 * 10.5 * 10.3 *
 beste Teiler 53.2 (41.) 54.0 (43.) 76.4 (42.)
 Trefferlage 0.41 mm rechts, 0.21 mm hoch
 Streuwert 0.85, horizontal: 0.90, vertikal: 0.80

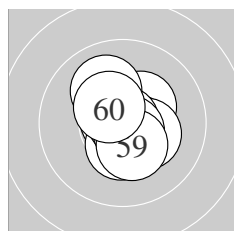

Serie 6:
 10.3 * 10.8 * 10.4 * 10.6 * 10.3 *
 10.9 * 10.7 * 10.0 ↘ 10.4 * 10.4 *
 beste Teiler 9.8 (56.) 44.9 (52.) 63.6 (57.)
 Trefferlage 0.19 mm rechts, 0.00 mm
 Streuwert 0.97, horizontal: 0.82, vertikal: 1.09

Meyton Elektronik

QF – Schütze hat sich fürs Finale qualifiziert

Unterschrift des Schützen

Meyton Elektronik

Ergebnis: **625.4** (593)
 Serien: 104.3 104.3 105.2 104.5 103.1 104.0
 Zähler: 53 7 0 0 0 0 0 0 0
 Innenzehner: 49
 weiteste: 314 (45), 304 (53), 293 (51)
 beste Teiler 19.8 (28.) 24.1 (57.) 29.1 (54.)
 Trefferlage 0.03 mm links, 0.12 mm hoch
 Streuwert 1.09, horizontal: 1.30, vertikal: 0.83

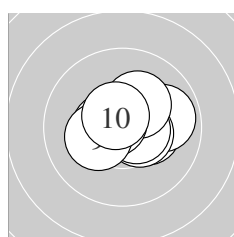
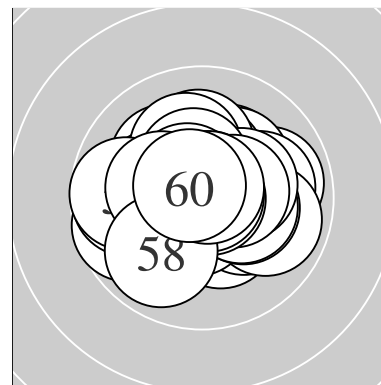

Serie 1:
 10.5 * 10.3 * 9.9 → 10.5 * 10.7 *
 10.6 * 10.2 * 10.7 * 10.3 * 10.6 *
 beste Teiler 52.8 (5.) 69.3 (8.) 89.3 (10.)
 Trefferlage 0.31 mm rechts, 0.20 mm hoch
 Streuwert 1.05, horizontal: 1.34, vertikal: 0.64

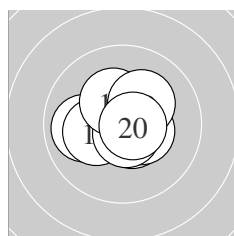

Serie 2:
 10.5 * 10.8 * 10.6 * 9.9 ← 10.4 *
 10.2 * 10.7 * 10.3 * 10.2 * 10.7 *
 beste Teiler 41.2 (12.) 68.7 (17.) 69.0 (20.)
 Trefferlage 0.13 mm links, 0.07 mm hoch
 Streuwert 1.06, horizontal: 1.23, vertikal: 0.86

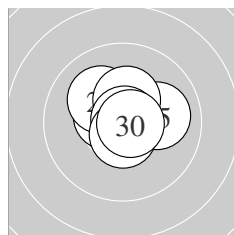

Serie 3:
 10.8 * 10.6 * 10.6 * 10.5 * 10.0 →
 10.1 ↘ 10.4 * 10.9 * 10.6 * 10.7 *
 beste Teiler 19.8 (28.) 35.3 (21.) 52.9 (30.)
 Trefferlage 0.04 mm links, 0.39 mm hoch
 Streuwert 0.89, horizontal: 1.04, vertikal: 0.71

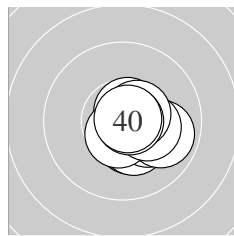

Serie 4:
 10.4 * 10.3 * 10.2 * 9.9 → 10.7 *
 10.6 * 10.3 * 10.5 * 10.8 * 10.8 *
 beste Teiler 37.6 (40.) 48.0 (39.) 72.8 (35.)
 Trefferlage 0.89 mm rechts, 0.43 mm tief
 Streuwert 0.77, horizontal: 0.83, vertikal: 0.72

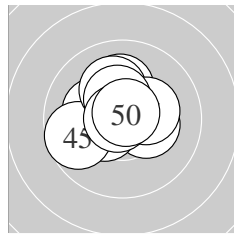

Serie 5:
 10.3 * 10.4 * 10.1 ↑ 10.2 * 9.7 ←
 10.1 ↑ 10.3 * 10.4 * 10.8 * 10.8 *
 beste Teiler 35.2 (49.) 48.3 (50.) 131.5 (42.)
 Trefferlage 0.40 mm links, 0.48 mm hoch
 Streuwert 1.23, horizontal: 1.38, vertikal: 1.05

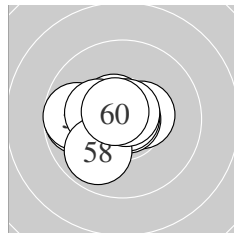

Serie 6:
 9.8 ← 10.5 * 9.7 ← 10.8 * 10.6 *
 10.3 * 10.9 * 9.9 ↙ 10.8 * 10.7 *
 beste Teiler 24.1 (57.) 29.1 (54.) 47.4 (59.)
 Trefferlage 0.83 mm links, 0.03 mm hoch
 Streuwert 1.16, horizontal: 1.43, vertikal: 0.79

Meyton Elektronik

ISSF AR Women – Wertung – Frauen

StandNr: 112

Leone, Chiara #426

StartNr: 12

21. Januar 2020 9:53

SUI

Unterschrift des Schützen

Meyton Elektronik

Ergebnis:	617.6	(590)
Serien:	102.5	102.8 102.3 102.2 103.2 104.6
Zähler:	50	10 0 0 0 0 0 0 0 0
Innenzehner:	40	
weiteste:	390	(59), 350 (29), 345 (12)
beste Teiler	13.0	(51.) 40.1 (57.) 43.4 (33.)
Trefferlage	0.12 mm	rechts, 0.13 mm hoch
Streuwert	1.31,	horizontal: 1.43, vertikal: 1.19

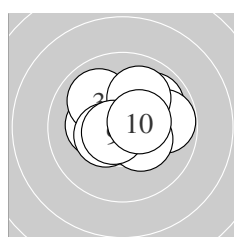
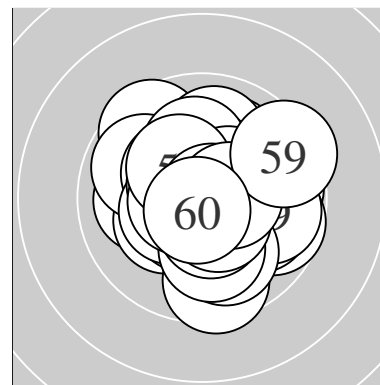

Serie 1:

10.2 *	10.7 *	10.0 ↘	9.9 ↗	10.4 *
9.8 →	10.0 ↗	10.3 *	10.7 *	10.5 *
beste Teiler	69.4 (2.)	73.4 (9.)	122.0 (10.)	
Trefferlage	0.32 mm rechts, 0.53 mm hoch			
Streuwert	1.35, horizontal: 1.62, vertikal: 1.01			

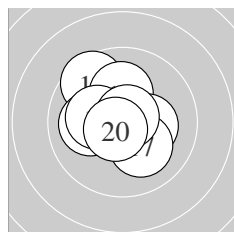

Serie 2:

10.1 ←	9.6 ↘	10.2 *	10.3 *	10.7 *
10.1 ←	10.1 ↘	10.2 *	10.8 *	10.7 *
beste Teiler	48.9 (19.)	55.3 (15.)	70.7 (20.)	
Trefferlage	0.61 mm links, 0.27 mm hoch			
Streuwert	1.34, horizontal: 1.43, vertikal: 1.24			

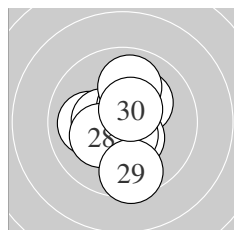

Serie 3:

10.0 ←	10.2 *	10.4 *	10.6 *	10.4 *
10.5 *	9.9 ↑	10.2 *	9.6 ↓	10.5 *
beste Teiler	93.4 (24.)	106.0 (30.)	110.8 (26.)	
Trefferlage	0.08 mm links, 0.06 mm tief			
Streuwert	1.44, horizontal: 1.19, vertikal: 1.66			

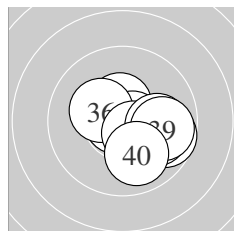

Serie 4:

9.7 →	10.5 *	10.8 *	10.7 *	9.9 →
10.3 *	10.5 *	10.0 →	9.8 →	10.0 ↓
beste Teiler	43.4 (33.)	70.4 (34.)	113.9 (37.)	
Trefferlage	1.08 mm rechts, 0.41 mm tief			
Streuwert	1.27, horizontal: 1.51, vertikal: 0.96			

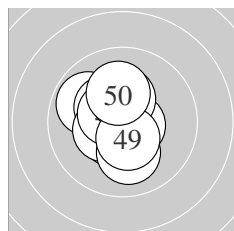

Serie 5:

10.5 *	9.9 ↘	10.3 *	10.4 *	10.5 *
10.6 *	10.3 *	10.1 ↓	10.5 *	10.1 ↑
beste Teiler	79.4 (46.)	109.6 (45.)	112.4 (41.)	
Trefferlage	0.51 mm links, 0.15 mm hoch			
Streuwert	1.18, horizontal: 0.97, vertikal: 1.35			

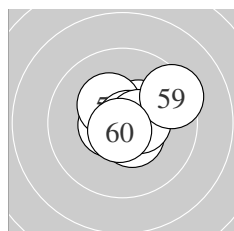

Serie 6:

10.9 *	10.5 *	10.4 *	10.6 *	10.3 *
10.5 *	10.8 *	10.5 *	9.4 →	10.7 *
beste Teiler	13.0 (51.)	40.1 (57.)	56.0 (60.)	
Trefferlage	0.57 mm rechts, 0.29 mm hoch			
Streuwert	1.07, horizontal: 1.27, vertikal: 0.83			

Meyton Elektronik

ISSF AR Women – Wertung – Frauen

StandNr: 113

Adams, Emma #412

StartNr: 13

21. Januar 2020 9:55

AUS

Unterschrift des Schützen

Meyton Elektronik

Ergebnis: **625.6** (594)
 Serien: 104.2 103.7 104.4 104.5 103.5 105.3
 Zähler: 54 6 0 0 0 0 0 0 0 0
 Innenzehner: 51
 weiteste: 306 (17), 289 (45), 275 (32)
 beste Teiler 4.4 (37.) 13.8 (40.) 44.9 (41.)
 Trefferlage 0.10 mm rechts, 0.36 mm hoch
 Streuwert 1.04, horizontal: 1.05, vertikal: 1.03

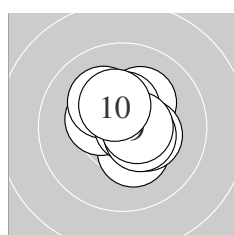
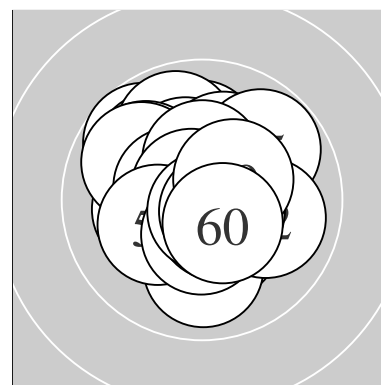

Serie 1:
 10.2 * 10.3 * 10.4 * 10.2 * 10.5 *
 10.8 * 10.3 * 10.5 * 10.6 * 10.4 *
 beste Teiler 48.3 (6.) 90.0 (9.) 120.7 (8.)
 Trefferlage 0.27 mm rechts, 0.37 mm hoch
 Streuwert 1.01, horizontal: 0.99, vertikal: 1.04

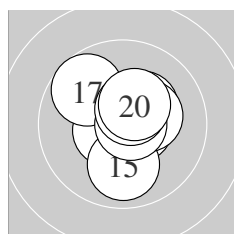

Serie 2:
 10.3 * 10.6 * 10.7 * 10.6 * 9.9 ↓
 10.3 * 9.7 ↘ 10.7 * 10.5 * 10.4 *
 beste Teiler 51.0 (18.) 55.0 (13.) 91.9 (12.)
 Trefferlage 0.22 mm rechts, 0.33 mm hoch
 Streuwert 1.17, horizontal: 1.10, vertikal: 1.24

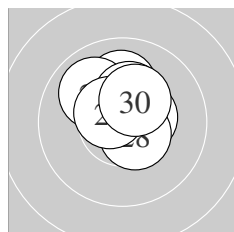

Serie 3:
 10.8 * 10.8 * 10.1 ↑ 10.0 ↖ 10.5 *
 10.5 * 10.3 * 10.5 * 10.6 * 10.3 *
 beste Teiler 47.0 (21.) 50.0 (22.) 99.4 (29.)
 Trefferlage 0.22 mm rechts, 0.81 mm hoch
 Streuwert 0.90, horizontal: 0.89, vertikal: 0.91

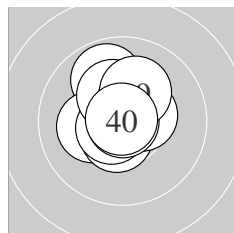

Serie 4:
 10.5 * 9.9 ↖ 10.2 * 10.5 * 10.6 *
 10.5 * 10.9 * 10.3 * 10.2 * 10.9 *
 beste Teiler 4.4 (37.) 13.8 (40.) 80.9 (35.)
 Trefferlage 0.36 mm links, 0.51 mm hoch
 Streuwert 1.02, horizontal: 0.90, vertikal: 1.12

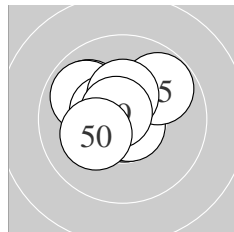

Serie 5:
 10.8 * 10.6 * 10.7 * 9.9 ↖ 9.8 ↗
 9.9 ↖ 10.5 * 10.4 * 10.7 * 10.2 *
 beste Teiler 44.9 (41.) 56.5 (43.) 57.2 (49.)
 Trefferlage 0.46 mm links, 0.61 mm hoch
 Streuwert 1.17, horizontal: 1.35, vertikal: 0.96

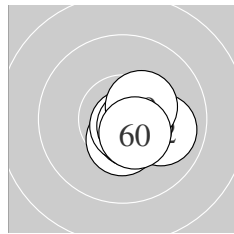

Serie 6:
 10.7 * 10.0 → 10.7 * 10.4 * 10.6 *
 10.6 * 10.8 * 10.6 * 10.4 * 10.5 *
 beste Teiler 46.5 (57.) 54.0 (53.) 55.8 (51.)
 Trefferlage 0.73 mm rechts, 0.47 mm tief
 Streuwert 0.60, horizontal: 0.67, vertikal: 0.53

Meyton Elektronik

ISSF AR Women – Wertung – Frauen

StandNr: 114

Benikova, Diana #481

StartNr: 14

21. Januar 2020 9:38

SVK

Unterschrift des Schützen

Meyton Elektronik

Ergebnis:	614.2	(584)
Serien:	103.4	103.2 102.7 104.0 101.3 99.6
Zähler:	45	14 1 0 0 0 0 0 0 0
Innenzehner:	38	
weiteste:	574	(54), 434 (43), 367 (57)
beste Teiler	10.1	(32.) 38.2 (39.) 38.6 (25.)
Trefferlage	0.60 mm	rechts, 0.02 mm hoch
Streuwert	1.45,	horizontal: 1.73, vertikal: 1.10

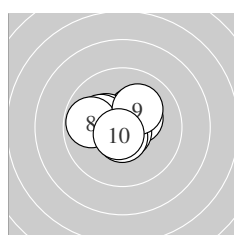
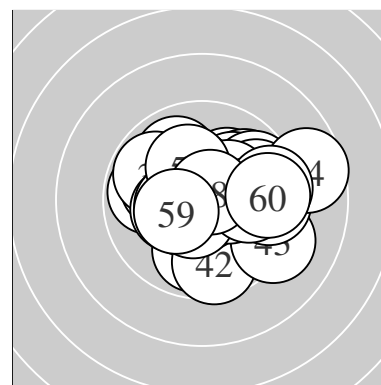

Serie 1:	10.4 *	10.3 *	10.3 *	10.3 *	10.7 *
	10.6 *	10.2 *	9.8 ←	10.1 ↗	10.7 *
beste Teiler	54.4 (5.)	71.1 (10.)	87.0 (6.)		
Trefferlage	0.38 mm links, 0.39 mm hoch				
Streuwert	1.15, horizontal: 1.41, vertikal: 0.81				

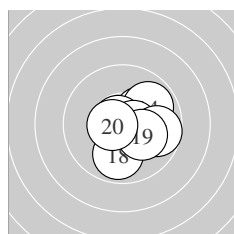

Serie 2:	10.2 *	10.6 *	10.7 *	9.9 ↗	10.8 *
	10.6 *	9.7 →	9.9 ↓	10.2 *	10.6 *
beste Teiler	49.4 (15.)	70.6 (13.)	79.0 (12.)		
Trefferlage	0.78 mm rechts, 0.17 mm tief				
Streuwert	1.25, horizontal: 1.35, vertikal: 1.13				

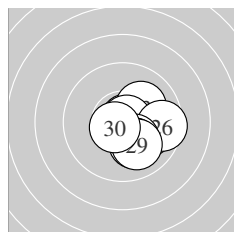

Serie 3:	10.5 *	10.8 *	10.1 ↗	10.0 ↘	10.8 *
	9.6 →	10.2 *	10.1 ↓	10.0 ↓	10.6 *
beste Teiler	38.6 (25.)	40.0 (22.)	82.9 (30.)		
Trefferlage	1.15 mm rechts, 0.58 mm tief				
Streuwert	1.08, horizontal: 1.13, vertikal: 1.03				

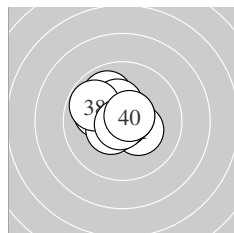

Serie 4:	10.3 *	10.9 *	10.1 ↖	10.5 *	9.9 ↖
	10.7 *	10.3 *	9.8 ↖	10.8 *	10.7 *
beste Teiler	10.1 (32.)	38.2 (39.)	72.2 (36.)		
Trefferlage	0.49 mm links, 0.48 mm hoch				
Streuwert	1.12, horizontal: 1.24, vertikal: 0.98				

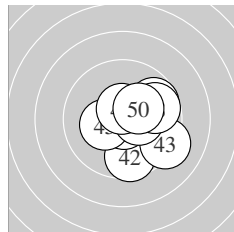

Serie 5:	10.7 *	9.6 ↓	9.2 ↘	10.8 *	10.3 *
	9.7 ↗	10.4 *	9.7 ↗	10.6 *	10.3 *
beste Teiler	45.6 (44.)	67.5 (41.)	90.3 (49.)		
Trefferlage	1.07 mm rechts, 0.25 mm tief				
Streuwert	1.59, horizontal: 1.69, vertikal: 1.49				

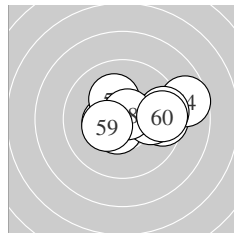

Serie 6:	10.6 *	10.4 *	9.5 →	8.7 →	10.0 →
	10.2 *	9.5 →	10.7 *	10.4 *	9.6 →
beste Teiler	59.4 (58.)	97.1 (51.)	138.0 (52.)		
Trefferlage	1.51 mm rechts, 0.26 mm hoch				
Streuwert	1.87, horizontal: 2.50, vertikal: 0.86				

Meyton Elektronik

ISSF AR Women – Wertung – Frauen

StandNr: 115

Goldfaden, Ella #336

StartNr: 17

21. Januar 2020 9:39

ISR

Unterschrift des Schützen

Meyton Elektronik

Ergebnis:	628.3	(598)
Serien:	104.3	105.7 103.8 105.3 104.9 104.3
Zähler:	58	2 0 0 0 0 0 0 0 0
Innenzehner:	53	
weiteste:	278	(23), 259 (56), 243 (6)
beste Teiler	33.1	(41.) 39.1 (17.) 40.3 (19.)
Trefferlage	0.20 mm	rechts, 0.00 mm
Streuwert	0.95,	horizontal: 1.04, vertikal: 0.84

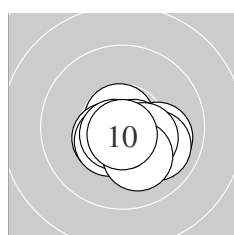
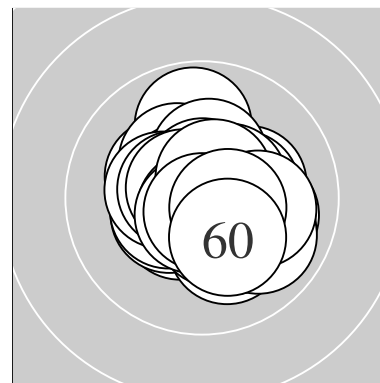

Serie 1:	10.7 *	10.5 *	10.6 *	10.0 →	10.5 *
	10.0 ↘	10.4 *	10.7 *	10.1 ↓	10.8 *
beste Teiler	48.0	(10.) 56.6	(1.) 69.3	(8.)	
Trefferlage	0.47 mm	rechts, 0.68 mm	tief		
Streuwert	0.93,	horizontal: 1.17,	vertikal: 0.60		

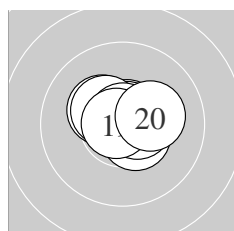

Serie 2:	10.7 *	10.7 *	10.5 *	10.7 *	10.3 *
	10.4 *	10.8 *	10.6 *	10.8 *	10.2 *
beste Teiler	39.1	(17.) 40.3	(19.) 56.0	(12.)	
Trefferlage	0.19 mm	rechts, 0.32 mm	hoch		
Streuwert	0.75,	horizontal: 0.94,	vertikal: 0.48		

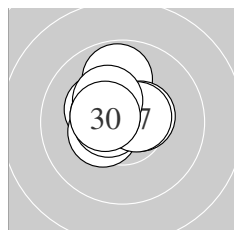

Serie 3:	10.3 *	10.3 *	9.8 ↑	10.5 *	10.4 *
	10.6 *	10.6 *	10.5 *	10.3 *	10.5 *
beste Teiler	90.0	(26.) 95.2	(27.) 117.9	(30.)	
Trefferlage	0.59 mm	links, 0.73 mm	hoch		
Streuwert	0.92,	horizontal: 0.90,	vertikal: 0.95		

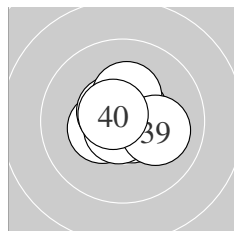

Serie 4:	10.4 *	10.5 *	10.7 *	10.6 *	10.7 *
	10.7 *	10.6 *	10.3 *	10.1 →	10.7 *
beste Teiler	52.9	(35.) 55.0	(36.) 72.2	(33.)	
Trefferlage	0.13 mm	rechts, 0.22 mm	hoch		
Streuwert	0.85,	horizontal: 0.93,	vertikal: 0.76		

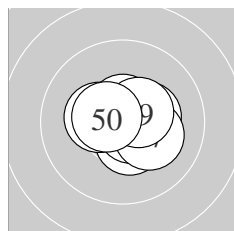

Serie 5:	10.8 *	10.3 *	10.5 *	10.7 *	10.5 *
	10.3 *	10.2 *	10.6 *	10.5 *	10.5 *
beste Teiler	33.1	(41.) 70.4	(44.) 81.0	(48.)	
Trefferlage	0.34 mm	rechts, 0.00 mm			
Streuwert	0.86,	horizontal: 1.05,	vertikal: 0.62		

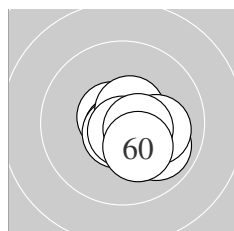

Serie 6:	10.6 *	10.8 *	10.2 *	10.7 *	10.6 *
	9.9 ↘	10.7 *	10.1 →	10.5 *	10.2 *
beste Teiler	50.6	(52.) 53.0	(57.) 72.4	(54.)	
Trefferlage	0.65 mm	rechts, 0.56 mm	tief		
Streuwert	0.89,	horizontal: 1.00,	vertikal: 0.76		

Meyton Elektronik

ISSF AR Women – Wertung – Frauen

StandNr: 116

Martina, Lindsay P Veloso #480

StartNr: 18

21. Januar 2020 9:52

SGP

Unterschrift des Schützen

Meyton Elektronik

Ergebnis: **625.6** (596)
 Serien: 102.9 103.5 104.6 106.2 104.1 104.3
 Zähler: 57 2 1 0 0 0 0 0 0
 Innenzehner: 53
 weiteste: 688 (2), 295 (14), 262 (55)
 beste Teiler 13.0 (7.) 13.0 (30.) 14.5 (36.)
 Trefferlage 0.00 mm , 0.19 mm tief
 Streuwert 1.16, horizontal: 1.09, vertikal: 1.22

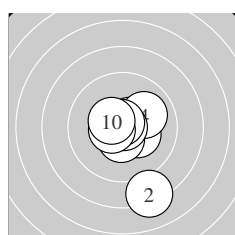
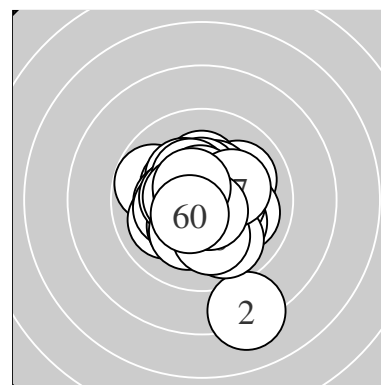

Serie 1:
 10.6 * 8.2 ↓ 10.3 * 10.0 ↗ 10.6 *
 10.5 * 10.9 * 10.8 * 10.5 * 10.5 *
 beste Teiler 13.0 (7.) 45.2 (8.) 88.4 (1.)
 Trefferlage 0.36 mm rechts, 0.51 mm tief
 Streuwert 1.78, horizontal: 1.28, vertikal: 2.17

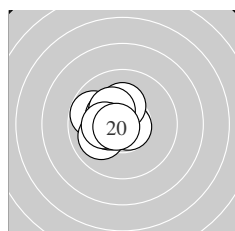

Serie 2:
 10.6 * 10.7 * 10.3 * 9.8 ↖ 10.0 ↙
 10.3 * 10.3 * 10.5 * 10.3 * 10.7 *
 beste Teiler 59.5 (12.) 65.9 (20.) 95.8 (11.)
 Trefferlage 1.11 mm links, 0.25 mm hoch
 Streuwert 0.93, horizontal: 0.96, vertikal: 0.90

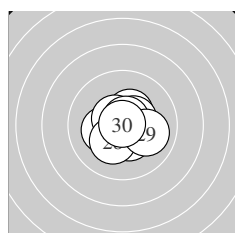

Serie 3:
 10.2 * 10.7 * 10.4 * 10.5 * 10.6 *
 10.7 * 10.4 * 10.2 * 10.0 → 10.9 *
 beste Teiler 13.0 (30.) 60.0 (22.) 61.4 (26.)
 Trefferlage 0.14 mm rechts, 0.14 mm tief
 Streuwert 1.01, horizontal: 1.12, vertikal: 0.88

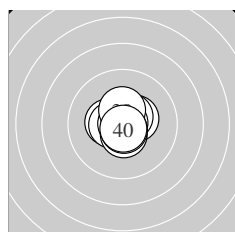

Serie 4:
 10.4 * 10.4 * 10.5 * 10.6 * 10.6 *
 10.9 * 10.9 * 10.7 * 10.4 * 10.8 *
 beste Teiler 14.5 (36.) 21.0 (37.) 44.5 (40.)
 Trefferlage 0.01 mm links, 0.08 mm hoch
 Streuwert 0.71, horizontal: 0.74, vertikal: 0.67

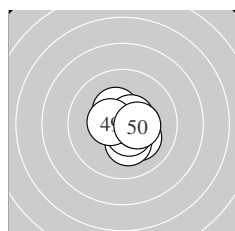

Serie 5:
 10.2 * 10.2 * 10.7 * 10.2 * 10.5 *
 10.4 * 10.4 * 10.6 * 10.5 * 10.4 *
 beste Teiler 55.0 (43.) 97.6 (48.) 104.4 (45.)
 Trefferlage 0.49 mm rechts, 0.32 mm tief
 Streuwert 0.96, horizontal: 0.89, vertikal: 1.03

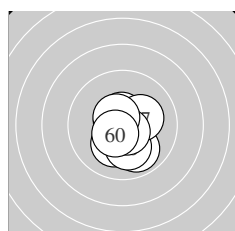

Serie 6:
 10.6 * 10.2 * 10.7 * 10.8 * 9.9 ↓
 10.1 ↓ 10.2 * 10.7 * 10.6 * 10.5 *
 beste Teiler 36.4 (54.) 67.1 (53.) 75.4 (58.)
 Trefferlage 0.15 mm rechts, 0.50 mm tief
 Streuwert 1.05, horizontal: 0.87, vertikal: 1.21

Meyton Elektronik

ISSF AR Women – Wertung – Frauen

StandNr: 117

McIntosh,, Seonaid #484

StartNr: 19

21. Januar 2020 9:48

GBR

Unterschrift des Schützen

Meyton Elektronik

Ergebnis:	621.4	(594)							
Serien:	102.5	104.5	102.1	105.3	104.3	102.7			
Zähler:	54	6	0	0	0	0	0	0	0
Innenzehner:	46								
weiteste:	306 (51), 284 (28), 275 (23)								
beste Teiler	21.9 (19.)	35.8 (11.)	50.5 (37.)						
Trefferlage	0.14 mm rechts, 0.30 mm hoch								
Streuwert	1.15, horizontal: 1.01, vertikal: 1.27								

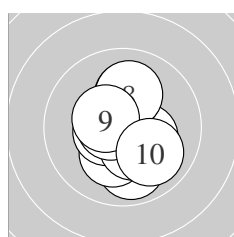
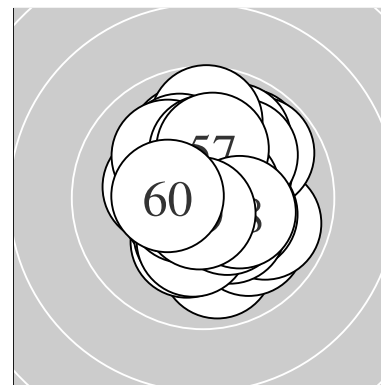

Serie 1:	10.3 *	9.9 ↓	10.2 *	10.5 *	10.4 *
	10.6 *	10.1 ↑	10.1 ↑	10.4 *	10.0 ↘
beste Teiler	79.1 (6.)	111.4 (4.)	126.5 (9.)		
Trefferlage	0.16 mm rechts, 0.33 mm tief				
Streuwert	1.35, horizontal: 1.04, vertikal: 1.60				

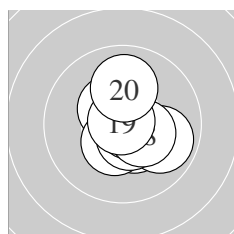

Serie 2:	10.8 *	10.4 *	10.4 *	9.9 ↘	10.4 *
	10.6 *	10.7 *	10.4 *	10.9 *	10.0 ↑
beste Teiler	21.9 (19.)	35.8 (11.)	54.5 (17.)		
Trefferlage	0.46 mm rechts, 0.10 mm tief				
Streuwert	1.03, horizontal: 0.93, vertikal: 1.12				

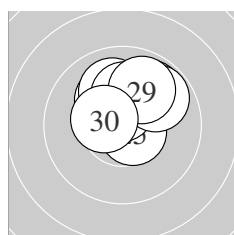

Serie 3:	10.2 *	10.6 *	9.9 ↗	10.0 ↑	10.6 *
	10.5 *	10.2 *	9.8 ↗	9.9 ↗	10.4 *
beste Teiler	80.9 (25.)	98.8 (22.)	114.4 (26.)		
Trefferlage	0.22 mm rechts, 1.36 mm hoch				
Streuwert	1.09, horizontal: 1.21, vertikal: 0.94				

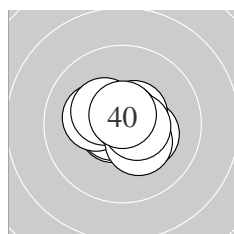

Serie 4:	10.7 *	10.3 *	10.7 *	10.6 *	10.2 *
	10.4 *	10.8 *	10.3 *	10.6 *	10.7 *
beste Teiler	50.5 (37.)	62.0 (40.)	67.1 (33.)		
Trefferlage	0.02 mm rechts, 0.05 mm hoch				
Streuwert	0.89, horizontal: 1.08, vertikal: 0.66				

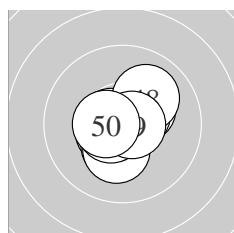

Serie 5:	10.3 *	10.5 *	10.3 *	10.6 *	10.3 *
	10.5 *	10.6 *	10.0 ↗	10.7 *	10.5 *
beste Teiler	62.2 (49.)	77.1 (44.)	85.4 (47.)		
Trefferlage	0.00 mm , 0.05 mm tief				
Streuwert	1.02, horizontal: 1.00, vertikal: 1.04				

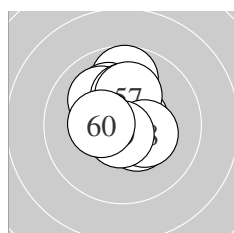

Serie 6:	9.7 ↑	10.1 ↖	10.1 ↖	10.4 *	10.6 *
	10.2 *	10.2 *	10.3 *	10.7 *	10.4 *
beste Teiler	62.8 (59.)	89.1 (55.)	127.6 (54.)		
Trefferlage	0.00 mm , 0.89 mm hoch				
Streuwert	1.19, horizontal: 0.99, vertikal: 1.36				

ISSF AR Women – Wertung – Frauen

StandNr: 118

Köck, Rebecca #44

StartNr: 20

21. Januar 2020 9:49

AUT

Unterschrift des Schützen

Meyton Elektronik

Ergebnis: **614.1** (586)
 Serien: 101.6 100.8 101.7 104.0 104.3 101.7
 Zähler: 46 14 0 0 0 0 0 0 0
 Innenzehner: 40
 weiteste: 447 (56), 435 (29), 386 (20)
 beste Teiler 46.3 (39.) 49.0 (41.) 53.3 (43.)
 Trefferlage 0.56 mm rechts, 0.10 mm hoch
 Streuwert 1.40, horizontal: 1.72, vertikal: 0.97

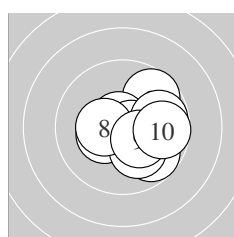
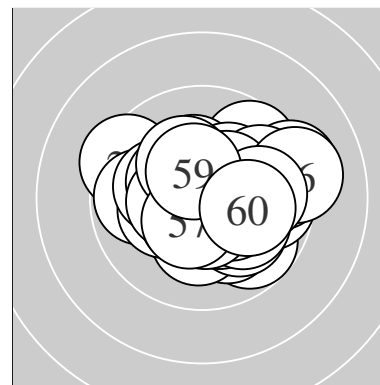

Serie 1:
 10.4 * 9.7 ↗ 10.7 * 9.8 ↘ 10.1 ↘
 10.7 * 9.8 → 10.4 * 10.3 * 9.7 →
 beste Teiler 60.5 (3.) 69.6 (6.) 142.0 (8.)
 Trefferlage 1.04 mm rechts, 0.21 mm tief
 Streuwert 1.45, horizontal: 1.64, vertikal: 1.24

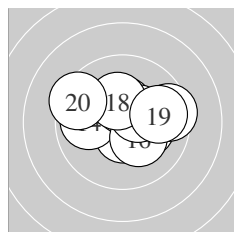

Serie 2:
 10.6 * 10.2 * 9.5 → 9.9 ← 10.4 *
 10.3 * 10.4 * 10.3 * 9.8 → 9.4 ↖
 beste Teiler 94.1 (11.) 128.6 (15.) 137.4 (17.)
 Trefferlage 0.42 mm rechts, 0.40 mm hoch
 Streuwert 1.73, horizontal: 2.22, vertikal: 1.02

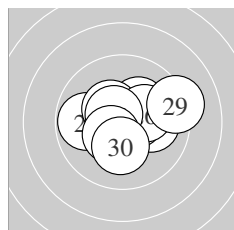

Serie 3:
 9.8 ← 10.2 * 10.1 → 10.4 * 10.6 *
 10.2 * 10.6 * 10.4 * 9.2 → 10.2 *
 beste Teiler 90.6 (27.) 100.2 (25.) 131.5 (28.)
 Trefferlage 0.47 mm rechts, 0.23 mm hoch
 Streuwert 1.57, horizontal: 1.98, vertikal: 1.02

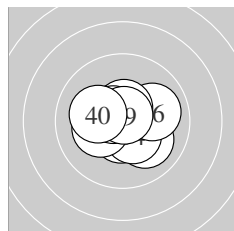

Serie 4:
 10.6 * 10.5 * 10.1 ↘ 10.4 * 10.2 *
 10.0 → 10.6 * 10.6 * 10.8 * 10.2 *
 beste Teiler 46.3 (39.) 81.3 (31.) 87.6 (38.)
 Trefferlage 0.01 mm rechts, 0.02 mm tief
 Streuwert 1.15, horizontal: 1.35, vertikal: 0.90

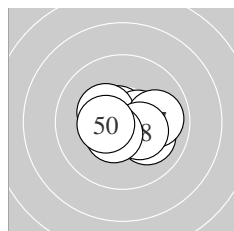

Serie 5:
 10.8 * 10.7 * 10.7 * 10.5 * 10.3 *
 10.1 ↘ 9.9 → 10.4 * 10.5 * 10.4 *
 beste Teiler 49.0 (41.) 53.3 (43.) 68.7 (42.)
 Trefferlage 0.27 mm rechts, 0.17 mm tief
 Streuwert 1.06, horizontal: 1.36, vertikal: 0.63

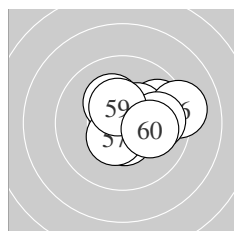

Serie 6:
 9.8 → 10.4 * 10.5 * 10.7 * 10.2 *
 9.2 → 10.5 * 9.9 → 10.4 * 10.1 →
 beste Teiler 55.4 (54.) 109.0 (53.) 121.3 (57.)
 Trefferlage 1.12 mm rechts, 0.40 mm hoch
 Streuwert 1.42, horizontal: 1.76, vertikal: 0.97

Meyton Elektronik

ISSF AR Women – Wertung – Frauen

StandNr: 119

Hofstetter, Vanessa #467

StartNr: 21

21. Januar 2020 9:39

SUI

Unterschrift des Schützen

Meyton Elektronik

Ergebnis:	617.2	(593)							
Serien:	101.7	102.3	105.8	101.3	101.8	104.3			
Zähler:	53	7	0	0	0	0	0	0	0
Innenzehner:	43								
weiteste:	491	(40),	473	(38),	442	(12)			
beste Teiler	7.8	(16.)	31.3	(44.)	34.9	(33.)			
Trefferlage	0.02 mm links, 0.04 mm tief								
Streuwert	1.40, horizontal: 1.47, vertikal: 1.33								

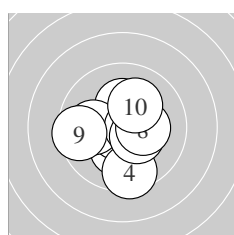
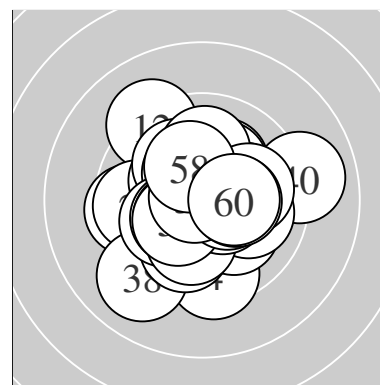

Serie 1:					
	10.2 *	10.7 *	10.3 *	9.5 ↓	10.0 ←
	10.7 *	10.4 *	10.3 *	9.5 ←	10.1 ↗
beste Teiler	61.5 (2.) 75.0 (6.) 138.4 (7.)				
Trefferlage	0.16 mm links, 0.35 mm tief				
Streuwert	1.61, horizontal: 1.65, vertikal: 1.57				

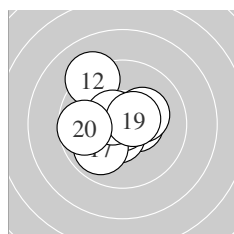

Serie 2:					
	10.2 *	9.2 ↘	10.5 *	10.5 *	10.2 *
	10.9 *	9.9 ↙	10.6 *	10.6 *	9.7 ←
beste Teiler	7.8 (16.) 96.6 (19.) 98.1 (18.)				
Trefferlage	0.68 mm links, 0.27 mm hoch				
Streuwert	1.52, horizontal: 1.60, vertikal: 1.44				

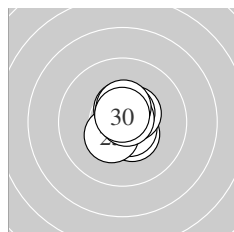

Serie 3:					
	10.5 *	10.6 *	10.4 *	10.5 *	10.6 *
	10.5 *	10.7 *	10.8 *	10.5 *	10.7 *
beste Teiler	42.6 (28.) 60.1 (30.) 74.0 (27.)				
Trefferlage	0.20 mm rechts, 0.27 mm hoch				
Streuwert	0.70, horizontal: 0.52, vertikal: 0.84				

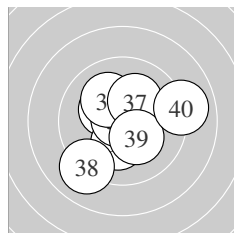

Serie 4:					
	10.3 *	10.5 *	10.8 *	10.2 *	10.8 *
	10.1 ↘	10.2 *	9.1 ↙	10.3 *	9.0 →
beste Teiler	34.9 (33.) 37.3 (35.) 112.3 (32.)				
Trefferlage	0.00 mm, 0.00 mm				
Streuwert	1.91, horizontal: 2.05, vertikal: 1.75				

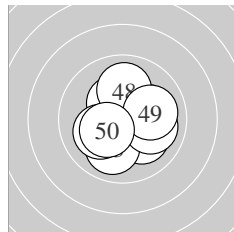

Serie 5:					
	10.1 ↘	10.1 →	10.0 ↓	10.8 *	10.4 *
	10.0 →	10.1 ←	10.0 ↑	10.0 →	10.3 *
beste Teiler	31.3 (44.) 148.1 (45.) 156.7 (50.)				
Trefferlage	0.34 mm rechts, 0.11 mm tief				
Streuwert	1.47, horizontal: 1.55, vertikal: 1.39				

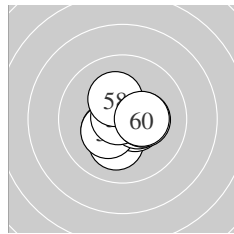

Serie 6:					
	10.7 *	10.2 *	10.5 *	10.4 *	10.3 *
	10.5 *	10.8 *	10.3 *	10.3 *	10.3 *
beste Teiler	39.5 (57.) 70.7 (51.) 110.3 (53.)				
Trefferlage	0.15 mm rechts, 0.34 mm tief				
Streuwert	1.02, horizontal: 1.11, vertikal: 0.93				

Meyton Elektronik

ISSF AR Women – Wertung – Frauen

StandNr: 120

Oseguera, Andrea #473

StartNr: 22

21. Januar 2020 9:35

ITA – SV Eppan

Unterschrift des Schützen

Meyton Elektronik

Ergebnis: **625.0** (598)
 Serien: 105.3 104.5 103.3 104.4 103.6 103.9
 Zähler: 58 2 0 0 0 0 0 0 0
 Innenzehner: 51
 weiteste: 266 (27), 254 (46), 245 (48)
 beste Teiler 6.4 (5.) 44.1 (39.) 55.0 (32.)
 Trefferlage 0.01 mm links, 0.17 mm hoch
 Streuwert 1.04, horizontal: 1.25, vertikal: 0.77

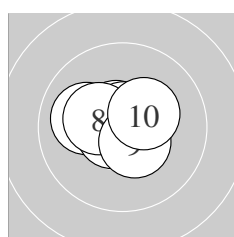
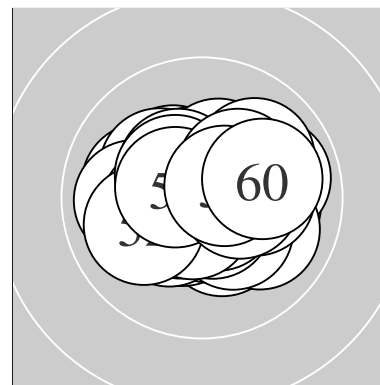

Serie 1:
 10.6 * 10.7 * 10.0 ← 10.6 * 10.9 *
 10.7 * 10.7 * 10.3 * 10.5 * 10.3 *
 beste Teiler 6.4 (5.) 57.8 (2.) 58.6 (6.)
 Trefferlage 0.40 mm links, 0.24 mm hoch
 Streuwert 0.82, horizontal: 1.03, vertikal: 0.53

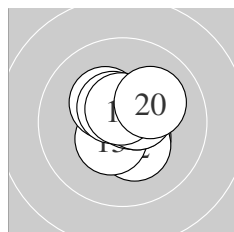

Serie 2:
 10.5 * 10.3 * 10.4 * 10.6 * 10.7 *
 10.3 * 10.5 * 10.5 * 10.6 * 10.1 →
 beste Teiler 72.2 (15.) 82.6 (19.) 100.4 (14.)
 Trefferlage 0.29 mm rechts, 0.23 mm hoch
 Streuwert 0.94, horizontal: 0.88, vertikal: 0.99

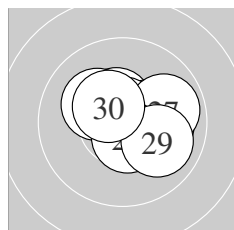

Serie 3:
 10.1 → 10.6 * 10.5 * 10.3 * 10.2 *
 10.7 * 9.9 → 10.6 * 10.0 → 10.4 *
 beste Teiler 57.1 (26.) 90.7 (22.) 97.0 (28.)
 Trefferlage 0.52 mm rechts, 0.32 mm hoch
 Streuwert 1.19, horizontal: 1.46, vertikal: 0.83

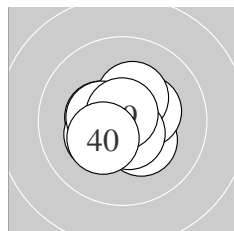

Serie 4:
 10.3 * 10.7 * 10.3 * 10.4 * 10.3 *
 10.3 * 10.6 * 10.4 * 10.8 * 10.3 *
 beste Teiler 44.1 (39.) 55.0 (32.) 86.7 (37.)
 Trefferlage 0.17 mm links, 0.13 mm tief
 Streuwert 0.98, horizontal: 1.08, vertikal: 0.86

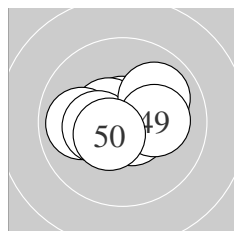

Serie 5:
 10.7 * 10.3 * 10.7 * 10.4 * 10.6 *
 9.9 ← 10.3 * 10.0 ↗ 10.2 * 10.5 *
 beste Teiler 60.1 (41.) 73.8 (43.) 100.3 (45.)
 Trefferlage 0.43 mm links, 0.06 mm hoch
 Streuwert 1.17, horizontal: 1.53, vertikal: 0.65

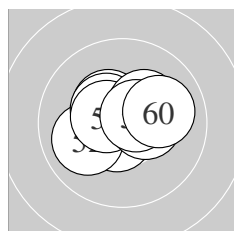

Serie 6:
 10.6 * 10.0 ← 10.7 * 10.4 * 10.4 *
 10.5 * 10.4 * 10.3 * 10.6 * 10.0 →
 beste Teiler 70.5 (53.) 86.4 (51.) 95.2 (59.)
 Trefferlage 0.06 mm rechts, 0.34 mm hoch
 Streuwert 1.11, horizontal: 1.38, vertikal: 0.73

Meyton Elektronik

ISSF AR Women – Wertung – Frauen

StandNr: 121

Ser, Xiang Wei Jasmine #464

StartNr: 23

21. Januar 2020 9:47

SGP

Unterschrift des Schützen

Meyton Elektronik

Ergebnis:	622.9	(592)						
Serien:	104.5	101.9	104.1	105.4	103.0	104.0		
Zähler:	52	8	0	0	0	0	0	0
Innenzehner:	47							
weiteste:	305 (17), 305 (19), 299 (32)							
beste Teiler	30.3 (10.) 32.2 (41.) 42.1 (40.)							
Trefferlage	0.21 mm links, 0.22 mm hoch							
Streuwert	1.12, horizontal: 1.18, vertikal: 1.04							

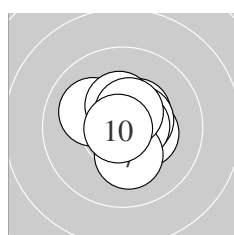
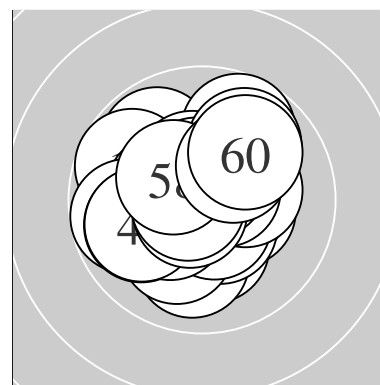

Serie 1:					
	10.4 *	10.4 *	10.1 ↖	10.5 *	10.6 *
	10.6 *	10.2 *	10.4 *	10.5 *	10.8 *
beste Teiler	30.3 (10.) 84.3 (5.) 94.5 (6.)				
Trefferlage	0.29 mm rechts, 0.34 mm hoch				
Streuwert	0.95, horizontal: 0.96, vertikal: 0.95				

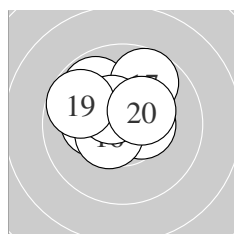

Serie 2:					
	10.1 ↖	10.6 *	9.8 ↖	10.5 *	10.2 *
	10.5 *	9.7 ↗	10.5 *	9.7 ↖	10.3 *
beste Teiler	94.2 (12.) 110.6 (16.) 118.0 (18.)				
Trefferlage	0.62 mm links, 0.95 mm hoch				
Streuwert	1.28, horizontal: 1.50, vertikal: 1.01				

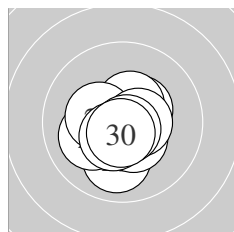

Serie 3:					
	10.4 *	10.5 *	10.0 ↓	10.4 *	10.1 ↙
	10.3 *	10.5 *	10.5 *	10.7 *	10.7 *
beste Teiler	52.8 (29.) 72.0 (30.) 102.0 (27.)				
Trefferlage	0.10 mm links, 0.42 mm tief				
Streuwert	1.03, horizontal: 1.03, vertikal: 1.02				

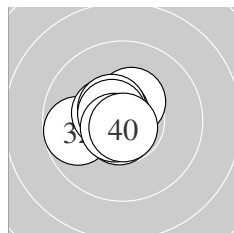

Serie 4:					
	10.7 *	9.8 ←	10.5 *	10.4 *	10.7 *
	10.7 *	10.5 *	10.6 *	10.7 *	10.8 *
beste Teiler	42.1 (40.) 66.1 (36.) 67.4 (39.)				
Trefferlage	0.66 mm links, 0.10 mm hoch				
Streuwert	0.81, horizontal: 0.92, vertikal: 0.69				

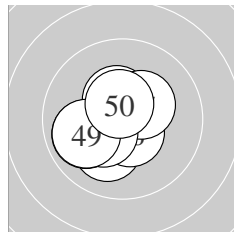

Serie 5:					
	10.8 *	10.2 *	10.1 ↙	9.9 ←	10.4 *
	10.6 *	10.3 *	10.3 *	9.9 ←	10.5 *
beste Teiler	32.2 (41.) 100.7 (46.) 101.2 (50.)				
Trefferlage	0.68 mm links, 0.39 mm tief				
Streuwert	1.15, horizontal: 1.19, vertikal: 1.10				

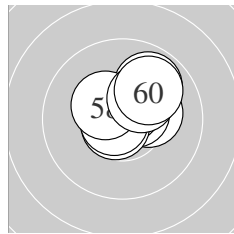

Serie 6:					
	10.3 *	10.7 *	10.6 *	10.6 *	10.7 *
	10.7 *	9.9 ↗	10.4 *	10.2 *	9.9 ↗
beste Teiler	56.7 (56.) 63.0 (55.) 66.8 (52.)				
Trefferlage	0.47 mm rechts, 0.75 mm hoch				
Streuwert	0.97, horizontal: 1.09, vertikal: 0.83				

Meyton Elektronik

ISSF AR Women – Wertung – Frauen

StandNr: 122

Tashtchiev, Olga #342

StartNr: 24

21. Januar 2020 9:48

ISR

Unterschrift des Schützen

Meyton Elektronik

Ergebnis:	618.1	(589)						
Serien:	101.7	103.1	105.0	103.2	102.4	102.7		
Zähler:	49	11	0	0	0	0	0	0
Innenzehner:	42							
weiteste:	462 (4), 387 (40), 382 (36)							
beste Teiler	18.4 (39.)	25.4 (13.)	32.7 (34.)					
Trefferlage	0.75 mm links, 0.04 mm hoch							
Streuwert	1.24, horizontal: 1.40, vertikal: 1.06							

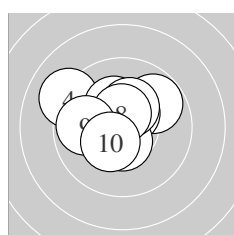
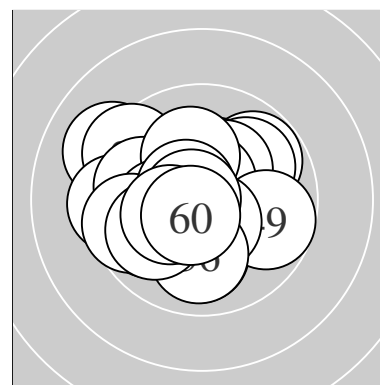

Serie 1:

10.5 *	9.8 ↗	10.5 *	9.1 ↘	10.5 *
10.3 *	10.3 *	10.5 *	9.8 ←	10.4 *

beste Teiler 103.3 (8.) 106.0 (5.) 110.4 (1.)
 Trefferlage 0.60 mm links, 0.77 mm hoch
 Streuwert 1.50, horizontal: 1.79, vertikal: 1.14

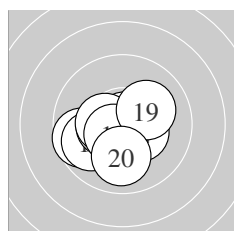

Serie 2:

9.7 ←	10.7 *	10.9 *	10.4 *	9.9 ↙
10.4 *	10.4 *	10.6 *	10.1 ↗	10.0 ↓

beste Teiler 25.4 (13.) 72.9 (12.) 100.4 (18.)
 Trefferlage 0.53 mm links, 0.55 mm tief
 Streuwert 1.27, horizontal: 1.53, vertikal: 0.94

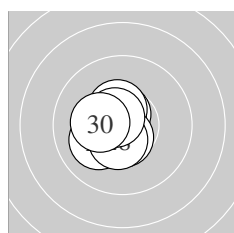

Serie 3:

10.6 *	10.5 *	10.1 ↙	10.6 *	10.7 *
10.5 *	10.6 *	10.5 *	10.6 *	10.3 *

beste Teiler 62.9 (25.) 81.3 (29.) 82.7 (24.)
 Trefferlage 0.69 mm links, 0.04 mm tief
 Streuwert 0.77, horizontal: 0.65, vertikal: 0.87

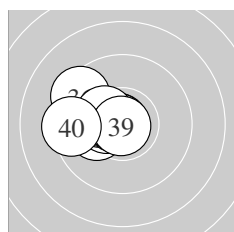

Serie 4:

10.1 ←	10.5 *	10.2 *	10.8 *	10.7 *
9.4 ↘	10.8 *	10.4 *	10.9 *	9.4 ←

beste Teiler 18.4 (39.) 32.7 (34.) 45.1 (37.)
 Trefferlage 1.47 mm links, 0.27 mm hoch
 Streuwert 1.02, horizontal: 1.25, vertikal: 0.72

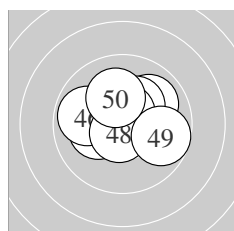

Serie 5:

10.0 ↗	10.2 *	10.3 *	10.3 *	10.6 *
9.9 ←	10.6 *	10.7 *	9.7 →	10.1 ↑

beste Teiler 70.9 (48.) 83.6 (47.) 91.7 (45.)
 Trefferlage 0.05 mm links, 0.64 mm hoch
 Streuwert 1.37, horizontal: 1.67, vertikal: 0.99

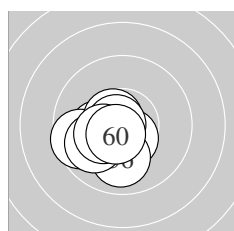

Serie 6:

10.2 *	10.2 *	10.5 *	9.6 ←	10.6 *
10.0 ↓	9.9 ↙	10.8 *	10.3 *	10.6 *

beste Teiler 49.1 (58.) 87.2 (60.) 87.3 (55.)
 Trefferlage 1.14 mm links, 0.82 mm tief
 Streuwert 0.95, horizontal: 1.07, vertikal: 0.80

ISSF AR Women – Wertung – Frauen

StandNr: 123

Lott, Amy #422

StartNr: 25

21. Januar 2020 9:43

GBR

Unterschrift des Schützen

Meyton Elektronik

Ergebnis: **624.1** (594)
 Serien: 102.5 104.3 105.5 102.8 103.5 105.5
 Zähler: 54 6 0 0 0 0 0 0 0 0
 Innenzehner: 50
 weiteste: 424 (10), 379 (39), 291 (12)
 beste Teiler 24.8 (25.) 41.2 (55.) 43.0 (4.)
 Trefferlage 0.03 mm links, 0.32 mm tief
 Streuwert 1.13, horizontal: 1.19, vertikal: 1.06

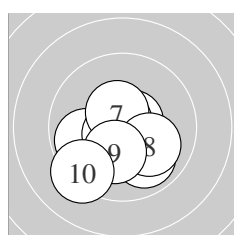
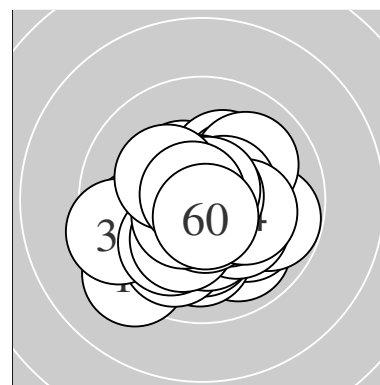

Serie 1:
 9.9 ← 10.6 * 10.7 * 10.8 * 9.9 ↘
 10.6 * 10.5 * 10.0 ↘ 10.2 * 9.3 ↙
 beste Teiler 43.0 (4.) 75.8 (3.) 80.6 (6.)
 Trefferlage 0.24 mm links, 0.82 mm tief
 Streuwert 1.43, horizontal: 1.57, vertikal: 1.28

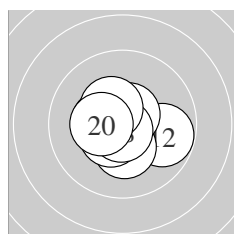

Serie 2:
 10.6 * 9.8 → 10.5 * 10.3 * 10.5 *
 10.4 * 10.6 * 10.8 * 10.4 * 10.4 *
 beste Teiler 46.0 (18.) 80.2 (17.) 100.1 (11.)
 Trefferlage 0.14 mm links, 0.36 mm tief
 Streuwert 1.05, horizontal: 1.22, vertikal: 0.85

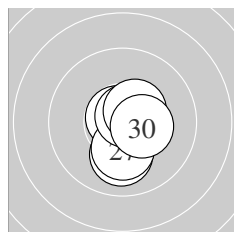

Serie 3:
 10.7 * 10.8 * 10.6 * 10.0 ↓ 10.9 *
 10.7 * 10.2 * 10.7 * 10.5 * 10.4 *
 beste Teiler 24.8 (25.) 48.8 (22.) 51.0 (26.)
 Trefferlage 0.31 mm rechts, 0.32 mm tief
 Streuwert 0.81, horizontal: 0.53, vertikal: 1.02

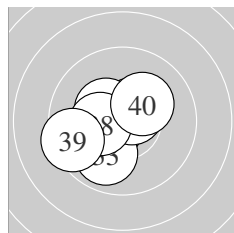

Serie 4:
 10.6 * 10.2 * 9.9 ↙ 10.6 * 10.6 *
 10.6 * 10.4 * 10.3 * 9.4 ← 10.2 *
 beste Teiler 82.2 (31.) 85.7 (36.) 98.2 (34.)
 Trefferlage 0.66 mm links, 0.10 mm tief
 Streuwert 1.32, horizontal: 1.48, vertikal: 1.14

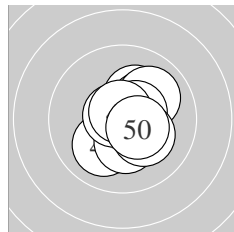

Serie 5:
 10.2 * 10.1 ↙ 10.3 * 10.0 ↗ 10.3 *
 10.5 * 10.2 * 10.7 * 10.7 * 10.5 *
 beste Teiler 53.4 (49.) 64.0 (48.) 103.7 (46.)
 Trefferlage 0.56 mm rechts, 0.02 mm hoch
 Streuwert 1.14, horizontal: 1.01, vertikal: 1.25

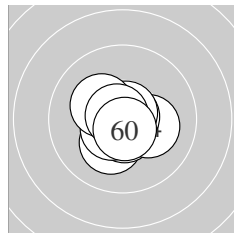

Serie 6:
 10.7 * 10.2 * 10.6 * 10.2 * 10.8 *
 10.5 * 10.8 * 10.2 * 10.8 * 10.7 *
 beste Teiler 41.2 (55.) 47.5 (59.) 49.6 (57.)
 Trefferlage 0.04 mm links, 0.32 mm tief
 Streuwert 0.83, horizontal: 0.89, vertikal: 0.77

Meyton Elektronik

ISSF AR Women – Wertung – Frauen

StandNr: 124

Pribitzer, Marlene #38

StartNr: 26

21. Januar 2020 9:55

AUT

Unterschrift des Schützen

Meyton Elektronik

Ergebnis: **628.5** (596)^{QF}
 Serien: 104.1 104.5 104.5 105.6 105.0 104.8
 Zähler: 56 4 0 0 0 0 0 0 0
 Innenzehner: 53
 weiteste: 289 (44), 282 (10), 260 (12)
 beste Teiler 7.2 (38.) 16.2 (32.) 25.0 (48.)
 Trefferlage 0.00 mm , 0.15 mm hoch
 Streuwert 0.97, horizontal: 1.04, vertikal: 0.90

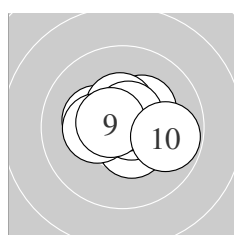
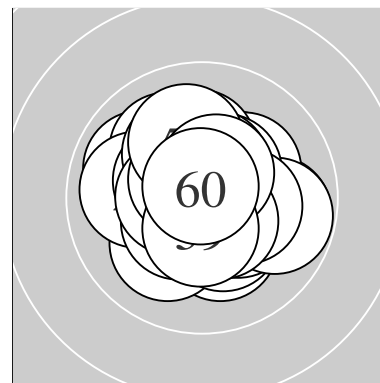

Serie 1:
 10.5 * 10.6 * 10.7 * 10.3 * 10.3 *
 10.4 * 10.3 * 10.6 * 10.6 * 9.8 →
 beste Teiler 59.4 (3.) 80.9 (8.) 82.6 (9.)
 Trefferlage 0.16 mm rechts, 0.30 mm hoch
 Streuwert 1.07, horizontal: 1.33, vertikal: 0.73

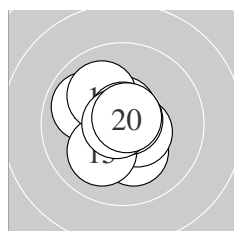

Serie 2:
 10.2 * 9.9 ↖ 10.6 * 10.5 * 10.1 ↙
 10.0 ↘ 10.8 * 10.8 * 10.8 * 10.8 *
 beste Teiler 38.1 (19.) 43.4 (18.) 46.0 (17.)
 Trefferlage 0.31 mm links, 0.09 mm hoch
 Streuwert 1.10, horizontal: 1.05, vertikal: 1.15

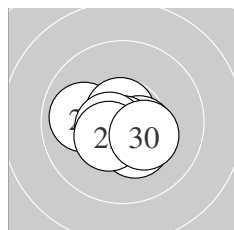

Serie 3:
 10.7 * 9.9 ← 10.4 * 10.7 * 10.5 *
 10.3 * 10.7 * 10.6 * 10.4 * 10.3 *
 beste Teiler 54.1 (27.) 63.7 (24.) 64.2 (21.)
 Trefferlage 0.06 mm links, 0.52 mm tief
 Streuwert 0.93, horizontal: 1.17, vertikal: 0.61

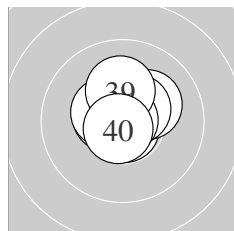

Serie 4:
 10.8 * 10.9 * 10.3 * 10.6 * 10.2 *
 10.5 * 10.5 * 10.9 * 10.2 * 10.7 *
 beste Teiler 7.2 (38.) 16.2 (32.) 43.9 (31.)
 Trefferlage 0.00 mm , 0.54 mm hoch
 Streuwert 0.80, horizontal: 0.79, vertikal: 0.81

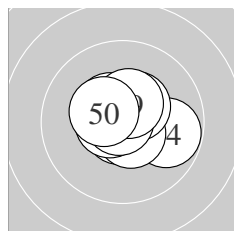

Serie 5:
 10.6 * 10.7 * 10.5 * 9.8 → 10.6 *
 10.6 * 10.4 * 10.9 * 10.5 * 10.4 *
 beste Teiler 25.0 (48.) 52.9 (42.) 82.2 (46.)
 Trefferlage 0.21 mm rechts, 0.17 mm hoch
 Streuwert 0.97, horizontal: 1.16, vertikal: 0.73

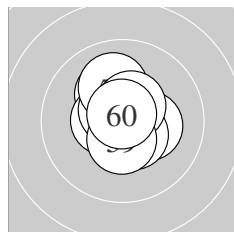

Serie 6:
 10.3 * 10.2 * 10.8 * 10.5 * 10.6 *
 10.1 ↑ 10.5 * 10.5 * 10.5 * 10.8 *
 beste Teiler 42.2 (53.) 45.3 (60.) 94.3 (55.)
 Trefferlage 0.05 mm links, 0.32 mm hoch
 Streuwert 0.96, horizontal: 0.83, vertikal: 1.08

Meyton Elektronik

ISSF AR Women – Wertung – Frauen

StandNr: 125

Mazurova, Nikola #415

StartNr: 27

21. Januar 2020 9:54

CZE

QF – Schütze hat sich fürs Finale qualifiziert

Unterschrift des Schützen

Meyton Elektronik

Ergebnis:	624.4	(595)					
Serien:	103.0	104.8	104.0	104.1	104.2	104.3	
Zähler:	55	5	0	0	0	0	0
Innenzehner:	49						
weiteste:	378 (19), 325 (3), 309 (8)						
beste Teiler	7.8 (12.) 16.5 (16.) 17.0 (27.)						
Trefferlage	0.08 mm rechts, 0.12 mm hoch						
Streuwert	1.12, horizontal: 1.17, vertikal: 1.06						

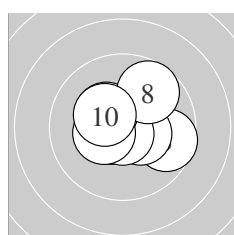
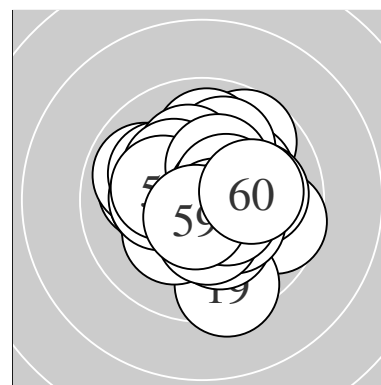

Serie 1:	10.5 *	10.3 *	9.7 →	10.4 *	10.6 *
	10.8 *	10.3 *	9.7 ↗	10.4 *	10.3 *
beste Teiler	48.0 (6.) 87.2 (5.) 116.1 (1.)				
Trefferlage	0.38 mm rechts, 0.32 mm hoch				
Streuwert	1.31, horizontal: 1.53, vertikal: 1.05				

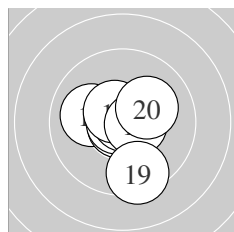

Serie 2:	10.0 ←	10.9 *	10.7 *	10.8 *	10.8 *
	10.9 *	10.6 *	10.6 *	9.4 ↓	10.1 ↘
beste Teiler	7.8 (12.) 16.5 (16.) 36.3 (15.)				
Trefferlage	0.08 mm rechts, 0.19 mm tief				
Streuwert	1.19, horizontal: 1.09, vertikal: 1.29				

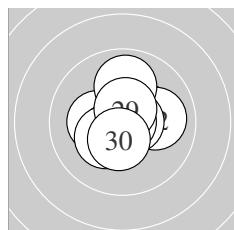

Serie 3:	10.3 *	10.0 →	10.7 *	10.3 *	9.9 ↑
	10.5 *	10.9 *	10.3 *	10.6 *	10.5 *
beste Teiler	17.0 (27.) 72.0 (23.) 96.1 (29.)				
Trefferlage	0.10 mm rechts, 0.11 mm hoch				
Streuwert	1.17, horizontal: 1.23, vertikal: 1.11				

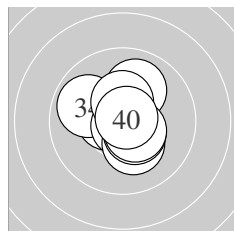

Serie 4:	10.5 *	10.0 ↗	10.5 *	9.9 ←	10.8 *
	10.4 *	10.2 *	10.5 *	10.5 *	10.8 *
beste Teiler	34.1 (35.) 36.8 (40.) 106.0 (33.)				
Trefferlage	0.01 mm rechts, 0.26 mm hoch				
Streuwert	1.12, horizontal: 1.07, vertikal: 1.17				

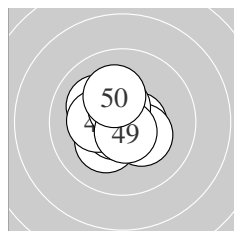

Serie 5:	10.6 *	10.3 *	10.2 *	10.1 ←	10.7 *
	10.7 *	10.2 *	10.5 *	10.7 *	10.2 *
beste Teiler	65.0 (46.) 69.4 (45.) 73.3 (49.)				
Trefferlage	0.41 mm links, 0.09 mm hoch				
Streuwert	1.03, horizontal: 1.04, vertikal: 1.02				

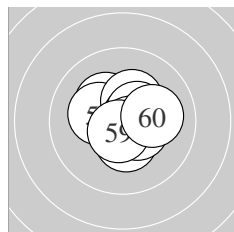

Serie 6:	10.3 *	10.3 *	10.3 *	10.6 *	10.5 *
	10.4 *	10.7 *	10.5 *	10.6 *	10.1 →
beste Teiler	75.6 (57.) 79.1 (59.) 82.5 (54.)				
Trefferlage	0.33 mm rechts, 0.12 mm hoch				
Streuwert	1.02, horizontal: 1.13, vertikal: 0.90				

ISSF AR Women – Wertung – Frauen

StandNr: 126

Guignard, Silvia #476

StartNr: 28

21. Januar 2020 9:43

SUI

Unterschrift des Schützen

Meyton Elektronik

Ergebnis:	627.8	(596)							
Serien:	104.1	105.0	105.1	105.1	105.5	103.0			
Zähler:	56	4	0	0	0	0	0	0	0
Innenzehner:	54								
weiteste:	361	(60),	359	(6),	305	(53)			
beste Teiler	5.0	(51.)	24.1	(25.)	31.1	(8.)			
Trefferlage	0.04 mm links, 0.21 mm hoch								
Streuwert	1.00, horizontal: 1.05, vertikal: 0.95								

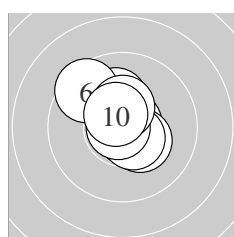
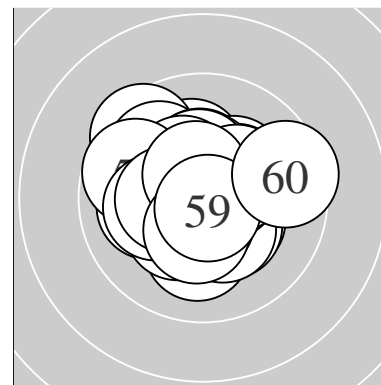

Serie 1:					
	10.7 *	10.2 *	10.5 *	10.7 *	10.3 *
	9.5 ↖	10.5 *	10.8 *	10.4 *	10.5 *
beste Teiler	31.1 (8.) 58.1 (4.) 65.8 (1.)				
Trefferlage	0.13 mm links, 0.59 mm hoch				
Streuwert	1.10, horizontal: 1.03, vertikal: 1.18				

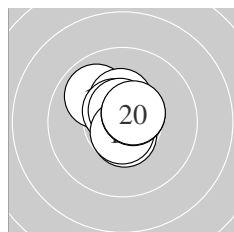

Serie 2:					
	10.4 *	9.9 ↖	10.7 *	10.3 *	10.6 *
	10.6 *	10.6 *	10.7 *	10.6 *	10.6 *
beste Teiler	65.7 (13.) 69.0 (18.) 84.7 (17.)				
Trefferlage	0.13 mm links, 0.60 mm hoch				
Streuwert	0.83, horizontal: 0.79, vertikal: 0.86				

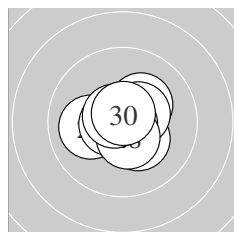

Serie 3:					
	10.7 *	10.3 *	10.2 *	10.5 *	10.9 *
	10.0 ←	10.6 *	10.5 *	10.7 *	10.7 *
beste Teiler	24.1 (25.) 61.2 (30.) 62.0 (21.)				
Trefferlage	0.09 mm rechts, 0.03 mm tief				
Streuwert	0.93, horizontal: 1.08, vertikal: 0.75				

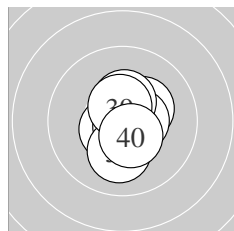

Serie 4:					
	10.6 *	10.8 *	10.6 *	10.3 *	10.5 *
	10.8 *	10.4 *	10.1 ↓	10.5 *	10.5 *
beste Teiler	33.5 (32.) 39.9 (36.) 84.8 (31.)				
Trefferlage	0.29 mm rechts, 0.05 mm tief				
Streuwert	0.87, horizontal: 0.66, vertikal: 1.04				

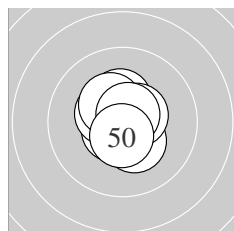

Serie 5:					
	10.3 *	10.4 *	10.8 *	10.6 *	10.8 *
	10.4 *	10.5 *	10.4 *	10.7 *	10.6 *
beste Teiler	42.7 (45.) 49.2 (43.) 64.6 (49.)				
Trefferlage	0.11 mm links, 0.15 mm hoch				
Streuwert	0.81, horizontal: 0.68, vertikal: 0.92				

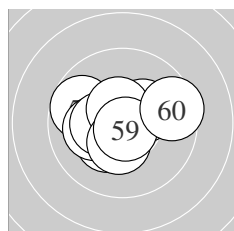

Serie 6:					
	10.9 *	10.3 *	9.7 ↖	10.2 *	10.4 *
	10.3 *	10.5 *	10.4 *	10.8 *	9.5 →
beste Teiler	5.0 (51.) 47.4 (59.) 103.7 (57.)				
Trefferlage	0.29 mm links, 0.04 mm hoch				
Streuwert	1.42, horizontal: 1.79, vertikal: 0.91				

Meyton Elektronik

ISSF AR Women – Wertung – Frauen

StandNr: 128

Peer, Franziska #115

StartNr: 30

21. Januar 2020 9:39

AUT

Unterschrift des Schützen

Meyton Elektronik

Ergebnis: **612.3** (584)

Serien: 90.7 103.1 104.7 104.9 104.8 104.1

Zähler: 53 6 0 0 0 0 0 0 0 0

Innenzehner: 48

weiteste: 380 (6), 327 (2), 296 (23)

beste Teiler 20.6 (33.) 30.1 (29.) 34.8 (26.)

Trefferlage 0.14 mm links, 0.28 mm hoch

Streuwert 1.14, horizontal: 1.31, vertikal: 0.93

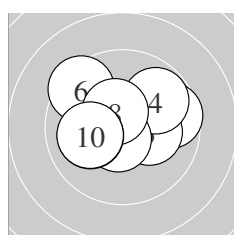
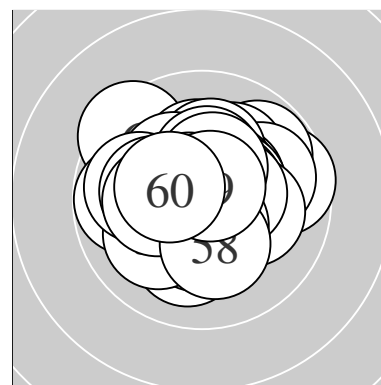

Serie 1:

10.5 *	9.6 →	10.2 *	9.8 ↗	0.0F
9.4 ↘	10.6 *	10.5 *	10.1 ←	10.0 ← ^{MIS}

beste Teiler 83.5 (7.) 108.6 (1.) 115.8 (8.)

Trefferlage 0.02 mm rechts, 0.49 mm hoch

Streuwert 1.73, horizontal: 2.15, vertikal: 1.17

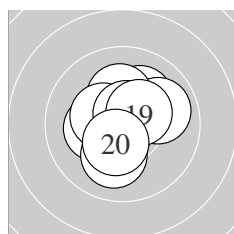

Serie 2:

10.1 ↗	9.9 →	10.2 *	10.7 *	10.2 *
10.4 *	10.1 ↓	10.7 *	10.4 *	10.4 *

beste Teiler 71.5 (14.) 74.0 (18.) 132.6 (20.)

Trefferlage 0.02 mm rechts, 0.22 mm hoch

Streuwert 1.25, horizontal: 1.24, vertikal: 1.26

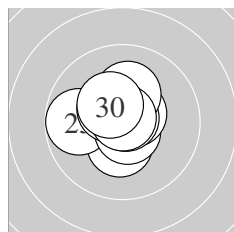

Serie 3:

10.5 *	10.4 *	9.8 ←	10.7 *	10.6 *
10.8 *	10.5 *	10.2 *	10.8 *	10.4 *

beste Teiler 30.1 (29.) 34.8 (26.) 69.8 (24.)

Trefferlage 0.40 mm links, 0.38 mm hoch

Streuwert 1.00, horizontal: 1.06, vertikal: 0.94

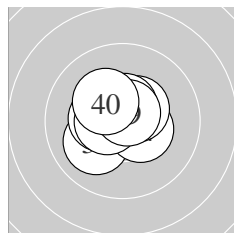

Serie 4:

10.1 ↙	10.5 *	10.9 *	10.4 *	10.5 *
10.6 *	10.4 *	10.5 *	10.7 *	10.3 *

beste Teiler 20.6 (33.) 64.4 (39.) 98.7 (36.)

Trefferlage 0.35 mm links, 0.27 mm hoch

Streuwert 0.91, horizontal: 1.02, vertikal: 0.79

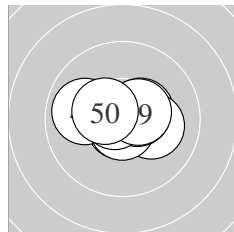

Serie 5:

10.8 *	10.4 *	10.7 *	10.2 *	9.9 ←
10.7 *	10.5 *	10.7 *	10.5 *	10.4 *

beste Teiler 50.5 (41.) 54.0 (46.) 56.9 (48.)

Trefferlage 0.12 mm rechts, 0.11 mm hoch

Streuwert 0.99, horizontal: 1.32, vertikal: 0.45

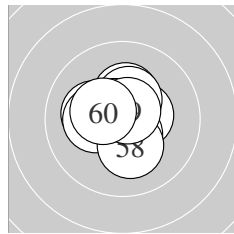

Serie 6:

10.5 *	10.2 *	10.5 *	10.3 *	10.4 *
10.2 *	10.7 *	10.2 *	10.7 *	10.4 *

beste Teiler 65.0 (59.) 72.1 (57.) 113.7 (53.)

Trefferlage 0.24 mm links, 0.21 mm hoch

Streuwert 1.04, horizontal: 1.09, vertikal: 1.00

Meyton Elektronik

ISSF AR Women – Wertung – Frauen

StandNr: 129

Kitzbichler, Jasmin #82

StartNr: 31

21. Januar 2020 9:42

T – SG Thierberg

MIS – Treffer wurde manuell eingefügt, da der Schütze die Scheibe verfehlt hat

Unterschrift des Schützen

Meyton Elektronik

Ergebnis:	631.4	(599) ^{QF}					
Serien:	105.0	105.3	104.9	106.4	104.4	105.4	
Zähler:	59	1	0	0	0	0	0
Innenzehner:	55						
weiteste:	261 (21), 244 (30), 232 (2)						
beste Teiler	7.0 (32.) 12.0 (8.) 13.6 (37.)						
Trefferlage	0.01 mm rechts, 0.08 mm hoch						
Streuwert	0.88, horizontal: 0.99, vertikal: 0.76						

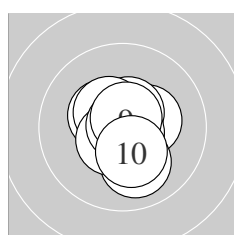
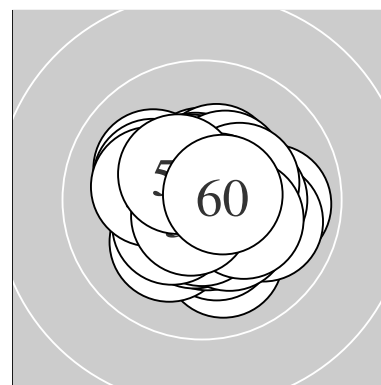

Serie 1:	10.3 *	10.0 ↘	10.6 *	10.4 *	10.5 *
	10.5 *	10.8 *	10.9 *	10.7 *	10.3 *
beste Teiler	12.0 (8.) 50.9 (7.) 62.0 (9.)				
Trefferlage	0.09 mm rechts, 0.11 mm tief				
Streuwert	0.96, horizontal: 0.81, vertikal: 1.08				

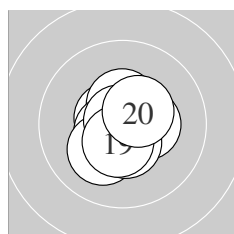

Serie 2:	10.7 *	10.6 *	10.5 *	10.6 *	10.4 *
	10.2 *	10.8 *	10.5 *	10.5 *	10.5 *
beste Teiler	29.0 (17.) 59.0 (11.) 88.5 (12.)				
Trefferlage	0.13 mm links, 0.14 mm tief				
Streuwert	0.86, horizontal: 0.82, vertikal: 0.90				

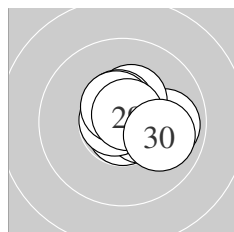

Serie 3:	9.9 →	10.8 *	10.5 *	10.8 *	10.4 *
	10.8 *	10.5 *	10.5 *	10.7 *	10.0 ↘
beste Teiler	29.6 (24.) 47.0 (22.) 50.4 (26.)				
Trefferlage	0.56 mm rechts, 0.23 mm hoch				
Streuwert	0.94, horizontal: 1.12, vertikal: 0.71				

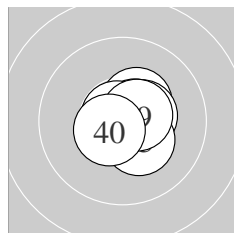

Serie 4:	10.4 *	10.9 *	10.5 *	10.8 *	10.3 *
	10.6 *	10.9 *	10.8 *	10.6 *	10.6 *
beste Teiler	7.0 (32.) 13.6 (37.) 27.0 (34.)				
Trefferlage	0.32 mm rechts, 0.09 mm hoch				
Streuwert	0.66, horizontal: 0.70, vertikal: 0.61				

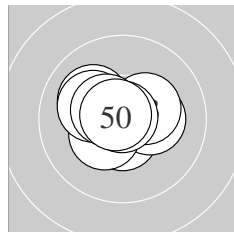

Serie 5:	10.6 *	10.3 *	10.3 *	10.5 *	10.4 *
	10.1 ↖	10.1 ↖	10.9 *	10.5 *	10.7 *
beste Teiler	14.5 (48.) 51.1 (50.) 99.0 (41.)				
Trefferlage	0.43 mm links, 0.18 mm hoch				
Streuwert	1.00, horizontal: 1.23, vertikal: 0.70				

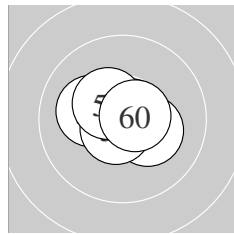

Serie 6:	10.6 *	10.7 *	10.7 *	10.5 *	10.3 *
	10.2 *	10.7 *	10.7 *	10.4 *	10.6 *
beste Teiler	57.2 (57.) 59.9 (52.) 67.2 (53.)				
Trefferlage	0.32 mm links, 0.23 mm hoch				
Streuwert	0.81, horizontal: 1.02, vertikal: 0.52				

Meyton Elektronik

ISSF AR Women – Wertung – Frauen

StartNr: 32

StandNr: 130

21. Januar 2020 9:49

Chandela, Apurvi #468

IND

QF – Schütze hat sich fürs Finale qualifiziert

Unterschrift des Schützen

Meyton Elektronik

Ergebnis:	625.9	(596)							
Serien:	104.0	104.3	103.3	105.0	105.6	103.7			
Zähler:	56	4	0	0	0	0	0	0	0
Innenzehner:	53								
weiteste:	287 (28), 278 (26), 266 (34)								
beste Teiler	5.0 (50.) 29.8 (43.) 30.1 (33.)								
Trefferlage	0.07 mm links, 0.01 mm hoch								
Streuwert	1.04, horizontal: 1.15, vertikal: 0.92								

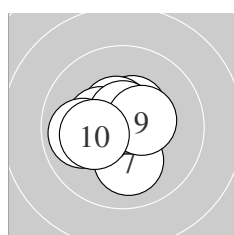
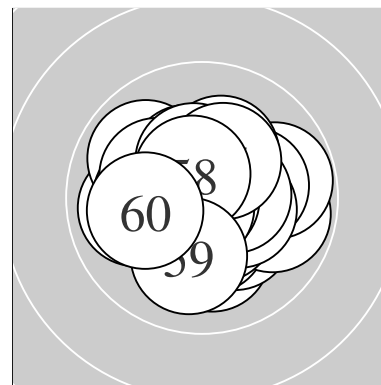

Serie 1:	10.7 *	10.5 *	10.5 *	10.4 *	10.7 *
	10.6 *	10.1 ↓	9.9 ←	10.4 *	10.2 *
beste Teiler	62.2 (1.) 74.0 (5.) 97.9 (6.)				
Trefferlage	0.50 mm links, 0.03 mm hoch				
Streuwert	1.08, horizontal: 1.16, vertikal: 0.99				

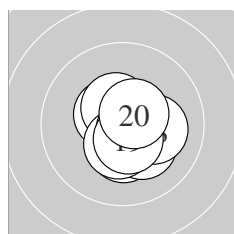

Serie 2:	10.5 *	10.4 *	10.3 *	10.5 *	10.2 *
	10.4 *	10.7 *	10.2 *	10.5 *	10.6 *
beste Teiler	67.0 (17.) 99.0 (20.) 102.5 (19.)				
Trefferlage	0.40 mm rechts, 0.46 mm tief				
Streuwert	0.90, horizontal: 0.84, vertikal: 0.95				

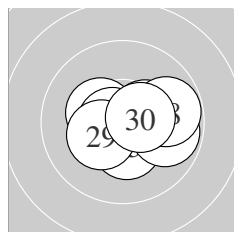

Serie 3:	10.5 *	10.3 *	10.7 *	10.7 *	10.4 *
	9.8 →	10.3 *	9.8 →	10.3 *	10.5 *
beste Teiler	66.0 (23.) 71.1 (24.) 102.0 (21.)				
Trefferlage	0.42 mm rechts, 0.20 mm tief				
Streuwert	1.22, horizontal: 1.57, vertikal: 0.71				

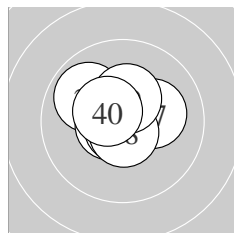

Serie 4:	10.6 *	10.5 *	10.8 *	9.9 ↘	10.6 *
	10.8 *	10.2 *	10.7 *	10.4 *	10.5 *
beste Teiler	30.1 (33.) 47.8 (36.) 72.4 (38.)				
Trefferlage	0.20 mm links, 0.45 mm hoch				
Streuwert	0.93, horizontal: 1.05, vertikal: 0.79				

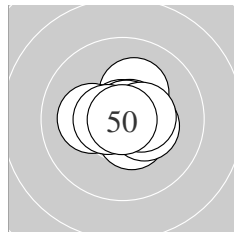

Serie 5:	10.2 *	10.2 *	10.8 *	10.7 *	10.5 *
	10.8 *	10.6 *	10.4 *	10.5 *	10.9 *
beste Teiler	5.0 (50.) 29.8 (43.) 34.6 (46.)				
Trefferlage	0.16 mm rechts, 0.11 mm hoch				
Streuwert	0.86, horizontal: 1.00, vertikal: 0.69				

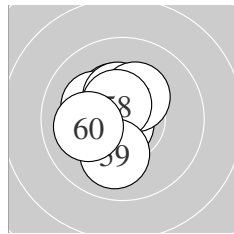

Serie 6:	10.4 *	10.5 *	10.2 *	10.8 *	10.4 *
	10.4 *	10.3 *	10.6 *	10.0 ↓	10.1 ←
beste Teiler	41.0 (54.) 100.4 (58.) 110.1 (52.)				
Trefferlage	0.73 mm links, 0.17 mm hoch				
Streuwert	1.04, horizontal: 0.84, vertikal: 1.21				

Meyton Elektronik

ISSF AR Women – Wertung – Frauen

StandNr: 131

Sidi, Roxana #411

StartNr: 33

21. Januar 2020 9:46

ROU

Unterschrift des Schützen

Meyton Elektronik

Ergebnis:	616.5	(592)
Serien:	100.8	103.8 101.6 102.9 103.8 103.6
Zähler:	52	8 0 0 0 0 0 0 0 0
Innenzehner:	42	
weiteste:	412	(8), 394 (2), 336 (32)
beste Teiler	53.6	(7.) 65.8 (15.) 74.4 (16.)
Trefferlage	0.06	mm rechts, 0.19 mm hoch
Streuwert	1.32,	horizontal: 1.46, vertikal: 1.18

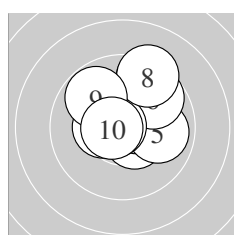
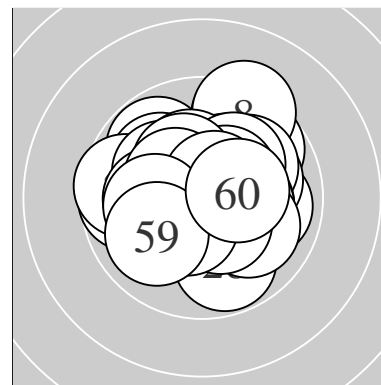

Serie 1:	10.5 *	9.4 ↗	10.5 *	10.4 *	9.9 →
	9.7 ↗	10.7 *	9.3 ↗	9.8 ↘	10.6 *
beste Teiler	53.6	(7.) 78.3 (10.)	106.2 (3.)		
Trefferlage	0.56	mm rechts, 1.07 mm hoch			
Streuwert	1.62,	horizontal: 1.60, vertikal: 1.65			

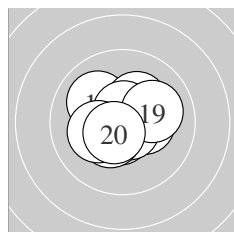

Serie 2:	10.0 ↘	10.3 *	10.6 *	10.3 *	10.7 *
	10.7 *	10.4 *	10.2 *	10.0 →	10.6 *
beste Teiler	65.8	(15.) 74.4 (16.)	87.0 (13.)		
Trefferlage	0.00	mm , 0.04 mm hoch			
Streuwert	1.16,	horizontal: 1.32, vertikal: 0.96			

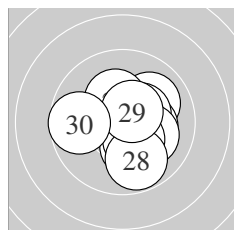

Serie 3:	10.0 ↗	10.2 *	10.3 *	10.4 *	10.2 *
	10.1 ↘	10.4 *	9.8 ↘	10.5 *	9.7 ←
beste Teiler	102.7	(29.) 139.5 (24.)	148.4 (27.)		
Trefferlage	0.62	mm rechts, 0.25 mm tief			
Streuwert	1.45,	horizontal: 1.51, vertikal: 1.39			

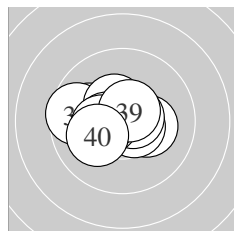

Serie 4:	10.0 ←	9.6 ←	10.2 *	10.6 *	10.4 *
	10.6 *	10.5 *	10.3 *	10.6 *	10.1 ←
beste Teiler	80.3	(36.) 88.2 (39.)	93.0 (34.)		
Trefferlage	0.69	mm links, 0.08 mm hoch			
Streuwert	1.24,	horizontal: 1.63, vertikal: 0.66			

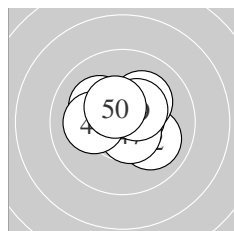

Serie 5:	10.6 *	10.0 ↘	10.6 *	10.2 *	10.2 *
	10.6 *	10.6 *	10.1 ←	10.4 *	10.5 *
beste Teiler	83.1	(46.) 83.6 (43.)	89.3 (41.)		
Trefferlage	0.26	mm rechts, 0.40 mm hoch			
Streuwert	1.10,	horizontal: 1.30, vertikal: 0.86			

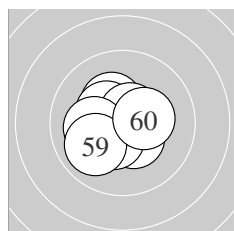

Serie 6:	10.3 *	10.6 *	10.4 *	10.5 *	10.4 *
	10.4 *	10.6 *	10.1 ←	10.0 ←	10.3 *
beste Teiler	82.7	(52.) 84.6 (57.)	119.0 (54.)		
Trefferlage	0.35	mm links, 0.15 mm tief			
Streuwert	1.11,	horizontal: 1.22, vertikal: 1.00			

Meyton Elektronik

ISSF AR Women – Wertung – Frauen

StandNr: 132

Züger, Muriel #420

StartNr: 34

21. Januar 2020 9:45

SUI

Unterschrift des Schützen

Meyton Elektronik

Ergebnis:	628.8	(598) ^{QF}							
Serien:	105.9	104.7	103.9	104.9	104.4	105.0			
Zähler:	58	2	0	0	0	0	0	0	0
Innenzehner:	54								
weiteste:	268 (50), 265 (16), 250 (29)								
beste Teiler	4.0 (3.) 26.0 (51.) 42.2 (40.)								
Trefferlage	0.01 mm rechts, 0.29 mm hoch								
Streuwert	0.92, horizontal: 0.92, vertikal: 0.92								

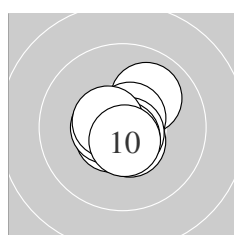
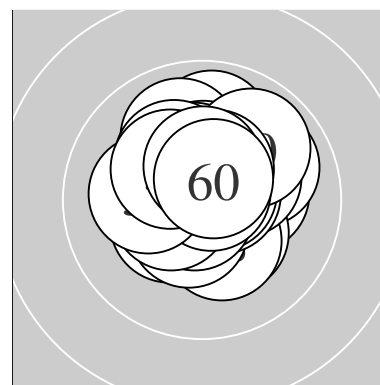

Serie 1:	10.6 *	10.0 ↗	10.9 *	10.7 *	10.6 *
	10.5 *	10.7 *	10.7 *	10.6 *	10.6 *
beste Teiler	4.0 (3.) 51.6 (7.) 62.8 (8.)				
Trefferlage	0.02 mm rechts, 0.06 mm tief				
Streuwert	0.79, horizontal: 0.76, vertikal: 0.82				

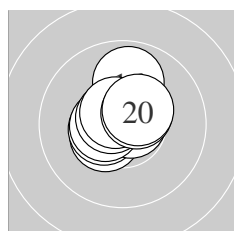

Serie 2:	10.4 *	10.6 *	10.5 *	10.7 *	10.5 *
	9.9 ↑	10.6 *	10.6 *	10.5 *	10.4 *
beste Teiler	52.1 (14.) 81.4 (17.) 84.9 (18.)				
Trefferlage	0.26 mm links, 0.42 mm hoch				
Streuwert	0.89, horizontal: 0.85, vertikal: 0.93				

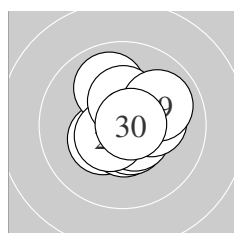

Serie 3:	10.4 *	10.5 *	10.6 *	10.6 *	10.0 ↘
	10.5 *	10.4 *	10.2 *	10.0 ↗	10.7 *
beste Teiler	52.3 (30.) 99.3 (24.) 99.8 (23.)				
Trefferlage	0.30 mm rechts, 0.13 mm hoch				
Streuwert	1.14, horizontal: 1.10, vertikal: 1.18				

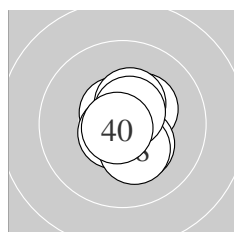

Serie 4:	10.5 *	10.6 *	10.5 *	10.3 *	10.3 *
	10.4 *	10.6 *	10.3 *	10.6 *	10.8 *
beste Teiler	42.2 (40.) 79.2 (37.) 84.8 (32.)				
Trefferlage	0.34 mm rechts, 0.21 mm hoch				
Streuwert	0.85, horizontal: 0.62, vertikal: 1.03				

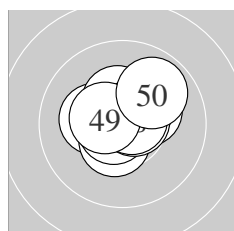

Serie 5:	10.2 *	10.5 *	10.7 *	10.3 *	10.4 *
	10.5 *	10.7 *	10.7 *	10.5 *	9.9 ↗
beste Teiler	63.0 (43.) 66.7 (48.) 75.2 (47.)				
Trefferlage	0.12 mm rechts, 0.47 mm hoch				
Streuwert	1.01, horizontal: 1.15, vertikal: 0.84				

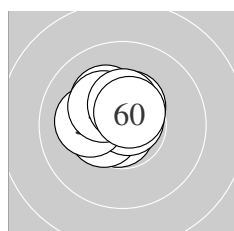

Serie 6:	10.8 *	10.8 *	10.2 *	10.5 *	10.5 *
	10.8 *	10.1 ←	10.3 *	10.4 *	10.6 *
beste Teiler	26.0 (51.) 47.3 (56.) 49.6 (52.)				
Trefferlage	0.44 mm links, 0.59 mm hoch				
Streuwert	0.78, horizontal: 0.86, vertikal: 0.69				

Meyton Elektronik

ISSF AR Women – Wertung – Frauen

StandNr: 133

Ho, Xiu Yi #424

StartNr: 35

21. Januar 2020 9:36

SGP

QF – Schütze hat sich fürs Finale qualifiziert

Unterschrift des Schützen

Meyton Elektronik

Ergebnis: **615.4** (591)
 Serien: 101.2 103.8 102.2 101.5 103.3 103.4
 Zähler: 51 9 0 0 0 0 0 0 0
 Innenzehner: 35
 weiteste: 333 (33), 319 (38), 304 (30)
 beste Teiler 5.8 (39.) 29.8 (17.) 48.2 (20.)
 Trefferlage 0.02 mm links, 0.08 mm tief
 Streuwert 1.36, horizontal: 1.37, vertikal: 1.35

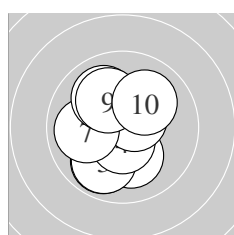
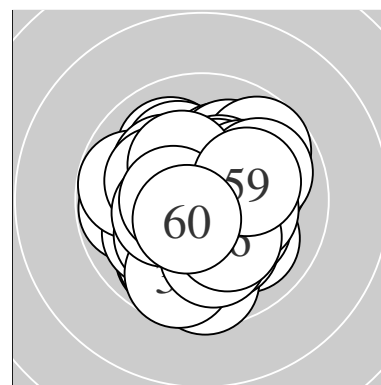

Serie 1:
 9.9 ↙ 10.1 ↓ 9.9 ↙ 10.6 * 10.6 *
 10.0 ↘ 10.0 ← 10.0 ↘ 10.1 ↘ 10.0 ↗
 beste Teiler 97.0 (4.) 99.8 (5.) 204.4 (2.)
 Trefferlage 0.57 mm links, 0.02 mm hoch
 Streuwert 1.56, horizontal: 1.24, vertikal: 1.83

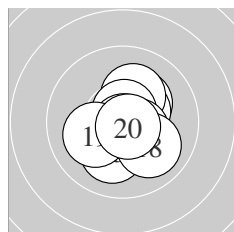

Serie 2:
 10.2 * 10.4 * 10.1 ↙ 10.2 * 10.7 *
 10.5 * 10.8 * 10.0 ↘ 10.1 ← 10.8 *
 beste Teiler 29.8 (17.) 48.2 (20.) 70.8 (15.)
 Trefferlage 0.37 mm rechts, 0.10 mm tief
 Streuwert 1.15, horizontal: 1.06, vertikal: 1.23

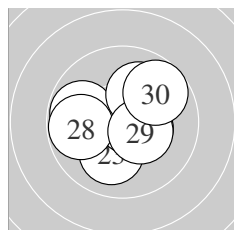

Serie 3:
 10.6 * 10.4 * 10.1 ↙ 10.8 * 10.5 *
 9.8 ← 10.1 ↗ 9.8 ← 10.4 * 9.7 ↗
 beste Teiler 50.0 (24.) 93.0 (21.) 108.8 (25.)
 Trefferlage 0.17 mm rechts, 0.15 mm hoch
 Streuwert 1.51, horizontal: 1.75, vertikal: 1.22

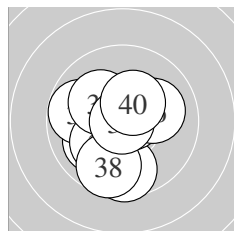

Serie 4:
 10.0 ↙ 9.8 ← 9.6 ↓ 10.1 ↙ 10.7 *
 10.1 → 10.2 * 9.7 ↓ 10.9 * 10.4 *
 beste Teiler 5.8 (39.) 62.7 (35.) 144.6 (40.)
 Trefferlage 0.52 mm links, 0.50 mm tief
 Streuwert 1.59, horizontal: 1.48, vertikal: 1.70

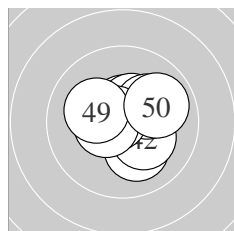

Serie 5:
 10.1 ↓ 10.2 * 10.6 * 10.4 * 10.5 *
 10.2 * 10.7 * 10.5 * 10.2 * 9.9 ↗
 beste Teiler 57.6 (47.) 100.1 (43.) 114.7 (48.)
 Trefferlage 0.24 mm rechts, 0.24 mm hoch
 Streuwert 1.22, horizontal: 1.39, vertikal: 1.02

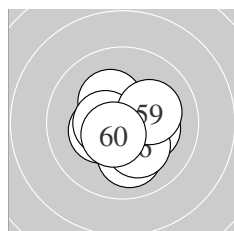

Serie 6:
 10.5 * 10.7 * 10.3 * 10.2 * 10.0 ↓
 10.2 * 10.3 * 10.5 * 10.2 * 10.5 *
 beste Teiler 67.9 (52.) 101.8 (60.) 113.8 (51.)
 Trefferlage 0.14 mm rechts, 0.33 mm tief
 Streuwert 1.15, horizontal: 1.23, vertikal: 1.08

ISSF AR Women – Wertung – Frauen

StandNr: 134

Moudgil, Anjum #462

StartNr: 36

21. Januar 2020 9:52

India

Unterschrift des Schützen

Meyton Elektronik

Ergebnis:	624.6	(596)							
Serien:	104.6	103.3	103.8	105.5	103.5	103.9			
Zähler:	56	4	0	0	0	0	0	0	0
Innenzehner:	49								
weiteste:	259 (10), 259 (30), 257 (11)								
beste Teiler	10.8 (40.) 48.0 (33.) 48.3 (59.)								
Trefferlage	0.04 mm rechts, 0.11 mm hoch								
Streuwert	1.06, horizontal: 1.15, vertikal: 0.95								

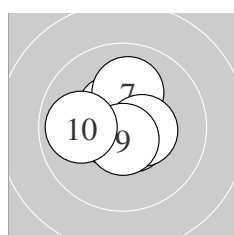
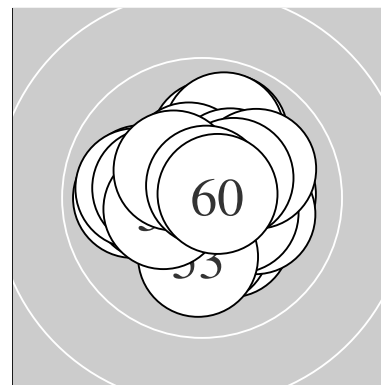

Serie 1:

10.6 *	10.5 *	10.7 *	10.7 *	10.5 *
10.5 *	10.1 ↑	10.5 *	10.6 *	9.9 ←

beste Teiler 54.6 (4.) 75.8 (3.) 76.0 (9.)
 Trefferlage 0.32 mm links, 0.24 mm hoch
 Streuwert 0.99, horizontal: 1.05, vertikal: 0.91

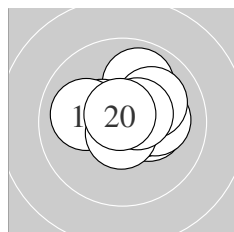

Serie 2:

9.9 ↑	10.4 *	10.3 *	10.0 ←	10.5 *
10.1 →	10.1 ↗	10.7 *	10.5 *	10.8 *

beste Teiler 50.9 (20.) 69.4 (18.) 105.6 (19.)
 Trefferlage 0.46 mm rechts, 0.48 mm hoch
 Streuwert 1.15, horizontal: 1.40, vertikal: 0.84

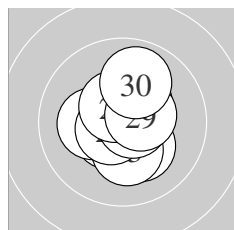

Serie 3:

10.5 *	10.2 *	10.3 *	10.2 *	10.6 *
10.7 *	10.4 *	10.5 *	10.5 *	9.9 ↑

beste Teiler 63.0 (26.) 83.3 (25.) 109.3 (21.)
 Trefferlage 0.09 mm rechts, 0.05 mm hoch
 Streuwert 1.14, horizontal: 1.01, vertikal: 1.26

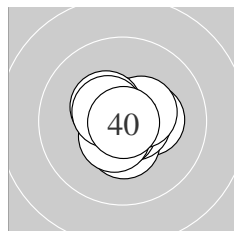

Serie 4:

10.3 *	10.4 *	10.8 *	10.6 *	10.7 *
10.5 *	10.4 *	10.4 *	10.5 *	10.9 *

beste Teiler 10.8 (40.) 48.0 (33.) 62.5 (35.)
 Trefferlage 0.10 mm rechts, 0.06 mm tief
 Streuwert 0.80, horizontal: 0.86, vertikal: 0.73

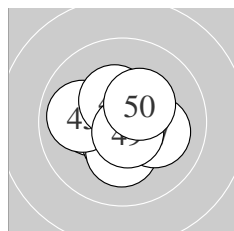

Serie 5:

10.5 *	10.2 *	10.5 *	10.2 *	9.9 ←
10.7 *	10.1 →	10.4 *	10.7 *	10.3 *

beste Teiler 69.7 (49.) 70.0 (46.) 106.3 (41.)
 Trefferlage 0.04 mm links, 0.13 mm tief
 Streuwert 1.19, horizontal: 1.35, vertikal: 1.00

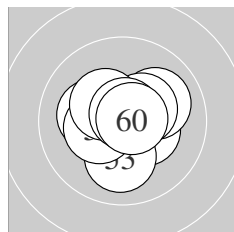

Serie 6:

10.4 *	10.2 *	10.1 ↓	10.0 ↗	10.4 *
10.5 *	10.4 *	10.4 *	10.8 *	10.7 *

beste Teiler 48.3 (59.) 59.9 (60.) 105.3 (56.)
 Trefferlage 0.02 mm links, 0.10 mm hoch
 Streuwert 1.16, horizontal: 1.31, vertikal: 0.98

Meyton Elektronik

ISSF AR Women – Wertung – Frauen

StandNr: 135

Brühler, Myriam #474

StartNr: 37

21. Januar 2020 9:54

SUI

Unterschrift des Schützen

Meyton Elektronik

Ergebnis:	586.2	(560)
Serien:	94.4 97.3 99.4 98.4 99.2 97.5	
Zähler:	31 19 9 1 0 0 0 0 0 0	
Innenzehner:	21	
weiteste:	861 (13), 738 (2), 628 (3)	
beste Teiler	47.0 (29.) 54.1 (19.) 57.3 (24.)	
Trefferlage	0.38 mm rechts, 0.30 mm hoch	
Streuwert	2.44, horizontal: 2.94, vertikal: 1.81	

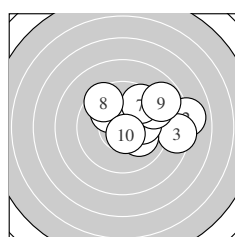
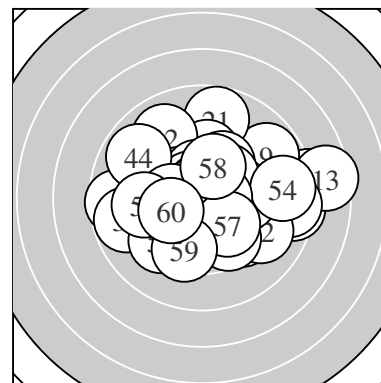

Serie 1:	10.1 ↘	8.0 →	8.4 →	10.1 ↘	10.0 ←
	9.3 ↗	9.6 ↗	9.5 ↘	8.8 ↗	10.6 *
beste Teiler	84.1 (10.) 217.4 (1.) 218.6 (4.)				
Trefferlage	2.44 mm rechts, 1.09 mm hoch				
Streuwert	2.44, horizontal: 3.07, vertikal: 1.58				

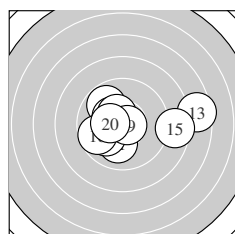

Serie 2:	10.0 ↓	9.8 ↘	7.5 →	10.0 ↙	8.5 →
	9.7 ←	10.3 *	10.4 *	10.7 *	10.4 *
beste Teiler	54.1 (19.) 133.9 (18.) 143.4 (20.)				
Trefferlage	0.45 mm rechts, 0.02 mm hoch				
Streuwert	2.82, horizontal: 3.75, vertikal: 1.38				

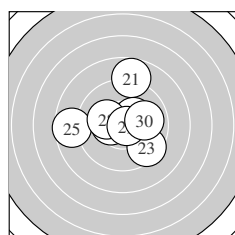

Serie 3:	8.8 ↑	10.2 *	9.5 ↘	10.7 *	8.6 ←
	10.4 *	10.3 *	10.2 *	10.8 *	9.9 →
beste Teiler	47.0 (29.) 57.3 (24.) 135.0 (26.)				
Trefferlage	0.12 mm rechts, 0.46 mm hoch				
Streuwert	2.29, horizontal: 2.56, vertikal: 1.98				

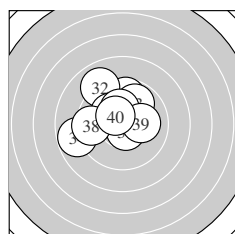

Serie 4:	9.7 ↑	9.0 ↘	9.9 ↗	8.8 ←	10.2 *
	10.2 *	10.6 *	9.5 ←	10.1 →	10.4 *
beste Teiler	85.4 (37.) 126.9 (40.) 179.2 (36.)				
Trefferlage	0.97 mm links, 1.13 mm hoch				
Streuwert	2.05, horizontal: 2.28, vertikal: 1.79				

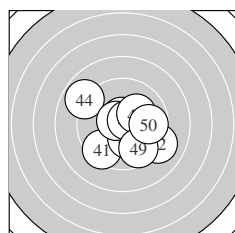

Serie 5:	9.5 ↙	9.1 ↘	10.2 *	8.9 ↘	10.6 *
	10.6 *	10.7 *	10.2 *	9.6 ↘	9.8 →
beste Teiler	64.5 (47.) 82.7 (46.) 83.1 (45.)				
Trefferlage	0.38 mm rechts, 0.39 mm tief				
Streuwert	2.21, horizontal: 2.48, vertikal: 1.91				

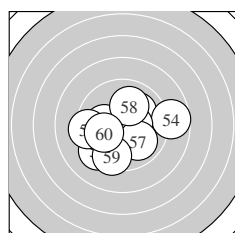

Serie 6:	9.3 ↙	10.1 ↗	10.1 ←	8.7 →	9.4 ←
	10.5 *	9.9 ↘	10.0 ↑	9.5 ↓	10.0 ←
beste Teiler	120.0 (56.) 210.1 (53.) 224.4 (52.)				
Trefferlage	0.13 mm links, 0.51 mm tief				
Streuwert	2.39, horizontal: 2.84, vertikal: 1.83				

Meyton Elektronik

ISSF AR Women – Wertung – Frauen

StandNr: 136

Moser, Arinette #463

StartNr: 38

21. Januar 2020 9:45

LIE

Unterschrift des Schützen

Meyton Elektronik

Ergebnis:	630.5	(596) ^{QF}					
Serien:	105.7	106.0	105.4	104.4	104.9	104.1	
Zähler:	56	4	0	0	0	0	0
Innenzehner:	55						
weiteste:	315 (32), 293 (48), 274 (33)						
beste Teiler	11.1 (16.) 18.9 (37.) 30.8 (8.)						
Trefferlage	0.12 mm links, 0.06 mm hoch						
Streuwert	0.92, horizontal: 0.95, vertikal: 0.88						

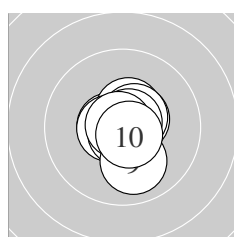
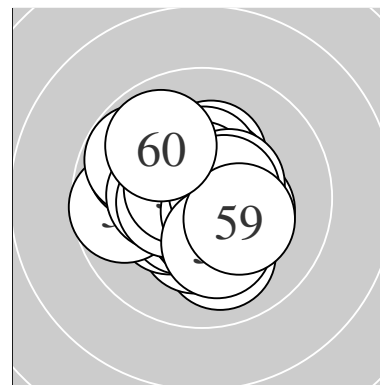

Serie 1:					
	10.5 *	10.6 *	10.5 *	10.5 *	10.6 *
	10.7 *	10.8 *	10.8 *	10.0 ↓	10.7 *
beste Teiler	30.8 (8.) 38.6 (7.) 52.6 (6.)				
Trefferlage	0.16 mm rechts, 0.03 mm tief				
Streuwert	0.79, horizontal: 0.64, vertikal: 0.92				

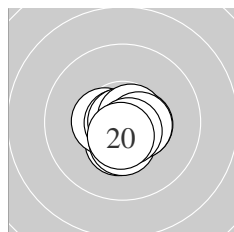

Serie 2:					
	10.5 *	10.4 *	10.5 *	10.4 *	10.8 *
	10.9 *	10.7 *	10.5 *	10.7 *	10.6 *
beste Teiler	11.1 (16.) 34.3 (15.) 64.0 (17.)				
Trefferlage	0.11 mm rechts, 0.42 mm tief				
Streuwert	0.65, horizontal: 0.71, vertikal: 0.60				

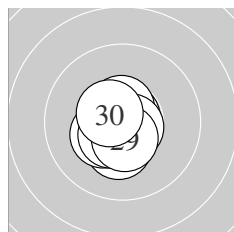

Serie 3:					
	10.6 *	10.6 *	10.8 *	10.6 *	10.3 *
	10.7 *	10.3 *	10.5 *	10.5 *	10.5 *
beste Teiler	43.2 (23.) 62.1 (26.) 78.2 (22.)				
Trefferlage	0.35 mm links, 0.19 mm tief				
Streuwert	0.73, horizontal: 0.58, vertikal: 0.86				

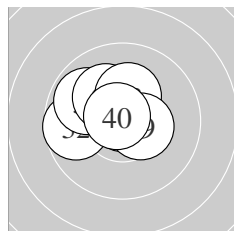

Serie 4:					
	10.8 *	9.7 ←	9.9 ↖	10.7 *	10.7 *
	10.2 *	10.9 *	10.3 *	10.4 *	10.8 *
beste Teiler	18.9 (37.) 39.6 (31.) 50.3 (40.)				
Trefferlage	0.50 mm links, 0.57 mm hoch				
Streuwert	1.09, horizontal: 1.34, vertikal: 0.74				

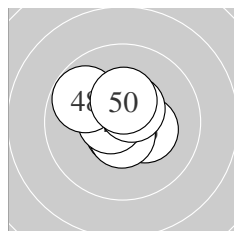

Serie 5:					
	10.7 *	10.7 *	10.7 *	10.6 *	10.3 *
	10.6 *	10.6 *	9.8 ↖	10.5 *	10.4 *
beste Teiler	60.5 (43.) 65.8 (42.) 67.7 (41.)				
Trefferlage	0.06 mm links, 0.38 mm hoch				
Streuwert	0.95, horizontal: 1.05, vertikal: 0.84				

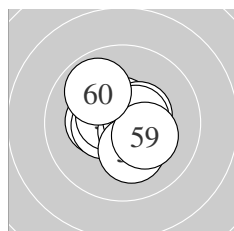

Serie 6:					
	10.3 *	10.6 *	10.5 *	10.6 *	10.5 *
	10.6 *	10.6 *	10.2 *	10.3 *	9.9 ↖
beste Teiler	79.2 (56.) 85.7 (52.) 93.6 (57.)				
Trefferlage	0.08 mm links, 0.09 mm hoch				
Streuwert	1.12, horizontal: 1.18, vertikal: 1.05				

Meyton Elektronik

ISSF AR Women – Wertung – Frauen

StartNr: 39

StandNr: 137

21. Januar 2020 9:37

Tan, Adele Qian Xiu #470

SGP

QF – Schütze hat sich fürs Finale qualifiziert

Unterschrift des Schützen

Meyton Elektronik

Ergebnis:	610.0	(584)							
Serien:	103.5	100.2	101.4	102.1	101.0	101.8			
Zähler:	45	14	1	0	0	0	0	0	0
Innenzehner:	34								
weiteste:	507 (13), 408 (49), 393 (11)								
beste Teiler	10.7 (4.)	40.3 (1.)	55.8 (54.)						
Trefferlage	0.07 mm links, 0.48 mm hoch								
Streuwert	1.53, horizontal: 1.68, vertikal: 1.36								

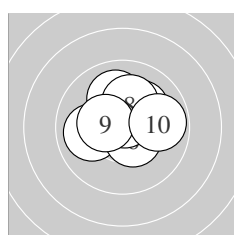
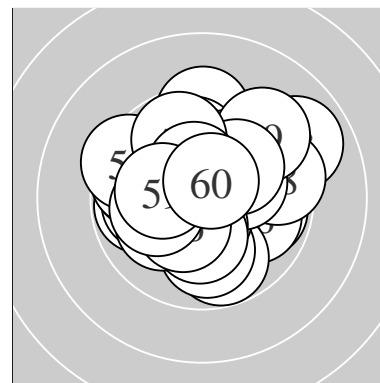

Serie 1:	10.8 *	10.2 *	10.0 ↑	10.9 *	10.0 ←
	10.5 *	10.7 *	10.2 *	10.4 *	9.8 →
beste Teiler	10.7 (4.)	40.3 (1.)	64.2 (7.)		
Trefferlage	0.16 mm rechts, 0.53 mm hoch				
Streuwert	1.23, horizontal: 1.42, vertikal: 1.01				

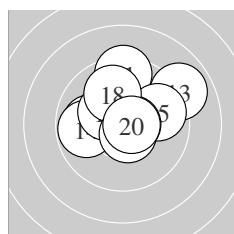

Serie 2:	9.4 ↑	10.0 ←	8.9 ↗	9.8 ←	9.8 →
	10.3 *	10.7 *	10.0 ↑	10.6 *	10.7 *
beste Teiler	70.1 (20.)	75.0 (17.)	88.1 (19.)		
Trefferlage	0.16 mm rechts, 0.96 mm hoch				
Streuwert	1.90, horizontal: 2.22, vertikal: 1.52				

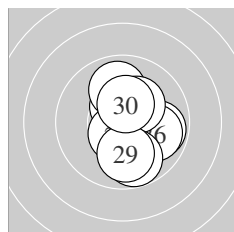

Serie 3:	10.4 *	10.4 *	10.5 *	9.8 →	9.9 ↑
	9.9 →	10.3 *	9.8 ↓	10.0 ↓	10.4 *
beste Teiler	101.0 (23.)	127.6 (21.)	140.4 (22.)		
Trefferlage	0.68 mm rechts, 0.02 mm hoch				
Streuwert	1.50, horizontal: 1.13, vertikal: 1.80				

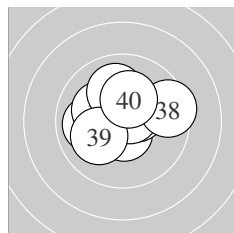

Serie 4:	10.0 ←	10.4 *	10.6 *	10.2 *	10.4 *
	10.7 *	10.0 ↑	9.5 →	10.1 ←	10.2 *
beste Teiler	74.6 (36.)	90.7 (33.)	126.6 (35.)		
Trefferlage	0.21 mm links, 0.44 mm hoch				
Streuwert	1.48, horizontal: 1.79, vertikal: 1.09				

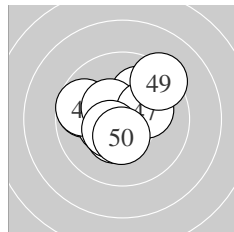

Serie 5:	9.7 ↖	10.4 *	10.4 *	10.0 ↗	9.7 ↖
	10.4 *	10.2 *	10.5 *	9.3 ↗	10.4 *
beste Teiler	124.3 (48.)	131.3 (50.)	134.5 (46.)		
Trefferlage	0.40 mm links, 0.44 mm hoch				
Streuwert	1.66, horizontal: 1.90, vertikal: 1.38				

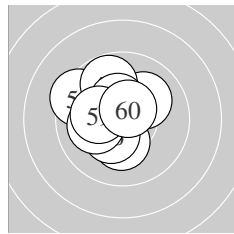

Serie 6:	10.2 *	10.1 ↗	9.4 ↖	10.7 *	9.8 ↑
	10.3 *	10.1 ←	10.4 *	10.2 *	10.6 *
beste Teiler	55.8 (54.)	90.3 (60.)	138.3 (58.)		
Trefferlage	0.82 mm links, 0.52 mm hoch				
Streuwert	1.40, horizontal: 1.42, vertikal: 1.39				

ISSF AR Women – Wertung – Frauen

StandNr: 138

Riccardi, Agata Alina #461

StartNr: 40

21. Januar 2020 9:28

SMR

Unterschrift des Schützen

Meyton Elektronik

Ergebnis: **620.3** (593)
 Serien: 104.2 101.9 102.3 104.8 102.0 105.1
 Zähler: 53 7 0 0 0 0 0 0 0
 Innenzehner: 44
 weiteste: 410 (19), 361 (49), 304 (18)
 beste Teiler 50.4 (37.) 62.2 (7.) 64.0 (53.)
 Trefferlage 0.08 mm links, 0.14 mm tief
 Streuwert 1.22, horizontal: 1.40, vertikal: 1.01

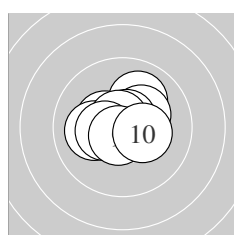
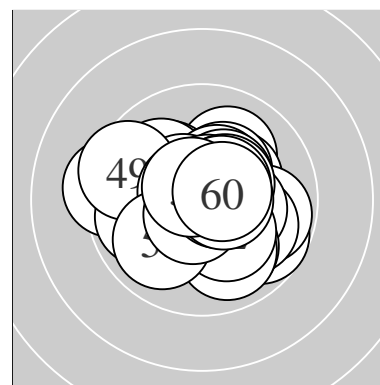

Serie 1:
 10.0 ↗ 10.4 * 10.6 * 10.1 ← 10.3 *
 10.7 * 10.7 * 10.4 * 10.7 * 10.3 *
 beste Teiler 62.2 (7.) 66.6 (6.) 71.1 (9.)
 Trefferlage 0.21 mm links, 0.29 mm hoch
 Streuwert 1.06, horizontal: 1.27, vertikal: 0.79

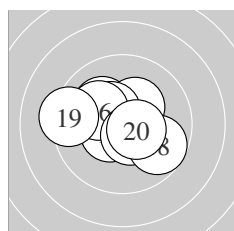

Serie 2:
 10.1 ↘ 10.3 * 10.5 * 10.5 * 10.4 *
 10.1 ↘ 10.5 * 9.7 ↘ 9.3 ← 10.5 *
 beste Teiler 102.9 (17.) 111.3 (13.) 111.7 (20.)
 Trefferlage 0.50 mm links, 0.12 mm hoch
 Streuwert 1.51, horizontal: 1.87, vertikal: 1.03

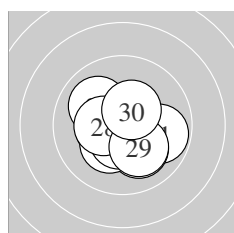

Serie 3:
 9.8 → 10.3 * 10.1 ↘ 10.0 ↘ 10.4 *
 10.3 * 10.5 * 10.4 * 10.1 ↘ 10.4 *
 beste Teiler 110.6 (27.) 133.0 (30.) 135.3 (25.)
 Trefferlage 0.14 mm links, 0.33 mm tief
 Streuwert 1.36, horizontal: 1.53, vertikal: 1.17

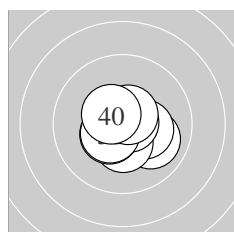

Serie 4:
 10.7 * 10.5 * 10.0 ↘ 10.3 * 10.4 *
 10.5 * 10.8 * 10.5 * 10.6 * 10.5 *
 beste Teiler 50.4 (37.) 72.9 (31.) 82.1 (39.)
 Trefferlage 0.35 mm rechts, 0.32 mm tief
 Streuwert 0.91, horizontal: 1.07, vertikal: 0.73

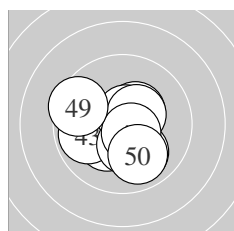

Serie 5:
 10.3 * 10.4 * 9.9 ← 10.7 * 10.3 *
 10.0 ↘ 10.4 * 10.6 * 9.5 ↘ 9.9 ↘
 beste Teiler 75.2 (44.) 91.9 (48.) 127.0 (47.)
 Trefferlage 0.15 mm links, 0.49 mm tief
 Streuwert 1.50, horizontal: 1.65, vertikal: 1.34

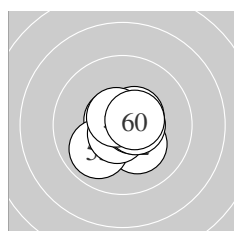

Serie 6:
 10.6 * 10.2 * 10.7 * 10.5 * 9.9 ↘
 10.6 * 10.7 * 10.6 * 10.7 * 10.6 *
 beste Teiler 64.0 (53.) 74.2 (57.) 75.2 (59.)
 Trefferlage 0.17 mm rechts, 0.14 mm tief
 Streuwert 0.92, horizontal: 0.97, vertikal: 0.86

ISSF AR Women – Wertung – Frauen

StandNr: 139

Tzabach,, Kim #465

StartNr: 41

21. Januar 2020 9:46

GBR

Unterschrift des Schützen

Meyton Elektronik

Ergebnis:	622.4	(594)					
Serien:	104.7	102.2	104.7	104.0	103.9	102.9	
Zähler:	54	6	0	0	0	0	0
Innenzehner:	46						
weiteste:	365 (17), 303 (4), 292 (18)						
beste Teiler	19.2 (1.) 20.1 (2.) 27.2 (33.)						
Trefferlage	0.06 mm rechts, 0.15 mm hoch						
Streuwert	1.16, horizontal: 1.29, vertikal: 1.01						

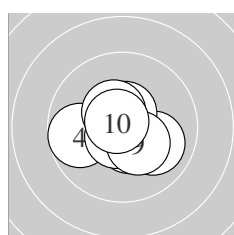
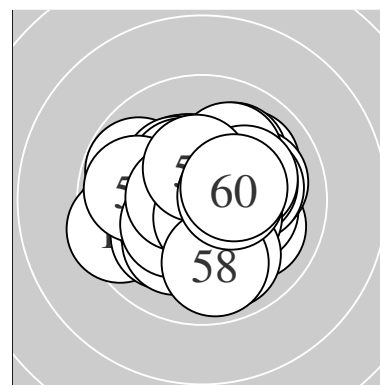

Serie 1:	10.9 *	10.9 *	10.0 ↘	9.7 ←	10.5 *
	10.6 *	10.6 *	10.5 *	10.3 *	10.7 *
beste Teiler	19.2 (1.) 20.1 (2.) 57.9 (10.)				
Trefferlage	0.08 mm links, 0.19 mm tief				
Streuwert	1.09, horizontal: 1.31, vertikal: 0.82				

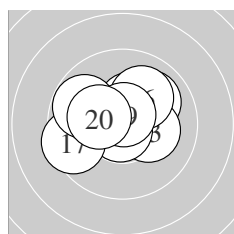

Serie 2:	10.5 *	10.0 ↗	10.2 *	10.8 *	10.4 *
	10.0 ↗	9.5 ←	9.8 ↖	10.7 *	10.3 *
beste Teiler	43.0 (14.) 66.4 (19.) 121.3 (11.)				
Trefferlage	0.17 mm links, 0.61 mm hoch				
Streuwert	1.48, horizontal: 1.84, vertikal: 1.00				

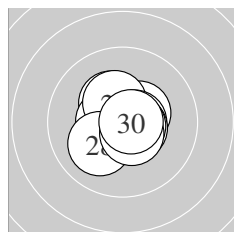

Serie 3:	10.3 *	10.5 *	10.4 *	10.4 *	10.6 *
	10.6 *	10.6 *	10.1 ↗	10.5 *	10.7 *
beste Teiler	59.0 (30.) 81.9 (27.) 84.0 (25.)				
Trefferlage	0.08 mm rechts, 0.04 mm hoch				
Streuwert	0.94, horizontal: 0.98, vertikal: 0.89				

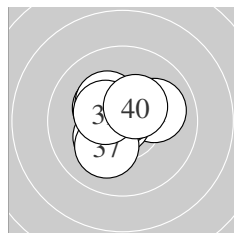

Serie 4:	10.0 →	10.7 *	10.8 *	10.3 *	10.7 *
	10.3 *	10.1 ↗	10.3 *	10.4 *	10.4 *
beste Teiler	27.2 (33.) 55.4 (32.) 56.3 (35.)				
Trefferlage	0.30 mm links, 0.27 mm hoch				
Streuwert	1.06, horizontal: 1.15, vertikal: 0.97				

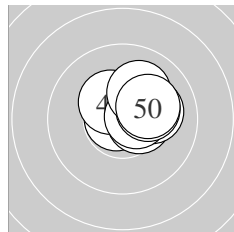

Serie 5:	10.8 *	10.8 *	10.5 *	10.2 *	10.1 →
	10.4 *	10.6 *	10.2 *	10.1 ↗	10.2 *
beste Teiler	38.0 (41.) 44.0 (42.) 98.4 (47.)				
Trefferlage	0.80 mm rechts, 0.68 mm hoch				
Streuwert	0.86, horizontal: 1.01, vertikal: 0.68				

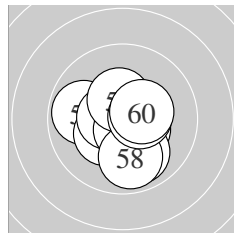

Serie 6:	9.9 ←	10.3 *	10.4 *	10.6 *	10.6 *
	10.4 *	9.9 ↘	9.9 ↘	10.5 *	10.4 *
beste Teiler	76.6 (55.) 97.5 (54.) 122.0 (59.)				
Trefferlage	0.03 mm rechts, 0.48 mm tief				
Streuwert	1.29, horizontal: 1.32, vertikal: 1.26				

Meyton Elektronik

ISSF AR Women – Wertung – Frauen

StandNr: 140

Höbl, Sabrina #466

StartNr: 42

21. Januar 2020 9:22

GER

Unterschrift des Schützen

Meyton Elektronik

Ergebnis:	566.5	(539)
Serien:	96.9 93.5 92.6 91.0 99.0 93.5	
Zähler:	16 32 9 2 0 1 0 0 0 0	
Innenzehner:	11	
weiteste:	1334 (60), 970 (13), 835 (29)	
beste Teiler	66.0 (8.) 97.4 (42.) 115.4 (41.)	
Trefferlage	0.05 mm rechts, 0.55 mm tief	
Streuwert	3.08, horizontal: 3.58, vertikal: 2.49	

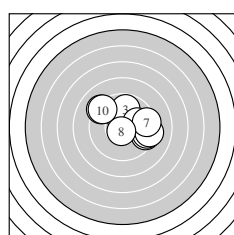
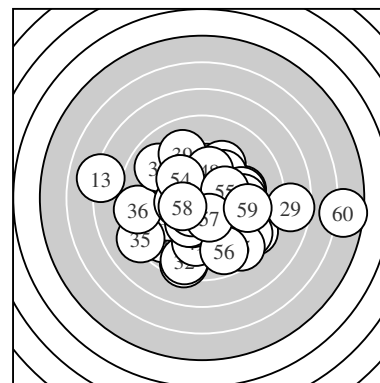

Serie 1:	9.4 →	10.4 *	9.8 ↑	9.4 →	10.0 →
	9.3 →	9.4 →	10.7 *	9.2 ↖	9.3 ↖
beste Teiler	66.0 (8.)	139.5 (2.)	240.9 (5.)		
Trefferlage	1.10 mm rechts, 0.76 mm hoch				
Streuwert	2.33, horizontal: 2.85, vertikal: 1.66				

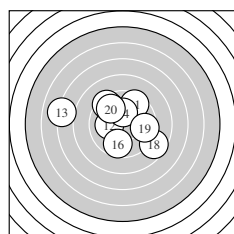

Serie 2:	9.5 ↗	10.1 ←	7.1 ←	10.2 *	9.6 ↖
	9.7 ↓	9.4 ↘	8.6 ↘	9.6 →	9.7 ↘
beste Teiler	183.1 (14.)	208.3 (12.)	305.4 (20.)		
Trefferlage	0.84 mm links, 0.80 mm hoch				
Streuwert	3.28, horizontal: 3.97, vertikal: 2.40				

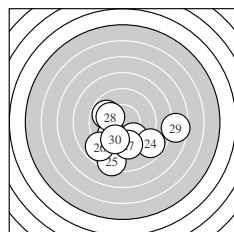

Serie 3:	9.8 ↘	9.8 ↖	9.9 ↗	8.8 ↘	8.4 ↓
	8.9 ↗	9.5 ↓	10.1 ↖	7.6 →	9.8 ↓
beste Teiler	208.3 (28.)	266.0 (23.)	280.0 (22.)		
Trefferlage	0.25 mm rechts, 2.28 mm tief				
Streuwert	3.03, horizontal: 3.67, vertikal: 2.20				

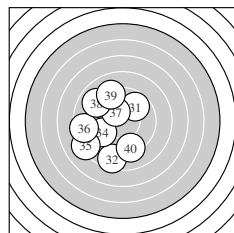

Serie 4:	9.8 ↗	8.5 ↓	9.0 ←	9.5 ↗	8.2 ↗
	8.5 ←	10.2 *	9.0 ↖	9.1 ↖	9.2 ↓
beste Teiler	178.6 (37.)	298.4 (31.)	363.9 (34.)		
Trefferlage	2.52 mm links, 0.75 mm tief				
Streuwert	3.06, horizontal: 2.76, vertikal: 3.33				

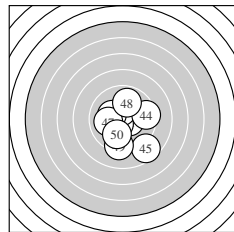

Serie 5:	10.5 *	10.6 *	10.5 *	9.5 →	8.6 ↘
	10.2 *	10.0 ←	9.9 ↑	9.3 ↓	9.9 ↓
beste Teiler	97.4 (42.)	115.4 (41.)	120.3 (43.)		
Trefferlage	0.29 mm rechts, 0.76 mm tief				
Streuwert	2.17, horizontal: 2.03, vertikal: 2.31				

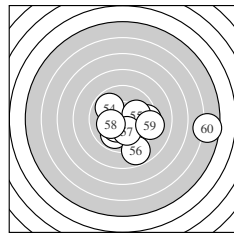

Serie 6:	9.9 ↘	10.3 *	9.4 →	9.9 ↖	10.0 →
	8.8 ↘	10.2 *	10.2 *	9.2 →	5.6 →
beste Teiler	165.3 (52.)	198.0 (57.)	200.2 (58.)		
Trefferlage	2.01 mm rechts, 1.11 mm tief				
Streuwert	3.47, horizontal: 4.56, vertikal: 1.82				

Meyton Elektronik

ISSF AR Women – Wertung – Frauen

StandNr: 141

Haindl, Marlies #113

StartNr: 43

21. Januar 2020 9:47

Steiermark

Unterschrift des Schützen

Meyton Elektronik

Ergebnis:	623.1	(596)
Serien:	104.8	103.6 104.2 103.7 105.3 101.5
Zähler:	56	4 0 0 0 0 0 0 0 0
Innenzehner:	45	
weiteste:	352	(52), 291 (54), 291 (58)
beste Teiler	9.4	(44.) 46.6 (50.) 50.9 (30.)
Trefferlage	0.08	mm rechts, 0.02 mm tief
Streuwert	1.14,	horizontal: 1.27, vertikal: 0.99

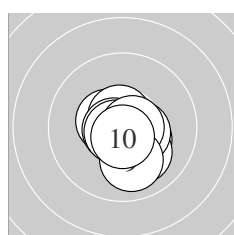
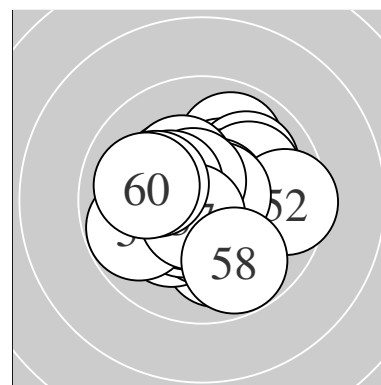

Serie 1:	10.3 *	10.5 *	10.6 *	10.7 *	10.1 ↘
	10.7 *	10.5 *	10.7 *	10.0 ↓	10.7 *
beste Teiler	58.2 (6.) 64.5 (4.) 68.0 (10.)				
Trefferlage	0.25 mm rechts, 0.53 mm tief				
Streuwert	0.89, horizontal: 0.84, vertikal: 0.93				

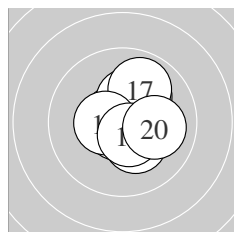

Serie 2:	10.7 *	10.3 *	10.3 *	10.1 ↗	10.6 *
	10.7 *	9.9 ↗	10.5 *	10.5 *	10.0 →
beste Teiler	58.4 (16.) 63.5 (11.) 89.0 (15.)				
Trefferlage	0.52 mm rechts, 0.28 mm hoch				
Streuwert	1.12, horizontal: 1.01, vertikal: 1.22				

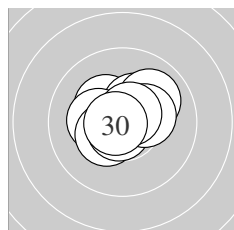

Serie 3:	10.3 *	10.4 *	10.3 *	10.4 *	10.4 *
	10.0 ↗	10.7 *	10.3 *	10.6 *	10.8 *
beste Teiler	50.9 (30.) 56.8 (27.) 77.8 (29.)				
Trefferlage	0.11 mm rechts, 0.41 mm hoch				
Streuwert	1.03, horizontal: 1.25, vertikal: 0.76				

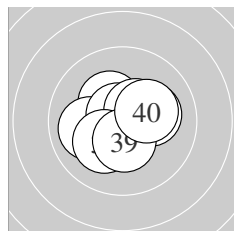

Serie 4:	10.5 *	10.3 *	10.0 ←	10.7 *	10.2 *
	10.7 *	10.5 *	10.2 *	10.4 *	10.2 *
beste Teiler	56.4 (36.) 66.9 (34.) 114.4 (31.)				
Trefferlage	0.02 mm links, 0.07 mm tief				
Streuwert	1.16, horizontal: 1.34, vertikal: 0.95				

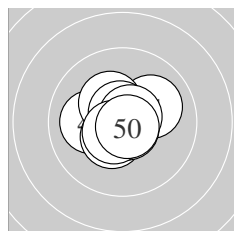

Serie 5:	10.1 ↗	10.1 ←	10.4 *	10.9 *	10.3 *
	10.7 *	10.7 *	10.7 *	10.6 *	10.8 *
beste Teiler	9.4 (44.) 46.6 (50.) 55.0 (46.)				
Trefferlage	0.13 mm links, 0.09 mm hoch				
Streuwert	0.95, horizontal: 1.10, vertikal: 0.77				

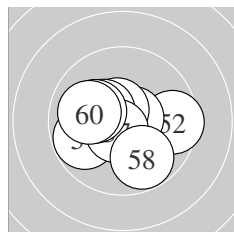

Serie 6:	10.1 ↘	9.5 →	10.7 *	9.8 ←	10.6 *
	10.3 *	10.6 *	9.8 ↓	10.1 ←	10.0 ←
beste Teiler	70.2 (53.) 81.9 (57.) 88.5 (55.)				
Trefferlage	0.21 mm links, 0.30 mm tief				
Streuwert	1.61, horizontal: 1.97, vertikal: 1.15				

Meyton Elektronik

ISSF AR Women – Wertung – Frauen

StandNr: 142

Russo, Fernanda #428

StartNr: 44

21. Januar 2020 9:51

ARG

Unterschrift des Schützen

Meyton Elektronik

Ergebnis:	628.9	(600) ^{QF}					
Serien:	104.3	105.5	105.2	103.6	105.5	104.8	
Zähler:	60	0	0	0	0	0	0
Innenzehner:	56						
weiteste:	241 (40), 239 (36), 238 (13)						
beste Teiler	10.6 (19.) 11.7 (53.) 34.0 (12.)						
Trefferlage	0.20 mm rechts, 0.25 mm hoch						
Streuwert	0.90, horizontal: 1.03, vertikal: 0.74						

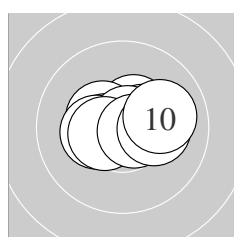
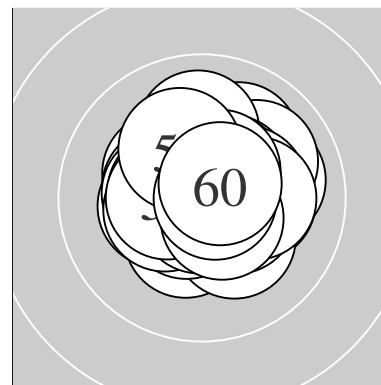

Serie 1:					
	10.5 *	10.4 *	10.5 *	10.3 *	10.4 *
	10.8 *	10.5 *	10.7 *	10.2 *	10.0 →
beste Teiler	41.0 (6.) 74.0 (8.) 105.1 (3.)				
Trefferlage	0.21 mm rechts, 0.15 mm hoch				
Streuwert	1.03, horizontal: 1.38, vertikal: 0.47				

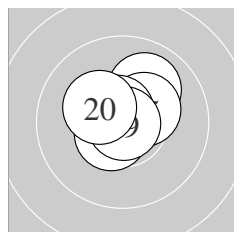

Serie 2:					
	10.6 *	10.8 *	10.0 ↗	10.6 *	10.3 *
	10.7 *	10.7 *	10.6 *	10.9 *	10.3 *
beste Teiler	10.6 (19.) 34.0 (12.) 61.8 (16.)				
Trefferlage	0.05 mm rechts, 0.50 mm hoch				
Streuwert	0.81, horizontal: 0.88, vertikal: 0.74				

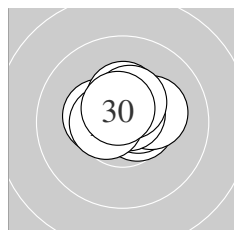

Serie 3:					
	10.6 *	10.5 *	10.2 *	10.4 *	10.8 *
	10.7 *	10.4 *	10.6 *	10.4 *	10.6 *
beste Teiler	48.3 (25.) 61.0 (26.) 88.5 (30.)				
Trefferlage	0.15 mm rechts, 0.55 mm hoch				
Streuwert	0.75, horizontal: 0.94, vertikal: 0.50				

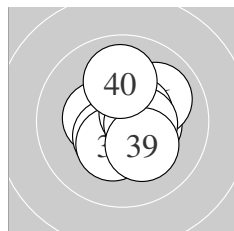

Serie 4:					
	10.7 *	10.4 *	10.4 *	10.5 *	10.3 *
	10.0 ↗	10.6 *	10.5 *	10.2 *	10.0 ↑
beste Teiler	52.3 (31.) 94.6 (37.) 111.1 (38.)				
Trefferlage	0.35 mm rechts, 0.07 mm hoch				
Streuwert	1.15, horizontal: 1.10, vertikal: 1.20				

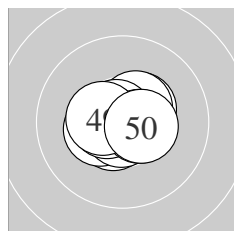

Serie 5:					
	10.6 *	10.4 *	10.5 *	10.4 *	10.8 *
	10.7 *	10.6 *	10.5 *	10.5 *	10.5 *
beste Teiler	50.9 (45.) 51.7 (46.) 91.0 (41.)				
Trefferlage	0.05 mm links, 0.00 mm				
Streuwert	0.79, horizontal: 0.98, vertikal: 0.54				

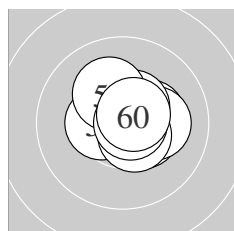

Serie 6:					
	10.4 *	10.3 *	10.9 *	10.2 *	10.4 *
	10.5 *	10.5 *	10.2 *	10.8 *	10.6 *
beste Teiler	11.7 (53.) 48.0 (59.) 84.0 (60.)				
Trefferlage	0.51 mm rechts, 0.22 mm hoch				
Streuwert	0.88, horizontal: 1.00, vertikal: 0.73				

Meyton Elektronik

QF – Schütze hat sich fürs Finale qualifiziert

Unterschrift des Schützen

Meyton Elektronik

Ergebnis:	617.7	(595)						
Serien:	100.7	103.7	104.1	103.1	103.2	102.9		
Zähler:	55	5	0	0	0	0	0	0
Innenzehner:	45							
weiteste:	466 (8), 340 (9), 309 (50)							
beste Teiler	43.5 (23.) 57.3 (56.) 65.2 (47.)							
Trefferlage	0.35 mm links, 0.11 mm hoch							
Streuwert	1.25, horizontal: 1.46, vertikal: 1.00							

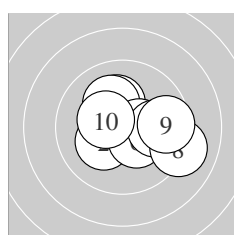
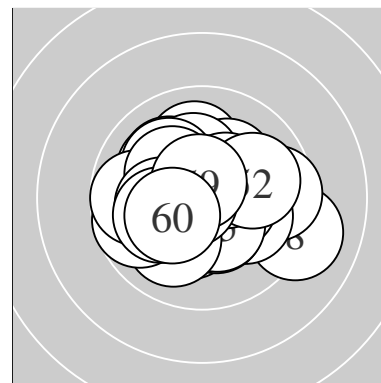

Serie 1:	10.2 *	10.2 *	10.4 *	10.1 ↖	10.4 *
	10.4 *	9.9 →	9.1 →	9.6 →	10.4 *
beste Teiler	127.1 (3.) 128.0 (5.) 144.5 (6.)				
Trefferlage	0.98 mm rechts, 0.06 mm hoch				
Streuwert	1.65, horizontal: 2.03, vertikal: 1.15				

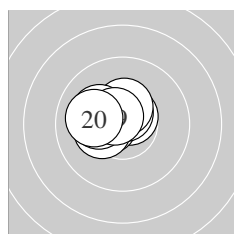

Serie 2:	10.6 *	10.5 *	10.3 *	10.6 *	10.4 *
	10.3 *	10.2 *	10.2 *	10.6 *	10.0 ←
beste Teiler	80.0 (11.) 86.2 (19.) 89.2 (14.)				
Trefferlage	0.99 mm links, 0.51 mm hoch				
Streuwert	0.78, horizontal: 0.98, vertikal: 0.50				

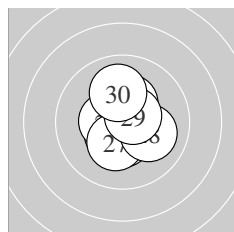

Serie 3:	10.4 *	10.5 *	10.8 *	10.5 *	10.6 *
	10.3 *	10.3 *	10.1 →	10.6 *	10.0 ↑
beste Teiler	43.5 (23.) 81.0 (25.) 95.1 (29.)				
Trefferlage	0.09 mm rechts, 0.00 mm				
Streuwert	1.09, horizontal: 0.95, vertikal: 1.22				

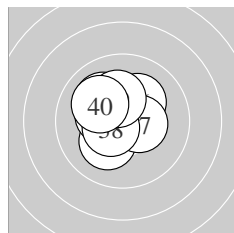

Serie 4:	10.5 *	10.2 *	10.3 *	10.1 ↘	10.6 *
	10.2 *	10.4 *	10.5 *	10.2 *	10.1 ↘
beste Teiler	94.3 (35.) 105.6 (38.) 107.9 (31.)				
Trefferlage	0.64 mm links, 0.33 mm hoch				
Streuwert	1.11, horizontal: 1.07, vertikal: 1.16				

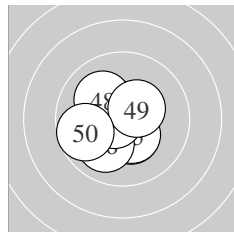

Serie 5:	10.5 *	10.5 *	10.4 *	10.5 *	10.4 *
	10.0 ↙	10.7 *	10.1 ↘	10.4 *	9.7 ←
beste Teiler	65.2 (47.) 103.0 (44.) 109.0 (42.)				
Trefferlage	0.57 mm links, 0.35 mm tief				
Streuwert	1.18, horizontal: 1.23, vertikal: 1.13				

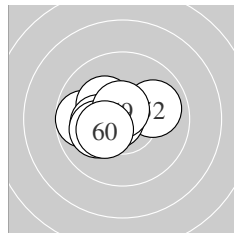

Serie 6:	10.6 *	10.0 →	9.7 ←	10.4 *	10.2 *
	10.7 *	10.2 *	10.1 ←	10.7 *	10.3 *
beste Teiler	57.3 (56.) 75.5 (59.) 76.9 (51.)				
Trefferlage	1.00 mm links, 0.12 mm hoch				
Streuwert	1.12, horizontal: 1.43, vertikal: 0.66				

ISSF AR Women – Wertung – Frauen

StandNr: 144

Auer, Marie–Theres #46

StartNr: 46

21. Januar 2020 9:44

T – SG Roppen

Unterschrift des Schützen

Meyton Elektronik