

Ergebnis: **394** (413.8)  
 Serien: 98 99 99 98  
 Zähler: 34 6 0 0 0 0 0 0 0 0  
 Innenzehner: 29  
 weiteste: 352 (7), 319 (16), 277 (36)  
 beste Teiler 8.0 (35.) 20.5 (37.) 25.3 (38.)  
 Trefferlage 0.05 mm rechts, 0.37 mm hoch  
 Streuwert 1.22, horizontal: 1.21, vertikal: 1.24

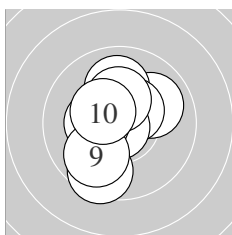

Serie 1:  
 10.0 ↗ 10.5 \* 10.0 ↑ 10.5 \* 10.8 \*  
 10.3 \* 9.5 ↘ 10.3 \* 9.9 ↙ 10.4 \*  
 beste Teiler 31.6 (5.) 109.0 (2.) 119.6 (4.)  
 Trefferlage 0.29 mm links, 0.23 mm hoch  
 Streuwert 1.48, horizontal: 1.18, vertikal: 1.73

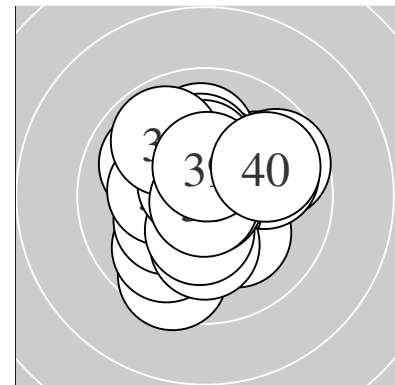
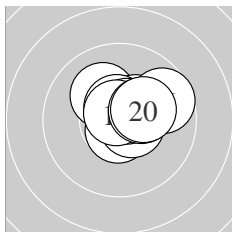

Serie 2:  
 10.7 \* 10.6 \* 10.1 ↖ 10.4 \* 10.6 \*  
 9.7 ↗ 10.6 \* 10.7 \* 10.3 \* 10.2 \*  
 beste Teiler 54.6 (18.) 69.8 (11.) 78.8 (17.)  
 Trefferlage 0.67 mm rechts, 0.62 mm hoch  
 Streuwert 0.96, horizontal: 1.17, vertikal: 0.70

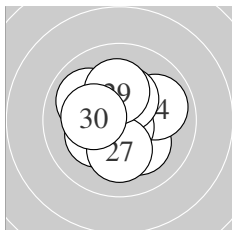

Serie 3:  
 10.2 \* 10.7 \* 10.2 \* 9.9 → 10.8 \*  
 10.4 \* 10.1 ↓ 10.0 ↖ 10.2 \* 10.2 \*  
 beste Teiler 48.2 (25.) 67.8 (22.) 150.2 (26.)  
 Trefferlage 0.20 mm links, 0.07 mm hoch  
 Streuwert 1.37, horizontal: 1.40, vertikal: 1.33

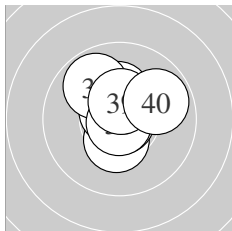

Serie 4:  
 10.4 \* 10.7 \* 10.7 \* 10.3 \* 10.9 \*  
 9.8 ↖ 10.9 \* 10.9 \* 10.5 \* 9.9 →  
 beste Teiler 8.0 (35.) 20.5 (37.) 25.3 (38.)  
 Trefferlage 0.02 mm rechts, 0.56 mm hoch  
 Streuwert 1.04, horizontal: 1.01, vertikal: 1.07

Unterschrift des Schützen

Ergebnis: **392** (411.0)  
 Serien: 97 98 98 99  
 Zähler: 32 8 0 0 0 0 0 0 0 0  
 Innenzehner: 26  
 weiteste: 460 (28), 377 (4), 348 (15)  
 beste Teiler 4.1 (34.) 17.4 (29.) 51.4 (36.)  
 Trefferlage 0.47 mm links, 0.29 mm hoch  
 Streuwert 1.35, horizontal: 1.60, vertikal: 1.05

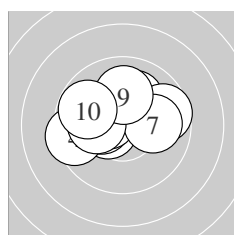
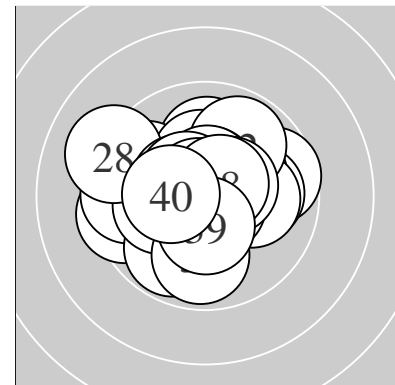

Serie 1:  
 10.1 ↗ 10.5 \* 9.7 → 9.4 ← 10.3 \*  
 10.5 \* 10.0 → 10.2 \* 10.0 ↑ 9.8 ↖  
 beste Teiler 115.1 (2.) 122.7 (6.) 160.0 (5.)  
 Trefferlage 0.58 mm links, 0.58 mm hoch  
 Streuwert 1.69, horizontal: 2.16, vertikal: 1.00

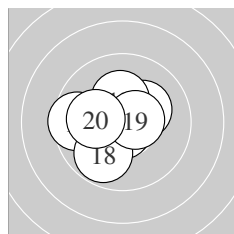

Serie 2:  
 10.7 \* 10.5 \* 10.2 \* 10.2 \* 9.6 ←  
 10.7 \* 10.3 \* 9.8 ↙ 10.6 \* 10.1 ←  
 beste Teiler 60.2 (11.) 68.2 (16.) 98.4 (19.)  
 Trefferlage 0.67 mm links, 0.15 mm hoch  
 Streuwert 1.34, horizontal: 1.54, vertikal: 1.11

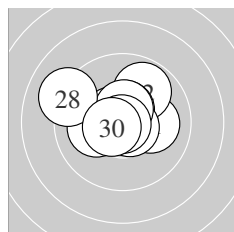

Serie 3:  
 10.1 → 9.8 ↗ 10.6 \* 10.6 \* 10.1 ←  
 10.7 \* 10.6 \* 9.1 ↖ 10.9 \* 10.6 \*  
 beste Teiler 17.4 (29.) 68.8 (26.) 89.8 (23.)  
 Trefferlage 0.33 mm links, 0.51 mm hoch  
 Streuwert 1.45, horizontal: 1.79, vertikal: 1.00

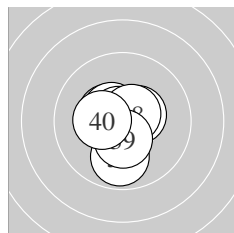

Serie 4:  
 10.4 \* 10.5 \* 10.5 \* 10.9 \* 10.5 \*  
 10.7 \* 9.9 ↓ 10.6 \* 10.4 \* 10.3 \*  
 beste Teiler 4.1 (34.) 51.4 (36.) 88.0 (38.)  
 Trefferlage 0.31 mm links, 0.06 mm tief  
 Streuwert 0.98, horizontal: 0.82, vertikal: 1.11

Unterschrift des Schützen

Meyton Elektronik

Ergebnis: **392** (409.7)  
 Serien: 97 97 99 99  
 Zähler: 33 6 1 0 0 0 0 0 0 0  
 Innenzehner: 25  
 weiteste: 584 (11), 423 (1), 371 (6)  
 beste Teiler 15.0 (8.) 25.4 (30.) 33.4 (12.)  
 Trefferlage 0.06 mm links, 0.17 mm hoch  
 Streuwert 1.51, horizontal: 1.58, vertikal: 1.44

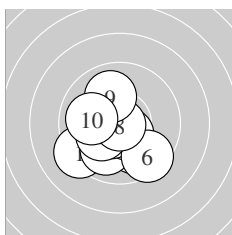
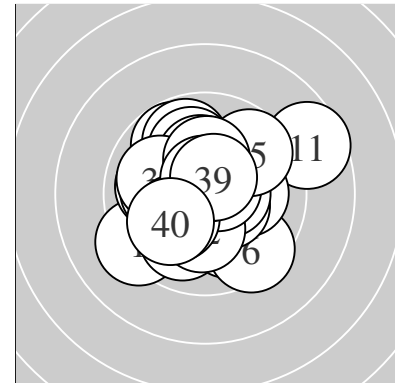

Serie 1:  
 9.3 ↙ 10.0 ↘ 9.9 ↗ 10.5 \* 10.5 \*  
 9.5 ↘ 10.2 \* 10.9 \* 10.0 ↑ 10.0 ←  
 beste Teiler 15.0 (8.) 109.1 (5.) 118.0 (4.)  
 Trefferlage 0.57 mm links, 0.99 mm tief  
 Streuwert 1.64, horizontal: 1.73, vertikal: 1.56

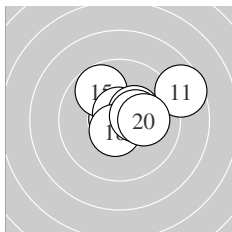

Serie 2:  
 8.6 → 10.8 \* 10.8 \* 10.4 \* 9.8 ↖  
 10.7 \* 10.4 \* 10.6 \* 10.4 \* 10.1 →  
 beste Teiler 33.4 (12.) 41.9 (13.) 60.6 (16.)  
 Trefferlage 0.86 mm rechts, 0.64 mm hoch  
 Streuwert 1.55, horizontal: 1.92, vertikal: 1.08

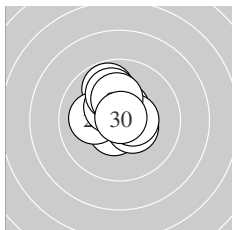

Serie 3:  
 10.6 \* 9.8 ↖ 10.5 \* 10.1 ← 10.4 \*  
 10.0 ↑ 10.4 \* 10.5 \* 10.2 \* 10.9 \*  
 beste Teiler 25.4 (30.) 94.5 (21.) 105.3 (23.)  
 Trefferlage 0.27 mm links, 0.78 mm hoch  
 Streuwert 1.10, horizontal: 1.00, vertikal: 1.19

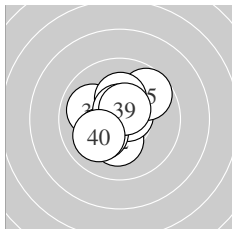

Serie 4:  
 10.7 \* 10.2 \* 10.7 \* 10.0 ← 9.7 ↗  
 10.2 \* 10.2 \* 10.6 \* 10.6 \* 10.0 ↙  
 beste Teiler 70.2 (31.) 74.2 (33.) 77.3 (38.)  
 Trefferlage 0.26 mm links, 0.27 mm hoch  
 Streuwert 1.34, horizontal: 1.34, vertikal: 1.34

Unterschrift des Schützen

Ergebnis: **390** (409.0)  
 Serien: 94 99 99 98  
 Zähler: 30 10 0 0 0 0 0 0 0 0  
 Innenzehner: 25  
 weiteste: 421 (10), 359 (11), 356 (8)  
 beste Teiler 36.1 (23.) 36.6 (36.) 48.8 (20.)  
 Trefferlage 0.45 mm rechts, 0.10 mm hoch  
 Streuwert 1.46, horizontal: 1.68, vertikal: 1.21

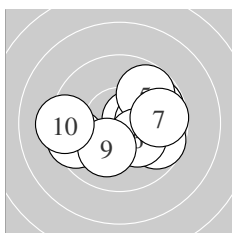
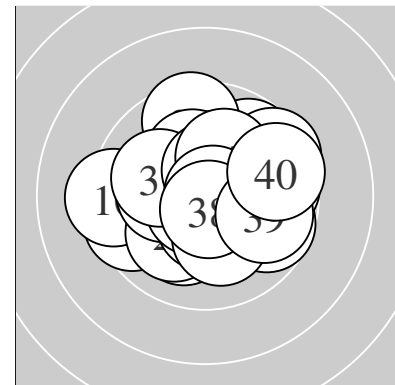

Serie 1:  
 10.6 \* 9.7 ↘ 10.2 \* 9.8 ↗ 9.8 ↗  
 10.2 \* 9.7 → 9.5 ← 10.1 ↙ 9.3 ←  
 beste Teiler 94.8 (1.) 176.9 (6.) 187.5 (3.)  
 Trefferlage 0.61 mm rechts, 0.12 mm tief  
 Streuwert 2.04, horizontal: 2.60, vertikal: 1.27

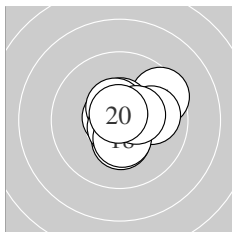

Serie 2:  
 9.5 ↗ 10.0 → 10.7 \* 10.3 \* 10.6 \*  
 10.5 \* 10.7 \* 10.4 \* 10.4 \* 10.8 \*  
 beste Teiler 48.8 (20.) 59.0 (17.) 66.4 (13.)  
 Trefferlage 0.58 mm rechts, 0.18 mm hoch  
 Streuwert 1.17, horizontal: 1.26, vertikal: 1.06

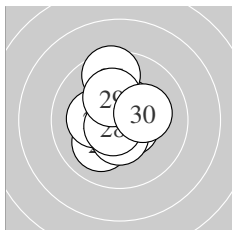

Serie 3:  
 10.6 \* 10.5 \* 10.8 \* 10.1 ↙ 10.5 \*  
 10.2 \* 9.5 ↑ 10.7 \* 10.2 \* 10.2 \*  
 beste Teiler 36.1 (23.) 70.0 (28.) 92.1 (21.)  
 Trefferlage 0.16 mm links, 0.25 mm hoch  
 Streuwert 1.30, horizontal: 1.07, vertikal: 1.50

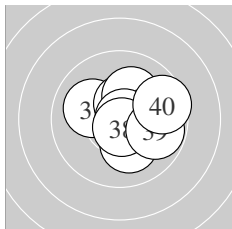

Serie 4:  
 10.5 \* 10.1 ↖ 10.6 \* 10.5 \* 10.2 \*  
 10.8 \* 10.1 ↓ 10.7 \* 9.8 → 9.6 →  
 beste Teiler 36.6 (36.) 64.2 (38.) 100.0 (33.)  
 Trefferlage 0.79 mm rechts, 0.09 mm hoch  
 Streuwert 1.31, horizontal: 1.46, vertikal: 1.14

Unterschrift des Schützen

Ergebnis: **394** (412.2)  
 Serien: 98 97 99 100  
 Zähler: 34 6 0 0 0 0 0 0 0 0  
 Innenzehner: 27  
 weiteste: 332 (12), 315 (7), 308 (19)  
 beste Teiler 31.0 (37.) 41.7 (38.) 44.4 (15.)  
 Trefferlage 0.00 mm , 0.27 mm tief  
 Streuwert 1.29, horizontal: 1.46, vertikal: 1.10

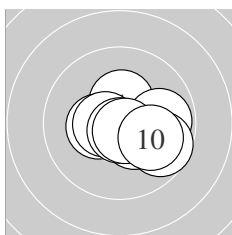
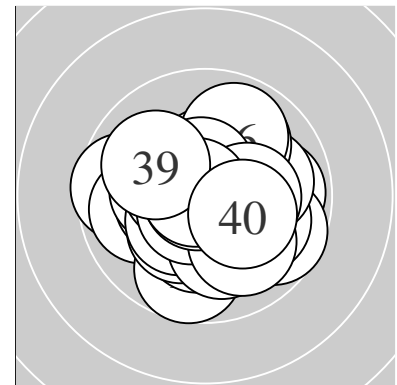

Serie 1:  
 10.4 \*                      10.4 \*                      10.4 \*                      10.1 →                      9.9 →  
 10.6 \*                      9.7 ↘                      10.8 \*                      10.7 \*                      10.0 ↘  
 beste Teiler 50.0 (8.) 64.6 (9.) 99.3 (6.)  
 Trefferlage 0.88 mm rechts, 0.37 mm tief  
 Streuwert 1.21, horizontal: 1.52, vertikal: 0.78

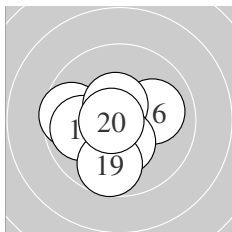

Serie 2:  
 10.3 \*                      9.6 ←                      10.6 \*                      9.9 ←                      10.8 \*  
 10.0 →                      10.5 \*                      10.3 \*                      9.7 ↓                      10.7 \*  
 beste Teiler 44.4 (15.) 57.2 (20.) 88.5 (13.)  
 Trefferlage 0.67 mm links, 0.42 mm tief  
 Streuwert 1.38, horizontal: 1.55, vertikal: 1.18

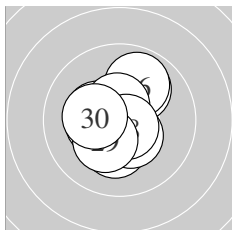

Serie 3:  
 10.2 \*                      10.4 \*                      10.4 \*                      10.3 \*                      10.0 ↗  
 9.9 ↗                      10.5 \*                      10.7 \*                      10.3 \*                      10.3 \*  
 beste Teiler 65.0 (28.) 101.4 (27.) 131.2 (22.)  
 Trefferlage 0.24 mm links, 0.13 mm hoch  
 Streuwert 1.28, horizontal: 1.15, vertikal: 1.40

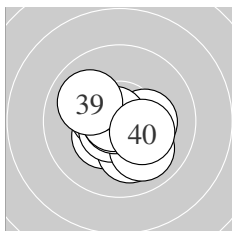

Serie 4:  
 10.4 \*                      10.3 \*                      10.5 \*                      10.1 ↓                      10.6 \*  
 10.0 ↘                      10.8 \*                      10.8 \*                      10.0 ↖                      10.3 \*  
 beste Teiler 31.0 (37.) 41.7 (38.) 82.0 (35.)  
 Trefferlage 0.00 mm , 0.44 mm tief  
 Streuwert 1.17, horizontal: 1.31, vertikal: 1.02

Unterschrift des Schützen

Ergebnis: **372** (391.5)  
 Serien: 87 96 94 95  
 Zähler: 20 14 4 2 0 0 0 0 0 0  
 Innenzehner: 15  
 weiteste: 959 (10), 877 (8), 700 (34)  
 beste Teiler 30.6 (37.) 47.3 (31.) 73.9 (23.)  
 Trefferlage 0.42 mm links, 0.12 mm tief  
 Streuwert 2.56, horizontal: 3.27, vertikal: 1.55

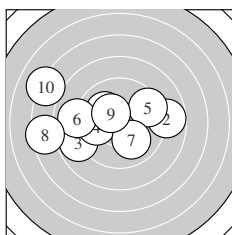
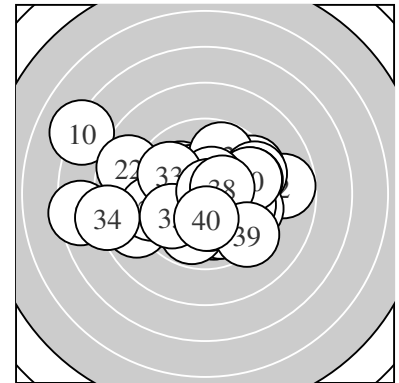

Serie 1:  
 10.1 ↘                      8.8 →                      8.9 ←                      9.9 ←                      9.5 →  
 9.0 ←                      10.0 ↘                      7.4 ←                      10.3 \*                      7.1 ↘  
 beste Teiler 153.1 (9.) 221.6 (1.) 234.4 (7.)  
 Trefferlage 2.22 mm links, 0.40 mm hoch  
 Streuwert 3.61, horizontal: 4.71, vertikal: 1.95

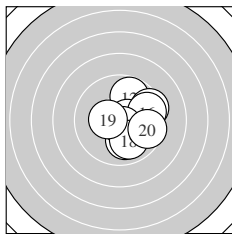

Serie 2:  
 10.5 \*                      9.8 ↗                      10.0 ↓                      10.6 \*                      9.5 →  
 9.6 →                      10.6 \*                      10.0 ↓                      10.4 \*                      9.6 →  
 beste Teiler 76.0 (17.) 91.5 (14.) 115.4 (11.)  
 Trefferlage 1.36 mm rechts, 0.05 mm tief  
 Streuwert 1.55, horizontal: 1.51, vertikal: 1.59

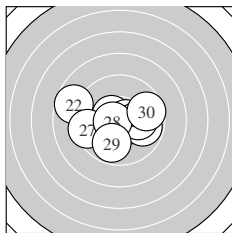

Serie 3:  
 10.5 \*                      8.7 ↖                      10.7 \*                      10.5 \*                      9.8 →  
 10.1 →                      9.4 ←                      10.6 \*                      9.8 ↓                      9.6 →  
 beste Teiler 73.9 (23.) 82.3 (28.) 101.2 (24.)  
 Trefferlage 0.21 mm links, 0.15 mm tief  
 Streuwert 2.11, horizontal: 2.73, vertikal: 1.22

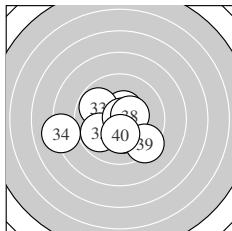

Serie 4:  
 10.8 \*                      10.5 \*                      9.8 ↖                      8.2 ←                      9.8 ←  
 10.3 \*                      10.8 \*                      10.4 \*                      9.3 ↘                      10.3 \*  
 beste Teiler 30.6 (37.) 47.3 (31.) 113.3 (32.)  
 Trefferlage 0.62 mm links, 0.69 mm tief  
 Streuwert 2.13, horizontal: 2.67, vertikal: 1.40

Unterschrift des Schützen

Meyton Elektronik

Ergebnis:	<b>380</b>	(398.7)
Serien:	93 93 97 97	
Zähler:	22 16 2 0 0 0 0 0 0 0	
Innenzehner:	17	
weiteste:	592 (20), 514 (10), 428 (17)	
beste Teiler	21.5 (23.) 30.8 (8.) 61.6 (30.)	
Trefferlage	0.09 mm rechts, 0.15 mm hoch	
Streuwert	2.00, horizontal: 2.01, vertikal: 2.00	

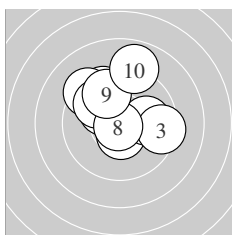
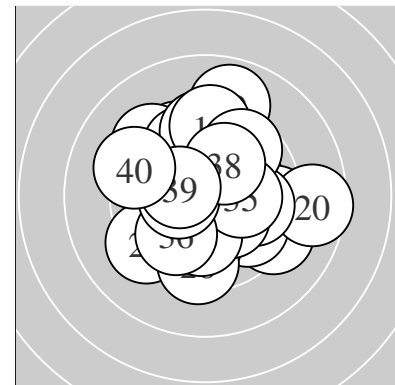

Serie 1:	10.5 *	10.0 →	9.4 →	9.6 ↖	10.2 *
	9.3 ↘	9.9 ↘	10.8 *	9.8 ↖	8.9 ↑
beste Teiler	30.8 (8.) 108.6 (1.) 185.6 (5.)				
Trefferlage	0.15 mm links, 1.46 mm hoch				
Streuwert	2.03, horizontal: 2.12, vertikal: 1.92				

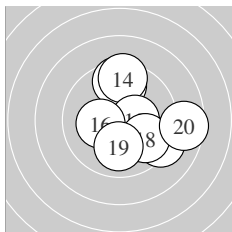

Serie 2:	9.7 ↑	9.5 ↑	10.5 *	9.4 ↑	10.4 *
	10.2 *	9.2 ↘	9.8 ↘	10.0 ↓	8.6 →
beste Teiler	117.6 (13.) 140.0 (15.) 177.9 (16.)				
Trefferlage	1.15 mm rechts, 0.25 mm hoch				
Streuwert	2.33, horizontal: 2.27, vertikal: 2.39				

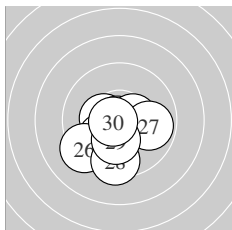

Serie 3:	10.6 *	10.4 *	10.9 *	10.1 ↙	10.5 *
	9.3 ↙	9.9 →	9.5 ↓	10.2 *	10.7 *
beste Teiler	21.5 (23.) 61.6 (30.) 93.4 (21.)				
Trefferlage	0.36 mm links, 1.09 mm tief				
Streuwert	1.46, horizontal: 1.60, vertikal: 1.31				

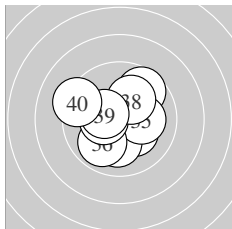

Serie 4:	10.6 *	10.2 *	10.1 ↓	9.7 ↗	10.2 *
	9.9 ↙	10.4 *	10.1 ↗	10.4 *	9.3 ↖
beste Teiler	83.4 (31.) 144.3 (37.) 146.7 (39.)				
Trefferlage	0.27 mm links, 0.01 mm hoch				
Streuwert	1.75, horizontal: 1.89, vertikal: 1.60				

Unterschrift des Schützen

Meyton Elektronik

Ergebnis:	<b>381</b>	(400.0)
Serien:	97 97 95 92	
Zähler:	23 15 2 0 0 0 0 0 0 0	
Innenzehner:	17	
weiteste:	544 (32), 514 (33), 414 (16)	
beste Teiler	23.0 (5.) 42.0 (13.) 43.0 (17.)	
Trefferlage	0.47 mm rechts, 0.68 mm hoch	
Streuwert	1.88, horizontal: 2.30, vertikal: 1.35	

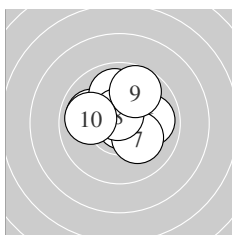
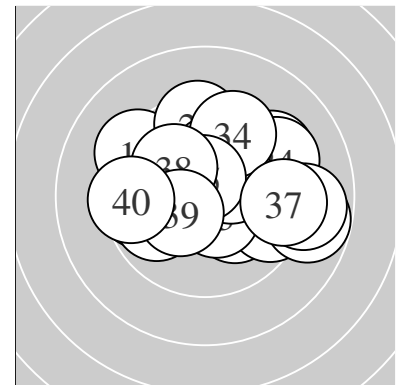

Serie 1:	10.0 ↑	10.0 ←	10.3 *	10.0 ↑	10.9 *
	9.9 →	10.2 *	10.6 *	9.7 ↗	9.9 ←
beste Teiler	23.0 (5.)	76.4 (8.)	172.0 (3.)		
Trefferlage	0.09 mm rechts, 1.01 mm hoch				
Streuwert	1.45, horizontal: 1.60, vertikal: 1.28				

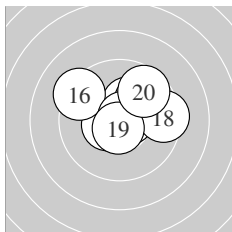

Serie 2:	10.5 *	10.6 *	10.8 *	10.3 *	10.0 ↗
	9.3 ↘	10.8 *	9.4 →	10.7 *	9.7 ↗
beste Teiler	42.0 (13.)	43.0 (17.)	70.0 (19.)		
Trefferlage	0.50 mm rechts, 0.78 mm hoch				
Streuwert	1.58, horizontal: 1.94, vertikal: 1.10				

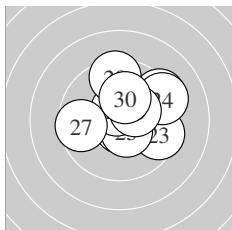

Serie 3:	10.7 *	9.3 ↗	9.5 ↘	9.3 ↗	10.5 *
	10.6 *	9.6 ←	9.5 ↑	10.3 *	10.2 *
beste Teiler	65.4 (21.)	90.5 (26.)	113.2 (25.)		
Trefferlage	0.90 mm rechts, 0.81 mm hoch				
Streuwert	1.92, horizontal: 2.17, vertikal: 1.62				

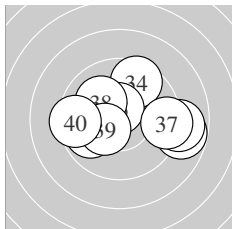

Serie 4:	10.0 ←	8.8 →	8.9 →	9.6 ↗	10.6 *
	9.9 ←	9.3 →	10.1 ↘	10.3 *	9.4 ←
beste Teiler	91.9 (35.)	155.3 (39.)	218.6 (38.)		
Trefferlage	0.40 mm rechts, 0.14 mm hoch				
Streuwert	2.58, horizontal: 3.38, vertikal: 1.38				

Unterschrift des Schützen