

Ergebnis: **392** (412.7)
 Serien: 99 97 99 97
 Zähler: 32 8 0 0 0 0 0 0 0 0
 Innenzehner: 26
 weiteste: 362 (21), 360 (14), 327 (12)
 beste Teiler 19.0 (18.) 21.0 (24.) 25.0 (33.)
 Trefferlage 0.09 mm links, 0.40 mm hoch
 Streuwert 1.29, horizontal: 1.44, vertikal: 1.11

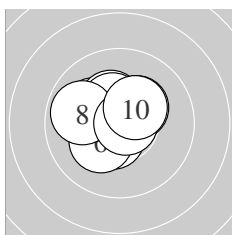

Serie 1:
 10.1 ↘ 10.7 * 10.5 * 10.3 * 10.4 *
 10.2 * 10.3 * 9.9 ← 10.8 * 10.3 *
 beste Teiler 43.0 (9.) 55.2 (2.) 110.0 (3.)
 Trefferlage 0.42 mm links, 0.47 mm hoch
 Streuwert 1.10, horizontal: 1.24, vertikal: 0.94

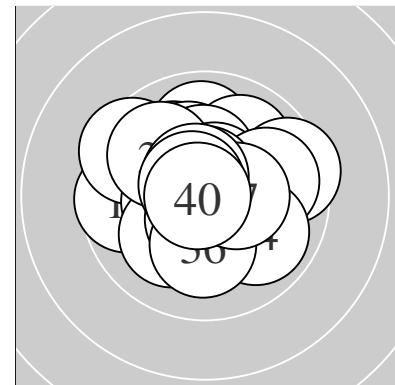
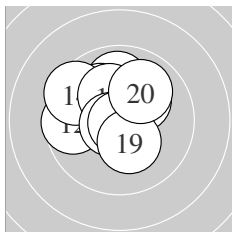

Serie 2:
 9.9 ↑ 9.6 ← 10.1 ↘ 9.5 ↘ 10.2 *
 10.7 * 10.2 * 10.9 * 10.3 * 10.0 ↗
 beste Teiler 19.0 (18.) 66.1 (16.) 165.1 (19.)
 Trefferlage 0.56 mm links, 0.92 mm hoch
 Streuwert 1.50, horizontal: 1.64, vertikal: 1.34

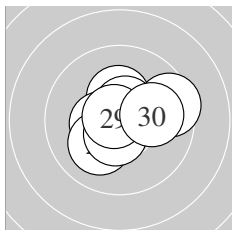

Serie 3:
 9.5 → 10.3 * 10.8 * 10.9 * 10.6 *
 10.4 * 10.1 ↙ 10.5 * 10.8 * 10.0 →
 beste Teiler 21.0 (24.) 36.6 (23.) 46.3 (29.)
 Trefferlage 0.30 mm rechts, 0.12 mm hoch
 Streuwert 1.26, horizontal: 1.50, vertikal: 0.95

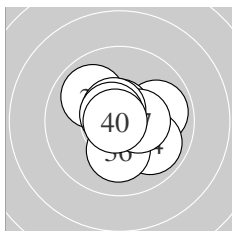

Serie 4:
 9.9 ↘ 9.9 → 10.9 * 9.9 ↘ 10.7 *
 10.1 ↓ 10.4 * 10.6 * 10.7 * 10.8 *
 beste Teiler 25.0 (33.) 32.0 (40.) 71.0 (35.)
 Trefferlage 0.29 mm rechts, 0.07 mm hoch
 Streuwert 1.23, horizontal: 1.34, vertikal: 1.11

Unterschrift des Schützen

Meyton Elektronik

Ergebnis: **385** (403.2)
 Serien: 94 96 97 98
 Zähler: 25 15 0 0 0 0 0 0 0 0
 Innenzehner: 16
 weiteste: 466 (19), 389 (6), 385 (9)
 beste Teiler 25.6 (22.) 32.3 (24.) 56.0 (27.)
 Trefferlage 0.38 mm rechts, 0.37 mm tief
 Streuwert 1.72, horizontal: 2.09, vertikal: 1.23

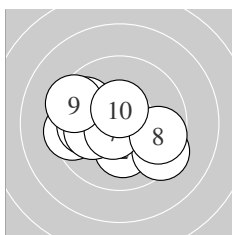
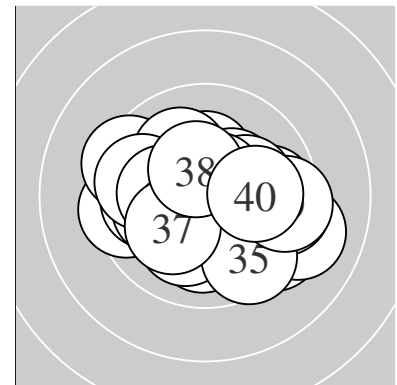

Serie 1:
 9.8 ↙ 10.1 ↓ 9.5 ← 9.9 ← 10.1 ←
 9.4 ↘ 10.6 * 9.7 → 9.4 ↖ 10.5 *
 beste Teiler 77.1 (7.) 112.0 (10.) 201.6 (2.)
 Trefferlage 0.87 mm links, 0.31 mm tief
 Streuwert 2.00, horizontal: 2.51, vertikal: 1.30

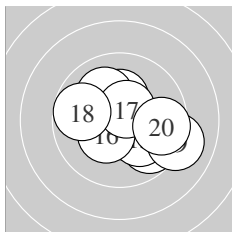

Serie 2:
 10.6 * 9.7 ↘ 10.1 ↘ 10.3 * 10.1 ↖
 10.3 * 10.6 * 9.8 ← 9.1 → 9.6 →
 beste Teiler 100.1 (17.) 100.7 (11.) 151.3 (16.)
 Trefferlage 0.74 mm rechts, 0.23 mm tief
 Streuwert 1.84, horizontal: 2.20, vertikal: 1.40

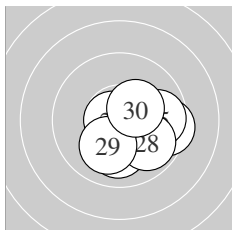

Serie 3:
 10.1 ↓ 10.9 * 9.5 → 10.8 * 9.8 →
 10.0 ↓ 10.7 * 9.9 ↘ 10.1 ↙ 10.3 *
 beste Teiler 25.6 (22.) 32.3 (24.) 56.0 (27.)
 Trefferlage 0.87 mm rechts, 0.79 mm tief
 Streuwert 1.34, horizontal: 1.54, vertikal: 1.10

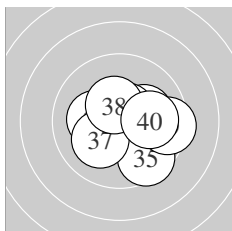

Serie 4:
 10.2 * 10.7 * 10.6 * 10.6 * 9.6 ↘
 10.2 * 10.1 ↙ 10.4 * 9.5 → 10.0 →
 beste Teiler 59.2 (32.) 77.1 (33.) 89.6 (34.)
 Trefferlage 0.80 mm rechts, 0.14 mm tief
 Streuwert 1.50, horizontal: 1.76, vertikal: 1.18

Unterschrift des Schützen

Ergebnis: **394** (414.1)
 Serien: 100 100 96 98
 Zähler: 34 6 0 0 0 0 0 0 0 0
 Innenzehner: 30
 weiteste: 436 (22), 362 (24), 334 (30)
 beste Teiler 21.6 (35.) 24.1 (39.) 35.7 (8.)
 Trefferlage 0.25 mm links, 0.78 mm hoch
 Streuwert 1.12, horizontal: 0.99, vertikal: 1.24

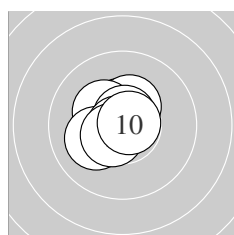
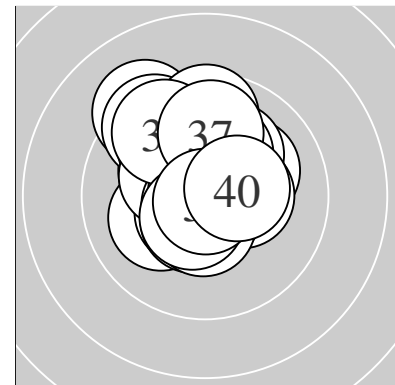

Serie 1:
 10.5 * 10.4 * 10.8 * 10.4 * 10.3 *
 10.7 * 10.1 ↙ 10.8 * 10.5 * 10.8 *
 beste Teiler 35.7 (8.) 38.8 (3.) 47.7 (10.)
 Trefferlage 0.47 mm links, 0.29 mm hoch
 Streuwert 0.77, horizontal: 0.81, vertikal: 0.74

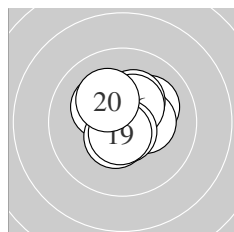

Serie 2:
 10.1 ↗ 10.2 * 10.3 * 10.5 * 10.3 *
 10.4 * 10.7 * 10.5 * 10.6 * 10.2 *
 beste Teiler 66.4 (17.) 79.0 (19.) 114.4 (18.)
 Trefferlage 0.16 mm rechts, 0.51 mm hoch
 Streuwert 1.03, horizontal: 1.05, vertikal: 1.01

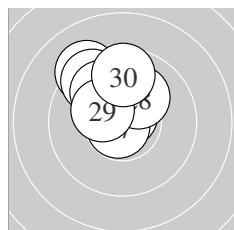

Serie 3:
 10.7 * 9.2 ↘ 10.1 ↑ 9.5 ↘ 9.9 ↘
 10.4 * 10.8 * 10.1 ↗ 10.3 * 9.6 ↑
 beste Teiler 44.5 (27.) 53.6 (21.) 129.0 (26.)
 Trefferlage 0.67 mm links, 1.80 mm hoch
 Streuwert 1.21, horizontal: 1.16, vertikal: 1.26

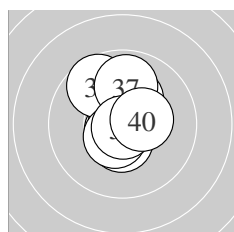

Serie 4:
 10.7 * 10.2 * 10.5 * 10.7 * 10.9 *
 9.7 ↘ 9.9 ↑ 10.5 * 10.9 * 10.4 *
 beste Teiler 21.6 (35.) 24.1 (39.) 60.9 (34.)
 Trefferlage 0.04 mm links, 0.54 mm hoch
 Streuwert 1.14, horizontal: 0.81, vertikal: 1.39

Unterschrift des Schützen

Meyton Elektronik

Ergebnis: **382** (399.8)
 Serien: 92 98 97 95
 Zähler: 25 12 3 0 0 0 0 0 0 0
 Innenzehner: 18
 weiteste: 750 (37), 600 (7), 511 (4)
 beste Teiler 32.3 (10.) 47.1 (25.) 61.8 (39.)
 Trefferlage 0.08 mm rechts, 0.64 mm tief
 Streuwert 1.98, horizontal: 2.24, vertikal: 1.68

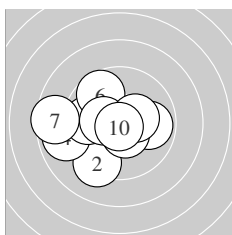
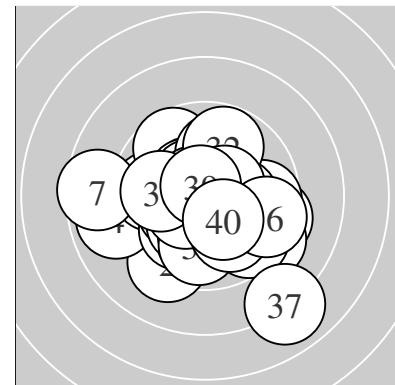

Serie 1:
 9.9 → 9.3 ↙ 10.5 * 8.9 ← 9.8 ←
 9.7 ↘ 8.6 ← 10.4 * 10.3 * 10.8 *
 beste Teiler 32.3 (10.) 112.7 (3.) 149.6 (8.)
 Trefferlage 1.45 mm links, 0.24 mm tief
 Streuwert 2.24, horizontal: 2.73, vertikal: 1.60

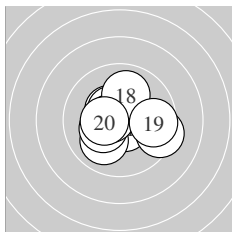

Serie 2:
 10.6 * 10.0 ↙ 10.3 * 10.4 * 10.5 *
 9.4 → 10.6 * 10.0 ↑ 9.7 → 10.4 *
 beste Teiler 83.6 (11.) 85.5 (17.) 119.3 (15.)
 Trefferlage 0.10 mm rechts, 0.04 mm tief
 Streuwert 1.61, horizontal: 1.92, vertikal: 1.22

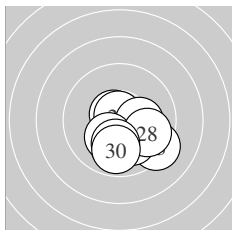

Serie 3:
 10.0 ↓ 10.6 * 9.3 ↘ 10.0 ↘ 10.8 *
 10.2 * 10.2 * 9.8 ↘ 10.1 ↓ 9.9 ↓
 beste Teiler 47.1 (25.) 78.5 (22.) 184.4 (26.)
 Trefferlage 0.60 mm rechts, 1.35 mm tief
 Streuwert 1.39, horizontal: 1.53, vertikal: 1.23

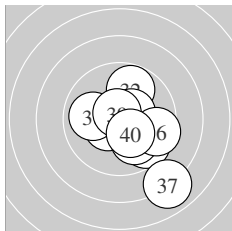

Serie 4:
 10.4 * 9.8 ↑ 10.5 * 9.6 ↘ 10.0 ↘
 9.5 → 8.0 ↘ 10.0 ← 10.7 * 10.3 *
 beste Teiler 61.8 (39.) 122.5 (33.) 128.7 (31.)
 Trefferlage 1.10 mm rechts, 0.94 mm tief
 Streuwert 2.19, horizontal: 2.05, vertikal: 2.33

Unterschrift des Schützen

Meyton Elektronik

Ergebnis: **381** (399.6)
 Serien: 98 93 97 93
 Zähler: 22 17 1 0 0 0 0 0 0 0
 Innenzehner: 13
 weiteste: 596 (13), 493 (27), 420 (20)
 beste Teiler 7.2 (8.) 28.2 (14.) 33.2 (9.)
 Trefferlage 0.13 mm rechts, 0.05 mm tief
 Streuwert 1.94, horizontal: 2.26, vertikal: 1.55

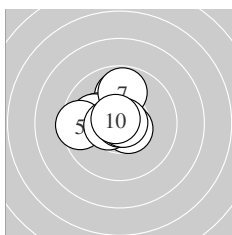
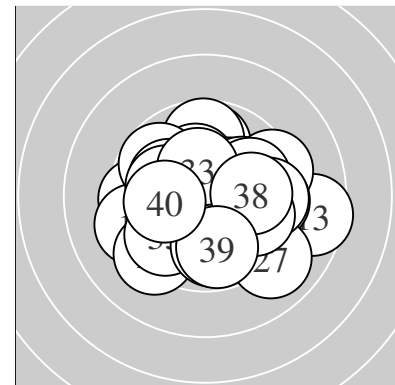

Serie 1:
 10.0 ↑ 10.6 * 10.2 * 10.0 ← 9.5 ←
 10.5 * 9.8 ↑ 10.9 * 10.8 * 10.7 *
 beste Teiler 7.2 (8.) 33.2 (9.) 53.0 (10.)
 Trefferlage 0.78 mm links, 0.58 mm hoch
 Streuwert 1.28, horizontal: 1.41, vertikal: 1.14

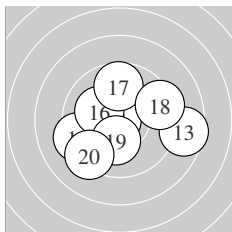

Serie 2:
 9.9 ↙ 10.6 * 8.6 → 10.8 * 9.3 ←
 10.1 ↖ 9.7 ↑ 9.4 → 10.2 * 9.3 ↘
 beste Teiler 28.2 (14.) 100.6 (12.) 187.9 (19.)
 Trefferlage 0.24 mm links, 0.27 mm tief
 Streuwert 2.46, horizontal: 2.96, vertikal: 1.84

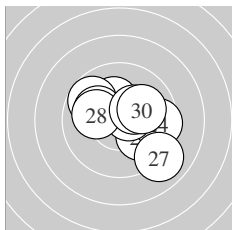

Serie 3:
 10.2 * 10.0 ↘ 9.7 ↖ 9.5 → 10.1 ↖
 10.6 * 9.0 ↘ 10.1 ← 10.3 * 10.1 →
 beste Teiler 90.0 (26.) 162.4 (29.) 179.6 (21.)
 Trefferlage 0.60 mm rechts, 0.21 mm hoch
 Streuwert 1.95, horizontal: 2.27, vertikal: 1.57

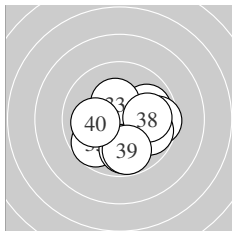

Serie 4:
 10.1 → 9.9 → 10.3 * 9.6 → 9.7 ↙
 9.8 → 9.9 ↓ 9.9 → 9.8 ↓ 10.1 ←
 beste Teiler 153.3 (33.) 218.2 (31.) 224.1 (40.)
 Trefferlage 0.94 mm rechts, 0.72 mm tief
 Streuwert 1.78, horizontal: 2.04, vertikal: 1.47

Unterschrift des Schützen

Meyton Elektronik

Ergebnis: **378** (394.1)
 Serien: 93 94 97 94
 Zähler: 21 16 3 0 0 0 0 0 0 0
 Innenzehner: 15
 weiteste: 731 (19), 598 (11), 574 (1)
 beste Teiler 41.1 (35.) 82.7 (17.) 89.6 (16.)
 Trefferlage 0.48 mm links, 0.22 mm hoch
 Streuwert 2.23, horizontal: 2.59, vertikal: 1.80

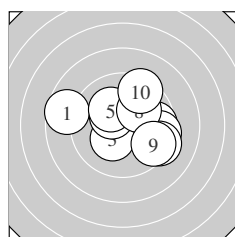
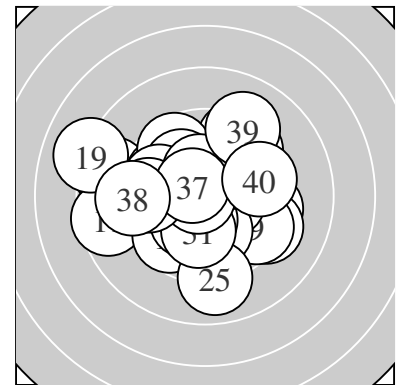

Serie 1:
 8.7 ← 9.7 → 10.3 * 10.4 * 10.2 *
 9.5 → 9.3 ↘ 10.1 ↗ 9.5 ↘ 9.4 ↗
 beste Teiler 138.0 (4.) 167.8 (3.) 196.4 (5.)
 Trefferlage 0.82 mm rechts, 0.29 mm hoch
 Streuwert 2.45, horizontal: 3.00, vertikal: 1.74

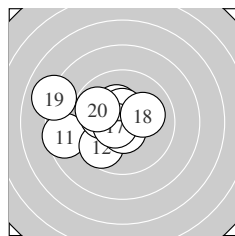

Serie 2:
 8.6 ← 9.7 ↗ 10.3 * 10.1 ← 10.5 *
 10.6 * 10.6 * 10.1 → 8.0 ← 9.8 ↖
 beste Teiler 82.7 (17.) 89.6 (16.) 114.0 (15.)
 Trefferlage 1.86 mm links, 0.27 mm hoch
 Streuwert 2.19, horizontal: 2.72, vertikal: 1.48

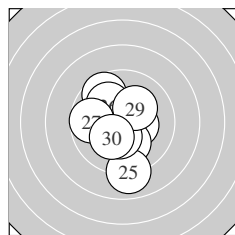

Serie 3:
 10.4 * 9.6 ↖ 10.1 ↓ 10.4 * 9.0 ↓
 10.0 ↖ 9.7 ← 10.4 * 10.2 * 10.2 *
 beste Teiler 142.7 (21.) 147.8 (28.) 148.6 (24.)
 Trefferlage 0.47 mm links, 0.53 mm tief
 Streuwert 1.88, horizontal: 1.46, vertikal: 2.22

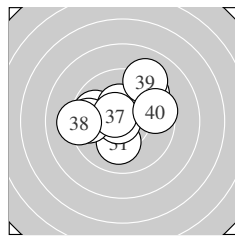

Serie 4:
 10.1 ↓ 9.5 ↗ 9.8 ↖ 10.4 * 10.8 *
 9.6 ← 10.6 * 9.2 ← 9.1 ↗ 9.6 →
 beste Teiler 41.1 (35.) 98.8 (37.) 150.6 (34.)
 Trefferlage 0.44 mm links, 0.84 mm hoch
 Streuwert 2.16, horizontal: 2.56, vertikal: 1.67

Unterschrift des Schützen

Meyton Elektronik

Ergebnis: **389** (409.3)
 Serien: 96 98 97 98
 Zähler: 30 9 1 0 0 0 0 0 0 0
 Innenzehner: 29
 weiteste: 749 (6), 350 (38), 337 (35)
 beste Teiler 32.7 (19.) 42.9 (9.) 49.2 (30.)
 Trefferlage 0.49 mm rechts, 0.38 mm hoch
 Streuwert 1.53, horizontal: 1.89, vertikal: 1.06

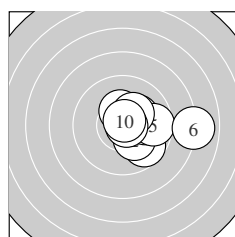
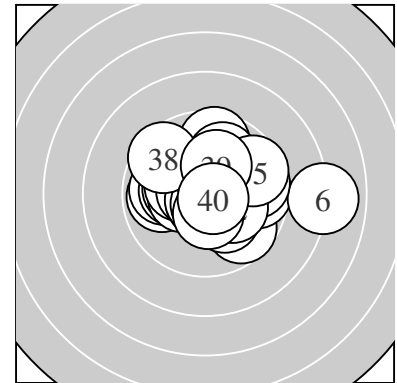

Serie 1:
 9.7 ↘ 10.2 * 10.0 → 10.2 * 9.7 →
 8.0 → 10.3 * 10.3 * 10.8 * 10.8 *
 beste Teiler 42.9 (9.) 49.7 (10.) 151.2 (7.)
 Trefferlage 1.96 mm rechts, 0.03 mm hoch
 Streuwert 1.77, horizontal: 2.22, vertikal: 1.15

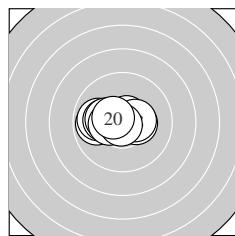

Serie 2:
 10.4 * 9.9 ← 9.9 ← 10.2 * 10.7 *
 10.3 * 10.4 * 10.4 * 10.8 * 10.5 *
 beste Teiler 32.7 (19.) 68.6 (15.) 110.4 (20.)
 Trefferlage 0.83 mm links, 0.12 mm hoch
 Streuwert 1.10, horizontal: 1.52, vertikal: 0.30

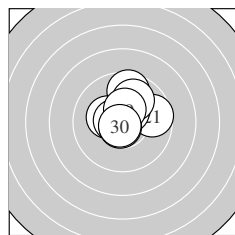

Serie 3:
 9.7 → 10.6 * 10.3 * 10.5 * 10.6 *
 10.7 * 9.6 ↑ 9.9 ↑ 10.4 * 10.8 *
 beste Teiler 49.2 (30.) 56.7 (26.) 86.8 (25.)
 Trefferlage 0.22 mm rechts, 0.93 mm hoch
 Streuwert 1.23, horizontal: 1.29, vertikal: 1.16

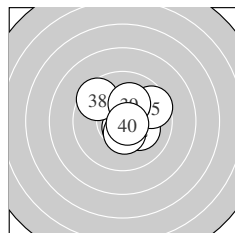

Serie 4:
 10.4 * 10.2 * 10.4 * 10.7 * 9.6 →
 10.5 * 10.4 * 9.6 ↘ 10.2 * 10.7 *
 beste Teiler 59.1 (40.) 65.2 (34.) 114.4 (36.)
 Trefferlage 0.62 mm rechts, 0.43 mm hoch
 Streuwert 1.35, horizontal: 1.45, vertikal: 1.25

Unterschrift des Schützen

Meyton Elektronik

Ergebnis:	366	(384.8)
Serien:	91 88 94 93	
Zähler:	14 20 4 2 0 0 0 0 0 0	
Innenzehner:	12	
weiteste:	805 (19), 763 (11), 741 (10)	
beste Teiler	49.9 (15.) 67.9 (2.) 98.0 (28.)	
Trefferlage	0.53 mm rechts, 0.37 mm hoch	
Streuwert	2.69, horizontal: 3.33, vertikal: 1.83	

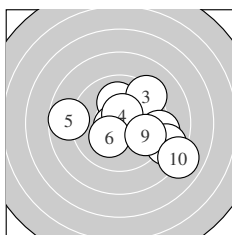
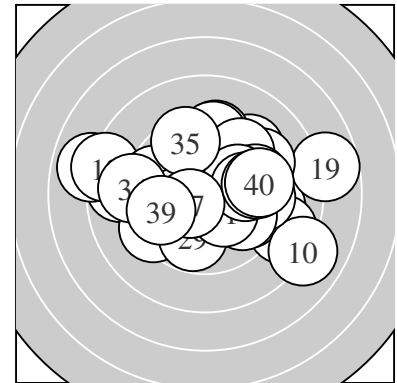

Serie 1:	10.0 ↑	10.7 *	9.3 ↗	10.5 *	8.7 ←
	10.2 *	9.2 →	8.7 ↘	9.7 →	8.0 ↘
beste Teiler	67.9 (2.)	101.2 (4.)	184.2 (6.)		
Trefferlage	1.43 mm rechts, 0.33 mm tief				
Streuwert	2.90, horizontal: 3.55, vertikal: 2.05				

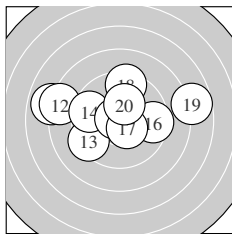

Serie 2:	7.9 ←	8.3 ←	9.3 ↖	9.6 ←	10.8 *
	9.5 →	10.5 *	9.4 ↑	7.7 →	10.2 *
beste Teiler	49.9 (15.)	117.4 (17.)	180.6 (20.)		
Trefferlage	0.75 mm links, 0.86 mm hoch				
Streuwert	3.47, horizontal: 4.60, vertikal: 1.71				

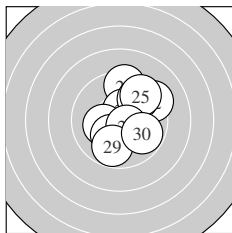

Serie 3:	9.4 ↑	9.3 ↗	10.5 *	9.7 ↗	9.5 ↗
	10.2 *	10.2 *	10.6 *	9.8 ↓	9.8 ↘
beste Teiler	98.0 (28.)	121.1 (23.)	183.8 (26.)		
Trefferlage	0.85 mm rechts, 0.49 mm hoch				
Streuwert	1.97, horizontal: 1.72, vertikal: 2.19				

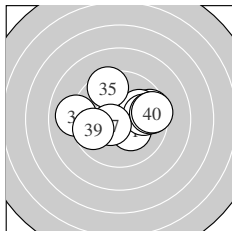

Serie 4:	10.3 *	9.6 →	10.0 ↗	9.0 ←	9.5 ↖
	9.9 →	10.5 *	9.6 →	9.7 ←	9.5 →
beste Teiler	116.5 (37.)	171.1 (31.)	235.3 (33.)		
Trefferlage	0.62 mm rechts, 0.47 mm hoch				
Streuwert	2.27, horizontal: 2.92, vertikal: 1.33				

Unterschrift des Schützen