

Ergebnis: **588.9** (561)
 Serien: 96.3 97.7 94.9 99.5 101.7 98.8
 Zähler: 26 30 3 1 0 0 0 0 0 0
 Innenzehner: 15
 weiteste: 777 (13), 728 (30), 675 (27)
 beste Teiler 55.0 (59.) 66.7 (24.) 67.5 (20.)
 Trefferlage 0.26 mm rechts, 0.31 mm hoch
 Streuwert 2.28, horizontal: 2.60, vertikal: 1.90

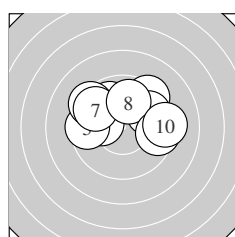

Serie 1:
 9.4 ↗ 9.9 ↘ 10.1 ← 9.8 ↗ 9.5 ←
 9.4 ↖ 9.6 ↖ 9.9 ↑ 9.5 → 9.2 →
 beste Teiler 214.2 (3.) 264.1 (8.) 268.9 (2.)
 Trefferlage 0.06 mm rechts, 1.35 mm hoch
 Streuwert 2.30, horizontal: 3.00, vertikal: 1.26

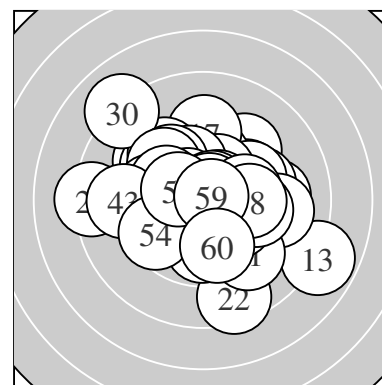
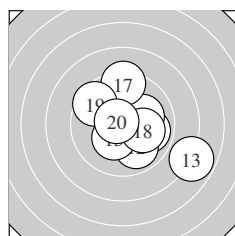

Serie 2:
 9.9 → 9.9 ↘ 7.8 ↘ 10.0 ↑ 10.3 *
 10.1 → 9.3 ↑ 10.1 → 9.6 ↖ 10.7 *
 beste Teiler 67.5 (20.) 161.7 (15.) 210.5 (16.)
 Trefferlage 0.98 mm rechts, 0.10 mm hoch
 Streuwert 2.48, horizontal: 2.68, vertikal: 2.27

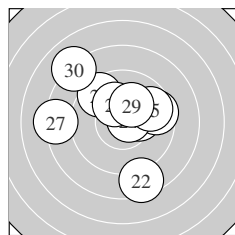

Serie 3:
 10.3 * 8.5 ↓ 9.5 → 10.7 * 9.7 ↗
 9.5 ↖ 8.3 ← 10.2 * 10.2 * 8.0 ↖
 beste Teiler 66.7 (24.) 170.2 (21.) 195.1 (28.)
 Trefferlage 0.35 mm links, 0.86 mm hoch
 Streuwert 3.11, horizontal: 3.36, vertikal: 2.83

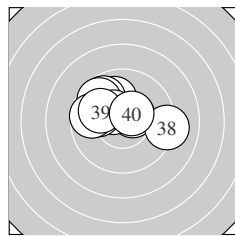

Serie 4:
 10.0 ↑ 10.5 * 9.7 ↖ 9.7 ↖ 10.4 *
 9.9 ← 9.7 ← 9.1 → 10.0 ↖ 10.5 *
 beste Teiler 116.3 (32.) 119.2 (40.) 128.7 (35.)
 Trefferlage 0.74 mm links, 1.04 mm hoch
 Streuwert 1.76, horizontal: 2.30, vertikal: 0.93

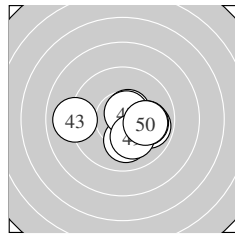

Serie 5:
 9.9 → 10.7 * 9.0 ← 10.6 * 10.6 *
 10.1 ↓ 10.7 * 10.0 → 10.1 ↓ 10.0 →
 beste Teiler 68.0 (42.) 70.7 (47.) 84.1 (44.)
 Trefferlage 0.62 mm rechts, 0.37 mm tief
 Streuwert 1.63, horizontal: 2.10, vertikal: 0.96

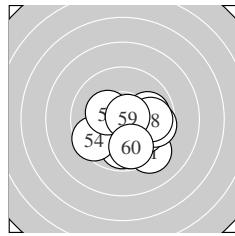

Serie 6:
 9.3 ↘ 10.0 ↘ 9.8 ↓ 9.6 ↖ 10.3 *
 9.9 → 9.6 → 9.8 → 10.7 * 9.8 ↓
 beste Teiler 55.0 (59.) 164.0 (55.) 240.8 (52.)
 Trefferlage 1.02 mm rechts, 1.13 mm tief
 Streuwert 1.77, horizontal: 2.03, vertikal: 1.48

Meyton Elektronik

ISSF AR Men – Wertung – **Männer**

StandNr: 101

Grün, Günther #138

StartNr: 47

20. Januar 2020 11:50

Steiermark

Unterschrift des Schützen

Meyton Elektronik

Ergebnis: **625.9** (593)
 Serien: 104.8 103.3 103.5 105.1 105.4 103.8
 Zähler: 53 7 0 0 0 0 0 0 0
 Innenzehner: 50
 weiteste: 300 (5), 278 (59), 276 (18)
 beste Teiler 16.1 (47.) 28.2 (1.) 35.4 (38.)
 Trefferlage 0.32 mm rechts, 0.03 mm tief
 Streuwert 1.04, horizontal: 0.99, vertikal: 1.08

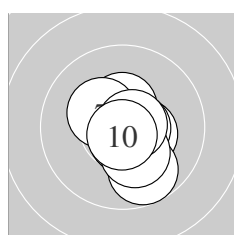
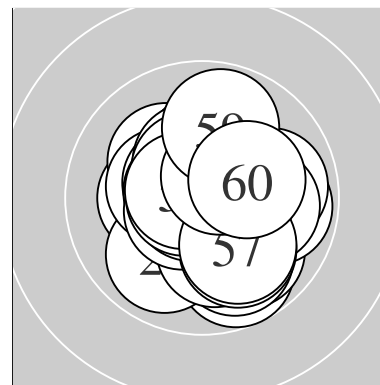

Serie 1:
 10.8 * 10.5 * 10.4 * 10.6 * 9.8 ↘
 10.7 * 10.3 * 10.2 * 10.7 * 10.8 *
 beste Teiler 28.2 (1.) 49.1 (10.) 62.8 (9.)
 Trefferlage 0.36 mm rechts, 0.39 mm tief
 Streuwert 0.98, horizontal: 0.78, vertikal: 1.15

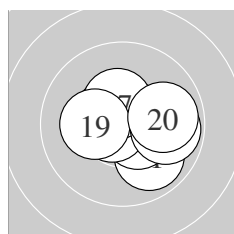

Serie 2:
 9.9 ↘ 10.5 * 10.8 * 10.6 * 10.5 *
 10.7 * 10.4 * 9.8 → 10.2 * 9.9 →
 beste Teiler 48.5 (13.) 68.4 (16.) 76.8 (14.)
 Trefferlage 0.55 mm rechts, 0.01 mm tief
 Streuwert 1.23, horizontal: 1.49, vertikal: 0.89

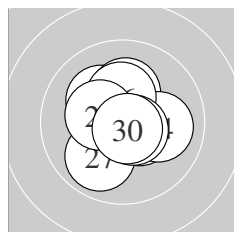

Serie 3:
 10.5 * 10.2 * 10.2 * 10.0 → 10.7 *
 10.3 * 9.9 ↙ 10.6 * 10.4 * 10.7 *
 beste Teiler 51.6 (30.) 67.6 (25.) 84.2 (28.)
 Trefferlage 0.06 mm rechts, 0.09 mm hoch
 Streuwert 1.22, horizontal: 1.21, vertikal: 1.23

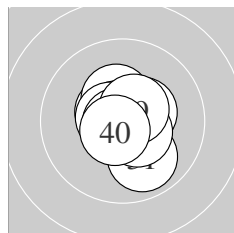

Serie 4:
 9.9 ↘ 10.4 * 10.6 * 10.4 * 10.5 *
 10.8 * 10.6 * 10.8 * 10.5 * 10.6 *
 beste Teiler 35.4 (38.) 47.3 (36.) 76.6 (40.)
 Trefferlage 0.10 mm rechts, 0.01 mm hoch
 Streuwert 0.93, horizontal: 0.84, vertikal: 1.02

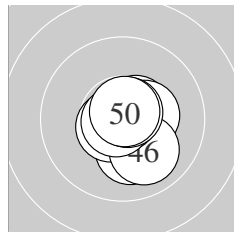

Serie 5:
 10.4 * 10.2 * 10.6 * 10.6 * 10.4 *
 10.0 ↘ 10.9 * 10.8 * 10.7 * 10.8 *
 beste Teiler 16.1 (47.) 44.3 (48.) 49.7 (50.)
 Trefferlage 0.36 mm rechts, 0.40 mm tief
 Streuwert 0.85, horizontal: 0.70, vertikal: 0.99

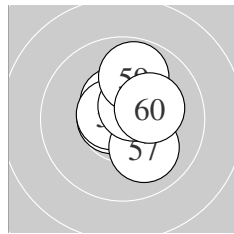

Serie 6:
 10.7 * 10.5 * 10.6 * 10.4 * 10.5 *
 10.6 * 10.0 ↘ 10.5 * 9.8 ↑ 10.2 *
 beste Teiler 67.0 (51.) 76.6 (56.) 93.0 (53.)
 Trefferlage 0.49 mm rechts, 0.48 mm hoch
 Streuwert 1.04, horizontal: 0.86, vertikal: 1.19

Meyton Elektronik

ISSF AR Men – Wertung – Männer

StandNr: 102

Hoberg, Alex #305

StartNr: 48

20. Januar 2020 11:26

AUS

Unterschrift des Schützen

Meyton Elektronik

Ergebnis:	607.6	(581)
Serien:	98.7	100.2 101.1 102.3 102.4 102.9
Zähler:	42 17 1 0 0 0 0 0 0	
Innenzehner:	33	
weiteste:	533 (8), 464 (44), 445 (19)	
beste Teiler	22.8 (1.) 45.6 (55.) 46.3 (42.)	
Trefferlage	0.05 mm rechts, 0.08 mm hoch	
Streuwert	1.69, horizontal: 1.78, vertikal: 1.60	

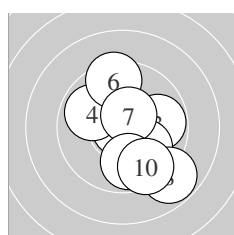
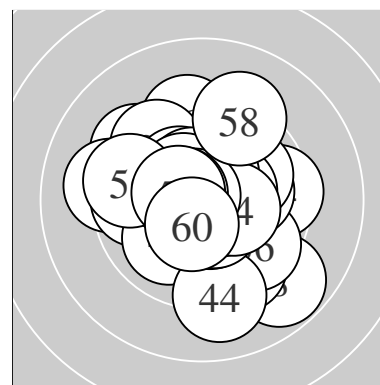

Serie 1:	10.9 *	10.1 ↖	9.8 →	9.9 ↙	10.0 ↘
	9.4 ↑	10.5 *	8.8 ↘	9.8 ↓	9.5 ↘
beste Teiler	22.8 (1.)	107.7 (7.)	212.0 (2.)		
Trefferlage	0.68 mm rechts, 0.32 mm tief				
Streuwert	2.17, horizontal: 1.85, vertikal: 2.45				

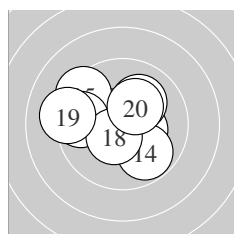

Serie 2:	10.5 *	10.4 *	10.4 *	9.8 ↘	9.4 ↖
	10.1 ↗	9.6 ←	10.5 *	9.2 ←	10.3 *
beste Teiler	120.1 (18.)	123.8 (11.)	144.2 (12.)		
Trefferlage	0.63 mm links, 0.29 mm hoch				
Streuwert	1.89, horizontal: 2.30, vertikal: 1.38				

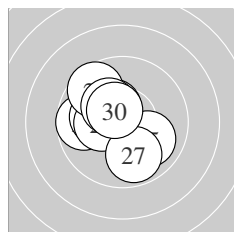

Serie 3:	10.4 *	9.7 ←	10.1 ←	10.3 *	10.0 ↘
	10.3 *	9.9 ↓	9.6 ↖	10.3 *	10.5 *
beste Teiler	113.7 (30.)	142.0 (21.)	156.1 (24.)		
Trefferlage	0.99 mm links, 0.30 mm hoch				
Streuwert	1.47, horizontal: 1.50, vertikal: 1.44				

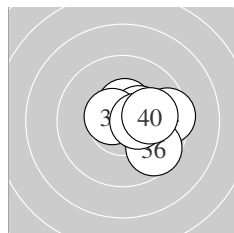

Serie 4:	10.3 *	10.7 *	10.1 →	9.5 →	10.5 *
	9.6 ↘	10.4 *	10.6 *	10.5 *	10.1 →
beste Teiler	72.0 (32.)	90.4 (38.)	116.2 (35.)		
Trefferlage	1.38 mm rechts, 0.12 mm hoch				
Streuwert	1.13, horizontal: 1.32, vertikal: 0.89				

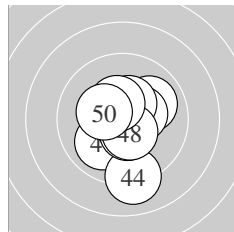

Serie 5:	10.0 ↗	10.8 *	10.0 ↗	9.1 ↓	10.4 *
	10.4 *	10.5 *	10.5 *	10.4 *	10.3 *
beste Teiler	46.3 (42.)	113.5 (47.)	117.7 (48.)		
Trefferlage	0.23 mm rechts, 0.43 mm tief				
Streuwert	1.53, horizontal: 1.16, vertikal: 1.82				

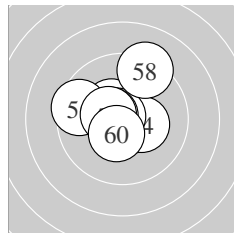

Serie 6:	10.7 *	10.4 *	10.6 *	10.3 *	10.8 *
	9.5 ←	10.5 *	9.2 ↑	10.5 *	10.4 *
beste Teiler	45.6 (55.)	63.0 (51.)	93.2 (53.)		
Trefferlage	0.33 mm links, 0.52 mm hoch				
Streuwert	1.44, horizontal: 1.51, vertikal: 1.36				

Meyton Elektronik

ISSF AR Men – Wertung – Männer

StandNr: 103

Heidegger, Daniel #140

StartNr: 49

20. Januar 2020 11:47

WSV Wien

Unterschrift des Schützen

Meyton Elektronik

Ergebnis: **612.2** (583)
 Serien: 100.4 102.2 104.6 101.2 100.4 103.4
 Zähler: 44 15 1 0 0 0 0 0 0
 Innenzehner: 40
 weiteste: 551 (48), 400 (49), 382 (8)
 beste Teiler 18.2 (28.) 32.7 (30.) 56.4 (21.)
 Trefferlage 0.16 mm rechts, 0.23 mm tief
 Streuwert 1.49, horizontal: 1.72, vertikal: 1.22

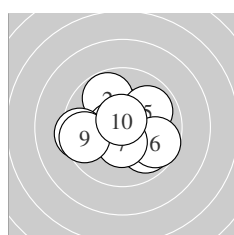
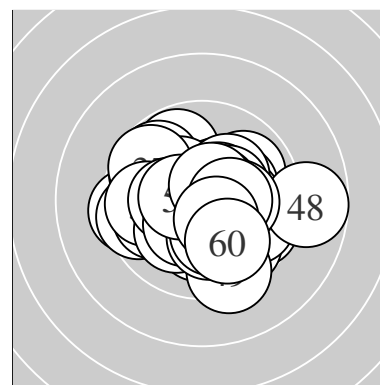

Serie 1:
 10.4 * 9.8 ↖ 10.6 * 9.9 ↘ 9.9 ↗
 9.7 ↗ 10.4 * 9.4 ← 9.6 ← 10.7 *
 beste Teiler 65.9 (10.) 86.0 (3.) 128.6 (1.)
 Trefferlage 0.25 mm links, 0.00 mm
 Streuwert 1.87, horizontal: 2.22, vertikal: 1.43

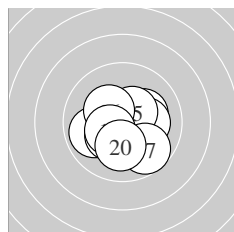

Serie 2:
 10.2 * 10.6 * 9.9 ← 10.2 * 10.5 *
 10.3 * 9.7 ↘ 10.3 * 10.4 * 10.1 ↓
 beste Teiler 97.8 (12.) 124.5 (15.) 132.8 (19.)
 Trefferlage 0.03 mm rechts, 0.55 mm tief
 Streuwert 1.38, horizontal: 1.56, vertikal: 1.19

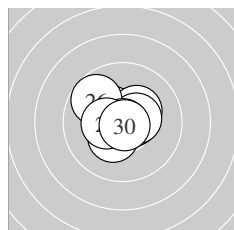

Serie 3:
 10.7 * 10.4 * 10.3 * 10.6 * 10.5 *
 9.7 ↖ 10.3 * 10.9 * 10.4 * 10.8 *
 beste Teiler 18.2 (28.) 32.7 (30.) 56.4 (21.)
 Trefferlage 0.15 mm links, 0.26 mm hoch
 Streuwert 1.05, horizontal: 1.19, vertikal: 0.88

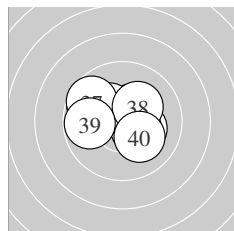

Serie 4:
 10.4 * 10.2 * 10.4 * 10.4 * 9.7 ↖
 10.3 * 9.7 ↖ 10.2 * 9.8 ← 10.1 ↘
 beste Teiler 128.0 (33.) 138.0 (34.) 149.0 (31.)
 Trefferlage 0.16 mm links, 0.29 mm hoch
 Streuwert 1.60, horizontal: 1.96, vertikal: 1.11

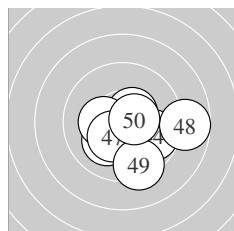

Serie 5:
 10.4 * 10.5 * 10.4 * 9.8 ↗ 10.1 ↖
 10.3 * 10.3 * 8.7 → 9.4 ↓ 10.5 *
 beste Teiler 105.7 (50.) 116.0 (42.) 130.2 (43.)
 Trefferlage 0.77 mm rechts, 0.92 mm tief
 Streuwert 1.77, horizontal: 2.16, vertikal: 1.27

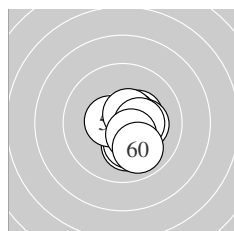

Serie 6:
 10.1 ↓ 10.4 * 10.2 * 10.6 * 10.2 *
 10.5 * 10.6 * 10.4 * 10.5 * 9.9 ↘
 beste Teiler 92.1 (57.) 96.5 (54.) 113.9 (56.)
 Trefferlage 0.77 mm rechts, 0.49 mm tief
 Streuwert 1.00, horizontal: 0.83, vertikal: 1.14

Meyton Elektronik

ISSF AR Men – Wertung – Männer

StandNr: 104

Schwarzer, Dominik #445

StartNr: 50

20. Januar 2020 11:18

GER

Unterschrift des Schützen

Meyton Elektronik

Ergebnis: **624.1** (594)
 Serien: 103.6 103.9 105.0 104.1 102.9 104.6
 Zähler: 54 6 0 0 0 0 0 0 0
 Innenzehner: 49
 weiteste: 291 (17), 281 (35), 280 (21)
 beste Teiler 12.1 (28.) 22.4 (22.) 45.1 (19.)
 Trefferlage 0.17 mm rechts, 0.00 mm
 Streuwert 1.09, horizontal: 1.04, vertikal: 1.14

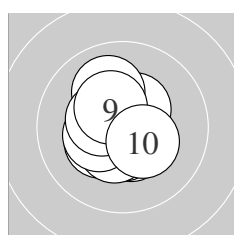
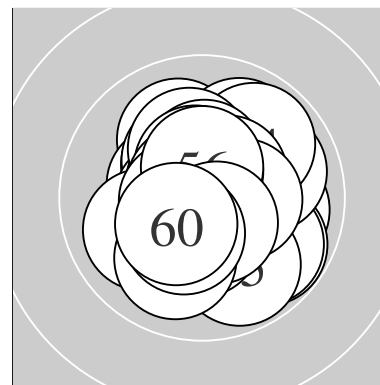

Serie 1:
 10.5 * 10.3 * 10.5 * 10.4 * 10.4 *
 10.0 ↖ 10.4 * 10.4 * 10.4 * 10.3 *
 beste Teiler 105.1 (3.) 120.3 (1.) 127.2 (5.)
 Trefferlage 0.36 mm links, 0.06 mm tief
 Streuwert 1.08, horizontal: 0.94, vertikal: 1.19

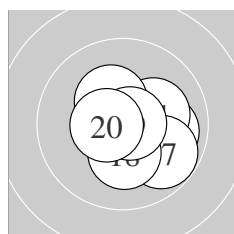

Serie 2:
 10.0 → 10.6 * 10.7 * 10.2 * 10.6 *
 10.3 * 9.8 ↘ 10.3 * 10.8 * 10.6 *
 beste Teiler 45.1 (19.) 63.0 (13.) 80.7 (15.)
 Trefferlage 0.67 mm rechts, 0.24 mm tief
 Streuwert 1.10, horizontal: 1.20, vertikal: 0.99

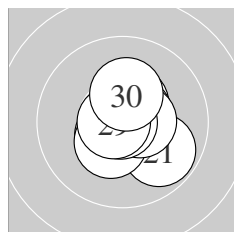

Serie 3:
 9.8 ↘ 10.9 * 10.5 * 10.4 * 10.6 *
 10.4 * 10.5 * 10.9 * 10.7 * 10.3 *
 beste Teiler 12.1 (28.) 22.4 (22.) 54.0 (29.)
 Trefferlage 0.30 mm rechts, 0.02 mm tief
 Streuwert 0.97, horizontal: 0.92, vertikal: 1.02

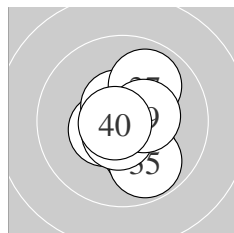

Serie 4:
 10.5 * 10.7 * 10.7 * 10.1 ↘ 9.8 ↘
 10.6 * 9.9 ↗ 10.6 * 10.4 * 10.8 *
 beste Teiler 48.7 (40.) 57.4 (33.) 61.5 (32.)
 Trefferlage 0.38 mm rechts, 0.15 mm tief
 Streuwert 1.13, horizontal: 0.88, vertikal: 1.33

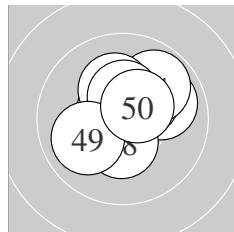

Serie 5:
 10.6 * 9.9 → 10.3 * 9.9 ↗ 10.7 *
 10.2 * 10.4 * 10.4 * 10.0 ↙ 10.5 *
 beste Teiler 72.4 (45.) 98.8 (41.) 119.7 (50.)
 Trefferlage 0.27 mm rechts, 0.68 mm hoch
 Streuwert 1.24, horizontal: 1.34, vertikal: 1.14

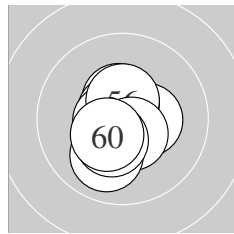

Serie 6:
 10.4 * 10.5 * 10.7 * 10.6 * 10.6 *
 10.5 * 10.5 * 10.0 ↓ 10.4 * 10.4 *
 beste Teiler 69.5 (53.) 81.7 (55.) 97.0 (54.)
 Trefferlage 0.22 mm links, 0.18 mm tief
 Streuwert 0.97, horizontal: 0.76, vertikal: 1.14

Meyton Elektronik

ISSF AR Men – Wertung – **Männer**

StandNr: 105

Mathis, Thomas #39

StartNr: 51

20. Januar 2020 11:31

AUT

Unterschrift des Schützen

Meyton Elektronik

Ergebnis:	623.5	(596)							
Serien:	104.6	105.1	102.2	104.5	102.9	104.2			
Zähler:	56	4	0	0	0	0	0	0	0
Innenzehner:	49								
weiteste:	385 (43),	333 (28),	326 (29)						
beste Teiler	9.0 (5.)	9.8 (50.)	47.0 (20.)						
Trefferlage	0.17 mm links, 0.00 mm								
Streuwert	1.13, horizontal: 1.14, vertikal: 1.11								

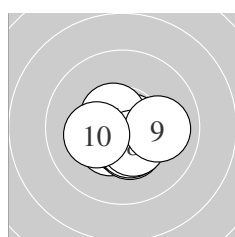
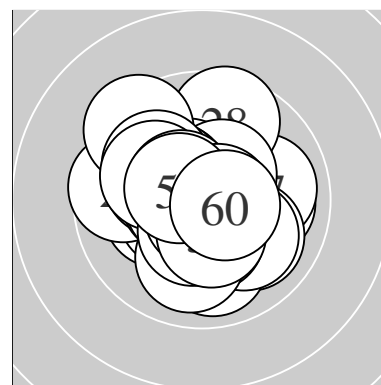

Serie 1:

10.4 *	10.6 *	10.7 *	10.4 *	10.9 *
10.6 *	10.4 *	10.4 *	10.0 →	10.2 *
beste Teiler	9.0 (5.)	56.0 (3.)	98.3 (2.)	
Trefferlage	0.14 mm rechts, 0.56 mm tief			
Streuwert	0.92, horizontal: 1.10, vertikal: 0.68			

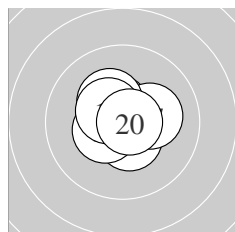

Serie 2:

10.7 *	10.5 *	10.7 *	10.4 *	10.5 *
10.5 *	10.2 *	10.3 *	10.5 *	10.8 *
beste Teiler	47.0 (20.)	59.4 (11.)	67.2 (13.)	
Trefferlage	0.20 mm links, 0.37 mm hoch			
Streuwert	0.82, horizontal: 0.90, vertikal: 0.74			

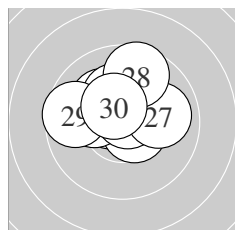

Serie 3:

10.2 *	10.6 *	10.6 *	10.2 *	10.2 *
10.7 *	10.0 →	9.6 ↑	9.6 ←	10.5 *
beste Teiler	55.4 (26.)	87.2 (22.)	95.4 (23.)	
Trefferlage	0.38 mm links, 0.92 mm hoch			
Streuwert	1.34, horizontal: 1.60, vertikal: 1.01			

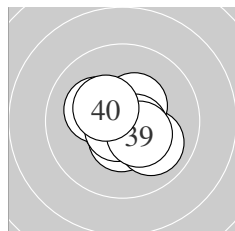

Serie 4:

10.7 *	10.5 *	10.2 *	10.6 *	10.0 ↘
10.4 *	10.6 *	10.7 *	10.4 *	10.4 *
beste Teiler	59.2 (31.)	61.0 (38.)	88.6 (34.)	
Trefferlage	0.13 mm rechts, 0.12 mm tief			
Streuwert	1.02, horizontal: 1.12, vertikal: 0.92			

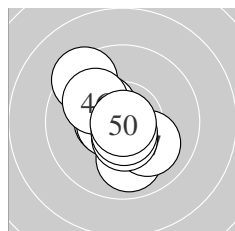

Serie 5:

10.3 *	9.9 ↓	9.4 ↖	10.5 *	10.6 *
10.0 ↖	10.1 ↘	10.5 *	10.7 *	10.9 *
beste Teiler	9.8 (50.)	71.8 (49.)	90.7 (45.)	
Trefferlage	0.52 mm links, 0.06 mm tief			
Streuwert	1.40, horizontal: 1.25, vertikal: 1.53			

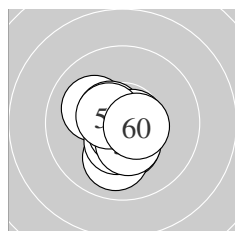

Serie 6:

10.3 *	10.0 ↓	10.1 ↖	10.4 *	10.5 *
10.7 *	10.4 *	10.7 *	10.5 *	10.6 *
beste Teiler	57.2 (56.)	65.1 (58.)	96.5 (60.)	
Trefferlage	0.24 mm links, 0.50 mm tief			
Streuwert	0.97, horizontal: 0.86, vertikal: 1.08			

Meyton Elektronik

ISSF AR Men – Wertung – **Männer**

StandNr: 106

Greuter, Sandro #446

StartNr: 52

20. Januar 2020 11:36

SUI–Sportschützen Sargans

Unterschrift des Schützen

Meyton Elektronik

Ergebnis: **623.8** (594)
 Serien: 103.8 103.5 104.5 104.2 103.2 104.6
 Zähler: 54 6 0 0 0 0 0 0 0 0
 Innenzehner: 46
 weiteste: 365 (11), 304 (50), 303 (21)
 beste Teiler 16.7 (59.) 19.0 (54.) 35.0 (33.)
 Trefferlage 0.38 mm links, 0.18 mm tief
 Streuwert 1.12, horizontal: 1.18, vertikal: 1.05

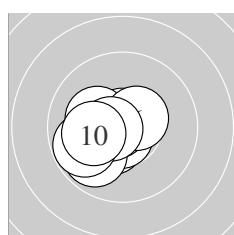
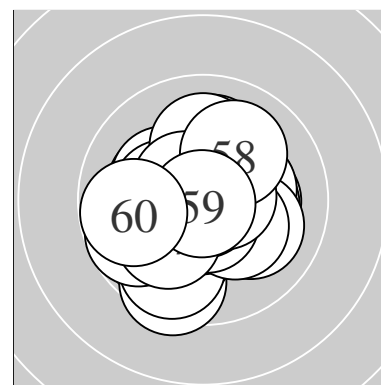

Serie 1:
 10.8 * 10.4 * 10.7 * 10.8 * 10.2 *
 10.5 * 9.9 ↙ 10.6 * 9.8 ↙ 10.1 ←
 beste Teiler 46.3 (4.) 48.1 (1.) 65.1 (3.)
 Trefferlage 0.95 mm links, 0.36 mm tief
 Streuwert 0.99, horizontal: 1.11, vertikal: 0.86

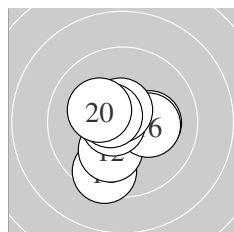

Serie 2:
 9.5 ↓ 10.1 ↓ 10.7 * 10.2 * 10.7 *
 10.2 * 10.7 * 10.6 * 10.6 * 10.2 *
 beste Teiler 54.2 (15.) 59.6 (13.) 67.0 (17.)
 Trefferlage 0.21 mm links, 0.25 mm tief
 Streuwert 1.28, horizontal: 1.18, vertikal: 1.38

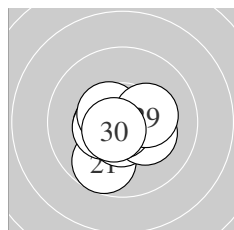

Serie 3:
 9.7 ↓ 10.5 * 10.4 * 10.6 * 10.3 *
 10.8 * 10.8 * 10.5 * 10.3 * 10.6 *
 beste Teiler 35.7 (26.) 40.0 (27.) 81.4 (30.)
 Trefferlage 0.27 mm links, 0.48 mm tief
 Streuwert 1.01, horizontal: 1.09, vertikal: 0.92

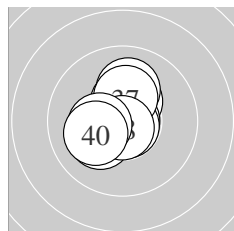

Serie 4:
 10.4 * 10.4 * 10.8 * 10.1 ↑ 10.8 *
 10.2 * 10.3 * 10.8 * 10.3 * 10.1 ←
 beste Teiler 35.0 (33.) 46.0 (35.) 47.1 (38.)
 Trefferlage 0.32 mm links, 0.34 mm hoch
 Streuwert 1.06, horizontal: 0.95, vertikal: 1.16

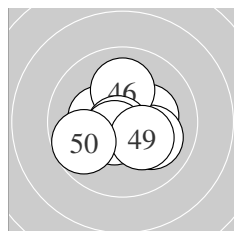

Serie 5:
 10.8 * 10.3 * 10.3 * 10.3 * 10.1 ↘
 10.1 ↑ 10.7 * 10.6 * 10.3 * 9.7 ←
 beste Teiler 48.2 (41.) 53.2 (47.) 94.2 (48.)
 Trefferlage 0.15 mm links, 0.22 mm tief
 Streuwert 1.32, horizontal: 1.54, vertikal: 1.05

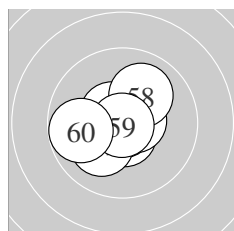

Serie 6:
 10.6 * 10.8 * 10.3 * 10.9 * 10.6 *
 10.6 * 10.1 ↙ 10.0 ↗ 10.9 * 9.8 ←
 beste Teiler 16.7 (59.) 19.0 (54.) 44.7 (52.)
 Trefferlage 0.40 mm links, 0.10 mm tief
 Streuwert 1.11, horizontal: 1.26, vertikal: 0.93

Meyton Elektronik

ISSF AR Men – Wertung – **Männer**
StandNr: 107
Borse, Pratik #447

StartNr: 53
20. Januar 2020 11:43
India

Unterschrift des Schützen

Meyton Elektronik

Ergebnis:	625.5	(595)							
Serien:	104.6	103.4	105.5	103.8	103.6	104.6			
Zähler:	55	5	0	0	0	0	0	0	0
Innenzehner:	52								
weiteste:	331	(50),	314	(13),	287	(12)			
beste Teiler	7.0	(15.)	25.0	(22.)	33.0	(60.)			
Trefferlage	0.13 mm links, 0.17 mm tief								
Streuwert	1.06, horizontal: 0.88, vertikal: 1.21								

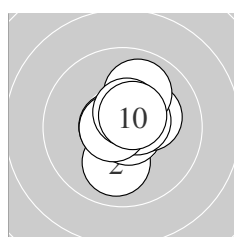
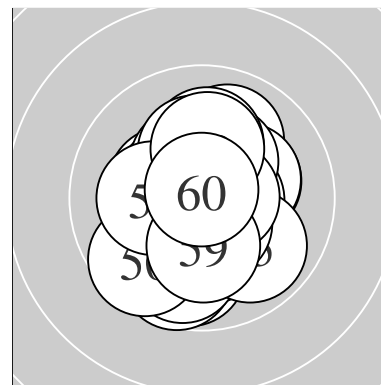

Serie 1:						
	10.7 *	10.0 ↓	10.7 *	10.8 *	10.2 *	
	10.5 *	10.0 ↑	10.7 *	10.5 *	10.5 *	
beste Teiler	47.7	(4.)	62.0	(8.)	64.1	(1.)
Trefferlage	0.38 mm rechts, 0.30 mm hoch					
Streuwert	0.97, horizontal: 0.76, vertikal: 1.15					

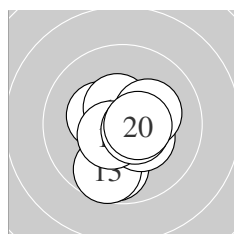

Serie 2:						
	10.3 *	9.8 ↓	9.7 ↓	10.4 *	10.9 *	
	10.5 *	10.5 *	10.2 *	10.6 *	10.5 *	
beste Teiler	7.0	(15.)	90.8	(19.)	101.4	(20.)
Trefferlage	0.05 mm rechts, 0.55 mm tief					
Streuwert	1.23, horizontal: 1.05, vertikal: 1.38					

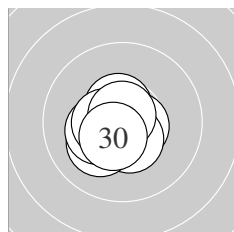

Serie 3:						
	10.6 *	10.9 *	10.6 *	10.6 *	10.5 *	
	10.2 *	10.3 *	10.5 *	10.8 *	10.5 *	
beste Teiler	25.0	(22.)	45.2	(29.)	82.7	(21.)
Trefferlage	0.41 mm links, 0.34 mm tief					
Streuwert	0.76, horizontal: 0.81, vertikal: 0.72					

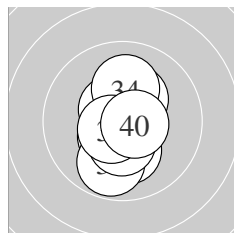

Serie 4:						
	10.3 *	10.8 *	10.5 *	10.1 ↑	10.2 *	
	10.5 *	9.8 ↓	10.4 *	10.6 *	10.6 *	
beste Teiler	50.0	(32.)	82.4	(40.)	90.8	(39.)
Trefferlage	0.11 mm links, 0.30 mm tief					
Streuwert	1.16, horizontal: 0.62, vertikal: 1.52					

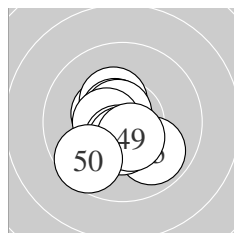

Serie 5:						
	10.4 *	10.4 *	10.6 *	10.7 *	9.9 ↘	
	10.5 *	10.5 *	10.5 *	10.5 *	9.6 ↙	
beste Teiler	64.4	(44.)	80.2	(43.)	106.0	(46.)
Trefferlage	0.38 mm links, 0.45 mm tief					
Streuwert	1.18, horizontal: 1.10, vertikal: 1.25					

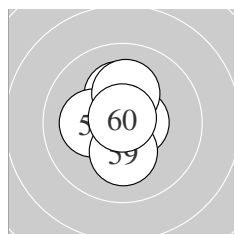

Serie 6:						
	10.6 *	10.5 *	10.7 *	10.6 *	10.2 *	
	10.6 *	10.2 *	10.2 *	10.2 *	10.8 *	
beste Teiler	33.0	(60.)	68.5	(53.)	80.4	(54.)
Trefferlage	0.31 mm links, 0.27 mm hoch					
Streuwert	0.96, horizontal: 0.80, vertikal: 1.10					

Meyton Elektronik

ISSF AR Men – Wertung – **Männer**

StandNr: 108

Sandeep, #377

StartNr: 54

20. Januar 2020 11:32

Indian Army

Unterschrift des Schützen

Meyton Elektronik

Ergebnis: **624.4** (595)
 Serien: 103.2 104.8 104.3 103.4 104.2 104.5
 Zähler: 55 5 0 0 0 0 0 0 0 0
 Innenzehner: 51
 weiteste: 374 (35), 293 (20), 276 (6)
 beste Teiler 33.2 (55.) 37.4 (19.) 38.6 (57.)
 Trefferlage 0.02 mm rechts, 0.07 mm hoch
 Streuwert 1.09, horizontal: 1.24, vertikal: 0.91

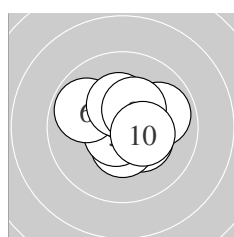
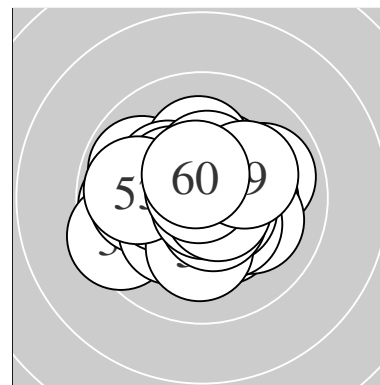

Serie 1:
 10.3 * 10.5 * 10.5 * 9.9 → 10.7 *
 9.8 ↖ 10.4 * 10.3 * 10.4 * 10.4 *
 beste Teiler 65.7 (5.) 124.9 (3.) 125.0 (2.)
 Trefferlage 0.28 mm rechts, 0.43 mm hoch
 Streuwert 1.21, horizontal: 1.35, vertikal: 1.07

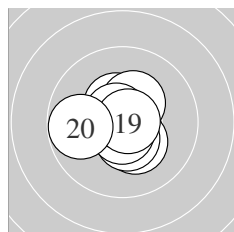

Serie 2:
 10.4 * 10.7 * 10.3 * 10.6 * 10.5 *
 10.3 * 10.7 * 10.7 * 10.8 * 9.8 ←
 beste Teiler 37.4 (19.) 57.6 (12.) 64.3 (18.)
 Trefferlage 0.19 mm links, 0.09 mm tief
 Streuwert 1.01, horizontal: 1.11, vertikal: 0.89

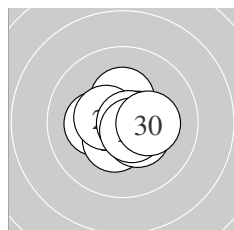

Serie 3:
 10.4 * 10.3 * 10.2 * 10.5 * 10.4 *
 10.5 * 10.4 * 10.8 * 10.6 * 10.2 *
 beste Teiler 43.4 (28.) 86.4 (29.) 106.4 (24.)
 Trefferlage 0.29 mm rechts, 0.12 mm tief
 Streuwert 0.98, horizontal: 1.17, vertikal: 0.75

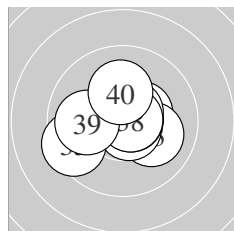

Serie 4:
 10.4 * 10.5 * 10.1 ↘ 10.7 * 9.5 ←
 10.7 * 10.6 * 10.7 * 10.0 ← 10.2 *
 beste Teiler 55.9 (38.) 59.8 (36.) 67.9 (34.)
 Trefferlage 0.08 mm links, 0.12 mm hoch
 Streuwert 1.37, horizontal: 1.65, vertikal: 1.01

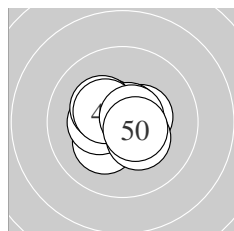

Serie 5:
 10.4 * 10.2 * 10.4 * 10.7 * 10.3 *
 10.3 * 10.4 * 10.7 * 10.3 * 10.5 *
 beste Teiler 63.4 (44.) 71.1 (48.) 101.5 (50.)
 Trefferlage 0.22 mm links, 0.07 mm hoch
 Streuwert 1.00, horizontal: 1.17, vertikal: 0.81

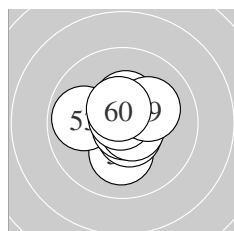

Serie 6:
 10.1 ↓ 10.6 * 9.9 ← 10.7 * 10.8 *
 10.6 * 10.8 * 10.4 * 10.1 → 10.5 *
 beste Teiler 33.2 (55.) 38.6 (57.) 62.9 (54.)
 Trefferlage 0.06 mm rechts, 0.05 mm hoch
 Streuwert 1.07, horizontal: 1.13, vertikal: 1.01

Meyton Elektronik

ISSF AR Men – Wertung – **Männer**

StandNr: 110

Pickl, Bernhard #294

StartNr: 56

20. Januar 2020 11:40

AUT

Unterschrift des Schützen

Meyton Elektronik

Ergebnis: **620.9** (594)
 Serien: 104.9 103.0 103.2 103.4 102.8 103.6
 Zähler: 54 6 0 0 0 0 0 0 0
 Innenzehner: 43
 weiteste: 433 (19), 300 (48), 288 (46)
 beste Teiler 28.7 (47.) 39.6 (3.) 46.5 (2.)
 Trefferlage 0.10 mm links, 0.01 mm tief
 Streuwert 1.22, horizontal: 1.16, vertikal: 1.28

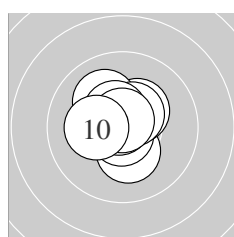
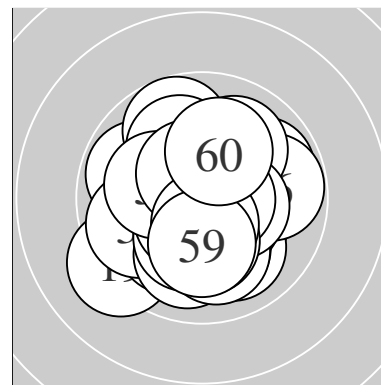

Serie 1:
 10.3 * 10.8 * 10.8 * 10.3 * 10.1 ↗
 10.5 * 10.6 * 10.5 * 10.8 * 10.2 *
 beste Teiler 39.6 (3.) 46.5 (2.) 47.1 (9.)
 Trefferlage 0.26 mm links, 0.39 mm hoch
 Streuwert 0.91, horizontal: 0.87, vertikal: 0.95

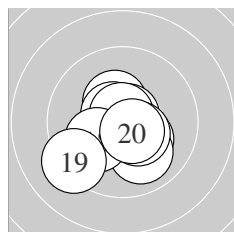

Serie 2:
 10.4 * 10.7 * 10.6 * 10.2 * 10.0 ↓
 10.8 * 10.4 * 10.1 ↙ 9.2 ↙ 10.6 *
 beste Teiler 50.6 (16.) 53.6 (12.) 87.3 (13.)
 Trefferlage 0.18 mm links, 0.57 mm tief
 Streuwert 1.39, horizontal: 1.49, vertikal: 1.28

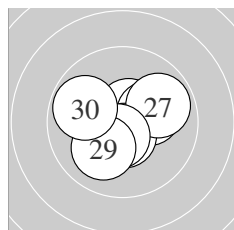

Serie 3:
 10.4 * 10.7 * 10.6 * 10.4 * 10.2 *
 10.6 * 9.9 ↗ 10.5 * 10.1 ↙ 9.8 ↖
 beste Teiler 59.5 (22.) 88.5 (23.) 94.6 (26.)
 Trefferlage 0.10 mm links, 0.16 mm tief
 Streuwert 1.30, horizontal: 1.52, vertikal: 1.04

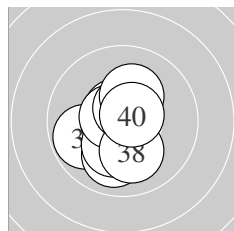

Serie 4:
 9.8 ↖ 10.7 * 10.6 * 10.0 ↓ 10.2 *
 10.6 * 10.6 * 10.1 ↓ 10.2 * 10.6 *
 beste Teiler 68.0 (32.) 77.6 (40.) 83.5 (36.)
 Trefferlage 0.37 mm links, 0.30 mm tief
 Streuwert 1.20, horizontal: 0.98, vertikal: 1.39

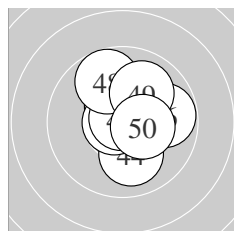

Serie 5:
 10.7 * 10.5 * 10.1 ↗ 10.0 ↓ 10.7 *
 9.8 ↗ 10.8 * 9.8 ↖ 10.0 ↗ 10.4 *
 beste Teiler 28.7 (47.) 53.1 (41.) 57.1 (45.)
 Trefferlage 0.56 mm rechts, 0.63 mm hoch
 Streuwert 1.30, horizontal: 1.17, vertikal: 1.42

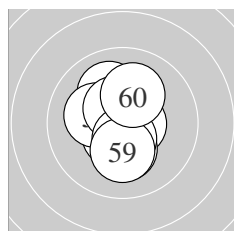

Serie 6:
 10.7 * 10.6 * 10.1 ↖ 10.5 * 10.2 *
 10.2 * 10.5 * 10.5 * 10.2 * 10.1 ↗
 beste Teiler 68.0 (51.) 81.3 (52.) 101.8 (54.)
 Trefferlage 0.26 mm links, 0.04 mm tief
 Streuwert 1.15, horizontal: 0.79, vertikal: 1.41

Meyton Elektronik

ISSF AR Men – Wertung – Männer

StandNr: 111

Schmir, Alexander #148

StartNr: 57

20. Januar 2020 11:48

AUT

Unterschrift des Schützen

Meyton Elektronik

Ergebnis: **617.3** (591)
 Serien: 105.1 101.8 101.8 103.0 103.4 102.2
 Zähler: 51 9 0 0 0 0 0 0 0
 Innenzehner: 41
 weiteste: 305 (15), 302 (47), 301 (12)
 beste Teiler 10.1 (42.) 21.0 (4.) 22.3 (2.)
 Trefferlage 0.08 mm links, 0.05 mm tief
 Streuwert 1.29, horizontal: 1.34, vertikal: 1.25

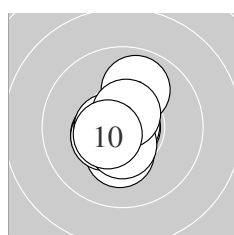
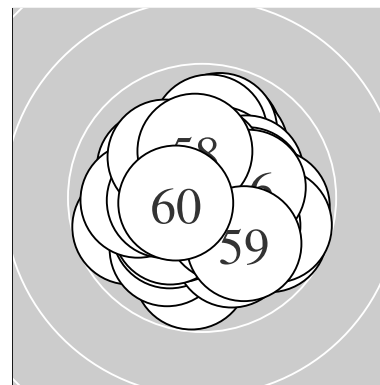

Serie 1:
 10.3 * 10.9 * 10.5 * 10.9 * 10.4 *
 9.9 ↑ 10.6 * 10.5 * 10.6 * 10.5 *
 beste Teiler 21.0 (4.) 22.3 (2.) 90.9 (9.)
 Trefferlage 0.29 mm links, 0.10 mm tief
 Streuwert 0.94, horizontal: 0.70, vertikal: 1.13

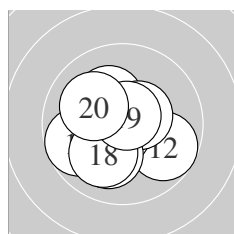

Serie 2:
 10.2 * 9.7 ↘ 10.0 ↙ 10.7 * 9.7 ↙
 10.5 * 10.1 ↙ 10.1 ↙ 10.7 * 10.1 ↘
 beste Teiler 60.8 (19.) 73.0 (14.) 116.8 (16.)
 Trefferlage 0.64 mm links, 0.41 mm tief
 Streuwert 1.46, horizontal: 1.62, vertikal: 1.29

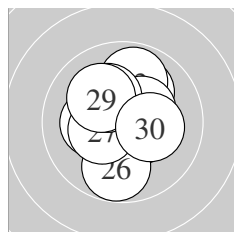

Serie 3:
 10.2 * 10.1 ↑ 9.9 ↑ 10.5 * 10.4 *
 9.8 ↓ 10.4 * 10.2 * 10.1 ↘ 10.2 *
 beste Teiler 109.6 (24.) 140.8 (27.) 144.9 (25.)
 Trefferlage 0.01 mm links, 0.41 mm hoch
 Streuwert 1.48, horizontal: 1.32, vertikal: 1.62

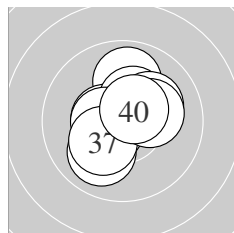

Serie 4:
 9.9 ↑ 10.6 * 10.5 * 10.0 ↙ 10.4 *
 10.5 * 10.2 * 10.2 * 10.2 * 10.5 *
 beste Teiler 95.0 (32.) 107.4 (40.) 113.9 (33.)
 Trefferlage 0.05 mm links, 0.25 mm hoch
 Streuwert 1.28, horizontal: 1.25, vertikal: 1.31

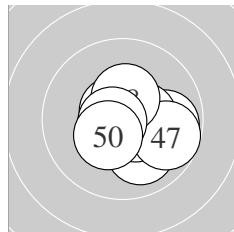

Serie 5:
 10.0 ↘ 10.9 * 9.8 → 10.4 * 10.6 *
 10.5 * 9.7 ↘ 10.4 * 10.7 * 10.4 *
 beste Teiler 10.1 (42.) 68.8 (49.) 77.8 (45.)
 Trefferlage 0.68 mm rechts, 0.33 mm tief
 Streuwert 1.16, horizontal: 1.35, vertikal: 0.94

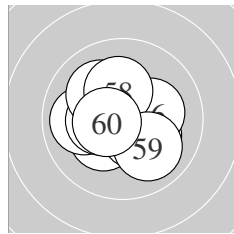

Serie 6:
 10.3 * 10.2 * 10.4 * 9.9 ← 10.4 *
 10.2 * 10.1 ↘ 10.2 * 10.0 ↘ 10.5 *
 beste Teiler 104.9 (60.) 131.3 (53.) 148.3 (55.)
 Trefferlage 0.21 mm links, 0.15 mm tief
 Streuwert 1.39, horizontal: 1.57, vertikal: 1.18

Meyton Elektronik

ISSF AR Men – Wertung – Männer

StandNr: 113

Rahman, Mohamad Irwan Abdul #450

StartNr: 59

20. Januar 2020 11:45

SGP

Unterschrift des Schützen

Meyton Elektronik

Ergebnis:	621.9	(596)							
Serien:	102.4	105.5	103.2	103.0	103.9	103.9			
Zähler:	56	4	0	0	0	0	0	0	0
Innenzehner:	49								
weiteste:	308	(2),	300	(1),	262	(33)			
beste Teiler	48.2	(13.)	50.3	(28.)	61.4	(14.)			
Trefferlage	0.13	mm links,	0.06	mm hoch					
Streuwert	1.13,	horizontal:	1.22,	vertikal:	1.03				

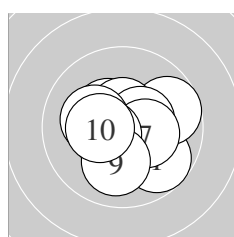
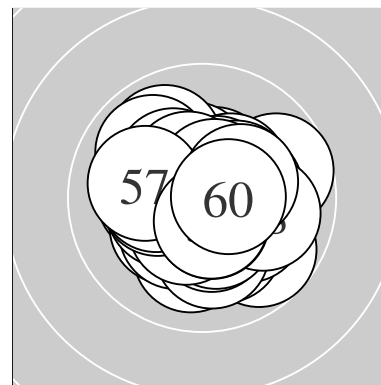

Serie 1:

9.8 ↘	9.7 →	10.4 *	10.6 *	10.5 *
10.2 *	10.3 *	10.5 *	10.0 ↓	10.4 *
beste Teiler	99.0 (4.)	111.8 (8.)	123.0 (5.)	
Trefferlage	0.20 mm rechts, 0.13 mm tief			
Streuwert	1.43, horizontal: 1.64, vertikal: 1.19			

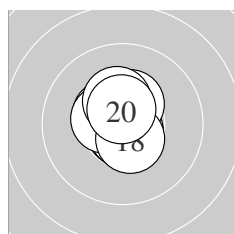

Serie 2:

10.5 *	10.7 *	10.8 *	10.7 *	10.5 *
10.4 *	10.5 *	10.5 *	10.3 *	10.6 *
beste Teiler	48.2 (13.)	61.4 (14.)	61.6 (12.)	
Trefferlage	0.16 mm links, 0.34 mm hoch			
Streuwert	0.76, horizontal: 0.58, vertikal: 0.90			

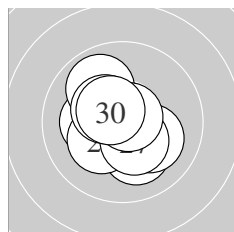

Serie 3:

10.2 *	10.1 ↓	9.9 ↖	10.6 *	10.2 *
10.1 ↘	10.4 *	10.8 *	10.4 *	10.5 *
beste Teiler	50.3 (28.)	84.2 (24.)	110.3 (30.)	
Trefferlage	0.27 mm links, 0.19 mm tief			
Streuwert	1.22, horizontal: 1.22, vertikal: 1.23			

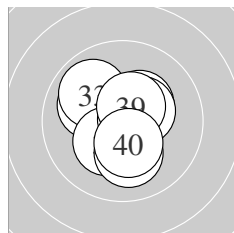

Serie 4:

10.4 *	10.0 ↖	9.9 ↖	10.3 *	10.3 *
10.7 *	10.1 ↓	10.4 *	10.5 *	10.4 *
beste Teiler	62.1 (36.)	110.6 (39.)	137.4 (38.)	
Trefferlage	0.18 mm links, 0.17 mm hoch			
Streuwert	1.27, horizontal: 1.22, vertikal: 1.31			

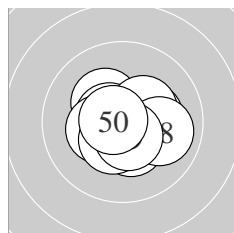

Serie 5:

10.3 *	10.3 *	10.6 *	10.4 *	10.3 *
10.3 *	10.4 *	10.0 →	10.6 *	10.7 *
beste Teiler	62.3 (50.)	92.3 (43.)	99.5 (49.)	
Trefferlage	0.16 mm rechts, 0.16 mm tief			
Streuwert	1.11, horizontal: 1.31, vertikal: 0.86			

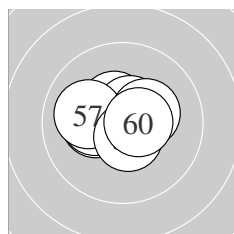

Serie 6:

10.3 *	10.4 *	10.5 *	10.5 *	10.6 *
10.2 *	10.0 ←	10.6 *	10.3 *	10.5 *
beste Teiler	96.7 (55.)	97.8 (58.)	103.1 (60.)	
Trefferlage	0.52 mm links, 0.36 mm hoch			
Streuwert	1.00, horizontal: 1.30, vertikal: 0.57			

Meyton Elektronik

ISSF AR Men – Wertung – Männer

StandNr: 114

Lochbihler, Jan #419

StartNr: 60

20. Januar 2020 11:45

SUI

Unterschrift des Schützen

Meyton Elektronik

Ergebnis: **622.0** (594)
 Serien: 102.6 102.4 104.2 103.9 105.6 103.3
 Zähler: 54 6 0 0 0 0 0 0 0 0
 Innenzehner: 50
 weiteste: 409 (60), 376 (38), 306 (15)
 beste Teiler 26.3 (32.) 28.2 (56.) 39.2 (47.)
 Trefferlage 0.01 mm links, 0.01 mm hoch
 Streuwert 1.18, horizontal: 1.39, vertikal: 0.93

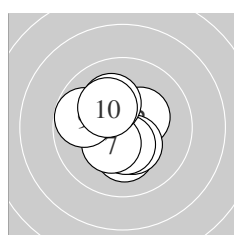
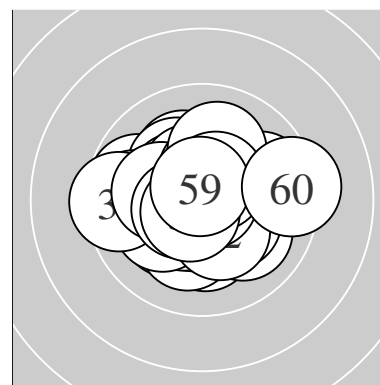

Serie 1:
 10.2 * 10.3 * 10.5 * 10.2 * 10.4 *
 10.4 * 10.4 * 10.2 * 9.8 ← 10.2 *
 beste Teiler 115.7 (3.) 133.0 (6.) 148.6 (7.)
 Trefferlage 0.62 mm links, 0.03 mm tief
 Streuwert 1.28, horizontal: 1.26, vertikal: 1.30

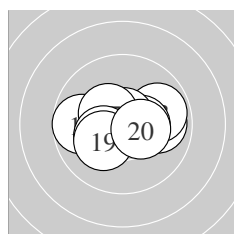

Serie 2:
 10.5 * 9.9 → 9.9 → 10.4 * 9.7 ←
 10.7 * 10.4 * 10.3 * 10.2 * 10.4 *
 beste Teiler 51.1 (16.) 118.8 (11.) 134.1 (14.)
 Trefferlage 0.21 mm rechts, 0.04 mm tief
 Streuwert 1.43, horizontal: 1.91, vertikal: 0.67

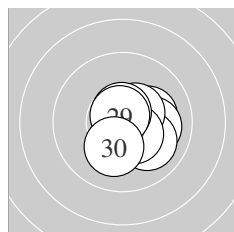

Serie 3:
 10.7 * 10.2 * 10.1 → 10.0 ↘ 10.6 *
 10.5 * 10.5 * 10.7 * 10.7 * 10.2 *
 beste Teiler 54.2 (29.) 64.6 (21.) 74.4 (28.)
 Trefferlage 0.78 mm rechts, 0.22 mm tief
 Streuwert 0.95, horizontal: 0.96, vertikal: 0.94

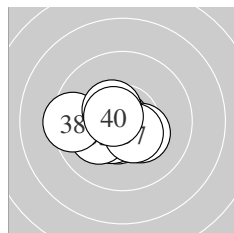

Serie 4:
 10.7 * 10.8 * 10.5 * 10.5 * 10.1 ←
 10.3 * 10.5 * 9.4 ← 10.5 * 10.6 *
 beste Teiler 26.3 (32.) 58.1 (31.) 77.3 (40.)
 Trefferlage 0.68 mm links, 0.35 mm tief
 Streuwert 1.09, horizontal: 1.39, vertikal: 0.67

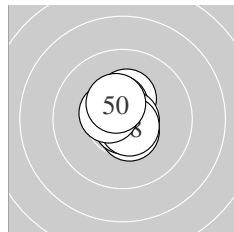

Serie 5:
 10.3 * 10.5 * 10.7 * 10.5 * 10.5 *
 10.7 * 10.8 * 10.7 * 10.5 * 10.4 *
 beste Teiler 39.2 (47.) 52.6 (43.) 72.2 (46.)
 Trefferlage 0.11 mm links, 0.36 mm hoch
 Streuwert 0.70, horizontal: 0.56, vertikal: 0.82

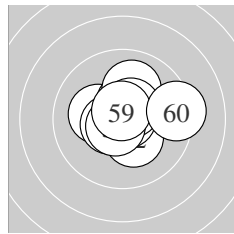

Serie 6:
 10.2 * 10.3 * 10.5 * 10.4 * 10.0 ↑
 10.8 * 10.5 * 10.6 * 10.7 * 9.3 →
 beste Teiler 28.2 (56.) 61.6 (59.) 76.3 (58.)
 Trefferlage 0.33 mm rechts, 0.35 mm hoch
 Streuwert 1.30, horizontal: 1.55, vertikal: 1.00

Meyton Elektronik

ISSF AR Men – Wertung – Männer

StandNr: 115

Gutierrez, Julian #386

StartNr: 61

20. Januar 2020 11:36

ARG

Unterschrift des Schützen

Meyton Elektronik

Ergebnis:	617.6	(595)							
Serien:	103.7	102.8	102.0	103.8	103.7	101.6			
Zähler:	55	5	0	0	0	0	0	0	0
Innenzehner:	45								
weiteste:	473 (24), 424 (59), 402 (20)								
beste Teiler	10.0 (45.)	36.1 (9.)	47.1 (29.)						
Trefferlage	0.19 mm rechts, 0.27 mm hoch								
Streuwert	1.31, horizontal: 1.41, vertikal: 1.19								

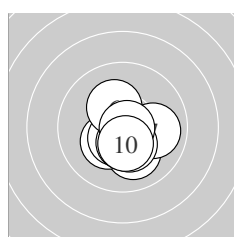
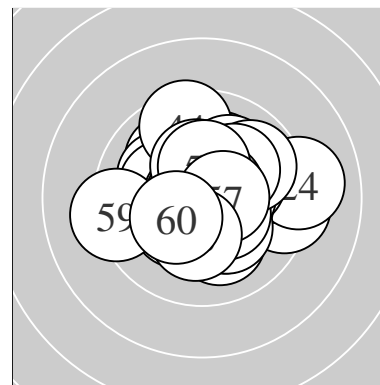

Serie 1:	10.4 *	10.1 ↘	10.3 *	10.5 *	10.5 *
	10.3 *	10.0 →	10.4 *	10.8 *	10.4 *
beste Teiler	36.1 (9.) 105.3 (4.) 124.3 (5.)				
Trefferlage	0.27 mm rechts, 0.80 mm tief				
Streuwert	1.00, horizontal: 1.00, vertikal: 1.00				

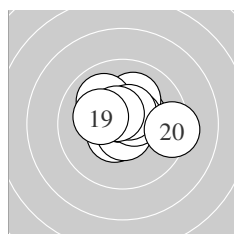

Serie 2:	10.5 *	10.4 *	10.1 ↗	10.0 ↖	10.7 *
	10.5 *	10.5 *	10.6 *	10.2 *	9.3 →
beste Teiler	71.0 (15.) 97.2 (18.) 105.5 (16.)				
Trefferlage	0.33 mm rechts, 0.52 mm hoch				
Streuwert	1.35, horizontal: 1.66, vertikal: 0.97				

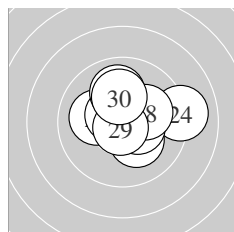

Serie 3:	10.5 *	10.1 ←	10.2 *	9.1 →	10.6 *
	10.0 ↑	10.4 *	10.2 *	10.8 *	10.1 ↑
beste Teiler	47.1 (29.) 99.6 (25.) 114.7 (21.)				
Trefferlage	0.53 mm rechts, 0.58 mm hoch				
Streuwert	1.53, horizontal: 1.84, vertikal: 1.14				

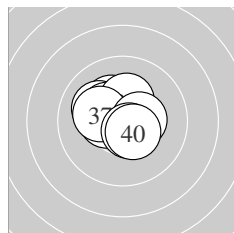

Serie 4:	10.6 *	10.3 *	10.1 ↖	10.4 *	10.3 *
	10.4 *	10.2 *	10.4 *	10.6 *	10.5 *
beste Teiler	82.2 (31.) 93.1 (39.) 120.9 (40.)				
Trefferlage	0.42 mm links, 0.49 mm hoch				
Streuwert	1.01, horizontal: 1.15, vertikal: 0.86				

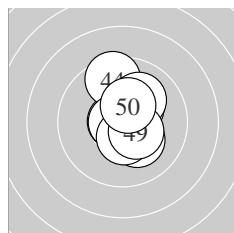

Serie 5:	10.2 *	10.3 *	10.7 *	9.5 ↑	10.9 *
	10.7 *	10.5 *	10.1 ↗	10.4 *	10.4 *
beste Teiler	10.0 (45.) 53.0 (46.) 61.2 (43.)				
Trefferlage	0.33 mm rechts, 0.42 mm hoch				
Streuwert	1.21, horizontal: 0.81, vertikal: 1.51				

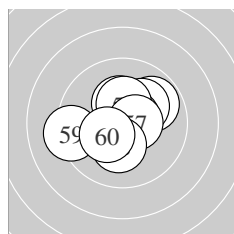

Serie 6:	10.2 *	9.8 ↗	10.1 ↗	10.3 *	10.6 *
	10.3 *	10.5 *	10.2 *	9.3 ←	10.3 *
beste Teiler	87.8 (55.) 102.0 (57.) 153.3 (56.)				
Trefferlage	0.12 mm rechts, 0.41 mm hoch				
Streuwert	1.57, horizontal: 1.84, vertikal: 1.23				

Meyton Elektronik

ISSF AR Men – Wertung – **Männer**

StandNr: 116

Diem, Patrick #133

StartNr: 62

20. Januar 2020 11:52

AUT

Unterschrift des Schützen

Meyton Elektronik

Ergebnis:	626.6	(596) ^{QF}							
Serien:	105.0	104.6	104.2	103.9	105.5	103.4			
Zähler:	56	4	0	0	0	0	0	0	0
Innenzehner:	51								
weiteste:	318 (54), 315 (11), 256 (55)								
beste Teiler	5.0 (36.) 31.0 (18.) 33.9 (46.)								
Trefferlage	0.15 mm rechts, 0.10 mm hoch								
Streuwert	1.02, horizontal: 1.03, vertikal: 1.02								

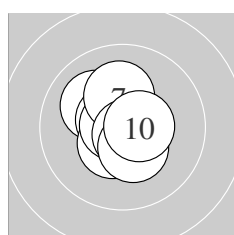
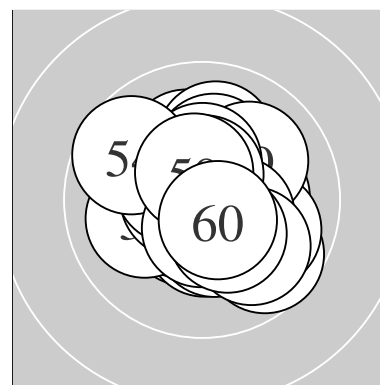

Serie 1:	10.1 ↘	10.6 *	10.6 *	10.5 *	10.6 *
	10.8 *	10.2 *	10.7 *	10.4 *	10.5 *
beste Teiler	50.6 (6.) 55.4 (8.) 81.0 (2.)				
Trefferlage	0.11 mm links, 0.20 mm hoch				
Streuwert	0.93, horizontal: 0.86, vertikal: 0.99				

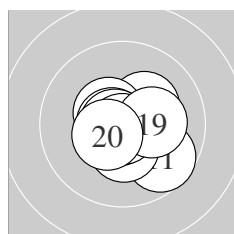

Serie 2:	9.7 ↘	10.4 *	10.3 *	10.5 *	10.7 *
	10.7 *	10.8 *	10.8 *	10.2 *	10.5 *
beste Teiler	31.0 (18.) 49.0 (17.) 52.0 (16.)				
Trefferlage	0.23 mm rechts, 0.29 mm tief				
Streuwert	1.08, horizontal: 1.20, vertikal: 0.93				

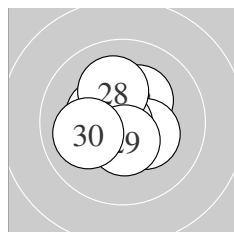

Serie 3:	10.5 *	10.7 *	10.3 *	10.3 *	10.6 *
	10.4 *	10.8 *	10.1 ↗	10.5 *	10.0 ←
beste Teiler	35.8 (27.) 70.4 (22.) 92.0 (25.)				
Trefferlage	0.43 mm links, 0.00 mm				
Streuwert	1.03, horizontal: 1.06, vertikal: 0.99				

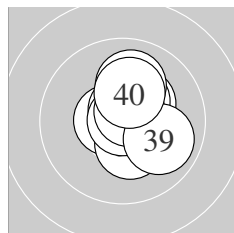

Serie 4:	10.6 *	10.3 *	10.7 *	10.3 *	10.4 *
	10.9 *	10.0 ↑	10.6 *	9.9 ↘	10.2 *
beste Teiler	5.0 (36.) 70.2 (33.) 76.2 (38.)				
Trefferlage	0.52 mm rechts, 0.52 mm hoch				
Streuwert	1.02, horizontal: 0.81, vertikal: 1.18				

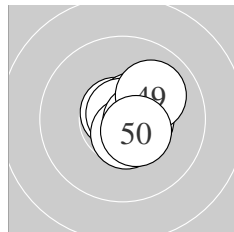

Serie 5:	10.7 *	10.7 *	10.5 *	10.6 *	10.5 *
	10.8 *	10.6 *	10.6 *	10.0 ↗	10.5 *
beste Teiler	33.9 (46.) 59.4 (42.) 68.8 (41.)				
Trefferlage	0.63 mm rechts, 0.12 mm hoch				
Streuwert	0.69, horizontal: 0.63, vertikal: 0.75				

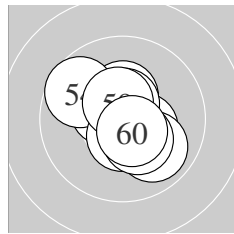

Serie 6:	10.4 *	10.5 *	10.4 *	9.7 ↘	9.9 ↘
	10.5 *	10.6 *	10.3 *	10.5 *	10.6 *
beste Teiler	97.4 (57.) 97.6 (60.) 107.0 (56.)				
Trefferlage	0.07 mm rechts, 0.02 mm hoch				
Streuwert	1.27, horizontal: 1.29, vertikal: 1.25				

Meyton Elektronik

ISSF AR Men – Wertung – Männer

StandNr: 118

Strepfl, Martin #31

StartNr: 63

20. Januar 2020 11:51

AUT

QF – Schütze hat sich fürs Finale qualifiziert

Unterschrift des Schützen

Meyton Elektronik

Ergebnis: **621.5** (595)
 Serien: 104.2 102.5 103.9 104.0 102.0 104.9
 Zähler: 55 5 0 0 0 0 0 0 0 0
 Innenzehner: 45
 weiteste: 362 (43), 335 (45), 295 (1)
 beste Teiler 8.9 (7.) 12.3 (36.) 14.2 (9.)
 Trefferlage 0.07 mm links, 0.04 mm hoch
 Streuwert 1.20, horizontal: 1.30, vertikal: 1.09

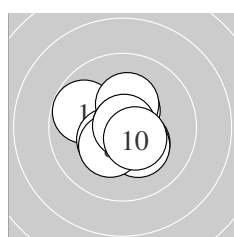
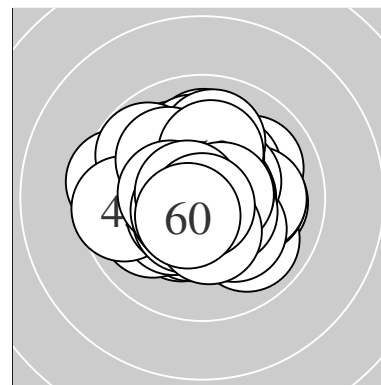

Serie 1:
 9.8 ↖ 10.4 * 10.3 * 10.3 * 10.5 *
 10.3 * 10.9 * 10.3 * 10.9 * 10.5 *
 beste Teiler 8.9 (7.) 14.2 (9.) 119.6 (10.)
 Trefferlage 0.06 mm links, 0.14 mm tief
 Streuwert 1.16, horizontal: 1.19, vertikal: 1.12

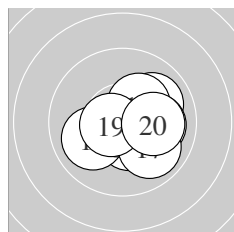

Serie 2:
 10.4 * 10.4 * 10.0 ↙ 10.0 ↗ 10.0 →
 10.8 * 9.9 ↘ 10.3 * 10.6 * 10.1 →
 beste Teiler 38.8 (16.) 83.4 (19.) 127.9 (12.)
 Trefferlage 0.81 mm rechts, 0.30 mm tief
 Streuwert 1.25, horizontal: 1.48, vertikal: 0.98

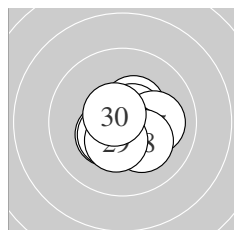

Serie 3:
 10.4 * 10.3 * 10.4 * 10.6 * 10.1 →
 10.5 * 10.4 * 10.2 * 10.4 * 10.6 *
 beste Teiler 79.2 (30.) 82.4 (24.) 104.2 (26.)
 Trefferlage 0.36 mm rechts, 0.41 mm tief
 Streuwert 0.99, horizontal: 1.11, vertikal: 0.85

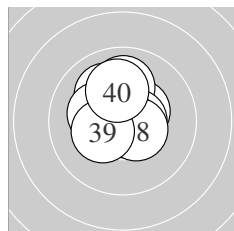

Serie 4:
 10.4 * 10.0 ↑ 10.6 * 10.9 * 10.1 ↘
 10.9 * 10.2 * 10.5 * 10.3 * 10.1 ↑
 beste Teiler 12.3 (36.) 17.8 (34.) 91.0 (33.)
 Trefferlage 0.13 mm links, 0.63 mm hoch
 Streuwert 1.08, horizontal: 1.02, vertikal: 1.14

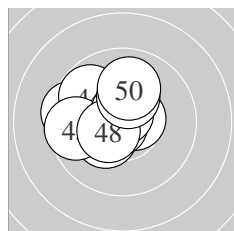

Serie 5:
 10.3 * 10.6 * 9.5 ↖ 9.8 ↘ 9.6 ←
 10.8 * 10.7 * 10.5 * 10.2 * 10.0 ↑
 beste Teiler 50.5 (46.) 62.1 (47.) 86.1 (42.)
 Trefferlage 1.02 mm links, 0.51 mm hoch
 Streuwert 1.38, horizontal: 1.57, vertikal: 1.16

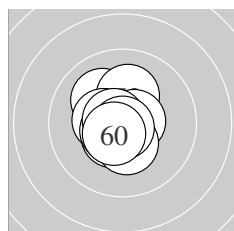

Serie 6:
 10.1 ↘ 10.2 * 10.4 * 10.5 * 10.6 *
 10.6 * 10.7 * 10.4 * 10.8 * 10.6 *
 beste Teiler 34.0 (59.) 65.1 (57.) 82.0 (56.)
 Trefferlage 0.40 mm links, 0.00 mm
 Streuwert 0.92, horizontal: 0.75, vertikal: 1.07

Meyton Elektronik

ISSF AR Men – Wertung – **Männer**

StandNr: 119

Rohit, #374

StartNr: 64

20. Januar 2020 11:28

Indian Army

Unterschrift des Schützen

Meyton Elektronik

Ergebnis: **628.3** (599)^{QF}
 Serien: 104.2 105.2 104.2 105.2 105.9 103.6
 Zähler: 59 1 0 0 0 0 0 0 0
 Innenzehner: 54
 weiteste: 274 (10), 245 (28), 238 (30)
 beste Teiler 24.3 (44.) 29.4 (59.) 35.0 (32.)
 Trefferlage 0.20 mm links, 0.04 mm hoch
 Streuwert 0.95, horizontal: 1.04, vertikal: 0.85

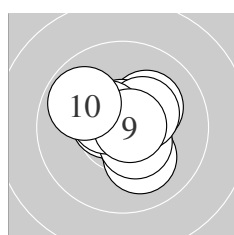
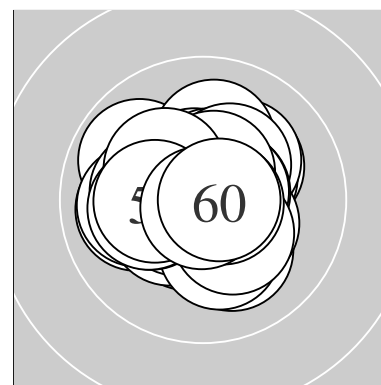

Serie 1:
 10.5 * 10.1 ↘ 10.2 * 10.6 * 10.7 *
 10.5 * 10.4 * 10.5 * 10.8 * 9.9 ↖
 beste Teiler 44.9 (9.) 67.4 (5.) 96.2 (4.)
 Trefferlage 0.14 mm rechts, 0.15 mm hoch
 Streuwert 1.13, horizontal: 1.20, vertikal: 1.05

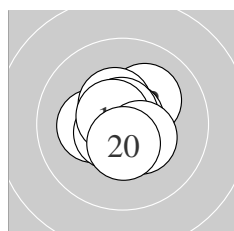

Serie 2:
 10.2 * 10.2 * 10.6 * 10.4 * 10.8 *
 10.8 * 10.7 * 10.6 * 10.4 * 10.5 *
 beste Teiler 42.2 (15.) 42.5 (16.) 61.4 (17.)
 Trefferlage 0.05 mm links, 0.12 mm hoch
 Streuwert 0.88, horizontal: 0.91, vertikal: 0.85

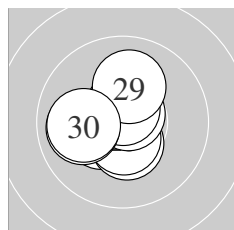

Serie 3:
 10.6 * 10.8 * 10.4 * 10.4 * 10.6 *
 10.7 * 10.6 * 10.0 ← 10.1 ↑ 10.0 ←
 beste Teiler 41.1 (22.) 61.0 (26.) 80.3 (21.)
 Trefferlage 0.54 mm links, 0.07 mm hoch
 Streuwert 1.06, horizontal: 1.10, vertikal: 1.02

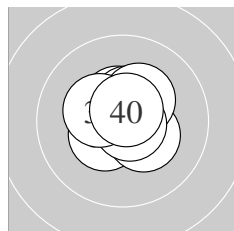

Serie 4:
 10.5 * 10.8 * 10.6 * 10.5 * 10.4 *
 10.3 * 10.3 * 10.8 * 10.3 * 10.7 *
 beste Teiler 35.0 (32.) 48.3 (38.) 71.7 (40.)
 Trefferlage 0.03 mm links, 0.22 mm hoch
 Streuwert 0.85, horizontal: 0.87, vertikal: 0.83

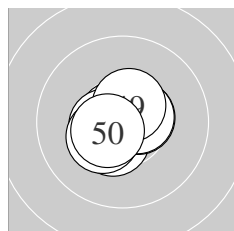

Serie 5:
 10.5 * 10.6 * 10.7 * 10.9 * 10.7 *
 10.6 * 10.5 * 10.4 * 10.5 * 10.5 *
 beste Teiler 24.3 (44.) 51.1 (45.) 58.1 (43.)
 Trefferlage 0.15 mm links, 0.03 mm tief
 Streuwert 0.73, horizontal: 0.81, vertikal: 0.64

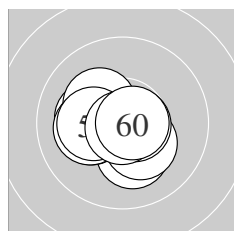

Serie 6:
 10.2 * 10.2 * 10.3 * 10.2 * 10.2 *
 10.1 ← 10.2 * 10.7 * 10.8 * 10.7 *
 beste Teiler 29.4 (59.) 59.0 (60.) 72.0 (58.)
 Trefferlage 0.60 mm links, 0.26 mm tief
 Streuwert 1.07, horizontal: 1.30, vertikal: 0.79

Meyton Elektronik

ISSF AR Men – Wertung – Männer

StandNr: 120

Renz, Andreas #451

StartNr: 65

20. Januar 2020 11:35

GER

QF – Schütze hat sich fürs Finale qualifiziert

Unterschrift des Schützen

Meyton Elektronik

Ergebnis:	626.9	(596) ^{QF}							
Serien:	103.5	105.1	102.6	105.0	105.4	105.3			
Zähler:	56	4	0	0	0	0	0	0	0
Innenzehner:	50								
weiteste:	322 (5), 317 (23), 267 (21)								
beste Teiler	4.4 (12.)	14.2 (16.)	30.0 (41.)						
Trefferlage	0.37 mm links, 0.19 mm hoch								
Streuwert	1.00, horizontal: 1.11, vertikal: 0.87								

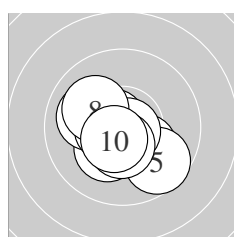
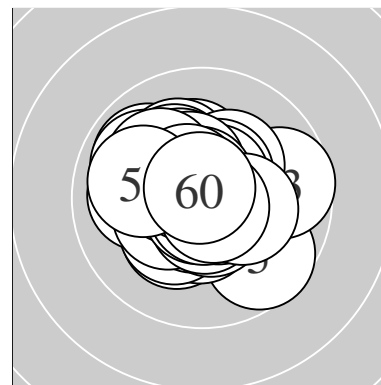

Serie 1:	10.3 *	10.0 ←	10.2 *	10.7 *	9.7 ↘
	10.6 *	10.8 *	10.1 ↖	10.5 *	10.6 *
beste Teiler	41.0 (7.) 74.6 (4.) 98.2 (10.)				
Trefferlage	0.33 mm links, 0.51 mm tief				
Streuwert	1.24, horizontal: 1.39, vertikal: 1.08				

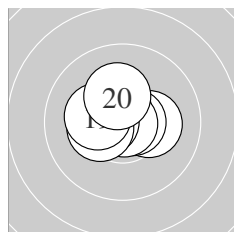

Serie 2:	10.5 *	10.9 *	10.2 *	10.7 *	10.6 *
	10.9 *	10.5 *	10.3 *	10.3 *	10.2 *
beste Teiler	4.4 (12.) 14.2 (16.) 67.0 (14.)				
Trefferlage	0.33 mm links, 0.29 mm hoch				
Streuwert	0.86, horizontal: 1.05, vertikal: 0.62				

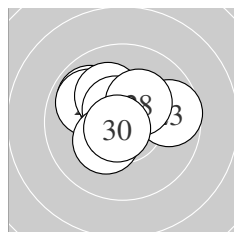

Serie 3:	9.9 ↖	9.9 ↖	9.7 →	10.5 *	10.6 *
	10.1 ↖	10.6 *	10.3 *	10.3 *	10.7 *
beste Teiler	56.7 (30.) 97.1 (27.) 97.8 (25.)				
Trefferlage	0.39 mm links, 0.76 mm hoch				
Streuwert	1.29, horizontal: 1.57, vertikal: 0.93				

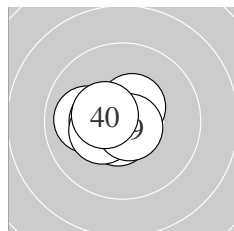

Serie 4:	10.6 *	10.0 ←	10.6 *	10.7 *	10.7 *
	10.5 *	10.4 *	10.3 *	10.7 *	10.5 *
beste Teiler	56.2 (35.) 58.2 (34.) 61.5 (39.)				
Trefferlage	0.60 mm links, 0.06 mm hoch				
Streuwert	0.80, horizontal: 0.98, vertikal: 0.56				

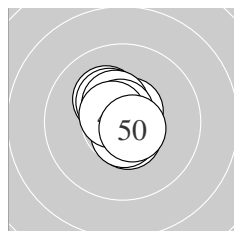

Serie 5:	10.8 *	10.2 *	10.6 *	10.3 *	10.6 *
	10.4 *	10.6 *	10.7 *	10.6 *	10.6 *
beste Teiler	30.0 (41.) 64.5 (48.) 78.7 (50.)				
Trefferlage	0.17 mm links, 0.35 mm hoch				
Streuwert	0.77, horizontal: 0.60, vertikal: 0.91				

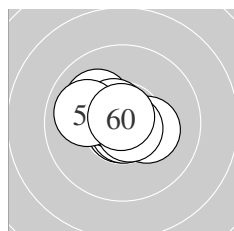

Serie 6:	10.6 *	10.3 *	10.8 *	10.1 ↖	10.8 *
	10.6 *	10.6 *	10.7 *	10.0 ←	10.8 *
beste Teiler	41.2 (60.) 44.9 (53.) 45.7 (55.)				
Trefferlage	0.40 mm links, 0.23 mm hoch				
Streuwert	0.90, horizontal: 1.10, vertikal: 0.63				

Meyton Elektronik

ISSF AR Men – Wertung – **Männer**

StandNr: 121

Rossiter, Jack #407

StartNr: 66

20. Januar 2020 11:37

AUS

QF – Schütze hat sich fürs Finale qualifiziert

Unterschrift des Schützen

Meyton Elektronik

Ergebnis: **622.4** (594)
 Serien: 103.7 104.9 103.2 102.6 104.2 103.8
 Zähler: 54 6 0 0 0 0 0 0 0
 Innenzehner: 47
 weiteste: 286 (44), 286 (51), 273 (6)
 beste Teiler 8.5 (16.) 39.0 (42.) 40.0 (55.)
 Trefferlage 0.15 mm rechts, 0.02 mm hoch
 Streuwert 1.13, horizontal: 1.41, vertikal: 0.77

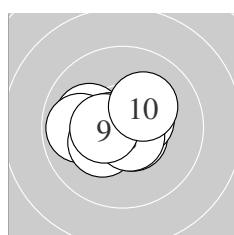
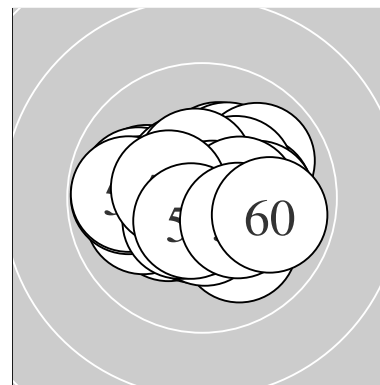

Serie 1:
 10.4 * 10.1 ← 10.6 * 10.5 * 10.6 *
 9.9 ← 10.3 * 10.6 * 10.5 * 10.2 *
 beste Teiler 76.8 (8.) 80.0 (5.) 89.9 (3.)
 Trefferlage 0.35 mm links, 0.07 mm hoch
 Streuwert 1.15, horizontal: 1.47, vertikal: 0.70

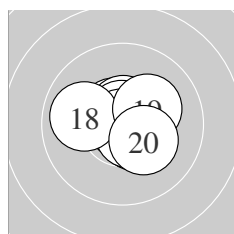

Serie 2:
 10.6 * 10.6 * 10.6 * 10.7 * 10.5 *
 10.9 * 10.6 * 9.9 ← 10.2 * 10.3 *
 beste Teiler 8.5 (16.) 59.4 (14.) 76.2 (17.)
 Trefferlage 0.05 mm rechts, 0.20 mm hoch
 Streuwert 0.97, horizontal: 1.15, vertikal: 0.75

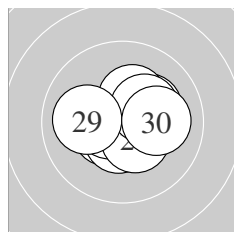

Serie 3:
 10.5 * 10.2 * 10.5 * 10.6 * 10.3 *
 10.3 * 10.4 * 10.3 * 10.0 ← 10.1 →
 beste Teiler 85.1 (24.) 110.1 (23.) 117.4 (21.)
 Trefferlage 0.38 mm rechts, 0.13 mm hoch
 Streuwert 1.18, horizontal: 1.43, vertikal: 0.86

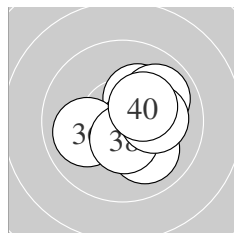

Serie 4:
 10.2 * 10.7 * 9.9 ↗ 10.5 * 10.4 *
 10.0 ← 10.0 ↘ 10.5 * 10.1 → 10.3 *
 beste Teiler 73.2 (32.) 117.5 (38.) 123.0 (34.)
 Trefferlage 0.86 mm rechts, 0.14 mm tief
 Streuwert 1.19, horizontal: 1.26, vertikal: 1.12

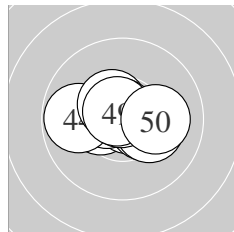

Serie 5:
 10.4 * 10.8 * 10.5 * 9.8 ← 10.5 *
 10.4 * 10.2 * 10.8 * 10.7 * 10.1 →
 beste Teiler 39.0 (42.) 40.2 (48.) 61.0 (49.)
 Trefferlage 0.07 mm links, 0.11 mm hoch
 Streuwert 1.14, horizontal: 1.54, vertikal: 0.45

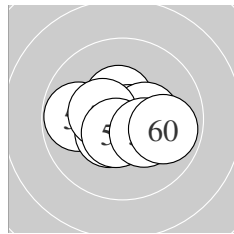

Serie 6:
 9.8 ← 10.6 * 10.5 * 10.5 * 10.8 *
 10.4 * 10.4 * 10.6 * 10.3 * 9.9 →
 beste Teiler 40.0 (55.) 76.1 (52.) 99.7 (58.)
 Trefferlage 0.03 mm rechts, 0.22 mm tief
 Streuwert 1.22, horizontal: 1.56, vertikal: 0.72

Meyton Elektronik

ISSF AR Men – Wertung – **Männer**

StandNr: 122

Kapil, Dev #387

StartNr: 67

20. Januar 2020 11:27

Indian Army

Unterschrift des Schützen

Meyton Elektronik

Ergebnis:	610.8	(583)
Serien:	102.6	104.2 101.1 102.0 99.8 101.1
Zähler:	43	17 0 0 0 0 0 0 0 0
Innenzehner:	36	
weiteste:	430	(21), 397 (44), 375 (40)
beste Teiler	7.0	(8.) 35.3 (58.) 68.6 (17.)
Trefferlage	0.08 mm	links, 0.60 mm hoch
Streuwert	1.49,	horizontal: 1.69, vertikal: 1.26

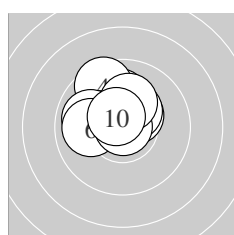
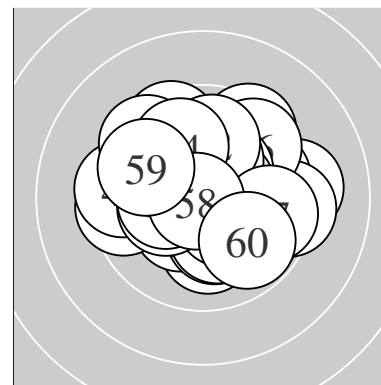

Serie 1:

10.4 *	10.0 ↑	10.6 *	9.6 ↖	9.9 ←
10.0 ←	10.4 *	10.9 *	10.2 *	10.6 *
beste Teiler	7.0 (8.)	95.5 (10.)	96.0 (3.)	
Trefferlage	0.46 mm	links, 1.19 mm	hoch	
Streuwert	1.14,	horizontal: 1.26,	vertikal: 1.00	

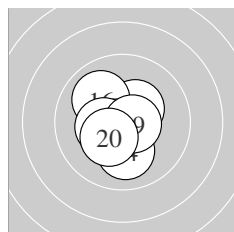

Serie 2:

10.6 *	10.6 *	10.4 *	10.1 ↓	10.5 *
10.0 ↘	10.7 *	10.4 *	10.6 *	10.3 *
beste Teiler	68.6 (17.)	77.2 (19.)	80.2 (11.)	
Trefferlage	0.26 mm	links, 0.03 mm	tief	
Streuwert	1.08,	horizontal: 1.03,	vertikal: 1.13	

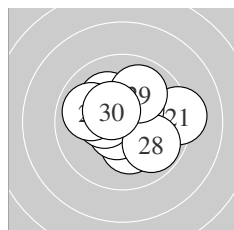

Serie 3:

9.2 →	10.2 *	10.6 *	10.1 ↖	10.4 *
10.4 *	9.9 ←	9.8 ↘	10.0 ↗	10.5 *
beste Teiler	79.3 (23.)	123.7 (30.)	133.6 (26.)	
Trefferlage	0.29 mm	rechts, 0.31 mm	hoch	
Streuwert	1.68,	horizontal: 1.98,	vertikal: 1.31	

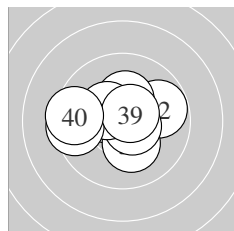

Serie 4:

10.7 *	9.8 →	10.4 *	10.2 *	10.6 *
10.3 *	10.4 *	9.5 ←	10.6 *	9.5 ←
beste Teiler	71.6 (31.)	83.4 (39.)	84.9 (35.)	
Trefferlage	0.52 mm	links, 0.30 mm	hoch	
Streuwert	1.58,	horizontal: 2.03,	vertikal: 0.93	

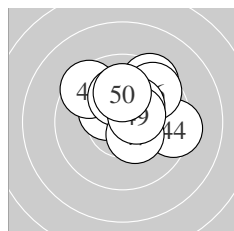

Serie 5:

10.4 *	9.5 ↖	10.2 *	9.4 →	9.5 ↗
9.6 ↗	10.4 *	10.3 *	10.5 *	10.0 ↑
beste Teiler	120.7 (49.)	135.7 (47.)	145.0 (41.)	
Trefferlage	0.71 mm	rechts, 1.33 mm	hoch	
Streuwert	1.63,	horizontal: 1.88,	vertikal: 1.34	

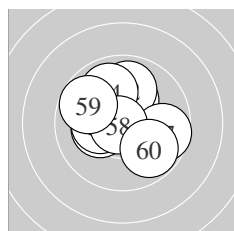

Serie 6:

10.2 *	9.9 ↑	10.5 *	9.9 ↖	10.2 *
10.3 *	9.7 →	10.8 *	9.8 ↖	9.8 ↘
beste Teiler	35.3 (58.)	111.1 (53.)	174.4 (56.)	
Trefferlage	0.25 mm	links, 0.48 mm	hoch	
Streuwert	1.64,	horizontal: 1.80,	vertikal: 1.47	

Meyton Elektronik

ISSF AR Men – Wertung – Männer

StandNr: 123

Davis, Michael #321

StartNr: 68

20. Januar 2020 11:50

AUS

Unterschrift des Schützen

Meyton Elektronik

Ergebnis:	620.6	(592)
Serien:	102.8	104.1 103.4 103.2 103.1 104.0
Zähler:	52	8 0 0 0 0 0 0 0 0
Innenzehner:	43	
weiteste:	325	(11), 310 (58), 284 (3)
beste Teiler	20.2	(31.) 26.9 (56.) 34.9 (20.)
Trefferlage	0.08	mm rechts, 0.07 mm hoch
Streuwert	1.22,	horizontal: 1.20, vertikal: 1.24

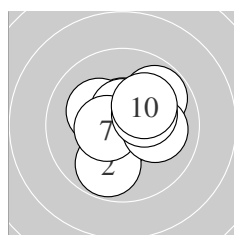
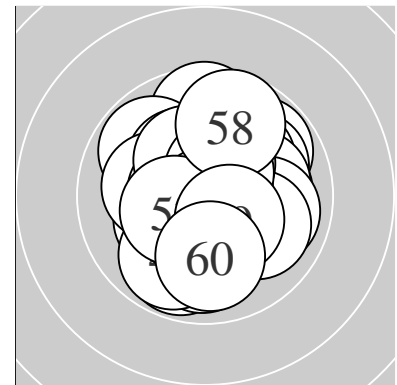

Serie 1:	10.7 *	9.8 ↘	9.8 ↗	10.6 *	10.2 *
	10.6 *	10.5 *	10.1 →	10.3 *	10.2 *
beste Teiler	70.8	(1.) 93.0 (6.) 98.0 (4.)			
Trefferlage	0.35	mm rechts, 0.29 mm hoch			
Streuwert	1.35,	horizontal: 1.40, vertikal: 1.30			

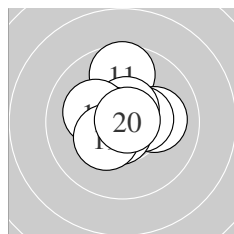

Serie 2:	9.7 ↑	10.1 →	10.5 *	10.6 *	10.6 *
	10.6 *	10.2 *	10.7 *	10.3 *	10.8 *
beste Teiler	34.9	(20.) 70.2 (18.) 89.5 (14.)			
Trefferlage	0.10	mm links, 0.35 mm hoch			
Streuwert	1.18,	horizontal: 1.19, vertikal: 1.17			

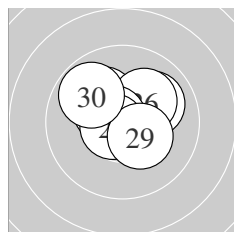

Serie 3:	10.4 *	10.5 *	10.1 ↖	10.8 *	10.0 ↗
	10.1 ↗	10.7 *	10.7 *	10.3 *	9.8 ↖
beste Teiler	38.2	(24.) 69.0 (27.) 73.4 (28.)			
Trefferlage	0.19	mm links, 0.71 mm hoch			
Streuwert	1.13,	horizontal: 1.33, vertikal: 0.88			

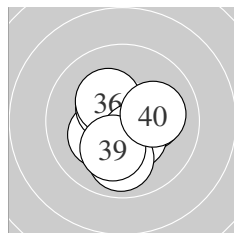

Serie 4:	10.9 *	10.2 *	10.4 *	10.6 *	10.2 *
	10.3 *	10.4 *	9.9 ↓	10.2 *	10.1 →
beste Teiler	20.2	(31.) 88.4 (34.) 128.4 (37.)			
Trefferlage	0.10	mm rechts, 0.38 mm tief			
Streuwert	1.22,	horizontal: 1.21, vertikal: 1.23			

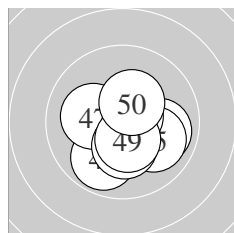

Serie 5:	10.6 *	10.7 *	9.9 ↘	9.9 →	10.0 ↘
	10.7 *	10.1 ←	10.3 *	10.5 *	10.4 *
beste Teiler	55.4	(42.) 65.2 (46.) 99.5 (41.)			
Trefferlage	0.41	mm rechts, 0.49 mm tief			
Streuwert	1.24,	horizontal: 1.34, vertikal: 1.13			

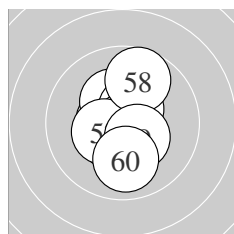

Serie 6:	10.5 *	10.6 *	10.8 *	10.3 *	10.5 *
	10.8 *	10.4 *	9.7 ↑	10.4 *	10.0 ↓
beste Teiler	26.9	(56.) 46.5 (53.) 95.3 (52.)			
Trefferlage	0.08	mm links, 0.01 mm tief			
Streuwert	1.20,	horizontal: 0.81, vertikal: 1.50			

Meyton Elektronik

ISSF AR Men – Wertung – Männer

StandNr: 124

Satyajeet, Khandil #379

StartNr: 69

20. Januar 2020 11:21

Indian Army

Unterschrift des Schützen

Meyton Elektronik

Ergebnis:	625.0	(594)
Serien:	103.8	104.5 105.1 103.6 105.1 102.9
Zähler:	54	6 0 0 0 0 0 0 0 0
Innenzehner:	53	
weiteste:	349	(32), 320 (2), 307 (19)
beste Teiler	41.9	(58.) 46.0 (46.) 50.1 (30.)
Trefferlage	0.18 mm	rechts, 0.35 mm hoch
Streuwert	1.05,	horizontal: 1.14, vertikal: 0.96

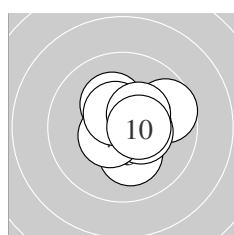
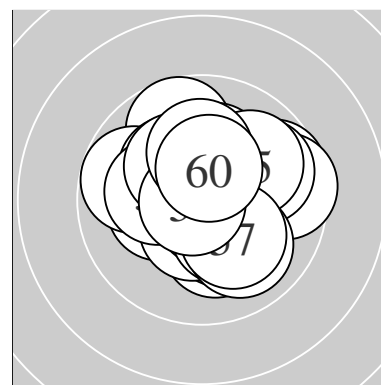

Serie 1:	10.7 *	9.7 →	10.2 *	10.7 *	10.2 *
	10.4 *	10.5 *	10.5 *	10.4 *	10.5 *
beste Teiler	55.4	(1.) 59.9 (4.)	105.9 (7.)		
Trefferlage	0.41 mm	rechts, 0.26 mm hoch			
Streuwert	1.13,	horizontal: 1.24, vertikal: 1.01			

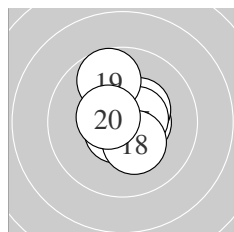

Serie 2:	10.5 *	10.7 *	10.5 *	10.4 *	10.6 *
	10.7 *	10.6 *	10.3 *	9.7 ↑	10.5 *
beste Teiler	64.4	(12.) 65.1 (16.)	76.0 (15.)		
Trefferlage	0.10 mm	rechts, 0.40 mm hoch			
Streuwert	1.01,	horizontal: 0.88, vertikal: 1.13			

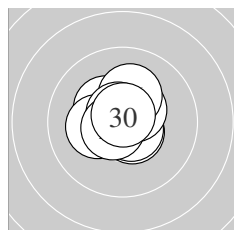

Serie 3:	10.6 *	10.3 *	10.6 *	10.6 *	10.5 *
	10.2 *	10.2 *	10.7 *	10.6 *	10.8 *
beste Teiler	50.1	(30.) 65.0 (28.)	78.8 (24.)		
Trefferlage	0.07 mm	links, 0.34 mm hoch			
Streuwert	0.85,	horizontal: 0.89, vertikal: 0.80			

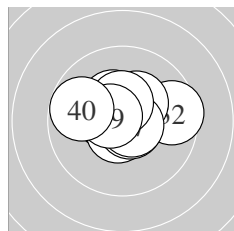

Serie 4:	10.5 *	9.6 →	10.4 *	10.3 *	10.6 *
	10.7 *	10.7 *	10.4 *	10.6 *	9.8 ←
beste Teiler	66.2	(36.) 69.4 (37.)	76.4 (35.)		
Trefferlage	0.03 mm	links, 0.45 mm hoch			
Streuwert	1.27,	horizontal: 1.64, vertikal: 0.74			

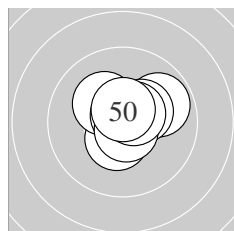

Serie 5:	9.9 →	10.7 *	10.4 *	10.5 *	10.2 *
	10.8 *	10.7 *	10.7 *	10.6 *	10.6 *
beste Teiler	46.0	(46.) 60.8 (48.)	63.1 (42.)		
Trefferlage	0.35 mm	rechts, 0.46 mm hoch			
Streuwert	0.89,	horizontal: 1.01, vertikal: 0.76			

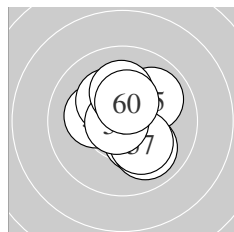

Serie 6:	10.3 *	10.0 ↘	10.7 *	10.2 *	9.9 →
	10.2 *	10.2 *	10.8 *	10.2 *	10.4 *
beste Teiler	41.9	(58.) 71.0 (53.)	136.1 (60.)		
Trefferlage	0.34 mm	rechts, 0.18 mm hoch			
Streuwert	1.30,	horizontal: 1.21, vertikal: 1.39			

Meyton Elektronik

ISSF AR Men – Wertung – **Männer**

StandNr: 125

Nikolaus, Blamauer #452

StartNr: 70

20. Januar 2020 11:24

OOE – ASKÖ Bad Goisern

Unterschrift des Schützen

Meyton Elektronik

Ergebnis: **625.9** (597)
 Serien: 104.0 103.9 104.7 103.6 104.0 105.7
 Zähler: 57 3 0 0 0 0 0 0 0 0
 Innenzehner: 50
 weiteste: 297 (48), 280 (34), 259 (4)
 beste Teiler 35.8 (51.) 37.2 (3.) 43.1 (53.)
 Trefferlage 0.00 mm , 0.09 mm hoch
 Streuwert 1.03, horizontal: 1.14, vertikal: 0.89

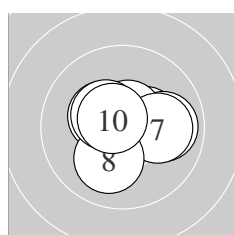
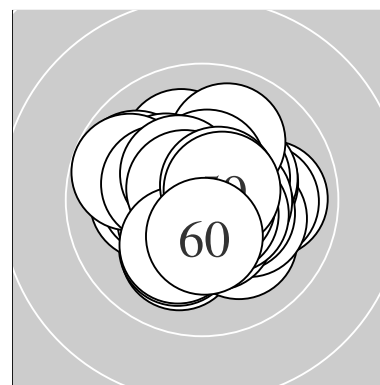

Serie 1:
 10.7 * 10.4 * 10.8 * 9.9 → 10.6 *
 10.4 * 10.1 → 10.1 ↓ 10.4 * 10.6 *
 beste Teiler 37.2 (3.) 57.4 (1.) 84.1 (5.)
 Trefferlage 0.21 mm rechts, 0.14 mm hoch
 Streuwert 1.15, horizontal: 1.41, vertikal: 0.82

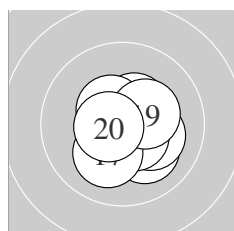

Serie 2:
 10.5 * 10.4 * 10.7 * 10.1 ↘ 10.2 *
 10.5 * 10.1 ↓ 10.5 * 10.3 * 10.6 *
 beste Teiler 65.0 (13.) 90.6 (20.) 106.0 (16.)
 Trefferlage 0.51 mm rechts, 0.14 mm tief
 Streuwert 1.03, horizontal: 1.02, vertikal: 1.03

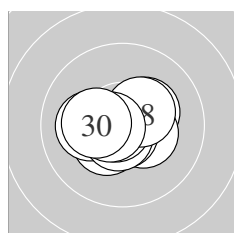

Serie 3:
 10.3 * 10.4 * 10.1 ← 10.4 * 10.7 *
 10.7 * 10.8 * 10.4 * 10.6 * 10.3 *
 beste Teiler 44.6 (27.) 53.0 (25.) 74.8 (26.)
 Trefferlage 0.23 mm links, 0.12 mm tief
 Streuwert 0.97, horizontal: 1.23, vertikal: 0.60

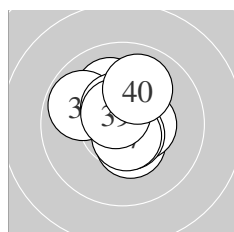

Serie 4:
 10.5 * 10.4 * 10.1 ↗ 9.8 ↖ 10.5 *
 10.6 * 10.6 * 10.5 * 10.6 * 10.0 ↗
 beste Teiler 79.0 (37.) 80.1 (39.) 81.5 (36.)
 Trefferlage 0.01 mm rechts, 0.44 mm hoch
 Streuwert 1.16, horizontal: 1.13, vertikal: 1.19

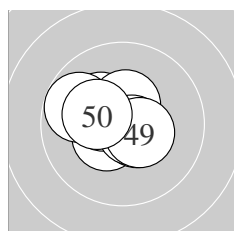

Serie 5:
 10.2 * 10.4 * 10.7 * 10.5 * 10.4 *
 10.5 * 10.7 * 9.8 ↖ 10.5 * 10.3 *
 beste Teiler 66.4 (43.) 70.7 (47.) 105.4 (44.)
 Trefferlage 0.55 mm links, 0.28 mm hoch
 Streuwert 1.05, horizontal: 1.26, vertikal: 0.77

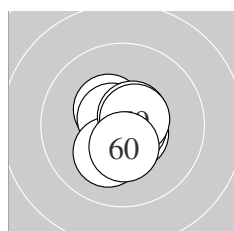

Serie 6:
 10.8 * 10.4 * 10.8 * 10.6 * 10.6 *
 10.7 * 10.2 * 10.6 * 10.6 * 10.4 *
 beste Teiler 35.8 (51.) 43.1 (53.) 60.4 (56.)
 Trefferlage 0.04 mm rechts, 0.07 mm tief
 Streuwert 0.79, horizontal: 0.66, vertikal: 0.90

Meyton Elektronik

ISSF AR Men – Wertung – **Männer**

StandNr: 126

Zott, Georg #47

StartNr: 71

20. Januar 2020 11:19

AUT

Unterschrift des Schützen

Meyton Elektronik

Ergebnis: **623.7** (596)
 Serien: 102.7 104.0 105.2 103.8 104.7 103.3
 Zähler: 56 4 0 0 0 0 0 0 0
 Innenzehner: 50
 weiteste: 297 (19), 289 (55), 281 (33)
 beste Teiler 7.2 (24.) 9.8 (36.) 41.2 (56.)
 Trefferlage 0.03 mm rechts, 0.21 mm hoch
 Streuwert 1.08, horizontal: 0.99, vertikal: 1.17

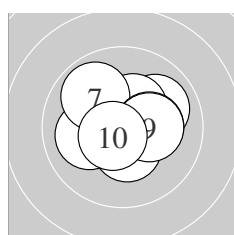
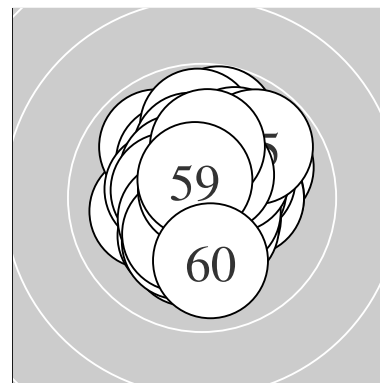

Serie 1:
 10.4 * 10.4 * 10.3 * 10.0 ↗ 10.4 *
 10.1 ← 9.9 ↘ 10.3 * 10.3 * 10.6 *
 beste Teiler 86.4 (10.) 135.3 (2.) 137.8 (1.)
 Trefferlage 0.23 mm rechts, 0.36 mm hoch
 Streuwert 1.32, horizontal: 1.55, vertikal: 1.04

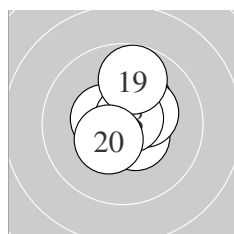

Serie 2:
 10.3 * 10.7 * 10.3 * 10.5 * 10.5 *
 10.5 * 10.3 * 10.7 * 9.8 ↑ 10.4 *
 beste Teiler 55.9 (18.) 72.4 (12.) 105.8 (14.)
 Trefferlage 0.20 mm rechts, 0.38 mm hoch
 Streuwert 1.09, horizontal: 0.94, vertikal: 1.21

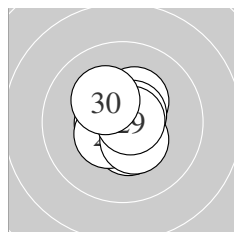

Serie 3:
 10.6 * 10.6 * 10.4 * 10.9 * 10.3 *
 10.6 * 10.5 * 10.4 * 10.7 * 10.2 *
 beste Teiler 7.2 (24.) 52.1 (29.) 78.4 (26.)
 Trefferlage 0.02 mm links, 0.07 mm tief
 Streuwert 0.85, horizontal: 0.74, vertikal: 0.95

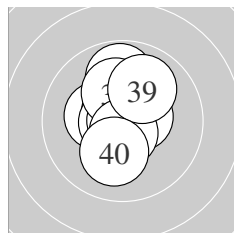

Serie 4:
 10.5 * 10.3 * 9.8 ↑ 10.7 * 10.7 *
 10.9 * 10.2 * 10.6 * 10.0 ↗ 10.1 ↓
 beste Teiler 9.8 (36.) 63.5 (35.) 72.8 (34.)
 Trefferlage 0.15 mm links, 0.51 mm hoch
 Streuwert 1.16, horizontal: 0.82, vertikal: 1.42

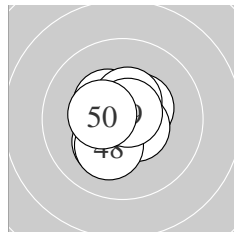

Serie 5:
 10.4 * 10.4 * 10.8 * 10.5 * 10.5 *
 10.2 * 10.6 * 10.2 * 10.7 * 10.4 *
 beste Teiler 42.0 (43.) 53.9 (49.) 98.4 (47.)
 Trefferlage 0.19 mm links, 0.08 mm tief
 Streuwert 0.95, horizontal: 0.88, vertikal: 1.00

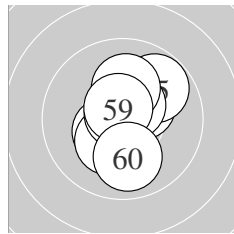

Serie 6:
 10.5 * 10.3 * 10.4 * 10.3 * 9.8 ↗
 10.8 * 10.5 * 10.1 ↑ 10.6 * 10.0 ↓
 beste Teiler 41.2 (56.) 77.2 (59.) 101.8 (51.)
 Trefferlage 0.12 mm rechts, 0.14 mm hoch
 Streuwert 1.25, horizontal: 0.98, vertikal: 1.46

Meyton Elektronik

ISSF AR Men – Wertung – **Männer**

StandNr: 127

Bamsey, Michael #423

StartNr: 72

20. Januar 2020 11:49

GBR

Unterschrift des Schützen

Meyton Elektronik

Ergebnis: **612.3** (585)
 Serien: 102.2 104.0 101.4 101.3 102.9 100.5
 Zähler: 47 11 2 0 0 0 0 0 0
 Innenzehner: 34
 weiteste: 596 (52), 543 (36), 342 (58)
 beste Teiler 20.5 (38.) 42.4 (55.) 63.0 (44.)
 Trefferlage 0.01 mm links, 0.32 mm hoch
 Streuwert 1.50, horizontal: 1.65, vertikal: 1.33

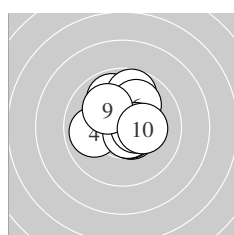
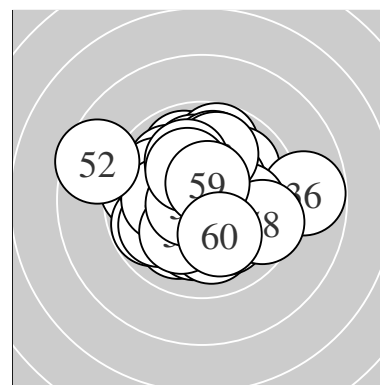

Serie 1:
 10.6 * 9.9 ↗ 9.7 ↑ 9.9 ← 10.6 *
 10.0 ↗ 10.7 * 10.5 * 10.1 ↘ 10.2 *
 beste Teiler 71.5 (7.) 82.8 (5.) 99.0 (1.)
 Trefferlage 0.20 mm rechts, 0.67 mm hoch
 Streuwert 1.39, horizontal: 1.35, vertikal: 1.42

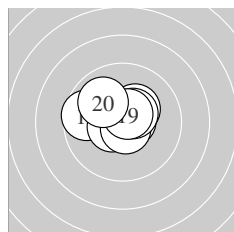

Serie 2:
 10.6 * 9.6 ← 10.4 * 10.6 * 10.7 *
 10.7 * 10.3 * 10.5 * 10.6 * 10.0 ↘
 beste Teiler 63.9 (16.) 73.4 (15.) 84.9 (19.)
 Trefferlage 0.42 mm links, 0.52 mm hoch
 Streuwert 1.10, horizontal: 1.37, vertikal: 0.72

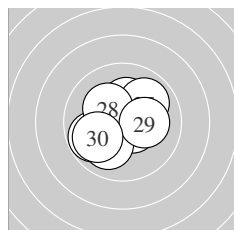

Serie 3:
 9.8 ← 10.2 * 10.5 * 10.5 * 10.2 *
 10.0 ↘ 9.9 ↗ 10.2 * 10.2 * 9.9 ←
 beste Teiler 101.7 (23.) 124.3 (24.) 176.1 (22.)
 Trefferlage 0.16 mm links, 0.09 mm hoch
 Streuwert 1.54, horizontal: 1.72, vertikal: 1.33

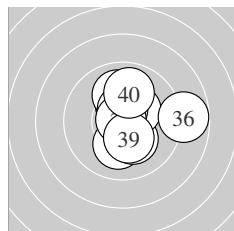

Serie 4:
 10.1 ↓ 10.2 * 10.3 * 10.3 * 10.0 ↑
 8.8 → 10.5 * 10.9 * 10.3 * 9.9 ↑
 beste Teiler 20.5 (38.) 102.0 (37.) 151.3 (33.)
 Trefferlage 0.74 mm rechts, 0.36 mm hoch
 Streuwert 1.68, horizontal: 1.74, vertikal: 1.62

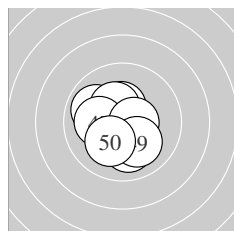

Serie 5:
 9.9 ↘ 10.4 * 10.6 * 10.7 * 10.0 ↓
 10.4 * 10.1 ← 10.6 * 10.1 ↓ 10.1 ↘
 beste Teiler 63.0 (44.) 76.8 (43.) 100.1 (48.)
 Trefferlage 0.34 mm links, 0.25 mm tief
 Streuwert 1.28, horizontal: 1.24, vertikal: 1.31

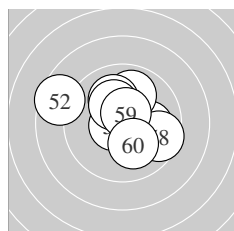

Serie 6:
 10.0 → 8.6 ↘ 9.9 ↑ 10.1 ↑ 10.8 *
 10.6 * 10.2 * 9.6 ↘ 10.6 * 10.1 ↓
 beste Teiler 42.4 (55.) 80.0 (56.) 94.5 (59.)
 Trefferlage 0.08 mm links, 0.53 mm hoch
 Streuwert 1.97, horizontal: 2.36, vertikal: 1.49

ISSF AR Men – Wertung – Männer

StandNr: 128

Eberhardt, Alexis #429

StartNr: 73

20. Januar 2020 11:50

ARG

Unterschrift des Schützen

Meyton Elektronik

Ergebnis:	626.8	(597) ^{QF}							
Serien:	104.4	105.1	103.8	104.2	104.6	104.7			
Zähler:	57	3	0	0	0	0	0	0	0
Innenzehner:	51								
weiteste:	322 (32), 289 (28), 253 (46)								
beste Teiler	7.0 (54.)	29.4 (55.)	44.2 (34.)						
Trefferlage	0.08 mm links, 0.06 mm hoch								
Streuwert	1.01, horizontal: 1.05, vertikal: 0.96								

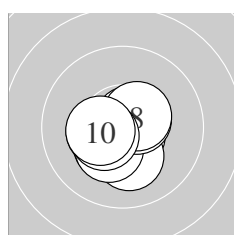
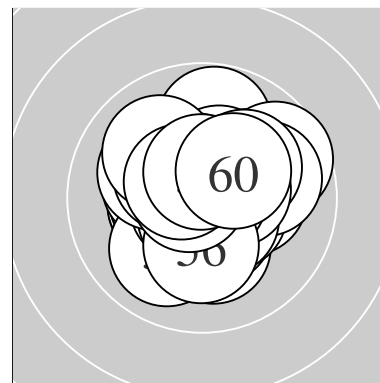

Serie 1:	10.7 *	10.7 *	10.4 *	10.3 *	10.2 *
	10.3 *	10.5 *	10.5 *	10.4 *	10.4 *
beste Teiler	57.9 (2.)	72.8 (1.)	104.2 (7.)		
Trefferlage	0.26 mm links, 0.43 mm tief				
Streuwert	0.92, horizontal: 0.99, vertikal: 0.84				

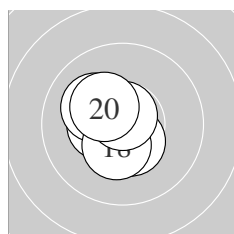

Serie 2:	10.7 *	10.8 *	10.5 *	10.4 *	10.7 *
	10.5 *	10.1 ↘	10.4 *	10.7 *	10.3 *
beste Teiler	50.3 (12.)	54.0 (19.)	57.3 (11.)		
Trefferlage	0.55 mm links, 0.18 mm tief				
Streuwert	0.81, horizontal: 0.70, vertikal: 0.90				

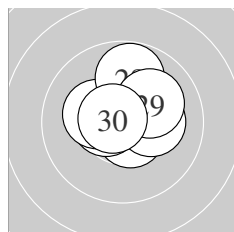

Serie 3:	10.6 *	10.6 *	10.2 *	10.6 *	10.5 *
	10.3 *	10.4 *	9.8 ↑	10.1 ↗	10.7 *
beste Teiler	68.9 (30.)	76.5 (24.)	80.0 (21.)		
Trefferlage	0.05 mm rechts, 0.61 mm hoch				
Streuwert	1.09, horizontal: 1.19, vertikal: 0.98				

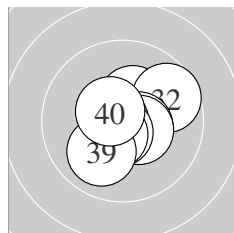

Serie 4:	10.4 *	9.7 ↗	10.5 *	10.8 *	10.5 *
	10.7 *	10.6 *	10.5 *	10.0 ↙	10.5 *
beste Teiler	44.2 (34.)	55.0 (36.)	77.8 (37.)		
Trefferlage	0.20 mm rechts, 0.14 mm tief				
Streuwert	1.15, horizontal: 1.23, vertikal: 1.06				

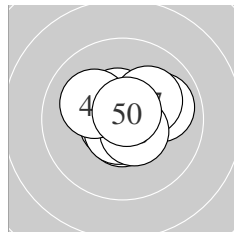

Serie 5:	10.8 *	10.6 *	10.7 *	10.5 *	10.7 *
	9.9 ↗	10.1 ↗	10.5 *	10.1 ↘	10.7 *
beste Teiler	48.1 (41.)	54.2 (50.)	63.9 (43.)		
Trefferlage	0.17 mm rechts, 0.15 mm hoch				
Streuwert	1.03, horizontal: 1.20, vertikal: 0.82				

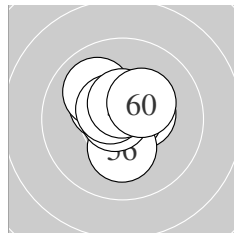

Serie 6:	10.3 *	10.5 *	10.0 ↘	10.9 *	10.8 *
	10.2 *	10.7 *	10.5 *	10.5 *	10.3 *
beste Teiler	7.0 (54.)	29.4 (55.)	51.9 (57.)		
Trefferlage	0.14 mm links, 0.40 mm hoch				
Streuwert	0.95, horizontal: 0.94, vertikal: 0.96				

ISSF AR Men – Wertung – Männer

StandNr: 129

Nepejchal, Filip #414

StartNr: 74

20. Januar 2020 11:22

CZE

QF – Schütze hat sich fürs Finale qualifiziert

Unterschrift des Schützen

Meyton Elektronik

Ergebnis: **620.0** (590)
 Serien: 104.1 104.3 103.8 101.8 101.8 104.2
 Zähler: 51 8 1 0 0 0 0 0 0
 Innenzehner: 42
 weiteste: 573 (38), 353 (44), 277 (3)
 beste Teiler 13.6 (60.) 47.0 (30.) 51.6 (8.)
 Trefferlage 0.40 mm rechts, 0.16 mm hoch
 Streuwert 1.25, horizontal: 1.43, vertikal: 1.03

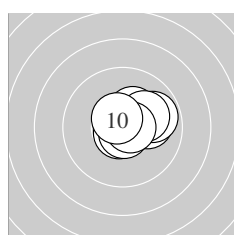
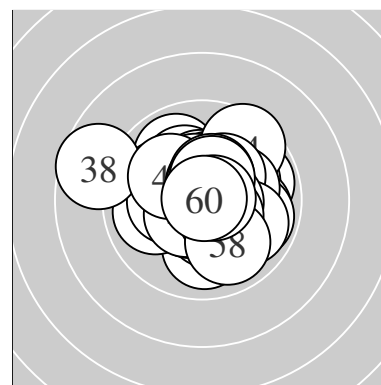

Serie 1:
 10.1 → 10.6 * 9.8 → 10.5 * 10.3 *
 10.7 * 10.1 → 10.7 * 10.7 * 10.6 *
 beste Teiler 51.6 (8.) 61.4 (6.) 68.0 (9.)
 Trefferlage 0.82 mm rechts, 0.47 mm hoch
 Streuwert 0.89, horizontal: 1.10, vertikal: 0.63

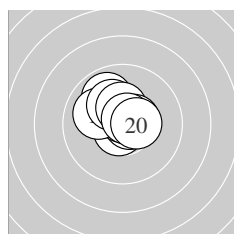

Serie 2:
 10.7 * 10.7 * 9.9 ↖ 10.7 * 10.0 ↖
 10.2 * 10.4 * 10.5 * 10.7 * 10.5 *
 beste Teiler 60.0 (12.) 61.2 (19.) 62.4 (11.)
 Trefferlage 0.17 mm links, 0.73 mm hoch
 Streuwert 0.96, horizontal: 1.05, vertikal: 0.86

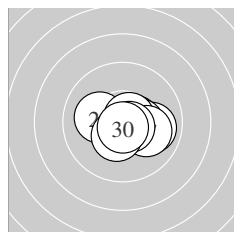

Serie 3:
 10.2 * 10.5 * 9.9 → 10.1 ← 10.4 *
 10.7 * 10.1 → 10.7 * 10.4 * 10.8 *
 beste Teiler 47.0 (30.) 66.8 (26.) 72.2 (28.)
 Trefferlage 0.74 mm rechts, 0.33 mm tief
 Streuwert 1.01, horizontal: 1.34, vertikal: 0.51

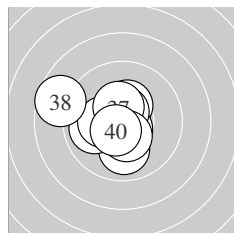

Serie 4:
 10.0 ↓ 10.4 * 9.9 ← 10.6 * 10.3 *
 10.6 * 10.4 * 8.7 ← 10.4 * 10.5 *
 beste Teiler 80.1 (34.) 81.3 (36.) 101.6 (40.)
 Trefferlage 0.92 mm links, 0.08 mm tief
 Streuwert 1.63, horizontal: 1.86, vertikal: 1.35

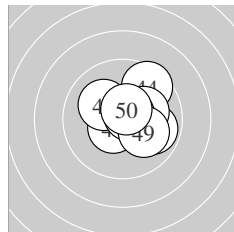

Serie 5:
 10.5 * 10.0 → 10.2 * 9.5 ↗ 9.9 →
 10.1 ↖ 10.2 * 10.7 * 10.1 → 10.6 *
 beste Teiler 66.7 (48.) 91.1 (50.) 111.8 (41.)
 Trefferlage 1.07 mm rechts, 0.15 mm hoch
 Streuwert 1.34, horizontal: 1.42, vertikal: 1.26

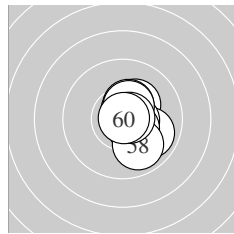

Serie 6:
 10.3 * 9.9 → 10.6 * 10.4 * 10.6 *
 10.5 * 10.4 * 9.9 ↘ 10.7 * 10.9 *
 beste Teiler 13.6 (60.) 58.8 (59.) 82.3 (55.)
 Trefferlage 0.88 mm rechts, 0.01 mm hoch
 Streuwert 0.93, horizontal: 0.63, vertikal: 1.16

Meyton Elektronik

ISSF AR Men – Wertung – **Männer**

StandNr: 130

Färber, Lars #427

StartNr: 75

20. Januar 2020 11:44

SUI

Unterschrift des Schützen

Meyton Elektronik

Ergebnis: **617.9** (593)
 Serien: 103.7 100.8 102.8 103.2 103.3 104.1
 Zähler: 53 7 0 0 0 0 0 0 0 0
 Innenzehner: 39
 weiteste: 361 (14), 329 (19), 303 (32)
 beste Teiler 4.4 (38.) 21.0 (37.) 32.0 (57.)
 Trefferlage 0.16 mm rechts, 0.07 mm hoch
 Streuwert 1.29, horizontal: 1.19, vertikal: 1.38

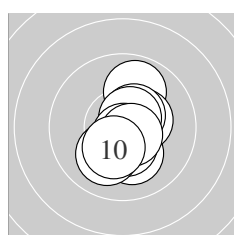
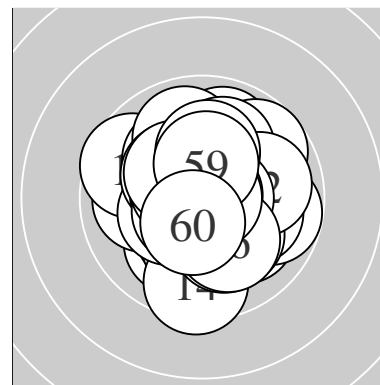

Serie 1:
 9.9 ↗ 10.2 * 10.4 * 10.4 * 10.1 ↘
 10.5 * 10.6 * 10.7 * 10.6 * 10.3 *
 beste Teiler 54.5 (8.) 82.1 (9.) 83.8 (7.)
 Trefferlage 0.34 mm rechts, 0.30 mm tief
 Streuwert 1.13, horizontal: 0.74, vertikal: 1.42

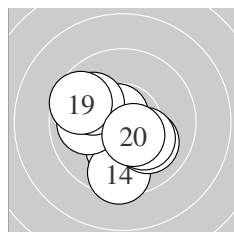

Serie 2:
 10.1 ↓ 10.7 * 10.2 * 9.5 ↓ 10.0 ↘
 10.2 * 10.0 ← 10.0 ↖ 9.6 ↖ 10.5 *
 beste Teiler 63.4 (12.) 119.9 (20.) 190.2 (13.)
 Trefferlage 0.45 mm links, 0.79 mm tief
 Streuwert 1.61, horizontal: 1.63, vertikal: 1.59

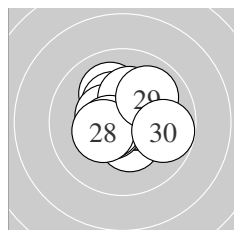

Serie 3:
 10.1 ↖ 10.4 * 10.3 * 10.5 * 10.6 *
 10.2 * 10.6 * 10.3 * 10.0 ↗ 9.8 →
 beste Teiler 88.5 (25.) 97.1 (27.) 124.7 (24.)
 Trefferlage 0.01 mm links, 0.40 mm hoch
 Streuwert 1.32, horizontal: 1.41, vertikal: 1.22

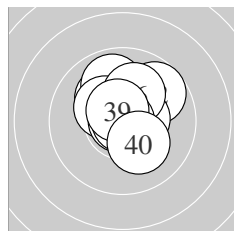

Serie 4:
 10.1 ↖ 9.7 ↗ 10.5 * 9.9 ↗ 10.3 *
 10.1 ↗ 10.9 * 10.9 * 10.6 * 10.2 *
 beste Teiler 4.4 (38.) 21.0 (37.) 84.5 (39.)
 Trefferlage 0.16 mm rechts, 0.84 mm hoch
 Streuwert 1.19, horizontal: 1.15, vertikal: 1.23

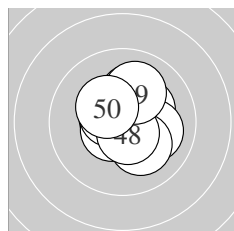

Serie 5:
 10.6 * 10.2 * 10.2 * 10.6 * 10.1 →
 10.1 ↘ 10.6 * 10.6 * 10.0 ↗ 10.3 *
 beste Teiler 87.3 (41.) 87.6 (48.) 95.2 (44.)
 Trefferlage 0.31 mm rechts, 0.30 mm hoch
 Streuwert 1.18, horizontal: 1.15, vertikal: 1.20

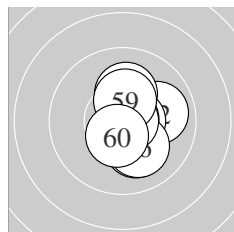

Serie 6:
 10.7 * 9.9 → 10.1 ↘ 10.6 * 10.8 *
 10.1 ↘ 10.8 * 10.2 * 10.4 * 10.5 *
 beste Teiler 32.0 (57.) 37.0 (55.) 62.6 (51.)
 Trefferlage 0.64 mm rechts, 0.00 mm
 Streuwert 1.04, horizontal: 0.77, vertikal: 1.26

Meyton Elektronik

ISSF AR Men – Wertung – Männer

StandNr: 131

Bargeron,, Michael #453

StartNr: 76

20. Januar 2020 11:50

GBR

Unterschrift des Schützen

Meyton Elektronik

Ergebnis: **627.1** (598)^{QF}
 Serien: 103.7 105.1 104.4 104.8 104.5 104.6
 Zähler: 58 2 0 0 0 0 0 0 0
 Innenzehner: 51
 weiteste: 274 (1), 251 (22), 231 (2)
 beste Teiler 11.6 (19.) 20.1 (7.) 29.9 (41.)
 Trefferlage 0.08 mm links, 0.04 mm tief
 Streuwert 0.98, horizontal: 1.06, vertikal: 0.89

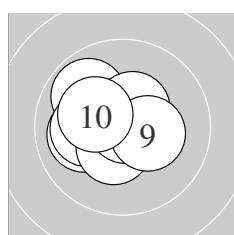
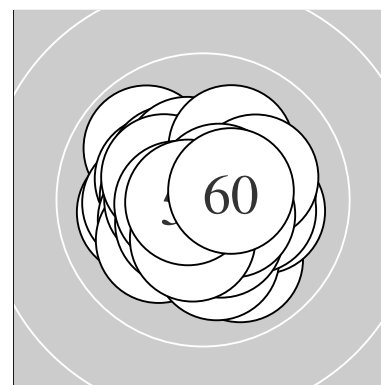

Serie 1:
 9.9 ↘ 10.0 ← 10.7 * 10.1 ← 10.7 *
 10.4 * 10.9 * 10.5 * 10.3 * 10.2 *
 beste Teiler 20.1 (7.) 51.6 (3.) 75.1 (5.)
 Trefferlage 0.69 mm links, 0.27 mm hoch
 Streuwert 1.09, horizontal: 1.27, vertikal: 0.87

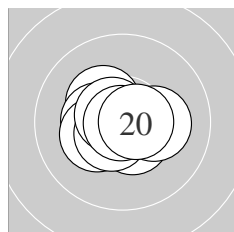

Serie 2:
 10.7 * 10.5 * 10.3 * 10.4 * 10.3 *
 10.6 * 10.2 * 10.6 * 10.9 * 10.6 *
 beste Teiler 11.6 (19.) 75.0 (11.) 76.2 (18.)
 Trefferlage 0.30 mm links, 0.07 mm tief
 Streuwert 0.88, horizontal: 1.09, vertikal: 0.60

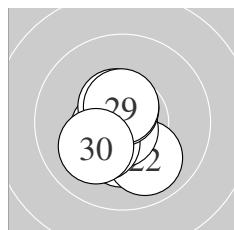

Serie 3:
 10.3 * 9.9 ↘ 10.7 * 10.6 * 10.8 *
 10.3 * 10.6 * 10.5 * 10.6 * 10.1 ↙
 beste Teiler 47.5 (25.) 63.6 (23.) 80.5 (27.)
 Trefferlage 0.34 mm links, 0.41 mm tief
 Streuwert 0.99, horizontal: 0.79, vertikal: 1.16

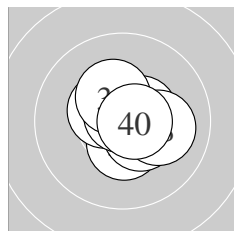

Serie 4:
 10.6 * 10.4 * 10.5 * 10.5 * 10.4 *
 10.8 * 10.5 * 10.1 → 10.3 * 10.7 *
 beste Teiler 36.8 (36.) 72.0 (40.) 81.2 (31.)
 Trefferlage 0.30 mm rechts, 0.06 mm hoch
 Streuwert 0.90, horizontal: 0.94, vertikal: 0.87

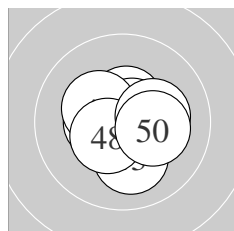

Serie 5:
 10.8 * 10.8 * 10.1 ↓ 10.5 * 10.7 *
 10.4 * 10.3 * 10.5 * 10.2 * 10.2 *
 beste Teiler 29.9 (41.) 50.0 (42.) 67.1 (45.)
 Trefferlage 0.13 mm rechts, 0.08 mm tief
 Streuwert 1.02, horizontal: 1.12, vertikal: 0.91

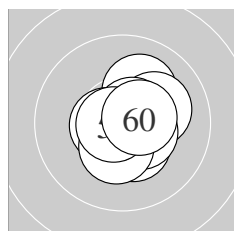

Serie 6:
 10.1 ↗ 10.4 * 10.6 * 10.1 → 10.5 *
 10.6 * 10.7 * 10.4 * 10.7 * 10.5 *
 beste Teiler 54.7 (59.) 74.5 (57.) 81.6 (53.)
 Trefferlage 0.36 mm rechts, 0.04 mm tief
 Streuwert 0.95, horizontal: 0.93, vertikal: 0.97

Meyton Elektronik

ISSF AR Men – Wertung – Männer

StandNr: 132

Franz, Sebastian #406

StartNr: 77

20. Januar 2020 11:45

GER

QF – Schütze hat sich fürs Finale qualifiziert

Unterschrift des Schützen

Meyton Elektronik

Ergebnis:	629.4	(600) ^{QF}					
Serien:	104.9	104.6	105.0	104.1	105.2	105.6	
Zähler:	60	0	0	0	0	0	0
Innenzehner:	58						
weiteste:	226 (46), 224 (13), 200 (41)						
beste Teiler	48.1 (52.) 50.3 (25.) 51.4 (22.)						
Trefferlage	0.20 mm rechts, 0.03 mm hoch						
Streuwert	0.88, horizontal: 0.96, vertikal: 0.78						

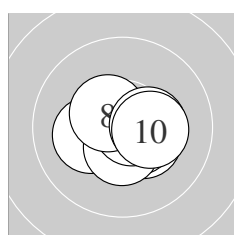
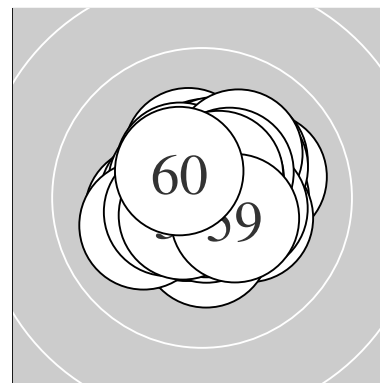

Serie 1:					
	10.4 *	10.6 *	10.2 *	10.7 *	10.6 *
	10.5 *	10.7 *	10.5 *	10.4 *	10.3 *
beste Teiler	54.0 (7.) 66.0 (4.) 97.7 (5.)				
Trefferlage	0.44 mm rechts, 0.26 mm tief				
Streuwert	0.86, horizontal: 1.09, vertikal: 0.53				

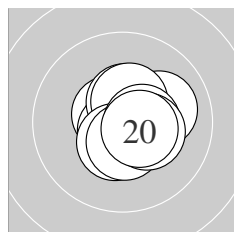

Serie 2:					
	10.6 *	10.7 *	10.1 →	10.5 *	10.4 *
	10.5 *	10.5 *	10.5 *	10.3 *	10.5 *
beste Teiler	61.0 (12.) 86.2 (11.) 106.4 (20.)				
Trefferlage	0.47 mm rechts, 0.01 mm tief				
Streuwert	0.90, horizontal: 0.92, vertikal: 0.87				

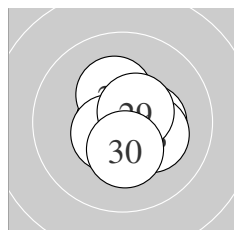

Serie 3:					
	10.6 *	10.7 *	10.4 *	10.3 *	10.8 *
	10.6 *	10.5 *	10.2 *	10.6 *	10.3 *
beste Teiler	50.3 (25.) 51.4 (22.) 78.3 (21.)				
Trefferlage	0.32 mm rechts, 0.14 mm tief				
Streuwert	0.86, horizontal: 0.83, vertikal: 0.89				

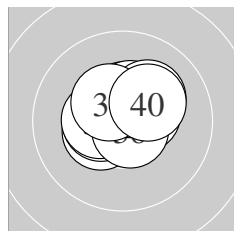

Serie 4:					
	10.4 *	10.5 *	10.4 *	10.4 *	10.5 *
	10.7 *	10.4 *	10.2 *	10.4 *	10.2 *
beste Teiler	65.8 (36.) 121.4 (35.) 122.4 (32.)				
Trefferlage	0.04 mm rechts, 0.52 mm hoch				
Streuwert	0.96, horizontal: 1.13, vertikal: 0.76				

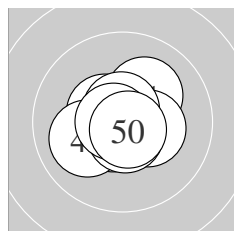

Serie 5:					
	10.2 *	10.7 *	10.4 *	10.5 *	10.6 *
	10.0 ←	10.7 *	10.7 *	10.7 *	10.7 *
beste Teiler	53.0 (49.) 53.8 (50.) 68.5 (47.)				
Trefferlage	0.05 mm links, 0.08 mm tief				
Streuwert	0.93, horizontal: 1.05, vertikal: 0.78				

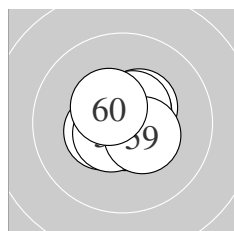

Serie 6:					
	10.4 *	10.8 *	10.7 *	10.6 *	10.6 *
	10.6 *	10.4 *	10.6 *	10.4 *	10.5 *
beste Teiler	48.1 (52.) 55.3 (53.) 89.8 (55.)				
Trefferlage	0.03 mm rechts, 0.18 mm hoch				
Streuwert	0.76, horizontal: 0.83, vertikal: 0.69				

Meyton Elektronik

ISSF AR Men – Wertung – Männer

StandNr: 133

Deepak, Kumar #454

StartNr: 78

20. Januar 2020 11:41

IND

QF – Schütze hat sich fürs Finale qualifiziert

Unterschrift des Schützen

Meyton Elektronik

Ergebnis:	622.8	(596)							
Serien:	104.0	103.6	104.1	103.2	104.5	103.4			
Zähler:	56	4	0	0	0	0	0	0	0
Innenzehner:	51								
weiteste:	323 (15),	262 (40),	257 (17)						
beste Teiler	15.0 (20.)	15.6 (26.)	36.0 (43.)						
Trefferlage	0.37 mm links, 0.39 mm hoch								
Streuwert	1.06, horizontal: 1.13, vertikal: 1.00								

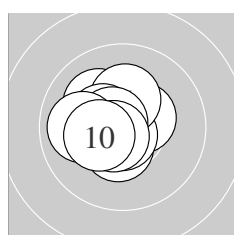
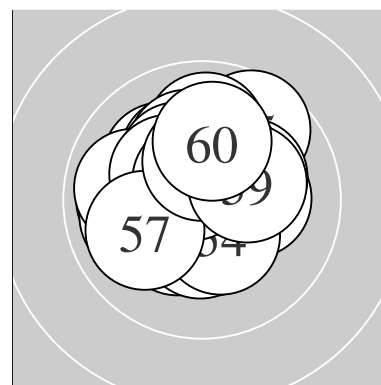

Serie 1:	10.5 *	10.4 *	10.1 ↘	10.8 *	10.3 *
	10.4 *	10.7 *	9.9 ←	10.6 *	10.3 *
beste Teiler	49.2 (4.) 72.0 (7.) 80.6 (9.)				
Trefferlage	0.70 mm links, 0.17 mm hoch				
Streuwert	0.98, horizontal: 1.03, vertikal: 0.93				

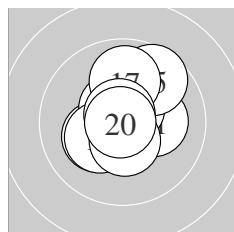

Serie 2:	10.2 *	10.2 *	10.6 *	10.6 *	9.7 ↗
	10.3 *	9.9 ↑	10.7 *	10.5 *	10.9 *
beste Teiler	15.0 (20.) 52.9 (18.) 99.6 (13.)				
Trefferlage	0.05 mm rechts, 0.45 mm hoch				
Streuwert	1.26, horizontal: 1.16, vertikal: 1.35				

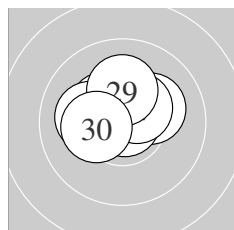

Serie 3:	10.3 *	10.2 *	10.8 *	10.5 *	10.4 *
	10.9 *	10.4 *	10.1 ←	10.2 *	10.3 *
beste Teiler	15.6 (26.) 46.0 (23.) 101.6 (24.)				
Trefferlage	0.16 mm links, 0.63 mm hoch				
Streuwert	1.01, horizontal: 1.28, vertikal: 0.63				

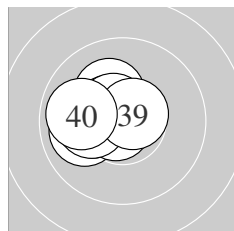

Serie 4:	10.0 ←	10.2 *	10.2 *	10.2 *	10.5 *
	10.6 *	10.8 *	10.2 *	10.6 *	9.9 ←
beste Teiler	48.8 (37.) 78.2 (39.) 95.6 (36.)				
Trefferlage	1.24 mm links, 0.37 mm hoch				
Streuwert	0.85, horizontal: 1.00, vertikal: 0.66				

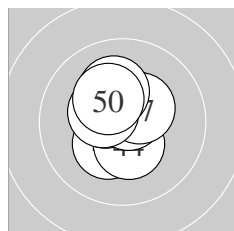

Serie 5:	10.3 *	10.5 *	10.8 *	10.4 *	10.5 *
	10.7 *	10.4 *	10.2 *	10.4 *	10.3 *
beste Teiler	36.0 (43.) 59.0 (46.) 115.0 (42.)				
Trefferlage	0.21 mm links, 0.39 mm hoch				
Streuwert	0.96, horizontal: 0.80, vertikal: 1.10				

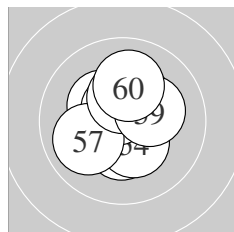

Serie 6:	10.4 *	10.7 *	10.3 *	10.4 *	10.6 *
	10.3 *	10.0 ←	10.4 *	10.2 *	10.1 ↑
beste Teiler	67.4 (52.) 81.8 (55.) 146.0 (58.)				
Trefferlage	0.03 mm rechts, 0.32 mm hoch				
Streuwert	1.20, horizontal: 1.11, vertikal: 1.29				

ISSF AR Men – Wertung – **Männer**

StandNr: 134

Nymbursky, Petr #28

StartNr: 79

20. Januar 2020 11:36

CZE

Unterschrift des Schützen

Meyton Elektronik

Ergebnis: **625.1** (593)
 Serien: 105.2 103.5 104.8 105.1 102.2 104.3
 Zähler: 53 7 0 0 0 0 0 0 0
 Innenzehner: 49
 weiteste: 342 (11), 306 (45), 301 (19)
 beste Teiler 8.2 (9.) 43.7 (52.) 44.6 (24.)
 Trefferlage 0.17 mm links, 0.47 mm hoch
 Streuwert 1.04, horizontal: 0.97, vertikal: 1.11

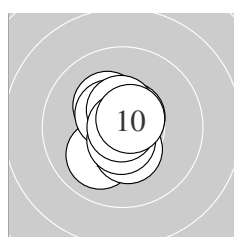
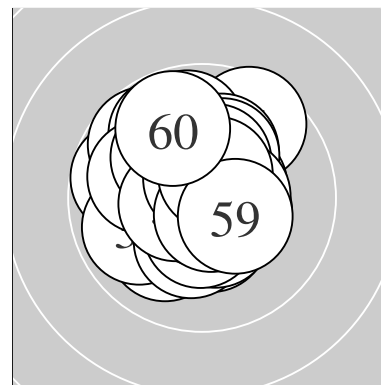

Serie 1:
 10.0 ↘ 10.4 * 10.3 * 10.7 * 10.6 *
 10.5 * 10.6 * 10.5 * 10.9 * 10.7 *
 beste Teiler 8.2 (9.) 54.9 (4.) 73.5 (10.)
 Trefferlage 0.25 mm links, 0.09 mm hoch
 Streuwert 0.91, horizontal: 0.66, vertikal: 1.10

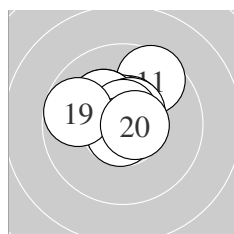

Serie 2:
 9.6 ↗ 10.6 * 10.2 * 10.6 * 10.2 *
 10.6 * 10.7 * 10.7 * 9.7 ← 10.6 *
 beste Teiler 53.1 (18.) 67.1 (17.) 80.2 (20.)
 Trefferlage 0.20 mm links, 0.91 mm hoch
 Streuwert 1.13, horizontal: 1.32, vertikal: 0.90

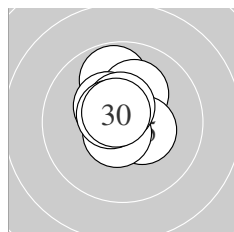

Serie 3:
 9.8 ↑ 10.8 * 10.2 * 10.8 * 10.4 *
 10.4 * 10.6 * 10.5 * 10.6 * 10.7 *
 beste Teiler 44.6 (24.) 49.4 (22.) 75.4 (30.)
 Trefferlage 0.03 mm links, 0.63 mm hoch
 Streuwert 0.92, horizontal: 0.73, vertikal: 1.08

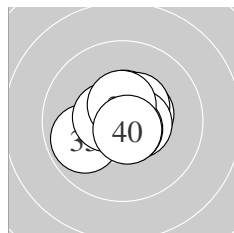

Serie 4:
 10.5 * 10.5 * 10.5 * 10.6 * 9.9 ↙
 10.7 * 10.7 * 10.5 * 10.5 * 10.7 *
 beste Teiler 63.0 (37.) 63.6 (36.) 64.0 (40.)
 Trefferlage 0.00 mm , 0.20 mm hoch
 Streuwert 0.93, horizontal: 1.07, vertikal: 0.77

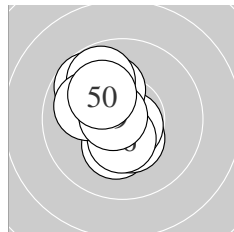

Serie 5:
 10.3 * 10.4 * 10.7 * 10.1 ↗ 9.7 ↖
 10.4 * 9.8 ↘ 10.0 ← 10.7 * 10.1 ↖
 beste Teiler 58.7 (43.) 64.8 (49.) 128.1 (46.)
 Trefferlage 0.81 mm links, 0.44 mm hoch
 Streuwert 1.30, horizontal: 0.98, vertikal: 1.56

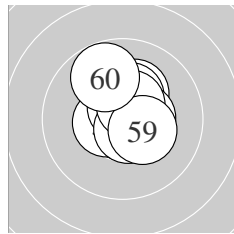

Serie 6:
 10.2 * 10.8 * 10.3 * 10.5 * 10.5 *
 10.6 * 10.7 * 10.5 * 10.4 * 9.8 ↘
 beste Teiler 43.7 (52.) 74.3 (57.) 76.2 (56.)
 Trefferlage 0.23 mm rechts, 0.55 mm hoch
 Streuwert 1.00, horizontal: 0.83, vertikal: 1.14

Meyton Elektronik

ISSF AR Men – Wertung – Männer

StandNr: 135

Thum, Andreas #45

StartNr: 80

20. Januar 2020 11:44

AUT

Unterschrift des Schützen

Meyton Elektronik

Ergebnis: **628.3** (597)^{QF}
 Serien: 104.7 104.8 105.7 104.9 104.2 104.0
 Zähler: 57 3 0 0 0 0 0 0 0 0
 Innenzehner: 53
 weiteste: 285 (13), 281 (53), 257 (59)
 beste Teiler 18.0 (58.) 21.9 (9.) 24.2 (51.)
 Trefferlage 0.14 mm links, 0.19 mm hoch
 Streuwert 0.95, horizontal: 1.06, vertikal: 0.84

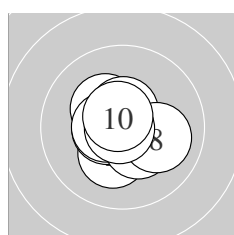
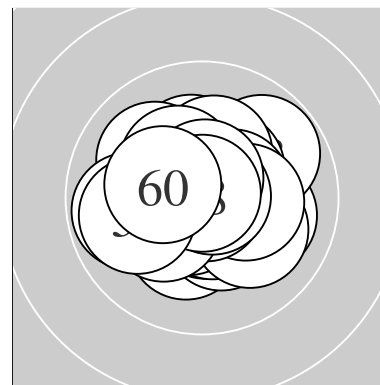

Serie 1:
 10.6 * 10.2 * 10.3 * 10.5 * 10.6 *
 10.5 * 10.4 * 10.0 ↘ 10.9 * 10.7 *
 beste Teiler 21.9 (9.) 75.6 (10.) 90.0 (1.)
 Trefferlage 0.02 mm links, 0.12 mm tief
 Streuwert 0.98, horizontal: 1.06, vertikal: 0.90

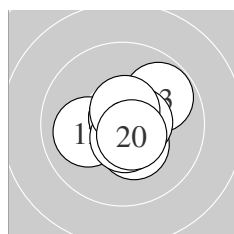

Serie 2:
 10.6 * 10.0 ← 9.8 ↗ 10.8 * 10.4 *
 10.8 * 10.6 * 10.6 * 10.6 * 10.6 *
 beste Teiler 40.6 (16.) 42.7 (14.) 87.2 (18.)
 Trefferlage 0.34 mm rechts, 0.04 mm tief
 Streuwert 1.02, horizontal: 1.12, vertikal: 0.92

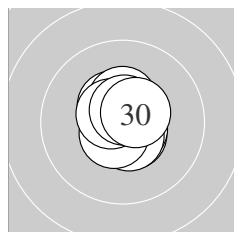

Serie 3:
 10.7 * 10.6 * 10.5 * 10.6 * 10.6 *
 10.4 * 10.6 * 10.6 * 10.6 * 10.5 *
 beste Teiler 62.8 (21.) 76.2 (24.) 77.7 (29.)
 Trefferlage 0.02 mm rechts, 0.19 mm hoch
 Streuwert 0.71, horizontal: 0.58, vertikal: 0.82

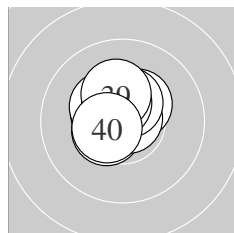

Serie 4:
 10.6 * 10.4 * 10.5 * 10.5 * 10.4 *
 10.8 * 10.5 * 10.5 * 10.2 * 10.5 *
 beste Teiler 35.3 (36.) 76.0 (31.) 108.8 (40.)
 Trefferlage 0.35 mm links, 0.65 mm hoch
 Streuwert 0.74, horizontal: 0.73, vertikal: 0.74

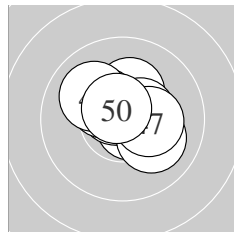

Serie 5:
 10.7 * 10.7 * 10.3 * 10.5 * 10.7 *
 10.1 ↘ 10.3 * 10.3 * 10.0 ↘ 10.6 *
 beste Teiler 57.4 (42.) 65.8 (41.) 75.9 (45.)
 Trefferlage 0.16 mm rechts, 0.46 mm hoch
 Streuwert 1.04, horizontal: 1.20, vertikal: 0.87

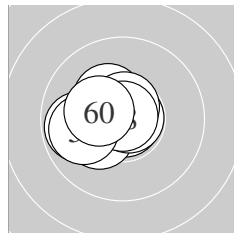

Serie 6:
 10.9 * 10.2 * 9.8 ← 10.8 * 10.3 *
 10.3 * 10.6 * 10.9 * 9.9 ← 10.3 *
 beste Teiler 18.0 (58.) 24.2 (51.) 40.6 (54.)
 Trefferlage 1.02 mm links, 0.05 mm hoch
 Streuwert 0.95, horizontal: 1.15, vertikal: 0.69

Meyton Elektronik

ISSF AR Men – Wertung – **Männer**

StandNr: 136

Sampson, Dane #413

StartNr: 81

20. Januar 2020 11:41

AUS

QF – Schütze hat sich fürs Finale qualifiziert

Unterschrift des Schützen

Meyton Elektronik

Ergebnis:	606.7	(581)
Serien:	101.3	103.1 100.6 102.7 99.8 99.2
Zähler:	43	15 2 0 0 0 0 0 0 0
Innenzehner:	30	
weiteste:	663 (46), 656 (52), 451 (4)	
beste Teiler	14.7 (40.)	16.6 (6.) 54.4 (48.)
Trefferlage	0.32 mm rechts,	0.09 mm hoch
Streuwert	1.69,	horizontal: 1.96, vertikal: 1.38

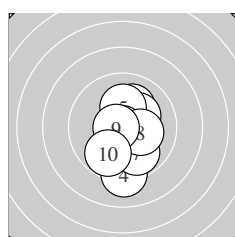

Serie 1:	10.1 ↗	10.3 *	10.2 *	9.1 ↓	10.2 *
	10.9 *	9.8 ↘	10.2 *	10.7 *	9.8 ↙
beste Teiler	16.6 (6.)	63.0 (9.)	154.4 (2.)		
Trefferlage	0.47 mm rechts, 0.41 mm tief				
Streuwert	1.67, horizontal: 1.03, vertikal: 2.12				

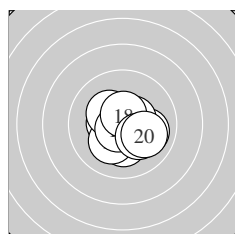

Serie 2:	10.0 →	10.4 *	10.2 *	10.5 *	10.2 *
	10.3 *	10.7 *	10.6 *	10.2 *	10.0 →
beste Teiler	62.9 (17.)	94.4 (18.)	111.8 (14.)		
Trefferlage	0.30 mm rechts, 0.42 mm tief				
Streuwert	1.21, horizontal: 1.36, vertikal: 1.03				

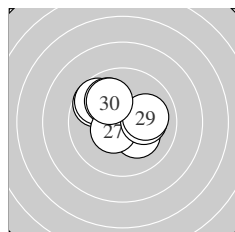

Serie 3:	9.9 ↘	10.2 *	9.7 ↖	10.5 *	9.7 ↖
	10.0 ↘	10.5 *	10.1 →	10.0 →	10.0 ↘
beste Teiler	115.5 (27.)	119.8 (24.)	187.0 (22.)		
Trefferlage	0.57 mm links, 0.90 mm hoch				
Streuwert	1.54, horizontal: 1.80, vertikal: 1.24				

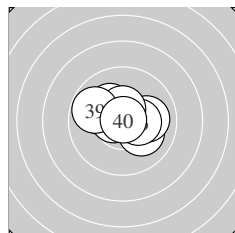

Serie 4:	10.1 ↘	10.3 *	10.0 ↖	10.0 →	10.2 *
	10.3 *	10.6 *	10.5 *	9.8 ↖	10.9 *
beste Teiler	14.7 (40.)	87.1 (37.)	117.0 (38.)		
Trefferlage	0.24 mm links, 0.47 mm hoch				
Streuwert	1.32, horizontal: 1.70, vertikal: 0.77				

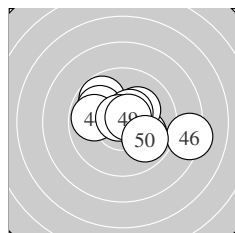

Serie 5:	9.8 ↘	10.0 →	9.9 ↖	9.8 ←	10.2 *
	8.3 →	10.5 *	10.7 *	10.7 *	9.9 ↘
beste Teiler	54.4 (48.)	70.2 (49.)	115.6 (47.)		
Trefferlage	0.60 mm rechts, 0.27 mm hoch				
Streuwert	2.12, horizontal: 2.72, vertikal: 1.26				

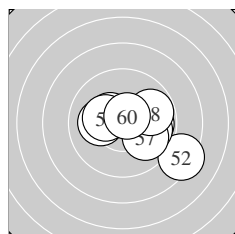

Serie 6:	10.4 *	8.3 ↘	9.9 →	10.1 ←	10.0 →
	9.9 →	9.9 ↘	9.8 →	10.3 *	10.6 *
beste Teiler	80.4 (60.)	138.9 (51.)	172.1 (59.)		
Trefferlage	1.38 mm rechts, 0.25 mm tief				
Streuwert	1.96, horizontal: 2.45, vertikal: 1.28				

Meyton Elektronik

ISSF AR Men – Wertung – **Männer**

StandNr: 137

Köppel, Michael #455

StartNr: 82

20. Januar 2020 11:44

SUI–Sportschützen Sargans

Unterschrift des Schützen

Meyton Elektronik

Ergebnis: **622.0** (596)
 Serien: 103.9 102.9 103.9 103.7 104.4 103.2
 Zähler: 56 4 0 0 0 0 0 0 0
 Innenzehner: 47
 weiteste: 429 (60), 332 (30), 294 (39)
 beste Teiler 14.3 (9.) 33.1 (57.) 37.0 (24.)
 Trefferlage 0.35 mm links, 0.23 mm hoch
 Streuwert 1.14, horizontal: 1.11, vertikal: 1.16

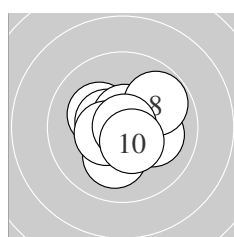
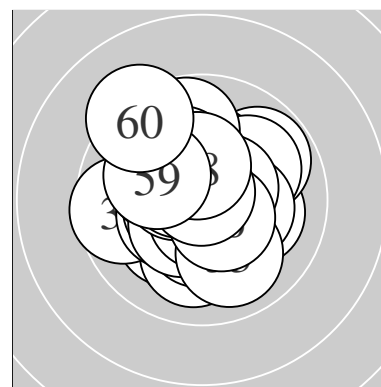

Serie 1:
 10.6 * 10.2 * 10.5 * 10.1 ↓ 10.1 →
 10.7 * 10.5 * 9.8 ↗ 10.9 * 10.5 *
 beste Teiler 14.3 (9.) 75.3 (6.) 92.0 (1.)
 Trefferlage 0.02 mm rechts, 0.08 mm tief
 Streuwert 1.20, horizontal: 1.33, vertikal: 1.05

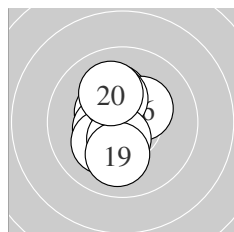

Serie 2:
 10.2 * 10.5 * 10.4 * 10.4 * 10.2 *
 10.3 * 10.3 * 10.5 * 10.0 ↓ 10.1 ↖
 beste Teiler 117.9 (18.) 122.7 (12.) 131.5 (13.)
 Trefferlage 0.51 mm links, 0.30 mm hoch
 Streuwert 1.18, horizontal: 0.75, vertikal: 1.50

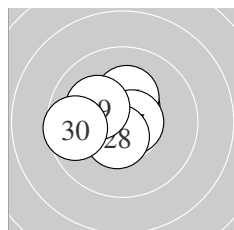

Serie 3:
 10.2 * 10.8 * 10.4 * 10.8 * 10.5 *
 10.3 * 10.7 * 10.5 * 10.1 ↖ 9.6 ←
 beste Teiler 37.0 (24.) 41.0 (22.) 62.0 (27.)
 Trefferlage 0.73 mm links, 0.28 mm hoch
 Streuwert 1.07, horizontal: 1.27, vertikal: 0.81

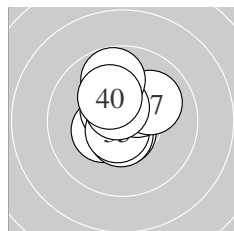

Serie 4:
 10.6 * 10.4 * 10.6 * 10.5 * 10.7 *
 10.4 * 10.0 ↗ 10.5 * 9.8 ↑ 10.2 *
 beste Teiler 75.1 (35.) 79.5 (31.) 94.7 (33.)
 Trefferlage 0.14 mm links, 0.56 mm hoch
 Streuwert 1.13, horizontal: 0.96, vertikal: 1.27

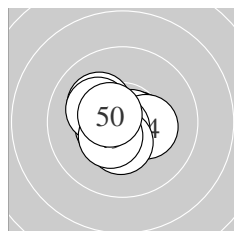

Serie 5:
 10.6 * 10.5 * 10.7 * 10.3 * 10.7 *
 10.1 ↖ 10.2 * 10.4 * 10.4 * 10.5 *
 beste Teiler 55.4 (45.) 56.0 (43.) 95.6 (41.)
 Trefferlage 0.34 mm links, 0.09 mm tief
 Streuwert 0.97, horizontal: 1.11, vertikal: 0.80

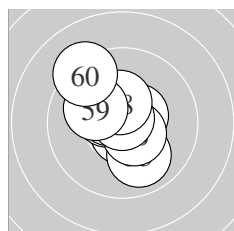

Serie 6:
 10.7 * 10.5 * 10.0 ↓ 10.5 * 10.5 *
 10.5 * 10.8 * 10.4 * 10.1 ↖ 9.2 ↖
 beste Teiler 33.1 (57.) 66.0 (51.) 107.8 (55.)
 Trefferlage 0.38 mm links, 0.43 mm hoch
 Streuwert 1.37, horizontal: 1.24, vertikal: 1.49

Meyton Elektronik

ISSF AR Men – Wertung – **Männer**

StandNr: 138

Kostenzer, Thomas #146

StartNr: 83

20. Januar 2020 11:44

T – SG Münster

Unterschrift des Schützen

Meyton Elektronik

Ergebnis: **623.5** (598)
 Serien: 102.8 103.6 104.3 104.5 105.9 102.4
 Zähler: 58 2 0 0 0 0 0 0 0
 Innenzehner: 48
 weiteste: 256 (16), 256 (60), 236 (36)
 beste Teiler 11.1 (49.) 35.6 (24.) 42.5 (43.)
 Trefferlage 0.19 mm rechts, 0.08 mm hoch
 Streuwert 1.07, horizontal: 0.95, vertikal: 1.18

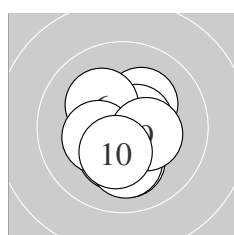
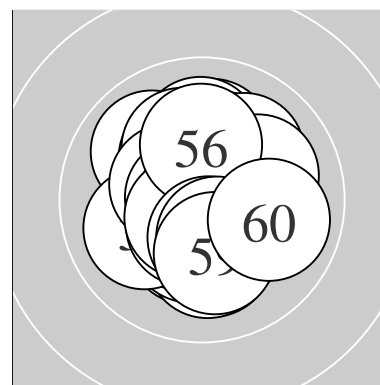

Serie 1:
 10.3 * 10.2 * 10.6 * 10.1 ↓ 10.3 *
 10.2 * 10.3 * 10.1 ↓ 10.4 * 10.3 *
 beste Teiler 91.2 (3.) 150.2 (9.) 155.3 (5.)
 Trefferlage 0.06 mm rechts, 0.66 mm tief
 Streuwert 1.17, horizontal: 0.98, vertikal: 1.33

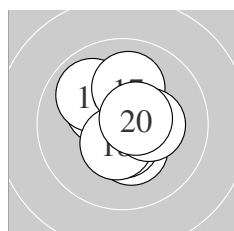

Serie 2:
 10.3 * 10.3 * 10.5 * 10.5 * 10.6 *
 9.9 ↘ 10.1 ↑ 10.5 * 10.3 * 10.6 *
 beste Teiler 87.8 (20.) 96.0 (15.) 106.1 (13.)
 Trefferlage 0.04 mm rechts, 0.26 mm hoch
 Streuwert 1.16, horizontal: 1.05, vertikal: 1.27

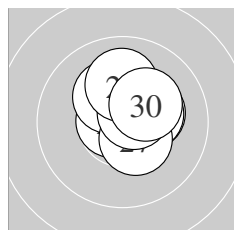

Serie 3:
 10.3 * 10.3 * 10.7 * 10.8 * 10.7 *
 10.3 * 10.4 * 10.6 * 10.0 ↑ 10.2 *
 beste Teiler 35.6 (24.) 62.3 (25.) 73.0 (23.)
 Trefferlage 0.45 mm rechts, 0.66 mm hoch
 Streuwert 0.88, horizontal: 0.88, vertikal: 0.88

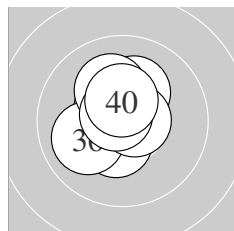

Serie 4:
 10.7 * 10.4 * 10.8 * 10.5 * 10.2 *
 10.0 ↙ 10.7 * 10.1 ↘ 10.7 * 10.4 *
 beste Teiler 50.9 (33.) 57.2 (39.) 59.0 (31.)
 Trefferlage 0.28 mm links, 0.45 mm hoch
 Streuwert 0.95, horizontal: 0.85, vertikal: 1.04

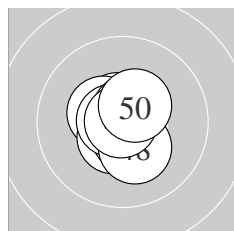

Serie 5:
 10.6 * 10.4 * 10.8 * 10.5 * 10.6 *
 10.7 * 10.7 * 10.3 * 10.9 * 10.4 *
 beste Teiler 11.1 (49.) 42.5 (43.) 59.6 (46.)
 Trefferlage 0.01 mm links, 0.04 mm tief
 Streuwert 0.75, horizontal: 0.64, vertikal: 0.85

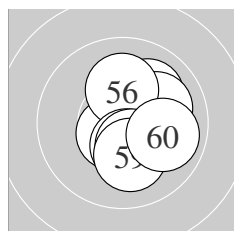

Serie 6:
 10.3 * 10.0 ↗ 10.6 * 10.5 * 10.1 →
 10.1 ↑ 10.4 * 10.4 * 10.1 ↓ 9.9 →
 beste Teiler 88.4 (53.) 118.2 (54.) 140.0 (57.)
 Trefferlage 0.92 mm rechts, 0.14 mm tief
 Streuwert 1.18, horizontal: 0.97, vertikal: 1.35

Meyton Elektronik

ISSF AR Men – Wertung – **Männer**

StandNr: 139

Höllwarth, Michael #35

StartNr: 84

20. Januar 2020 11:49

AUT

Unterschrift des Schützen

Meyton Elektronik

Ergebnis: **624.2** (598)
 Serien: 104.3 103.3 103.6 105.2 104.3 103.5
 Zähler: 58 2 0 0 0 0 0 0 0 0
 Innenzehner: 52
 weiteste: 339 (47), 279 (17), 247 (56)
 beste Teiler 9.2 (53.) 21.9 (6.) 21.9 (46.)
 Trefferlage 0.11 mm rechts, 0.16 mm hoch
 Streuwert 1.08, horizontal: 1.12, vertikal: 1.04

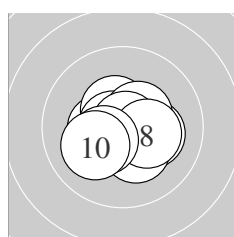
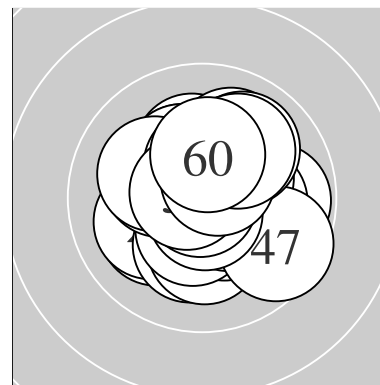

Serie 1:
 10.4 * 10.5 * 10.7 * 10.2 * 10.5 *
 10.9 * 10.3 * 10.3 * 10.4 * 10.1 ↙
 beste Teiler 21.9 (6.) 62.9 (3.) 121.7 (2.)
 Trefferlage 0.00 mm , 0.23 mm tief
 Streuwert 1.07, horizontal: 1.28, vertikal: 0.79

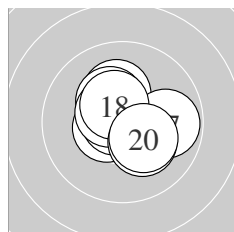

Serie 2:
 10.5 * 10.2 * 10.2 * 10.3 * 10.8 *
 10.5 * 9.8 → 10.5 * 10.2 * 10.3 *
 beste Teiler 45.8 (15.) 106.0 (16.) 108.1 (11.)
 Trefferlage 0.33 mm rechts, 0.17 mm hoch
 Streuwert 1.22, horizontal: 1.38, vertikal: 1.04

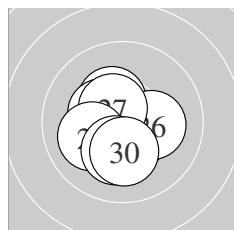

Serie 3:
 10.5 * 10.7 * 10.3 * 10.4 * 10.5 *
 10.2 * 10.5 * 10.1 ↙ 10.2 * 10.2 *
 beste Teiler 69.3 (22.) 110.4 (27.) 114.0 (25.)
 Trefferlage 0.27 mm links, 0.36 mm tief
 Streuwert 1.12, horizontal: 1.08, vertikal: 1.16

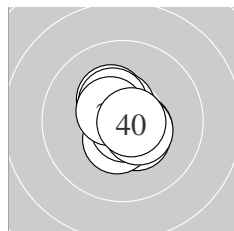

Serie 4:
 10.4 * 10.5 * 10.3 * 10.5 * 10.6 *
 10.4 * 10.8 * 10.5 * 10.5 * 10.7 *
 beste Teiler 45.5 (37.) 57.5 (40.) 95.0 (35.)
 Trefferlage 0.09 mm rechts, 0.04 mm hoch
 Streuwert 0.84, horizontal: 0.73, vertikal: 0.94

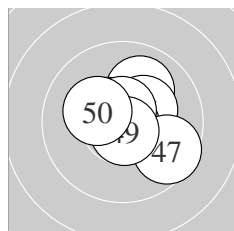

Serie 5:
 10.0 ↗ 10.5 * 10.7 * 10.7 * 10.3 *
 10.9 * 9.6 ↘ 10.7 * 10.7 * 10.2 *
 beste Teiler 21.9 (46.) 51.1 (44.) 59.2 (49.)
 Trefferlage 0.41 mm rechts, 0.21 mm hoch
 Streuwert 1.15, horizontal: 1.25, vertikal: 1.03

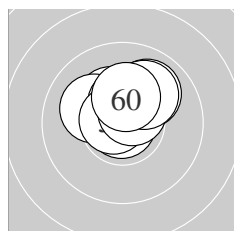

Serie 6:
 10.3 * 10.1 ↖ 10.9 * 10.4 * 10.2 *
 10.0 ↗ 10.7 * 10.6 * 10.0 ↗ 10.3 *
 beste Teiler 9.2 (53.) 62.9 (57.) 98.8 (58.)
 Trefferlage 0.14 mm rechts, 1.17 mm hoch
 Streuwert 0.89, horizontal: 1.06, vertikal: 0.69

Meyton Elektronik

ISSF AR Men – Wertung – Männer

StandNr: 140

Krumm,, Florian #456

StartNr: 85

20. Januar 2020 11:25

GER

Unterschrift des Schützen

Meyton Elektronik

Ergebnis:	618.3	(589)						
Serien:	102.8	102.4	102.5	104.0	103.2	103.4		
Zähler:	49	11	0	0	0	0	0	0
Innenzehner:	41							
weiteste:	347 (20), 335 (1), 325 (36)							
beste Teiler	13.6 (32.)	13.6 (38.)	36.0 (55.)					
Trefferlage	0.21 mm rechts, 0.28 mm hoch							
Streuwert	1.28, horizontal: 1.38, vertikal: 1.17							

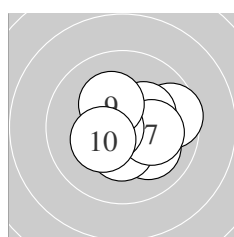
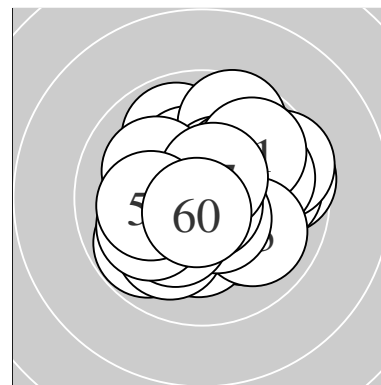

Serie 1:

9.6 →	10.4 *	10.7 *	10.1 ↘	10.3 *
10.4 *	10.1 →	10.6 *	10.3 *	10.3 *
beste Teiler	72.0 (3.)	79.2 (8.)	144.1 (6.)	
Trefferlage	0.68 mm rechts, 0.06 mm hoch			
Streuwert	1.27, horizontal: 1.48, vertikal: 1.03			

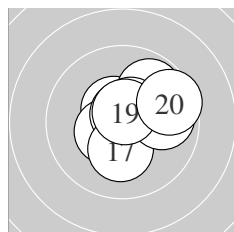

Serie 2:

10.5 *	9.9 ↗	10.5 *	9.8 ↗	10.6 *
10.7 *	10.2 *	9.9 →	10.7 *	9.6 →
beste Teiler	54.0 (16.)	71.8 (19.)	100.1 (15.)	
Trefferlage	0.87 mm rechts, 0.57 mm hoch			
Streuwert	1.31, horizontal: 1.48, vertikal: 1.11			

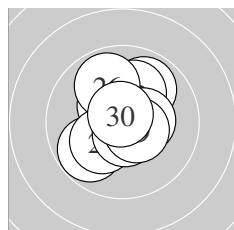

Serie 3:

10.4 *	9.9 ↗	10.1 ↑	10.4 *	9.8 ↗
9.9 ↘	10.2 *	10.6 *	10.5 *	10.7 *
beste Teiler	56.0 (30.)	82.7 (28.)	109.2 (29.)	
Trefferlage	0.09 mm links, 0.39 mm hoch			
Streuwert	1.40, horizontal: 1.26, vertikal: 1.53			

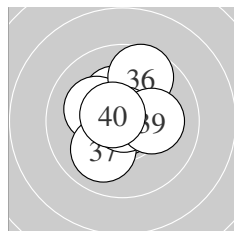

Serie 4:

10.4 *	10.9 *	10.3 *	10.8 *	10.2 *
9.7 ↑	10.0 ↙	10.9 *	10.2 *	10.6 *
beste Teiler	13.6 (32.)	13.6 (38.)	47.0 (34.)	
Trefferlage	0.05 mm links, 0.57 mm hoch			
Streuwert	1.21, horizontal: 1.12, vertikal: 1.29			

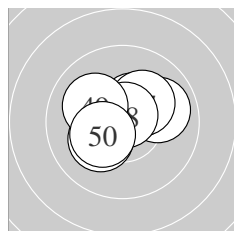

Serie 5:

10.4 *	10.2 *	9.9 →	10.6 *	10.3 *
10.4 *	10.2 *	10.8 *	10.1 ↘	10.3 *
beste Teiler	50.9 (48.)	83.1 (44.)	131.5 (46.)	
Trefferlage	0.13 mm links, 0.47 mm hoch			
Streuwert	1.20, horizontal: 1.45, vertikal: 0.86			

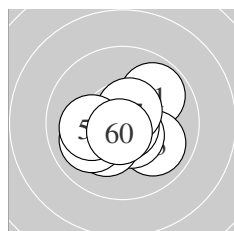

Serie 6:

9.8 ↗	10.7 *	10.0 ↘	10.5 *	10.8 *
10.2 *	10.6 *	10.0 ↙	10.1 ←	10.7 *
beste Teiler	36.0 (55.)	63.9 (60.)	72.4 (52.)	
Trefferlage	0.01 mm rechts, 0.39 mm tief			
Streuwert	1.27, horizontal: 1.46, vertikal: 1.03			

Meyton Elektronik

ISSF AR Men – Wertung – Männer

StandNr: 141

Wyrsh, Fabio #421

StartNr: 86

20. Januar 2020 11:30

SUI

Unterschrift des Schützen

Meyton Elektronik

Ergebnis:	628.4	(600) ^{QF}
Serien:	103.1	104.4 104.5 105.0 105.9 105.5
Zähler:	60	0 0 0 0 0 0 0 0 0
Innenzehner:	55	
weiteste:	240	(1), 221 (6), 212 (32)
beste Teiler	7.2	(41.) 13.4 (25.) 19.1 (43.)
Trefferlage	0.19 mm	links, 0.12 mm hoch
Streuwert	0.93,	horizontal: 0.91, vertikal: 0.95

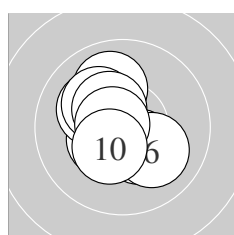
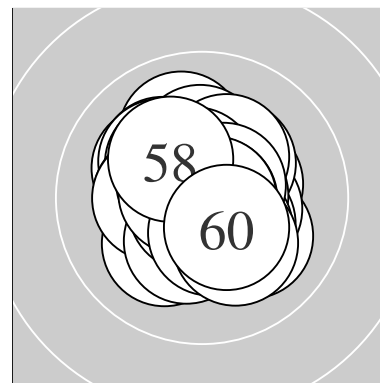

Serie 1:	10.0 ↗	10.4 *	10.5 *	10.3 *	10.1 ↘
	10.1 ↘	10.2 *	10.4 *	10.7 *	10.4 *
beste Teiler	64.2	(9.) 110.9 (3.)	133.1 (2.)		
Trefferlage	0.49 mm	links, 0.05 mm hoch			
Streuwert	1.20,	horizontal: 1.06, vertikal: 1.32			

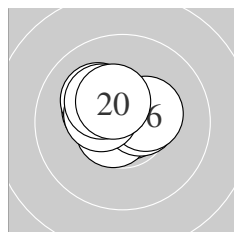

Serie 2:	10.3 *	10.8 *	10.7 *	10.2 *	10.5 *
	10.4 *	10.4 *	10.4 *	10.3 *	10.4 *
beste Teiler	42.1	(12.) 73.1 (13.)	107.2 (15.)		
Trefferlage	0.43 mm	links, 0.64 mm hoch			
Streuwert	0.85,	horizontal: 1.04, vertikal: 0.60			

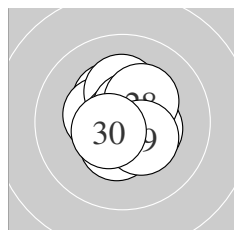

Serie 3:	10.3 *	10.4 *	10.4 *	10.2 *	10.9 *
	10.4 *	10.6 *	10.3 *	10.4 *	10.6 *
beste Teiler	13.4	(25.) 81.4 (27.)	99.0 (30.)		
Trefferlage	0.05 mm	rechts, 0.25 mm hoch			
Streuwert	0.98,	horizontal: 0.92, vertikal: 1.03			

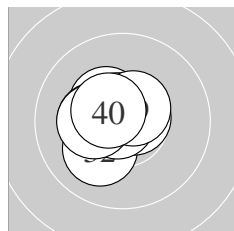

Serie 4:	10.6 *	10.1 ↙	10.4 *	10.7 *	10.7 *
	10.8 *	10.3 *	10.3 *	10.6 *	10.5 *
beste Teiler	31.0	(36.) 68.3 (35.)	71.1 (34.)		
Trefferlage	0.66 mm	links, 0.17 mm hoch			
Streuwert	0.79,	horizontal: 0.84, vertikal: 0.73			

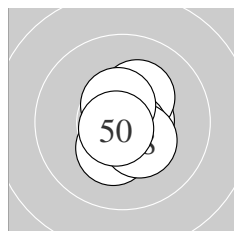

Serie 5:	10.9 *	10.6 *	10.9 *	10.6 *	10.3 *
	10.3 *	10.7 *	10.4 *	10.5 *	10.7 *
beste Teiler	7.2	(41.) 19.1 (43.)	55.1 (50.)		
Trefferlage	0.17 mm	rechts, 0.14 mm tief			
Streuwert	0.77,	horizontal: 0.58, vertikal: 0.92			

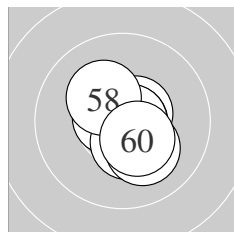

Serie 6:	10.6 *	10.8 *	10.6 *	10.8 *	10.8 *
	10.8 *	10.4 *	10.2 *	10.1 ↘	10.4 *
beste Teiler	39.2	(52.) 42.0 (55.)	43.1 (56.)		
Trefferlage	0.21 mm	rechts, 0.22 mm tief			
Streuwert	0.82,	horizontal: 0.74, vertikal: 0.89			

ISSF AR Men – Wertung – Männer

StandNr: 142

Divyansh, Singh Panwar #457

StartNr: 87

20. Januar 2020 11:45

IND

QF – Schütze hat sich fürs Finale qualifiziert

Unterschrift des Schützen

Meyton Elektronik

Ergebnis: **625.5** (595)
 Serien: 104.8 105.2 104.3 103.5 104.3 103.4
 Zähler: 55 5 0 0 0 0 0 0 0 0
 Innenzehner: 53
 weiteste: 305 (50), 292 (20), 262 (53)
 beste Teiler 35.1 (16.) 41.4 (47.) 43.1 (46.)
 Trefferlage 0.12 mm links, 0.09 mm tief
 Streuwert 1.04, horizontal: 1.21, vertikal: 0.83

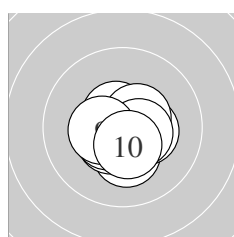
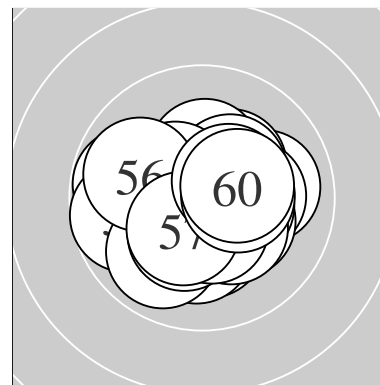

Serie 1:
 10.3 * 10.6 * 10.6 * 10.4 * 10.5 *
 10.5 * 10.5 * 10.5 * 10.4 * 10.5 *
 beste Teiler 84.3 (3.) 89.5 (2.) 112.5 (7.)
 Trefferlage 0.01 mm links, 0.41 mm tief
 Streuwert 0.86, horizontal: 0.97, vertikal: 0.74

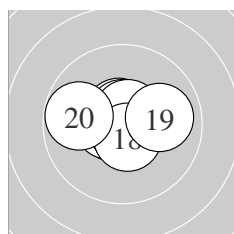

Serie 2:
 10.6 * 10.8 * 10.7 * 10.6 * 10.7 *
 10.8 * 10.6 * 10.6 * 10.0 → 9.8 ←
 beste Teiler 35.1 (16.) 47.5 (12.) 55.9 (13.)
 Trefferlage 0.15 mm links, 0.20 mm hoch
 Streuwert 1.00, horizontal: 1.30, vertikal: 0.56

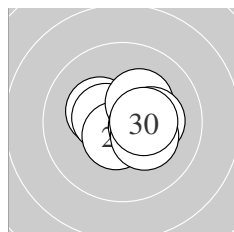

Serie 3:
 10.6 * 10.3 * 10.7 * 10.5 * 10.6 *
 10.3 * 10.4 * 10.2 * 10.3 * 10.4 *
 beste Teiler 52.6 (23.) 93.9 (21.) 98.8 (25.)
 Trefferlage 0.36 mm rechts, 0.04 mm hoch
 Streuwert 1.00, horizontal: 1.23, vertikal: 0.68

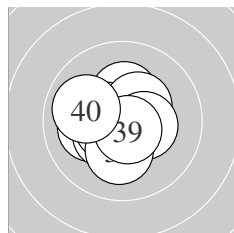

Serie 4:
 10.3 * 10.1 ← 10.5 * 10.4 * 10.6 *
 10.4 * 10.4 * 10.2 * 10.7 * 9.9 ←
 beste Teiler 66.3 (39.) 100.3 (35.) 106.6 (33.)
 Trefferlage 0.48 mm links, 0.07 mm tief
 Streuwert 1.14, horizontal: 1.24, vertikal: 1.04

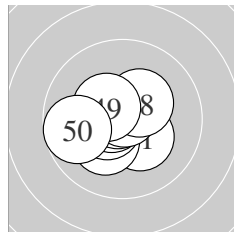

Serie 5:
 10.3 * 10.2 * 10.5 * 10.7 * 10.6 *
 10.8 * 10.8 * 10.3 * 10.4 * 9.7 ←
 beste Teiler 41.4 (47.) 43.1 (46.) 72.1 (44.)
 Trefferlage 0.54 mm links, 0.05 mm tief
 Streuwert 1.04, horizontal: 1.20, vertikal: 0.85

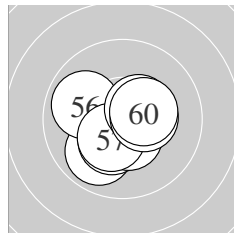

Serie 6:
 10.6 * 10.5 * 9.9 ↘ 10.3 * 10.5 *
 9.9 ← 10.4 * 10.5 * 10.4 * 10.4 *
 beste Teiler 93.6 (51.) 106.4 (52.) 120.4 (55.)
 Trefferlage 0.07 mm rechts, 0.30 mm tief
 Streuwert 1.21, horizontal: 1.35, vertikal: 1.06

Meyton Elektronik

ISSF AR Men – Wertung – Männer

StandNr: 143

Rumpler, Gernot #137

StartNr: 88

20. Januar 2020 11:51

AUT

Unterschrift des Schützen

Meyton Elektronik

Ergebnis:	622.8	(595)					
Serien:	104.6	103.5	104.8	103.3	102.7	103.9	
Zähler:	55	5	0	0	0	0	0
Innenzehner:	50						
weiteste:	405 (19), 292 (44), 291 (37)						
beste Teiler	31.3 (34.) 52.0 (56.) 52.8 (23.)						
Trefferlage	0.13 mm rechts, 0.14 mm hoch						
Streuwert	1.13, horizontal: 1.37, vertikal: 0.81						

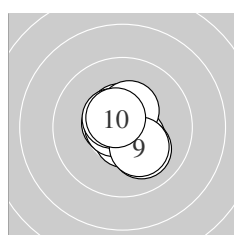
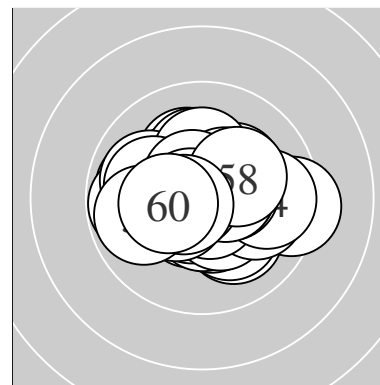

Serie 1:	10.5 *	10.6 *	10.4 *	10.6 *	10.4 *
	10.7 *	10.5 *	10.1 ↘	10.2 *	10.6 *
beste Teiler	61.0 (6.) 79.7 (4.) 88.0 (10.)				
Trefferlage	0.12 mm rechts, 0.07 mm tief				
Streuwert	0.96, horizontal: 0.86, vertikal: 1.04				

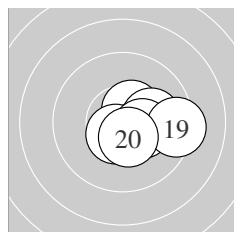

Serie 2:	10.5 *	10.6 *	10.7 *	10.5 *	10.5 *
	10.1 →	10.5 *	10.3 *	9.3 →	10.5 *
beste Teiler	75.6 (13.) 95.0 (12.) 103.9 (17.)				
Trefferlage	1.14 mm rechts, 0.23 mm tief				
Streuwert	0.99, horizontal: 1.24, vertikal: 0.66				

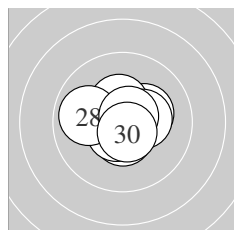

Serie 3:	10.3 *	10.5 *	10.7 *	10.7 *	10.4 *
	10.4 *	10.6 *	9.9 ←	10.7 *	10.6 *
beste Teiler	52.8 (23.) 59.5 (24.) 64.3 (29.)				
Trefferlage	0.05 mm rechts, 0.01 mm hoch				
Streuwert	0.99, horizontal: 1.18, vertikal: 0.75				

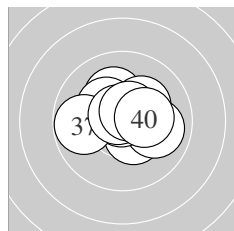

Serie 4:	10.2 *	10.4 *	10.0 →	10.8 *	10.3 *
	10.2 *	9.8 ←	10.7 *	10.6 *	10.3 *
beste Teiler	31.3 (34.) 59.4 (38.) 89.0 (39.)				
Trefferlage	0.15 mm rechts, 0.40 mm hoch				
Streuwert	1.25, horizontal: 1.55, vertikal: 0.85				

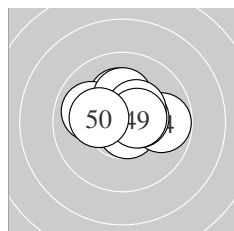

Serie 5:	10.7 *	10.3 *	10.2 *	9.8 →	10.4 *
	10.0 ←	10.2 *	10.4 *	10.5 *	10.2 *
beste Teiler	62.4 (41.) 111.8 (49.) 128.0 (45.)				
Trefferlage	0.05 mm rechts, 0.64 mm hoch				
Streuwert	1.26, horizontal: 1.62, vertikal: 0.75				

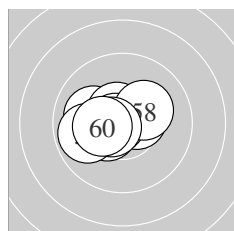

Serie 6:	10.4 *	10.5 *	10.6 *	10.1 ←	10.6 *
	10.7 *	9.9 ←	10.2 *	10.6 *	10.3 *
beste Teiler	52.0 (56.) 88.2 (59.) 90.4 (53.)				
Trefferlage	0.73 mm links, 0.11 mm hoch				
Streuwert	1.01, horizontal: 1.30, vertikal: 0.60				

ISSF AR Men – Wertung – Männer

StandNr: 144

Manpat, Rakesh #458

StartNr: 89

20. Januar 2020 11:33

IND

Unterschrift des Schützen

Meyton Elektronik

Ergebnis: **624.8** (597)
 Serien: 106.0 102.9 104.6 104.3 103.2 103.8
 Zähler: 57 3 0 0 0 0 0 0 0 0
 Innenzehner: 50
 weiteste: 373 (15), 288 (21), 264 (56)
 beste Teiler 35.2 (1.) 35.6 (8.) 38.1 (60.)
 Trefferlage 0.13 mm links, 0.00 mm
 Streuwert 1.08, horizontal: 1.19, vertikal: 0.95

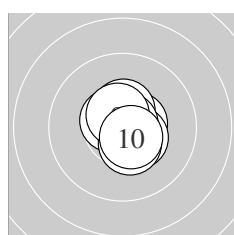
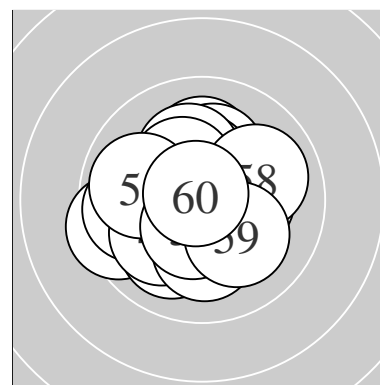

Serie 1:
 10.8 * 10.6 * 10.5 * 10.6 * 10.5 *
 10.6 * 10.4 * 10.8 * 10.6 * 10.6 *
 beste Teiler 35.2 (1.) 35.6 (8.) 92.9 (10.)
 Trefferlage 0.32 mm rechts, 0.03 mm tief
 Streuwert 0.67, horizontal: 0.56, vertikal: 0.77

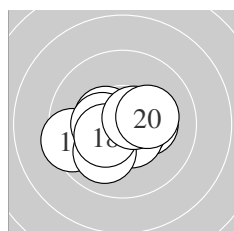

Serie 2:
 10.4 * 10.3 * 10.6 * 10.5 * 9.5 ←
 10.4 * 10.0 ↙ 10.4 * 10.6 * 10.2 *
 beste Teiler 90.0 (19.) 95.2 (13.) 106.6 (14.)
 Trefferlage 0.29 mm links, 0.37 mm tief
 Streuwert 1.34, horizontal: 1.71, vertikal: 0.81

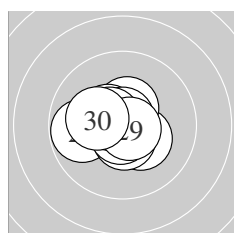

Serie 3:
 9.8 ← 10.3 * 10.6 * 10.7 * 10.5 *
 10.5 * 10.8 * 10.5 * 10.7 * 10.2 *
 beste Teiler 45.0 (27.) 55.4 (29.) 55.7 (24.)
 Trefferlage 0.45 mm links, 0.01 mm hoch
 Streuwert 1.00, horizontal: 1.22, vertikal: 0.73

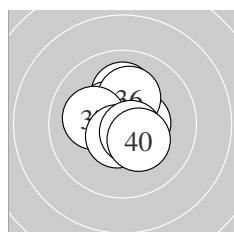

Serie 4:
 10.7 * 10.8 * 10.1 ↑ 10.4 * 10.5 *
 10.2 * 10.1 ← 10.6 * 10.6 * 10.3 *
 beste Teiler 44.0 (32.) 65.0 (31.) 82.7 (39.)
 Trefferlage 0.07 mm links, 0.23 mm hoch
 Streuwert 1.05, horizontal: 1.00, vertikal: 1.10

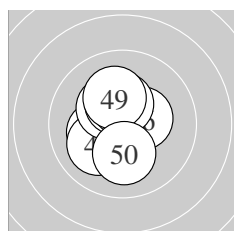

Serie 5:
 10.5 * 10.2 * 10.7 * 10.1 ↙ 10.3 *
 10.4 * 10.3 * 10.4 * 10.2 * 10.1 ↓
 beste Teiler 68.9 (43.) 119.9 (41.) 138.8 (46.)
 Trefferlage 0.33 mm links, 0.31 mm hoch
 Streuwert 1.18, horizontal: 1.04, vertikal: 1.30

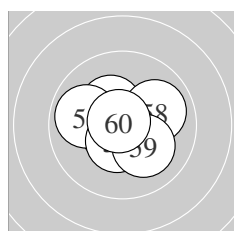

Serie 6:
 10.8 * 10.6 * 10.3 * 10.3 * 10.5 *
 9.9 ← 10.5 * 10.0 → 10.1 ↘ 10.8 *
 beste Teiler 38.1 (60.) 49.1 (51.) 90.4 (52.)
 Trefferlage 0.04 mm rechts, 0.14 mm tief
 Streuwert 1.21, horizontal: 1.42, vertikal: 0.94

Meyton Elektronik

ISSF AR Men – Wertung – Männer

StandNr: 145

Bale,, Dean #459

StartNr: 90

20. Januar 2020 11:49

GBR

Unterschrift des Schützen

Meyton Elektronik

Ergebnis: **619.5** (591)
 Serien: 101.9 103.2 103.8 102.9 103.5 104.2
 Zähler: 51 9 0 0 0 0 0 0 0 0
 Innenzehner: 43
 weiteste: 403 (37), 394 (12), 278 (22)
 beste Teiler 29.1 (29.) 49.9 (11.) 53.0 (34.)
 Trefferlage 0.18 mm links, 0.08 mm tief
 Streuwert 1.25, horizontal: 1.37, vertikal: 1.12

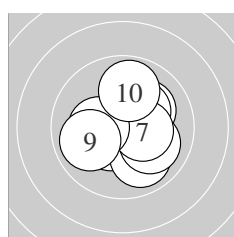
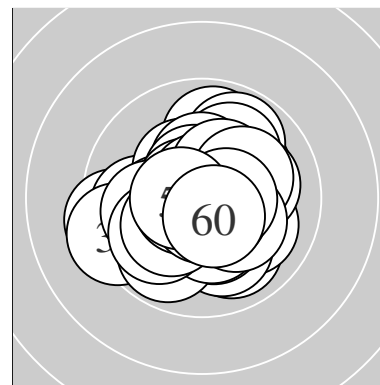

Serie 1:
 10.7 * 10.1 ↗ 10.4 * 10.3 * 9.9 ↘
 10.0 ↘ 10.4 * 10.3 * 9.9 ← 9.9 ↑
 beste Teiler 62.3 (1.) 128.8 (3.) 150.0 (7.)
 Trefferlage 0.27 mm rechts, 0.00 mm
 Streuwert 1.48, horizontal: 1.55, vertikal: 1.42

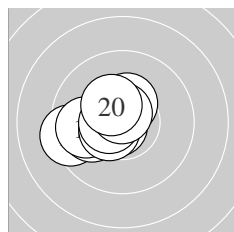

Serie 2:
 10.8 * 9.4 ← 10.0 ← 10.5 * 10.4 *
 9.9 ← 10.5 * 10.6 * 10.7 * 10.4 *
 beste Teiler 49.9 (11.) 66.3 (19.) 98.1 (18.)
 Trefferlage 1.27 mm links, 0.09 mm hoch
 Streuwert 1.07, horizontal: 1.27, vertikal: 0.82

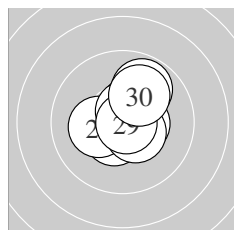

Serie 3:
 10.4 * 9.8 ↗ 10.5 * 10.2 * 10.5 *
 10.5 * 10.5 * 10.6 * 10.8 * 10.0 ↗
 beste Teiler 29.1 (29.) 83.8 (28.) 110.0 (26.)
 Trefferlage 0.42 mm rechts, 0.51 mm hoch
 Streuwert 1.06, horizontal: 0.97, vertikal: 1.14

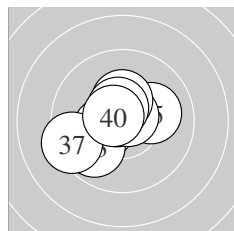

Serie 4:
 10.5 * 10.4 * 9.8 ↘ 10.7 * 10.1 →
 10.7 * 9.3 ← 10.3 * 10.5 * 10.6 *
 beste Teiler 53.0 (34.) 55.9 (36.) 77.8 (40.)
 Trefferlage 0.56 mm links, 0.11 mm hoch
 Streuwert 1.36, horizontal: 1.57, vertikal: 1.10

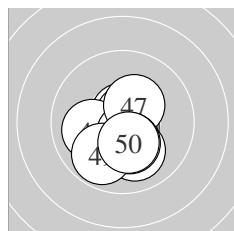

Serie 5:
 10.7 * 10.7 * 10.7 * 10.0 ← 10.0 ↓
 10.6 * 10.4 * 10.3 * 9.8 ↘ 10.3 *
 beste Teiler 56.4 (43.) 58.0 (41.) 61.4 (42.)
 Trefferlage 0.00 mm , 0.69 mm tief
 Streuwert 1.12, horizontal: 1.03, vertikal: 1.20

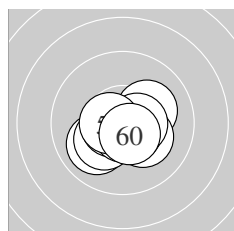

Serie 6:
 10.0 ↘ 10.2 * 10.2 * 10.6 * 10.7 *
 10.2 * 10.6 * 10.5 * 10.6 * 10.6 *
 beste Teiler 63.0 (55.) 81.9 (54.) 89.8 (57.)
 Trefferlage 0.05 mm rechts, 0.52 mm tief
 Streuwert 1.01, horizontal: 1.25, vertikal: 0.70

ISSF AR Men – Wertung – **Männer**

StandNr: 146

Hrckulak, David #32

StartNr: 91

20. Januar 2020 11:49

CZE

Unterschrift des Schützen

Meyton Elektronik

Ergebnis:	582.7	(558)
Serien:	97.2 96.8 96.4 96.9 100.9 94.5	
Zähler:	24 31 4 1 0 0 0 0 0 0	
Innenzehner:	16	
weiteste:	983 (52), 695 (40), 635 (18)	
beste Teiler	9.8 (45.) 68.6 (55.) 88.2 (42.)	
Trefferlage	0.38 mm rechts, 0.70 mm hoch	
Streuwert	2.45, horizontal: 2.73, vertikal: 2.13	

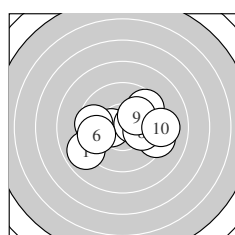
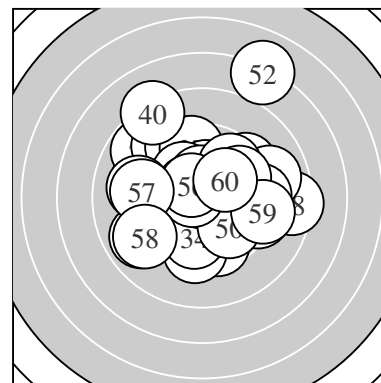

Serie 1:	8.9 ↙	10.4 *	10.4 *	9.3 ➔	9.6 ←
	9.7 ←	9.6 ↗	10.0 ➔	10.1 ↗	9.2 ➔
beste Teiler	127.7 (3.)	133.1 (2.)	211.7 (9.)		
Trefferlage	0.41 mm rechts, 0.11 mm tief				
Streuwert	2.46, horizontal: 3.20, vertikal: 1.37				

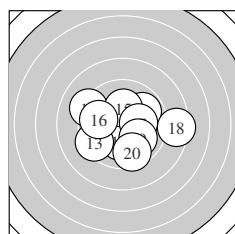

Serie 2:	9.9 ↗	10.1 ↓	9.4 ↙	9.2 ↖	10.2 *
	9.8 ←	10.2 *	8.4 ➔	10.0 ↘	9.6 ↓
beste Teiler	187.6 (17.)	189.2 (15.)	202.2 (12.)		
Trefferlage	0.30 mm rechts, 0.34 mm tief				
Streuwert	2.56, horizontal: 3.12, vertikal: 1.84				

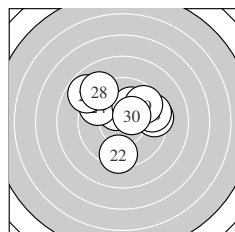

Serie 3:	10.4 *	9.4 ↓	9.4 ➔	9.6 ↖	10.1 ↗
	9.5 ➔	8.8 ↖	9.1 ↖	9.7 ↗	10.4 *
beste Teiler	131.8 (30.)	146.1 (21.)	213.8 (25.)		
Trefferlage	0.06 mm rechts, 1.26 mm hoch				
Streuwert	2.43, horizontal: 2.77, vertikal: 2.04				

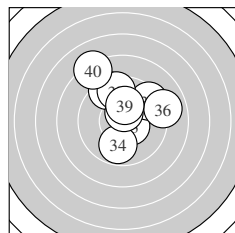

Serie 4:	9.3 ↖	10.5 *	10.5 *	9.8 ↓	9.4 ↗
	9.0 ➔	9.5 ↑	10.5 *	10.2 *	8.2 ↖
beste Teiler	102.2 (38.)	112.3 (33.)	124.0 (32.)		
Trefferlage	0.36 mm rechts, 1.72 mm hoch				
Streuwert	2.38, horizontal: 2.33, vertikal: 2.42				

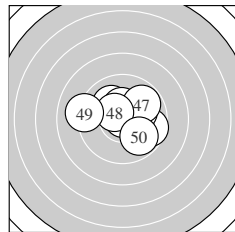

Serie 5:	9.6 ➔	10.6 *	10.1 ↖	10.1 ➔	10.9 *
	10.4 *	9.8 ↗	10.5 *	9.1 ←	9.8 ↘
beste Teiler	9.8 (45.)	88.2 (42.)	122.9 (48.)		
Trefferlage	0.26 mm rechts, 0.51 mm hoch				
Streuwert	1.79, horizontal: 2.22, vertikal: 1.20				

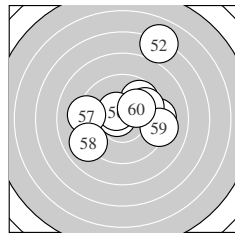

Serie 6:	9.3 ➔	7.0 ↑	9.7 ↗	9.8 ↗	10.7 *
	10.5 *	9.2 ←	9.0 ↙	9.2 ➔	10.1 ↗
beste Teiler	68.6 (55.)	116.5 (56.)	206.6 (60.)		
Trefferlage	0.91 mm rechts, 1.19 mm hoch				
Streuwert	3.13, horizontal: 3.23, vertikal: 3.03				

Meyton Elektronik

ISSF AR Men – Wertung – Männer

StandNr: 147

Mattle, Michael #460

StartNr: 92

20. Januar 2020 11:47

LIE

Unterschrift des Schützen

Meyton Elektronik

Ergebnis: **603.7** (578)
 Serien: 100.9 99.0 99.0 101.0 101.7 102.1
 Zähler: 40 18 2 0 0 0 0 0 0 0
 Innenzehner: 26
 weiteste: 549 (18), 502 (22), 468 (12)
 beste Teiler 20.6 (40.) 50.1 (3.) 67.0 (10.)
 Trefferlage 0.16 mm rechts, 0.41 mm hoch
 Streuwert 1.73, horizontal: 1.75, vertikal: 1.72

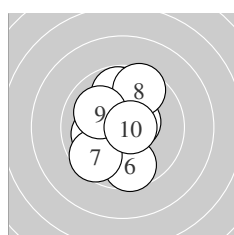
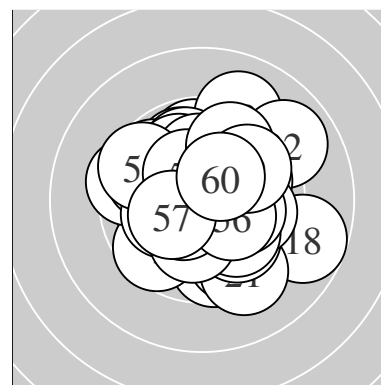

Serie 1:
 10.2 * 10.5 * 10.8 * 9.8 ↑ 10.1 ←
 9.6 ↓ 9.6 ↙ 9.6 ↑ 10.0 ↘ 10.7 *
 beste Teiler 50.1 (3.) 67.0 (10.) 109.2 (2.)
 Trefferlage 0.41 mm links, 0.26 mm hoch
 Streuwert 1.75, horizontal: 1.37, vertikal: 2.07

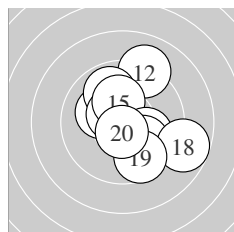

Serie 2:
 10.2 * 9.1 ↗ 9.9 ↖ 10.5 * 10.2 *
 10.1 ↘ 10.0 ↘ 8.8 ↘ 9.6 ↓ 10.6 *
 beste Teiler 83.2 (20.) 108.8 (14.) 178.4 (15.)
 Trefferlage 0.80 mm rechts, 0.16 mm hoch
 Streuwert 2.15, horizontal: 2.04, vertikal: 2.25

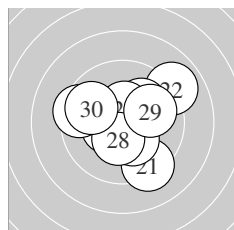

Serie 3:
 9.3 ↘ 8.9 ↗ 10.3 * 10.4 * 10.1 ↗
 10.5 * 9.4 ← 10.4 * 9.9 → 9.8 ↖
 beste Teiler 123.9 (26.) 133.1 (24.) 146.7 (28.)
 Trefferlage 0.32 mm rechts, 0.16 mm hoch
 Streuwert 2.16, horizontal: 2.40, vertikal: 1.89

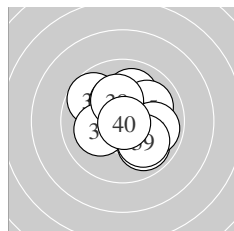

Serie 4:
 10.0 ↑ 9.9 ↘ 9.7 ↘ 10.3 * 10.0 ↗
 9.9 → 10.1 ← 10.2 * 10.0 ↘ 10.9 *
 beste Teiler 20.6 (40.) 165.8 (34.) 179.2 (38.)
 Trefferlage 0.36 mm rechts, 0.34 mm hoch
 Streuwert 1.64, horizontal: 1.72, vertikal: 1.55

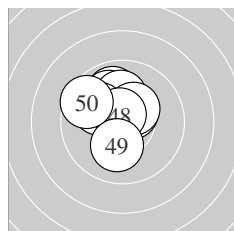

Serie 5:
 9.9 ↖ 10.4 * 10.0 ↖ 10.1 ↑ 10.5 *
 10.0 ↘ 10.4 * 10.7 * 10.1 ↓ 9.6 ↖
 beste Teiler 69.2 (48.) 111.0 (45.) 145.7 (47.)
 Trefferlage 0.66 mm links, 1.16 mm hoch
 Streuwert 1.23, horizontal: 1.20, vertikal: 1.26

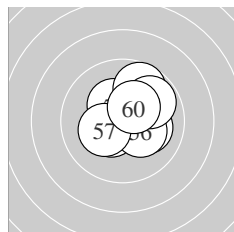

Serie 6:
 10.5 * 10.3 * 10.1 → 10.5 * 10.3 *
 10.3 * 10.3 * 9.7 ↑ 9.8 ↗ 10.3 *
 beste Teiler 115.4 (54.) 125.4 (51.) 151.4 (60.)
 Trefferlage 0.58 mm rechts, 0.41 mm hoch
 Streuwert 1.35, horizontal: 1.42, vertikal: 1.29

Meyton Elektronik

ISSF AR Men – Wertung – **Männer**

StandNr: 140

Fuchs, Manfred #250

StartNr: 134

19. Januar 2020 13:03

T – SG Bruckhäusl

Unterschrift des Schützen

Meyton Elektronik

Ergebnis:	571.8	(545)
Serien:	96.2	94.1 90.8 97.4 97.6 95.7
Zähler:	18 30 11 1 0 0 0 0 0	
Innenzehner:	12	
weiteste:	911 (24), 667 (20), 657 (33)	
beste Teiler	12.6 (5.) 53.1 (36.) 55.9 (17.)	
Trefferlage	0.49 mm rechts, 0.14 mm hoch	
Streuwert	2.83, horizontal: 3.56, vertikal: 1.83	

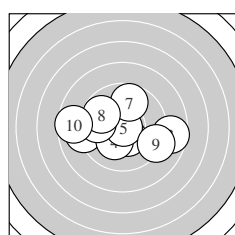
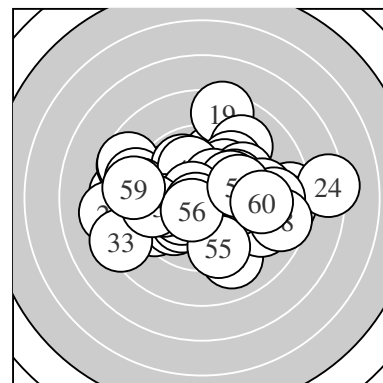

Serie 1:

9.1 ←	10.4 *	8.6 →	10.2 *	10.9 *
9.7 ←	9.7 ↑	9.8 ↘	9.2 →	8.6 ←

beste Teiler 12.6 (5.) 139.5 (2.) 189.5 (4.)
 Trefferlage 0.57 mm links, 0.13 mm tief
 Streuwert 2.79, horizontal: 3.64, vertikal: 1.52

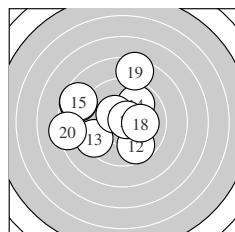

Serie 2:

8.6 ↖	9.7 ↘	9.4 ↙	9.9 ↗	8.6 ↖
10.4 *	10.7 *	10.1 →	8.4 ↑	8.3 ←

beste Teiler 55.9 (17.) 133.6 (16.) 212.3 (18.)
 Trefferlage 1.43 mm links, 0.84 mm hoch
 Streuwert 3.01, horizontal: 3.39, vertikal: 2.57

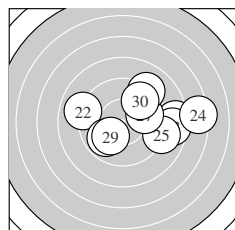

Serie 3:

8.4 →	9.0 ↖	8.6 →	7.3 →	9.0 →
9.9 ↙	9.8 →	9.1 ↗	10.1 ↙	9.6 ↗

beste Teiler 220.5 (29.) 273.8 (26.) 278.2 (27.)
 Trefferlage 2.53 mm rechts, 0.40 mm hoch
 Streuwert 3.28, horizontal: 4.25, vertikal: 1.85

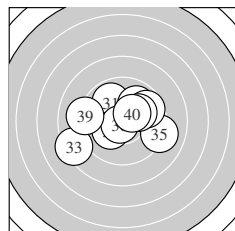

Serie 4:

9.9 ↘	9.9 ↗	8.3 ↙	10.2 *	9.1 →
10.7 *	9.7 →	10.1 ↗	9.1 ←	10.4 *

beste Teiler 53.1 (36.) 146.3 (40.) 181.6 (34.)
 Trefferlage 0.16 mm links, 0.21 mm hoch
 Streuwert 2.57, horizontal: 3.21, vertikal: 1.70

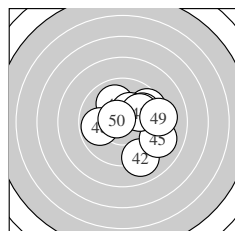

Serie 5:

10.0 ↘	9.1 ↘	9.6 ↗	10.3 *	9.1 →
9.9 →	10.0 →	9.8 ←	9.2 →	10.6 *

beste Teiler 78.2 (50.) 153.1 (44.) 233.6 (47.)
 Trefferlage 1.44 mm rechts, 0.17 mm hoch
 Streuwert 2.14, horizontal: 2.30, vertikal: 1.96

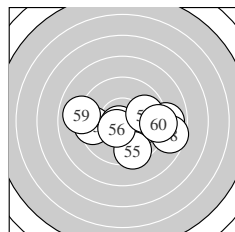

Serie 6:

8.9 →	10.0 →	9.5 ←	10.7 *	9.5 ↓
10.5 *	9.8 →	8.6 →	9.0 ←	9.2 →

beste Teiler 62.9 (54.) 113.7 (56.) 239.7 (52.)
 Trefferlage 1.15 mm rechts, 0.62 mm tief
 Streuwert 2.67, horizontal: 3.57, vertikal: 1.24

Meyton Elektronik

ISSF AR Men – Wertung – Männer

StandNr: 144

Lamplmair, Gottfried #395

StartNr: 138

19. Januar 2020 13:14

T – SG Walchsee

Unterschrift des Schützen

Meyton Elektronik