

Ergebnis: **414.4** (396)  
 Serien: 103.4 103.9 103.1 104.0  
 Zähler: 36 4 0 0 0 0 0 0 0 0  
 Innenzehner: 30  
 weiteste: 370 (2), 318 (23), 279 (32)  
 beste Teiler 14.1 (9.) 53.0 (36.) 55.2 (1.)  
 Trefferlage 0.26 mm links, 0.22 mm tief  
 Streuwert 1.17, horizontal: 1.29, vertikal: 1.02

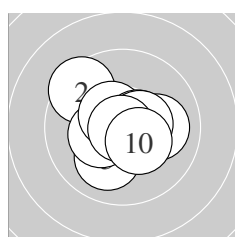

Serie 1:  
 10.7 \*                      9.5 ↖                      10.1 ↙                      10.3 \*                      10.5 \*  
 10.5 \*                      10.0 →                      10.5 \*                      10.9 \*                      10.4 \*  
 beste Teiler 14.1 (9.) 55.2 (1.) 102.3 (6.)  
 Trefferlage 0.08 mm links, 0.07 mm hoch  
 Streuwert 1.34, horizontal: 1.48, vertikal: 1.17

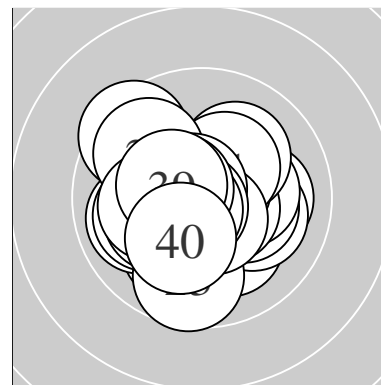
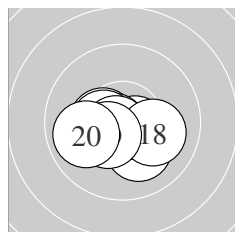

Serie 2:  
 10.4 \*                      10.6 \*                      10.7 \*                      10.6 \*                      10.4 \*  
 10.7 \*                      10.1 ↘                      10.1 →                      10.4 \*                      9.9 ←  
 beste Teiler 65.0 (16.) 69.3 (13.) 95.8 (12.)  
 Trefferlage 0.28 mm links, 0.63 mm tief  
 Streuwert 1.02, horizontal: 1.34, vertikal: 0.51

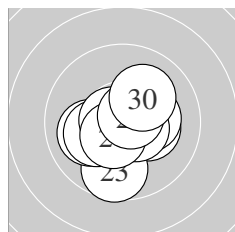

Serie 3:  
 10.3 \*                      10.3 \*                      9.7 ↓                      10.0 ←                      10.2 \*  
 10.6 \*                      10.7 \*                      10.5 \*                      10.7 \*                      10.1 ↗  
 beste Teiler 70.4 (29.) 71.0 (27.) 99.3 (26.)  
 Trefferlage 0.03 mm rechts, 0.38 mm tief  
 Streuwert 1.31, horizontal: 1.39, vertikal: 1.23

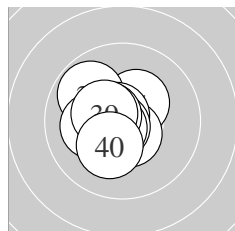

Serie 4:  
 10.3 \*                      9.8 ↖                      10.6 \*                      10.7 \*                      10.2 \*  
 10.7 \*                      10.6 \*                      10.5 \*                      10.4 \*                      10.2 \*  
 beste Teiler 53.0 (36.) 56.0 (34.) 76.2 (37.)  
 Trefferlage 0.72 mm links, 0.06 mm hoch  
 Streuwert 0.98, horizontal: 0.95, vertikal: 1.00

Unterschrift des Schützen

Meyton Elektronik

Ergebnis:	<b>412.4</b>	(395)
Serien:	103.0	101.2 104.6 103.6
Zähler:	35	5 0 0 0 0 0 0 0 0
Innenzehner:	26	
weiteste:	349	(15), 292 (12), 277 (9)
beste Teiler	47.3	(27.) 69.1 (28.) 72.0 (4.)
Trefferlage	0.20 mm rechts, 0.18 mm hoch	
Streuwert	1.25, horizontal: 1.22, vertikal: 1.29	

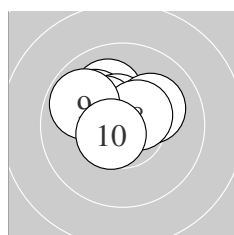
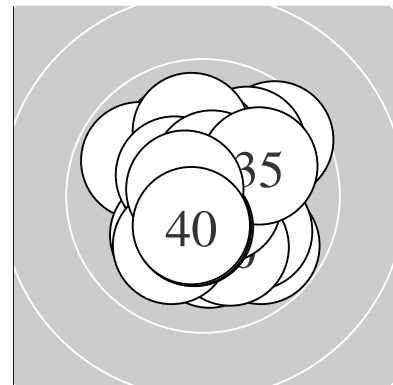

Serie 1:	10.3 *	10.1 ↗	10.1 ↘	10.7 *	10.5 *
	10.1 ↗	10.3 *	10.5 *	9.8 ↘	10.6 *
beste Teiler	72.0 (4.) 93.4 (10.) 109.1 (5.)				
Trefferlage	0.60 mm links, 0.95 mm hoch				
Streuwert	0.99, horizontal: 1.23, vertikal: 0.66				

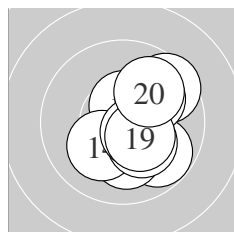

Serie 2:	10.5 *	9.8 ↘	10.1 ↓	10.2 *	9.6 ↗
	10.0 ↗	10.2 *	10.5 *	10.4 *	9.9 ↗
beste Teiler	103.2 (18.) 105.4 (11.) 142.9 (19.)				
Trefferlage	1.06 mm rechts, 0.16 mm tief				
Streuwert	1.43, horizontal: 1.18, vertikal: 1.65				

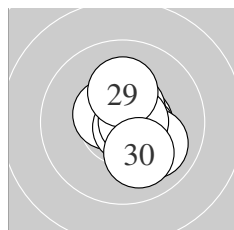

Serie 3:	10.7 *	10.6 *	10.4 *	10.0 ↘	10.6 *
	10.5 *	10.8 *	10.7 *	10.2 *	10.1 ↘
beste Teiler	47.3 (27.) 69.1 (28.) 72.4 (21.)				
Trefferlage	0.50 mm rechts, 0.05 mm tief				
Streuwert	0.99, horizontal: 0.86, vertikal: 1.10				

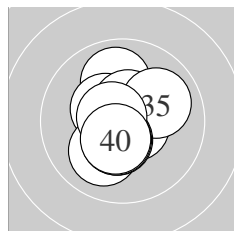

Serie 4:	9.9 ↑	10.6 *	10.4 *	10.5 *	10.0 ↗
	10.1 ↗	10.5 *	10.4 *	10.7 *	10.5 *
beste Teiler	74.6 (39.) 80.7 (32.) 108.4 (34.)				
Trefferlage	0.14 mm links, 0.00 mm				
Streuwert	1.20, horizontal: 0.99, vertikal: 1.38				

Unterschrift des Schützen

Ergebnis: **418.6** (399)  
 Serien: 103.8 105.3 104.5 105.0  
 Zähler: 39 1 0 0 0 0 0 0 0 0  
 Innenzehner: 35  
 weiteste: 301 (3), 245 (1), 235 (26)  
 beste Teiler 4.4 (8.) 37.5 (21.) 38.0 (17.)  
 Trefferlage 0.08 mm links, 0.22 mm hoch  
 Streuwert 0.98, horizontal: 0.97, vertikal: 0.98

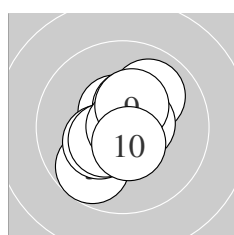
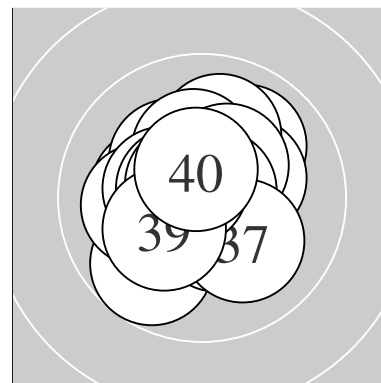

Serie 1:  
 10.0 ↗ 10.5 \* 9.7 ↘ 10.3 \* 10.6 \*  
 10.4 \* 10.5 \* 10.9 \* 10.4 \* 10.5 \*  
 beste Teiler 4.4 (8.) 97.5 (5.) 102.8 (2.)  
 Trefferlage 0.08 mm links, 0.04 mm hoch  
 Streuwert 1.21, horizontal: 1.08, vertikal: 1.32

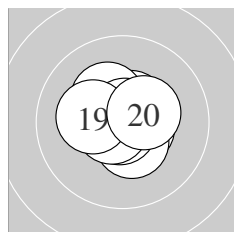

Serie 2:  
 10.6 \* 10.5 \* 10.6 \* 10.4 \* 10.3 \*  
 10.8 \* 10.8 \* 10.7 \* 10.2 \* 10.4 \*  
 beste Teiler 38.0 (17.) 44.2 (16.) 71.5 (18.)  
 Trefferlage 0.03 mm rechts, 0.08 mm hoch  
 Streuwert 0.86, horizontal: 0.93, vertikal: 0.77

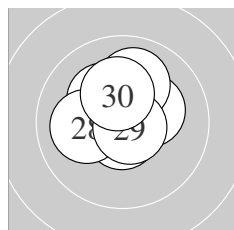

Serie 3:  
 10.8 \* 10.6 \* 10.8 \* 10.7 \* 10.3 \*  
 10.0 ↑ 10.2 \* 10.1 ← 10.7 \* 10.3 \*  
 beste Teiler 37.5 (21.) 42.7 (23.) 53.8 (29.)  
 Trefferlage 0.12 mm links, 0.61 mm hoch  
 Streuwert 0.98, horizontal: 1.02, vertikal: 0.94

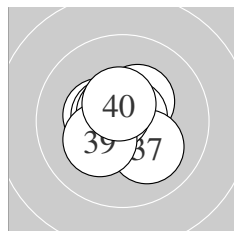

Serie 4:  
 10.7 \* 10.4 \* 10.7 \* 10.7 \* 10.4 \*  
 10.6 \* 10.1 ↘ 10.7 \* 10.2 \* 10.5 \*  
 beste Teiler 53.7 (34.) 62.9 (31.) 67.1 (33.)  
 Trefferlage 0.17 mm links, 0.13 mm hoch  
 Streuwert 0.92, horizontal: 0.98, vertikal: 0.86

Unterschrift des Schützen

Ergebnis: **416.7** (400)  
 Serien: 105.1 103.6 104.6 103.4  
 Zähler: 40 0 0 0 0 0 0 0 0 0  
 Innenzehner: 32  
 weiteste: 249 (39), 243 (31), 240 (2)  
 beste Teiler 4.4 (14.) 23.0 (28.) 24.1 (30.)  
 Trefferlage 0.05 mm rechts, 0.38 mm hoch  
 Streuwert 1.05, horizontal: 1.22, vertikal: 0.84

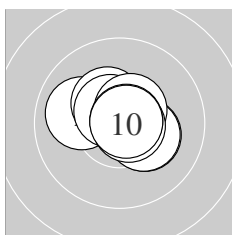
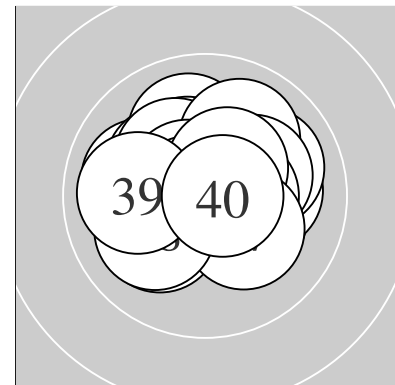

Serie 1:  
 10.7 \*                      10.0 ←                      10.4 \*                      10.6 \*                      10.3 \*  
 10.3 \*                      10.5 \*                      10.7 \*                      10.8 \*                      10.8 \*  
 beste Teiler 41.9 (10.) 43.6 (9.) 55.2 (1.)  
 Trefferlage 0.13 mm rechts, 0.25 mm hoch  
 Streuwert 0.93, horizontal: 1.15, vertikal: 0.65

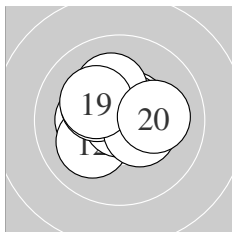

Serie 2:  
 10.3 \*                      10.1 ↙                      10.5 \*                      10.9 \*                      10.6 \*  
 10.3 \*                      10.4 \*                      10.2 \*                      10.2 \*                      10.1 →  
 beste Teiler 4.4 (14.) 84.8 (15.) 105.3 (13.)  
 Trefferlage 0.20 mm links, 0.35 mm hoch  
 Streuwert 1.16, horizontal: 1.36, vertikal: 0.91

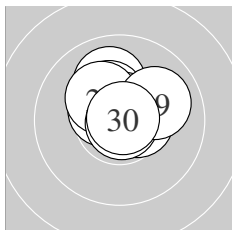

Serie 3:  
 10.0 ↑                      10.6 \*                      10.3 \*                      10.7 \*                      10.5 \*  
 10.5 \*                      10.2 \*                      10.9 \*                      10.0 ↗                      10.9 \*  
 beste Teiler 23.0 (28.) 24.1 (30.) 73.8 (24.)  
 Trefferlage 0.13 mm rechts, 0.73 mm hoch  
 Streuwert 0.92, horizontal: 1.03, vertikal: 0.80

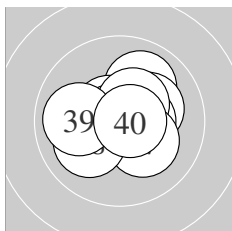

Serie 4:  
 10.0 ↗                      10.2 \*                      10.6 \*                      10.5 \*                      10.7 \*  
 10.4 \*                      10.2 \*                      10.1 ↙                      10.0 ←                      10.7 \*  
 beste Teiler 51.0 (35.) 65.0 (40.) 85.7 (33.)  
 Trefferlage 0.16 mm rechts, 0.21 mm hoch  
 Streuwert 1.25, horizontal: 1.46, vertikal: 0.99

Unterschrift des Schützen

Meyton Elektronik

Ergebnis: **410.9** (392)  
 Serien: 103.2 103.0 101.9 102.8  
 Zähler: 32 8 0 0 0 0 0 0 0 0  
 Innenzehner: 27  
 weiteste: 329 (37), 320 (8), 309 (34)  
 beste Teiler 34.0 (38.) 37.0 (13.) 50.0 (32.)  
 Trefferlage 0.25 mm links, 0.96 mm hoch  
 Streuwert 1.14, horizontal: 1.34, vertikal: 0.89

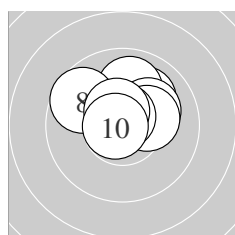
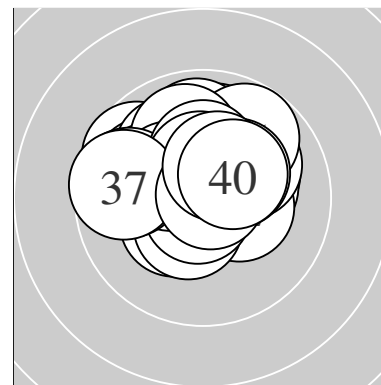

Serie 1:  
 10.0 ↗ 10.7 \* 10.3 \* 10.0 ↑ 10.2 \*  
 10.3 \* 10.7 \* 9.7 ↘ 10.5 \* 10.8 \*  
 beste Teiler 50.4 (10.) 60.0 (7.) 60.5 (2.)  
 Trefferlage 0.13 mm rechts, 1.09 mm hoch  
 Streuwert 1.08, horizontal: 1.32, vertikal: 0.76

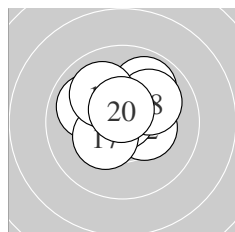

Serie 2:  
 10.6 \* 10.3 \* 10.8 \* 9.9 ↗ 10.6 \*  
 9.9 ↘ 10.3 \* 10.0 ↗ 10.0 ↘ 10.6 \*  
 beste Teiler 37.0 (13.) 86.4 (20.) 95.1 (11.)  
 Trefferlage 0.16 mm links, 0.73 mm hoch  
 Streuwert 1.20, horizontal: 1.38, vertikal: 0.99

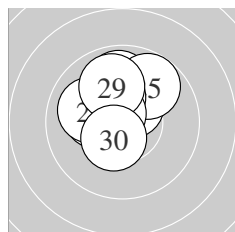

Serie 3:  
 10.4 \* 10.4 \* 9.9 ↑ 10.2 \* 9.8 ↗  
 10.2 \* 10.6 \* 10.0 ↘ 9.9 ↑ 10.5 \*  
 beste Teiler 87.0 (27.) 124.9 (30.) 129.2 (21.)  
 Trefferlage 0.54 mm links, 1.21 mm hoch  
 Streuwert 1.12, horizontal: 1.10, vertikal: 1.14

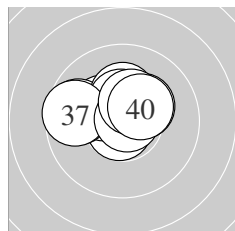

Serie 4:  
 10.3 \* 10.8 \* 10.3 \* 9.7 ↘ 10.2 \*  
 10.4 \* 9.6 ← 10.8 \* 10.4 \* 10.3 \*  
 beste Teiler 34.0 (38.) 50.0 (32.) 130.5 (36.)  
 Trefferlage 0.45 mm links, 0.81 mm hoch  
 Streuwert 1.22, horizontal: 1.61, vertikal: 0.63

Unterschrift des Schützen

Meyton Elektronik

Ergebnis: **415.6** (397)  
 Serien: 102.9 104.1 104.0 104.6  
 Zähler: 37 3 0 0 0 0 0 0 0 0  
 Innenzehner: 28  
 weiteste: 371 (29), 285 (18), 263 (3)  
 beste Teiler 10.4 (38.) 22.8 (25.) 36.4 (9.)  
 Trefferlage 0.15 mm links, 0.56 mm hoch  
 Streuwert 1.09, horizontal: 0.97, vertikal: 1.19

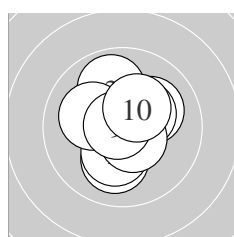
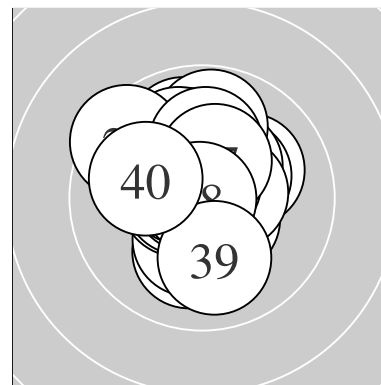

Serie 1:  
 10.1 ↓                      10.3 \*                      9.9 ↑                      10.4 \*                      10.1 ↗  
 10.3 \*                      10.6 \*                      10.1 ←                      10.8 \*                      10.3 \*  
 beste Teiler 36.4 (9.) 100.4 (7.) 126.5 (4.)  
 Trefferlage 0.16 mm rechts, 0.29 mm hoch  
 Streuwert 1.29, horizontal: 1.16, vertikal: 1.42

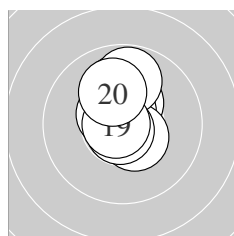

Serie 2:  
 10.6 \*                      10.4 \*                      10.6 \*                      10.5 \*                      10.8 \*  
 10.5 \*                      10.0 ↑                      9.8 ↑                      10.8 \*                      10.1 ↑  
 beste Teiler 43.0 (19.) 44.0 (15.) 77.4 (11.)  
 Trefferlage 0.05 mm links, 0.96 mm hoch  
 Streuwert 0.93, horizontal: 0.52, vertikal: 1.20

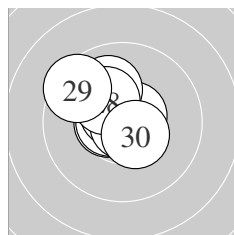

Serie 3:  
 10.5 \*                      10.6 \*                      10.6 \*                      10.6 \*                      10.9 \*  
 10.6 \*                      10.0 ↘                      10.2 \*                      9.5 ↖                      10.5 \*  
 beste Teiler 22.8 (25.) 79.4 (26.) 84.0 (23.)  
 Trefferlage 0.65 mm links, 0.66 mm hoch  
 Streuwert 1.04, horizontal: 1.08, vertikal: 1.01

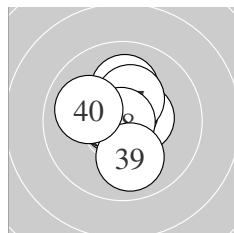

Serie 4:  
 10.8 \*                      10.5 \*                      10.1 ↑                      10.7 \*                      10.7 \*  
 10.6 \*                      10.3 \*                      10.9 \*                      10.0 ↓                      10.0 ←  
 beste Teiler 10.4 (38.) 43.1 (31.) 52.3 (34.)  
 Trefferlage 0.08 mm links, 0.33 mm hoch  
 Streuwert 1.06, horizontal: 0.93, vertikal: 1.17

Unterschrift des Schützen

Meyton Elektronik

Ergebnis: **414.1** (393)  
 Serien: 104.5 103.8 102.3 103.5  
 Zähler: 33 7 0 0 0 0 0 0 0 0  
 Innenzehner: 31  
 weiteste: 401 (29), 348 (40), 310 (25)  
 beste Teiler 18.0 (30.) 23.0 (4.) 34.5 (18.)  
 Trefferlage 0.05 mm links, 0.08 mm tief  
 Streuwert 1.25, horizontal: 1.42, vertikal: 1.04

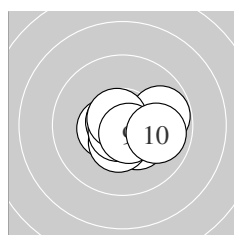
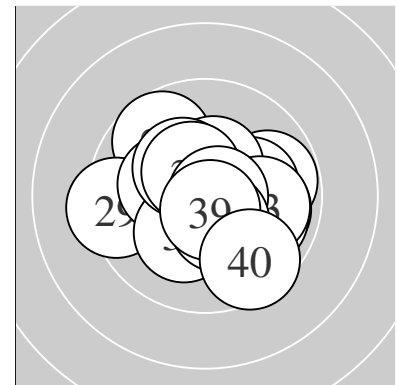

Serie 1:  
 9.8 → 10.5 \* 10.7 \* 10.9 \* 10.3 \*  
 10.4 \* 10.7 \* 10.7 \* 10.6 \* 9.9 →  
 beste Teiler 23.0 (4.) 56.6 (7.) 57.6 (3.)  
 Trefferlage 0.40 mm rechts, 0.30 mm tief  
 Streuwert 1.04, horizontal: 1.33, vertikal: 0.64

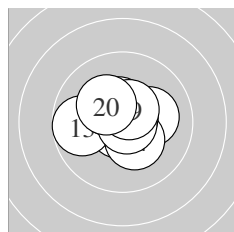

Serie 2:  
 10.1 → 10.7 \* 9.7 ← 10.3 \* 10.3 \*  
 10.7 \* 10.5 \* 10.8 \* 10.5 \* 10.2 \*  
 beste Teiler 34.5 (18.) 53.3 (12.) 55.9 (16.)  
 Trefferlage 0.17 mm links, 0.31 mm hoch  
 Streuwert 1.14, horizontal: 1.36, vertikal: 0.86

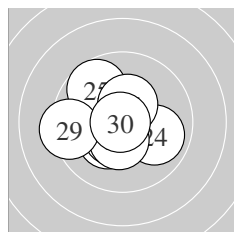

Serie 3:  
 10.3 \* 10.5 \* 10.4 \* 9.9 → 9.7 ↖  
 10.5 \* 10.4 \* 10.4 \* 9.3 ← 10.9 \*  
 beste Teiler 18.0 (30.) 105.9 (22.) 121.7 (26.)  
 Trefferlage 0.63 mm links, 0.02 mm hoch  
 Streuwert 1.48, horizontal: 1.66, vertikal: 1.27

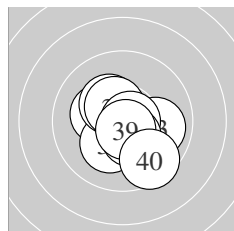

Serie 4:  
 10.3 \* 10.2 \* 10.0 → 10.3 \* 10.8 \*  
 10.5 \* 10.7 \* 10.4 \* 10.7 \* 9.6 ↘  
 beste Teiler 36.3 (35.) 58.0 (37.) 68.0 (39.)  
 Trefferlage 0.16 mm rechts, 0.35 mm tief  
 Streuwert 1.30, horizontal: 1.32, vertikal: 1.28

Unterschrift des Schützen

Ergebnis: **416.6** (397)  
 Serien: 104.2 104.1 104.0 104.3  
 Zähler: 37 3 0 0 0 0 0 0 0 0  
 Innenzehner: 32  
 weiteste: 284 (23), 282 (35), 269 (19)  
 beste Teiler 7.0 (28.) 36.2 (5.) 45.1 (18.)  
 Trefferlage 0.31 mm rechts, 0.25 mm tief  
 Streuwert 1.03, horizontal: 1.11, vertikal: 0.94

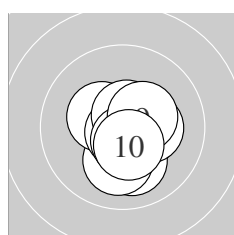
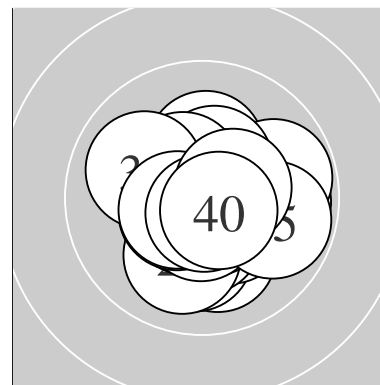

Serie 1:  
 10.4 \* 10.1 ↓ 10.1 ↓ 10.4 \* 10.8 \*  
 10.6 \* 10.6 \* 10.3 \* 10.4 \* 10.5 \*  
 beste Teiler 36.2 (5.) 80.0 (6.) 86.3 (7.)  
 Trefferlage 0.39 mm rechts, 0.47 mm tief  
 Streuwert 0.98, horizontal: 0.88, vertikal: 1.07

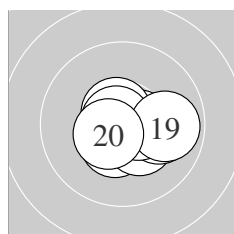

Serie 2:  
 10.4 \* 10.5 \* 10.5 \* 10.4 \* 10.0 →  
 10.5 \* 10.6 \* 10.8 \* 9.9 → 10.5 \*  
 beste Teiler 45.1 (18.) 83.2 (17.) 101.1 (16.)  
 Trefferlage 0.49 mm rechts, 0.39 mm tief  
 Streuwert 1.01, horizontal: 1.30, vertikal: 0.59

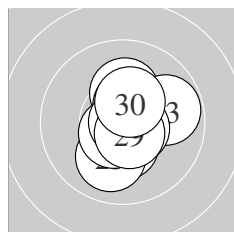

Serie 3:  
 10.4 \* 10.2 \* 9.8 → 10.5 \* 10.0 ↓  
 10.6 \* 10.6 \* 10.9 \* 10.6 \* 10.4 \*  
 beste Teiler 7.0 (28.) 84.3 (29.) 85.0 (26.)  
 Trefferlage 0.37 mm rechts, 0.04 mm tief  
 Streuwert 1.13, horizontal: 0.95, vertikal: 1.28

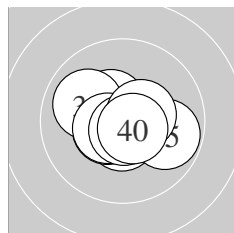

Serie 4:  
 10.6 \* 10.5 \* 10.7 \* 10.4 \* 9.8 →  
 10.0 ↖ 10.5 \* 10.7 \* 10.5 \* 10.6 \*  
 beste Teiler 58.5 (38.) 63.0 (33.) 80.0 (40.)  
 Trefferlage 0.01 mm rechts, 0.08 mm tief  
 Streuwert 1.10, horizontal: 1.36, vertikal: 0.75

Unterschrift des Schützen

Meyton Elektronik



Ergebnis: **415.9** (397)  
 Serien: 104.4 104.8 103.7 103.0  
 Zähler: 37 3 0 0 0 0 0 0 0 0  
 Innenzehner: 34  
 weiteste: 379 (33), 285 (2), 260 (35)  
 beste Teiler 11.6 (20.) 31.3 (18.) 35.4 (1.)  
 Trefferlage 0.03 mm links, 0.73 mm tief  
 Streuwert 1.00, horizontal: 1.02, vertikal: 0.98

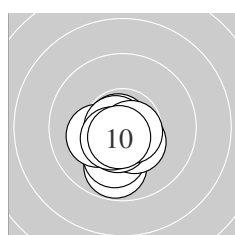
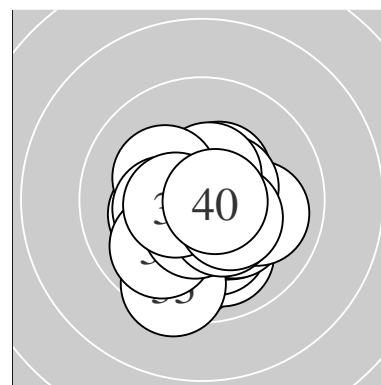

Serie 1:  
 10.8 \*                      9.8 ↓                      10.1 ↓                      10.2 \*                      10.4 \*  
 10.5 \*                      10.7 \*                      10.7 \*                      10.5 \*                      10.7 \*  
 beste Teiler 35.4 (1.) 51.0 (7.) 69.4 (8.)  
 Trefferlage 0.36 mm links, 0.92 mm tief  
 Streuwert 0.82, horizontal: 0.72, vertikal: 0.90

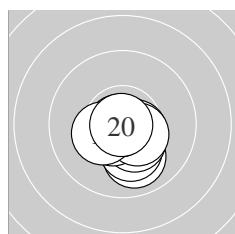

Serie 2:  
 10.0 ↓                      10.8 \*                      10.2 \*                      10.4 \*                      10.5 \*  
 10.5 \*                      10.4 \*                      10.8 \*                      10.3 \*                      10.9 \*  
 beste Teiler 11.6 (20.) 31.3 (18.) 49.6 (12.)  
 Trefferlage 0.21 mm rechts, 0.84 mm tief  
 Streuwert 0.77, horizontal: 0.81, vertikal: 0.73

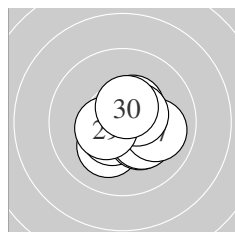

Serie 3:  
 10.2 \*                      10.4 \*                      10.5 \*                      10.3 \*                      10.3 \*  
 10.5 \*                      10.0 →                      10.5 \*                      10.5 \*                      10.5 \*  
 beste Teiler 111.1 (30.) 112.0 (23.) 116.2 (28.)  
 Trefferlage 0.51 mm rechts, 0.27 mm tief  
 Streuwert 1.07, horizontal: 1.15, vertikal: 0.98

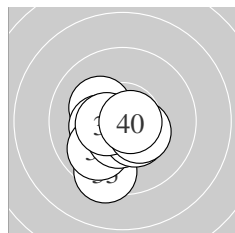

Serie 4:  
 10.2 \*                      10.3 \*                      9.4 ↓                      10.7 \*                      9.9 ↙  
 10.5 \*                      10.4 \*                      10.5 \*                      10.4 \*                      10.7 \*  
 beste Teiler 56.4 (40.) 72.2 (34.) 115.1 (38.)  
 Trefferlage 0.51 mm links, 0.88 mm tief  
 Streuwert 1.16, horizontal: 1.10, vertikal: 1.22

Unterschrift des Schützen

Meyton Elektronik

Ergebnis: **418.6** (400)  
 Serien: 104.4 105.0 105.2 104.0  
 Zähler: 40 0 0 0 0 0 0 0 0 0  
 Innenzehner: 35  
 weiteste: 250 (31), 248 (24), 240 (30)  
 beste Teiler 6.3 (15.) 20.5 (21.) 23.1 (28.)  
 Trefferlage 0.36 mm links, 0.05 mm hoch  
 Streuwert 0.96, horizontal: 0.82, vertikal: 1.08

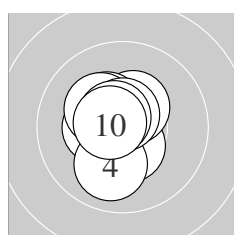
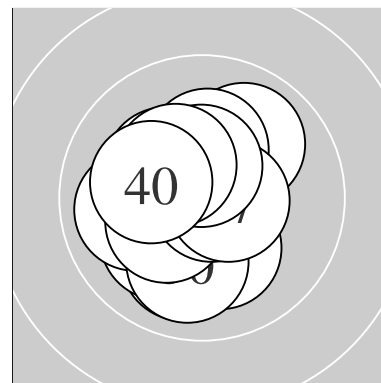

Serie 1:  
 10.6 \* 10.5 \* 10.4 \* 10.0 ↓ 10.4 \*  
 10.4 \* 10.3 \* 10.6 \* 10.6 \* 10.6 \*  
 beste Teiler 77.0 (8.) 78.7 (9.) 82.8 (10.)  
 Trefferlage 0.54 mm links, 0.24 mm hoch  
 Streuwert 0.93, horizontal: 0.69, vertikal: 1.12

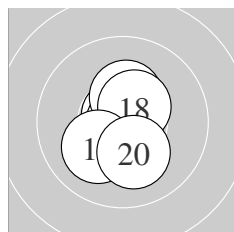

Serie 2:  
 10.4 \* 10.7 \* 10.8 \* 10.7 \* 10.9 \*  
 10.4 \* 10.3 \* 10.5 \* 10.1 ✓ 10.2 \*  
 beste Teiler 6.3 (15.) 48.8 (13.) 61.6 (14.)  
 Trefferlage 0.02 mm links, 0.41 mm tief  
 Streuwert 0.91, horizontal: 0.64, vertikal: 1.12

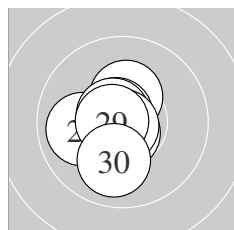

Serie 3:  
 10.9 \* 10.3 \* 10.7 \* 10.0 ← 10.3 \*  
 10.7 \* 10.7 \* 10.9 \* 10.7 \* 10.0 ↓  
 beste Teiler 20.5 (21.) 23.1 (28.) 62.4 (26.)  
 Trefferlage 0.58 mm links, 0.20 mm tief  
 Streuwert 0.90, horizontal: 0.78, vertikal: 1.01

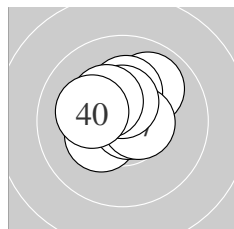

Serie 4:  
 10.0 ↗ 10.7 \* 10.4 \* 10.3 \* 10.2 \*  
 10.8 \* 10.6 \* 10.5 \* 10.3 \* 10.2 \*  
 beste Teiler 36.4 (36.) 54.0 (32.) 97.5 (37.)  
 Trefferlage 0.28 mm links, 0.60 mm hoch  
 Streuwert 1.00, horizontal: 1.08, vertikal: 0.92

Unterschrift des Schützen

Meyton Elektronik

Ergebnis: **419.4** (400)  
 Serien: 104.5 104.6 105.8 104.5  
 Zähler: 40 0 0 0 0 0 0 0 0 0  
 Innenzehner: 34  
 weiteste: 240 (10), 235 (38), 228 (31)  
 beste Teiler 12.1 (27.) 31.1 (7.) 38.8 (35.)  
 Trefferlage 0.06 mm links, 0.13 mm hoch  
 Streuwert 0.95, horizontal: 1.14, vertikal: 0.73

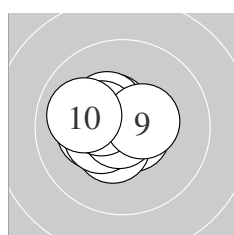
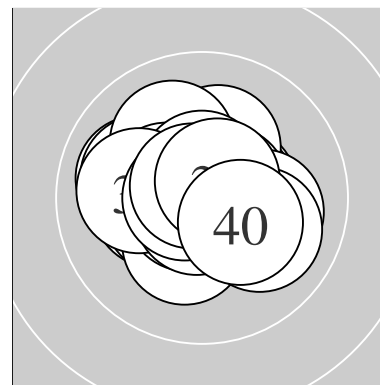

Serie 1:  
 10.7 \*                      10.5 \*                      10.3 \*                      10.4 \*                      10.5 \*  
 10.4 \*                      10.8 \*                      10.4 \*                      10.5 \*                      10.0 ↖  
 beste Teiler 31.1 (7.) 72.6 (1.) 111.3 (5.)  
 Trefferlage 0.70 mm links, 0.10 mm hoch  
 Streuwert 0.89, horizontal: 1.04, vertikal: 0.72

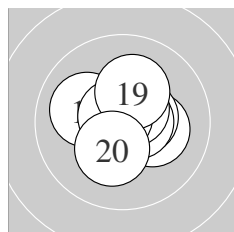

Serie 2:  
 10.7 \*                      10.7 \*                      10.2 \*                      10.5 \*                      10.6 \*  
 10.6 \*                      10.1 ↖                      10.7 \*                      10.2 \*                      10.3 \*  
 beste Teiler 55.6 (18.) 68.8 (11.) 71.6 (12.)  
 Trefferlage 0.16 mm rechts, 0.28 mm hoch  
 Streuwert 1.00, horizontal: 1.12, vertikal: 0.88

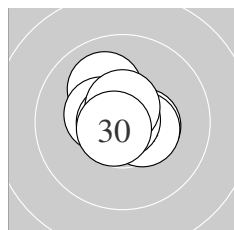

Serie 3:  
 10.7 \*                      10.1 ↖                      10.5 \*                      10.5 \*                      10.7 \*  
 10.4 \*                      10.9 \*                      10.7 \*                      10.6 \*                      10.7 \*  
 beste Teiler 12.1 (27.) 53.0 (28.) 61.3 (21.)  
 Trefferlage 0.09 mm links, 0.24 mm hoch  
 Streuwert 0.80, horizontal: 0.87, vertikal: 0.73

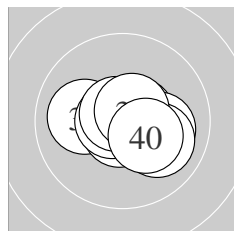

Serie 4:  
 10.0 ↖                      10.7 \*                      10.6 \*                      10.1 →                      10.8 \*  
 10.7 \*                      10.7 \*                      10.0 ↘                      10.6 \*                      10.3 \*  
 beste Teiler 38.8 (35.) 55.3 (32.) 55.4 (37.)  
 Trefferlage 0.36 mm rechts, 0.09 mm tief  
 Streuwert 1.04, horizontal: 1.34, vertikal: 0.61

Unterschrift des Schützen

Meyton Elektronik

Ergebnis: **416.2** (397)  
 Serien: 104.9 103.7 104.1 103.5  
 Zähler: 37 3 0 0 0 0 0 0 0 0  
 Innenzehner: 31  
 weiteste: 295 (20), 283 (35), 258 (24)  
 beste Teiler 22.8 (21.) 29.1 (30.) 33.2 (14.)  
 Trefferlage 0.09 mm rechts, 0.54 mm hoch  
 Streuwert 1.04, horizontal: 1.11, vertikal: 0.97

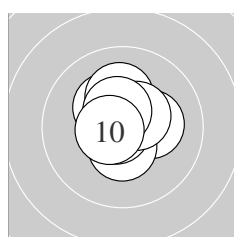
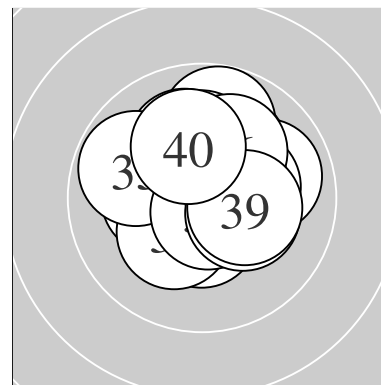

Serie 1:  
 10.2 \*                      10.4 \*                      10.7 \*                      10.8 \*                      10.3 \*  
 10.2 \*                      10.7 \*                      10.5 \*                      10.5 \*                      10.6 \*  
 beste Teiler 46.8 (4.) 66.5 (7.) 71.0 (3.)  
 Trefferlage 0.12 mm links, 0.42 mm hoch  
 Streuwert 0.88, horizontal: 0.85, vertikal: 0.91

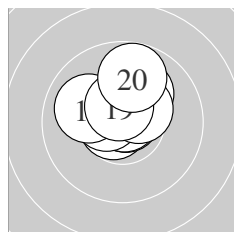

Serie 2:  
 10.1 ↗                      10.7 \*                      10.8 \*                      10.8 \*                      10.1 ↗  
 10.5 \*                      10.4 \*                      10.0 ↖                      10.5 \*                      9.8 ↑  
 beste Teiler 33.2 (14.) 35.0 (13.) 62.2 (12.)  
 Trefferlage 0.03 mm links, 1.03 mm hoch  
 Streuwert 0.99, horizontal: 1.03, vertikal: 0.96

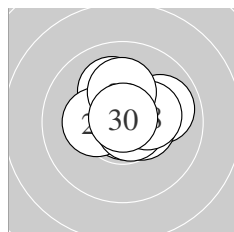

Serie 3:  
 10.9 \*                      10.4 \*                      10.1 ↖                      9.9 →                      10.5 \*  
 10.3 \*                      10.7 \*                      10.3 \*                      10.2 \*                      10.8 \*  
 beste Teiler 22.8 (21.) 29.1 (30.) 59.5 (27.)  
 Trefferlage 0.47 mm rechts, 0.50 mm hoch  
 Streuwert 1.04, horizontal: 1.20, vertikal: 0.86

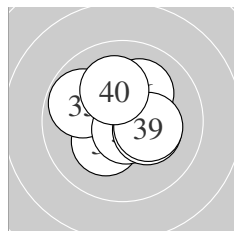

Serie 4:  
 10.8 \*                      10.6 \*                      10.3 \*                      10.5 \*                      9.8 ↖  
 10.1 ↗                      10.7 \*                      10.3 \*                      10.3 \*                      10.1 ↖  
 beste Teiler 42.5 (31.) 59.6 (37.) 86.9 (32.)  
 Trefferlage 0.08 mm rechts, 0.23 mm hoch  
 Streuwert 1.24, horizontal: 1.36, vertikal: 1.11

Unterschrift des Schützen

Meyton Elektronik

Ergebnis: **398.2** (381)  
 Serien: 97.0 100.0 101.0 100.2  
 Zähler: 22 17 1 0 0 0 0 0 0 0  
 Innenzehner: 17  
 weiteste: 556 (2), 478 (3), 469 (32)  
 beste Teiler 32.5 (26.) 70.9 (22.) 77.7 (37.)  
 Trefferlage 0.01 mm rechts, 0.34 mm tief  
 Streuwert 1.99, horizontal: 2.26, vertikal: 1.69

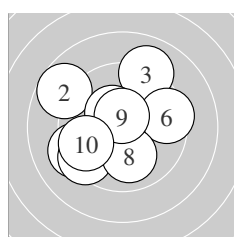
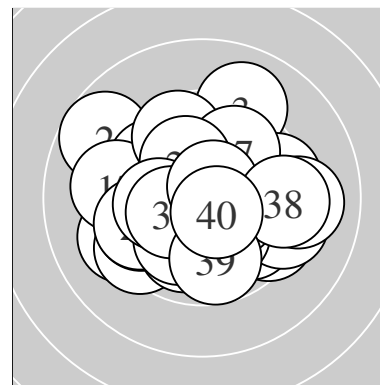

Serie 1:  
 9.2 ↙ 8.7 ↘ 9.0 ↗ 9.4 ↘ 10.4 \*  
 9.5 → 10.5 \* 10.0 ↓ 10.6 \* 9.7 ↙  
 beste Teiler 92.2 (9.) 124.7 (7.) 143.2 (5.)  
 Trefferlage 0.97 mm links, 0.11 mm hoch  
 Streuwert 2.49, horizontal: 2.65, vertikal: 2.32

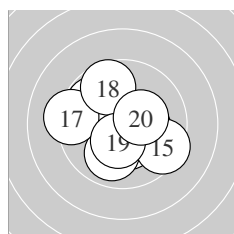

Serie 2:  
 10.3 \* 10.3 \* 9.8 ↘ 9.9 ↓ 9.5 ↘  
 10.5 \* 9.3 ← 9.7 ↘ 10.4 \* 10.3 \*  
 beste Teiler 101.1 (16.) 139.9 (19.) 152.7 (12.)  
 Trefferlage 0.25 mm links, 0.06 mm tief  
 Streuwert 1.92, horizontal: 2.13, vertikal: 1.70

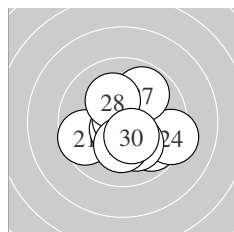

Serie 3:  
 9.6 ↙ 10.7 \* 9.8 ↘ 9.3 → 10.1 ↓  
 10.8 \* 9.9 ↗ 10.2 \* 10.2 \* 10.4 \*  
 beste Teiler 32.5 (26.) 70.9 (22.) 134.8 (30.)  
 Trefferlage 0.50 mm rechts, 0.52 mm tief  
 Streuwert 1.71, horizontal: 1.91, vertikal: 1.47

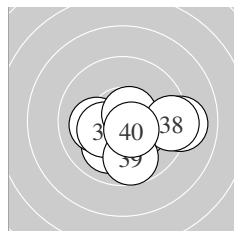

Serie 4:  
 10.0 ↓ 9.1 → 10.3 \* 10.1 ← 10.1 ↓  
 10.3 \* 10.6 \* 9.4 → 9.7 ↓ 10.6 \*  
 beste Teiler 77.7 (37.) 99.7 (40.) 159.3 (33.)  
 Trefferlage 0.77 mm rechts, 0.91 mm tief  
 Streuwert 1.72, horizontal: 2.19, vertikal: 1.06

Unterschrift des Schützen

Meyton Elektronik

Ergebnis: **414.2** (397)  
 Serien: 102.9 103.8 103.1 104.4  
 Zähler: 37 3 0 0 0 0 0 0 0 0  
 Innenzehner: 34  
 weiteste: 360 (1), 324 (21), 264 (11)  
 beste Teiler 38.6 (33.) 55.4 (12.) 56.0 (23.)  
 Trefferlage 0.20 mm rechts, 0.41 mm hoch  
 Streuwert 1.11, horizontal: 1.06, vertikal: 1.16

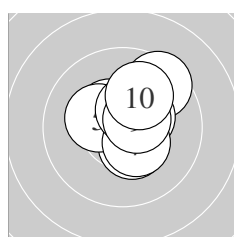
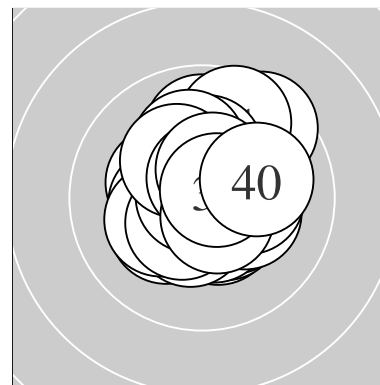

Serie 1:  
 9.5 ↗ 10.5 \* 10.4 \* 10.4 \* 10.3 \*  
 10.4 \* 10.4 \* 10.5 \* 10.5 \* 10.0 ↗  
 beste Teiler 107.9 (9.) 119.4 (2.) 123.4 (8.)  
 Trefferlage 0.62 mm rechts, 0.70 mm hoch  
 Streuwert 1.15, horizontal: 1.10, vertikal: 1.20

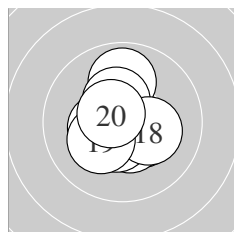

Serie 2:  
 9.9 ↑ 10.7 \* 10.4 \* 10.5 \* 10.5 \*  
 10.4 \* 10.4 \* 10.2 \* 10.2 \* 10.6 \*  
 beste Teiler 55.4 (12.) 94.4 (20.) 112.7 (15.)  
 Trefferlage 0.14 mm links, 0.07 mm tief  
 Streuwert 1.14, horizontal: 1.03, vertikal: 1.24

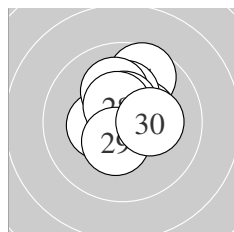

Serie 3:  
 9.7 ↗ 10.4 \* 10.7 \* 10.4 \* 10.2 \*  
 10.1 ↑ 10.5 \* 10.5 \* 10.4 \* 10.2 \*  
 beste Teiler 56.0 (23.) 111.4 (27.) 114.7 (28.)  
 Trefferlage 0.24 mm rechts, 0.81 mm hoch  
 Streuwert 1.14, horizontal: 1.01, vertikal: 1.25

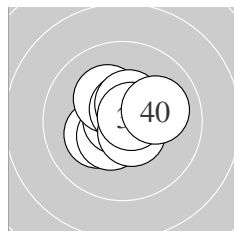

Serie 4:  
 10.2 \* 10.4 \* 10.8 \* 10.4 \* 10.2 \*  
 10.6 \* 10.6 \* 10.5 \* 10.7 \* 10.0 →  
 beste Teiler 38.6 (33.) 65.7 (39.) 79.1 (36.)  
 Trefferlage 0.12 mm rechts, 0.22 mm hoch  
 Streuwert 1.00, horizontal: 1.12, vertikal: 0.86

Unterschrift des Schützen

Ergebnis: **422.8** (400)  
 Serien: 105.4 105.8 105.4 106.2  
 Zähler: 40 0 0 0 0 0 0 0 0 0  
 Innenzehner: 39  
 weiteste: 245 (20), 176 (9), 174 (8)  
 beste Teiler 36.6 (19.) 40.8 (17.) 46.4 (34.)  
 Trefferlage 0.21 mm rechts, 0.11 mm hoch  
 Streuwert 0.74, horizontal: 0.71, vertikal: 0.77

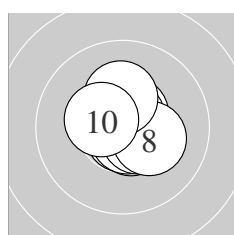
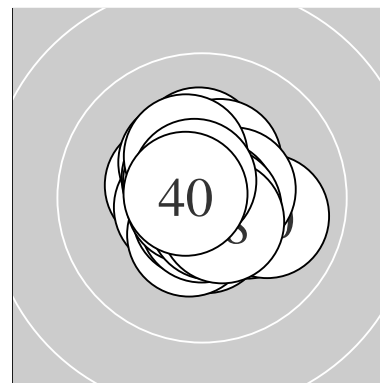

Serie 1:  
 10.6 \* 10.6 \* 10.6 \* 10.7 \* 10.8 \*  
 10.7 \* 10.5 \* 10.3 \* 10.2 \* 10.4 \*  
 beste Teiler 48.0 (5.) 63.8 (4.) 64.8 (6.)  
 Trefferlage 0.36 mm rechts, 0.07 mm hoch  
 Streuwert 0.79, horizontal: 0.76, vertikal: 0.82

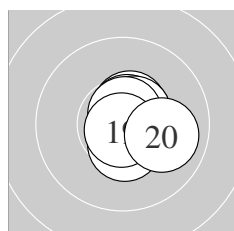

Serie 2:  
 10.6 \* 10.7 \* 10.5 \* 10.5 \* 10.6 \*  
 10.6 \* 10.8 \* 10.7 \* 10.8 \* 10.0 →  
 beste Teiler 36.6 (19.) 40.8 (17.) 63.5 (18.)  
 Trefferlage 0.56 mm rechts, 0.13 mm hoch  
 Streuwert 0.70, horizontal: 0.68, vertikal: 0.72

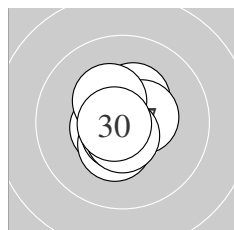

Serie 3:  
 10.5 \* 10.4 \* 10.6 \* 10.4 \* 10.7 \*  
 10.7 \* 10.5 \* 10.3 \* 10.6 \* 10.7 \*  
 beste Teiler 51.4 (30.) 62.0 (26.) 68.5 (25.)  
 Trefferlage 0.00 mm , 0.05 mm hoch  
 Streuwert 0.81, horizontal: 0.71, vertikal: 0.90

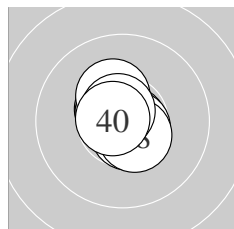

Serie 4:  
 10.6 \* 10.7 \* 10.6 \* 10.8 \* 10.7 \*  
 10.6 \* 10.3 \* 10.5 \* 10.7 \* 10.7 \*  
 beste Teiler 46.4 (34.) 55.5 (32.) 61.8 (40.)  
 Trefferlage 0.08 mm links, 0.19 mm hoch  
 Streuwert 0.65, horizontal: 0.56, vertikal: 0.73

Unterschrift des Schützen

Meyton Elektronik

Ergebnis: **412.9** (395)  
 Serien: 103.7 102.7 102.0 104.5  
 Zähler: 35 5 0 0 0 0 0 0 0 0  
 Innenzehner: 30  
 weiteste: 381 (18), 324 (21), 322 (24)  
 beste Teiler 10.2 (4.) 35.1 (1.) 52.1 (39.)  
 Trefferlage 0.34 mm rechts, 0.54 mm tief  
 Streuwert 1.19, horizontal: 1.14, vertikal: 1.24

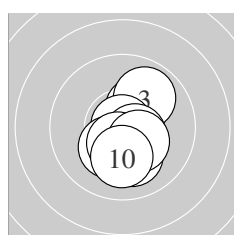
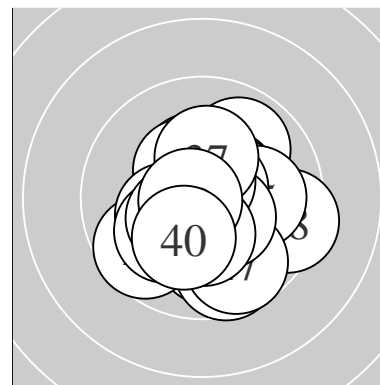

Serie 1:  
 10.8 \*                      10.3 \*                      9.9 ↗                      10.9 \*                      10.3 \*  
 10.1 ↓                      10.5 \*                      10.5 \*                      10.3 \*                      10.1 ↓  
 beste Teiler 10.2 (4.) 35.1 (1.) 105.1 (7.)  
 Trefferlage 0.42 mm rechts, 0.46 mm tief  
 Streuwert 1.13, horizontal: 0.77, vertikal: 1.39

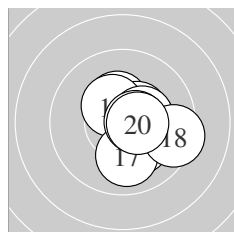

Serie 2:  
 10.4 \*                      10.5 \*                      10.4 \*                      10.3 \*                      10.4 \*  
 10.2 \*                      10.0 ↓                      9.4 →                      10.6 \*                      10.5 \*  
 beste Teiler 91.0 (19.) 108.2 (20.) 124.8 (12.)  
 Trefferlage 1.01 mm rechts, 0.13 mm tief  
 Streuwert 1.20, horizontal: 1.21, vertikal: 1.19

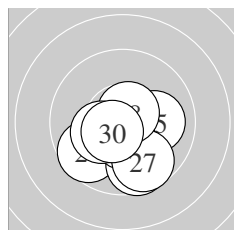

Serie 3:  
 9.7 ↙                      10.5 \*                      10.5 \*                      9.7 ↓                      10.0 →  
 10.5 \*                      9.7 ↓                      10.6 \*                      10.3 \*                      10.5 \*  
 beste Teiler 78.0 (28.) 101.2 (30.) 111.8 (23.)  
 Trefferlage 0.21 mm rechts, 1.16 mm tief  
 Streuwert 1.31, horizontal: 1.42, vertikal: 1.18

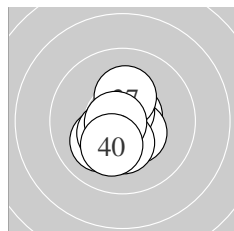

Serie 4:  
 10.7 \*                      10.4 \*                      10.1 ↙                      10.7 \*                      10.7 \*  
 10.4 \*                      10.3 \*                      10.3 \*                      10.7 \*                      10.2 \*  
 beste Teiler 52.1 (39.) 62.4 (35.) 71.2 (34.)  
 Trefferlage 0.25 mm links, 0.39 mm tief  
 Streuwert 0.96, horizontal: 0.77, vertikal: 1.11

Unterschrift des Schützen

Meyton Elektronik



Ergebnis: **414.1** (395)  
 Serien: 104.1 103.6 103.7 102.7  
 Zähler: 35 5 0 0 0 0 0 0 0 0  
 Innenzehner: 31  
 weiteste: 384 (25), 301 (40), 296 (8)  
 beste Teiler 10.0 (23.) 14.5 (4.) 36.3 (35.)  
 Trefferlage 0.28 mm rechts, 0.01 mm tief  
 Streuwert 1.22, horizontal: 1.19, vertikal: 1.24

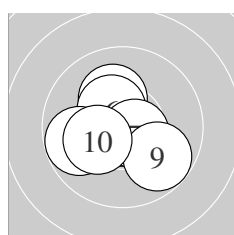
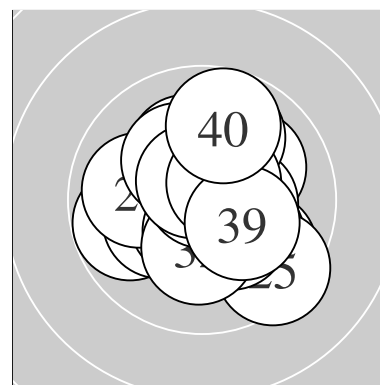

Serie 1:  
 10.8 \*                      10.6 \*                      10.8 \*                      10.9 \*                      10.2 \*  
 10.4 \*                      10.6 \*                      9.8 ←                      9.8 ↘                      10.2 \*  
 beste Teiler 14.5 (4.) 39.6 (3.) 43.4 (1.)  
 Trefferlage 0.42 mm links, 0.15 mm tief  
 Streuwert 1.22, horizontal: 1.36, vertikal: 1.05

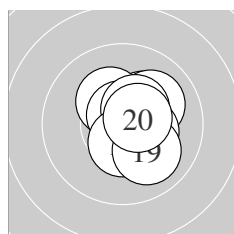

Serie 2:  
 10.6 \*                      10.2 \*                      10.3 \*                      10.1 ↗                      10.3 \*  
 10.7 \*                      10.4 \*                      10.5 \*                      10.0 ↘                      10.5 \*  
 beste Teiler 60.0 (16.) 97.8 (11.) 106.2 (20.)  
 Trefferlage 0.76 mm rechts, 0.33 mm hoch  
 Streuwert 0.98, horizontal: 0.85, vertikal: 1.10

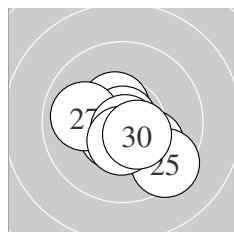

Serie 3:  
 10.5 \*                      10.5 \*                      10.9 \*                      10.0 ↘                      9.4 ↘  
 10.6 \*                      10.0 ←                      10.8 \*                      10.5 \*                      10.5 \*  
 beste Teiler 10.0 (23.) 48.3 (28.) 100.4 (26.)  
 Trefferlage 0.24 mm rechts, 0.68 mm tief  
 Streuwert 1.24, horizontal: 1.41, vertikal: 1.03

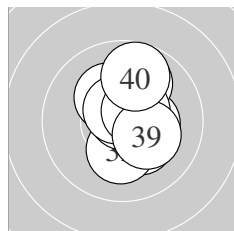

Serie 4:  
 10.3 \*                      10.2 \*                      10.3 \*                      10.2 \*                      10.8 \*  
 9.9 ↑                      10.6 \*                      10.5 \*                      10.2 \*                      9.7 ↑  
 beste Teiler 36.3 (35.) 82.3 (37.) 108.2 (38.)  
 Trefferlage 0.55 mm rechts, 0.45 mm hoch  
 Streuwert 1.25, horizontal: 0.84, vertikal: 1.55

Unterschrift des Schützen

Ergebnis: **417.5** (400)  
 Serien: 104.0 104.8 104.7 104.0  
 Zähler: 40 0 0 0 0 0 0 0 0 0  
 Innenzehner: 35  
 weiteste: 237 (10), 231 (19), 226 (28)  
 beste Teiler 47.1 (39.) 52.4 (26.) 54.1 (22.)  
 Trefferlage 0.07 mm links, 0.21 mm hoch  
 Streuwert 0.98, horizontal: 1.06, vertikal: 0.89

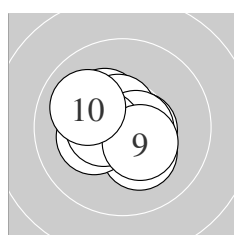
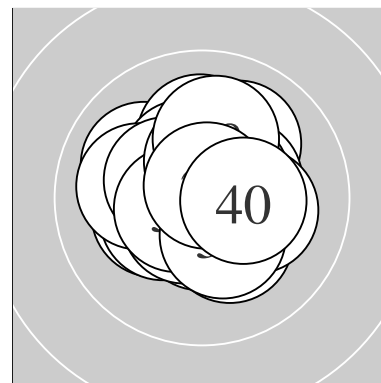

Serie 1:  
 10.3 \*                      10.5 \*                      10.7 \*                      10.6 \*                      10.2 \*  
 10.6 \*                      10.2 \*                      10.5 \*                      10.4 \*                      10.0 ↖  
 beste Teiler 56.0 (3.) 79.3 (6.) 93.0 (4.)  
 Trefferlage 0.29 mm links, 0.00 mm  
 Streuwert 1.05, horizontal: 1.19, vertikal: 0.89

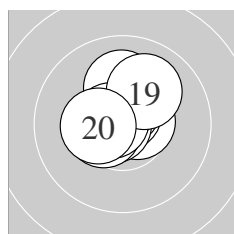

Serie 2:  
 10.6 \*                      10.7 \*                      10.6 \*                      10.7 \*                      10.5 \*  
 10.1 ↑                      10.5 \*                      10.7 \*                      10.0 ↗                      10.4 \*  
 beste Teiler 54.3 (14.) 67.4 (12.) 71.1 (18.)  
 Trefferlage 0.16 mm links, 0.68 mm hoch  
 Streuwert 0.85, horizontal: 0.83, vertikal: 0.87

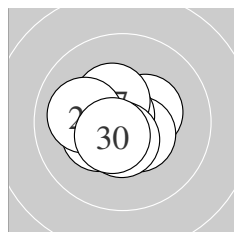

Serie 3:  
 10.6 \*                      10.7 \*                      10.4 \*                      10.5 \*                      10.3 \*  
 10.7 \*                      10.4 \*                      10.0 ←                      10.5 \*                      10.6 \*  
 beste Teiler 52.4 (26.) 54.1 (22.) 100.1 (21.)  
 Trefferlage 0.34 mm links, 0.07 mm tief  
 Streuwert 0.92, horizontal: 1.08, vertikal: 0.74

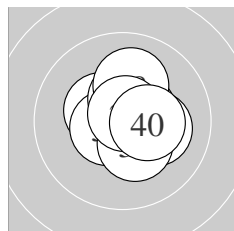

Serie 4:  
 10.4 \*                      10.6 \*                      10.4 \*                      10.3 \*                      10.2 \*  
 10.5 \*                      10.3 \*                      10.1 ↑                      10.8 \*                      10.4 \*  
 beste Teiler 47.1 (39.) 97.1 (32.) 109.6 (36.)  
 Trefferlage 0.52 mm rechts, 0.24 mm hoch  
 Streuwert 1.00, horizontal: 1.02, vertikal: 0.99

Unterschrift des Schützen

Meyton Elektronik

Ergebnis: **417.1** (397)  
 Serien: 104.4 103.8 104.4 104.5  
 Zähler: 37 3 0 0 0 0 0 0 0 0  
 Innenzehner: 35  
 weiteste: 301 (13), 280 (11), 260 (25)  
 beste Teiler 15.2 (36.) 30.0 (17.) 43.0 (19.)  
 Trefferlage 0.38 mm links, 0.37 mm tief  
 Streuwert 0.99, horizontal: 1.09, vertikal: 0.87

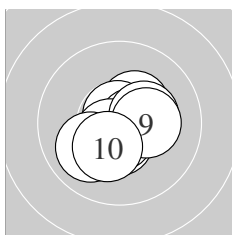
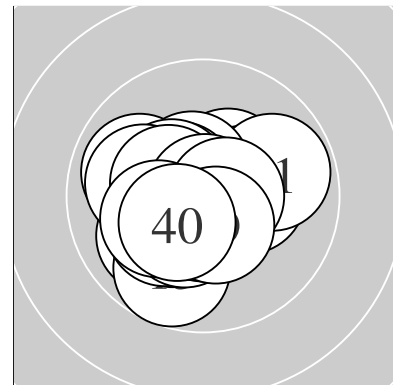

Serie 1:  
 10.4 \*                      10.8 \*                      10.5 \*                      10.6 \*                      10.6 \*  
 10.6 \*                      10.0 ↙                      10.3 \*                      10.3 \*                      10.3 \*  
 beste Teiler 49.7 (2.) 81.2 (5.) 88.0 (4.)  
 Trefferlage 0.15 mm rechts, 0.35 mm tief  
 Streuwert 1.02, horizontal: 1.12, vertikal: 0.90

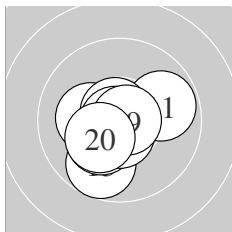

Serie 2:  
 9.8 →                      10.6 \*                      9.7 ↓                      10.2 \*                      10.3 \*  
 10.7 \*                      10.8 \*                      10.6 \*                      10.8 \*                      10.3 \*  
 beste Teiler 30.0 (17.) 43.0 (19.) 56.0 (16.)  
 Trefferlage 0.31 mm links, 0.53 mm tief  
 Streuwert 1.16, horizontal: 1.26, vertikal: 1.06

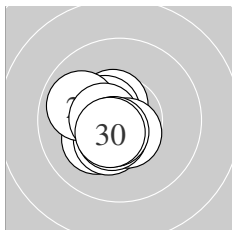

Serie 3:  
 10.2 \*                      10.5 \*                      10.5 \*                      10.4 \*                      9.9 ↖  
 10.6 \*                      10.6 \*                      10.5 \*                      10.6 \*                      10.6 \*  
 beste Teiler 82.7 (29.) 94.4 (27.) 99.8 (30.)  
 Trefferlage 0.80 mm links, 0.31 mm tief  
 Streuwert 0.83, horizontal: 0.76, vertikal: 0.89

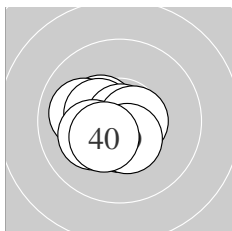

Serie 4:  
 10.6 \*                      10.4 \*                      10.0 ←                      10.4 \*                      10.5 \*  
 10.9 \*                      10.2 \*                      10.6 \*                      10.5 \*                      10.4 \*  
 beste Teiler 15.2 (36.) 84.6 (31.) 87.0 (38.)  
 Trefferlage 0.57 mm links, 0.30 mm tief  
 Streuwert 0.91, horizontal: 1.06, vertikal: 0.73

Unterschrift des Schützen

Ergebnis: **416.1** (396)  
 Serien: 103.5 105.7 103.3 103.6  
 Zähler: 36 4 0 0 0 0 0 0 0 0  
 Innenzehner: 32  
 weiteste: 295 (31), 280 (28), 258 (21)  
 beste Teiler 29.0 (6.) 33.0 (15.) 56.4 (23.)  
 Trefferlage 0.09 mm links, 0.13 mm hoch  
 Streuwert 1.09, horizontal: 1.12, vertikal: 1.06

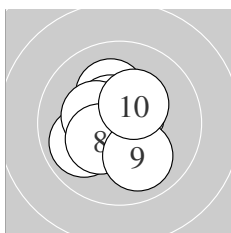
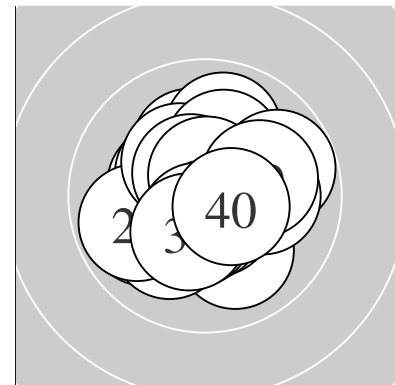

Serie 1:  
 9.9 ↙                      10.2 \*                      10.5 \*                      10.6 \*                      10.5 \*  
 10.8 \*                      10.3 \*                      10.3 \*                      10.0 ↘                      10.4 \*  
 beste Teiler 29.0 (6.) 79.0 (4.) 101.5 (5.)  
 Trefferlage 0.46 mm links, 0.10 mm hoch  
 Streuwert 1.15, horizontal: 1.10, vertikal: 1.21

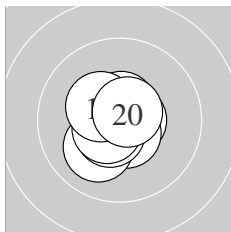

Serie 2:  
 10.6 \*                      10.6 \*                      10.7 \*                      10.6 \*                      10.8 \*  
 10.1 ↙                      10.6 \*                      10.6 \*                      10.4 \*                      10.7 \*  
 beste Teiler 33.0 (15.) 69.2 (13.) 72.1 (20.)  
 Trefferlage 0.30 mm links, 0.20 mm tief  
 Streuwert 0.78, horizontal: 0.73, vertikal: 0.82

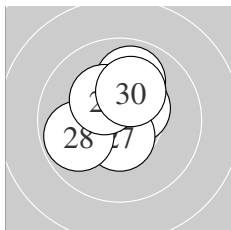

Serie 3:  
 9.9 ↑                      10.5 \*                      10.7 \*                      10.5 \*                      10.4 \*  
 10.5 \*                      10.5 \*                      9.8 ↙                      10.3 \*                      10.2 \*  
 beste Teiler 56.4 (23.) 102.0 (27.) 104.6 (24.)  
 Trefferlage 0.22 mm links, 0.62 mm hoch  
 Streuwert 1.15, horizontal: 1.11, vertikal: 1.19

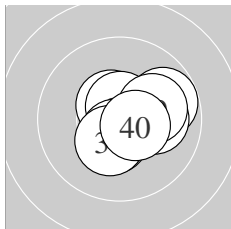

Serie 4:  
 9.8 →                      10.7 \*                      10.5 \*                      10.6 \*                      10.4 \*  
 10.1 →                      10.6 \*                      10.3 \*                      10.1 →                      10.5 \*  
 beste Teiler 63.3 (32.) 80.2 (34.) 100.4 (37.)  
 Trefferlage 0.61 mm rechts, 0.00 mm  
 Streuwert 1.13, horizontal: 1.29, vertikal: 0.94

Unterschrift des Schützen

Ergebnis: **413.7** (396)  
 Serien: 102.8 102.6 104.0 104.3  
 Zähler: 36 4 0 0 0 0 0 0 0 0  
 Innenzehner: 30  
 weiteste: 327 (16), 309 (15), 299 (31)  
 beste Teiler 12.1 (13.) 56.9 (28.) 59.2 (21.)  
 Trefferlage 0.09 mm links, 0.05 mm hoch  
 Streuwert 1.20, horizontal: 1.14, vertikal: 1.26

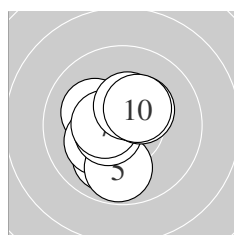
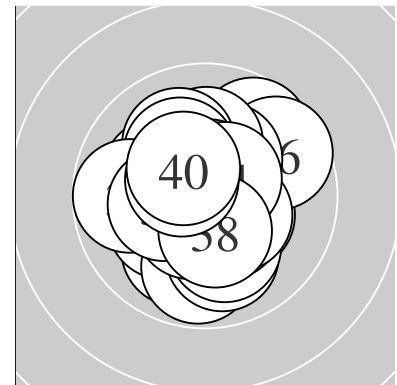

Serie 1:  
 10.6 \*                      10.0 ↘                      10.1 ↖                      10.2 \*                      9.8 ↓  
 10.5 \*                      10.5 \*                      10.3 \*                      10.4 \*                      10.4 \*  
 beste Teiler 94.0 (1.) 103.8 (6.) 116.1 (7.)  
 Trefferlage 0.44 mm links, 0.11 mm tief  
 Streuwert 1.27, horizontal: 1.05, vertikal: 1.45

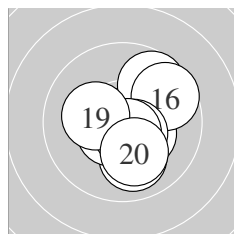

Serie 2:  
 10.0 ↓                      10.5 \*                      10.9 \*                      10.4 \*                      9.7 ↗  
 9.6 ↗                      10.5 \*                      10.7 \*                      10.2 \*                      10.1 ↓  
 beste Teiler 12.1 (13.) 75.6 (18.) 101.5 (12.)  
 Trefferlage 0.60 mm rechts, 0.25 mm tief  
 Streuwert 1.39, horizontal: 1.29, vertikal: 1.47

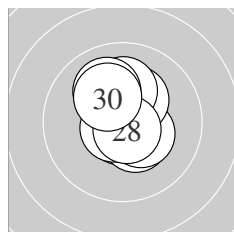

Serie 3:  
 10.7 \*                      10.5 \*                      10.4 \*                      10.4 \*                      10.3 \*  
 10.7 \*                      10.1 ↑                      10.7 \*                      10.0 ↖                      10.2 \*  
 beste Teiler 56.9 (28.) 59.2 (21.) 69.0 (26.)  
 Trefferlage 0.09 mm rechts, 0.48 mm hoch  
 Streuwert 1.04, horizontal: 0.78, vertikal: 1.25

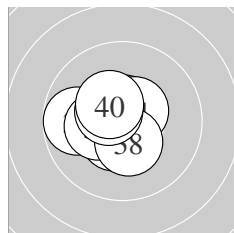

Serie 4:  
 9.8 ←                      10.7 \*                      10.6 \*                      10.5 \*                      10.5 \*  
 10.6 \*                      10.3 \*                      10.4 \*                      10.5 \*                      10.4 \*  
 beste Teiler 71.0 (32.) 79.9 (33.) 91.0 (36.)  
 Trefferlage 0.65 mm links, 0.11 mm hoch  
 Streuwert 0.97, horizontal: 1.09, vertikal: 0.83

Unterschrift des Schützen

Meyton Elektronik

Ergebnis: **416.1** (396)  
 Serien: 103.1 104.2 103.5 105.3  
 Zähler: 36 4 0 0 0 0 0 0 0 0  
 Innenzehner: 30  
 weiteste: 298 (18), 275 (27), 260 (5)  
 beste Teiler 9.8 (13.) 17.0 (35.) 49.2 (26.)  
 Trefferlage 0.12 mm links, 0.01 mm tief  
 Streuwert 1.12, horizontal: 1.20, vertikal: 1.04

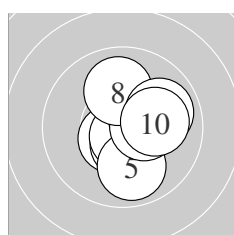
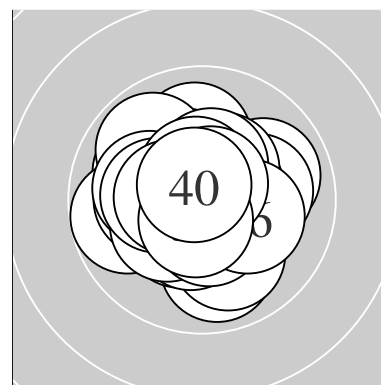

Serie 1:  
 10.6 \* 10.6 \* 10.5 \* 10.7 \* 9.9 ↓  
 10.4 \* 10.4 \* 10.0 ↑ 9.9 → 10.1 →  
 beste Teiler 59.4 (4.) 90.6 (2.) 100.5 (1.)  
 Trefferlage 0.78 mm rechts, 0.08 mm tief  
 Streuwert 1.18, horizontal: 1.01, vertikal: 1.32

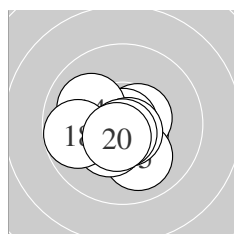

Serie 2:  
 10.6 \* 10.5 \* 10.9 \* 10.0 ↖ 10.0 ↓  
 10.4 \* 10.7 \* 9.8 ← 10.7 \* 10.6 \*  
 beste Teiler 9.8 (13.) 60.0 (19.) 63.0 (17.)  
 Trefferlage 0.30 mm links, 0.48 mm tief  
 Streuwert 1.11, horizontal: 1.31, vertikal: 0.87

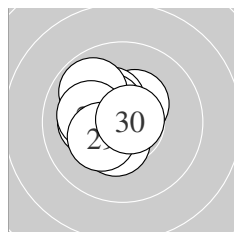

Serie 3:  
 10.4 \* 10.3 \* 10.4 \* 10.4 \* 10.1 ←  
 10.8 \* 9.9 ↘ 10.1 ← 10.3 \* 10.8 \*  
 beste Teiler 49.2 (26.) 50.9 (30.) 127.4 (23.)  
 Trefferlage 0.86 mm links, 0.39 mm hoch  
 Streuwert 1.01, horizontal: 1.00, vertikal: 1.02

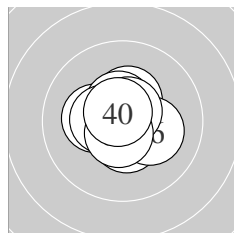

Serie 4:  
 10.3 \* 10.4 \* 10.5 \* 10.5 \* 10.9 \*  
 10.2 \* 10.5 \* 10.7 \* 10.6 \* 10.7 \*  
 beste Teiler 17.0 (35.) 66.6 (40.) 72.4 (38.)  
 Trefferlage 0.11 mm links, 0.14 mm hoch  
 Streuwert 0.88, horizontal: 0.95, vertikal: 0.80

Unterschrift des Schützen

Ergebnis: **416.3** (396)  
 Serien: 104.3 103.8 103.8 104.4  
 Zähler: 36 4 0 0 0 0 0 0 0 0  
 Innenzehner: 34  
 weiteste: 379 (26), 273 (18), 270 (31)  
 beste Teiler 15.2 (25.) 37.6 (10.) 41.4 (2.)  
 Trefferlage 0.06 mm links, 0.27 mm hoch  
 Streuwert 1.09, horizontal: 1.29, vertikal: 0.84

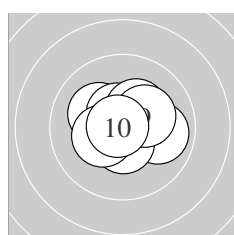
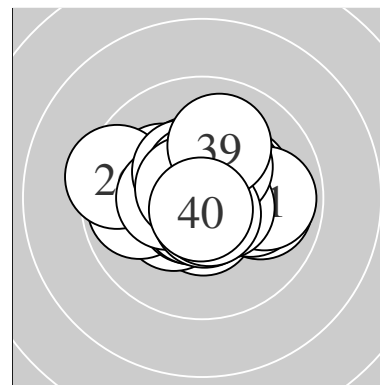

Serie 1:  
 9.9 → 10.8 \* 10.8 \* 10.2 \* 10.5 \*  
 10.5 \* 10.3 \* 10.3 \* 10.2 \* 10.8 \*  
 beste Teiler 37.6 (10.) 41.4 (2.) 45.2 (3.)  
 Trefferlage 0.16 mm rechts, 0.21 mm hoch  
 Streuwert 1.07, horizontal: 1.29, vertikal: 0.79

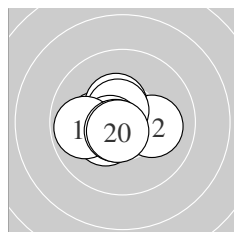

Serie 2:  
 10.2 \* 10.1 → 10.4 \* 10.6 \* 10.6 \*  
 10.4 \* 10.3 \* 9.9 ← 10.6 \* 10.7 \*  
 beste Teiler 74.3 (20.) 80.1 (19.) 92.8 (14.)  
 Trefferlage 0.74 mm links, 0.18 mm tief  
 Streuwert 1.02, horizontal: 1.25, vertikal: 0.71

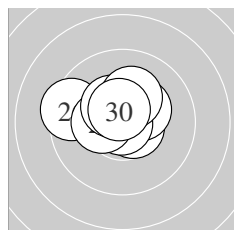

Serie 3:  
 10.4 \* 10.6 \* 10.6 \* 10.3 \* 10.9 \*  
 9.4 ← 10.4 \* 10.4 \* 10.2 \* 10.6 \*  
 beste Teiler 15.2 (25.) 85.4 (23.) 93.4 (30.)  
 Trefferlage 0.22 mm links, 0.69 mm hoch  
 Streuwert 1.15, horizontal: 1.47, vertikal: 0.70

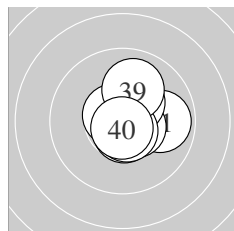

Serie 4:  
 9.9 → 10.5 \* 10.6 \* 10.5 \* 10.6 \*  
 10.3 \* 10.6 \* 10.6 \* 10.0 ↑ 10.8 \*  
 beste Teiler 50.2 (40.) 76.1 (37.) 77.7 (35.)  
 Trefferlage 0.56 mm rechts, 0.36 mm hoch  
 Streuwert 0.95, horizontal: 0.88, vertikal: 1.02

Unterschrift des Schützen

Meyton Elektronik

Ergebnis: **418.8** (399)  
 Serien: 103.6 105.7 105.1 104.4  
 Zähler: 39 1 0 0 0 0 0 0 0 0  
 Innenzehner: 35  
 weiteste: 262 (10), 226 (4), 208 (38)  
 beste Teiler 20.5 (18.) 29.7 (23.) 37.1 (28.)  
 Trefferlage 0.06 mm rechts, 0.16 mm hoch  
 Streuwert 0.94, horizontal: 0.97, vertikal: 0.90

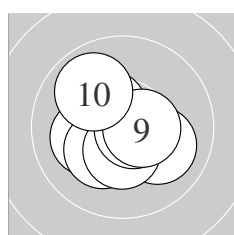
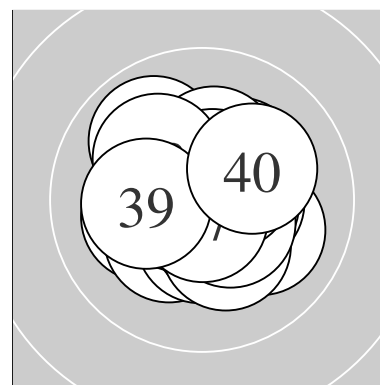

Serie 1:  
 10.6 \* 10.4 \* 10.7 \* 10.0 ↘ 10.1 ←  
 10.3 \* 10.4 \* 10.7 \* 10.5 \* 9.9 ↙  
 beste Teiler 63.5 (8.) 66.2 (3.) 96.1 (1.)  
 Trefferlage 0.31 mm links, 0.18 mm tief  
 Streuwert 1.16, horizontal: 1.25, vertikal: 1.06

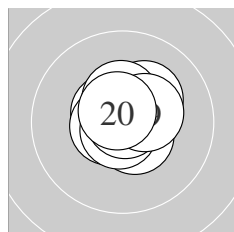

Serie 2:  
 10.6 \* 10.2 \* 10.4 \* 10.6 \* 10.6 \*  
 10.5 \* 10.8 \* 10.9 \* 10.4 \* 10.7 \*  
 beste Teiler 20.5 (18.) 49.6 (17.) 72.0 (20.)  
 Trefferlage 0.18 mm rechts, 0.24 mm hoch  
 Streuwert 0.75, horizontal: 0.75, vertikal: 0.75

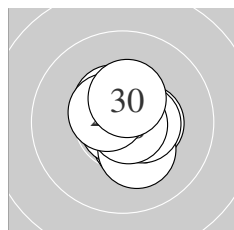

Serie 3:  
 10.5 \* 10.5 \* 10.8 \* 10.5 \* 10.4 \*  
 10.2 \* 10.5 \* 10.8 \* 10.5 \* 10.4 \*  
 beste Teiler 29.7 (23.) 37.1 (28.) 105.1 (29.)  
 Trefferlage 0.28 mm rechts, 0.08 mm hoch  
 Streuwert 0.84, horizontal: 0.70, vertikal: 0.95

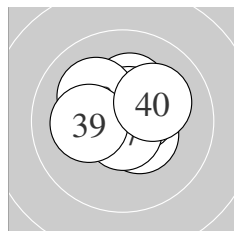

Serie 4:  
 10.6 \* 10.5 \* 10.3 \* 10.8 \* 10.6 \*  
 10.5 \* 10.7 \* 10.1 ↘ 10.2 \* 10.1 ↗  
 beste Teiler 47.4 (34.) 59.0 (37.) 77.8 (31.)  
 Trefferlage 0.10 mm rechts, 0.52 mm hoch  
 Streuwert 0.98, horizontal: 1.11, vertikal: 0.81

Unterschrift des Schützen



Ergebnis: **414.6** (397)  
 Serien: 103.2 103.1 103.7 104.6  
 Zähler: 37 3 0 0 0 0 0 0 0 0  
 Innenzehner: 31  
 weiteste: 416 (20), 284 (6), 267 (26)  
 beste Teiler 13.8 (39.) 22.0 (7.) 38.6 (18.)  
 Trefferlage 0.12 mm rechts, 0.11 mm hoch  
 Streuwert 1.20, horizontal: 1.27, vertikal: 1.12

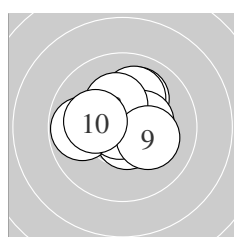
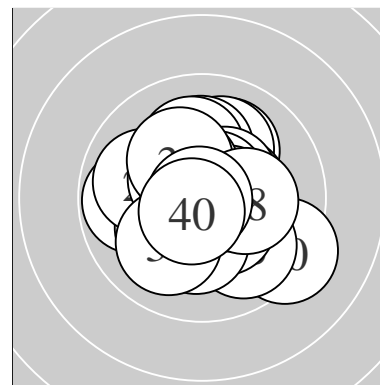

Serie 1:  
 10.6 \*                      10.1 ↗                      10.6 \*                      10.1 ↗                      10.4 \*  
 9.8 ←                      10.9 \*                      10.3 \*                      10.2 \*                      10.2 \*  
 beste Teiler 22.0 (7.) 76.0 (1.) 80.2 (3.)  
 Trefferlage 0.02 mm rechts, 0.41 mm hoch  
 Streuwert 1.29, horizontal: 1.46, vertikal: 1.10

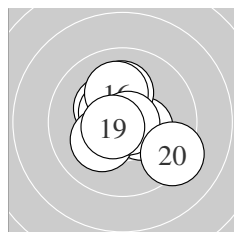

Serie 2:  
 10.3 \*                      10.5 \*                      10.8 \*                      10.4 \*                      10.1 ↑  
 10.1 ↑                      10.2 \*                      10.8 \*                      10.6 \*                      9.3 ↘  
 beste Teiler 38.6 (18.) 39.6 (13.) 76.9 (19.)  
 Trefferlage 0.02 mm rechts, 0.17 mm hoch  
 Streuwert 1.41, horizontal: 1.46, vertikal: 1.36

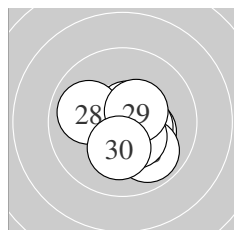

Serie 3:  
 10.7 \*                      10.7 \*                      10.6 \*                      10.3 \*                      10.4 \*  
 9.9 ↘                      10.4 \*                      10.0 ←                      10.5 \*                      10.2 \*  
 beste Teiler 60.6 (21.) 72.0 (22.) 79.0 (23.)  
 Trefferlage 0.55 mm rechts, 0.36 mm tief  
 Streuwert 1.10, horizontal: 1.19, vertikal: 1.01

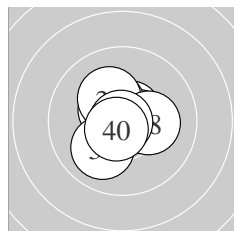

Serie 4:  
 10.5 \*                      10.6 \*                      10.6 \*                      10.5 \*                      10.4 \*  
 10.2 \*                      10.0 ↙                      10.2 \*                      10.9 \*                      10.7 \*  
 beste Teiler 13.8 (39.) 72.0 (40.) 78.6 (32.)  
 Trefferlage 0.11 mm links, 0.22 mm hoch  
 Streuwert 0.99, horizontal: 1.00, vertikal: 0.99

Unterschrift des Schützen

Meyton Elektronik

Ergebnis: **421.6** (400)  
 Serien: 105.1 106.6 105.6 104.3  
 Zähler: 40 0 0 0 0 0 0 0 0 0  
 Innenzehner: 36  
 weiteste: 225 (23), 223 (7), 221 (39)  
 beste Teiler 19.2 (26.) 25.9 (17.) 34.2 (36.)  
 Trefferlage 0.04 mm links, 0.10 mm hoch  
 Streuwert 0.84, horizontal: 0.67, vertikal: 0.98

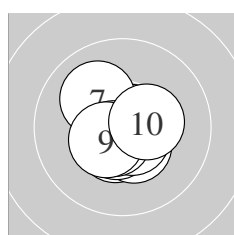
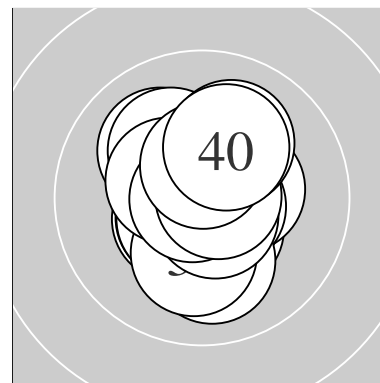

Serie 1:  
 10.5 \*                      10.4 \*                      10.7 \*                      10.6 \*                      10.7 \*  
 10.6 \*                      10.1 ↖                      10.6 \*                      10.5 \*                      10.4 \*  
 beste Teiler 54.8 (3.) 56.0 (5.) 82.8 (6.)  
 Trefferlage 0.01 mm links, 0.30 mm tief  
 Streuwert 0.86, horizontal: 0.87, vertikal: 0.85

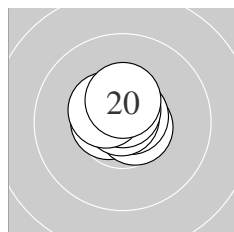

Serie 2:  
 10.7 \*                      10.8 \*                      10.6 \*                      10.6 \*                      10.7 \*  
 10.7 \*                      10.9 \*                      10.7 \*                      10.5 \*                      10.4 \*  
 beste Teiler 25.9 (17.) 43.0 (12.) 51.0 (15.)  
 Trefferlage 0.06 mm links, 0.41 mm hoch  
 Streuwert 0.50, horizontal: 0.55, vertikal: 0.43

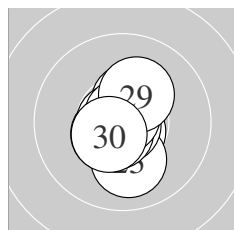

Serie 3:  
 10.5 \*                      10.7 \*                      10.1 ↓                      10.4 \*                      10.8 \*  
 10.9 \*                      10.7 \*                      10.8 \*                      10.2 \*                      10.5 \*  
 beste Teiler 19.2 (26.) 36.0 (28.) 49.0 (25.)  
 Trefferlage 0.06 mm links, 0.17 mm tief  
 Streuwert 0.86, horizontal: 0.55, vertikal: 1.08

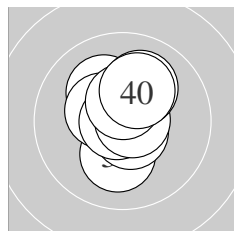

Serie 4:  
 10.7 \*                      10.2 \*                      10.1 ↖                      10.6 \*                      10.4 \*  
 10.8 \*                      10.7 \*                      10.5 \*                      10.1 ↗                      10.2 \*  
 beste Teiler 34.2 (36.) 56.5 (31.) 58.4 (37.)  
 Trefferlage 0.03 mm links, 0.50 mm hoch  
 Streuwert 1.02, horizontal: 0.77, vertikal: 1.22

Unterschrift des Schützen

Ergebnis: **410.0** (393)  
 Serien: 101.2 103.2 103.5 102.1  
 Zähler: 33 7 0 0 0 0 0 0 0 0  
 Innenzehner: 28  
 weiteste: 390 (36), 380 (6), 369 (12)  
 beste Teiler 38.3 (20.) 65.1 (26.) 72.1 (19.)  
 Trefferlage 0.44 mm rechts, 0.65 mm hoch  
 Streuwert 1.29, horizontal: 1.40, vertikal: 1.17

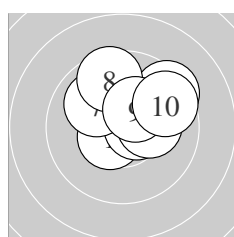
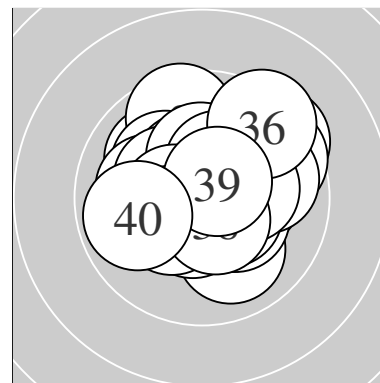

Serie 1:  
 10.5 \*                      10.5 \*                      10.4 \*                      10.6 \*                      10.2 \*  
 9.4 ↗                      10.0 ↘                      9.6 ↑                      10.4 \*                      9.6 ↗  
 beste Teiler 96.0 (4.) 108.4 (1.) 112.9 (2.)  
 Trefferlage 0.72 mm rechts, 1.16 mm hoch  
 Streuwert 1.39, horizontal: 1.59, vertikal: 1.16

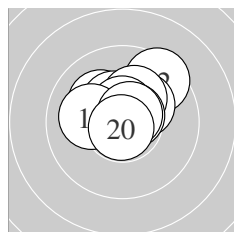

Serie 2:  
 10.1 ↘                      9.5 ↗                      10.2 \*                      10.4 \*                      10.2 \*  
 10.6 \*                      10.1 ←                      10.6 \*                      10.7 \*                      10.8 \*  
 beste Teiler 38.3 (20.) 72.1 (19.) 78.8 (18.)  
 Trefferlage 0.12 mm rechts, 1.01 mm hoch  
 Streuwert 1.12, horizontal: 1.32, vertikal: 0.87

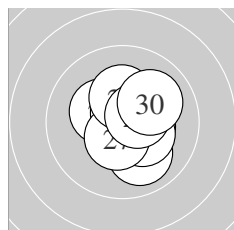

Serie 3:  
 10.0 ↘                      10.5 \*                      10.3 \*                      10.4 \*                      10.3 \*  
 10.7 \*                      10.5 \*                      10.3 \*                      10.5 \*                      10.0 ↗  
 beste Teiler 65.1 (26.) 111.4 (29.) 111.6 (27.)  
 Trefferlage 0.43 mm rechts, 0.15 mm hoch  
 Streuwert 1.13, horizontal: 1.07, vertikal: 1.19

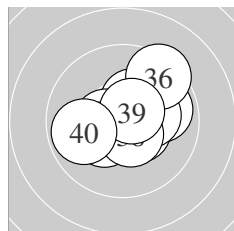

Serie 4:  
 10.3 \*                      10.5 \*                      9.9 →                      10.5 \*                      10.2 \*  
 9.4 ↗                      10.3 \*                      10.5 \*                      10.6 \*                      9.9 ←  
 beste Teiler 92.6 (39.) 106.0 (38.) 113.1 (34.)  
 Trefferlage 0.47 mm rechts, 0.30 mm hoch  
 Streuwert 1.48, horizontal: 1.69, vertikal: 1.24

Unterschrift des Schützen

Ergebnis: **416.8** (398)  
 Serien: 103.9 103.2 105.8 103.9  
 Zähler: 38 2 0 0 0 0 0 0 0 0  
 Innenzehner: 29  
 weiteste: 316 (19), 269 (36), 250 (11)  
 beste Teiler 17.8 (30.) 22.2 (32.) 27.2 (24.)  
 Trefferlage 0.18 mm links, 0.07 mm tief  
 Streuwert 1.11, horizontal: 1.21, vertikal: 0.99

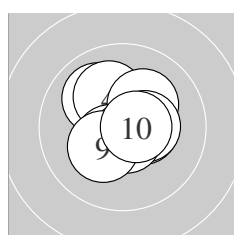
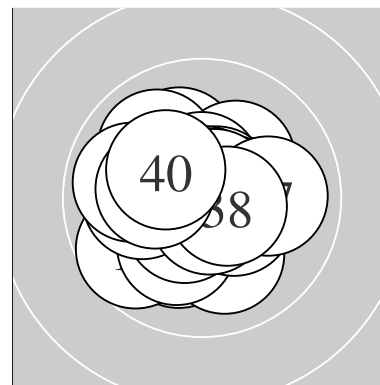

Serie 1:  
 10.7 \*                      10.4 \*                      10.0 ↘                      10.1 ↖                      10.2 \*  
 10.4 \*                      10.5 \*                      10.7 \*                      10.3 \*                      10.6 \*  
 beste Teiler 58.0 (1.) 68.3 (8.) 85.0 (10.)  
 Trefferlage 0.11 mm rechts, 0.24 mm hoch  
 Streuwert 1.11, horizontal: 1.13, vertikal: 1.10

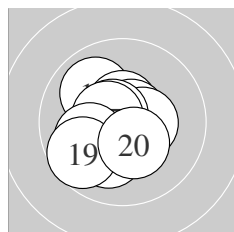

Serie 2:  
 10.0 ↘                      10.6 \*                      10.1 ↙                      10.7 \*                      10.5 \*  
 10.6 \*                      10.6 \*                      10.0 ↙                      9.7 ↙                      10.4 \*  
 beste Teiler 70.2 (14.) 77.4 (16.) 99.0 (12.)  
 Trefferlage 0.62 mm links, 0.21 mm tief  
 Streuwert 1.26, horizontal: 1.24, vertikal: 1.27

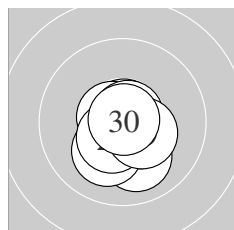

Serie 3:  
 10.8 \*                      10.7 \*                      10.0 ↘                      10.8 \*                      10.8 \*  
 10.1 ↙                      10.8 \*                      10.5 \*                      10.4 \*                      10.9 \*  
 beste Teiler 17.8 (30.) 27.2 (24.) 34.2 (25.)  
 Trefferlage 0.02 mm rechts, 0.48 mm tief  
 Streuwert 0.80, horizontal: 0.67, vertikal: 0.91

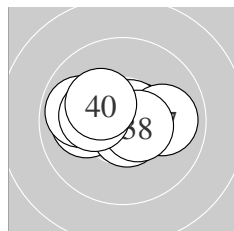

Serie 4:  
 10.6 \*                      10.9 \*                      10.0 ←                      10.7 \*                      10.7 \*  
 9.9 ←                      10.0 →                      10.6 \*                      10.2 \*                      10.3 \*  
 beste Teiler 22.2 (32.) 57.8 (35.) 69.8 (34.)  
 Trefferlage 0.26 mm links, 0.15 mm hoch  
 Streuwert 1.22, horizontal: 1.66, vertikal: 0.47

Unterschrift des Schützen

Meyton Elektronik

Ergebnis: **415.5** (399)  
 Serien: 102.7 105.1 103.2 104.5  
 Zähler: 39 1 0 0 0 0 0 0 0 0  
 Innenzehner: 36  
 weiteste: 314 (10), 245 (21), 244 (22)  
 beste Teiler 21.0 (23.) 42.0 (17.) 47.1 (36.)  
 Trefferlage 0.10 mm links, 0.10 mm tief  
 Streuwert 1.10, horizontal: 1.15, vertikal: 1.04

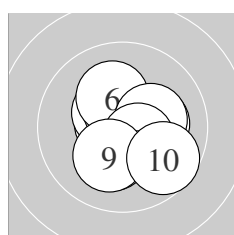
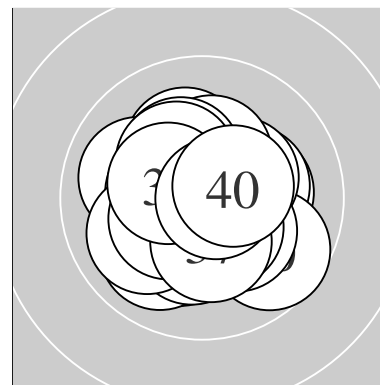

Serie 1:  
 10.6 \*                      10.4 \*                      10.2 \*                      10.2 \*                      10.5 \*  
 10.2 \*                      10.2 \*                      10.5 \*                      10.2 \*                      9.7 ↘  
 beste Teiler 76.2 (1.) 111.9 (5.) 121.6 (8.)  
 Trefferlage 0.32 mm rechts, 0.13 mm tief  
 Streuwert 1.31, horizontal: 1.31, vertikal: 1.32

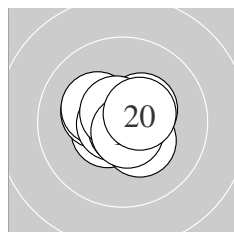

Serie 2:  
 10.5 \*                      10.3 \*                      10.4 \*                      10.2 \*                      10.3 \*  
 10.7 \*                      10.8 \*                      10.7 \*                      10.7 \*                      10.5 \*  
 beste Teiler 42.0 (17.) 61.3 (16.) 65.7 (19.)  
 Trefferlage 0.13 mm links, 0.05 mm hoch  
 Streuwert 0.89, horizontal: 1.04, vertikal: 0.71

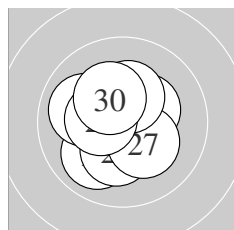

Serie 3:  
 10.0 ↙                      10.0 ↖                      10.9 \*                      10.3 \*                      10.3 \*  
 10.5 \*                      10.2 \*                      10.3 \*                      10.4 \*                      10.3 \*  
 beste Teiler 21.0 (23.) 101.4 (26.) 135.2 (29.)  
 Trefferlage 0.42 mm links, 0.01 mm hoch  
 Streuwert 1.22, horizontal: 1.21, vertikal: 1.24

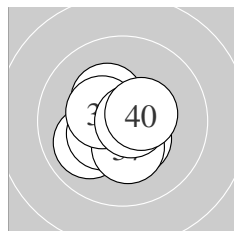

Serie 4:  
 10.0 ↙                      10.4 \*                      10.7 \*                      10.4 \*                      10.3 \*  
 10.8 \*                      10.3 \*                      10.4 \*                      10.7 \*                      10.5 \*  
 beste Teiler 47.1 (36.) 52.0 (39.) 68.5 (33.)  
 Trefferlage 0.19 mm links, 0.33 mm tief  
 Streuwert 1.00, horizontal: 1.07, vertikal: 0.92

Unterschrift des Schützen

Meyton Elektronik

Ergebnis: **416.9** (397)  
 Serien: 104.2 103.0 104.0 105.7  
 Zähler: 37 3 0 0 0 0 0 0 0 0  
 Innenzehner: 33  
 weiteste: 348 (22), 307 (15), 254 (19)  
 beste Teiler 45.5 (20.) 46.1 (38.) 46.4 (18.)  
 Trefferlage 0.10 mm links, 0.40 mm hoch  
 Streuwert 1.05, horizontal: 1.19, vertikal: 0.88

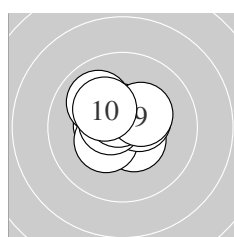
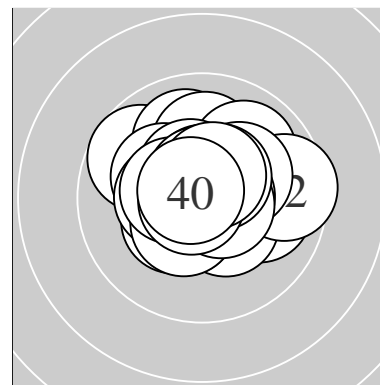

Serie 1:  
 10.5 \*                      10.7 \*                      10.0 ↘                      10.5 \*                      10.4 \*  
 10.4 \*                      10.6 \*                      10.6 \*                      10.3 \*                      10.2 \*  
 beste Teiler 69.8 (2.) 89.5 (7.) 89.5 (8.)  
 Trefferlage 0.35 mm links, 0.45 mm hoch  
 Streuwert 0.98, horizontal: 1.08, vertikal: 0.85

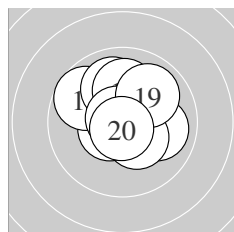

Serie 2:  
 10.0 →                      10.8 \*                      10.4 \*                      10.5 \*                      9.7 ↘  
 10.0 ↑                      10.1 ↑                      10.8 \*                      9.9 ↗                      10.8 \*  
 beste Teiler 45.5 (20.) 46.4 (18.) 50.6 (12.)  
 Trefferlage 0.05 mm rechts, 0.54 mm hoch  
 Streuwert 1.37, horizontal: 1.41, vertikal: 1.32

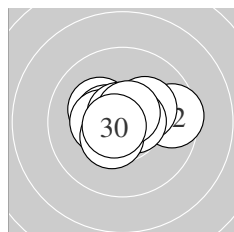

Serie 3:  
 10.2 \*                      9.6 →                      10.5 \*                      10.2 \*                      10.4 \*  
 10.7 \*                      10.6 \*                      10.4 \*                      10.7 \*                      10.7 \*  
 beste Teiler 59.9 (26.) 64.8 (30.) 75.8 (29.)  
 Trefferlage 0.04 mm rechts, 0.26 mm hoch  
 Streuwert 1.19, horizontal: 1.57, vertikal: 0.59

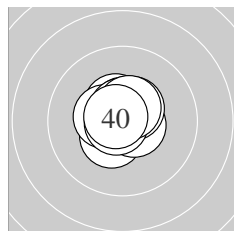

Serie 4:  
 10.5 \*                      10.4 \*                      10.6 \*                      10.5 \*                      10.6 \*  
 10.6 \*                      10.5 \*                      10.8 \*                      10.5 \*                      10.7 \*  
 beste Teiler 46.1 (38.) 57.1 (40.) 76.5 (36.)  
 Trefferlage 0.15 mm links, 0.36 mm hoch  
 Streuwert 0.67, horizontal: 0.65, vertikal: 0.68

Unterschrift des Schützen

Ergebnis: **417.9** (398)  
 Serien: 103.8 104.2 104.0 105.9  
 Zähler: 38 2 0 0 0 0 0 0 0 0  
 Innenzehner: 36  
 weiteste: 311 (8), 253 (28), 211 (21)  
 beste Teiler 27.0 (34.) 32.3 (22.) 45.1 (1.)  
 Trefferlage 0.39 mm links, 0.35 mm hoch  
 Streuwert 0.92, horizontal: 0.90, vertikal: 0.93

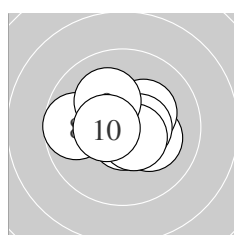
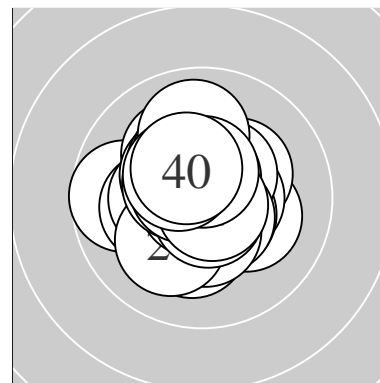

Serie 1:  
 10.8 \*                      10.2 \*                      10.3 \*                      10.4 \*                      10.7 \*  
 10.5 \*                      10.6 \*                      9.7 ←                      10.1 ↗                      10.5 \*  
 beste Teiler 45.1 (1.) 64.4 (5.) 100.5 (7.)  
 Trefferlage 0.19 mm links, 0.10 mm hoch  
 Streuwert 1.20, horizontal: 1.51, vertikal: 0.77

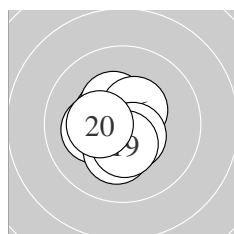

Serie 2:  
 10.7 \*                      10.5 \*                      10.5 \*                      10.2 \*                      10.4 \*  
 10.5 \*                      10.5 \*                      10.2 \*                      10.4 \*                      10.3 \*  
 beste Teiler 51.0 (11.) 104.2 (17.) 114.5 (13.)  
 Trefferlage 0.44 mm links, 0.01 mm hoch  
 Streuwert 0.97, horizontal: 0.87, vertikal: 1.06

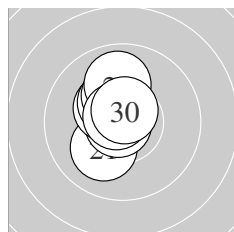

Serie 3:  
 10.1 ↘                      10.8 \*                      10.5 \*                      10.4 \*                      10.5 \*  
 10.3 \*                      10.2 \*                      9.9 ↑                      10.7 \*                      10.6 \*  
 beste Teiler 32.3 (22.) 57.3 (29.) 80.0 (30.)  
 Trefferlage 0.55 mm links, 0.80 mm hoch  
 Streuwert 0.85, horizontal: 0.40, vertikal: 1.14

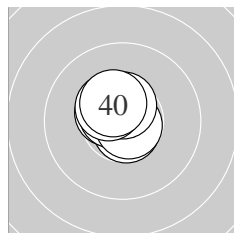

Serie 4:  
 10.7 \*                      10.5 \*                      10.5 \*                      10.8 \*                      10.7 \*  
 10.6 \*                      10.8 \*                      10.5 \*                      10.4 \*                      10.4 \*  
 beste Teiler 27.0 (34.) 50.2 (37.) 61.3 (31.)  
 Trefferlage 0.38 mm links, 0.47 mm hoch  
 Streuwert 0.53, horizontal: 0.51, vertikal: 0.56

Unterschrift des Schützen

Meyton Elektronik

Ergebnis: **414.2** (396)  
 Serien: 102.6 104.0 103.6 104.0  
 Zähler: 36 4 0 0 0 0 0 0 0 0  
 Innenzehner: 31  
 weiteste: 305 (7), 284 (6), 270 (15)  
 beste Teiler 31.0 (18.) 43.0 (20.) 47.0 (9.)  
 Trefferlage 0.17 mm rechts, 0.08 mm tief  
 Streuwert 1.16, horizontal: 1.02, vertikal: 1.29

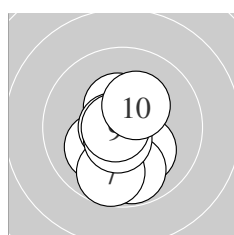
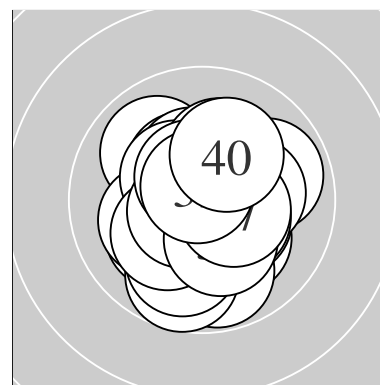

Serie 1:  
 10.4 \*                      10.0 ↓                      10.1 ↙                      10.7 \*                      10.2 \*  
 9.8 ↓                      9.7 ↓                      10.6 \*                      10.8 \*                      10.3 \*  
 beste Teiler 47.0 (9.) 67.0 (4.) 82.4 (8.)  
 Trefferlage 0.06 mm links, 0.88 mm tief  
 Streuwert 1.27, horizontal: 0.90, vertikal: 1.56

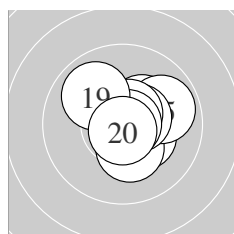

Serie 2:  
 10.3 \*                      10.3 \*                      10.6 \*                      10.3 \*                      9.9 →  
 10.5 \*                      10.6 \*                      10.8 \*                      9.9 ↘                      10.8 \*  
 beste Teiler 31.0 (18.) 43.0 (20.) 80.1 (17.)  
 Trefferlage 0.62 mm rechts, 0.25 mm hoch  
 Streuwert 1.04, horizontal: 1.10, vertikal: 0.98

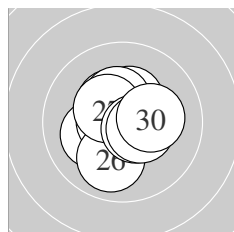

Serie 3:  
 10.1 ↙                      10.4 \*                      10.4 \*                      10.6 \*                      10.4 \*  
 10.0 ↓                      10.4 \*                      10.6 \*                      10.5 \*                      10.2 \*  
 beste Teiler 80.0 (24.) 93.9 (28.) 124.0 (29.)  
 Trefferlage 0.12 mm links, 0.12 mm hoch  
 Streuwert 1.17, horizontal: 1.15, vertikal: 1.19

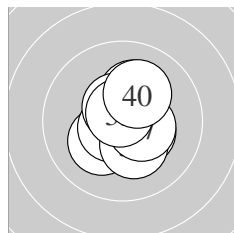

Serie 4:  
 10.2 \*                      10.4 \*                      10.5 \*                      10.2 \*                      10.6 \*  
 10.3 \*                      10.4 \*                      10.6 \*                      10.7 \*                      10.1 ↗  
 beste Teiler 56.9 (39.) 83.5 (35.) 100.2 (38.)  
 Trefferlage 0.28 mm rechts, 0.15 mm hoch  
 Streuwert 1.06, horizontal: 0.90, vertikal: 1.20

Unterschrift des Schützen



Ergebnis: **418.0** (398)  
 Serien: 104.7 104.5 104.8 104.0  
 Zähler: 38 2 0 0 0 0 0 0 0 0  
 Innenzehner: 31  
 weiteste: 282 (18), 261 (23), 248 (2)  
 beste Teiler 26.2 (27.) 26.3 (14.) 29.7 (25.)  
 Trefferlage 0.10 mm links, 0.06 mm hoch  
 Streuwert 1.04, horizontal: 0.96, vertikal: 1.11

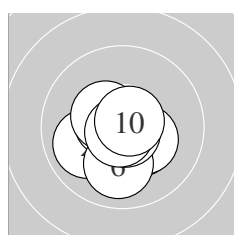
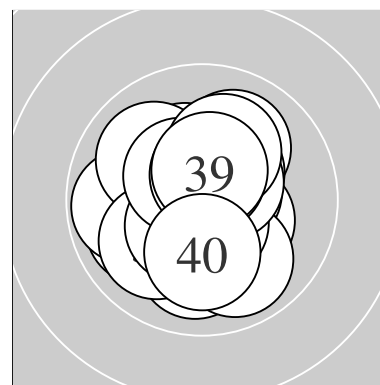

Serie 1:  
 10.4 \*                      10.0 ←                      10.7 \*                      10.6 \*                      10.3 \*  
 10.0 ↓                      10.4 \*                      10.8 \*                      10.8 \*                      10.7 \*  
 beste Teiler 37.7 (9.) 38.0 (8.) 53.7 (3.)  
 Trefferlage 0.12 mm links, 0.47 mm tief  
 Streuwert 0.98, horizontal: 1.07, vertikal: 0.88

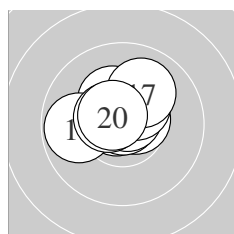

Serie 2:  
 10.6 \*                      10.8 \*                      10.3 \*                      10.8 \*                      10.7 \*  
 10.4 \*                      10.0 ↗                      9.8 ←                      10.5 \*                      10.6 \*  
 beste Teiler 26.3 (14.) 43.8 (12.) 57.9 (15.)  
 Trefferlage 0.22 mm links, 0.67 mm hoch  
 Streuwert 0.96, horizontal: 1.16, vertikal: 0.68

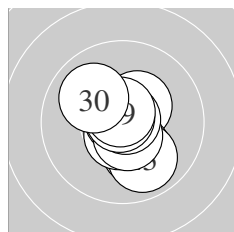

Serie 3:  
 10.4 \*                      10.2 \*                      9.9 ↘                      10.6 \*                      10.8 \*  
 10.6 \*                      10.8 \*                      10.8 \*                      10.7 \*                      10.0 ↖  
 beste Teiler 26.2 (27.) 29.7 (25.) 34.9 (28.)  
 Trefferlage 0.09 mm rechts, 0.18 mm tief  
 Streuwert 1.07, horizontal: 0.88, vertikal: 1.23

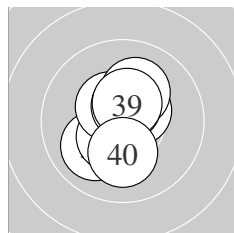

Serie 4:  
 10.0 ↙                      10.5 \*                      10.5 \*                      10.7 \*                      10.5 \*  
 10.5 \*                      10.1 ↗                      10.6 \*                      10.5 \*                      10.1 ↓  
 beste Teiler 75.2 (34.) 99.4 (38.) 107.3 (33.)  
 Trefferlage 0.17 mm links, 0.26 mm hoch  
 Streuwert 1.09, horizontal: 0.81, vertikal: 1.31

Unterschrift des Schützen

Meyton Elektronik

Ergebnis: **417.3** (399)  
 Serien: 103.8 104.4 104.1 105.0  
 Zähler: 39 1 0 0 0 0 0 0 0 0  
 Innenzehner: 31  
 weiteste: 260 (27), 243 (5), 239 (10)  
 beste Teiler 25.3 (36.) 32.0 (18.) 34.5 (22.)  
 Trefferlage 0.17 mm links, 0.06 mm tief  
 Streuwert 1.05, horizontal: 1.01, vertikal: 1.09

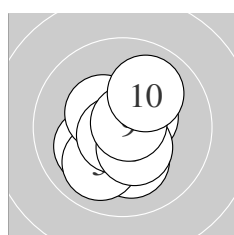
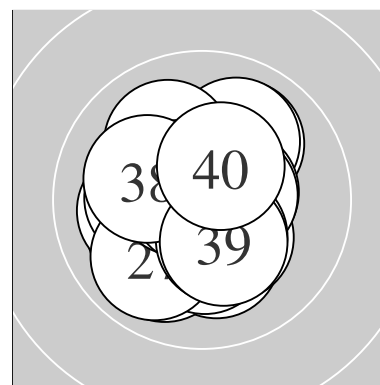

Serie 1:  
 10.5 \*                      10.7 \*                      10.1 ↙                      10.2 \*                      10.0 ↘  
 10.4 \*                      10.7 \*                      10.4 \*                      10.8 \*                      10.0 ↗  
 beste Teiler 43.8 (9.) 65.0 (7.) 72.6 (2.)  
 Trefferlage 0.06 mm links, 0.38 mm tief  
 Streuwert 1.18, horizontal: 1.06, vertikal: 1.28

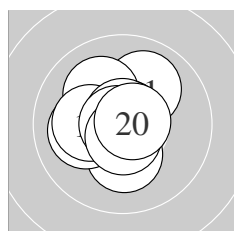

Serie 2:  
 10.0 ↗                      10.1 ↖                      10.2 \*                      10.8 \*                      10.1 ←  
 10.2 \*                      10.8 \*                      10.8 \*                      10.7 \*                      10.7 \*  
 beste Teiler 32.0 (18.) 41.6 (14.) 43.0 (17.)  
 Trefferlage 0.34 mm links, 0.19 mm hoch  
 Streuwert 1.10, horizontal: 1.08, vertikal: 1.11

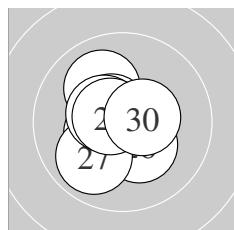

Serie 3:  
 10.5 \*                      10.8 \*                      10.4 \*                      10.0 ↖                      10.6 \*  
 10.3 \*                      9.9 ↙                      10.5 \*                      10.6 \*                      10.5 \*  
 beste Teiler 34.5 (22.) 79.2 (29.) 87.8 (25.)  
 Trefferlage 0.32 mm links, 0.02 mm hoch  
 Streuwert 1.08, horizontal: 1.07, vertikal: 1.10

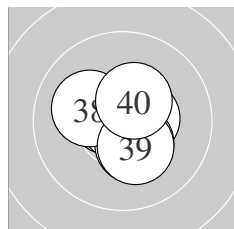

Serie 4:  
 10.5 \*                      10.8 \*                      10.7 \*                      10.6 \*                      10.4 \*  
 10.9 \*                      10.3 \*                      10.1 ↖                      10.3 \*                      10.4 \*  
 beste Teiler 25.3 (36.) 41.0 (32.) 61.5 (33.)  
 Trefferlage 0.03 mm rechts, 0.09 mm tief  
 Streuwert 0.94, horizontal: 0.94, vertikal: 0.95

Unterschrift des Schützen

Meyton Elektronik

Ergebnis: **418.1** (398)  
 Serien: 103.4 105.0 105.6 104.1  
 Zähler: 38 2 0 0 0 0 0 0 0 0  
 Innenzehner: 35  
 weiteste: 275 (7), 271 (20), 247 (9)  
 beste Teiler 7.6 (22.) 28.8 (19.) 35.9 (30.)  
 Trefferlage 0.13 mm rechts, 0.05 mm hoch  
 Streuwert 0.98, horizontal: 1.03, vertikal: 0.93

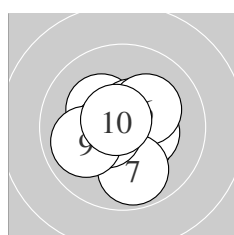
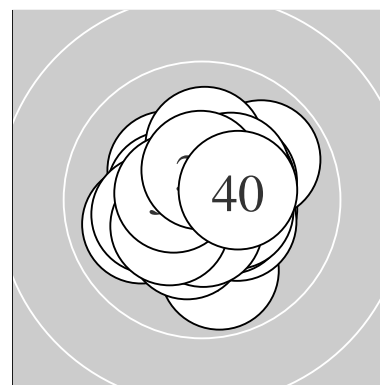

Serie 1:  
 10.4 \*                      10.4 \*                      10.3 \*                      10.5 \*                      10.5 \*  
 10.2 \*                      9.9 ↓                      10.5 \*                      10.0 ←                      10.7 \*  
 beste Teiler 61.6 (10.) 101.6 (5.) 108.1 (8.)  
 Trefferlage 0.10 mm links, 0.22 mm tief  
 Streuwert 1.23, horizontal: 1.28, vertikal: 1.17

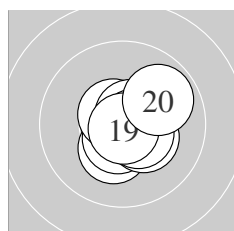

Serie 2:  
 10.3 \*                      10.6 \*                      10.6 \*                      10.7 \*                      10.3 \*  
 10.7 \*                      10.6 \*                      10.5 \*                      10.8 \*                      9.9 ↗  
 beste Teiler 28.8 (19.) 65.4 (16.) 75.1 (14.)  
 Trefferlage 0.49 mm rechts, 0.17 mm tief  
 Streuwert 0.89, horizontal: 0.89, vertikal: 0.88

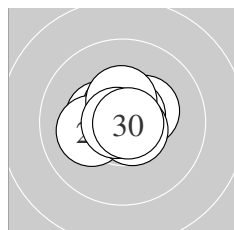

Serie 3:  
 10.3 \*                      10.9 \*                      10.7 \*                      10.4 \*                      10.6 \*  
 10.1 ←                      10.4 \*                      10.6 \*                      10.8 \*                      10.8 \*  
 beste Teiler 7.6 (22.) 35.9 (30.) 37.3 (29.)  
 Trefferlage 0.13 mm links, 0.24 mm hoch  
 Streuwert 0.80, horizontal: 0.96, vertikal: 0.60

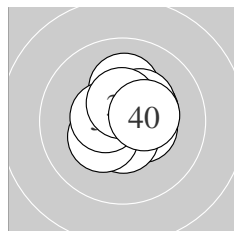

Serie 4:  
 10.1 ↑                      10.4 \*                      10.4 \*                      10.7 \*                      10.5 \*  
 10.3 \*                      10.5 \*                      10.3 \*                      10.5 \*                      10.4 \*  
 beste Teiler 61.1 (34.) 105.1 (35.) 110.8 (37.)  
 Trefferlage 0.28 mm rechts, 0.36 mm hoch  
 Streuwert 0.96, horizontal: 0.95, vertikal: 0.97

Unterschrift des Schützen

Ergebnis: **416.2** (398)  
 Serien: 104.1 104.2 103.8 104.1  
 Zähler: 38 2 0 0 0 0 0 0 0 0  
 Innenzehner: 33  
 weiteste: 363 (6), 276 (35), 249 (16)  
 beste Teiler 14.1 (17.) 26.0 (10.) 29.1 (20.)  
 Trefferlage 0.16 mm rechts, 0.41 mm hoch  
 Streuwert 1.05, horizontal: 1.08, vertikal: 1.02

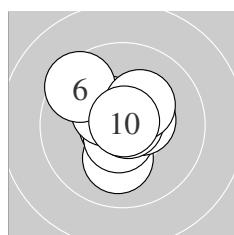
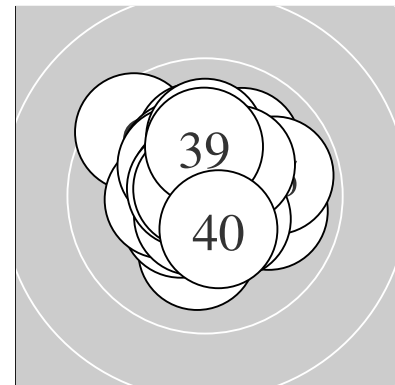

Serie 1:  
 10.7 \*                      10.1 ↓                      10.6 \*                      10.4 \*                      10.4 \*  
 9.5 ↖                      10.5 \*                      10.8 \*                      10.3 \*                      10.8 \*  
 beste Teiler 26.0 (10.) 37.3 (8.) 52.3 (1.)  
 Trefferlage 0.10 mm links, 0.31 mm hoch  
 Streuwert 1.19, horizontal: 1.18, vertikal: 1.21

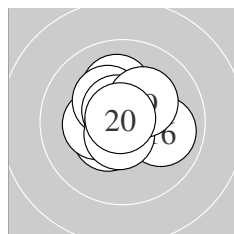

Serie 2:  
 10.4 \*                      10.3 \*                      10.1 ↑                      10.3 \*                      10.6 \*  
 10.0 →                      10.9 \*                      10.6 \*                      10.2 \*                      10.8 \*  
 beste Teiler 14.1 (17.) 29.1 (20.) 79.8 (18.)  
 Trefferlage 0.09 mm links, 0.33 mm hoch  
 Streuwert 1.08, horizontal: 1.16, vertikal: 1.00

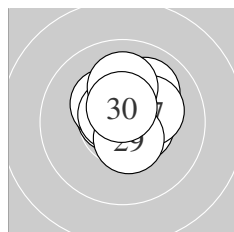

Serie 3:  
 10.7 \*                      10.3 \*                      10.0 ↗                      10.3 \*                      10.6 \*  
 10.5 \*                      10.2 \*                      10.1 ↑                      10.5 \*                      10.6 \*  
 beste Teiler 72.8 (21.) 76.8 (25.) 96.1 (30.)  
 Trefferlage 0.34 mm rechts, 0.71 mm hoch  
 Streuwert 0.96, horizontal: 0.97, vertikal: 0.95

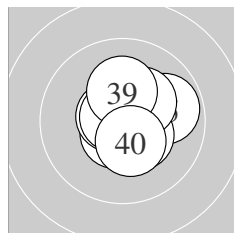

Serie 4:  
 10.6 \*                      10.4 \*                      10.6 \*                      10.7 \*                      9.8 →  
 10.4 \*                      10.3 \*                      10.7 \*                      10.2 \*                      10.4 \*  
 beste Teiler 55.9 (38.) 71.2 (34.) 78.5 (33.)  
 Trefferlage 0.50 mm rechts, 0.29 mm hoch  
 Streuwert 1.01, horizontal: 1.01, vertikal: 1.00

Unterschrift des Schützen

Meyton Elektronik

Ergebnis: **421.1** (398)  
 Serien: 105.2 104.1 105.9 105.9  
 Zähler: 38 2 0 0 0 0 0 0 0 0  
 Innenzehner: 38  
 weiteste: 313 (19), 259 (11), 178 (32)  
 beste Teiler 25.0 (30.) 29.6 (14.) 31.8 (26.)  
 Trefferlage 0.09 mm rechts, 0.05 mm tief  
 Streuwert 0.86, horizontal: 0.88, vertikal: 0.85

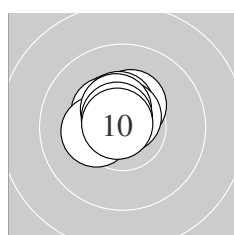
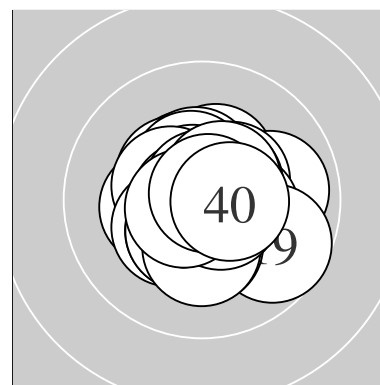

Serie 1:  
 10.4 \*                      10.4 \*                      10.6 \*                      10.4 \*                      10.4 \*  
 10.7 \*                      10.3 \*                      10.5 \*                      10.7 \*                      10.8 \*  
 beste Teiler 40.4 (10.) 68.9 (6.) 69.9 (9.)  
 Trefferlage 0.41 mm links, 0.78 mm hoch  
 Streuwert 0.56, horizontal: 0.60, vertikal: 0.51

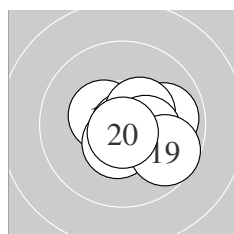

Serie 2:  
 9.9 →                      10.8 \*                      10.4 \*                      10.8 \*                      10.6 \*  
 10.4 \*                      10.5 \*                      10.3 \*                      9.7 ↘                      10.7 \*  
 beste Teiler 29.6 (14.) 46.2 (12.) 54.0 (20.)  
 Trefferlage 0.61 mm rechts, 0.34 mm tief  
 Streuwert 1.06, horizontal: 1.29, vertikal: 0.75

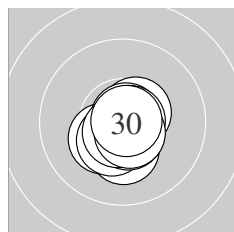

Serie 3:  
 10.3 \*                      10.3 \*                      10.4 \*                      10.6 \*                      10.5 \*  
 10.8 \*                      10.8 \*                      10.7 \*                      10.6 \*                      10.9 \*  
 beste Teiler 25.0 (30.) 31.8 (26.) 45.5 (27.)  
 Trefferlage 0.04 mm rechts, 0.50 mm tief  
 Streuwert 0.66, horizontal: 0.60, vertikal: 0.72

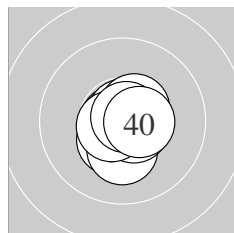

Serie 4:  
 10.4 \*                      10.2 \*                      10.8 \*                      10.6 \*                      10.8 \*  
 10.6 \*                      10.7 \*                      10.5 \*                      10.8 \*                      10.5 \*  
 beste Teiler 33.9 (39.) 40.0 (35.) 45.0 (33.)  
 Trefferlage 0.15 mm rechts, 0.17 mm tief  
 Streuwert 0.71, horizontal: 0.62, vertikal: 0.80

Unterschrift des Schützen

Meyton Elektronik

Ergebnis: **416.5** (396)  
 Serien: 104.6 105.3 104.0 102.6  
 Zähler: 36 4 0 0 0 0 0 0 0 0  
 Innenzehner: 33  
 weiteste: 349 (27), 332 (35), 270 (37)  
 beste Teiler 37.6 (3.) 40.0 (24.) 41.2 (30.)  
 Trefferlage 0.21 mm rechts, 0.06 mm tief  
 Streuwert 1.10, horizontal: 1.25, vertikal: 0.93

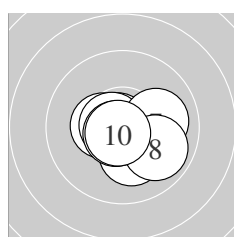
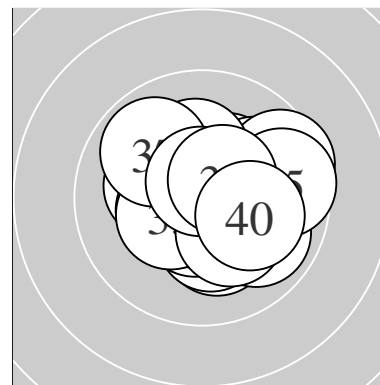

Serie 1:  
 10.7 \*                      10.4 \*                      10.8 \*                      10.7 \*                      10.5 \*  
 10.2 \*                      10.0 →                      9.9 ↘                      10.7 \*                      10.7 \*  
 beste Teiler 37.6 (3.) 52.6 (10.) 63.0 (1.)  
 Trefferlage 0.21 mm rechts, 0.39 mm tief  
 Streuwert 1.02, horizontal: 1.25, vertikal: 0.72

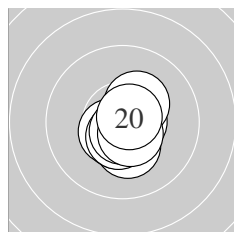

Serie 2:  
 10.6 \*                      10.3 \*                      10.5 \*                      10.5 \*                      10.5 \*  
 10.7 \*                      10.6 \*                      10.3 \*                      10.6 \*                      10.7 \*  
 beste Teiler 58.4 (20.) 64.1 (16.) 80.0 (17.)  
 Trefferlage 0.09 mm rechts, 0.46 mm tief  
 Streuwert 0.72, horizontal: 0.62, vertikal: 0.81

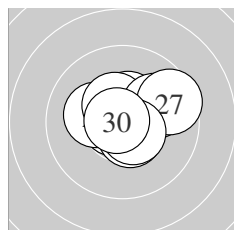

Serie 3:  
 10.7 \*                      10.2 \*                      10.4 \*                      10.8 \*                      10.4 \*  
 10.0 →                      9.6 →                      10.5 \*                      10.6 \*                      10.8 \*  
 beste Teiler 40.0 (24.) 41.2 (30.) 57.7 (21.)  
 Trefferlage 0.36 mm rechts, 0.42 mm hoch  
 Streuwert 1.16, horizontal: 1.44, vertikal: 0.80

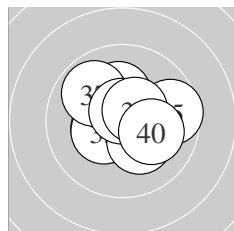

Serie 4:  
 10.6 \*                      10.4 \*                      10.4 \*                      10.2 \*                      9.6 →  
 10.2 \*                      9.9 ↘                      10.7 \*                      10.5 \*                      10.1 →  
 beste Teiler 68.3 (38.) 87.0 (31.) 112.6 (39.)  
 Trefferlage 0.17 mm rechts, 0.18 mm hoch  
 Streuwert 1.40, horizontal: 1.63, vertikal: 1.13

Unterschrift des Schützen

Meyton Elektronik

Ergebnis: **407.0** (386)  
 Serien: 100.6 101.2 102.9 102.3  
 Zähler: 27 12 1 0 0 0 0 0 0 0  
 Innenzehner: 23  
 weiteste: 597 (20), 411 (5), 386 (39)  
 beste Teiler 11.7 (27.) 31.9 (34.) 50.0 (12.)  
 Trefferlage 0.15 mm rechts, 0.00 mm  
 Streuwert 1.65, horizontal: 1.97, vertikal: 1.27

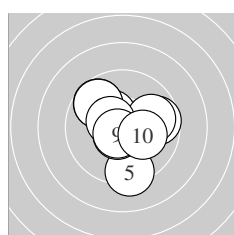
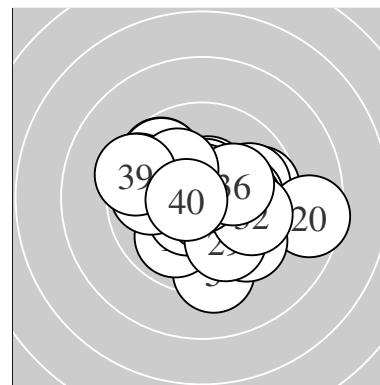

Serie 1:  
 9.7 → 10.3 \* 9.7 ↘ 9.9 → 9.3 ↓  
 9.7 ↘ 10.6 \* 10.5 \* 10.7 \* 10.2 \*  
 beste Teiler 74.6 (9.) 84.3 (7.) 123.4 (8.)  
 Trefferlage 0.06 mm rechts, 0.13 mm hoch  
 Streuwert 1.86, horizontal: 1.92, vertikal: 1.81

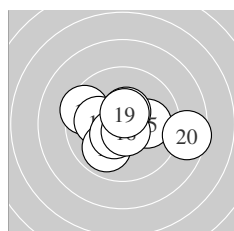

Serie 2:  
 9.5 ↖ 10.8 \* 10.1 ← 9.9 ↗ 10.1 →  
 10.5 \* 10.5 \* 10.7 \* 10.5 \* 8.6 →  
 beste Teiler 50.0 (12.) 72.6 (18.) 101.6 (19.)  
 Trefferlage 0.07 mm rechts, 0.04 mm tief  
 Streuwert 1.98, horizontal: 2.57, vertikal: 1.11

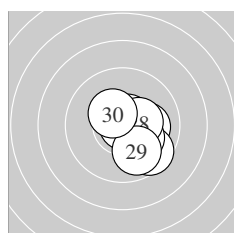

Serie 3:  
 10.1 → 10.7 \* 9.6 ↘ 10.3 \* 10.4 \*  
 10.2 \* 10.9 \* 10.4 \* 9.9 ↘ 10.4 \*  
 beste Teiler 11.7 (27.) 74.8 (22.) 140.4 (30.)  
 Trefferlage 1.12 mm rechts, 0.57 mm tief  
 Streuwert 1.08, horizontal: 0.99, vertikal: 1.16

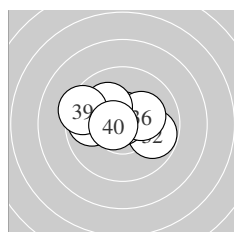

Serie 4:  
 10.7 \* 9.8 → 10.2 \* 10.8 \* 10.7 \*  
 10.2 \* 9.8 ← 10.1 ↘ 9.4 ↖ 10.6 \*  
 beste Teiler 31.9 (34.) 52.3 (31.) 72.0 (35.)  
 Trefferlage 0.63 mm links, 0.46 mm hoch  
 Streuwert 1.45, horizontal: 1.93, vertikal: 0.69

Unterschrift des Schützen

Meyton Elektronik

Ergebnis: **400.2** (380)  
 Serien: 100.0 98.5 101.3 100.4  
 Zähler: 22 16 2 0 0 0 0 0 0  
 Innenzehner: 17  
 weiteste: 626 (7), 507 (17), 451 (39)  
 beste Teiler 69.2 (35.) 86.8 (5.) 88.1 (9.)  
 Trefferlage 0.02 mm rechts, 0.08 mm hoch  
 Streuwert 1.93, horizontal: 2.24, vertikal: 1.55

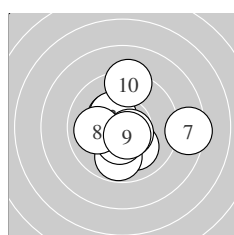
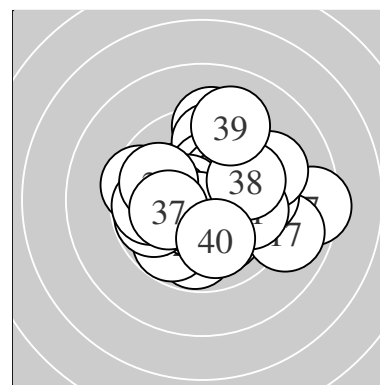

Serie 1:  
 10.4 \*                      10.1 ↘                      10.4 \*                      9.8 ↓                      10.6 \*  
 10.4 \*                      8.4 →                      10.0 ←                      10.6 \*                      9.3 ↑  
 beste Teiler 86.8 (5.) 88.1 (9.) 131.0 (6.)  
 Trefferlage 0.40 mm rechts, 0.16 mm tief  
 Streuwert 2.13, horizontal: 2.31, vertikal: 1.93

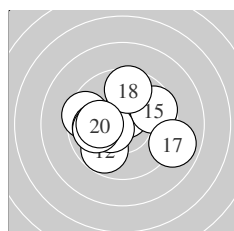

Serie 2:  
 9.5 ←                      9.8 ↙                      10.6 \*                      9.9 ←                      9.7 →  
 10.5 \*                      8.9 →                      9.6 ↑                      9.9 ←                      10.1 ←  
 beste Teiler 94.9 (13.) 122.5 (16.) 217.0 (20.)  
 Trefferlage 0.51 mm links, 0.09 mm hoch  
 Streuwert 2.19, horizontal: 2.64, vertikal: 1.62

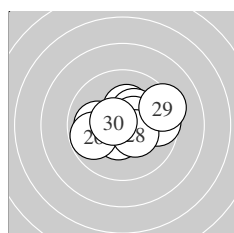

Serie 3:  
 10.3 \*                      10.5 \*                      10.0 ←                      10.3 \*                      9.6 →  
 9.8 ←                      10.5 \*                      10.4 \*                      9.3 →                      10.6 \*  
 beste Teiler 93.4 (30.) 112.3 (22.) 114.5 (27.)  
 Trefferlage 0.43 mm rechts, 0.27 mm hoch  
 Streuwert 1.67, horizontal: 2.14, vertikal: 1.01

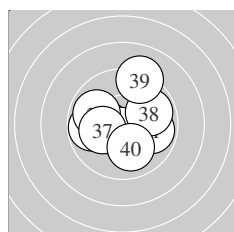

Serie 4:  
 9.9 →                      10.3 \*                      10.6 \*                      9.8 ←                      10.7 \*  
 9.9 ←                      10.2 \*                      9.9 →                      9.1 ↑                      10.0 ↓  
 beste Teiler 69.2 (35.) 96.2 (33.) 167.0 (32.)  
 Trefferlage 0.21 mm links, 0.12 mm hoch  
 Streuwert 1.88, horizontal: 2.04, vertikal: 1.71

Unterschrift des Schützen

Meyton Elektronik



Ergebnis: **415.4** (397)  
 Serien: 103.0 104.7 103.7 104.0  
 Zähler: 37 3 0 0 0 0 0 0 0 0  
 Innenzehner: 32  
 weiteste: 287 (19), 277 (10), 253 (31)  
 beste Teiler 26.0 (13.) 45.3 (37.) 52.3 (33.)  
 Trefferlage 0.11 mm rechts, 0.34 mm hoch  
 Streuwert 1.09, horizontal: 1.17, vertikal: 1.01

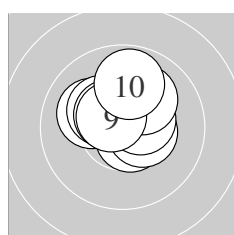
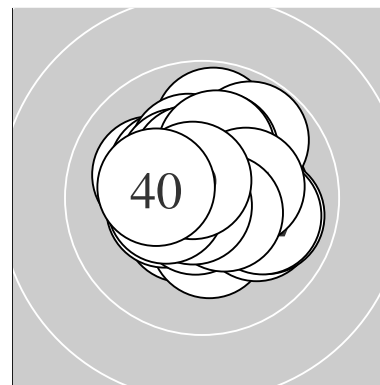

Serie 1:  
 10.1 ↖                      10.6 \*                      10.3 \*                      10.4 \*                      10.5 \*  
 10.5 \*                      10.1 ↗                      10.1 ↗                      10.6 \*                      9.8 ↑  
 beste Teiler 79.0 (2.) 98.3 (9.) 118.2 (6.)  
 Trefferlage 0.05 mm rechts, 0.94 mm hoch  
 Streuwert 1.10, horizontal: 1.17, vertikal: 1.02

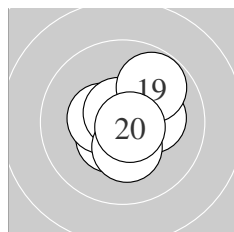

Serie 2:  
 10.6 \*                      10.7 \*                      10.8 \*                      10.5 \*                      10.4 \*  
 10.7 \*                      10.2 \*                      10.3 \*                      9.8 ↗                      10.7 \*  
 beste Teiler 26.0 (13.) 56.8 (20.) 58.5 (12.)  
 Trefferlage 0.16 mm rechts, 0.08 mm tief  
 Streuwert 1.03, horizontal: 1.02, vertikal: 1.04

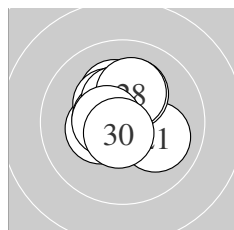

Serie 3:  
 10.0 ↘                      10.2 \*                      10.4 \*                      10.4 \*                      10.2 \*  
 10.6 \*                      10.4 \*                      10.2 \*                      10.6 \*                      10.7 \*  
 beste Teiler 73.3 (30.) 100.3 (29.) 100.6 (26.)  
 Trefferlage 0.22 mm links, 0.61 mm hoch  
 Streuwert 1.07, horizontal: 1.05, vertikal: 1.09

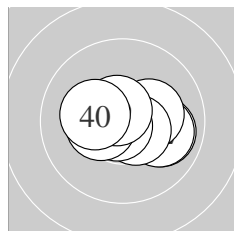

Serie 4:  
 9.9 ↘                      10.0 ↘                      10.7 \*                      10.6 \*                      10.3 \*  
 10.5 \*                      10.8 \*                      10.4 \*                      10.6 \*                      10.2 \*  
 beste Teiler 45.3 (37.) 52.3 (33.) 76.0 (39.)  
 Trefferlage 0.47 mm rechts, 0.08 mm tief  
 Streuwert 1.08, horizontal: 1.44, vertikal: 0.49

Unterschrift des Schützen

Meyton Elektronik

Ergebnis: **413.0** (397)  
 Serien: 103.4 102.6 103.2 103.8  
 Zähler: 37 3 0 0 0 0 0 0 0 0  
 Innenzehner: 31  
 weiteste: 339 (7), 312 (39), 308 (15)  
 beste Teiler 36.1 (5.) 43.4 (31.) 53.2 (38.)  
 Trefferlage 0.10 mm links, 0.04 mm hoch  
 Streuwert 1.24, horizontal: 1.33, vertikal: 1.13

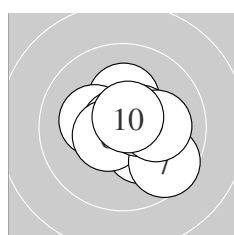
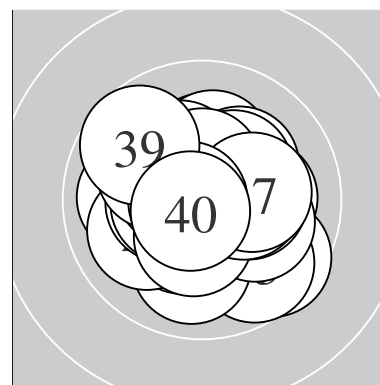

Serie 1:  
 10.5 \*                      10.2 \*                      10.2 \*                      10.3 \*                      10.8 \*  
 10.5 \*                      9.6 ↘                      10.5 \*                      10.1 →                      10.7 \*  
 beste Teiler 36.1 (5.) 72.0 (10.) 104.8 (6.)  
 Trefferlage 0.37 mm rechts, 0.02 mm hoch  
 Streuwert 1.25, horizontal: 1.37, vertikal: 1.12

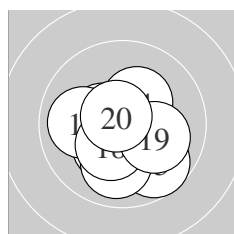

Serie 2:  
 10.7 \*                      10.3 \*                      10.4 \*                      10.3 \*                      9.7 ↘  
 10.0 ←                      10.0 ↓                      10.4 \*                      10.1 →                      10.7 \*  
 beste Teiler 64.0 (20.) 66.8 (11.) 128.3 (13.)  
 Trefferlage 0.18 mm links, 0.63 mm tief  
 Streuwert 1.33, horizontal: 1.42, vertikal: 1.24

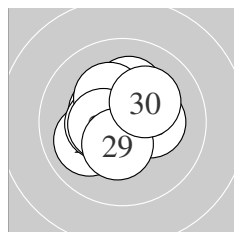

Serie 3:  
 10.4 \*                      10.5 \*                      10.0 ↙                      10.2 \*                      10.4 \*  
 10.3 \*                      10.3 \*                      10.5 \*                      10.4 \*                      10.2 \*  
 beste Teiler 120.8 (28.) 125.8 (22.) 132.9 (21.)  
 Trefferlage 0.43 mm links, 0.16 mm hoch  
 Streuwert 1.19, horizontal: 1.24, vertikal: 1.14

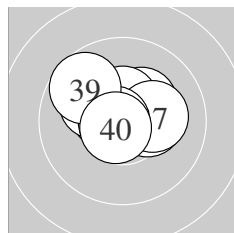

Serie 4:  
 10.8 \*                      10.5 \*                      10.3 \*                      10.1 ↘                      10.5 \*  
 10.3 \*                      10.2 \*                      10.7 \*                      9.7 ↘                      10.7 \*  
 beste Teiler 43.4 (31.) 53.2 (38.) 60.8 (40.)  
 Trefferlage 0.16 mm links, 0.61 mm hoch  
 Streuwert 1.11, horizontal: 1.38, vertikal: 0.75

Unterschrift des Schützen

Meyton Elektronik

Ergebnis: **406.1** (385)  
 Serien: 100.7 102.4 101.3 101.7  
 Zähler: 25 15 0 0 0 0 0 0 0 0  
 Innenzehner: 23  
 weiteste: 475 (40), 357 (25), 340 (1)  
 beste Teiler 13.8 (38.) 40.5 (22.) 47.0 (12.)  
 Trefferlage 0.21 mm links, 0.62 mm hoch  
 Streuwert 1.51, horizontal: 1.70, vertikal: 1.29

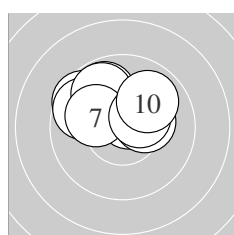
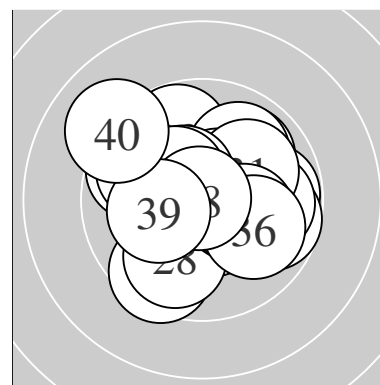

Serie 1:  
 9.6 ↘                      10.5 \*                      9.8 ↗                      9.7 ↘                      10.6 \*  
 9.8 ↘                      10.1 ↘                      10.3 \*                      10.4 \*                      9.9 ↗  
 beste Teiler 80.1 (5.) 108.0 (2.) 146.2 (9.)  
 Trefferlage 0.52 mm links, 1.36 mm hoch  
 Streuwert 1.36, horizontal: 1.78, vertikal: 0.74

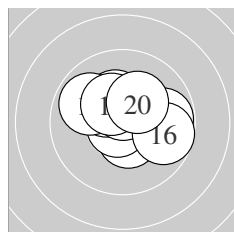

Serie 2:  
 10.5 \*                      10.8 \*                      9.8 →                      10.3 \*                      10.6 \*  
 9.7 →                      10.3 \*                      9.9 ↘                      10.3 \*                      10.2 \*  
 beste Teiler 47.0 (12.) 93.0 (15.) 115.5 (11.)  
 Trefferlage 0.21 mm rechts, 0.57 mm hoch  
 Streuwert 1.38, horizontal: 1.69, vertikal: 0.98

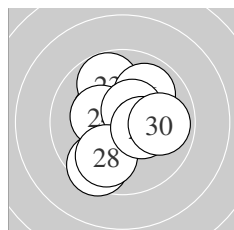

Serie 3:  
 10.3 \*                      10.8 \*                      9.8 ↘                      10.3 \*                      9.5 ↙  
 9.9 ↗                      10.5 \*                      9.9 ↙                      10.4 \*                      9.9 →  
 beste Teiler 40.5 (22.) 109.4 (27.) 143.6 (29.)  
 Trefferlage 0.07 mm links, 0.02 mm hoch  
 Streuwert 1.68, horizontal: 1.56, vertikal: 1.79

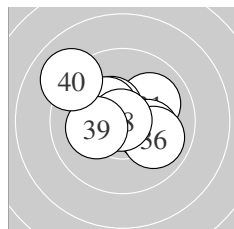

Serie 4:  
 10.0 ↗                      10.2 \*                      10.4 \*                      10.2 \*                      10.4 \*  
 9.9 ↘                      10.4 \*                      10.9 \*                      10.2 \*                      9.1 ↘  
 beste Teiler 13.8 (38.) 127.7 (35.) 132.4 (33.)  
 Trefferlage 0.44 mm links, 0.53 mm hoch  
 Streuwert 1.60, horizontal: 1.92, vertikal: 1.19

Unterschrift des Schützen

Meyton Elektronik

Ergebnis: **417.4** (396)  
 Serien: 103.6 103.9 105.0 104.9  
 Zähler: 36 4 0 0 0 0 0 0 0 0  
 Innenzehner: 34  
 weiteste: 325 (7), 273 (3), 271 (21)  
 beste Teiler 21.1 (25.) 27.2 (27.) 34.1 (23.)  
 Trefferlage 0.09 mm links, 0.11 mm tief  
 Streuwert 1.06, horizontal: 1.09, vertikal: 1.03

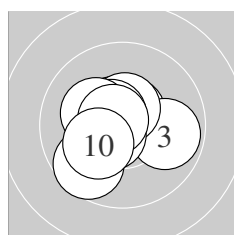
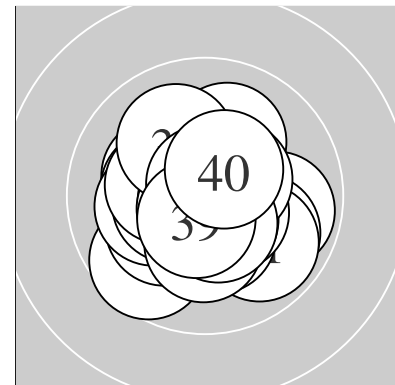

Serie 1:  
 10.6 \*                      10.6 \*                      9.9 →                      10.5 \*                      10.6 \*  
 10.6 \*                      9.7 ↙                      10.2 \*                      10.7 \*                      10.2 \*  
 beste Teiler 69.3 (9.) 90.5 (2.) 96.2 (5.)  
 Trefferlage 0.47 mm links, 0.03 mm tief  
 Streuwert 1.25, horizontal: 1.37, vertikal: 1.13

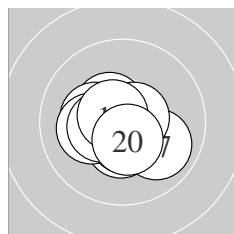

Serie 2:  
 10.5 \*                      10.4 \*                      10.3 \*                      10.2 \*                      10.5 \*  
 10.4 \*                      9.9 ↘                      10.6 \*                      10.6 \*                      10.5 \*  
 beste Teiler 76.2 (19.) 76.3 (18.) 102.9 (15.)  
 Trefferlage 0.32 mm links, 0.36 mm tief  
 Streuwert 1.04, horizontal: 1.23, vertikal: 0.82

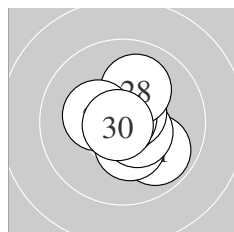

Serie 3:  
 9.9 ↘                      10.3 \*                      10.8 \*                      10.5 \*                      10.9 \*  
 10.6 \*                      10.8 \*                      10.1 ↑                      10.3 \*                      10.8 \*  
 beste Teiler 21.1 (25.) 27.2 (27.) 34.1 (23.)  
 Trefferlage 0.33 mm rechts, 0.05 mm tief  
 Streuwert 1.01, horizontal: 0.94, vertikal: 1.08

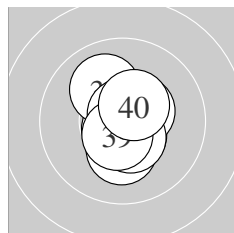

Serie 4:  
 10.2 \*                      10.5 \*                      10.7 \*                      10.5 \*                      10.5 \*  
 10.6 \*                      10.0 ↘                      10.8 \*                      10.6 \*                      10.5 \*  
 beste Teiler 45.0 (38.) 60.2 (33.) 79.2 (36.)  
 Trefferlage 0.08 mm rechts, 0.02 mm tief  
 Streuwert 0.94, horizontal: 0.63, vertikal: 1.17

Unterschrift des Schützen

Meyton Elektronik

Ergebnis: **414.2** (396)  
 Serien: 103.7 104.4 104.2 101.9  
 Zähler: 36 4 0 0 0 0 0 0 0 0  
 Innenzehner: 30  
 weiteste: 273 (32), 272 (35), 262 (37)  
 beste Teiler 14.5 (26.) 44.9 (31.) 47.5 (19.)  
 Trefferlage 0.07 mm rechts, 0.05 mm tief  
 Streuwert 1.18, horizontal: 1.20, vertikal: 1.16

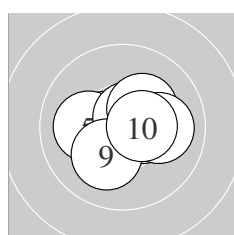
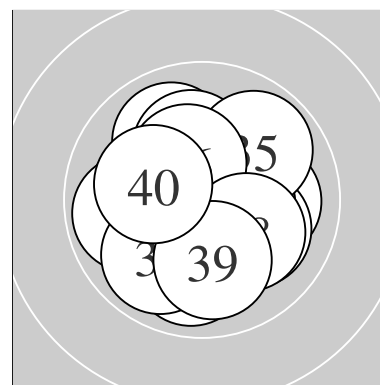

Serie 1:  
 10.5 \*                      10.5 \*                      10.4 \*                      10.5 \*                      10.1 ←  
 10.7 \*                      10.3 \*                      10.0 →                      10.2 \*                      10.5 \*  
 beste Teiler 73.4 (6.) 101.1 (1.) 111.6 (2.)  
 Trefferlage 0.22 mm rechts, 0.06 mm tief  
 Streuwert 1.14, horizontal: 1.43, vertikal: 0.76

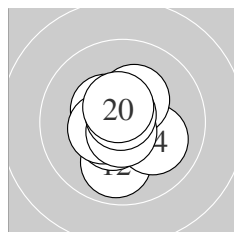

Serie 2:  
 10.7 \*                      9.9 ↓                      10.4 \*                      10.1 ↘                      10.3 \*  
 10.5 \*                      10.4 \*                      10.7 \*                      10.8 \*                      10.6 \*  
 beste Teiler 47.5 (19.) 61.5 (18.) 73.5 (11.)  
 Trefferlage 0.17 mm links, 0.23 mm tief  
 Streuwert 1.05, horizontal: 0.91, vertikal: 1.17

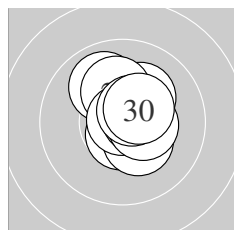

Serie 3:  
 10.2 \*                      10.6 \*                      10.3 \*                      10.0 ↖                      10.2 \*  
 10.9 \*                      10.6 \*                      10.4 \*                      10.6 \*                      10.4 \*  
 beste Teiler 14.5 (26.) 78.7 (22.) 94.4 (29.)  
 Trefferlage 0.42 mm rechts, 0.55 mm hoch  
 Streuwert 0.98, horizontal: 0.81, vertikal: 1.12

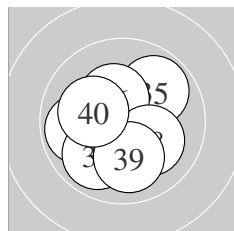

Serie 4:  
 10.8 \*                      9.9 ←                      10.4 \*                      10.3 \*                      9.9 ↗  
 10.4 \*                      9.9 ↙                      10.1 ↘                      10.0 ↓                      10.2 \*  
 beste Teiler 44.9 (31.) 138.2 (33.) 149.8 (36.)  
 Trefferlage 0.17 mm links, 0.47 mm tief  
 Streuwert 1.48, horizontal: 1.55, vertikal: 1.41

Unterschrift des Schützen

Meyton Elektronik

Ergebnis: **393.4** (375)  
 Serien: 96.5 101.4 98.6 96.9  
 Zähler: 18 20 1 1 0 0 0 0 0 0  
 Innenzehner: 14  
 weiteste: 860 (9), 675 (29), 499 (1)  
 beste Teiler 4.2 (26.) 36.2 (17.) 96.7 (21.)  
 Trefferlage 0.31 mm links, 0.35 mm hoch  
 Streuwert 2.30, horizontal: 2.82, vertikal: 1.62

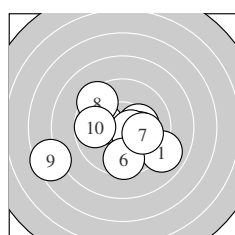
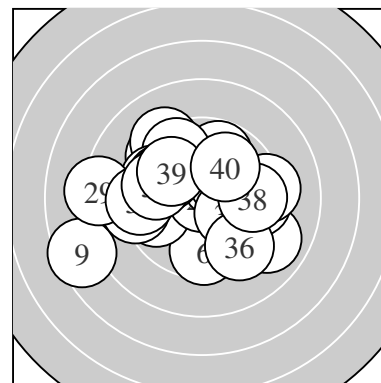

Serie 1:  
 9.0 ↘ 10.3 \* 10.2 \* 10.1 ← 10.6 \*  
 9.6 ↓ 10.0 → 9.4 ↖ 7.5 ↙ 9.8 ←  
 beste Teiler 97.3 (5.) 173.2 (2.) 192.6 (3.)  
 Trefferlage 0.47 mm links, 0.78 mm tief  
 Streuwert 2.83, horizontal: 3.50, vertikal: 1.94

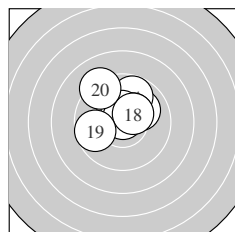

Serie 2:  
 10.2 \* 10.0 ↗ 10.4 \* 9.8 ↗ 10.4 \*  
 10.5 \* 10.8 \* 10.4 \* 9.7 ← 9.2 ↖  
 beste Teiler 36.2 (17.) 121.3 (16.) 142.0 (13.)  
 Trefferlage 0.00 mm , 1.31 mm hoch  
 Streuwert 1.44, horizontal: 1.60, vertikal: 1.25

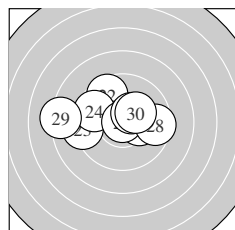

Serie 3:  
 10.6 \* 9.6 ↖ 9.2 ← 9.6 ↖ 10.2 \*  
 10.9 \* 10.4 \* 9.5 → 8.3 ← 10.3 \*  
 beste Teiler 4.2 (26.) 96.7 (21.) 136.4 (27.)  
 Trefferlage 0.71 mm links, 0.54 mm hoch  
 Streuwert 2.37, horizontal: 3.18, vertikal: 1.06

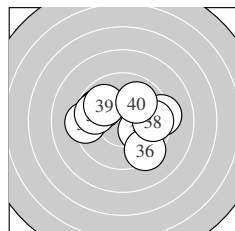

Serie 4:  
 9.8 ↖ 9.3 ← 9.9 ↖ 9.3 → 10.1 ↘  
 9.4 ↘ 9.7 ← 9.6 → 9.9 ↖ 9.9 ↗  
 beste Teiler 201.5 (35.) 252.2 (40.) 264.4 (39.)  
 Trefferlage 0.08 mm links, 0.36 mm hoch  
 Streuwert 2.39, horizontal: 3.00, vertikal: 1.54

Unterschrift des Schützen

Meyton Elektronik

Ergebnis: **419.9** (398)  
 Serien: 106.1 104.4 103.3 106.1  
 Zähler: 38 2 0 0 0 0 0 0 0 0  
 Innenzehner: 36  
 weiteste: 324 (23), 264 (30), 227 (24)  
 beste Teiler 17.1 (10.) 42.5 (37.) 43.4 (38.)  
 Trefferlage 0.01 mm links, 0.21 mm hoch  
 Streuwert 0.93, horizontal: 0.99, vertikal: 0.86

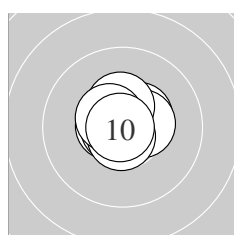
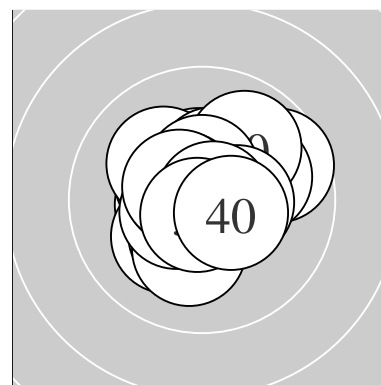

Serie 1:  
 10.6 \*                      10.6 \*                      10.7 \*                      10.5 \*                      10.5 \*  
 10.7 \*                      10.4 \*                      10.7 \*                      10.5 \*                      10.9 \*  
 beste Teiler 17.1 (10.) 51.4 (6.) 56.6 (3.)  
 Trefferlage 0.02 mm links, 0.30 mm hoch  
 Streuwert 0.65, horizontal: 0.75, vertikal: 0.53

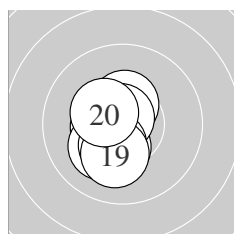

Serie 2:  
 10.7 \*                      10.5 \*                      10.6 \*                      10.3 \*                      10.4 \*  
 10.2 \*                      10.8 \*                      10.3 \*                      10.2 \*                      10.4 \*  
 beste Teiler 44.9 (17.) 75.6 (11.) 94.8 (13.)  
 Trefferlage 0.70 mm links, 0.39 mm tief  
 Streuwert 0.85, horizontal: 0.48, vertikal: 1.10

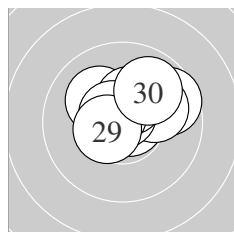

Serie 3:  
 10.6 \*                      10.8 \*                      9.7 ↗                      10.0 ↗                      10.7 \*  
 10.1 ↘                      10.4 \*                      10.6 \*                      10.5 \*                      9.9 ↗  
 beste Teiler 46.0 (22.) 54.0 (25.) 80.2 (28.)  
 Trefferlage 0.51 mm rechts, 0.83 mm hoch  
 Streuwert 1.13, horizontal: 1.41, vertikal: 0.75

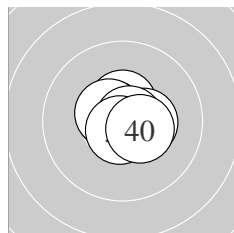

Serie 4:  
 10.5 \*                      10.6 \*                      10.6 \*                      10.7 \*                      10.5 \*  
 10.4 \*                      10.8 \*                      10.8 \*                      10.7 \*                      10.5 \*  
 beste Teiler 42.5 (37.) 43.4 (38.) 61.9 (39.)  
 Trefferlage 0.14 mm rechts, 0.10 mm hoch  
 Streuwert 0.67, horizontal: 0.80, vertikal: 0.52

Unterschrift des Schützen

Meyton Elektronik

Ergebnis: **417.2** (398)  
 Serien: 103.3 104.8 103.6 105.5  
 Zähler: 38 2 0 0 0 0 0 0 0 0  
 Innenzehner: 34  
 weiteste: 297 (1), 291 (22), 240 (9)  
 beste Teiler 52.3 (36.) 61.2 (35.) 62.3 (16.)  
 Trefferlage 0.14 mm links, 0.24 mm hoch  
 Streuwert 1.04, horizontal: 1.04, vertikal: 1.03

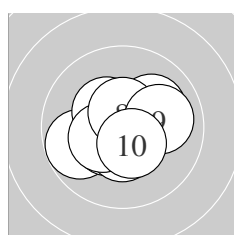
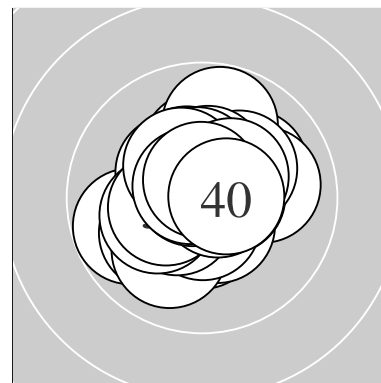

Serie 1:  
 9.8 ←                      10.4 \*                      10.4 \*                      10.7 \*                      10.1 ↗  
 10.4 \*                      10.4 \*                      10.6 \*                      10.0 →                      10.5 \*  
 beste Teiler 75.9 (4.) 97.0 (8.) 119.9 (10.)  
 Trefferlage 0.09 mm links, 0.06 mm tief  
 Streuwert 1.28, horizontal: 1.51, vertikal: 1.02

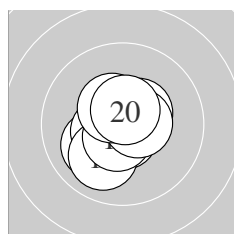

Serie 2:  
 10.1 ↙                      10.7 \*                      10.5 \*                      10.5 \*                      10.0 ↘  
 10.7 \*                      10.6 \*                      10.6 \*                      10.5 \*                      10.6 \*  
 beste Teiler 62.3 (16.) 69.1 (12.) 87.3 (17.)  
 Trefferlage 0.32 mm links, 0.20 mm tief  
 Streuwert 0.98, horizontal: 0.91, vertikal: 1.03

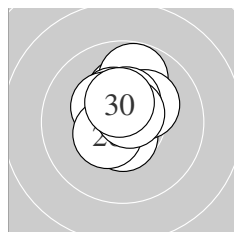

Serie 3:  
 10.2 \*                      9.8 ↑                      10.6 \*                      10.4 \*                      10.4 \*  
 10.5 \*                      10.2 \*                      10.4 \*                      10.7 \*                      10.4 \*  
 beste Teiler 73.1 (29.) 94.0 (23.) 122.6 (26.)  
 Trefferlage 0.00 mm , 0.95 mm hoch  
 Streuwert 0.97, horizontal: 0.77, vertikal: 1.13

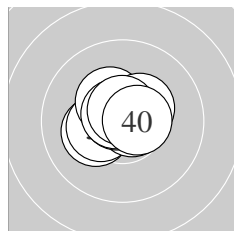

Serie 4:  
 10.2 \*                      10.7 \*                      10.4 \*                      10.4 \*                      10.7 \*  
 10.7 \*                      10.4 \*                      10.7 \*                      10.7 \*                      10.6 \*  
 beste Teiler 52.3 (36.) 61.2 (35.) 64.3 (38.)  
 Trefferlage 0.15 mm links, 0.30 mm hoch  
 Streuwert 0.80, horizontal: 0.97, vertikal: 0.58

Unterschrift des Schützen

Meyton Elektronik



Ergebnis: **416.8** (398)  
 Serien: 103.5 103.5 104.6 105.2  
 Zähler: 38 2 0 0 0 0 0 0 0 0  
 Innenzehner: 35  
 weiteste: 313 (19), 269 (2), 246 (3)  
 beste Teiler 9.4 (27.) 41.1 (18.) 46.0 (16.)  
 Trefferlage 0.14 mm links, 0.03 mm hoch  
 Streuwert 1.07, horizontal: 1.24, vertikal: 0.86

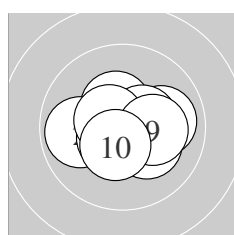
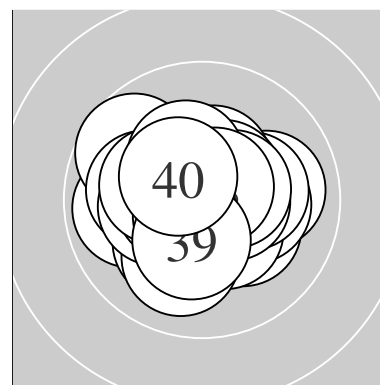

Serie 1:  
 10.4 \*                    9.9 ←                    10.0 →                    10.6 \*                    10.7 \*  
 10.2 \*                    10.4 \*                    10.6 \*                    10.2 \*                    10.5 \*  
 beste Teiler 69.0 (5.) 94.7 (4.) 94.8 (8.)  
 Trefferlage 0.27 mm rechts, 0.09 mm tief  
 Streuwert 1.22, horizontal: 1.56, vertikal: 0.75

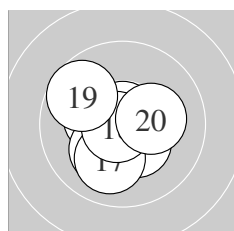

Serie 2:  
 10.6 \*                    10.3 \*                    10.5 \*                    10.2 \*                    10.4 \*  
 10.8 \*                    10.0 ↓                    10.8 \*                    9.7 ↘                    10.2 \*  
 beste Teiler 41.1 (18.) 46.0 (16.) 76.2 (11.)  
 Trefferlage 0.29 mm links, 0.33 mm tief  
 Streuwert 1.22, horizontal: 1.28, vertikal: 1.17

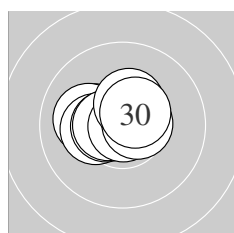

Serie 3:  
 10.2 \*                    10.1 ←                    10.5 \*                    10.3 \*                    10.5 \*  
 10.6 \*                    10.9 \*                    10.6 \*                    10.4 \*                    10.5 \*  
 beste Teiler 9.4 (27.) 92.0 (26.) 93.4 (28.)  
 Trefferlage 0.47 mm links, 0.34 mm hoch  
 Streuwert 0.91, horizontal: 1.19, vertikal: 0.51

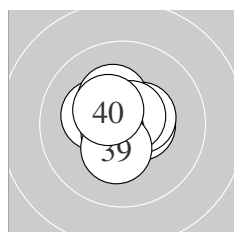

Serie 4:  
 10.7 \*                    10.8 \*                    10.5 \*                    10.5 \*                    10.3 \*  
 10.3 \*                    10.7 \*                    10.7 \*                    10.3 \*                    10.4 \*  
 beste Teiler 49.3 (32.) 61.6 (31.) 69.3 (38.)  
 Trefferlage 0.08 mm links, 0.21 mm hoch  
 Streuwert 0.87, horizontal: 0.89, vertikal: 0.85

Unterschrift des Schützen

Meyton Elektronik

Ergebnis: **417.6** (399)  
 Serien: 104.0 104.4 103.5 105.7  
 Zähler: 39 1 0 0 0 0 0 0 0 0  
 Innenzehner: 36  
 weiteste: 257 (29), 240 (26), 221 (15)  
 beste Teiler 15.8 (40.) 35.6 (30.) 38.3 (28.)  
 Trefferlage 0.25 mm rechts, 0.17 mm hoch  
 Streuwert 0.98, horizontal: 1.09, vertikal: 0.84

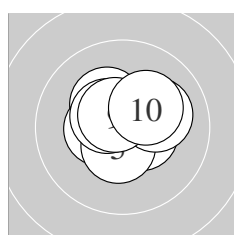
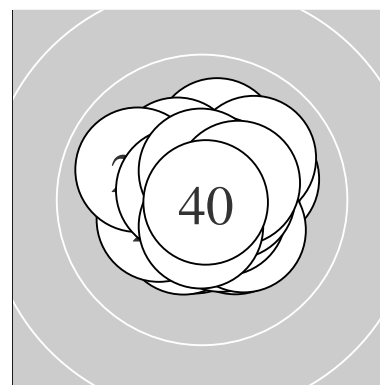

Serie 1:  
 10.7 \*                      10.3 \*                      10.4 \*                      10.5 \*                      10.5 \*  
 10.2 \*                      10.5 \*                      10.1 ↗                      10.6 \*                      10.2 \*  
 beste Teiler 56.4 (1.) 87.1 (9.) 114.6 (7.)  
 Trefferlage 0.27 mm rechts, 0.41 mm hoch  
 Streuwert 1.01, horizontal: 1.20, vertikal: 0.78

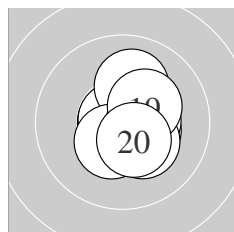

Serie 2:  
 10.5 \*                      10.8 \*                      10.8 \*                      10.4 \*                      10.1 ↑  
 10.4 \*                      10.4 \*                      10.3 \*                      10.3 \*                      10.4 \*  
 beste Teiler 45.5 (13.) 47.0 (12.) 110.6 (11.)  
 Trefferlage 0.55 mm rechts, 0.13 mm tief  
 Streuwert 0.93, horizontal: 0.79, vertikal: 1.05

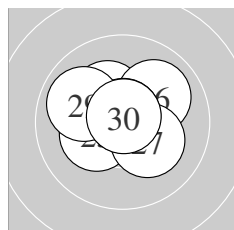

Serie 3:  
 10.3 \*                      10.5 \*                      10.3 \*                      10.4 \*                      10.3 \*  
 10.0 ↗                      10.2 \*                      10.8 \*                      9.9 ↖                      10.8 \*  
 beste Teiler 35.6 (30.) 38.3 (28.) 115.8 (22.)  
 Trefferlage 0.31 mm links, 0.20 mm hoch  
 Streuwert 1.21, horizontal: 1.44, vertikal: 0.92

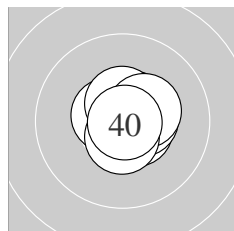

Serie 4:  
 10.6 \*                      10.6 \*                      10.5 \*                      10.5 \*                      10.5 \*  
 10.6 \*                      10.5 \*                      10.4 \*                      10.6 \*                      10.9 \*  
 beste Teiler 15.8 (40.) 92.8 (32.) 92.9 (31.)  
 Trefferlage 0.50 mm rechts, 0.22 mm hoch  
 Streuwert 0.64, horizontal: 0.69, vertikal: 0.60

Unterschrift des Schützen

Meyton Elektronik

Ergebnis: **416.9** (396)  
 Serien: 104.4 103.9 103.3 105.3  
 Zähler: 36 4 0 0 0 0 0 0 0 0  
 Innenzehner: 36  
 weiteste: 343 (17), 331 (21), 328 (24)  
 beste Teiler 35.0 (36.) 41.2 (10.) 55.1 (35.)  
 Trefferlage 0.00 mm , 0.09 mm hoch  
 Streuwert 1.07, horizontal: 1.10, vertikal: 1.04

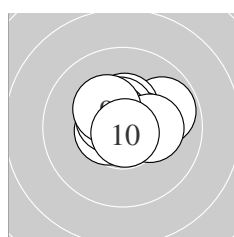
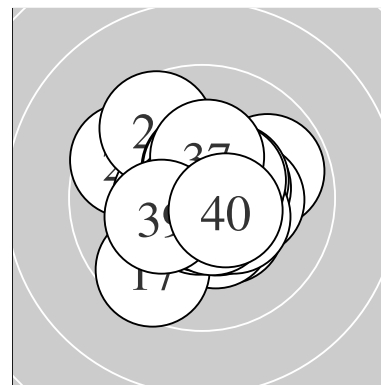

Serie 1:  
 10.6 \* 9.8 ↗ 10.4 \* 10.5 \* 10.5 \*  
 10.7 \* 10.6 \* 10.2 \* 10.3 \* 10.8 \*  
 beste Teiler 41.2 (10.) 72.6 (6.) 96.0 (1.)  
 Trefferlage 0.23 mm rechts, 0.51 mm hoch  
 Streuwert 0.97, horizontal: 1.22, vertikal: 0.63

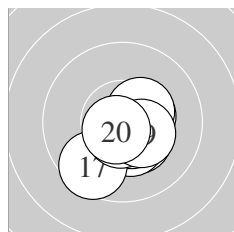

Serie 2:  
 10.4 \* 10.4 \* 10.4 \* 10.4 \* 10.6 \*  
 10.4 \* 9.6 ↙ 10.6 \* 10.4 \* 10.7 \*  
 beste Teiler 65.2 (20.) 79.0 (18.) 100.8 (15.)  
 Trefferlage 0.41 mm rechts, 0.81 mm tief  
 Streuwert 0.98, horizontal: 1.00, vertikal: 0.96

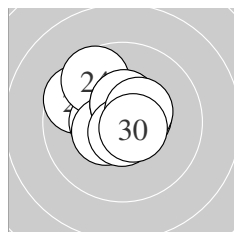

Serie 3:  
 9.6 ↖ 10.4 \* 10.5 \* 9.6 ↗ 10.5 \*  
 10.5 \* 10.5 \* 10.7 \* 10.4 \* 10.6 \*  
 beste Teiler 66.1 (28.) 78.7 (30.) 102.4 (23.)  
 Trefferlage 0.42 mm links, 0.60 mm hoch  
 Streuwert 1.20, horizontal: 1.32, vertikal: 1.08

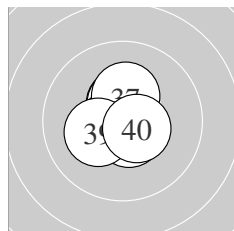

Serie 4:  
 10.5 \* 10.7 \* 10.5 \* 10.5 \* 10.7 \*  
 10.8 \* 10.3 \* 10.6 \* 10.2 \* 10.5 \*  
 beste Teiler 35.0 (36.) 55.1 (35.) 71.0 (32.)  
 Trefferlage 0.20 mm links, 0.09 mm hoch  
 Streuwert 0.82, horizontal: 0.74, vertikal: 0.89

Unterschrift des Schützen

Meyton Elektronik

Ergebnis: **413.6** (398)  
 Serien: 102.2 102.6 103.6 105.2  
 Zähler: 38 2 0 0 0 0 0 0 0 0  
 Innenzehner: 31  
 weiteste: 294 (3), 274 (25), 241 (2)  
 beste Teiler 14.8 (39.) 20.2 (37.) 43.4 (6.)  
 Trefferlage 0.21 mm rechts, 0.01 mm hoch  
 Streuwert 1.20, horizontal: 1.18, vertikal: 1.22

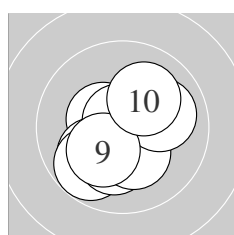
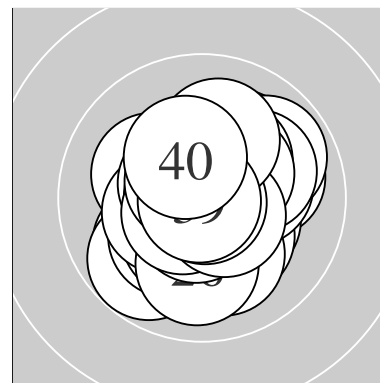

Serie 1:  
 10.4 \* 10.0 ↙ 9.8 ↙ 10.2 \* 10.4 \*  
 10.8 \* 10.3 \* 10.0 → 10.2 \* 10.1 ↗  
 beste Teiler 43.4 (6.) 128.3 (1.) 150.9 (5.)  
 Trefferlage 0.11 mm links, 0.47 mm tief  
 Streuwert 1.42, horizontal: 1.45, vertikal: 1.39

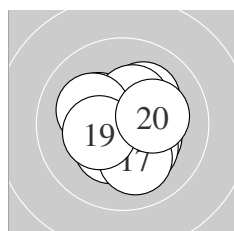

Serie 2:  
 10.3 \* 10.3 \* 10.2 \* 10.2 \* 10.3 \*  
 10.4 \* 10.1 ↓ 10.2 \* 10.4 \* 10.2 \*  
 beste Teiler 149.4 (16.) 150.2 (19.) 154.3 (15.)  
 Trefferlage 0.15 mm rechts, 0.09 mm tief  
 Streuwert 1.32, horizontal: 1.36, vertikal: 1.28

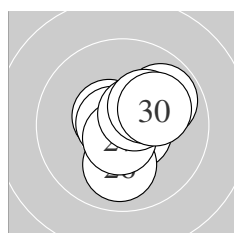

Serie 3:  
 10.2 \* 10.6 \* 10.6 \* 10.7 \* 9.9 ↗  
 10.0 ↓ 10.6 \* 10.6 \* 10.3 \* 10.1 ↗  
 beste Teiler 61.0 (24.) 80.2 (27.) 86.6 (22.)  
 Trefferlage 0.67 mm rechts, 0.23 mm hoch  
 Streuwert 1.13, horizontal: 1.10, vertikal: 1.17

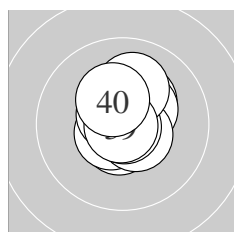

Serie 4:  
 10.3 \* 10.6 \* 10.6 \* 10.4 \* 10.5 \*  
 10.6 \* 10.9 \* 10.1 ↑ 10.9 \* 10.3 \*  
 beste Teiler 14.8 (39.) 20.2 (37.) 83.4 (36.)  
 Trefferlage 0.14 mm rechts, 0.41 mm hoch  
 Streuwert 0.88, horizontal: 0.70, vertikal: 1.02

Unterschrift des Schützen

Meyton Elektronik

Ergebnis: **407.4** (391)  
 Serien: 102.1 101.6 102.6 101.1  
 Zähler: 31 9 0 0 0 0 0 0 0 0  
 Innenzehner: 24  
 weiteste: 432 (38), 378 (39), 343 (29)  
 beste Teiler 52.6 (23.) 55.7 (36.) 67.0 (25.)  
 Trefferlage 0.52 mm links, 0.21 mm hoch  
 Streuwert 1.45, horizontal: 1.65, vertikal: 1.22

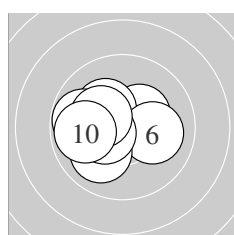
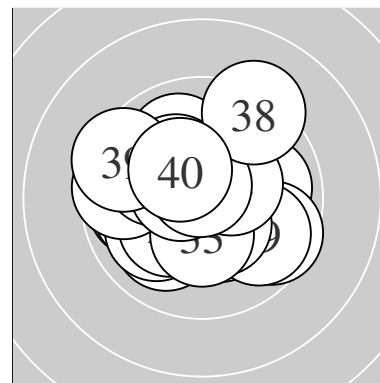

Serie 1:  
 10.7 \* 10.3 \* 10.4 \* 10.2 \* 9.8 ←  
 10.1 → 10.0 ↙ 10.4 \* 10.3 \* 9.9 ←  
 beste Teiler 67.6 (1.) 133.7 (8.) 149.2 (3.)  
 Trefferlage 0.96 mm links, 0.19 mm hoch  
 Streuwert 1.30, horizontal: 1.58, vertikal: 0.92

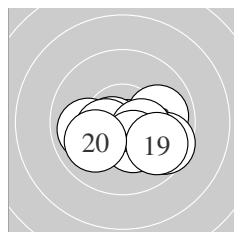

Serie 2:  
 10.7 \* 10.6 \* 9.9 → 9.9 ← 10.4 \*  
 9.6 ↘ 10.4 \* 10.3 \* 9.8 ↘ 10.0 ↙  
 beste Teiler 68.8 (11.) 86.3 (12.) 133.3 (15.)  
 Trefferlage 0.39 mm rechts, 0.80 mm tief  
 Streuwert 1.46, horizontal: 1.96, vertikal: 0.64

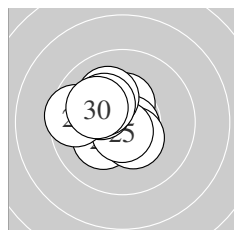

Serie 3:  
 10.2 \* 10.4 \* 10.7 \* 10.4 \* 10.7 \*  
 10.2 \* 10.1 ↘ 10.2 \* 9.6 ← 10.1 ↘  
 beste Teiler 52.6 (23.) 67.0 (25.) 132.3 (22.)  
 Trefferlage 0.93 mm links, 0.36 mm hoch  
 Streuwert 1.18, horizontal: 1.26, vertikal: 1.09

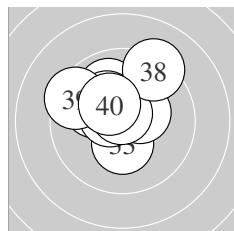

Serie 4:  
 10.0 ↘ 10.0 ↖ 10.3 \* 10.4 \* 10.6 \*  
 10.7 \* 10.2 \* 9.2 ↗ 9.4 ↘ 10.3 \*  
 beste Teiler 55.7 (36.) 98.6 (35.) 140.4 (34.)  
 Trefferlage 0.60 mm links, 1.12 mm hoch  
 Streuwert 1.48, horizontal: 1.59, vertikal: 1.37

Unterschrift des Schützen

Meyton Elektronik

Ergebnis: **412.5** (396)  
 Serien: 103.2 102.9 103.4 103.0  
 Zähler: 36 4 0 0 0 0 0 0 0 0  
 Innenzehner: 30  
 weiteste: 306 (2), 273 (3), 268 (13)  
 beste Teiler 47.0 (22.) 59.2 (5.) 66.2 (34.)  
 Trefferlage 0.13 mm links, 0.13 mm tief  
 Streuwert 1.22, horizontal: 1.15, vertikal: 1.30

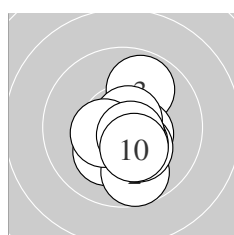
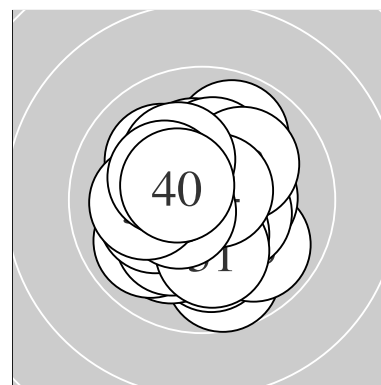

Serie 1:  
 10.2 \* 9.7 ↓ 9.9 ↗ 10.5 \* 10.7 \*  
 10.3 \* 10.5 \* 10.4 \* 10.7 \* 10.3 \*  
 beste Teiler 59.2 (5.) 75.6 (9.) 118.4 (4.)  
 Trefferlage 0.43 mm rechts, 0.67 mm tief  
 Streuwert 1.18, horizontal: 0.85, vertikal: 1.43

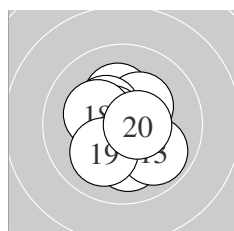

Serie 2:  
 10.5 \* 10.1 ↓ 9.9 ↘ 10.2 \* 10.3 \*  
 10.4 \* 10.6 \* 10.2 \* 10.1 ↙ 10.6 \*  
 beste Teiler 80.7 (17.) 98.1 (20.) 124.5 (11.)  
 Trefferlage 0.15 mm links, 0.16 mm tief  
 Streuwert 1.30, horizontal: 1.21, vertikal: 1.39

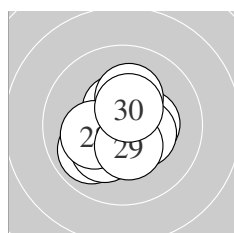

Serie 3:  
 9.9 ↖ 10.8 \* 10.5 \* 10.3 \* 10.2 \*  
 10.4 \* 10.2 \* 10.2 \* 10.4 \* 10.5 \*  
 beste Teiler 47.0 (22.) 112.3 (23.) 120.2 (30.)  
 Trefferlage 0.14 mm links, 0.11 mm tief  
 Streuwert 1.21, horizontal: 1.22, vertikal: 1.21

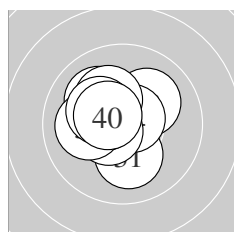

Serie 4:  
 10.1 ↓ 10.1 ↖ 10.1 ↗ 10.7 \* 10.5 \*  
 10.2 \* 10.4 \* 10.1 ← 10.3 \* 10.5 \*  
 beste Teiler 66.2 (34.) 101.9 (35.) 113.3 (40.)  
 Trefferlage 0.67 mm links, 0.43 mm hoch  
 Streuwert 1.13, horizontal: 1.16, vertikal: 1.10

Unterschrift des Schützen

Meyton Elektronik

Ergebnis: **419.3** (397)  
 Serien: 104.0 104.5 105.5 105.3  
 Zähler: 37 3 0 0 0 0 0 0 0 0  
 Innenzehner: 34  
 weiteste: 276 (3), 260 (1), 259 (27)  
 beste Teiler 33.1 (8.) 44.5 (17.) 45.8 (22.)  
 Trefferlage 0.10 mm rechts, 0.23 mm hoch  
 Streuwert 0.95, horizontal: 0.87, vertikal: 1.02

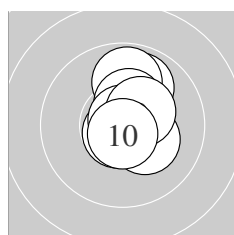
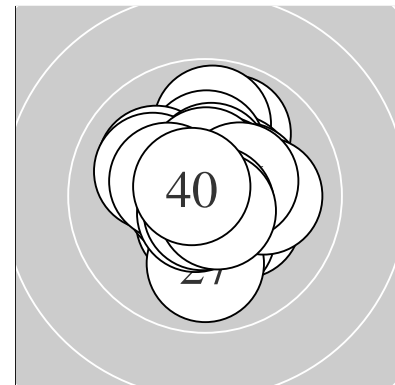

Serie 1:  
 9.9 ↗ 10.7 \* 9.8 ↑ 10.5 \* 10.5 \*  
 10.4 \* 10.3 \* 10.8 \* 10.4 \* 10.7 \*  
 beste Teiler 33.1 (8.) 55.0 (10.) 59.0 (2.)  
 Trefferlage 0.55 mm rechts, 0.64 mm hoch  
 Streuwert 0.99, horizontal: 0.58, vertikal: 1.28

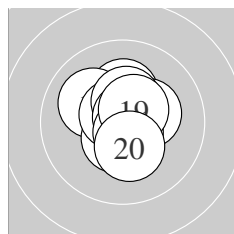

Serie 2:  
 10.2 \* 10.1 ↖ 10.3 \* 10.5 \* 10.7 \*  
 10.4 \* 10.8 \* 10.7 \* 10.5 \* 10.3 \*  
 beste Teiler 44.5 (17.) 73.5 (15.) 73.8 (18.)  
 Trefferlage 0.07 mm rechts, 0.33 mm hoch  
 Streuwert 0.99, horizontal: 0.89, vertikal: 1.08

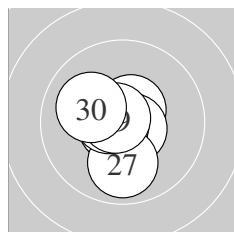

Serie 3:  
 10.7 \* 10.8 \* 10.7 \* 10.6 \* 10.7 \*  
 10.7 \* 9.9 ↓ 10.6 \* 10.7 \* 10.1 ↙  
 beste Teiler 45.8 (22.) 52.8 (29.) 60.8 (23.)  
 Trefferlage 0.33 mm links, 0.06 mm tief  
 Streuwert 0.90, horizontal: 0.77, vertikal: 1.01

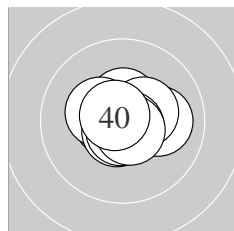

Serie 4:  
 10.5 \* 10.6 \* 10.3 \* 10.1 → 10.6 \*  
 10.4 \* 10.7 \* 10.7 \* 10.7 \* 10.7 \*  
 beste Teiler 52.4 (38.) 61.0 (37.) 62.4 (40.)  
 Trefferlage 0.12 mm rechts, 0.04 mm hoch  
 Streuwert 0.87, horizontal: 1.07, vertikal: 0.61

Unterschrift des Schützen

Ergebnis: **418.9** (398)  
 Serien: 104.4 105.7 103.8 105.0  
 Zähler: 38 2 0 0 0 0 0 0 0 0  
 Innenzehner: 34  
 weiteste: 325 (2), 280 (38), 241 (3)  
 beste Teiler 8.0 (40.) 20.2 (32.) 34.0 (5.)  
 Trefferlage 0.16 mm rechts, 0.13 mm hoch  
 Streuwert 0.99, horizontal: 0.88, vertikal: 1.09

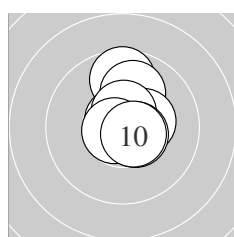
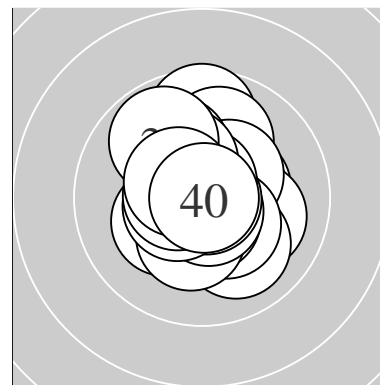

Serie 1:  
 10.4 \* 9.7 ↑ 10.0 ↑ 10.7 \* 10.8 \*  
 10.4 \* 10.6 \* 10.5 \* 10.7 \* 10.6 \*  
 beste Teiler 34.0 (5.) 57.6 (4.) 60.0 (9.)  
 Trefferlage 0.40 mm rechts, 0.72 mm hoch  
 Streuwert 0.97, horizontal: 0.61, vertikal: 1.23

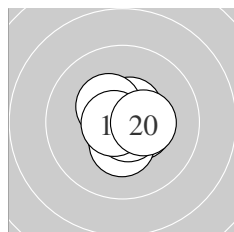

Serie 2:  
 10.5 \* 10.5 \* 10.8 \* 10.7 \* 10.6 \*  
 10.4 \* 10.7 \* 10.4 \* 10.7 \* 10.4 \*  
 beste Teiler 36.4 (13.) 59.6 (17.) 59.6 (19.)  
 Trefferlage 0.28 mm rechts, 0.11 mm tief  
 Streuwert 0.75, horizontal: 0.78, vertikal: 0.73

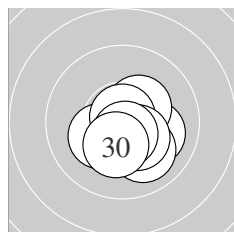

Serie 3:  
 10.4 \* 10.1 ↘ 10.4 \* 10.0 ↘ 10.6 \*  
 10.2 \* 10.8 \* 10.4 \* 10.6 \* 10.3 \*  
 beste Teiler 35.0 (27.) 80.7 (25.) 83.7 (29.)  
 Trefferlage 0.54 mm rechts, 0.69 mm tief  
 Streuwert 0.93, horizontal: 1.03, vertikal: 0.83

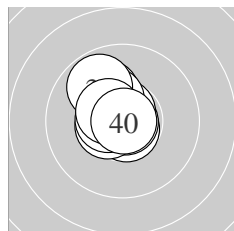

Serie 4:  
 10.7 \* 10.9 \* 10.1 ↖ 10.7 \* 10.5 \*  
 10.3 \* 10.6 \* 9.8 ↖ 10.5 \* 10.9 \*  
 beste Teiler 8.0 (40.) 20.2 (32.) 60.3 (31.)  
 Trefferlage 0.58 mm links, 0.61 mm hoch  
 Streuwert 0.84, horizontal: 0.66, vertikal: 0.98

Unterschrift des Schützen

Meyton Elektronik



Ergebnis: **416.2** (398)  
 Serien: 103.5 104.5 104.5 103.7  
 Zähler: 38 2 0 0 0 0 0 0 0 0  
 Innenzehner: 34  
 weiteste: 315 (33), 262 (6), 233 (2)  
 beste Teiler 36.6 (18.) 49.3 (32.) 50.0 (20.)  
 Trefferlage 0.01 mm rechts, 0.22 mm hoch  
 Streuwert 1.07, horizontal: 1.10, vertikal: 1.04

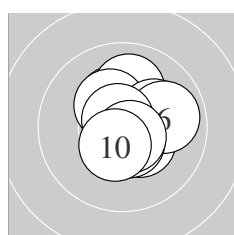
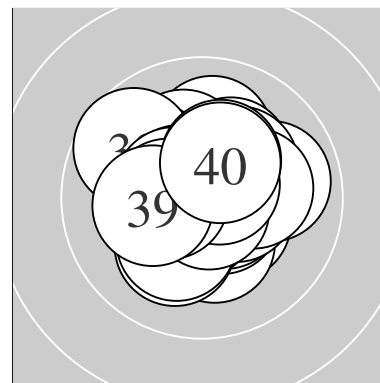

Serie 1:  
 10.3 \*                      10.0 ↑                      10.3 \*                      10.1 →                      10.4 \*  
 9.9 →                      10.7 \*                      10.6 \*                      10.7 \*                      10.5 \*  
 beste Teiler 54.9 (7.) 74.8 (9.) 98.0 (8.)  
 Trefferlage 0.47 mm rechts, 0.36 mm hoch  
 Streuwert 1.14, horizontal: 1.10, vertikal: 1.19

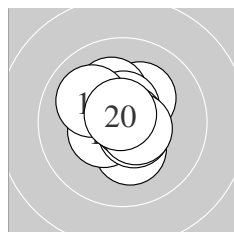

Serie 2:  
 10.3 \*                      10.2 \*                      10.2 \*                      10.6 \*                      10.4 \*  
 10.0 ↘                      10.6 \*                      10.8 \*                      10.6 \*                      10.8 \*  
 beste Teiler 36.6 (18.) 50.0 (20.) 92.3 (17.)  
 Trefferlage 0.04 mm links, 0.28 mm hoch  
 Streuwert 1.03, horizontal: 0.95, vertikal: 1.11

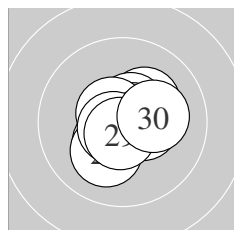

Serie 3:  
 10.2 \*                      10.3 \*                      10.6 \*                      10.7 \*                      10.6 \*  
 10.1 ↙                      10.4 \*                      10.7 \*                      10.7 \*                      10.2 \*  
 beste Teiler 65.1 (24.) 66.8 (28.) 72.5 (29.)  
 Trefferlage 0.23 mm rechts, 0.11 mm tief  
 Streuwert 0.98, horizontal: 1.04, vertikal: 0.93

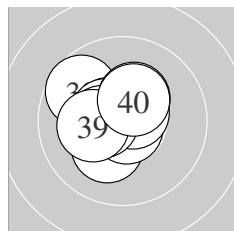

Serie 4:  
 10.2 \*                      10.8 \*                      9.7 ↘                      10.6 \*                      10.5 \*  
 10.6 \*                      10.3 \*                      10.4 \*                      10.2 \*                      10.4 \*  
 beste Teiler 49.3 (32.) 82.6 (36.) 94.5 (34.)  
 Trefferlage 0.61 mm links, 0.36 mm hoch  
 Streuwert 1.08, horizontal: 1.14, vertikal: 1.01

Unterschrift des Schützen

Meyton Elektronik

Ergebnis: **403.5** (387)  
 Serien: 98.7 101.5 100.6 102.7  
 Zähler: 27 13 0 0 0 0 0 0 0 0  
 Innenzehner: 22  
 weiteste: 468 (2), 449 (21), 406 (6)  
 beste Teiler 48.0 (36.) 69.4 (38.) 86.1 (18.)  
 Trefferlage 0.06 mm links, 0.42 mm hoch  
 Streuwert 1.69, horizontal: 1.50, vertikal: 1.87

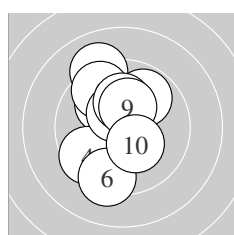
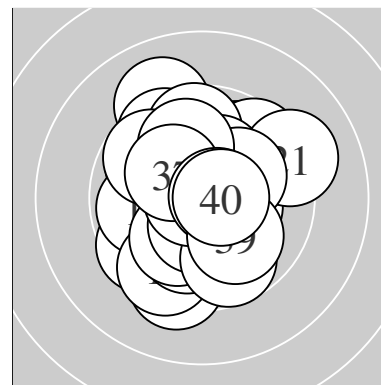

Serie 1:  
 9.8 ↗ 9.1 ↖ 10.0 ↘ 9.6 ↙ 9.6 ↖  
 9.3 ↘ 10.5 \* 10.2 \* 10.3 \* 10.3 \*  
 beste Teiler 123.0 (7.) 161.0 (9.) 162.6 (10.)  
 Trefferlage 0.65 mm links, 0.84 mm hoch  
 Streuwert 2.02, horizontal: 1.37, vertikal: 2.51

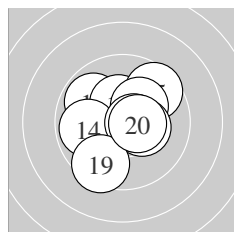

Serie 2:  
 10.6 \* 9.9 ↖ 10.4 \* 9.9 ← 9.6 ↗  
 10.2 \* 10.3 \* 10.6 \* 9.5 ↘ 10.5 \*  
 beste Teiler 86.1 (18.) 89.8 (11.) 116.6 (20.)  
 Trefferlage 0.04 mm links, 0.28 mm hoch  
 Streuwert 1.66, horizontal: 1.76, vertikal: 1.56

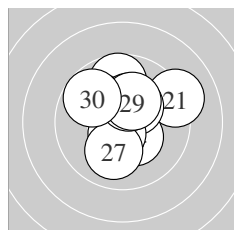

Serie 3:  
 9.2 ↗ 10.2 \* 9.7 ↑ 10.4 \* 10.3 \*  
 10.6 \* 10.0 ↘ 10.3 \* 10.2 \* 9.7 ↖  
 beste Teiler 100.1 (26.) 147.2 (24.) 153.4 (25.)  
 Trefferlage 0.23 mm rechts, 0.85 mm hoch  
 Streuwert 1.69, horizontal: 1.70, vertikal: 1.68

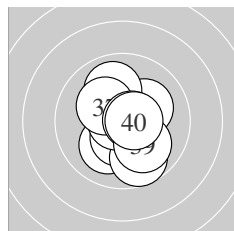

Serie 4:  
 10.2 \* 10.1 ↙ 10.4 \* 10.0 ↑ 9.7 ↘  
 10.8 \* 10.2 \* 10.7 \* 10.0 ↘ 10.6 \*  
 beste Teiler 48.0 (36.) 69.4 (38.) 88.0 (40.)  
 Trefferlage 0.20 mm rechts, 0.30 mm tief  
 Streuwert 1.39, horizontal: 1.14, vertikal: 1.61

Unterschrift des Schützen

Meyton Elektronik