

Ergebnis: **310.4** (297)
 Serien: 101.2 103.7 105.5
 Zähler: 27 3 0 0 0 0 0 0 0 0
 Innenzehner: 21
 weiteste: 348 (10), 289 (19), 262 (4)
 beste Teiler 4.0 (30.) 24.0 (13.) 48.5 (29.)
 Trefferlage 0.52 mm links, 0.02 mm hoch
 Streuwert 1.21, horizontal: 1.46, vertikal: 0.88

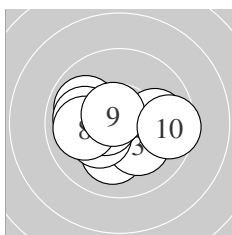

Serie 1:
 10.0 → 10.1 ↓ 10.2 * 9.9 ↖ 10.3 *
 10.0 ← 10.5 * 10.0 ← 10.6 * 9.6 →
 beste Teiler 77.2 (9.) 103.0 (7.) 166.9 (5.)
 Trefferlage 0.33 mm links, 0.27 mm tief
 Streuwert 1.64, horizontal: 2.11, vertikal: 0.96

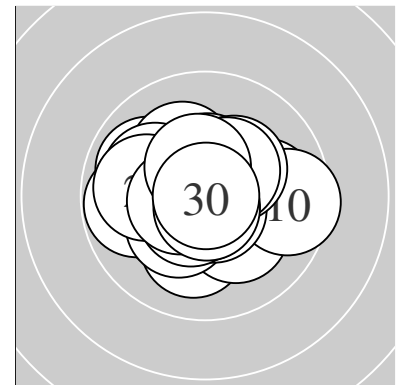
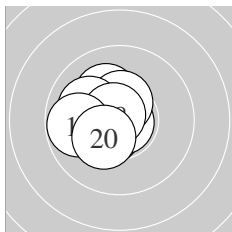

Serie 2:
 10.3 * 10.5 * 10.9 * 10.2 * 10.5 *
 10.5 * 10.0 ↖ 10.7 * 9.8 ← 10.3 *
 beste Teiler 24.0 (13.) 56.6 (18.) 113.3 (12.)
 Trefferlage 1.06 mm links, 0.22 mm hoch
 Streuwert 0.93, horizontal: 0.94, vertikal: 0.92

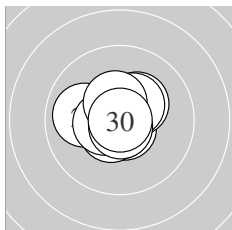

Serie 3:
 10.7 * 10.0 ← 10.8 * 10.3 * 10.6 *
 10.5 * 10.4 * 10.5 * 10.8 * 10.9 *
 beste Teiler 4.0 (30.) 48.5 (29.) 49.0 (23.)
 Trefferlage 0.18 mm links, 0.12 mm hoch
 Streuwert 0.91, horizontal: 1.04, vertikal: 0.76

Unterschrift des Schützen

Ergebnis: **312.0** (297)
 Serien: 104.6 103.7 103.7
 Zähler: 27 3 0 0 0 0 0 0 0 0
 Innenzehner: 25
 weiteste: 317 (28), 312 (9), 265 (16)
 beste Teiler 55.4 (15.) 57.9 (2.) 62.4 (10.)
 Trefferlage 0.10 mm rechts, 0.12 mm hoch
 Streuwert 1.13, horizontal: 1.21, vertikal: 1.03

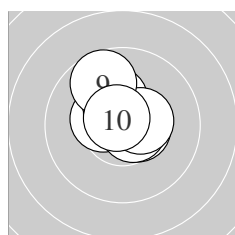
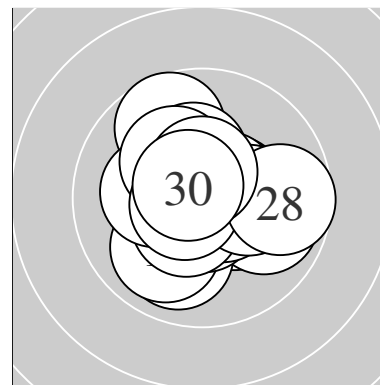

Serie 1:
 10.4 * 10.7 * 10.6 * 10.6 * 10.5 *
 10.2 * 10.7 * 10.5 * 9.7 ↗ 10.7 *
 beste Teiler 57.9 (2.) 62.4 (10.) 75.9 (7.)
 Trefferlage 0.03 mm rechts, 0.64 mm hoch
 Streuwert 0.95, horizontal: 0.94, vertikal: 0.96

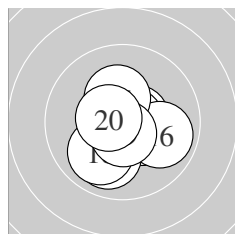

Serie 2:
 10.6 * 10.6 * 10.4 * 10.0 ↙ 10.7 *
 9.9 ↘ 10.3 * 10.0 ↙ 10.6 * 10.6 *
 beste Teiler 55.4 (15.) 77.1 (19.) 87.0 (12.)
 Trefferlage 0.07 mm rechts, 0.46 mm tief
 Streuwert 1.19, horizontal: 1.24, vertikal: 1.14

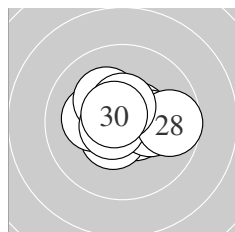

Serie 3:
 10.6 * 10.5 * 10.5 * 10.2 * 10.2 *
 10.2 * 10.7 * 9.7 → 10.5 * 10.6 *
 beste Teiler 75.0 (27.) 76.4 (30.) 90.4 (21.)
 Trefferlage 0.18 mm rechts, 0.20 mm hoch
 Streuwert 1.18, horizontal: 1.52, vertikal: 0.71

Unterschrift des Schützen

Ergebnis: **310.5** (296)
 Serien: 103.4 103.5 103.6
 Zähler: 26 4 0 0 0 0 0 0 0 0
 Innenzehner: 22
 weiteste: 440 (6), 265 (24), 265 (27)
 beste Teiler 21.4 (26.) 29.0 (3.) 31.0 (1.)
 Trefferlage 0.48 mm links, 0.21 mm hoch
 Streuwert 1.20, horizontal: 1.41, vertikal: 0.96

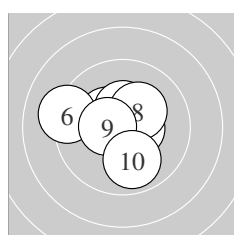
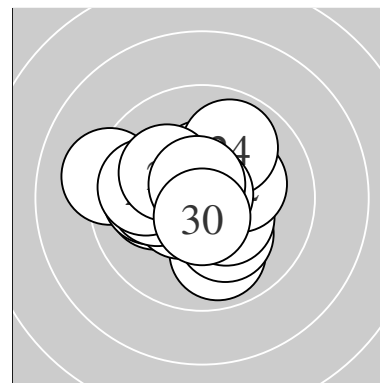

Serie 1:
 10.8 * 10.4 * 10.8 * 10.5 * 10.6 *
 9.2 ← 10.4 * 10.3 * 10.5 * 9.9 ↓
 beste Teiler 29.0 (3.) 31.0 (1.) 81.5 (5.)
 Trefferlage 0.36 mm links, 0.28 mm hoch
 Streuwert 1.38, horizontal: 1.60, vertikal: 1.13

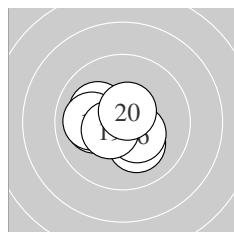

Serie 2:
 10.5 * 10.7 * 10.2 * 10.4 * 10.1 ↖
 10.4 * 10.1 ← 10.0 ← 10.5 * 10.6 *
 beste Teiler 58.1 (12.) 92.7 (20.) 112.6 (19.)
 Trefferlage 0.58 mm links, 0.20 mm tief
 Streuwert 1.12, horizontal: 1.37, vertikal: 0.81

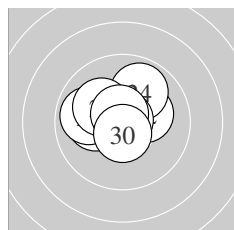

Serie 3:
 10.4 * 10.2 * 10.7 * 9.9 ↗ 10.1 ←
 10.9 * 9.9 ← 10.2 * 10.7 * 10.6 *
 beste Teiler 21.4 (26.) 52.3 (23.) 67.4 (29.)
 Trefferlage 0.49 mm links, 0.56 mm hoch
 Streuwert 1.14, horizontal: 1.39, vertikal: 0.82

Unterschrift des Schützen

Ergebnis: **314.0** (299)
 Serien: 104.9 104.4 104.7
 Zähler: 29 1 0 0 0 0 0 0 0 0
 Innenzehner: 24
 weiteste: 258 (20), 245 (14), 245 (21)
 beste Teiler 34.9 (7.) 44.9 (17.) 45.0 (16.)
 Trefferlage 0.11 mm links, 0.10 mm hoch
 Streuwert 1.00, horizontal: 1.16, vertikal: 0.80

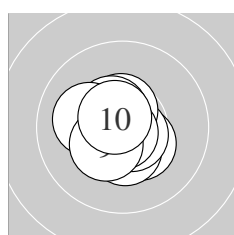
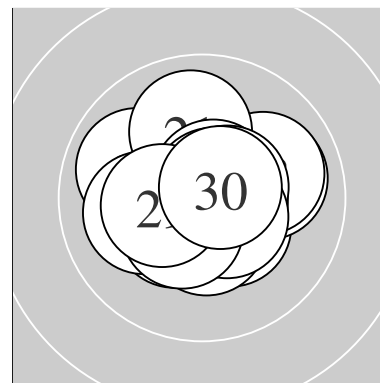

Serie 1:
 10.4 * 10.5 * 10.4 * 10.7 * 10.5 *
 10.5 * 10.8 * 10.1 ← 10.4 * 10.6 *
 beste Teiler 34.9 (7.) 70.9 (4.) 76.8 (10.)
 Trefferlage 0.39 mm links, 0.11 mm tief
 Streuwert 0.87, horizontal: 0.90, vertikal: 0.85

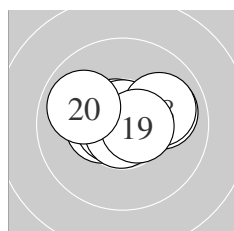

Serie 2:
 10.5 * 10.4 * 10.7 * 10.0 → 10.7 *
 10.8 * 10.8 * 10.0 → 10.6 * 9.9 ←
 beste Teiler 44.9 (17.) 45.0 (16.) 64.4 (15.)
 Trefferlage 0.20 mm rechts, 0.32 mm hoch
 Streuwert 1.12, horizontal: 1.51, vertikal: 0.49

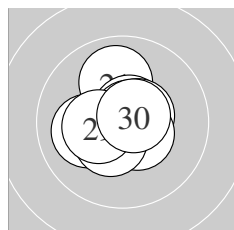

Serie 3:
 10.0 ↑ 10.7 * 10.1 ← 10.7 * 10.6 *
 10.7 * 10.5 * 10.4 * 10.4 * 10.6 *
 beste Teiler 51.2 (26.) 63.1 (22.) 74.3 (24.)
 Trefferlage 0.15 mm links, 0.09 mm hoch
 Streuwert 1.01, horizontal: 1.03, vertikal: 1.00

Unterschrift des Schützen

Ergebnis: **313.0** (297)
 Serien: 104.9 104.3 103.8
 Zähler: 27 3 0 0 0 0 0 0 0 0
 Innenzehner: 26
 weiteste: 310 (26), 303 (14), 270 (25)
 beste Teiler 15.5 (23.) 20.1 (9.) 49.2 (12.)
 Trefferlage 0.07 mm rechts, 0.10 mm tief
 Streuwert 1.08, horizontal: 1.25, vertikal: 0.86

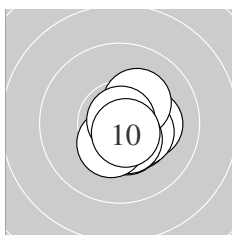
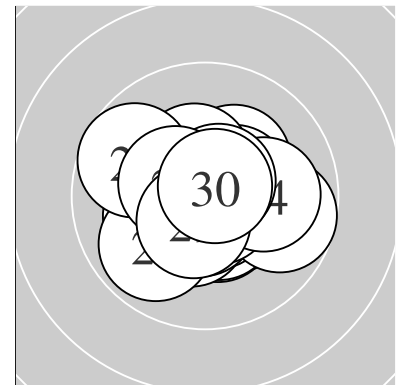

Serie 1:
 10.6 * 10.4 * 10.2 * 10.5 * 10.4 *
 10.3 * 10.5 * 10.4 * 10.9 * 10.7 *
 beste Teiler 20.1 (9.) 75.4 (10.) 87.6 (1.)
 Trefferlage 0.69 mm rechts, 0.48 mm tief
 Streuwert 0.74, horizontal: 0.69, vertikal: 0.79

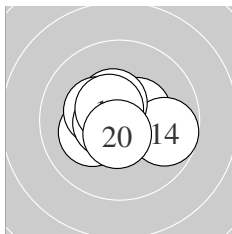

Serie 2:
 10.2 * 10.8 * 10.5 * 9.7 → 10.5 *
 10.6 * 10.3 * 10.6 * 10.5 * 10.6 *
 beste Teiler 49.2 (12.) 83.7 (16.) 84.9 (18.)
 Trefferlage 0.16 mm links, 0.04 mm hoch
 Streuwert 1.10, horizontal: 1.38, vertikal: 0.72

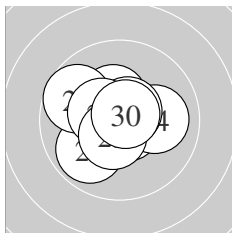

Serie 3:
 10.7 * 10.4 * 10.9 * 10.0 → 9.9 ↙
 9.7 ↖ 10.6 * 10.4 * 10.5 * 10.7 *
 beste Teiler 15.5 (23.) 55.1 (30.) 65.0 (21.)
 Trefferlage 0.29 mm links, 0.11 mm hoch
 Streuwert 1.24, horizontal: 1.42, vertikal: 1.02

Unterschrift des Schützen

Ergebnis: **311.6** (299)
 Serien: 103.8 103.7 104.1
 Zähler: 29 1 0 0 0 0 0 0 0 0
 Innenzehner: 25
 weiteste: 450 (19), 245 (1), 229 (14)
 beste Teiler 19.0 (15.) 26.5 (17.) 28.2 (8.)
 Trefferlage 0.38 mm rechts, 0.24 mm hoch
 Streuwert 1.13, horizontal: 1.24, vertikal: 1.01

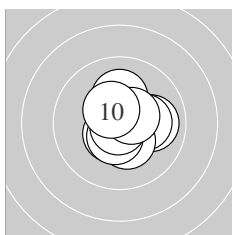
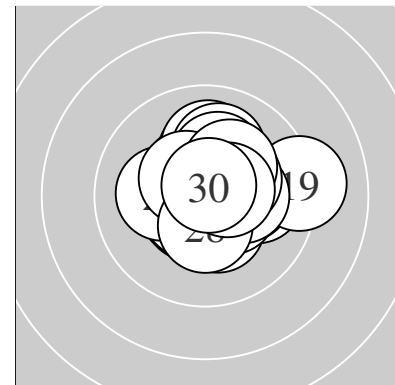

Serie 1:
 10.0 → 10.2 * 10.4 * 10.1 ↑ 10.3 *
 10.5 * 10.5 * 10.8 * 10.5 * 10.5 *
 beste Teiler 28.2 (8.) 107.4 (6.) 109.1 (7.)
 Trefferlage 0.45 mm rechts, 0.10 mm tief
 Streuwert 1.07, horizontal: 1.05, vertikal: 1.09

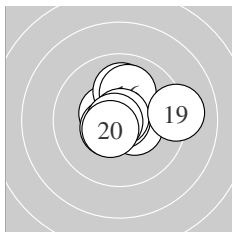

Serie 2:
 10.5 * 10.4 * 10.5 * 10.0 ↑ 10.9 *
 10.1 † 10.8 * 10.8 * 9.2 → 10.5 *
 beste Teiler 19.0 (15.) 26.5 (17.) 42.7 (18.)
 Trefferlage 0.37 mm rechts, 0.38 mm hoch
 Streuwert 1.36, horizontal: 1.60, vertikal: 1.07

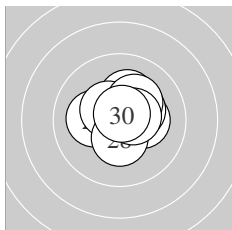

Serie 3:
 10.3 * 10.8 * 10.2 * 10.2 * 10.3 *
 10.5 * 10.2 * 10.4 * 10.5 * 10.7 *
 beste Teiler 41.6 (22.) 53.1 (30.) 109.8 (29.)
 Trefferlage 0.34 mm rechts, 0.46 mm hoch
 Streuwert 1.00, horizontal: 1.13, vertikal: 0.85

Unterschrift des Schützen

Ergebnis: **309.8** (296)
 Serien: 102.6 104.4 102.8
 Zähler: 26 4 0 0 0 0 0 0 0 0
 Innenzehner: 22
 weiteste: 444 (8), 358 (18), 300 (22)
 beste Teiler 24.4 (13.) 52.0 (11.) 53.0 (12.)
 Trefferlage 0.08 mm links, 0.24 mm hoch
 Streuwert 1.31, horizontal: 1.54, vertikal: 1.03

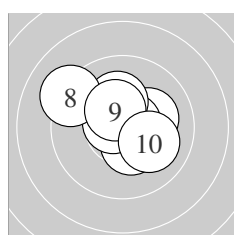
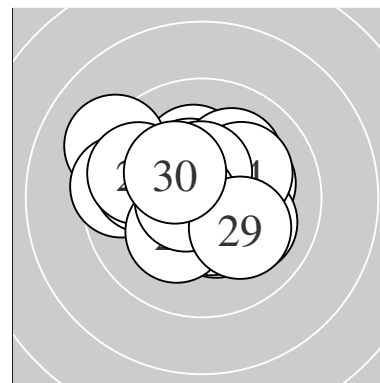

Serie 1:
 10.3 * 10.4 * 10.2 * 10.7 * 10.4 *
 10.2 * 10.7 * 9.2 ↖ 10.4 * 10.1 ↘
 beste Teiler 64.0 (4.) 75.6 (7.) 135.2 (9.)
 Trefferlage 0.19 mm rechts, 0.30 mm hoch
 Streuwert 1.50, horizontal: 1.71, vertikal: 1.25

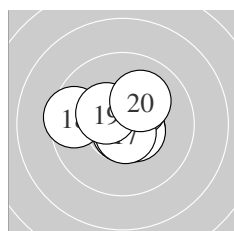

Serie 2:
 10.7 * 10.7 * 10.9 * 10.6 * 10.5 *
 10.3 * 10.7 * 9.5 ← 10.4 * 10.1 ↗
 beste Teiler 24.4 (13.) 52.0 (11.) 53.0 (12.)
 Trefferlage 0.06 mm links, 0.30 mm hoch
 Streuwert 1.16, horizontal: 1.43, vertikal: 0.81

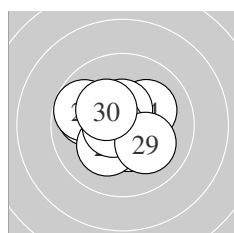

Serie 3:
 9.9 ↖ 9.8 ↖ 10.7 * 10.1 ↗ 10.5 *
 10.5 * 10.2 * 10.7 * 10.1 ↘ 10.3 *
 beste Teiler 58.3 (23.) 71.8 (28.) 112.1 (25.)
 Trefferlage 0.40 mm links, 0.11 mm hoch
 Streuwert 1.35, horizontal: 1.57, vertikal: 1.08

Unterschrift des Schützen

Ergebnis: **310.0** (297)
 Serien: 101.6 104.2 104.2
 Zähler: 27 3 0 0 0 0 0 0 0 0
 Innenzehner: 21
 weiteste: 302 (4), 282 (10), 264 (16)
 beste Teiler 4.0 (26.) 40.1 (15.) 59.8 (20.)
 Trefferlage 0.25 mm rechts, 0.35 mm hoch
 Streuwert 1.19, horizontal: 1.40, vertikal: 0.93

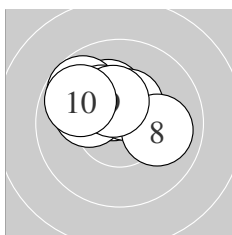
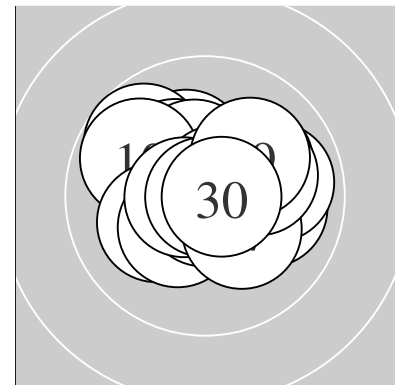

Serie 1:
 10.5 * 10.2 * 10.2 * 9.7 ↘ 10.2 *
 10.1 ↖ 10.5 * 10.0 → 10.4 * 9.8 ↘
 beste Teiler 122.4 (1.) 125.0 (7.) 142.7 (9.)
 Trefferlage 0.75 mm links, 1.19 mm hoch
 Streuwert 1.11, horizontal: 1.42, vertikal: 0.66

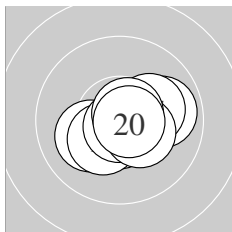

Serie 2:
 10.1 ↙ 10.5 * 10.6 * 10.3 * 10.8 *
 9.9 → 10.2 * 10.4 * 10.7 * 10.7 *
 beste Teiler 40.1 (15.) 59.8 (20.) 64.6 (19.)
 Trefferlage 0.48 mm rechts, 0.32 mm tief
 Streuwert 1.04, horizontal: 1.31, vertikal: 0.66

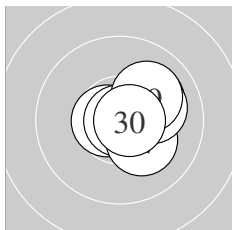

Serie 3:
 10.1 ↗ 10.5 * 10.6 * 10.6 * 10.4 *
 10.9 * 10.2 * 10.1 → 10.1 ↗ 10.7 *
 beste Teiler 4.0 (26.) 62.0 (30.) 78.1 (23.)
 Trefferlage 1.01 mm rechts, 0.20 mm hoch
 Streuwert 0.82, horizontal: 0.87, vertikal: 0.77

Unterschrift des Schützen

Ergebnis: **312.1** (299)
 Serien: 103.6 104.1 104.4
 Zähler: 29 1 0 0 0 0 0 0 0 0
 Innenzehner: 26
 weiteste: 332 (5), 248 (17), 244 (11)
 beste Teiler 39.6 (6.) 52.0 (8.) 53.0 (12.)
 Trefferlage 0.22 mm links, 0.05 mm hoch
 Streuwert 1.07, horizontal: 1.14, vertikal: 1.01

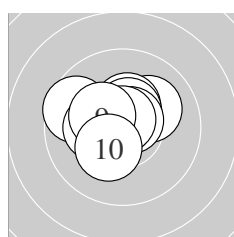
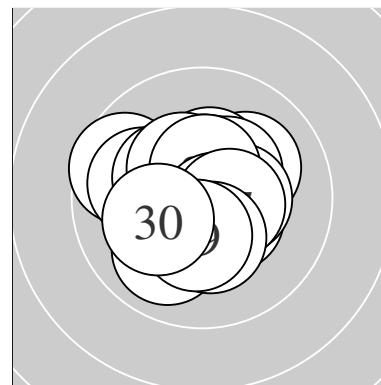

Serie 1:
 10.1 ↗ 10.4 * 10.5 * 10.7 * 9.6 ↖
 10.8 * 10.2 * 10.7 * 10.3 * 10.3 *
 beste Teiler 39.6 (6.) 52.0 (8.) 68.6 (4.)
 Trefferlage 0.45 mm links, 0.55 mm hoch
 Streuwert 1.13, horizontal: 1.38, vertikal: 0.81

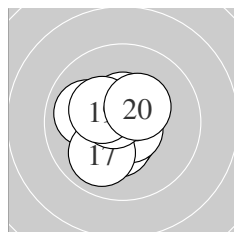

Serie 2:
 10.0 ↖ 10.7 * 10.5 * 10.5 * 10.4 *
 10.7 * 10.0 ↙ 10.6 * 10.3 * 10.4 *
 beste Teiler 53.0 (12.) 66.4 (16.) 76.2 (18.)
 Trefferlage 0.45 mm links, 0.04 mm tief
 Streuwert 1.07, horizontal: 1.00, vertikal: 1.13

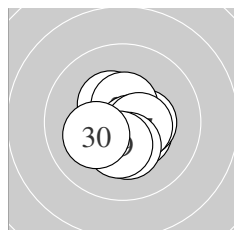

Serie 3:
 10.7 * 10.4 * 10.4 * 10.4 * 10.5 *
 10.7 * 10.5 * 10.3 * 10.3 * 10.2 *
 beste Teiler 64.8 (21.) 69.2 (26.) 111.6 (25.)
 Trefferlage 0.22 mm rechts, 0.35 mm tief
 Streuwert 0.95, horizontal: 0.96, vertikal: 0.94

Unterschrift des Schützen

Ergebnis: **314.8** (299)
 Serien: 104.4 105.8 104.6
 Zähler: 29 1 0 0 0 0 0 0 0 0
 Innenzehner: 27
 weiteste: 289 (4), 243 (7), 218 (28)
 beste Teiler 21.9 (10.) 48.4 (20.) 50.0 (11.)
 Trefferlage 0.17 mm rechts, 0.23 mm tief
 Streuwert 0.91, horizontal: 0.78, vertikal: 1.02

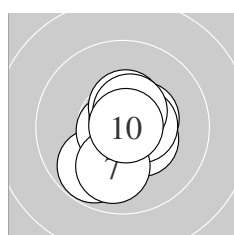
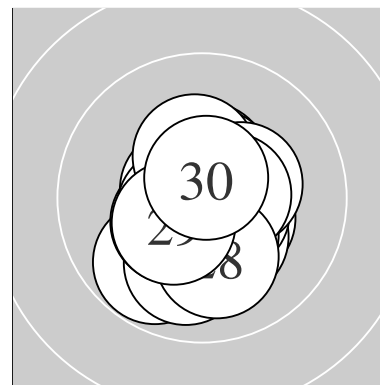

Serie 1:
 10.4 * 10.4 * 10.5 * 9.8 ✓ 10.7 *
 10.7 * 10.0 ↓ 10.5 * 10.5 * 10.9 *
 beste Teiler 21.9 (10.) 59.8 (5.) 61.0 (6.)
 Trefferlage 0.15 mm rechts, 0.21 mm tief
 Streuwert 1.10, horizontal: 0.91, vertikal: 1.25

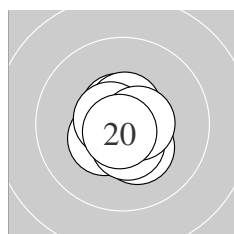

Serie 2:
 10.8 * 10.6 * 10.6 * 10.4 * 10.3 *
 10.6 * 10.6 * 10.5 * 10.6 * 10.8 *
 beste Teiler 48.4 (20.) 50.0 (11.) 79.3 (17.)
 Trefferlage 0.05 mm rechts, 0.30 mm tief
 Streuwert 0.73, horizontal: 0.66, vertikal: 0.80

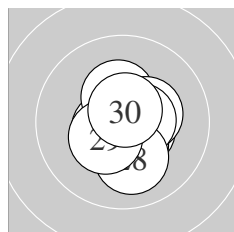

Serie 3:
 10.6 * 10.5 * 10.4 * 10.6 * 10.3 *
 10.4 * 10.6 * 10.1 ↓ 10.4 * 10.7 *
 beste Teiler 74.5 (30.) 92.1 (21.) 95.7 (24.)
 Trefferlage 0.32 mm rechts, 0.19 mm tief
 Streuwert 0.95, horizontal: 0.81, vertikal: 1.08

Unterschrift des Schützen

Ergebnis: **310.3** (296)
 Serien: 103.7 103.5 103.1
 Zähler: 26 4 0 0 0 0 0 0 0 0
 Innenzehner: 21
 weiteste: 286 (29), 278 (30), 272 (9)
 beste Teiler 18.0 (3.) 26.0 (5.) 47.7 (19.)
 Trefferlage 0.25 mm rechts, 0.06 mm hoch
 Streuwert 1.21, horizontal: 1.07, vertikal: 1.35

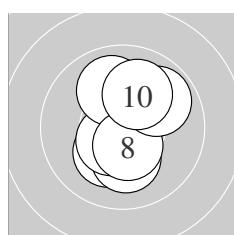
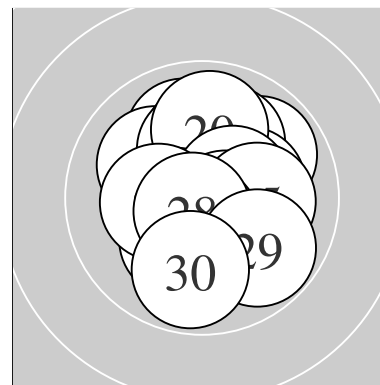

Serie 1:
 10.2 * 10.7 * 10.9 * 10.2 * 10.8 *
 10.5 * 10.0 ↕ 10.5 * 9.9 ↗ 10.0 ↗
 beste Teiler 18.0 (3.) 26.0 (5.) 59.5 (2.)
 Trefferlage 0.19 mm rechts, 0.06 mm hoch
 Streuwert 1.26, horizontal: 0.91, vertikal: 1.53

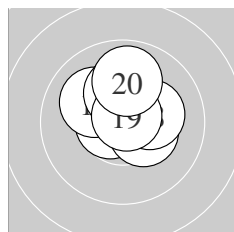

Serie 2:
 10.7 * 10.6 * 10.1 ↘ 10.5 * 10.1 ↑
 10.4 * 10.2 * 10.2 * 10.8 * 9.9 ↑
 beste Teiler 47.7 (19.) 57.9 (11.) 78.6 (12.)
 Trefferlage 0.15 mm rechts, 0.88 mm hoch
 Streuwert 1.03, horizontal: 1.04, vertikal: 1.03

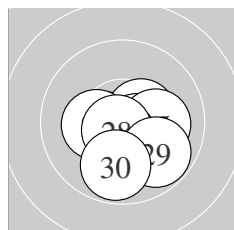

Serie 3:
 10.5 * 10.4 * 10.6 * 10.3 * 10.1 →
 10.3 * 10.6 * 10.7 * 9.8 ↘ 9.8 ↓
 beste Teiler 63.6 (28.) 99.0 (27.) 99.7 (23.)
 Trefferlage 0.40 mm rechts, 0.76 mm tief
 Streuwert 1.14, horizontal: 1.31, vertikal: 0.95

Unterschrift des Schützen

Ergebnis: **309.6** (295)
 Serien: 102.4 103.1 104.1
 Zähler: 25 5 0 0 0 0 0 0 0 0
 Innenzehner: 24
 weiteste: 363 (7), 282 (1), 280 (23)
 beste Teiler 40.8 (5.) 43.0 (29.) 53.0 (9.)
 Trefferlage 0.41 mm links, 0.13 mm hoch
 Streuwert 1.23, horizontal: 1.51, vertikal: 0.86

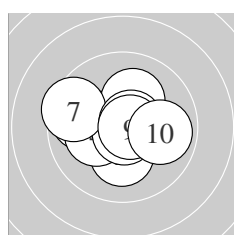
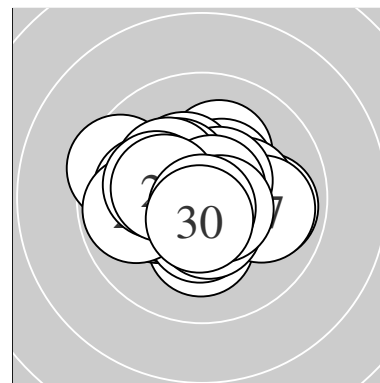

Serie 1:
 9.8 ← 10.2 * 10.4 * 10.2 * 10.8 *
 10.2 * 9.5 ← 10.7 * 10.7 * 9.9 →
 beste Teiler 40.8 (5.) 53.0 (9.) 68.0 (8.)
 Trefferlage 0.48 mm links, 0.11 mm hoch
 Streuwert 1.48, horizontal: 1.83, vertikal: 1.02

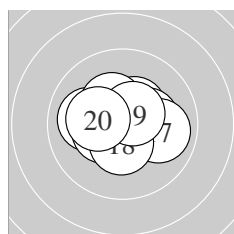

Serie 2:
 10.0 ← 10.4 * 10.3 * 10.6 * 10.3 *
 10.4 * 9.9 → 10.4 * 10.5 * 10.3 *
 beste Teiler 80.5 (14.) 101.8 (19.) 130.3 (18.)
 Trefferlage 0.00 mm , 0.26 mm hoch
 Streuwert 1.22, horizontal: 1.52, vertikal: 0.80

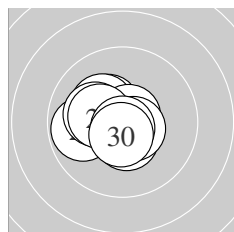

Serie 3:
 10.4 * 10.2 * 9.8 ← 10.7 * 10.2 *
 10.5 * 10.6 * 10.3 * 10.8 * 10.6 *
 beste Teiler 43.0 (29.) 56.6 (24.) 87.9 (27.)
 Trefferlage 0.73 mm links, 0.01 mm hoch
 Streuwert 1.00, horizontal: 1.17, vertikal: 0.80

Unterschrift des Schützen

Ergebnis: **310.9** (296)
 Serien: 102.1 104.1 104.7
 Zähler: 26 4 0 0 0 0 0 0 0 0
 Innenzehner: 22
 weiteste: 345 (12), 328 (9), 264 (4)
 beste Teiler 25.4 (15.) 46.3 (19.) 48.7 (18.)
 Trefferlage 0.42 mm rechts, 0.42 mm hoch
 Streuwert 1.16, horizontal: 1.05, vertikal: 1.25

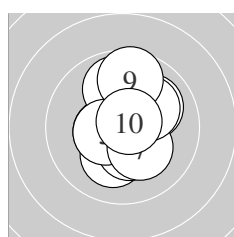
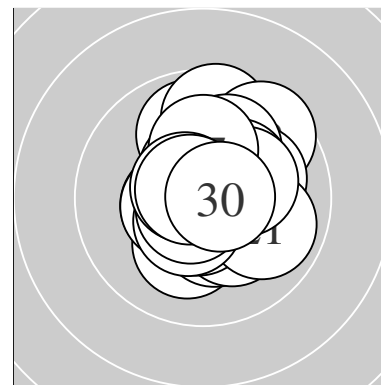

Serie 1:
 10.2 * 10.4 * 10.5 * 9.9 ↑ 10.5 *
 10.0 ↗ 10.2 * 10.1 ↗ 9.6 ↑ 10.7 *
 beste Teiler 58.7 (10.) 117.8 (3.) 118.9 (5.)
 Trefferlage 0.27 mm rechts, 0.36 mm hoch
 Streuwert 1.46, horizontal: 1.11, vertikal: 1.74

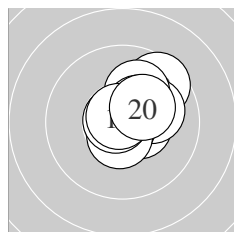

Serie 2:
 10.5 * 9.6 ↗ 10.1 ↗ 10.1 ↗ 10.9 *
 10.4 * 10.6 * 10.8 * 10.8 * 10.3 *
 beste Teiler 25.4 (15.) 46.3 (19.) 48.7 (18.)
 Trefferlage 0.80 mm rechts, 0.63 mm hoch
 Streuwert 1.02, horizontal: 0.98, vertikal: 1.05

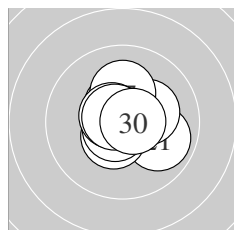

Serie 3:
 9.9 ↘ 10.5 * 10.5 * 10.7 * 10.2 *
 10.7 * 10.2 * 10.6 * 10.7 * 10.7 *
 beste Teiler 61.2 (26.) 63.8 (29.) 67.3 (24.)
 Trefferlage 0.19 mm rechts, 0.27 mm hoch
 Streuwert 1.00, horizontal: 1.07, vertikal: 0.93

Unterschrift des Schützen

Ergebnis: **314.5** (299)
 Serien: 105.3 103.8 105.4
 Zähler: 29 1 0 0 0 0 0 0 0 0
 Innenzehner: 27
 weiteste: 293 (16), 243 (13), 237 (4)
 beste Teiler 9.4 (19.) 47.6 (8.) 50.0 (26.)
 Trefferlage 0.11 mm rechts, 0.04 mm tief
 Streuwert 0.95, horizontal: 1.11, vertikal: 0.76

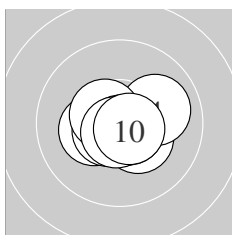
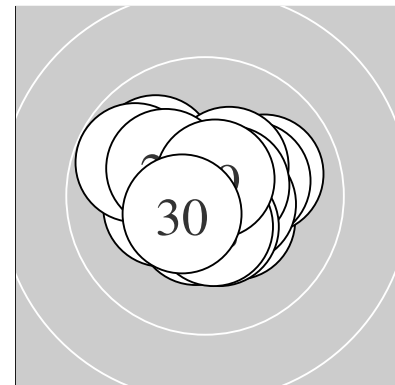

Serie 1:
 10.6 * 10.4 * 10.7 * 10.0 → 10.3 *
 10.6 * 10.5 * 10.8 * 10.7 * 10.7 *
 beste Teiler 47.6 (8.) 60.7 (9.) 68.5 (3.)
 Trefferlage 0.19 mm rechts, 0.26 mm tief
 Streuwert 0.87, horizontal: 1.12, vertikal: 0.53

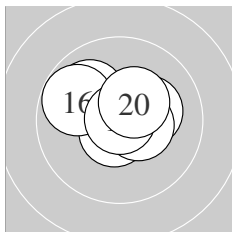

Serie 2:
 10.6 * 10.6 * 10.0 ↖ 10.4 * 10.4 *
 9.8 ↖ 10.2 * 10.5 * 10.9 * 10.4 *
 beste Teiler 9.4 (19.) 76.0 (11.) 77.3 (12.)
 Trefferlage 0.21 mm rechts, 0.40 mm hoch
 Streuwert 1.15, horizontal: 1.45, vertikal: 0.74

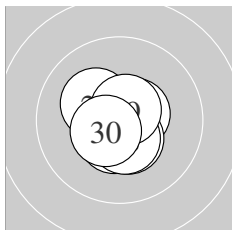

Serie 3:
 10.7 * 10.5 * 10.2 * 10.5 * 10.6 *
 10.8 * 10.4 * 10.5 * 10.7 * 10.5 *
 beste Teiler 50.0 (26.) 64.3 (21.) 74.4 (29.)
 Trefferlage 0.07 mm links, 0.27 mm tief
 Streuwert 0.79, horizontal: 0.74, vertikal: 0.83

Unterschrift des Schützen

Ergebnis: **310.1** (297)
 Serien: 102.9 103.6 103.6
 Zähler: 27 3 0 0 0 0 0 0 0 0
 Innenzehner: 24
 weiteste: 373 (11), 272 (4), 253 (10)
 beste Teiler 16.1 (16.) 61.3 (1.) 66.4 (25.)
 Trefferlage 0.08 mm links, 0.42 mm hoch
 Streuwert 1.18, horizontal: 1.39, vertikal: 0.93

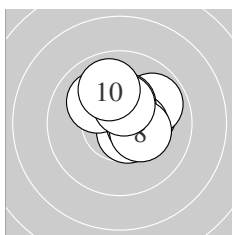
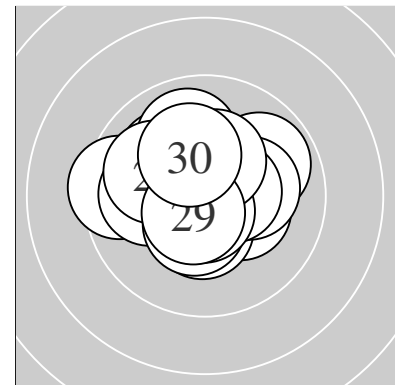

Serie 1:
 10.7 * 10.2 * 10.6 * 9.9 ↗ 10.1 ↘
 10.4 * 10.4 * 10.3 * 10.4 * 9.9 ↑
 beste Teiler 61.3 (1.) 87.1 (3.) 129.3 (6.)
 Trefferlage 0.64 mm rechts, 0.71 mm hoch
 Streuwert 1.12, horizontal: 1.19, vertikal: 1.05

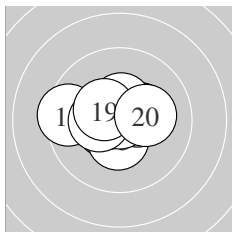

Serie 2:
 9.5 ← 10.5 * 10.4 * 10.4 * 10.4 *
 10.9 * 10.5 * 10.4 * 10.4 * 10.2 *
 beste Teiler 16.1 (16.) 104.2 (12.) 118.5 (17.)
 Trefferlage 0.26 mm links, 0.17 mm hoch
 Streuwert 1.27, horizontal: 1.66, vertikal: 0.70

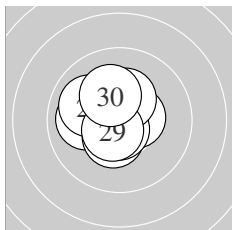

Serie 3:
 10.5 * 10.0 ← 10.4 * 10.4 * 10.7 *
 10.5 * 10.0 ↘ 10.3 * 10.6 * 10.2 *
 beste Teiler 66.4 (25.) 89.0 (29.) 102.6 (26.)
 Trefferlage 0.63 mm links, 0.37 mm hoch
 Streuwert 1.03, horizontal: 1.05, vertikal: 1.02

Unterschrift des Schützen

Ergebnis: **312.8** (299)
 Serien: 104.5 104.0 104.3
 Zähler: 29 1 0 0 0 0 0 0 0 0
 Innenzehner: 25
 weiteste: 324 (25), 235 (8), 231 (29)
 beste Teiler 9.2 (22.) 22.8 (21.) 42.4 (5.)
 Trefferlage 0.40 mm links, 0.43 mm hoch
 Streuwert 0.97, horizontal: 1.07, vertikal: 0.87

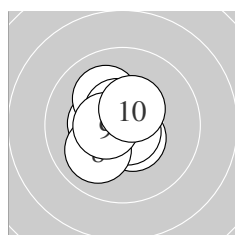
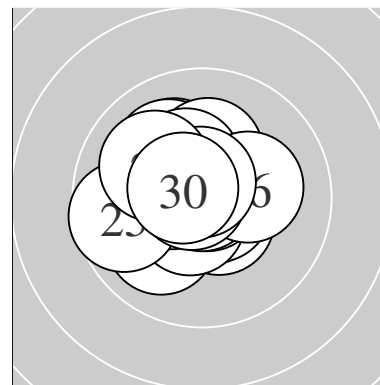

Serie 1:
 10.4 * 10.5 * 10.1 ↘ 10.5 * 10.8 *
 10.6 * 10.7 * 10.0 ↙ 10.5 * 10.4 *
 beste Teiler 42.4 (5.) 56.2 (7.) 96.9 (6.)
 Trefferlage 0.42 mm links, 0.15 mm hoch
 Streuwert 0.97, horizontal: 0.89, vertikal: 1.04

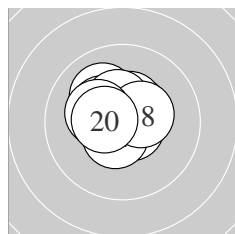

Serie 2:
 10.1 ↘ 10.5 * 10.7 * 10.5 * 10.3 *
 10.4 * 10.4 * 10.4 * 10.2 * 10.5 *
 beste Teiler 67.4 (13.) 101.5 (14.) 118.0 (12.)
 Trefferlage 0.32 mm links, 0.60 mm hoch
 Streuwert 0.93, horizontal: 1.05, vertikal: 0.79

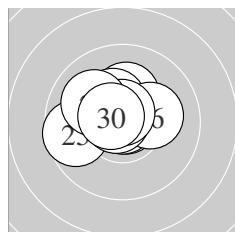

Serie 3:
 10.9 * 10.9 * 10.2 * 10.3 * 9.7 ←
 10.2 * 10.8 * 10.7 * 10.0 ↘ 10.6 *
 beste Teiler 9.2 (22.) 22.8 (21.) 44.2 (27.)
 Trefferlage 0.47 mm links, 0.55 mm hoch
 Streuwert 1.09, horizontal: 1.34, vertikal: 0.75

Unterschrift des Schützen

Ergebnis: **314.7** (299)
 Serien: 104.4 106.2 104.1
 Zähler: 29 1 0 0 0 0 0 0 0 0
 Innenzehner: 26
 weiteste: 270 (30), 226 (23), 214 (8)
 beste Teiler 8.0 (15.) 29.6 (17.) 31.5 (14.)
 Trefferlage 0.20 mm links, 0.07 mm tief
 Streuwert 0.91, horizontal: 1.03, vertikal: 0.77

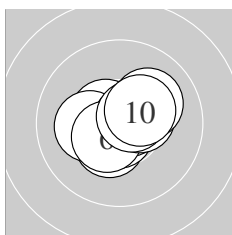
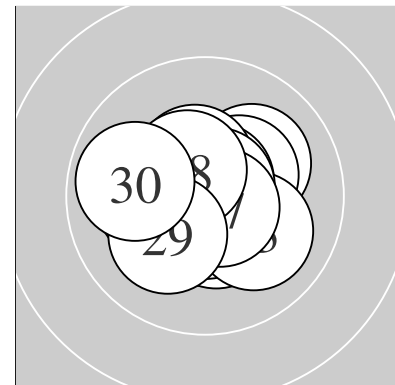

Serie 1:
 10.5 * 10.4 * 10.2 * 10.7 * 10.7 *
 10.5 * 10.4 * 10.1 ↗ 10.6 * 10.3 *
 beste Teiler 58.6 (5.) 60.8 (4.) 89.0 (9.)
 Trefferlage 0.13 mm rechts, 0.06 mm hoch
 Streuwert 0.99, horizontal: 1.17, vertikal: 0.76

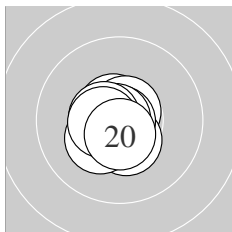

Serie 2:
 10.6 * 10.7 * 10.4 * 10.8 * 10.9 *
 10.3 * 10.8 * 10.6 * 10.5 * 10.6 *
 beste Teiler 8.0 (15.) 29.6 (17.) 31.5 (14.)
 Trefferlage 0.34 mm links, 0.21 mm tief
 Streuwert 0.62, horizontal: 0.57, vertikal: 0.67

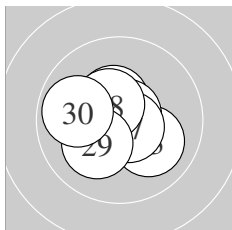

Serie 3:
 10.4 * 10.4 * 10.0 ↘ 10.8 * 10.6 *
 10.7 * 10.7 * 10.5 * 10.1 ↙ 9.9 ←
 beste Teiler 41.0 (24.) 51.7 (26.) 71.4 (27.)
 Trefferlage 0.40 mm links, 0.07 mm tief
 Streuwert 1.08, horizontal: 1.23, vertikal: 0.91

Unterschrift des Schützen

Ergebnis: **311.4** (297)
 Serien: 104.5 103.5 103.4
 Zähler: 27 3 0 0 0 0 0 0 0 0
 Innenzehner: 23
 weiteste: 460 (15), 274 (25), 263 (6)
 beste Teiler 26.6 (18.) 34.0 (3.) 48.0 (5.)
 Trefferlage 0.31 mm rechts, 0.31 mm hoch
 Streuwert 1.17, horizontal: 1.24, vertikal: 1.10

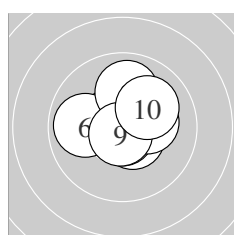
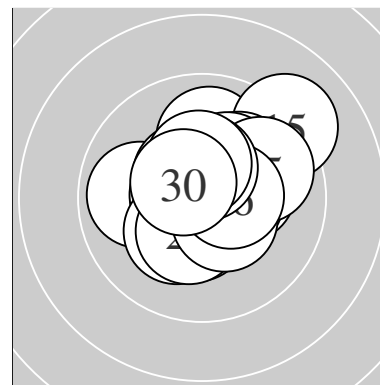

Serie 1:
 10.5 * 10.8 * 10.8 * 10.6 * 10.8 *
 9.9 ← 10.2 * 10.0 ↑ 10.8 * 10.1 ↗
 beste Teiler 34.0 (3.) 48.0 (5.) 49.9 (2.)
 Trefferlage 0.02 mm rechts, 0.34 mm hoch
 Streuwert 1.12, horizontal: 1.26, vertikal: 0.96

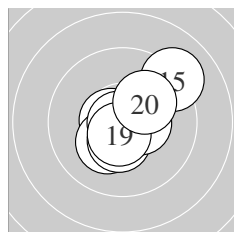

Serie 2:
 10.6 * 10.5 * 10.2 * 10.4 * 9.1 ↗
 10.7 * 10.5 * 10.8 * 10.6 * 10.1 ↗
 beste Teiler 26.6 (18.) 61.9 (16.) 83.0 (11.)
 Trefferlage 0.36 mm rechts, 0.01 mm hoch
 Streuwert 1.37, horizontal: 1.40, vertikal: 1.34

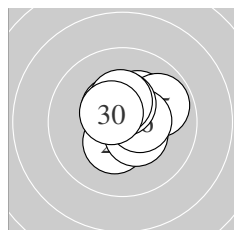

Serie 3:
 10.4 * 10.1 ↗ 10.4 * 10.3 * 9.9 ↗
 10.5 * 10.4 * 10.5 * 10.4 * 10.5 *
 beste Teiler 102.9 (30.) 116.8 (28.) 122.4 (26.)
 Trefferlage 0.54 mm rechts, 0.58 mm hoch
 Streuwert 1.07, horizontal: 1.13, vertikal: 1.00

Unterschrift des Schützen

Ergebnis: **313.9** (299)
 Serien: 105.8 103.4 104.7
 Zähler: 29 1 0 0 0 0 0 0 0 0
 Innenzehner: 28
 weiteste: 252 (11), 241 (13), 197 (15)
 beste Teiler 11.6 (9.) 17.0 (29.) 28.4 (27.)
 Trefferlage 0.05 mm rechts, 0.05 mm hoch
 Streuwert 0.97, horizontal: 1.08, vertikal: 0.85

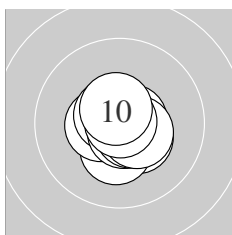
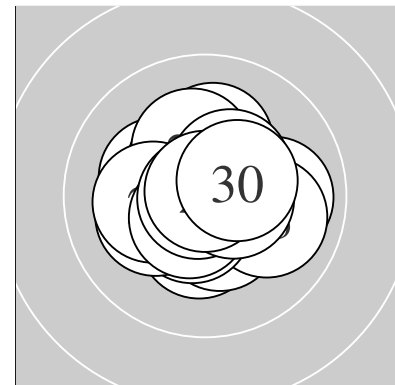

Serie 1:
 10.4 * 10.3 * 10.5 * 10.6 * 10.7 *
 10.6 * 10.7 * 10.5 * 10.9 * 10.6 *
 beste Teiler 11.6 (9.) 60.4 (5.) 71.8 (7.)
 Trefferlage 0.16 mm rechts, 0.25 mm tief
 Streuwert 0.72, horizontal: 0.74, vertikal: 0.71

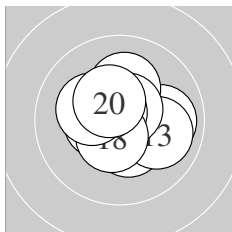

Serie 2:
 9.9 → 10.4 * 10.0 → 10.5 * 10.2 *
 10.6 * 10.7 * 10.5 * 10.2 * 10.4 *
 beste Teiler 71.5 (17.) 80.4 (16.) 110.0 (18.)
 Trefferlage 0.15 mm rechts, 0.17 mm hoch
 Streuwert 1.21, horizontal: 1.38, vertikal: 1.01

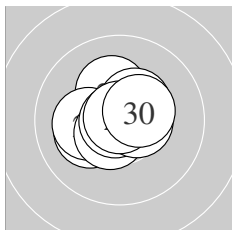

Serie 3:
 10.5 * 10.2 * 10.2 * 10.2 * 10.4 *
 10.6 * 10.8 * 10.5 * 10.9 * 10.4 *
 beste Teiler 17.0 (29.) 28.4 (27.) 99.6 (26.)
 Trefferlage 0.15 mm links, 0.24 mm hoch
 Streuwert 0.97, horizontal: 1.11, vertikal: 0.80

Unterschrift des Schützen

Ergebnis: **312.2** (299)
 Serien: 103.5 104.4 104.3
 Zähler: 29 1 0 0 0 0 0 0 0 0
 Innenzehner: 25
 weiteste: 271 (4), 240 (3), 234 (12)
 beste Teiler 43.2 (2.) 44.9 (30.) 51.3 (28.)
 Trefferlage 0.47 mm links, 0.09 mm hoch
 Streuwert 1.03, horizontal: 1.06, vertikal: 0.99

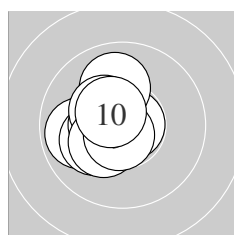
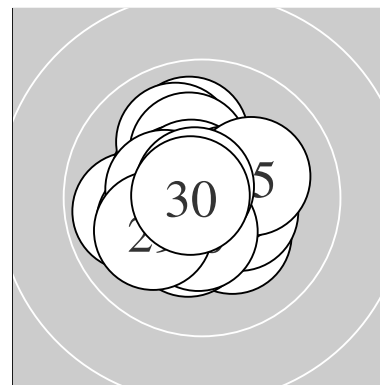

Serie 1:
 10.2 * 10.8 * 10.0 ↑ 9.9 ← 10.2 *
 10.5 * 10.4 * 10.3 * 10.7 * 10.5 *
 beste Teiler 43.2 (2.) 66.1 (9.) 111.8 (10.)
 Trefferlage 1.09 mm links, 0.09 mm hoch
 Streuwert 0.97, horizontal: 0.89, vertikal: 1.03

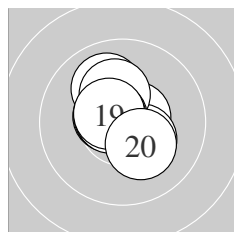

Serie 2:
 10.6 * 10.0 ↑ 10.3 * 10.2 * 10.6 *
 10.6 * 10.7 * 10.6 * 10.6 * 10.2 *
 beste Teiler 74.3 (17.) 80.0 (18.) 85.7 (11.)
 Trefferlage 0.24 mm links, 0.35 mm hoch
 Streuwert 0.99, horizontal: 0.90, vertikal: 1.07

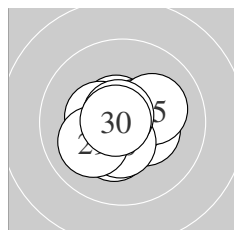

Serie 3:
 10.6 * 10.4 * 10.5 * 10.3 * 10.1 →
 10.4 * 10.4 * 10.7 * 10.1 ← 10.8 *
 beste Teiler 44.9 (30.) 51.3 (28.) 82.8 (21.)
 Trefferlage 0.08 mm links, 0.16 mm tief
 Streuwert 1.04, horizontal: 1.18, vertikal: 0.89

Unterschrift des Schützen

Ergebnis: **308.8** (296)
 Serien: 104.0 103.0 101.8
 Zähler: 26 4 0 0 0 0 0 0 0 0
 Innenzehner: 20
 weiteste: 425 (28), 311 (14), 290 (22)
 beste Teiler 45.7 (2.) 50.4 (1.) 66.9 (5.)
 Trefferlage 0.34 mm links, 1.02 mm hoch
 Streuwert 1.09, horizontal: 1.30, vertikal: 0.84

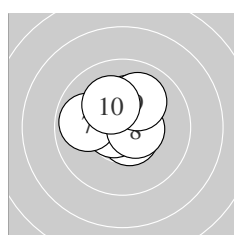
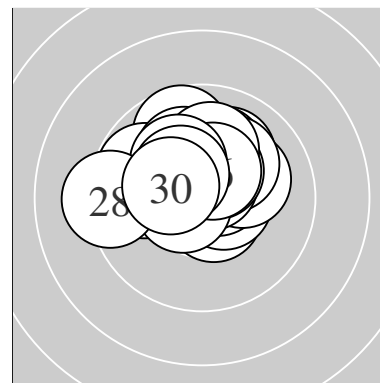

Serie 1:
 10.8 * 10.8 * 10.3 * 10.6 * 10.7 *
 10.2 * 9.9 ← 10.5 * 10.0 ↗ 10.2 *
 beste Teiler 45.7 (2.) 50.4 (1.) 66.9 (5.)
 Trefferlage 0.18 mm links, 0.72 mm hoch
 Streuwert 1.04, horizontal: 1.12, vertikal: 0.96

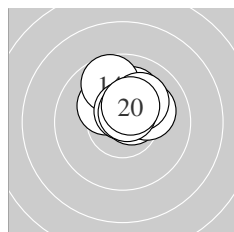

Serie 2:
 10.6 * 10.2 * 10.1 ↗ 9.7 ↗ 10.6 *
 10.1 ↗ 10.6 * 10.1 ↗ 10.6 * 10.4 *
 beste Teiler 83.1 (19.) 85.4 (15.) 86.0 (17.)
 Trefferlage 0.32 mm rechts, 1.30 mm hoch
 Streuwert 0.85, horizontal: 0.96, vertikal: 0.73

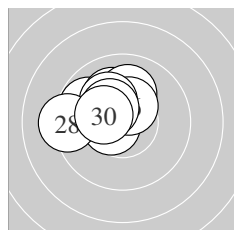

Serie 3:
 10.6 * 9.8 ↖ 10.1 ↗ 10.6 * 10.1 ↗
 10.4 * 10.2 * 9.3 ← 10.4 * 10.3 *
 beste Teiler 92.6 (24.) 98.3 (21.) 133.3 (26.)
 Trefferlage 1.15 mm links, 1.04 mm hoch
 Streuwert 1.15, horizontal: 1.41, vertikal: 0.80

Unterschrift des Schützen

Ergebnis: **314.6** (300)
 Serien: 105.4 104.1 105.1
 Zähler: 30 0 0 0 0 0 0 0 0 0
 Innenzehner: 27
 weiteste: 239 (14), 236 (21), 232 (1)
 beste Teiler 11.1 (9.) 52.1 (16.) 52.7 (25.)
 Trefferlage 0.08 mm links, 0.13 mm hoch
 Streuwert 0.93, horizontal: 0.99, vertikal: 0.86

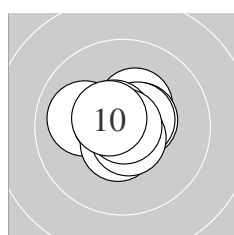
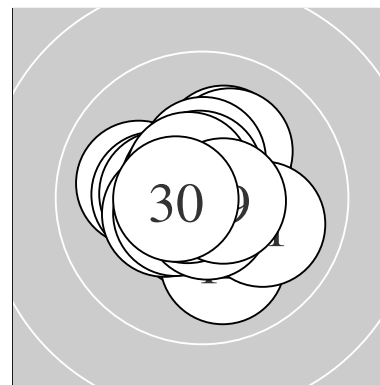

Serie 1:
 10.0 ← 10.6 * 10.4 * 10.5 * 10.5 *
 10.6 * 10.7 * 10.6 * 10.9 * 10.6 *
 beste Teiler 11.1 (9.) 74.7 (7.) 77.1 (8.)
 Trefferlage 0.15 mm links, 0.26 mm hoch
 Streuwert 0.84, horizontal: 1.00, vertikal: 0.65

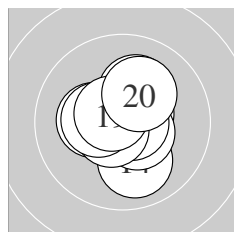

Serie 2:
 10.3 * 10.6 * 10.2 * 10.0 ↓ 10.5 *
 10.7 * 10.6 * 10.4 * 10.6 * 10.2 *
 beste Teiler 52.1 (16.) 80.7 (17.) 83.4 (19.)
 Trefferlage 0.02 mm rechts, 0.13 mm hoch
 Streuwert 1.10, horizontal: 1.04, vertikal: 1.16

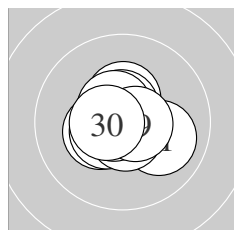

Serie 3:
 10.0 → 10.4 * 10.5 * 10.7 * 10.7 *
 10.4 * 10.6 * 10.6 * 10.6 * 10.6 *
 beste Teiler 52.7 (25.) 70.3 (24.) 76.7 (29.)
 Trefferlage 0.11 mm links, 0.00 mm
 Streuwert 0.90, horizontal: 1.01, vertikal: 0.77

Unterschrift des Schützen

Ergebnis: **315.6** (300)
 Serien: 105.4 105.1 105.1
 Zähler: 30 0 0 0 0 0 0 0 0 0
 Innenzehner: 29
 weiteste: 212 (17), 197 (12), 192 (21)
 beste Teiler 4.1 (9.) 31.5 (24.) 37.0 (13.)
 Trefferlage 0.06 mm links, 0.07 mm hoch
 Streuwert 0.88, horizontal: 0.99, vertikal: 0.77

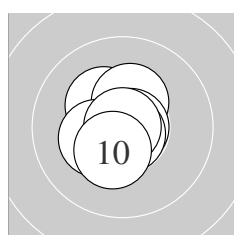
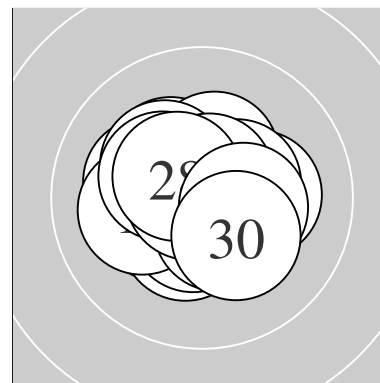

Serie 1:
 10.7 * 10.5 * 10.4 * 10.3 * 10.3 *
 10.8 * 10.3 * 10.8 * 10.9 * 10.4 *
 beste Teiler 4.1 (9.) 44.0 (6.) 46.6 (8.)
 Trefferlage 0.29 mm links, 0.20 mm hoch
 Streuwert 0.83, horizontal: 0.68, vertikal: 0.96

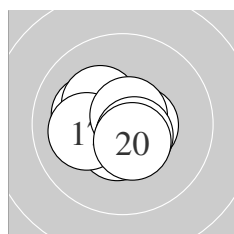

Serie 2:
 10.8 * 10.2 * 10.8 * 10.5 * 10.6 *
 10.3 * 10.1 ← 10.7 * 10.6 * 10.5 *
 beste Teiler 37.0 (13.) 39.0 (11.) 61.0 (18.)
 Trefferlage 0.26 mm links, 0.13 mm tief
 Streuwert 0.93, horizontal: 1.11, vertikal: 0.71

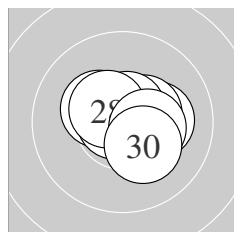

Serie 3:
 10.2 * 10.8 * 10.4 * 10.8 * 10.7 *
 10.3 * 10.8 * 10.5 * 10.4 * 10.2 *
 beste Teiler 31.5 (24.) 42.9 (27.) 43.0 (22.)
 Trefferlage 0.36 mm rechts, 0.17 mm hoch
 Streuwert 0.88, horizontal: 1.07, vertikal: 0.63

Unterschrift des Schützen

Ergebnis: **311.2** (298)
 Serien: 103.3 105.0 102.9
 Zähler: 28 2 0 0 0 0 0 0 0 0
 Innenzehner: 25
 weiteste: 351 (3), 274 (24), 237 (11)
 beste Teiler 21.0 (12.) 29.0 (26.) 65.2 (14.)
 Trefferlage 0.12 mm links, 0.03 mm hoch
 Streuwert 1.14, horizontal: 1.00, vertikal: 1.27

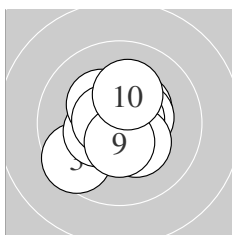
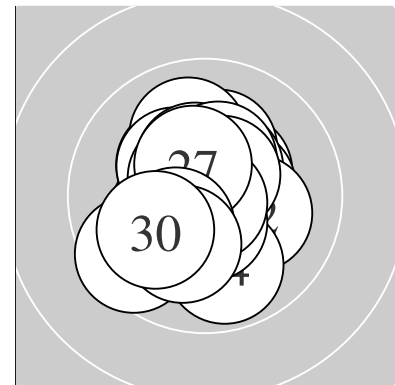

Serie 1:
 10.4 * 10.4 * 9.5 ↙ 10.7 * 10.3 *
 10.4 * 10.3 * 10.6 * 10.5 * 10.2 *
 beste Teiler 66.4 (4.) 83.6 (8.) 120.0 (9.)
 Trefferlage 0.15 mm links, 0.04 mm tief
 Streuwert 1.28, horizontal: 1.31, vertikal: 1.24

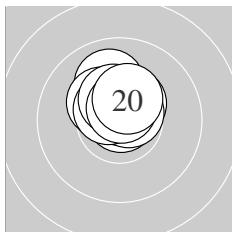

Serie 2:
 10.0 ↑ 10.9 * 10.3 * 10.7 * 10.4 *
 10.7 * 10.6 * 10.4 * 10.6 * 10.4 *
 beste Teiler 21.0 (12.) 65.2 (14.) 75.9 (16.)
 Trefferlage 0.09 mm links, 0.99 mm hoch
 Streuwert 0.60, horizontal: 0.62, vertikal: 0.58

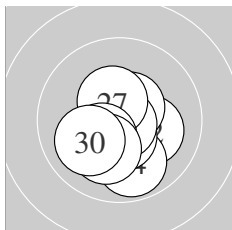

Serie 3:
 10.2 * 10.2 * 10.5 * 9.9 ↓ 10.5 *
 10.8 * 10.4 * 10.3 * 10.1 ↓ 10.0 ↙
 beste Teiler 29.0 (26.) 101.8 (25.) 103.4 (23.)
 Trefferlage 0.12 mm links, 0.85 mm tief
 Streuwert 1.13, horizontal: 1.07, vertikal: 1.19

Unterschrift des Schützen

Ergebnis: **314.0** (300)
 Serien: 105.5 103.4 105.1
 Zähler: 30 0 0 0 0 0 0 0 0 0
 Innenzehner: 26
 weiteste: 246 (25), 235 (11), 223 (18)
 beste Teiler 53.8 (23.) 56.7 (2.) 58.1 (26.)
 Trefferlage 0.11 mm rechts, 0.47 mm hoch
 Streuwert 0.89, horizontal: 0.75, vertikal: 1.02

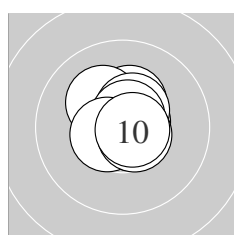
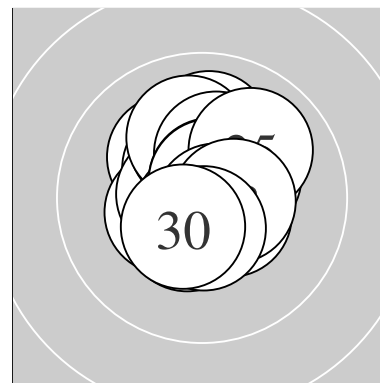

Serie 1:
 10.6 * 10.7 * 10.7 * 10.3 * 10.2 *
 10.5 * 10.7 * 10.5 * 10.6 * 10.7 *
 beste Teiler 56.7 (2.) 61.1 (10.) 67.5 (7.)
 Trefferlage 0.16 mm rechts, 0.43 mm hoch
 Streuwert 0.72, horizontal: 0.67, vertikal: 0.77

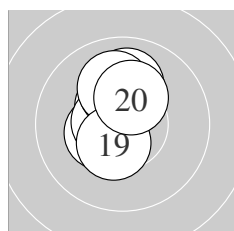

Serie 2:
 10.0 † 10.6 * 10.4 * 10.5 * 10.6 *
 10.1 † 10.3 * 10.1 † 10.5 * 10.3 *
 beste Teiler 79.3 (12.) 87.1 (15.) 124.6 (14.)
 Trefferlage 0.37 mm links, 0.97 mm hoch
 Streuwert 0.93, horizontal: 0.57, vertikal: 1.18

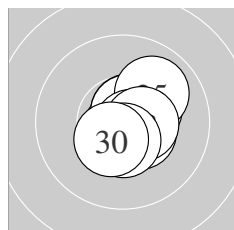

Serie 3:
 10.7 * 10.3 * 10.7 * 10.7 * 10.0 ↗
 10.7 * 10.5 * 10.5 * 10.5 * 10.5 *
 beste Teiler 53.8 (23.) 58.1 (26.) 68.8 (24.)
 Trefferlage 0.55 mm rechts, 0.01 mm hoch
 Streuwert 0.83, horizontal: 0.75, vertikal: 0.91

Unterschrift des Schützen

Ergebnis: **311.2** (298)
 Serien: 103.3 104.8 103.1
 Zähler: 28 2 0 0 0 0 0 0 0 0
 Innenzehner: 26
 weiteste: 323 (1), 303 (25), 248 (5)
 beste Teiler 42.0 (18.) 51.4 (11.) 52.4 (2.)
 Trefferlage 0.27 mm rechts, 0.14 mm tief
 Streuwert 1.14, horizontal: 1.29, vertikal: 0.96

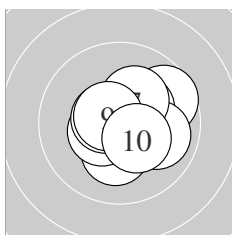
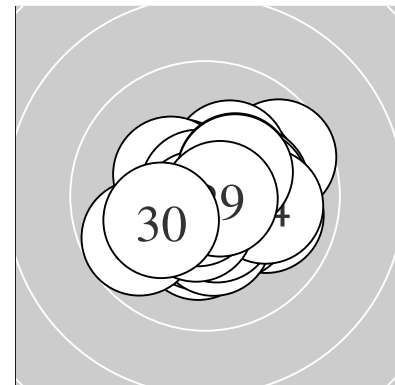

Serie 1:
 9.7 ↗ 10.7 * 10.3 * 10.2 * 10.0 →
 10.5 * 10.3 * 10.6 * 10.6 * 10.4 *
 beste Teiler 52.4 (2.) 86.6 (9.) 96.7 (8.)
 Trefferlage 0.52 mm rechts, 0.10 mm hoch
 Streuwert 1.26, horizontal: 1.40, vertikal: 1.09

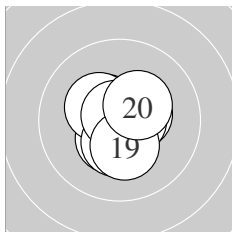

Serie 2:
 10.7 * 10.4 * 10.5 * 10.5 * 10.3 *
 10.4 * 10.6 * 10.8 * 10.3 * 10.3 *
 beste Teiler 42.0 (18.) 51.4 (11.) 81.0 (17.)
 Trefferlage 0.01 mm links, 0.14 mm tief
 Streuwert 0.92, horizontal: 0.87, vertikal: 0.97

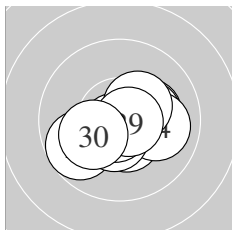

Serie 3:
 10.2 * 10.2 * 10.5 * 10.0 → 9.7 ↙
 10.5 * 10.7 * 10.4 * 10.7 * 10.2 *
 beste Teiler 56.9 (27.) 59.0 (29.) 114.4 (26.)
 Trefferlage 0.31 mm rechts, 0.40 mm tief
 Streuwert 1.25, horizontal: 1.58, vertikal: 0.81

Unterschrift des Schützen

Ergebnis: **314.4** (299)
 Serien: 105.6 103.8 105.0
 Zähler: 29 1 0 0 0 0 0 0 0 0
 Innenzehner: 27
 weiteste: 273 (23), 247 (20), 243 (13)
 beste Teiler 27.6 (2.) 32.2 (12.) 34.6 (30.)
 Trefferlage 0.30 mm links, 0.05 mm tief
 Streuwert 0.94, horizontal: 1.12, vertikal: 0.73

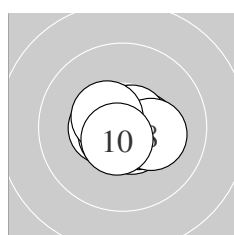
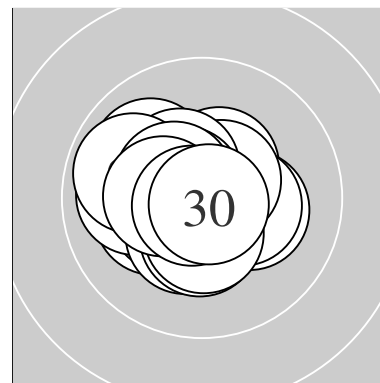

Serie 1:
 10.6 * 10.8 * 10.5 * 10.5 * 10.5 *
 10.7 * 10.7 * 10.2 * 10.5 * 10.6 *
 beste Teiler 27.6 (2.) 67.6 (6.) 68.8 (7.)
 Trefferlage 0.23 mm rechts, 0.19 mm tief
 Streuwert 0.75, horizontal: 0.96, vertikal: 0.45

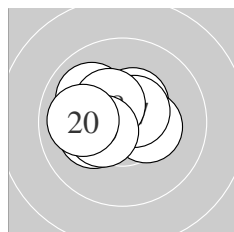

Serie 2:
 10.7 * 10.8 * 10.0 ↖ 10.2 * 10.4 *
 10.3 * 10.6 * 10.4 * 10.4 * 10.0 ←
 beste Teiler 32.2 (12.) 69.6 (11.) 97.6 (17.)
 Trefferlage 0.44 mm links, 0.32 mm hoch
 Streuwert 1.10, horizontal: 1.37, vertikal: 0.74

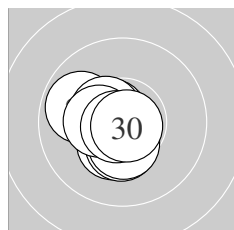

Serie 3:
 10.6 * 10.8 * 9.9 ↖ 10.4 * 10.5 *
 10.4 * 10.4 * 10.4 * 10.8 * 10.8 *
 beste Teiler 34.6 (30.) 47.8 (29.) 50.3 (22.)
 Trefferlage 0.69 mm links, 0.29 mm tief
 Streuwert 0.84, horizontal: 0.84, vertikal: 0.85

Unterschrift des Schützen

Ergebnis: **309.2** (298)
 Serien: 103.7 102.5 103.0
 Zähler: 28 2 0 0 0 0 0 0 0 0
 Innenzehner: 20
 weiteste: 287 (29), 285 (12), 227 (1)
 beste Teiler 43.3 (23.) 51.6 (7.) 54.6 (6.)
 Trefferlage 0.06 mm rechts, 0.13 mm tief
 Streuwert 1.23, horizontal: 1.17, vertikal: 1.30

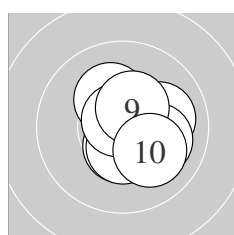
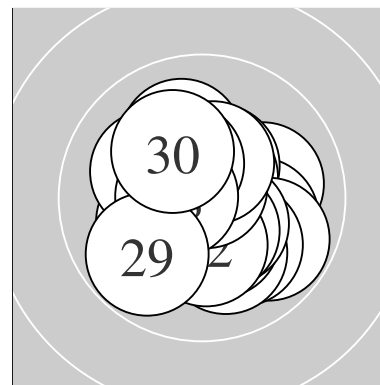

Serie 1:
 10.0 → 10.5 * 10.5 * 10.2 * 10.5 *
 10.7 * 10.7 * 10.1 ↘ 10.4 * 10.1 ↘
 beste Teiler 51.6 (7.) 54.6 (6.) 104.7 (2.)
 Trefferlage 0.58 mm rechts, 0.07 mm hoch
 Streuwert 1.07, horizontal: 1.03, vertikal: 1.12

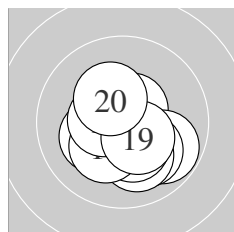

Serie 2:
 10.6 * 9.8 ↘ 10.1 ↘ 10.2 * 10.1 ↘
 10.3 * 10.2 * 10.5 * 10.4 * 10.3 *
 beste Teiler 91.8 (11.) 112.8 (18.) 132.2 (19.)
 Trefferlage 0.22 mm rechts, 0.76 mm tief
 Streuwert 1.23, horizontal: 1.30, vertikal: 1.15

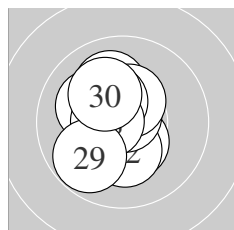

Serie 3:
 10.4 * 10.3 * 10.8 * 10.1 ↘ 10.1 ↗
 10.4 * 10.4 * 10.6 * 9.8 ↗ 10.1 ↘
 beste Teiler 43.3 (23.) 93.1 (28.) 133.7 (21.)
 Trefferlage 0.60 mm links, 0.28 mm hoch
 Streuwert 1.22, horizontal: 0.91, vertikal: 1.47

Unterschrift des Schützen

Ergebnis: **313.3** (299)
 Serien: 105.6 104.3 103.4
 Zähler: 29 1 0 0 0 0 0 0 0 0
 Innenzehner: 26
 weiteste: 304 (25), 221 (13), 212 (4)
 beste Teiler 22.0 (8.) 45.8 (22.) 46.1 (11.)
 Trefferlage 0.36 mm rechts, 0.14 mm hoch
 Streuwert 0.99, horizontal: 1.07, vertikal: 0.89

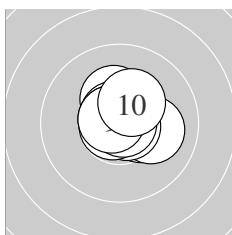
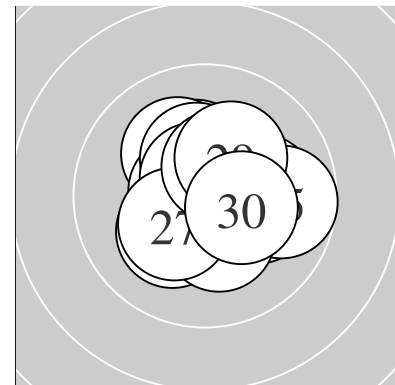

Serie 1:
 10.4 * 10.3 * 10.7 * 10.1 → 10.7 *
 10.7 * 10.8 * 10.9 * 10.7 * 10.3 *
 beste Teiler 22.0 (8.) 48.8 (7.) 53.2 (5.)
 Trefferlage 0.27 mm rechts, 0.27 mm hoch
 Streuwert 0.81, horizontal: 0.91, vertikal: 0.71

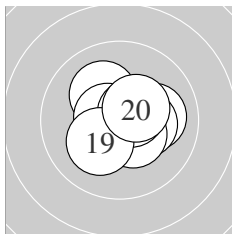

Serie 2:
 10.8 * 10.8 * 10.1 → 10.3 * 10.1 ↖
 10.6 * 10.4 * 10.6 * 10.2 * 10.4 *
 beste Teiler 46.1 (11.) 46.6 (12.) 83.4 (16.)
 Trefferlage 0.31 mm rechts, 0.09 mm hoch
 Streuwert 1.04, horizontal: 1.19, vertikal: 0.88

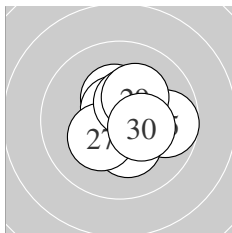

Serie 3:
 10.3 * 10.8 * 10.6 * 10.5 * 9.7 →
 10.3 * 10.3 * 10.4 * 10.2 * 10.3 *
 beste Teiler 45.8 (22.) 77.8 (23.) 122.9 (24.)
 Trefferlage 0.50 mm rechts, 0.07 mm hoch
 Streuwert 1.16, horizontal: 1.20, vertikal: 1.12

Unterschrift des Schützen

Ergebnis: **310.3** (296)
 Serien: 103.0 103.2 104.1
 Zähler: 26 4 0 0 0 0 0 0 0 0
 Innenzehner: 23
 weiteste: 456 (15), 288 (18), 264 (8)
 beste Teiler 20.8 (11.) 62.2 (20.) 62.6 (19.)
 Trefferlage 0.26 mm links, 0.11 mm hoch
 Streuwert 1.24, horizontal: 1.43, vertikal: 1.01

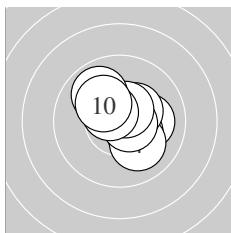
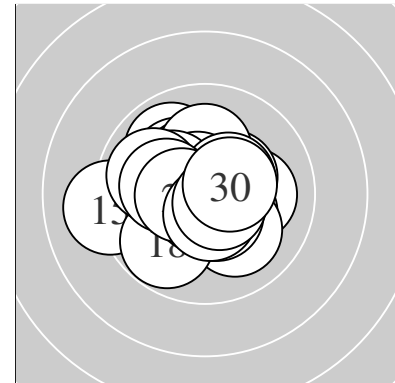

Serie 1:
 10.3 * 10.1 → 10.4 * 10.1 ↘ 10.4 *
 10.6 * 10.5 * 9.9 ↙ 10.5 * 10.2 *
 beste Teiler 79.3 (6.) 102.5 (9.) 103.3 (7.)
 Trefferlage 0.53 mm rechts, 0.32 mm hoch
 Streuwert 1.21, horizontal: 1.30, vertikal: 1.11

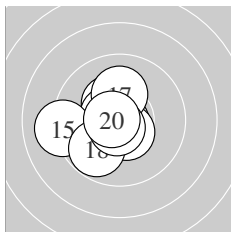

Serie 2:
 10.9 * 10.3 * 10.5 * 10.6 * 9.1 ←
 10.5 * 10.1 ↑ 9.8 ↙ 10.7 * 10.7 *
 beste Teiler 20.8 (11.) 62.2 (20.) 62.6 (19.)
 Trefferlage 0.90 mm links, 0.16 mm tief
 Streuwert 1.33, horizontal: 1.43, vertikal: 1.22

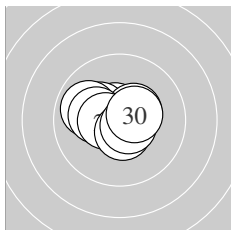

Serie 3:
 10.6 * 10.2 * 10.7 * 9.9 ↘ 10.4 *
 10.2 * 10.5 * 10.6 * 10.6 * 10.4 *
 beste Teiler 64.0 (23.) 80.4 (21.) 81.3 (29.)
 Trefferlage 0.41 mm links, 0.18 mm hoch
 Streuwert 1.02, horizontal: 1.28, vertikal: 0.66

Unterschrift des Schützen

Ergebnis: **315.5** (298)
 Serien: 105.5 104.7 105.3
 Zähler: 28 2 0 0 0 0 0 0 0 0
 Innenzehner: 28
 weiteste: 304 (19), 291 (1), 164 (27)
 beste Teiler 28.0 (10.) 40.0 (13.) 45.1 (7.)
 Trefferlage 0.28 mm links, 0.05 mm hoch
 Streuwert 0.88, horizontal: 0.90, vertikal: 0.86

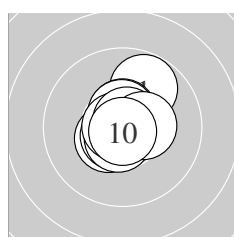
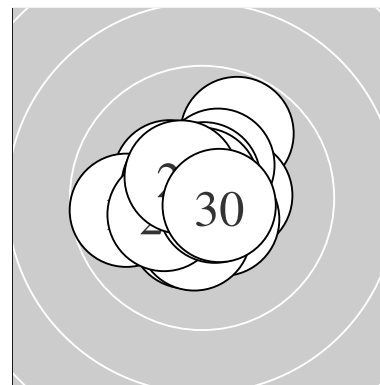

Serie 1:
 9.8 ↗ 10.6 * 10.5 * 10.6 * 10.6 *
 10.6 * 10.8 * 10.8 * 10.4 * 10.8 *
 beste Teiler 28.0 (10.) 45.1 (7.) 49.0 (8.)
 Trefferlage 0.07 mm rechts, 0.26 mm hoch
 Streuwert 0.90, horizontal: 0.76, vertikal: 1.01

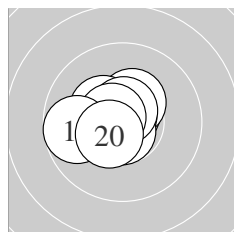

Serie 2:
 10.7 * 10.4 * 10.8 * 10.3 * 10.7 *
 10.4 * 10.6 * 10.6 * 9.7 ← 10.5 *
 beste Teiler 40.0 (13.) 58.2 (15.) 63.1 (11.)
 Trefferlage 0.62 mm links, 0.19 mm hoch
 Streuwert 0.91, horizontal: 1.07, vertikal: 0.71

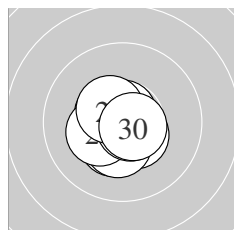

Serie 3:
 10.4 * 10.7 * 10.5 * 10.5 * 10.4 *
 10.6 * 10.3 * 10.7 * 10.5 * 10.7 *
 beste Teiler 54.0 (22.) 60.7 (28.) 74.3 (30.)
 Trefferlage 0.30 mm links, 0.27 mm tief
 Streuwert 0.79, horizontal: 0.79, vertikal: 0.80

Unterschrift des Schützen

Ergebnis: **307.8** (296)
 Serien: 103.7 102.3 101.8
 Zähler: 26 4 0 0 0 0 0 0 0 0
 Innenzehner: 16
 weiteste: 338 (27), 267 (6), 256 (14)
 beste Teiler 60.1 (11.) 71.2 (1.) 76.4 (22.)
 Trefferlage 0.08 mm links, 0.22 mm tief
 Streuwert 1.32, horizontal: 1.33, vertikal: 1.31

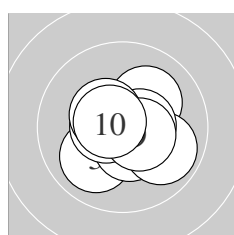
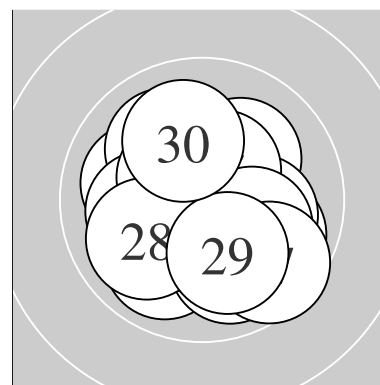

Serie 1:
 10.7 * 10.1 ↗ 10.0 ↙ 10.5 * 10.5 *
 9.9 ↘ 10.5 * 10.4 * 10.5 * 10.6 *
 beste Teiler 71.2 (1.) 86.0 (10.) 101.0 (5.)
 Trefferlage 0.12 mm rechts, 0.22 mm tief
 Streuwert 1.16, horizontal: 1.31, vertikal: 0.99

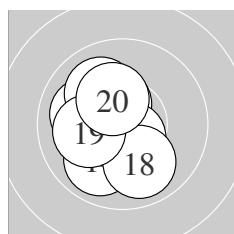

Serie 2:
 10.7 * 10.0 ← 10.4 * 9.9 ↙ 10.4 *
 10.0 ↘ 10.6 * 9.9 ↓ 10.1 ← 10.3 *
 beste Teiler 60.1 (11.) 94.8 (17.) 131.3 (15.)
 Trefferlage 0.77 mm links, 0.07 mm hoch
 Streuwert 1.29, horizontal: 1.02, vertikal: 1.50

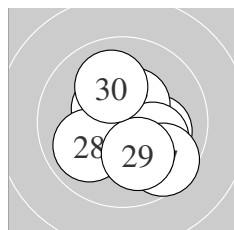

Serie 3:
 10.5 * 10.6 * 10.4 * 10.1 → 10.4 *
 10.1 ↘ 9.6 ↘ 10.0 ↙ 10.1 ↓ 10.0 ↑
 beste Teiler 76.4 (22.) 123.1 (21.) 127.0 (25.)
 Trefferlage 0.40 mm rechts, 0.51 mm tief
 Streuwert 1.45, horizontal: 1.45, vertikal: 1.44

Unterschrift des Schützen

Meyton Elektronik

Ergebnis: **309.6** (294)
 Serien: 103.3 103.2 103.1
 Zähler: 24 6 0 0 0 0 0 0 0 0
 Innenzehner: 20
 weiteste: 296 (16), 284 (12), 265 (24)
 beste Teiler 39.0 (5.) 45.3 (9.) 46.6 (17.)
 Trefferlage 0.03 mm links, 0.18 mm tief
 Streuwert 1.27, horizontal: 1.33, vertikal: 1.20

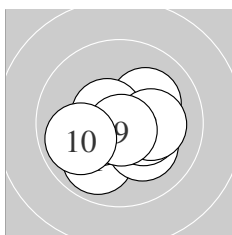
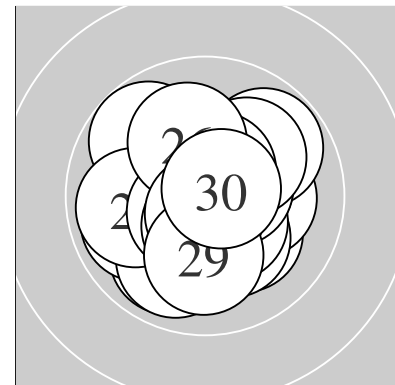

Serie 1:
 9.9 ↙ 10.2 * 10.3 * 10.1 ↗ 10.8 *
 10.5 * 10.6 * 10.2 * 10.8 * 9.9 ←
 beste Teiler 39.0 (5.) 45.3 (9.) 95.4 (7.)
 Trefferlage 0.10 mm rechts, 0.45 mm tief
 Streuwert 1.26, horizontal: 1.51, vertikal: 0.96

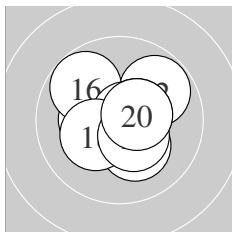

Serie 2:
 10.6 * 9.8 ↗ 10.3 * 10.2 * 10.5 *
 9.8 ↘ 10.8 * 10.3 * 10.4 * 10.5 *
 beste Teiler 46.6 (17.) 90.1 (11.) 112.8 (15.)
 Trefferlage 0.06 mm rechts, 0.18 mm hoch
 Streuwert 1.31, horizontal: 1.45, vertikal: 1.16

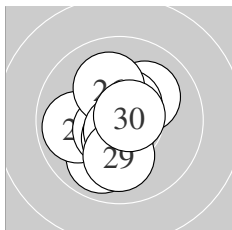

Serie 3:
 9.9 ↙ 10.1 ↗ 10.5 * 9.9 ← 10.6 *
 10.1 ↖ 10.5 * 10.7 * 10.1 ↓ 10.7 *
 beste Teiler 66.7 (30.) 67.0 (28.) 92.8 (25.)
 Trefferlage 0.27 mm links, 0.27 mm tief
 Streuwert 1.30, horizontal: 1.12, vertikal: 1.46

Unterschrift des Schützen

Ergebnis: **311.6** (299)
 Serien: 103.9 104.2 103.5
 Zähler: 29 1 0 0 0 0 0 0 0 0
 Innenzehner: 25
 weiteste: 267 (25), 249 (13), 243 (22)
 beste Teiler 23.0 (15.) 32.0 (30.) 45.1 (26.)
 Trefferlage 0.16 mm links, 0.16 mm hoch
 Streuwert 1.11, horizontal: 1.30, vertikal: 0.88

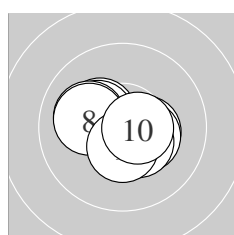
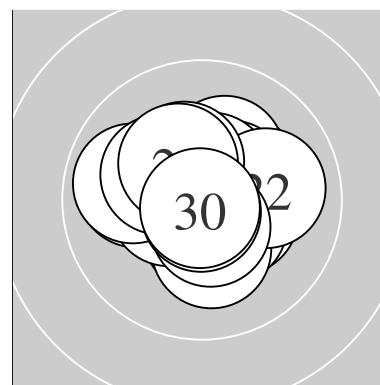

Serie 1:
 10.3 * 10.4 * 10.3 * 10.4 * 10.1 ←
 10.8 * 10.4 * 10.1 ← 10.5 * 10.6 *
 beste Teiler 49.4 (6.) 94.1 (10.) 121.0 (9.)
 Trefferlage 0.24 mm links, 0.08 mm tief
 Streuwert 1.12, horizontal: 1.42, vertikal: 0.72

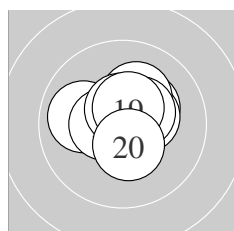

Serie 2:
 10.3 * 10.4 * 10.0 ← 10.2 * 10.9 *
 10.4 * 10.5 * 10.6 * 10.5 * 10.4 *
 beste Teiler 23.0 (15.) 95.0 (18.) 108.7 (19.)
 Trefferlage 0.16 mm rechts, 0.47 mm hoch
 Streuwert 1.02, horizontal: 1.19, vertikal: 0.83

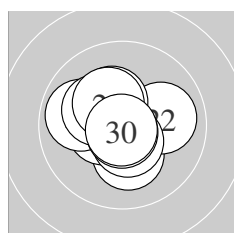

Serie 3:
 10.2 * 10.0 → 10.5 * 10.5 * 9.9 ←
 10.8 * 10.2 * 10.3 * 10.3 * 10.8 *
 beste Teiler 32.0 (30.) 45.1 (26.) 105.9 (24.)
 Trefferlage 0.40 mm links, 0.09 mm hoch
 Streuwert 1.21, horizontal: 1.35, vertikal: 1.06

Unterschrift des Schützen

Ergebnis: **310.1** (296)
 Serien: 103.3 103.1 103.7
 Zähler: 26 4 0 0 0 0 0 0 0 0
 Innenzehner: 23
 weiteste: 414 (16), 280 (4), 257 (12)
 beste Teiler 47.1 (17.) 48.2 (23.) 52.5 (9.)
 Trefferlage 0.42 mm rechts, 0.13 mm hoch
 Streuwert 1.21, horizontal: 1.38, vertikal: 1.00

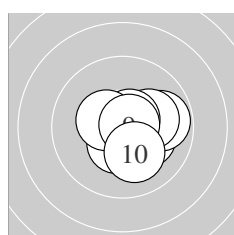
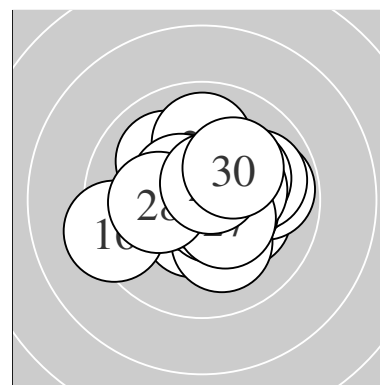

Serie 1:
 10.2 * 10.4 * 10.5 * 9.8 → 10.1 →
 10.5 * 10.6 * 10.4 * 10.7 * 10.1 ↘
 beste Teiler 52.5 (9.) 77.1 (7.) 113.4 (3.)
 Trefferlage 0.77 mm rechts, 0.37 mm tief
 Streuwert 1.05, horizontal: 1.15, vertikal: 0.93

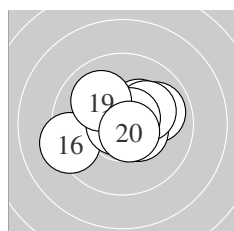

Serie 2:
 10.3 * 9.9 → 10.5 * 10.7 * 10.2 *
 9.3 ← 10.8 * 10.7 * 10.0 ↘ 10.7 *
 beste Teiler 47.1 (17.) 54.4 (14.) 71.0 (18.)
 Trefferlage 0.19 mm rechts, 0.22 mm hoch
 Streuwert 1.45, horizontal: 1.82, vertikal: 0.95

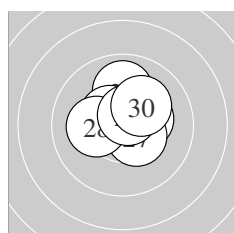

Serie 3:
 10.5 * 9.9 ↑ 10.8 * 10.5 * 10.3 *
 10.3 * 10.4 * 10.2 * 10.6 * 10.2 *
 beste Teiler 48.2 (23.) 83.1 (29.) 117.4 (24.)
 Trefferlage 0.31 mm rechts, 0.56 mm hoch
 Streuwert 1.06, horizontal: 1.14, vertikal: 0.98

Unterschrift des Schützen

Ergebnis: **309.4** (296)
 Serien: 103.6 104.7 101.1
 Zähler: 26 4 0 0 0 0 0 0 0 0
 Innenzehner: 21
 weiteste: 343 (24), 341 (25), 336 (26)
 beste Teiler 39.8 (14.) 59.2 (7.) 68.8 (8.)
 Trefferlage 0.37 mm links, 0.34 mm hoch
 Streuwert 1.24, horizontal: 1.42, vertikal: 1.04

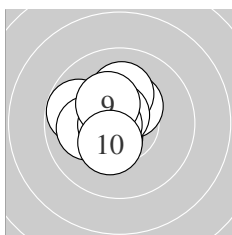
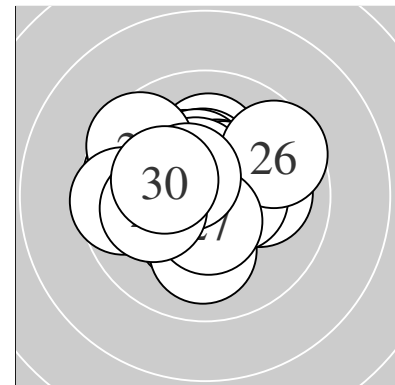

Serie 1:
 10.5 * 10.4 * 10.6 * 10.1 ↑ 9.8 ↖
 10.1 ← 10.7 * 10.7 * 10.3 * 10.4 *
 beste Teiler 59.2 (7.) 68.8 (8.) 99.2 (3.)
 Trefferlage 0.75 mm links, 0.40 mm hoch
 Streuwert 1.07, horizontal: 1.06, vertikal: 1.08

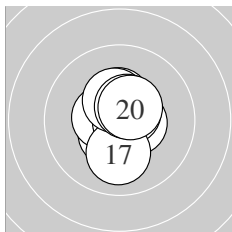

Serie 2:
 10.4 * 10.5 * 10.5 * 10.8 * 10.5 *
 10.6 * 10.0 ↓ 10.4 * 10.5 * 10.5 *
 beste Teiler 39.8 (14.) 84.3 (16.) 106.8 (19.)
 Trefferlage 0.10 mm rechts, 0.17 mm hoch
 Streuwert 0.94, horizontal: 0.68, vertikal: 1.14

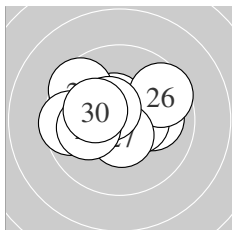

Serie 3:
 10.0 → 10.5 * 10.5 * 9.6 ↘ 9.6 ←
 9.6 ↗ 10.5 * 10.5 * 10.1 ← 10.2 *
 beste Teiler 106.0 (27.) 108.9 (28.) 111.0 (23.)
 Trefferlage 0.46 mm links, 0.45 mm hoch
 Streuwert 1.65, horizontal: 2.11, vertikal: 0.99

Unterschrift des Schützen

Ergebnis: **311.7** (298)
 Serien: 104.8 104.3 102.6
 Zähler: 28 2 0 0 0 0 0 0 0 0
 Innenzehner: 26
 weiteste: 281 (25), 262 (21), 238 (3)
 beste Teiler 4.1 (7.) 41.2 (15.) 56.3 (30.)
 Trefferlage 0.20 mm rechts, 0.46 mm hoch
 Streuwert 1.04, horizontal: 1.08, vertikal: 0.99

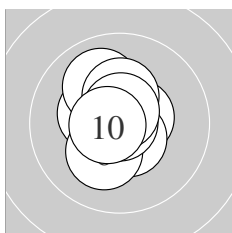
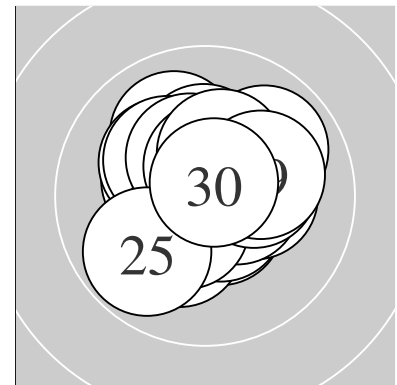

Serie 1:
 10.4 * 10.5 * 10.0 ↖ 10.6 * 10.5 *
 10.2 * 10.9 * 10.3 * 10.7 * 10.7 *
 beste Teiler 4.1 (7.) 69.3 (9.) 71.8 (10.)
 Trefferlage 0.25 mm links, 0.37 mm hoch
 Streuwert 0.94, horizontal: 0.74, vertikal: 1.10

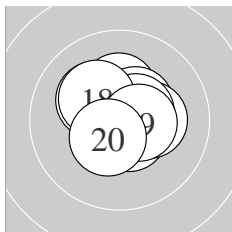

Serie 2:
 10.3 * 10.4 * 10.2 * 10.6 * 10.8 *
 10.3 * 10.5 * 10.2 * 10.5 * 10.5 *
 beste Teiler 41.2 (15.) 93.0 (14.) 104.6 (17.)
 Trefferlage 0.20 mm rechts, 0.34 mm hoch
 Streuwert 0.98, horizontal: 1.07, vertikal: 0.89

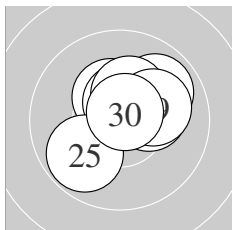

Serie 3:
 9.9 ↗ 10.4 * 10.5 * 10.3 * 9.8 ↙
 10.4 * 10.2 * 10.3 * 10.1 → 10.7 *
 beste Teiler 56.3 (30.) 104.3 (23.) 144.1 (22.)
 Trefferlage 0.65 mm rechts, 0.69 mm hoch
 Streuwert 1.15, horizontal: 1.27, vertikal: 1.02

Unterschrift des Schützen

Ergebnis: **308.5** (294)
 Serien: 100.9 103.4 104.2
 Zähler: 24 6 0 0 0 0 0 0 0 0
 Innenzehner: 21
 weiteste: 425 (5), 354 (11), 331 (10)
 beste Teiler 8.9 (26.) 50.4 (14.) 72.2 (15.)
 Trefferlage 0.14 mm rechts, 0.25 mm hoch
 Streuwert 1.37, horizontal: 1.66, vertikal: 0.99

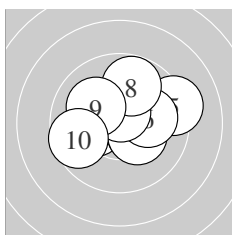
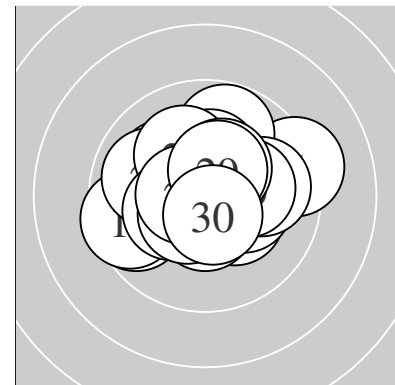

Serie 1:
 10.5 * 10.2 * 10.4 * 10.3 * 9.3 →
 10.1 → 10.6 * 9.8 ↑ 10.1 ↖ 9.6 ←
 beste Teiler 83.6 (7.) 105.3 (1.) 147.1 (3.)
 Trefferlage 0.40 mm rechts, 0.34 mm hoch
 Streuwert 1.74, horizontal: 2.13, vertikal: 1.22

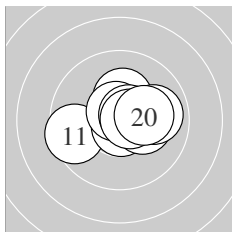

Serie 2:
 9.5 ← 10.5 * 10.3 * 10.8 * 10.7 *
 10.6 * 10.3 * 10.6 * 9.9 → 10.2 *
 beste Teiler 50.4 (14.) 72.2 (15.) 78.5 (16.)
 Trefferlage 0.50 mm rechts, 0.24 mm hoch
 Streuwert 1.26, horizontal: 1.62, vertikal: 0.75

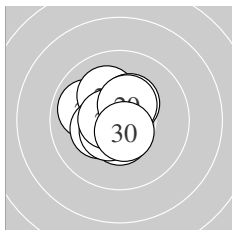

Serie 3:
 10.5 * 9.9 ↖ 10.1 ↖ 10.3 * 10.4 *
 10.9 * 10.5 * 10.6 * 10.4 * 10.6 *
 beste Teiler 8.9 (26.) 90.1 (28.) 92.8 (30.)
 Trefferlage 0.48 mm links, 0.17 mm hoch
 Streuwert 1.03, horizontal: 1.01, vertikal: 1.05

Unterschrift des Schützen

Ergebnis: **309.8** (297)
 Serien: 102.7 102.9 104.2
 Zähler: 27 3 0 0 0 0 0 0 0 0
 Innenzehner: 21
 weiteste: 364 (20), 300 (10), 275 (3)
 beste Teiler 39.0 (23.) 41.4 (29.) 60.4 (16.)
 Trefferlage 0.05 mm rechts, 0.14 mm tief
 Streuwert 1.27, horizontal: 1.35, vertikal: 1.19

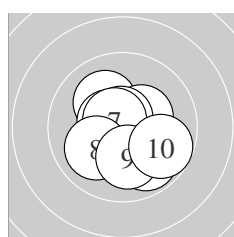
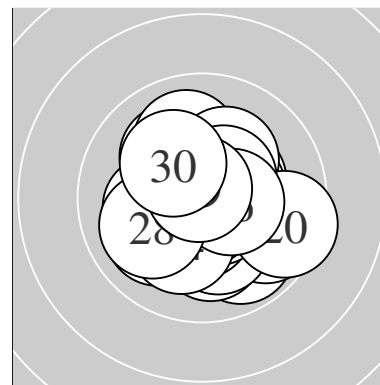

Serie 1:
 10.1 ↖ 10.6 * 9.9 ↘ 10.4 * 10.5 *
 10.7 * 10.6 * 10.0 ↙ 10.1 ↓ 9.8 ↗
 beste Teiler 63.9 (6.) 76.4 (7.) 97.3 (2.)
 Trefferlage 0.21 mm rechts, 0.27 mm tief
 Streuwert 1.40, horizontal: 1.42, vertikal: 1.38

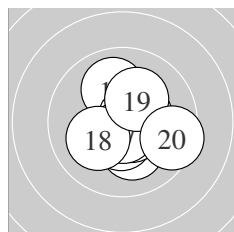

Serie 2:
 10.2 * 10.5 * 10.4 * 10.6 * 10.0 ↗
 10.7 * 10.7 * 10.1 ↙ 10.2 * 9.5 ↘
 beste Teiler 60.4 (16.) 65.1 (17.) 84.8 (14.)
 Trefferlage 0.51 mm rechts, 0.19 mm tief
 Streuwert 1.34, horizontal: 1.36, vertikal: 1.32

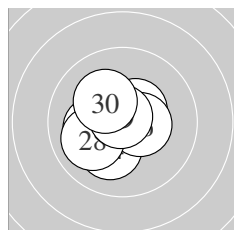

Serie 3:
 10.5 * 10.5 * 10.8 * 10.2 * 10.5 *
 10.5 * 10.2 * 10.0 ↙ 10.8 * 10.2 *
 beste Teiler 39.0 (23.) 41.4 (29.) 104.8 (25.)
 Trefferlage 0.57 mm links, 0.01 mm hoch
 Streuwert 1.05, horizontal: 1.13, vertikal: 0.96

Unterschrift des Schützen

Ergebnis: **309.2** (294)
 Serien: 102.3 103.1 103.8
 Zähler: 24 6 0 0 0 0 0 0 0 0
 Innenzehner: 21
 weiteste: 340 (7), 324 (24), 301 (26)
 beste Teiler 12.1 (21.) 16.6 (25.) 17.2 (22.)
 Trefferlage 0.20 mm rechts, 0.06 mm hoch
 Streuwert 1.31, horizontal: 1.58, vertikal: 0.97

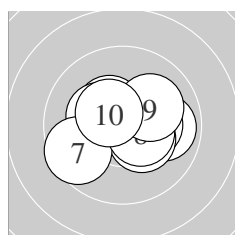
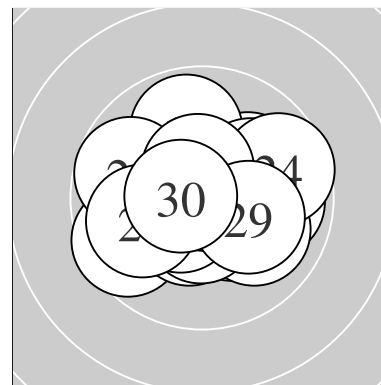

Serie 1:
 9.9 → 10.4 * 10.5 * 10.3 * 10.3 *
 10.3 * 9.6 ← 10.4 * 10.1 ↗ 10.5 *
 beste Teiler 105.3 (3.) 121.0 (10.) 130.1 (8.)
 Trefferlage 0.15 mm rechts, 0.10 mm hoch
 Streuwert 1.44, horizontal: 1.82, vertikal: 0.92

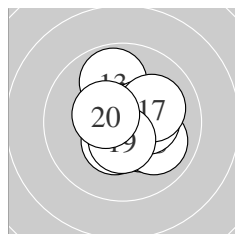

Serie 2:
 10.3 * 10.6 * 9.9 ↑ 10.5 * 10.0 ↘
 10.3 * 10.1 ↗ 10.4 * 10.5 * 10.5 *
 beste Teiler 79.0 (12.) 116.1 (19.) 119.5 (14.)
 Trefferlage 0.63 mm rechts, 0.00 mm
 Streuwert 1.20, horizontal: 1.14, vertikal: 1.25

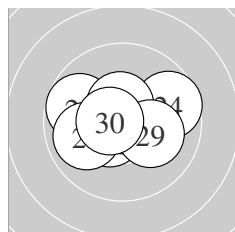

Serie 3:
 10.9 * 10.9 * 10.5 * 9.7 → 10.9 *
 9.7 ← 10.5 * 9.9 ← 10.2 * 10.6 *
 beste Teiler 12.1 (21.) 16.6 (25.) 17.2 (22.)
 Trefferlage 0.18 mm links, 0.09 mm hoch
 Streuwert 1.35, horizontal: 1.75, vertikal: 0.77

Unterschrift des Schützen

Ergebnis: **312.9** (300)
 Serien: 104.9 103.7 104.3
 Zähler: 30 0 0 0 0 0 0 0 0 0
 Innenzehner: 29
 weiteste: 227 (15), 198 (19), 195 (18)
 beste Teiler 16.7 (7.) 23.0 (14.) 53.8 (10.)
 Trefferlage 0.03 mm links, 0.09 mm tief
 Streuwert 1.01, horizontal: 1.09, vertikal: 0.94

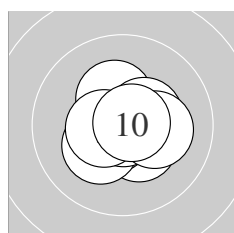
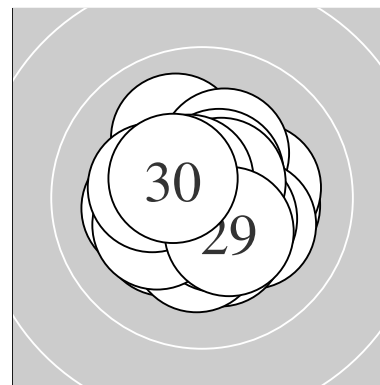

Serie 1:
 10.5 * 10.3 * 10.4 * 10.4 * 10.7 *
 10.3 * 10.9 * 10.2 * 10.5 * 10.7 *
 beste Teiler 16.7 (7.) 53.8 (10.) 67.1 (5.)
 Trefferlage 0.05 mm rechts, 0.17 mm tief
 Streuwert 0.93, horizontal: 1.06, vertikal: 0.78

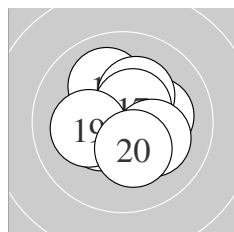

Serie 2:
 10.7 * 10.4 * 10.2 * 10.9 * 10.0 ↗
 10.3 * 10.5 * 10.2 * 10.2 * 10.3 *
 beste Teiler 23.0 (14.) 71.6 (11.) 103.4 (17.)
 Trefferlage 0.09 mm rechts, 0.15 mm hoch
 Streuwert 1.19, horizontal: 1.26, vertikal: 1.12

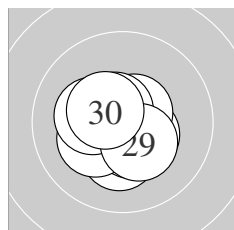

Serie 3:
 10.3 * 10.4 * 10.6 * 10.5 * 10.2 *
 10.6 * 10.2 * 10.6 * 10.4 * 10.5 *
 beste Teiler 79.6 (28.) 82.8 (26.) 85.2 (23.)
 Trefferlage 0.24 mm links, 0.28 mm tief
 Streuwert 0.97, horizontal: 1.01, vertikal: 0.92

Unterschrift des Schützen

Ergebnis: **305.4** (293)
 Serien: 101.4 102.3 101.7
 Zähler: 23 7 0 0 0 0 0 0 0 0
 Innenzehner: 19
 weiteste: 422 (8), 419 (20), 388 (21)
 beste Teiler 54.5 (5.) 61.0 (19.) 64.5 (22.)
 Trefferlage 0.60 mm rechts, 0.13 mm tief
 Streuwert 1.54, horizontal: 1.44, vertikal: 1.62

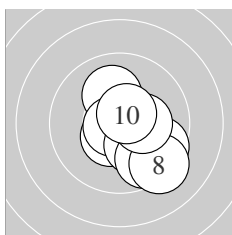
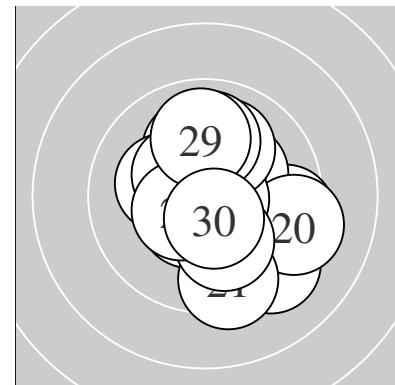

Serie 1:
 10.1 ↑ 10.5 * 9.6 ↘ 10.4 * 10.7 *
 10.2 * 9.7 ↘ 9.3 ↘ 10.3 * 10.6 *
 beste Teiler 54.5 (5.) 88.0 (10.) 120.6 (2.)
 Trefferlage 1.06 mm rechts, 0.79 mm tief
 Streuwert 1.46, horizontal: 1.36, vertikal: 1.55

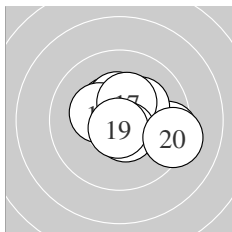

Serie 2:
 9.5 → 10.5 * 10.4 * 10.2 * 10.4 *
 10.3 * 10.4 * 10.6 * 10.7 * 9.3 →
 beste Teiler 61.0 (19.) 99.2 (18.) 125.0 (12.)
 Trefferlage 0.74 mm rechts, 0.28 mm hoch
 Streuwert 1.48, horizontal: 1.80, vertikal: 1.07

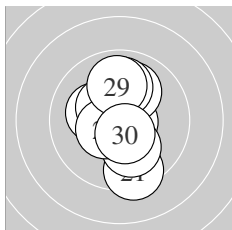

Serie 3:
 9.4 ↓ 10.7 * 10.1 ↓ 10.2 * 10.4 *
 10.0 ↗ 10.5 * 10.0 ↑ 9.9 ↑ 10.5 *
 beste Teiler 64.5 (22.) 109.5 (30.) 123.4 (27.)
 Trefferlage 0.00 mm , 0.11 mm hoch
 Streuwert 1.61, horizontal: 0.98, vertikal: 2.05

Unterschrift des Schützen

Ergebnis: **309.9** (296)
 Serien: 105.4 102.9 101.6
 Zähler: 26 4 0 0 0 0 0 0 0 0
 Innenzehner: 23
 weiteste: 446 (21), 386 (30), 304 (14)
 beste Teiler 17.0 (16.) 59.0 (17.) 67.1 (1.)
 Trefferlage 0.18 mm rechts, 0.19 mm hoch
 Streuwert 1.31, horizontal: 1.41, vertikal: 1.21

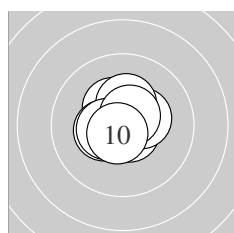
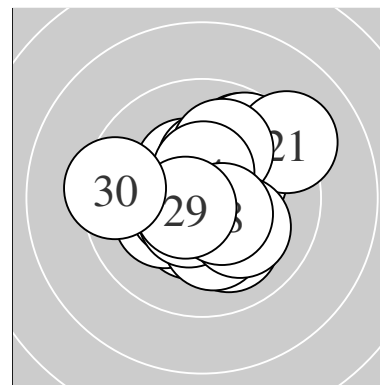

Serie 1:
 10.7 * 10.7 * 10.4 * 10.4 * 10.4 *
 10.3 * 10.7 * 10.5 * 10.6 * 10.7 *
 beste Teiler 67.1 (1.) 71.5 (10.) 75.6 (7.)
 Trefferlage 0.21 mm links, 0.26 mm hoch
 Streuwert 0.81, horizontal: 0.85, vertikal: 0.76

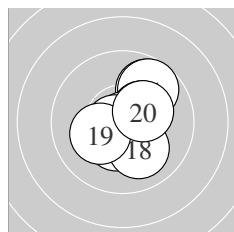

Serie 2:
 10.5 * 9.8 ↗ 10.4 * 9.7 ↗ 10.3 *
 10.9 * 10.7 * 10.1 ↘ 10.2 * 10.3 *
 beste Teiler 17.0 (16.) 59.0 (17.) 102.8 (11.)
 Trefferlage 0.61 mm rechts, 0.24 mm hoch
 Streuwert 1.31, horizontal: 1.18, vertikal: 1.43

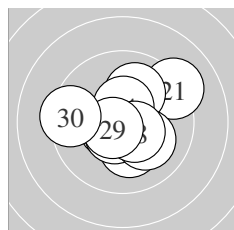

Serie 3:
 9.2 ↗ 10.0 ↗ 10.5 * 10.5 * 10.2 *
 10.6 * 10.1 ↘ 10.5 * 10.6 * 9.4 ←
 beste Teiler 84.7 (29.) 100.4 (26.) 104.7 (23.)
 Trefferlage 0.16 mm rechts, 0.07 mm hoch
 Streuwert 1.72, horizontal: 1.97, vertikal: 1.43

Unterschrift des Schützen

Ergebnis: **300.2** (286)
 Serien: 100.3 99.9 100.0
 Zähler: 18 10 2 0 0 0 0 0 0 0
 Innenzehner: 10
 weiteste: 603 (14), 570 (12), 456 (21)
 beste Teiler 16.4 (4.) 29.4 (15.) 53.0 (19.)
 Trefferlage 0.49 mm rechts, 0.14 mm tief
 Streuwert 1.95, horizontal: 2.29, vertikal: 1.53

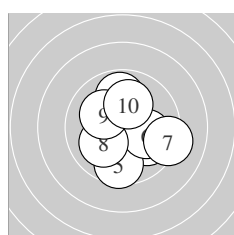
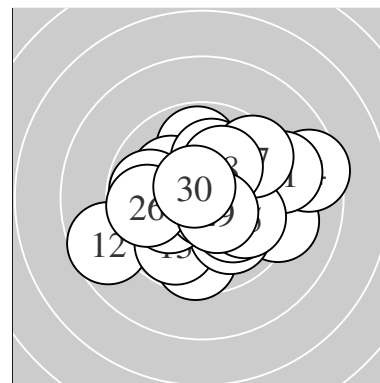

Serie 1:
 9.8 ↑ 9.9 ↘ 10.5 * 10.9 * 9.6 ↓
 10.1 → 9.2 ↘ 10.1 ↙ 10.1 ↖ 10.1 ↑
 beste Teiler 16.4 (4.) 124.4 (3.) 204.9 (9.)
 Trefferlage 0.48 mm rechts, 0.32 mm tief
 Streuwert 1.85, horizontal: 1.86, vertikal: 1.84

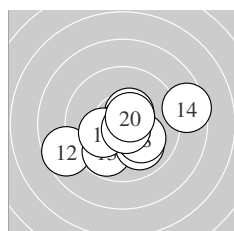

Serie 2:
 10.5 * 8.7 ↙ 9.8 ↘ 8.5 → 10.8 *
 10.0 ↘ 10.2 * 10.1 ↘ 10.7 * 10.6 *
 beste Teiler 29.4 (15.) 53.0 (19.) 91.9 (20.)
 Trefferlage 0.25 mm rechts, 0.61 mm tief
 Streuwert 2.24, horizontal: 2.82, vertikal: 1.43

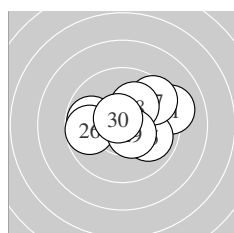

Serie 3:
 9.1 → 9.8 ← 10.1 ↗ 10.6 * 9.9 ↘
 9.7 ← 9.5 ↗ 10.1 ↗ 10.5 * 10.7 *
 beste Teiler 74.8 (30.) 97.6 (24.) 113.2 (29.)
 Trefferlage 0.75 mm rechts, 0.51 mm hoch
 Streuwert 1.83, horizontal: 2.32, vertikal: 1.15

Unterschrift des Schützen