

Ergebnis: **209.0** (200)
 Serien: 103.9 105.1
 Zähler: 20 0 0 0 0 0 0 0 0 0
 Innenzehner: 17
 weiteste: 233 (9), 217 (4), 203 (6)
 beste Teiler 3.1 (10.) 42.2 (19.) 70.0 (8.)
 Trefferlage 0.22 mm links, 0.09 mm tief
 Streuwert 0.98, horizontal: 1.10, vertikal: 0.85

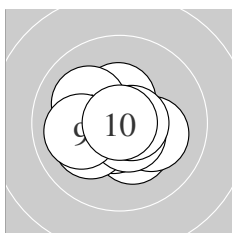

Serie 1:
 10.3 * 10.4 * 10.6 * 10.1 ↘ 10.2 *
 10.1 ↙ 10.6 * 10.7 * 10.0 ← 10.9 *
 beste Teiler 3.1 (10.) 70.0 (8.) 84.5 (3.)
 Trefferlage 0.23 mm links, 0.24 mm tief
 Streuwert 1.14, horizontal: 1.33, vertikal: 0.91

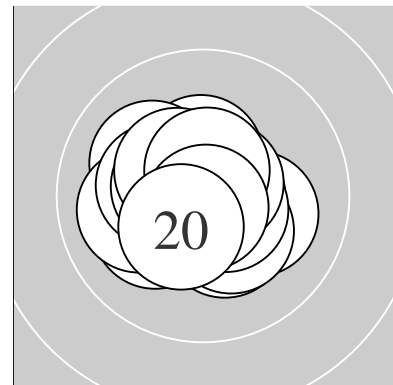
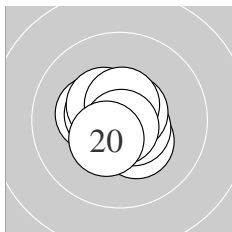

Serie 2:
 10.6 * 10.3 * 10.3 * 10.6 * 10.6 *
 10.5 * 10.4 * 10.6 * 10.8 * 10.4 *
 beste Teiler 42.2 (19.) 78.8 (15.) 87.7 (11.)
 Trefferlage 0.21 mm links, 0.05 mm hoch
 Streuwert 0.85, horizontal: 0.88, vertikal: 0.81

Unterschrift des Schützen

Ergebnis: **207.3** (197)
 Serien: 103.0 104.3
 Zähler: 17 3 0 0 0 0 0 0 0 0
 Innenzehner: 15
 weiteste: 313 (2), 285 (8), 259 (16)
 beste Teiler 20.0 (5.) 66.0 (14.) 67.5 (20.)
 Trefferlage 0.58 mm links, 0.16 mm hoch
 Streuwert 1.12, horizontal: 1.31, vertikal: 0.90

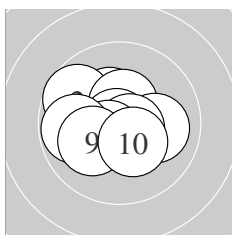
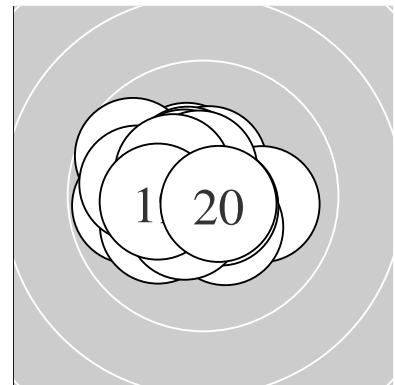

Serie 1:
 10.4 * 9.7 ↖ 10.5 * 10.0 → 10.9 *
 10.7 * 10.5 * 9.8 ← 10.1 ↙ 10.4 *
 beste Teiler 20.0 (5.) 74.7 (6.) 106.1 (7.)
 Trefferlage 0.48 mm links, 0.00 mm
 Streuwert 1.35, horizontal: 1.62, vertikal: 1.03

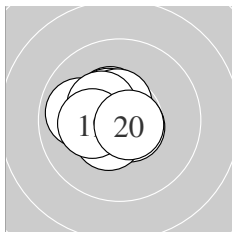

Serie 2:
 10.6 * 10.4 * 10.4 * 10.7 * 10.5 *
 9.9 ← 10.4 * 10.5 * 10.2 * 10.7 *
 beste Teiler 66.0 (14.) 67.5 (20.) 80.7 (11.)
 Trefferlage 0.68 mm links, 0.33 mm hoch
 Streuwert 0.89, horizontal: 0.98, vertikal: 0.77

Unterschrift des Schützen

Ergebnis: **208.5** (198)
 Serien: 104.8 103.7
 Zähler: 18 2 0 0 0 0 0 0 0 0
 Innenzehner: 16
 weiteste: 327 (15), 314 (19), 223 (9)
 beste Teiler 46.1 (13.) 49.2 (14.) 49.9 (4.)
 Trefferlage 0.24 mm links, 0.37 mm tief
 Streuwert 1.12, horizontal: 1.12, vertikal: 1.12

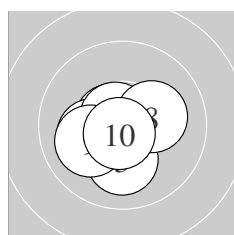
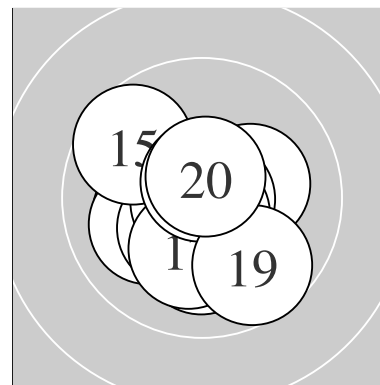

Serie 1:
 10.7 * 10.7 * 10.1 ↓ 10.8 * 10.6 *
 10.2 * 10.7 * 10.2 * 10.1 ← 10.7 *
 beste Teiler 49.9 (4.) 56.0 (10.) 56.4 (2.)
 Trefferlage 0.40 mm links, 0.27 mm tief
 Streuwert 0.97, horizontal: 1.10, vertikal: 0.82

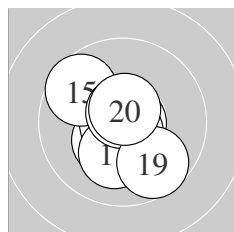

Serie 2:
 10.4 * 10.2 * 10.8 * 10.8 * 9.6 ↘
 10.7 * 10.2 * 10.7 * 9.7 ↘ 10.6 *
 beste Teiler 46.1 (13.) 49.2 (14.) 61.2 (18.)
 Trefferlage 0.08 mm links, 0.48 mm tief
 Streuwert 1.30, horizontal: 1.18, vertikal: 1.40

Unterschrift des Schützen

Ergebnis: **207.6** (199)
 Serien: 104.4 103.2
 Zähler: 19 1 0 0 0 0 0 0 0 0
 Innenzehner: 15
 weiteste: 262 (14), 241 (9), 229 (3)
 beste Teiler 41.4 (4.) 42.1 (5.) 58.0 (7.)
 Trefferlage 0.45 mm rechts, 0.48 mm tief
 Streuwert 1.04, horizontal: 0.96, vertikal: 1.12

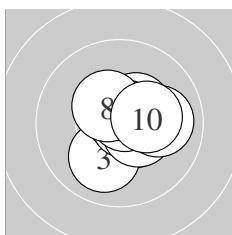
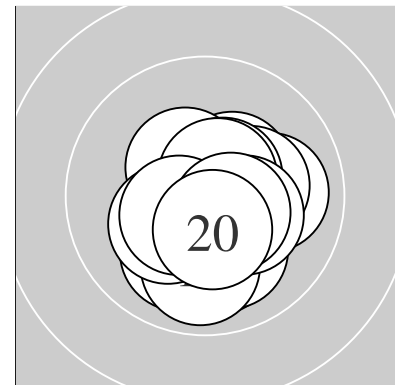

Serie 1:
 10.5 * 10.4 * 10.0 ✓ 10.8 * 10.8 *
 10.5 * 10.7 * 10.4 * 10.0 → 10.3 *
 beste Teiler 41.4 (4.) 42.1 (5.) 58.0 (7.)
 Trefferlage 0.63 mm rechts, 0.02 mm hoch
 Streuwert 0.97, horizontal: 1.03, vertikal: 0.91

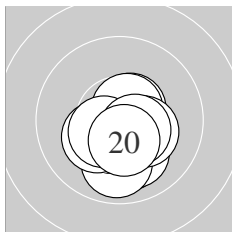

Serie 2:
 10.0 ↓ 10.6 * 10.1 ✘ 9.9 ↓ 10.6 *
 10.3 * 10.3 * 10.5 * 10.5 * 10.4 *
 beste Teiler 82.6 (15.) 96.8 (12.) 115.1 (19.)
 Trefferlage 0.26 mm rechts, 0.98 mm tief
 Streuwert 1.01, horizontal: 0.89, vertikal: 1.12

Unterschrift des Schützen

Ergebnis: **204.9** (198)
 Serien: 102.0 102.9
 Zähler: 18 2 0 0 0 0 0 0 0 0
 Innenzehner: 13
 weiteste: 319 (10), 297 (20), 215 (6)
 beste Teiler 100.0 (16.) 115.8 (13.) 117.9 (1.)
 Trefferlage 0.44 mm links, 0.04 mm hoch
 Streuwert 1.32, horizontal: 1.71, vertikal: 0.76

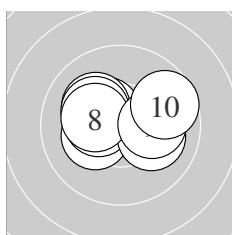
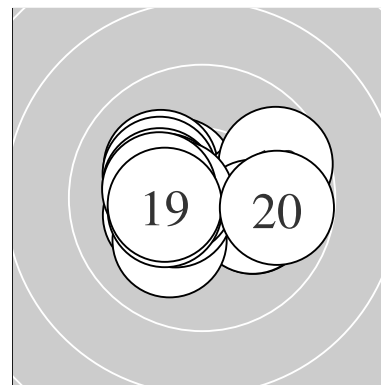

Serie 1:
 10.5 * 10.2 * 10.4 * 10.4 * 10.1 ↖
 10.1 → 10.2 * 10.3 * 10.1 → 9.7 →
 beste Teiler 117.9 (1.) 133.0 (3.) 145.1 (4.)
 Trefferlage 0.30 mm links, 0.43 mm hoch
 Streuwert 1.41, horizontal: 1.85, vertikal: 0.73

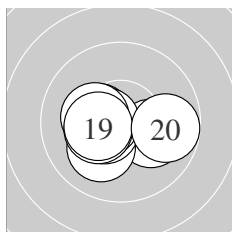

Serie 2:
 10.1 → 10.1 ↙ 10.5 * 10.4 * 10.4 *
 10.6 * 10.3 * 10.3 * 10.4 * 9.8 →
 beste Teiler 100.0 (16.) 115.8 (13.) 144.5 (15.)
 Trefferlage 0.59 mm links, 0.35 mm tief
 Streuwert 1.23, horizontal: 1.64, vertikal: 0.58

Unterschrift des Schützen

Ergebnis: **207.7** (198)
 Serien: 103.8 103.9
 Zähler: 18 2 0 0 0 0 0 0 0 0
 Innenzehner: 16
 weiteste: 304 (10), 254 (14), 241 (7)
 beste Teiler 43.8 (1.) 54.1 (11.) 60.8 (9.)
 Trefferlage 0.05 mm rechts, 0.32 mm tief
 Streuwert 1.11, horizontal: 1.20, vertikal: 1.01

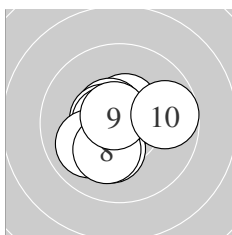
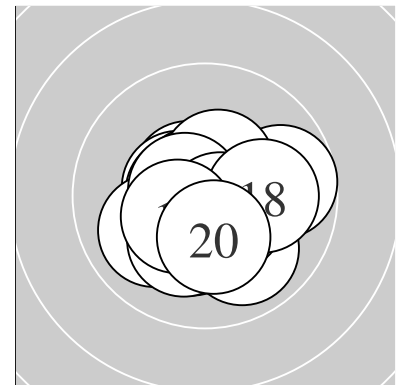

Serie 1:
 10.8 * 10.5 * 10.6 * 10.5 * 10.2 *
 10.6 * 10.0 ↙ 10.2 * 10.7 * 9.7 →
 beste Teiler 43.8 (1.) 60.8 (9.) 91.0 (6.)
 Trefferlage 0.27 mm links, 0.11 mm tief
 Streuwert 1.20, horizontal: 1.33, vertikal: 1.05

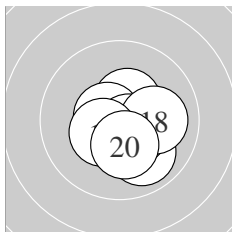

Serie 2:
 10.7 * 10.4 * 10.5 * 9.9 ↘ 10.6 *
 10.5 * 10.6 * 10.0 → 10.4 * 10.3 *
 beste Teiler 54.1 (11.) 79.3 (17.) 83.8 (15.)
 Trefferlage 0.37 mm rechts, 0.52 mm tief
 Streuwert 1.00, horizontal: 1.03, vertikal: 0.97

Unterschrift des Schützen

Ergebnis: **210.1** (200)
 Serien: 105.1 105.0
 Zähler: 20 0 0 0 0 0 0 0 0 0
 Innenzehner: 19
 weiteste: 204 (6), 187 (11), 174 (8)
 beste Teiler 10.8 (3.) 22.5 (10.) 51.6 (18.)
 Trefferlage 0.02 mm links, 0.12 mm hoch
 Streuwert 0.89, horizontal: 0.98, vertikal: 0.78

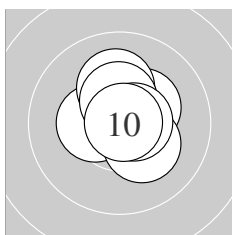
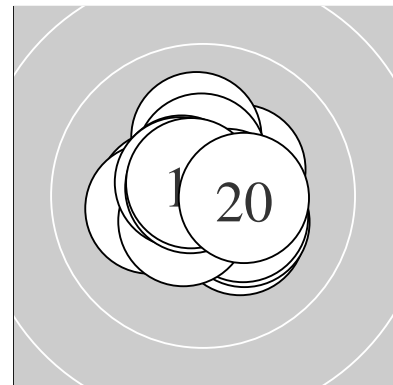

Serie 1:
 10.6 * 10.6 * 10.9 * 10.3 * 10.4 *
 10.1 † 10.4 * 10.3 * 10.6 * 10.9 *
 beste Teiler 10.8 (3.) 22.5 (10.) 81.3 (9.)
 Trefferlage 0.05 mm rechts, 0.43 mm hoch
 Streuwert 0.87, horizontal: 0.88, vertikal: 0.86

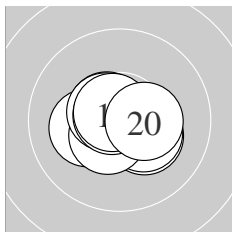

Serie 2:
 10.2 * 10.3 * 10.7 * 10.3 * 10.6 *
 10.5 * 10.6 * 10.7 * 10.7 * 10.4 *
 beste Teiler 51.6 (18.) 51.9 (13.) 60.1 (19.)
 Trefferlage 0.09 mm links, 0.17 mm tief
 Streuwert 0.89, horizontal: 1.12, vertikal: 0.57

Unterschrift des Schützen

Ergebnis: **207.3** (199)
 Serien: 104.3 103.0
 Zähler: 19 1 0 0 0 0 0 0 0 0
 Innenzehner: 16
 weiteste: 266 (8), 222 (17), 215 (11)
 beste Teiler 56.6 (2.) 83.2 (14.) 86.8 (4.)
 Trefferlage 0.18 mm rechts, 0.37 mm hoch
 Streuwert 1.10, horizontal: 1.20, vertikal: 0.99

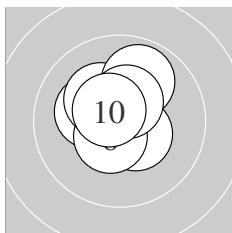
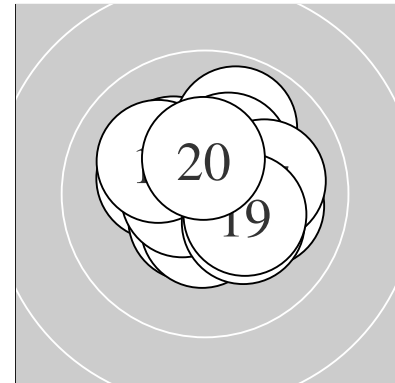

Serie 1:
 10.5 * 10.7 * 10.5 * 10.6 * 10.2 *
 10.5 * 10.3 * 9.9 ↑ 10.5 * 10.6 *
 beste Teiler 56.6 (2.) 86.8 (4.) 93.3 (10.)
 Trefferlage 0.30 mm links, 0.65 mm hoch
 Streuwert 0.94, horizontal: 0.90, vertikal: 0.98

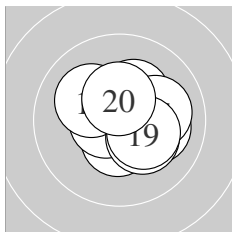

Serie 2:
 10.1 → 10.5 * 10.3 * 10.6 * 10.3 *
 10.1 ↖ 10.1 → 10.3 * 10.3 * 10.4 *
 beste Teiler 83.2 (14.) 119.5 (12.) 130.1 (20.)
 Trefferlage 0.68 mm rechts, 0.09 mm hoch
 Streuwert 1.15, horizontal: 1.31, vertikal: 0.98

Unterschrift des Schützen

Ergebnis: **206.7** (197)
 Serien: 102.5 104.2
 Zähler: 17 3 0 0 0 0 0 0 0 0
 Innenzehner: 16
 weiteste: 360 (7), 286 (17), 259 (16)
 beste Teiler 53.6 (13.) 58.5 (20.) 59.1 (18.)
 Trefferlage 0.19 mm rechts, 0.20 mm tief
 Streuwert 1.24, horizontal: 1.45, vertikal: 0.98

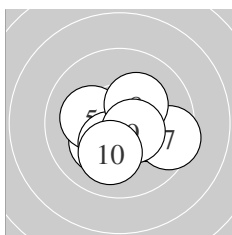
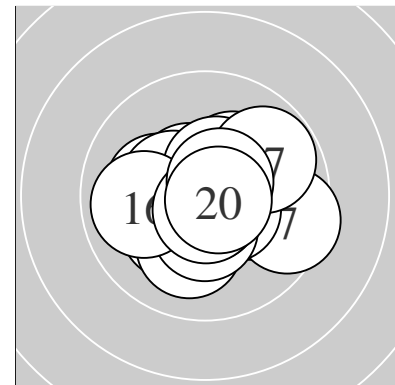

Serie 1:
 10.2 * 10.6 * 10.2 * 10.6 * 10.2 *
 10.3 * 9.5 ↘ 10.3 * 10.5 * 10.1 ↓
 beste Teiler 83.0 (2.) 98.4 (4.) 110.2 (9.)
 Trefferlage 0.42 mm rechts, 0.56 mm tief
 Streuwert 1.34, horizontal: 1.61, vertikal: 0.98

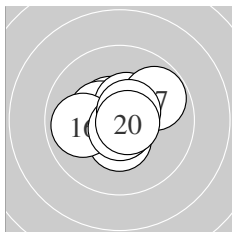

Serie 2:
 10.4 * 10.5 * 10.7 * 10.4 * 10.5 *
 9.9 ← 9.8 ↗ 10.7 * 10.6 * 10.7 *
 beste Teiler 53.6 (13.) 58.5 (20.) 59.1 (18.)
 Trefferlage 0.03 mm links, 0.15 mm hoch
 Streuwert 1.13, horizontal: 1.32, vertikal: 0.89

Unterschrift des Schützen

Ergebnis: **207.2** (199)
 Serien: 103.6 103.6
 Zähler: 19 1 0 0 0 0 0 0 0 0
 Innenzehner: 16
 weiteste: 275 (13), 248 (8), 246 (4)
 beste Teiler 43.8 (14.) 85.7 (5.) 86.0 (7.)
 Trefferlage 0.85 mm rechts, 0.30 mm hoch
 Streuwert 0.99, horizontal: 1.04, vertikal: 0.93

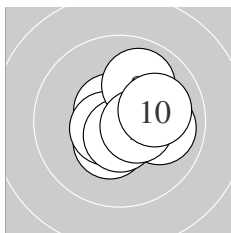
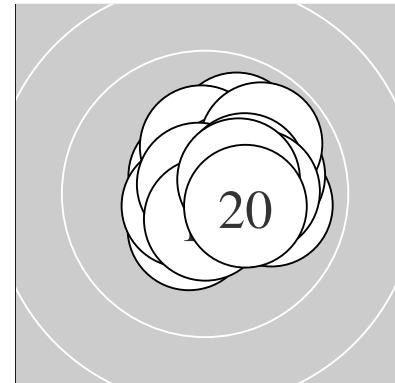

Serie 1:
 10.4 * 10.2 * 10.6 * 10.0 → 10.6 *
 10.6 * 10.6 * 10.0 ↗ 10.5 * 10.1 →
 beste Teiler 85.7 (5.) 86.0 (7.) 92.1 (6.)
 Trefferlage 0.69 mm rechts, 0.15 mm hoch
 Streuwert 1.12, horizontal: 1.21, vertikal: 1.02

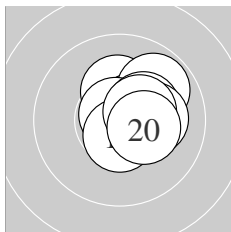

Serie 2:
 10.3 * 10.5 * 9.9 ↘ 10.8 * 10.3 *
 10.6 * 10.3 * 10.2 * 10.4 * 10.3 *
 beste Teiler 43.8 (14.) 93.0 (16.) 110.8 (12.)
 Trefferlage 1.01 mm rechts, 0.45 mm hoch
 Streuwert 0.86, horizontal: 0.86, vertikal: 0.86

Unterschrift des Schützen

Ergebnis: **208.1** (199)
 Serien: 103.8 104.3
 Zähler: 19 1 0 0 0 0 0 0 0 0
 Innenzehner: 18
 weiteste: 358 (6), 247 (10), 189 (14)
 beste Teiler 41.7 (20.) 57.0 (12.) 59.4 (4.)
 Trefferlage 0.27 mm rechts, 0.39 mm tief
 Streuwert 1.06, horizontal: 1.19, vertikal: 0.91

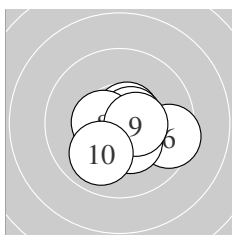
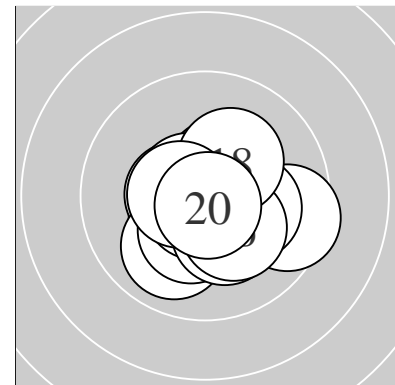

Serie 1:
 10.6 * 10.4 * 10.6 * 10.7 * 10.6 *
 9.5 → 10.4 * 10.5 * 10.5 * 10.0 ↙
 beste Teiler 59.4 (4.) 82.4 (1.) 85.2 (5.)
 Trefferlage 0.24 mm rechts, 0.51 mm tief
 Streuwert 1.18, horizontal: 1.45, vertikal: 0.81

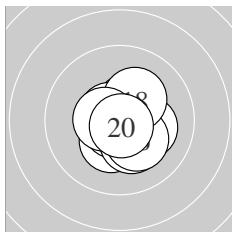

Serie 2:
 10.3 * 10.7 * 10.5 * 10.2 * 10.3 *
 10.2 * 10.6 * 10.2 * 10.5 * 10.8 *
 beste Teiler 41.7 (20.) 57.0 (12.) 77.6 (17.)
 Trefferlage 0.29 mm rechts, 0.26 mm tief
 Streuwert 0.98, horizontal: 0.95, vertikal: 1.02

Unterschrift des Schützen

Ergebnis: **207.1** (199)
 Serien: 103.6 103.5
 Zähler: 19 1 0 0 0 0 0 0 0 0
 Innenzehner: 17
 weiteste: 352 (13), 215 (14), 211 (9)
 beste Teiler 53.8 (6.) 61.1 (20.) 67.2 (11.)
 Trefferlage 0.38 mm rechts, 0.35 mm hoch
 Streuwert 1.12, horizontal: 1.15, vertikal: 1.09

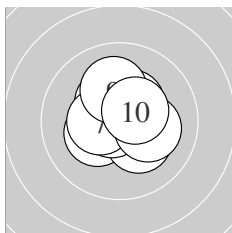
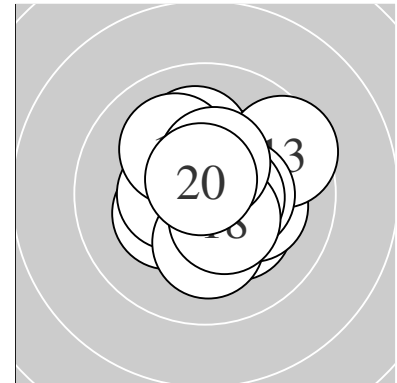

Serie 1:
 10.3 * 10.2 * 10.4 * 10.4 * 10.4 *
 10.7 * 10.4 * 10.2 * 10.1 ↑ 10.5 *
 beste Teiler 53.8 (6.) 125.9 (10.) 129.0 (7.)
 Trefferlage 0.11 mm rechts, 0.37 mm hoch
 Streuwert 1.11, horizontal: 1.15, vertikal: 1.07

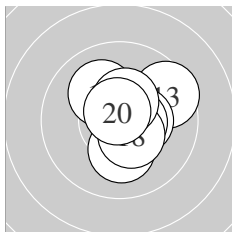

Serie 2:
 10.7 * 10.4 * 9.5 ↘ 10.1 ↖ 10.4 *
 10.2 * 10.6 * 10.5 * 10.4 * 10.7 *
 beste Teiler 61.1 (20.) 67.2 (11.) 96.0 (17.)
 Trefferlage 0.66 mm rechts, 0.33 mm hoch
 Streuwert 1.15, horizontal: 1.14, vertikal: 1.17

Unterschrift des Schützen

Ergebnis: **205.5** (195)
 Serien: 102.1 103.4
 Zähler: 15 5 0 0 0 0 0 0 0 0
 Innenzehner: 14
 weiteste: 410 (7), 383 (1), 303 (15)
 beste Teiler 44.7 (18.) 48.2 (8.) 49.2 (19.)
 Trefferlage 0.47 mm rechts, 0.45 mm tief
 Streuwert 1.37, horizontal: 1.57, vertikal: 1.14

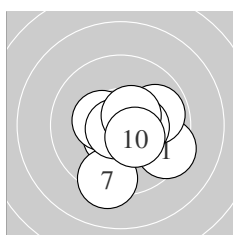
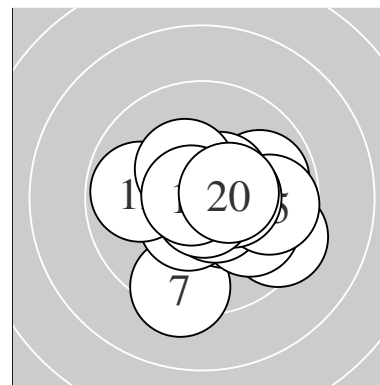

Serie 1:
 9.4 ↘ 9.9 → 10.5 * 10.4 * 10.5 *
 10.4 * 9.3 ↓ 10.8 * 10.5 * 10.4 *
 beste Teiler 48.2 (8.) 104.0 (5.) 106.8 (9.)
 Trefferlage 0.58 mm rechts, 0.72 mm tief
 Streuwert 1.49, horizontal: 1.56, vertikal: 1.42

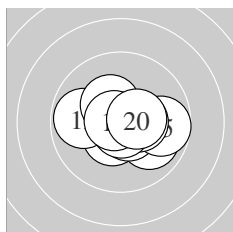

Serie 2:
 10.5 * 9.8 ← 10.0 ↘ 10.6 * 9.7 →
 10.3 * 10.4 * 10.8 * 10.8 * 10.5 *
 beste Teiler 44.7 (18.) 49.2 (19.) 88.5 (14.)
 Trefferlage 0.37 mm rechts, 0.17 mm tief
 Streuwert 1.28, horizontal: 1.66, vertikal: 0.74

Unterschrift des Schützen

Ergebnis: **206.9** (197)
 Serien: 103.6 103.3
 Zähler: 17 3 0 0 0 0 0 0 0 0
 Innenzehner: 14
 weiteste: 324 (11), 295 (1), 253 (12)
 beste Teiler 64.1 (3.) 69.4 (7.) 79.8 (4.)
 Trefferlage 0.05 mm rechts, 0.39 mm tief
 Streuwert 1.20, horizontal: 1.35, vertikal: 1.03

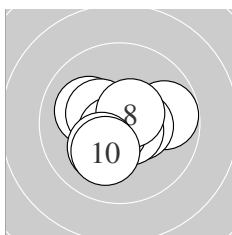
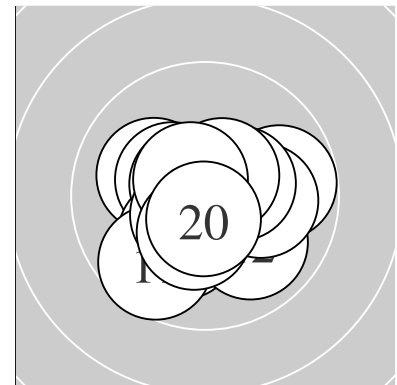

Serie 1:
 9.8 → 10.4 * 10.7 * 10.6 * 10.1 ↖
 10.4 * 10.7 * 10.6 * 10.2 * 10.1 ↙
 beste Teiler 64.1 (3.) 69.4 (7.) 79.8 (4.)
 Trefferlage 0.03 mm links, 0.25 mm tief
 Streuwert 1.22, horizontal: 1.46, vertikal: 0.93

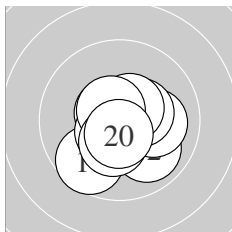

Serie 2:
 9.7 ↙ 9.9 ↘ 10.6 * 10.1 → 10.4 *
 10.5 * 10.5 * 10.6 * 10.4 * 10.6 *
 beste Teiler 85.4 (13.) 85.7 (18.) 90.1 (20.)
 Trefferlage 0.15 mm rechts, 0.52 mm tief
 Streuwert 1.23, horizontal: 1.30, vertikal: 1.16

Unterschrift des Schützen

Ergebnis: **207.9** (198)
 Serien: 103.5 104.4
 Zähler: 18 2 0 0 0 0 0 0 0 0
 Innenzehner: 16
 weiteste: 270 (7), 267 (5), 237 (9)
 beste Teiler 8.4 (3.) 34.2 (2.) 52.6 (4.)
 Trefferlage 0.36 mm links, 0.19 mm hoch
 Streuwert 1.09, horizontal: 1.12, vertikal: 1.06

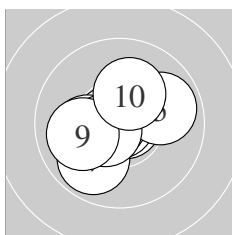
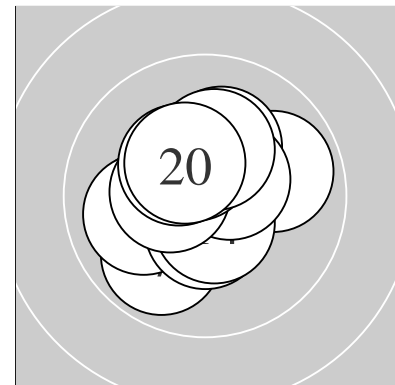

Serie 1:
 10.4 * 10.8 * 10.9 * 10.7 * 9.9 →
 10.1 ← 9.9 ↙ 10.6 * 10.0 ← 10.2 *
 beste Teiler 8.4 (3.) 34.2 (2.) 52.6 (4.)
 Trefferlage 0.49 mm links, 0.16 mm tief
 Streuwert 1.26, horizontal: 1.43, vertikal: 1.06

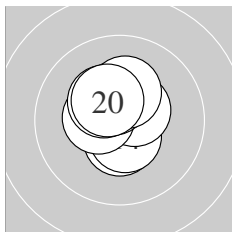

Serie 2:
 10.7 * 10.4 * 10.5 * 10.5 * 10.5 *
 10.4 * 10.3 * 10.4 * 10.3 * 10.4 *
 beste Teiler 68.6 (11.) 105.6 (14.) 110.9 (15.)
 Trefferlage 0.22 mm links, 0.55 mm hoch
 Streuwert 0.87, horizontal: 0.74, vertikal: 0.99

Unterschrift des Schützen

Ergebnis: **207.0** (197)
 Serien: 103.5 103.5
 Zähler: 17 3 0 0 0 0 0 0 0 0
 Innenzehner: 16
 weiteste: 354 (16), 272 (10), 257 (2)
 beste Teiler 58.0 (3.) 59.4 (14.) 65.1 (5.)
 Trefferlage 0.50 mm rechts, 0.10 mm hoch
 Streuwert 1.16, horizontal: 1.09, vertikal: 1.22

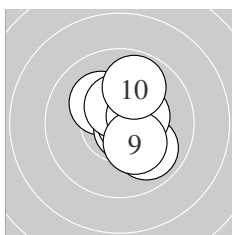
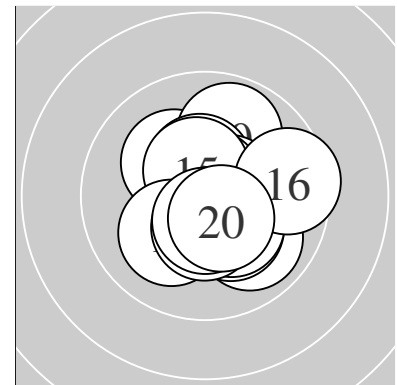

Serie 1:
 10.2 * 9.9 ↘ 10.7 * 10.4 * 10.7 *
 10.5 * 10.5 * 10.4 * 10.3 * 9.9 ↗
 beste Teiler 58.0 (3.) 65.1 (5.) 104.3 (6.)
 Trefferlage 0.56 mm rechts, 0.43 mm hoch
 Streuwert 1.13, horizontal: 0.90, vertikal: 1.32

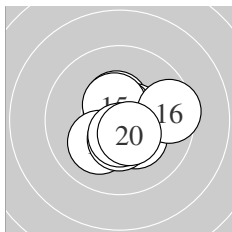

Serie 2:
 10.3 * 10.5 * 10.5 * 10.7 * 10.5 *
 9.5 → 10.1 ↙ 10.4 * 10.5 * 10.5 *
 beste Teiler 59.4 (14.) 101.8 (13.) 105.0 (19.)
 Trefferlage 0.44 mm rechts, 0.22 mm tief
 Streuwert 1.19, horizontal: 1.30, vertikal: 1.08

Unterschrift des Schützen