

Ergebnis:	590.4	(567)
Serien:	99.2 99.5 98.6 97.3 98.7 97.1	
Zähler:	34 19 7 0 0 0 0 0 0	
Innenzehner:	21	
weiteste:	734 (52), 684 (31), 669 (48)	
beste Teiler	53.5 (6.) 68.1 (41.) 79.7 (28.)	
Trefferlage	0.03 mm links, 0.04 mm tief	
Streuwert	2.26, horizontal: 2.33, vertikal: 2.18	

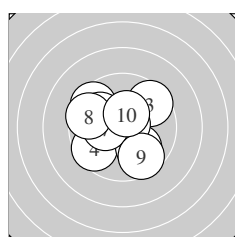

Serie 1:	9.5 ↘	10.0 ↘	9.6 ↗	9.6 ↙	9.9 ↘
	10.7 *	10.3 *	9.6 ↖	9.6 ↘	10.4 *
beste Teiler	53.5 (6.)	136.1 (10.)	168.0 (7.)		
Trefferlage	0.58 mm links, 0.14 mm hoch				
Streuwert	2.02, horizontal: 2.20, vertikal: 1.83				

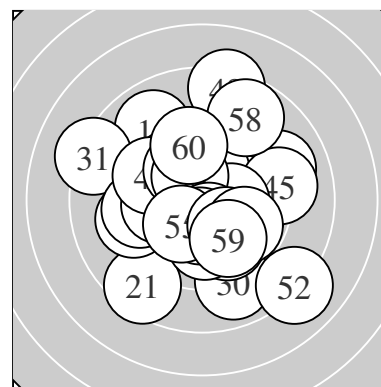
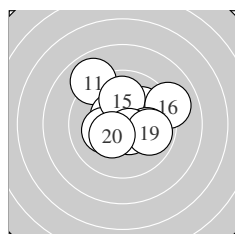

Serie 2:	8.9 ↘	10.5 *	10.2 *	10.0 ↗	10.0 ↑
	9.0 ↗	10.0 →	10.6 *	9.9 →	10.4 *
beste Teiler	96.3 (18.)	121.7 (12.)	146.3 (20.)		
Trefferlage	0.52 mm rechts, 0.68 mm hoch				
Streuwert	2.02, horizontal: 2.26, vertikal: 1.74				

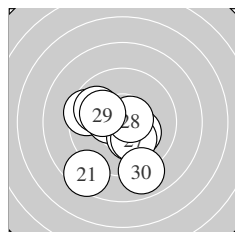

Serie 3:	8.5 ↙	9.5 ↖	10.2 *	9.8 ↖	10.5 *
	10.3 *	10.2 *	10.6 *	10.1 ↖	8.9 ↘
beste Teiler	79.7 (28.)	124.1 (25.)	163.2 (26.)		
Trefferlage	0.68 mm links, 1.03 mm tief				
Streuwert	2.17, horizontal: 2.09, vertikal: 2.25				

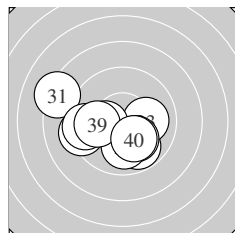

Serie 4:	8.2 ↖	9.8 ↘	10.0 →	10.3 *	10.1 ↘
	9.3 ↖	10.0 ↓	9.5 ↖	10.0 ↖	10.1 ↘
beste Teiler	172.2 (34.)	204.1 (40.)	214.4 (35.)		
Trefferlage	1.18 mm links, 0.79 mm tief				
Streuwert	2.29, horizontal: 2.88, vertikal: 1.48				

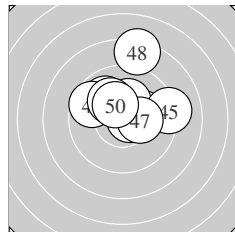

Serie 5:	10.7 *	9.9 ↘	10.2 *	10.2 *	9.1 →
	9.6 ↖	10.3 *	8.3 ↑	10.1 ↖	10.3 *
beste Teiler	68.1 (41.)	156.0 (50.)	169.3 (47.)		
Trefferlage	0.40 mm rechts, 1.60 mm hoch				
Streuwert	2.01, horizontal: 2.13, vertikal: 1.88				

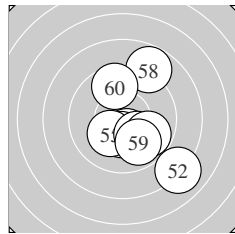

Serie 6:	10.4 *	8.0 ↘	10.0 ↘	10.3 *	10.2 *
	10.1 ↘	9.8 ↘	8.8 ↑	9.9 ↘	9.6 ↑
beste Teiler	130.2 (51.)	152.3 (54.)	185.1 (55.)		
Trefferlage	1.30 mm rechts, 0.84 mm tief				
Streuwert	2.40, horizontal: 1.92, vertikal: 2.79				

Meyton Elektronik

ISSF AR Women – Wertung – Frauen

StandNr: 104

Anlanger, Beatrice Carina #117

StartNr: 94

20. Januar 2020 13:04

OOE – SV Laakirchen

Unterschrift des Schützen

Meyton Elektronik

Ergebnis: **621.8** (593)
 Serien: 102.9 102.6 104.0 104.8 104.0 103.5
 Zähler: 53 7 0 0 0 0 0 0 0
 Innenzehner: 49
 weiteste: 341 (59), 281 (3), 278 (1)
 beste Teiler 22.6 (11.) 30.0 (35.) 34.9 (53.)
 Trefferlage 0.01 mm links, 0.40 mm hoch
 Streuwert 1.11, horizontal: 1.18, vertikal: 1.05

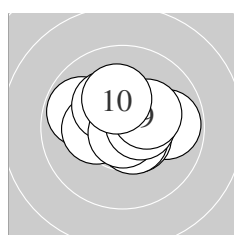
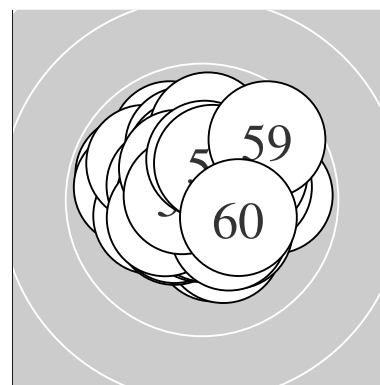

Serie 1:
 9.8 → 10.5 * 9.8 ↖ 10.3 * 10.5 *
 10.3 * 10.8 * 10.5 * 10.2 * 10.2 *
 beste Teiler 37.1 (7.) 101.3 (5.) 111.4 (2.)
 Trefferlage 0.13 mm rechts, 0.34 mm hoch
 Streuwert 1.30, horizontal: 1.61, vertikal: 0.88

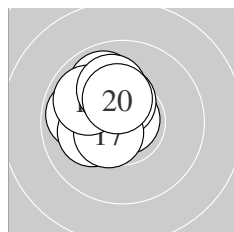

Serie 2:
 10.9 * 10.6 * 9.9 ↗ 10.4 * 9.9 ↖
 10.1 ← 10.5 * 9.9 ↘ 10.1 ↗ 10.3 *
 beste Teiler 22.6 (11.) 100.8 (12.) 112.8 (17.)
 Trefferlage 1.09 mm links, 0.82 mm hoch
 Streuwert 1.00, horizontal: 0.93, vertikal: 1.06

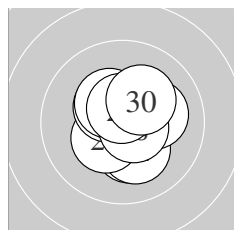

Serie 3:
 10.3 * 10.2 * 10.8 * 10.4 * 10.1 →
 10.4 * 10.4 * 10.6 * 10.6 * 10.2 *
 beste Teiler 42.1 (23.) 79.6 (28.) 88.2 (29.)
 Trefferlage 0.21 mm rechts, 0.02 mm tief
 Streuwert 1.09, horizontal: 1.00, vertikal: 1.18

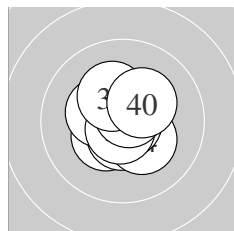

Serie 4:
 10.4 * 10.4 * 10.6 * 10.3 * 10.8 *
 10.3 * 10.7 * 10.7 * 10.3 * 10.3 *
 beste Teiler 30.0 (35.) 53.4 (37.) 67.2 (38.)
 Trefferlage 0.05 mm links, 0.15 mm hoch
 Streuwert 0.95, horizontal: 0.88, vertikal: 1.02

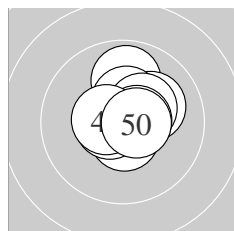

Serie 5:
 9.9 ↑ 10.6 * 10.6 * 10.4 * 10.1 →
 10.4 * 10.3 * 10.6 * 10.5 * 10.6 *
 beste Teiler 83.1 (43.) 88.2 (50.) 90.7 (42.)
 Trefferlage 0.40 mm rechts, 0.62 mm hoch
 Streuwert 0.94, horizontal: 0.88, vertikal: 1.00

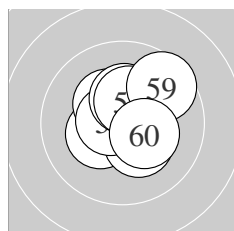

Serie 6:
 10.3 * 10.6 * 10.8 * 10.3 * 10.3 *
 10.6 * 10.3 * 10.4 * 9.6 ↗ 10.3 *
 beste Teiler 34.9 (53.) 78.6 (56.) 88.5 (52.)
 Trefferlage 0.30 mm rechts, 0.49 mm hoch
 Streuwert 1.16, horizontal: 1.17, vertikal: 1.15

Meyton Elektronik

ISSF AR Women – Wertung – Frauen

StandNr: 105

Kitzbichler, Jasmin #82

StartNr: 95

20. Januar 2020 13:42

T – SG Thierberg

Unterschrift des Schützen

Meyton Elektronik

Ergebnis: **628.6** (597)^{QF}
 Serien: 104.9 103.6 104.6 104.7 105.7 105.1
 Zähler: 57 3 0 0 0 0 0 0 0 0
 Innenzehner: 54
 weiteste: 328 (55), 307 (11), 273 (20)
 beste Teiler 7.0 (60.) 8.9 (57.) 13.6 (50.)
 Trefferlage 0.10 mm rechts, 0.04 mm hoch
 Streuwert 0.98, horizontal: 1.10, vertikal: 0.84

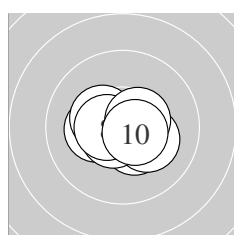
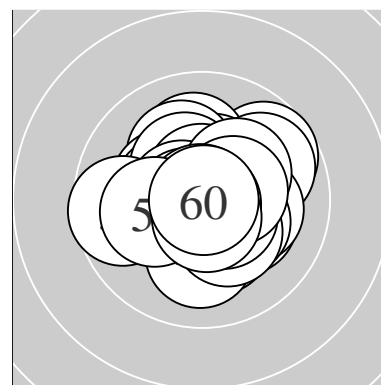

Serie 1:
 10.7 * 10.3 * 10.7 * 10.4 * 10.2 *
 10.4 * 10.6 * 10.5 * 10.5 * 10.6 *
 beste Teiler 56.7 (3.) 63.1 (1.) 83.6 (7.)
 Trefferlage 0.12 mm links, 0.23 mm tief
 Streuwert 0.90, horizontal: 1.15, vertikal: 0.53

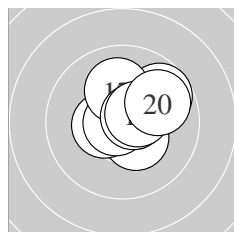

Serie 2:
 9.7 ↗ 10.6 * 10.4 * 10.5 * 10.5 *
 10.8 * 10.1 ↑ 10.6 * 10.5 * 9.9 ↘
 beste Teiler 46.2 (16.) 79.9 (12.) 81.8 (18.)
 Trefferlage 0.59 mm rechts, 0.55 mm hoch
 Streuwert 1.13, horizontal: 1.21, vertikal: 1.05

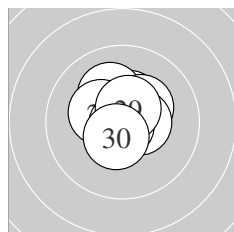

Serie 3:
 10.6 * 10.5 * 10.4 * 10.1 ↖ 10.3 *
 10.3 * 10.5 * 10.9 * 10.5 * 10.5 *
 beste Teiler 21.5 (28.) 79.6 (21.) 101.3 (29.)
 Trefferlage 0.04 mm rechts, 0.51 mm hoch
 Streuwert 0.87, horizontal: 0.92, vertikal: 0.82

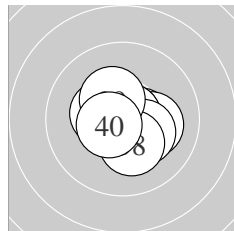

Serie 4:
 10.5 * 10.2 * 10.5 * 10.8 * 10.8 *
 10.4 * 10.3 * 10.3 * 10.3 * 10.6 *
 beste Teiler 42.1 (34.) 42.4 (35.) 100.3 (40.)
 Trefferlage 0.19 mm rechts, 0.09 mm tief
 Streuwert 0.98, horizontal: 1.12, vertikal: 0.81

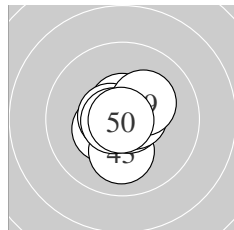

Serie 5:
 10.4 * 10.6 * 10.1 ↓ 10.8 * 10.8 *
 10.6 * 10.6 * 10.7 * 10.2 * 10.9 *
 beste Teiler 13.6 (50.) 42.9 (45.) 49.0 (44.)
 Trefferlage 0.02 mm rechts, 0.07 mm tief
 Streuwert 0.85, horizontal: 0.79, vertikal: 0.90

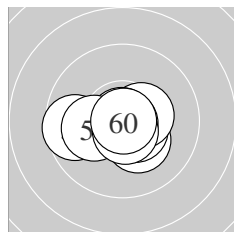

Serie 6:
 10.3 * 10.7 * 10.5 * 10.4 * 9.6 ←
 10.9 * 10.9 * 10.2 * 10.7 * 10.9 *
 beste Teiler 7.0 (60.) 8.9 (57.) 24.0 (56.)
 Trefferlage 0.12 mm links, 0.38 mm tief
 Streuwert 1.05, horizontal: 1.41, vertikal: 0.47

Meyton Elektronik

ISSF AR Women – Wertung – Frauen

StandNr: 106

Peer, Franziska #115

StartNr: 96

20. Januar 2020 13:29

AUT

QF – Schütze hat sich fürs Finale qualifiziert

Unterschrift des Schützen

Meyton Elektronik

Ergebnis:	630.1	(597) ^{QF}
Serien:	103.4	105.2 105.7 106.6 104.4 104.8
Zähler:	57	3 0 0 0 0 0 0 0 0
Innenzehner:	49	
weiteste:	297	(21), 270 (48), 253 (44)
beste Teiler	19.9	(29.) 20.1 (45.) 20.2 (31.)
Trefferlage	0.04	mm rechts, 0.13 mm tief
Streuwert	0.94,	horizontal: 0.94, vertikal: 0.94

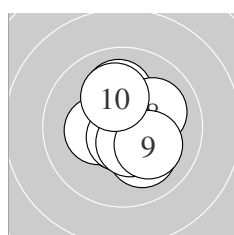
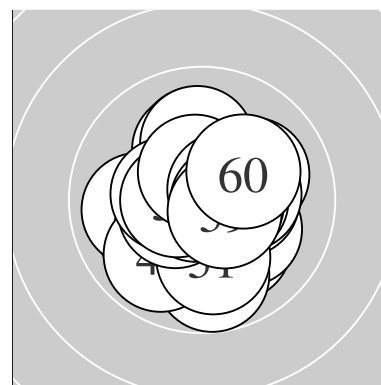

Serie 1:	10.1 ↘	10.7 *	10.7 *	10.3 *	10.7 *
	10.1 ↑	10.5 *	10.1 ↗	10.1 ↘	10.1 ↑
beste Teiler	55.6	(2.) 65.5 (3.)	67.4 (5.)		
Trefferlage	0.31	mm rechts, 0.03 mm tief			
Streuwert	1.22,	horizontal: 1.10, vertikal: 1.33			

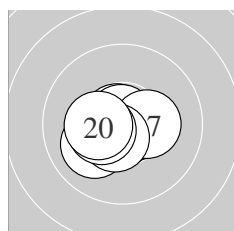

Serie 2:	10.1 ↙	10.7 *	10.6 *	10.7 *	10.8 *
	10.8 *	10.3 *	10.5 *	10.4 *	10.3 *
beste Teiler	36.4	(16.) 42.2 (15.)	53.2 (14.)		
Trefferlage	0.29	mm links, 0.26 mm tief			
Streuwert	0.86,	horizontal: 1.09, vertikal: 0.53			

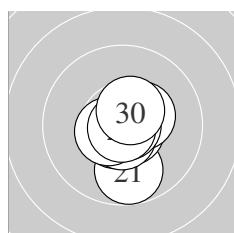

Serie 3:	9.8 ↓	10.7 *	10.7 *	10.6 *	10.4 *
	10.7 *	10.8 *	10.6 *	10.9 *	10.5 *
beste Teiler	19.9	(29.) 28.4 (27.)	57.2 (22.)		
Trefferlage	0.18	mm rechts, 0.33 mm tief			
Streuwert	0.86,	horizontal: 0.59, vertikal: 1.07			

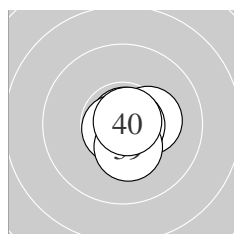

Serie 4:	10.9 *	10.7 *	10.3 *	10.7 *	10.7 *
	10.8 *	10.7 *	10.7 *	10.3 *	10.8 *
beste Teiler	20.2	(31.) 36.2 (40.)	44.0 (36.)		
Trefferlage	0.39	mm rechts, 0.24 mm tief			
Streuwert	0.54,	horizontal: 0.56, vertikal: 0.51			

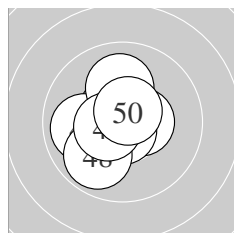

Serie 5:	10.7 *	10.6 *	10.5 *	9.9 ←	10.9 *
	10.1 ↑	10.7 *	9.9 ↙	10.5 *	10.6 *
beste Teiler	20.1	(45.) 54.0 (47.)	69.6 (41.)		
Trefferlage	0.44	mm links, 0.11 mm hoch			
Streuwert	1.09,	horizontal: 1.05, vertikal: 1.13			

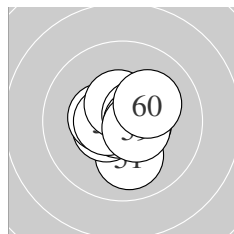

Serie 6:	10.0 ↓	10.5 *	10.8 *	10.4 *	10.6 *
	10.5 *	10.6 *	10.6 *	10.6 *	10.2 *
beste Teiler	29.8	(53.) 97.5 (57.)	98.0 (55.)		
Trefferlage	0.09	mm rechts, 0.05 mm tief			
Streuwert	0.99,	horizontal: 1.02, vertikal: 0.96			

ISSF AR Women – Wertung – Frauen

StandNr: 107

Moudgil, Anjum #462

StartNr: 97

20. Januar 2020 13:30

India

QF – Schütze hat sich fürs Finale qualifiziert

Unterschrift des Schützen

Meyton Elektronik

Ergebnis:	622.0	(591)					
Serien:	103.7	103.5	105.5	104.0	104.0	101.3	
Zähler:	51	9	0	0	0	0	0
Innenzehner:	49						
weiteste:	375 (56), 343 (20), 314 (9)						
beste Teiler	41.4 (45.) 42.2 (15.) 47.6 (29.)						
Trefferlage	0.04 mm rechts, 0.15 mm tief						
Streuwert	1.18, horizontal: 1.33, vertikal: 1.01						

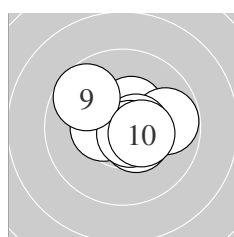
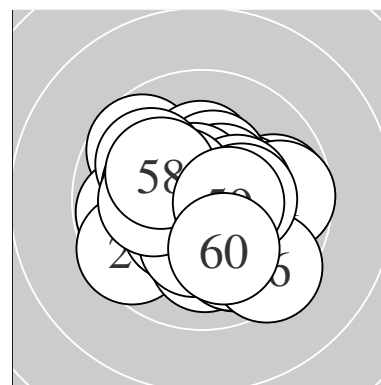

Serie 1:					
10.5 *	10.4 *	10.7 *	9.8 →	10.4 *	
10.5 *	10.6 *	10.7 *	9.7 ↖	10.4 *	
beste Teiler	55.4 (3.) 67.2 (8.) 90.0 (7.)				
Trefferlage	0.48 mm rechts, 0.17 mm hoch				
Streuwert	1.18, horizontal: 1.44, vertikal: 0.84				

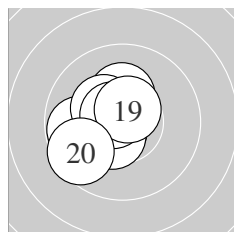

Serie 2:					
9.8 ←	10.4 *	10.3 *	10.3 *	10.8 *	
10.6 *	10.5 *	10.6 *	10.6 *	9.6 ↙	
beste Teiler	42.2 (15.) 78.6 (18.) 85.5 (16.)				
Trefferlage	0.99 mm links, 0.08 mm tief				
Streuwert	1.08, horizontal: 1.07, vertikal: 1.10				

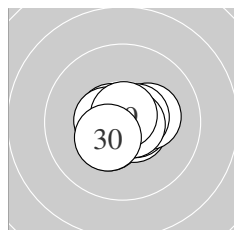

Serie 3:					
10.6 *	10.4 *	10.5 *	10.6 *	10.6 *	
10.3 *	10.6 *	10.7 *	10.8 *	10.4 *	
beste Teiler	47.6 (29.) 64.0 (28.) 82.3 (21.)				
Trefferlage	0.11 mm rechts, 0.12 mm tief				
Streuwert	0.80, horizontal: 0.98, vertikal: 0.56				

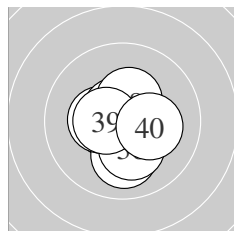

Serie 4:					
10.6 *	10.0 ↓	10.5 *	10.6 *	10.4 *	
10.2 *	10.6 *	10.4 *	10.5 *	10.2 *	
beste Teiler	80.1 (37.) 84.6 (34.) 89.1 (31.)				
Trefferlage	0.05 mm rechts, 0.37 mm tief				
Streuwert	1.04, horizontal: 1.01, vertikal: 1.06				

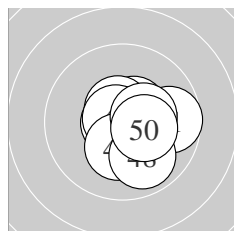

Serie 5:					
9.7 →	10.5 *	10.7 *	10.6 *	10.8 *	
10.7 *	10.3 *	9.9 ↘	10.4 *	10.4 *	
beste Teiler	41.4 (45.) 52.3 (46.) 58.3 (43.)				
Trefferlage	0.67 mm rechts, 0.18 mm tief				
Streuwert	1.10, horizontal: 1.18, vertikal: 1.02				

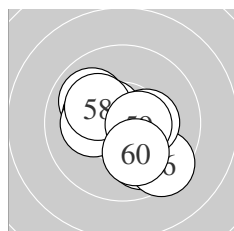

Serie 6:					
9.9 ↖	10.5 *	10.2 *	9.9 ↘	10.2 *	
9.5 ↘	10.3 *	10.2 *	10.5 *	10.1 ↘	
beste Teiler	107.5 (59.) 110.6 (52.) 159.0 (57.)				
Trefferlage	0.09 mm links, 0.32 mm tief				
Streuwert	1.61, horizontal: 1.75, vertikal: 1.46				

Meyton Elektronik

ISSF AR Women – Wertung – Frauen

StandNr: 108

Russo, Fernanda #428

StartNr: 98

20. Januar 2020 13:43

ARG

Unterschrift des Schützen

Meyton Elektronik

Ergebnis:	619.2	(590)					
Serien:	104.7	102.4	103.0	103.5	101.1	104.5	
Zähler:	50	10	0	0	0	0	0
Innenzehner:	44						
weiteste:	392 (15), 361 (51), 345 (44)						
beste Teiler	22.4 (2.) 27.2 (5.) 40.8 (58.)						
Trefferlage	0.29 mm rechts, 0.01 mm tief						
Streuwert	1.28, horizontal: 1.50, vertikal: 1.02						

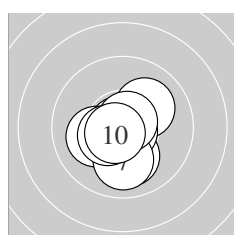
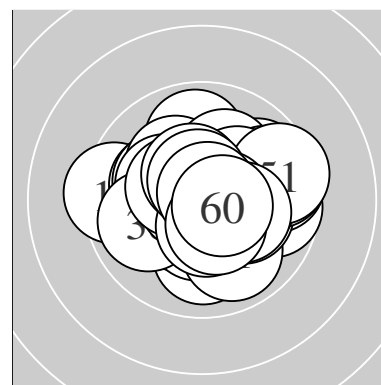

Serie 1:

10.1 ←	10.9 *	10.1 ↓	10.1 ↗	10.8 *
10.8 *	10.0 ↓	10.7 *	10.5 *	10.7 *
beste Teiler	22.4 (2.) 27.2 (5.) 45.3 (6.)			
Trefferlage	0.12 mm links, 0.48 mm tief			
Streuwert	1.05, horizontal: 0.97, vertikal: 1.12			

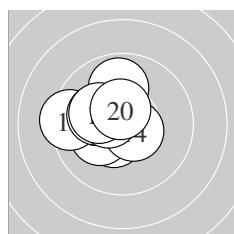

Serie 2:

10.4 *	10.5 *	10.2 *	10.6 *	9.4 ←
9.9 ↑	10.2 *	10.5 *	10.2 *	10.5 *
beste Teiler	95.1 (14.) 111.1 (20.) 115.4 (18.)			
Trefferlage	1.15 mm links, 0.44 mm hoch			
Streuwert	1.17, horizontal: 1.27, vertikal: 1.06			

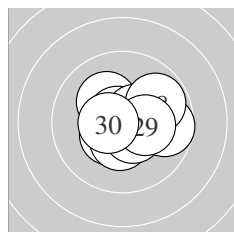

Serie 3:

10.2 *	10.4 *	10.4 *	10.7 *	10.5 *
10.5 *	9.7 →	9.8 ↗	10.3 *	10.5 *
beste Teiler	56.5 (24.) 106.2 (30.) 110.2 (25.)			
Trefferlage	0.51 mm rechts, 0.01 mm hoch			
Streuwert	1.27, horizontal: 1.52, vertikal: 0.95			

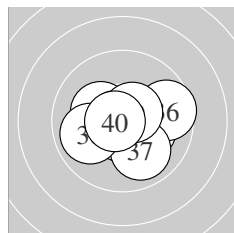

Serie 4:

10.2 *	10.3 *	10.8 *	10.8 *	10.6 *
9.6 →	10.0 ↓	9.9 ←	10.6 *	10.7 *
beste Teiler	43.1 (34.) 48.8 (33.) 57.0 (40.)			
Trefferlage	0.22 mm rechts, 0.27 mm tief			
Streuwert	1.32, horizontal: 1.64, vertikal: 0.90			

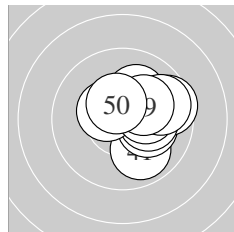

Serie 5:

9.9 ↓	10.2 *	10.1 ↗	9.6 →	10.2 *
10.4 *	10.2 *	9.8 →	10.2 *	10.5 *
beste Teiler	123.8 (50.) 131.0 (46.) 176.8 (47.)			
Trefferlage	1.38 mm rechts, 0.40 mm hoch			
Streuwert	1.26, horizontal: 1.35, vertikal: 1.15			

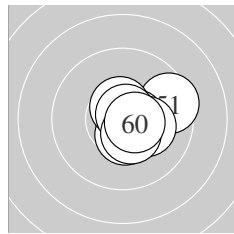

Serie 6:

9.5 →	10.6 *	10.5 *	10.5 *	10.7 *
10.6 *	10.2 *	10.8 *	10.5 *	10.6 *
beste Teiler	40.8 (58.) 72.4 (55.) 91.0 (52.)			
Trefferlage	0.93 mm rechts, 0.17 mm tief			
Streuwert	0.91, horizontal: 1.02, vertikal: 0.78			

Meyton Elektronik

ISSF AR Women – Wertung – Frauen

StandNr: 109

Goldfaden, Ella #336

StartNr: 99

20. Januar 2020 13:38

Israel

Unterschrift des Schützen

Meyton Elektronik

Ergebnis: **586.8** (562)

Serien: 96.3 97.1 99.8 98.0 97.9 97.7

Zähler: 26 30 4 0 0 0 0 0 0 0

Innenzehner: 15

weiteste: 587 (17), 572 (9), 506 (6)

beste Teiler 89.2 (21.) 98.4 (10.) 115.1 (23.)

Trefferlage 1.00 mm rechts, 0.20 mm hoch

Streuwert 2.14, horizontal: 2.39, vertikal: 1.86

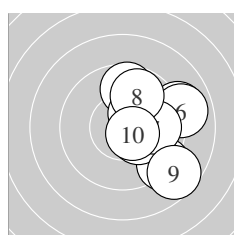
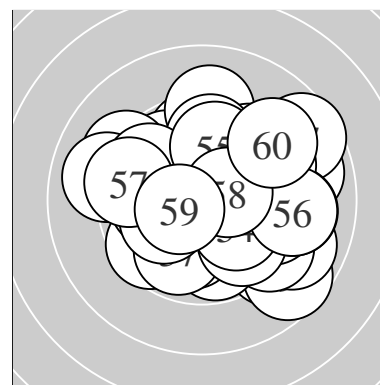

Serie 1:

9.7 ↑	10.3 *	9.1 ↘	10.3 *	9.0 →
8.9 →	9.9 →	9.8 ↑	8.7 ↘	10.6 *

beste Teiler 98.4 (10.) 153.7 (2.) 158.6 (4.)

Trefferlage 2.46 mm rechts, 0.16 mm hoch

Streuwert 2.03, horizontal: 1.72, vertikal: 2.29

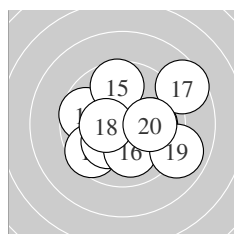

Serie 2:

9.7 ←	9.6 ↙	10.0 →	10.2 *	9.7 ↑
10.0 ↓	8.6 ↗	10.4 *	8.9 ↘	10.0 →

beste Teiler 138.4 (18.) 191.6 (14.) 227.7 (16.)

Trefferlage 0.60 mm rechts, 0.12 mm tief

Streuwert 2.47, horizontal: 2.84, vertikal: 2.04

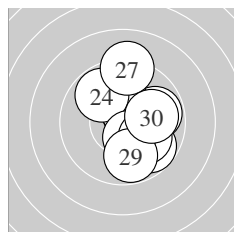

Serie 3:

10.6 *	9.8 →	10.5 *	9.8 ↘	9.8 ↘
10.4 *	9.1 ↑	10.0 ↘	9.8 ↓	10.0 →

beste Teiler 89.2 (21.) 115.1 (23.) 139.6 (26.)

Trefferlage 1.00 mm rechts, 0.24 mm hoch

Streuwert 1.80, horizontal: 1.34, vertikal: 2.16

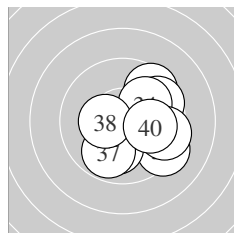

Serie 4:

9.6 ↗	9.8 ↘	9.6 ↗	10.0 ↗	9.3 ↘
10.0 ↓	9.8 ↙	10.4 *	9.5 →	10.0 →

beste Teiler 145.0 (38.) 226.1 (36.) 234.9 (40.)

Trefferlage 1.57 mm rechts, 0.42 mm tief

Streuwert 1.84, horizontal: 1.88, vertikal: 1.79

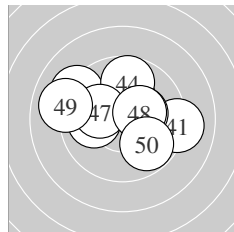

Serie 5:

9.1 →	9.2 ↘	10.3 *	9.7 ↑	10.3 *
10.0 ←	10.2 *	10.3 *	9.0 ←	9.8 ↘

beste Teiler 152.2 (48.) 161.9 (45.) 164.1 (43.)

Trefferlage 0.22 mm links, 0.68 mm hoch

Streuwert 2.29, horizontal: 2.90, vertikal: 1.45

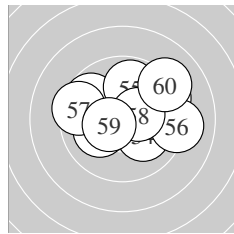

Serie 6:

9.7 ↘	10.1 ←	9.4 ↗	10.1 ↘	9.9 ↑
9.1 →	9.4 ←	10.4 *	10.5 *	9.1 ↗

beste Teiler 122.3 (59.) 134.4 (58.) 212.4 (52.)

Trefferlage 0.58 mm rechts, 0.68 mm hoch

Streuwert 2.26, horizontal: 2.83, vertikal: 1.50

ISSF AR Women – Wertung – Frauen

StandNr: 110

Moser, Arinette #463

StartNr: 100

20. Januar 2020 13:28

LIE

Unterschrift des Schützen

Meyton Elektronik

Ergebnis: **625.7** (597)

Serien: 105.2 104.0 105.7 103.2 103.2 104.4

Zähler: 57 3 0 0 0 0 0 0 0 0

Innenzehner: 49

weiteste: 297 (43), 273 (19), 260 (32)

beste Teiler 27.0 (23.) 30.5 (3.) 33.1 (41.)

Trefferlage 0.07 mm rechts, 0.45 mm hoch

Streuwert 1.00, horizontal: 1.07, vertikal: 0.94

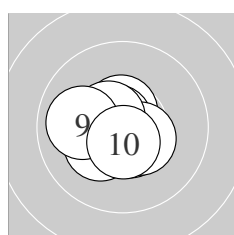
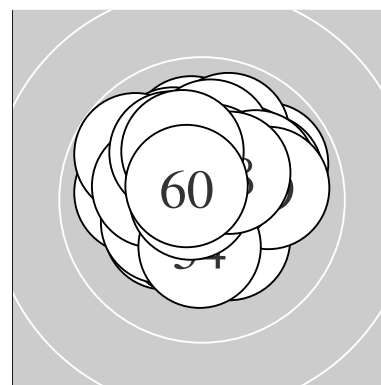

Serie 1:

10.6 *	10.6 *	10.8 *	10.6 *	10.3 *
10.7 *	10.5 *	10.5 *	10.0 ←	10.6 *

beste Teiler 30.5 (3.) 56.7 (6.) 86.4 (2.)

Trefferlage 0.32 mm links, 0.24 mm tief

Streuwert 0.88, horizontal: 1.01, vertikal: 0.73

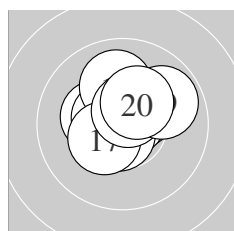

Serie 2:

10.3 *	10.6 *	10.0 ↑	10.5 *	10.7 *
10.7 *	10.4 *	10.6 *	9.9 ↗	10.3 *

beste Teiler 52.2 (15.) 67.7 (16.) 88.3 (18.)

Trefferlage 0.07 mm rechts, 0.62 mm hoch

Streuwert 1.06, horizontal: 1.17, vertikal: 0.93

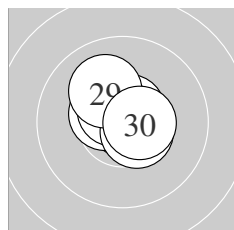

Serie 3:

10.7 *	10.7 *	10.8 *	10.7 *	10.5 *
10.6 *	10.6 *	10.5 *	10.1 ↖	10.5 *

beste Teiler 27.0 (23.) 52.4 (22.) 61.9 (24.)

Trefferlage 0.10 mm rechts, 0.45 mm hoch

Streuwert 0.70, horizontal: 0.74, vertikal: 0.65

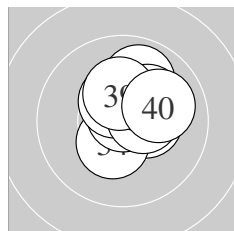

Serie 4:

10.4 *	9.9 ↑	10.4 *	10.4 *	10.2 *
10.8 *	10.4 *	10.4 *	10.3 *	10.0 →

beste Teiler 36.2 (36.) 127.2 (33.) 128.6 (38.)

Trefferlage 0.70 mm rechts, 0.76 mm hoch

Streuwert 0.98, horizontal: 0.95, vertikal: 1.02

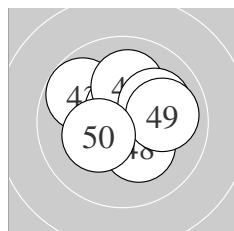

Serie 5:

10.8 *	10.5 *	9.8 ↖	10.6 *	10.7 *
10.1 ↑	10.1 ↗	10.3 *	10.0 →	10.3 *

beste Teiler 33.1 (41.) 57.7 (45.) 77.2 (44.)

Trefferlage 0.23 mm rechts, 0.55 mm hoch

Streuwert 1.28, horizontal: 1.45, vertikal: 1.08

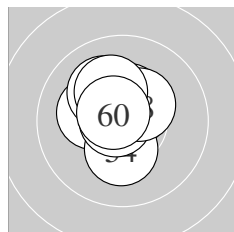

Serie 6:

10.7 *	10.2 *	10.7 *	10.3 *	10.4 *
10.8 *	10.1 ↖	10.4 *	10.2 *	10.6 *

beste Teiler 42.2 (56.) 71.7 (53.) 71.8 (51.)

Trefferlage 0.36 mm links, 0.59 mm hoch

Streuwert 0.92, horizontal: 0.82, vertikal: 1.01

ISSF AR Women – Wertung – Frauen

StandNr: 111

Ser, Xiang Wei Jasmine #464

StartNr: 101

20. Januar 2020 13:43

SGP

Unterschrift des Schützen

Meyton Elektronik

Ergebnis:	623.9	(594)
Serien:	102.8	105.4 104.1 103.5 104.9 103.2
Zähler:	54	6 0 0 0 0 0 0 0 0
Innenzehner:	46	
weiteste:	301	(6), 298 (54), 282 (22)
beste Teiler	22.8	(15.) 23.0 (44.) 28.2 (18.)
Trefferlage	0.00 mm , 0.06 mm hoch	
Streuwert	1.13, horizontal: 1.19, vertikal: 1.07	

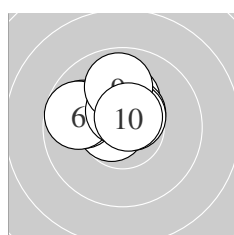
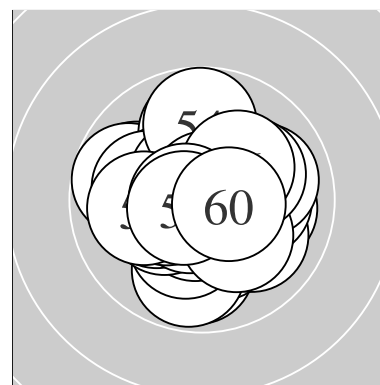

Serie 1:	10.2 *	10.2 *	10.7 *	10.5 *	9.9 ↖
	9.7 ↖	10.6 *	10.5 *	9.9 ↑	10.6 *
beste Teiler	72.0 (3.) 77.0 (10.) 92.9 (7.)				
Trefferlage	0.51 mm links, 1.14 mm hoch				
Streuwert	1.04, horizontal: 1.25, vertikal: 0.77				

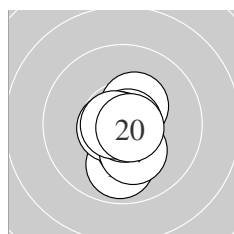

Serie 2:	10.4 *	9.9 ↓	10.8 *	10.4 *	10.9 *
	10.6 *	10.2 *	10.8 *	10.7 *	10.7 *
beste Teiler	22.8 (15.) 28.2 (18.) 35.6 (13.)				
Trefferlage	0.12 mm rechts, 0.54 mm tief				
Streuwert	0.86, horizontal: 0.53, vertikal: 1.09				

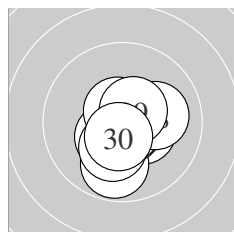

Serie 3:	10.4 *	9.8 ↓	10.4 *	10.7 *	10.2 *
	10.8 *	10.6 *	10.1 →	10.5 *	10.6 *
beste Teiler	50.9 (26.) 59.2 (24.) 79.6 (27.)				
Trefferlage	0.21 mm rechts, 0.58 mm tief				
Streuwert	1.03, horizontal: 0.96, vertikal: 1.10				

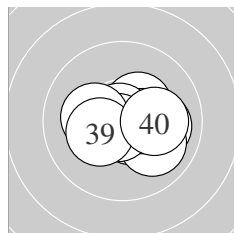

Serie 4:	10.4 *	10.4 *	10.6 *	10.8 *	10.0 →
	10.0 ↘	10.7 *	10.2 *	10.3 *	10.1 →
beste Teiler	32.0 (34.) 53.6 (37.) 83.6 (33.)				
Trefferlage	0.54 mm rechts, 0.21 mm tief				
Streuwert	1.14, horizontal: 1.47, vertikal: 0.65				

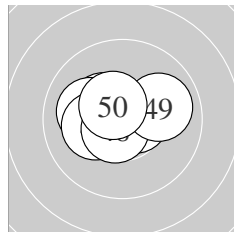

Serie 5:	10.4 *	10.8 *	10.6 *	10.9 *	10.1 ↖
	10.2 *	10.8 *	10.6 *	10.0 →	10.5 *
beste Teiler	23.0 (44.) 50.0 (42.) 50.2 (47.)				
Trefferlage	0.39 mm links, 0.24 mm hoch				
Streuwert	0.99, horizontal: 1.29, vertikal: 0.53				

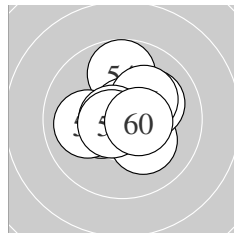

Serie 6:	10.2 *	10.1 ↗	10.4 *	9.8 ↑	10.7 *
	10.2 *	10.0 ↖	10.7 *	10.6 *	10.5 *
beste Teiler	51.6 (55.) 66.0 (58.) 78.7 (59.)				
Trefferlage	0.07 mm rechts, 0.31 mm hoch				
Streuwert	1.29, horizontal: 1.36, vertikal: 1.21				

Meyton Elektronik

ISSF AR Women – Wertung – Frauen

StandNr: 112

Tzabach,, Kim #465

StartNr: 102

20. Januar 2020 13:43

GBR

Unterschrift des Schützen

Meyton Elektronik

Ergebnis: **624.3** (595)
 Serien: 102.0 103.9 104.5 104.4 104.7 104.8
 Zähler: 55 5 0 0 0 0 0 0 0 0
 Innenzehner: 52
 weiteste: 449 (1), 400 (19), 303 (6)
 beste Teiler 18.0 (60.) 30.5 (46.) 31.6 (12.)
 Trefferlage 0.29 mm links, 0.03 mm tief
 Streuwert 1.11, horizontal: 1.30, vertikal: 0.89

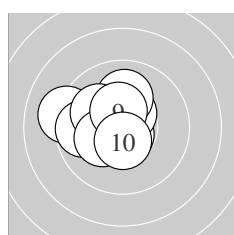
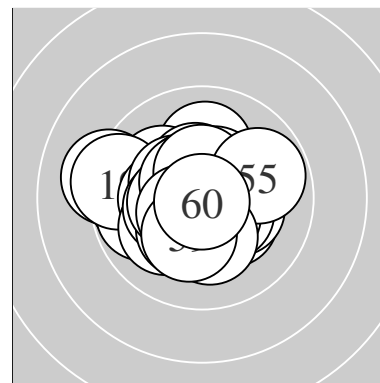

Serie 1:
 9.2 ← 10.7 * 10.7 * 10.5 * 10.0 ↑
 9.7 ← 10.1 ↖ 10.2 * 10.4 * 10.5 *
 beste Teiler 55.4 (3.) 62.0 (2.) 107.0 (10.)
 Trefferlage 1.06 mm links, 0.45 mm hoch
 Streuwert 1.37, horizontal: 1.61, vertikal: 1.08

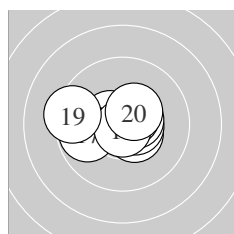

Serie 2:
 10.5 * 10.8 * 10.6 * 10.5 * 10.6 *
 10.5 * 9.8 ← 10.8 * 9.4 ← 10.4 *
 beste Teiler 31.6 (12.) 33.0 (18.) 86.4 (15.)
 Trefferlage 0.35 mm links, 0.11 mm hoch
 Streuwert 1.29, horizontal: 1.73, vertikal: 0.59

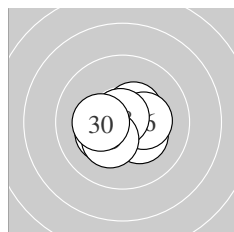

Serie 3:
 10.5 * 10.5 * 10.5 * 10.3 * 10.3 *
 10.3 * 10.7 * 10.8 * 10.3 * 10.3 *
 beste Teiler 41.2 (28.) 66.1 (27.) 112.3 (21.)
 Trefferlage 0.09 mm rechts, 0.13 mm tief
 Streuwert 1.02, horizontal: 1.24, vertikal: 0.72

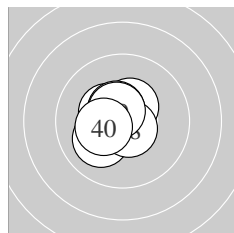

Serie 4:
 10.2 * 10.4 * 10.7 * 10.1 ↙ 10.4 *
 10.6 * 10.5 * 10.6 * 10.6 * 10.3 *
 beste Teiler 53.2 (33.) 76.0 (38.) 92.7 (39.)
 Trefferlage 0.67 mm links, 0.11 mm hoch
 Streuwert 0.86, horizontal: 0.81, vertikal: 0.91

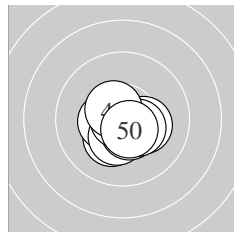

Serie 5:
 10.5 * 10.3 * 10.4 * 10.4 * 10.5 *
 10.8 * 10.3 * 10.4 * 10.5 * 10.6 *
 beste Teiler 30.5 (46.) 95.9 (50.) 103.2 (49.)
 Trefferlage 0.04 mm links, 0.61 mm tief
 Streuwert 0.82, horizontal: 0.96, vertikal: 0.66

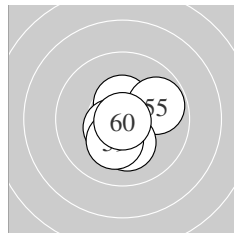

Serie 6:
 10.8 * 10.6 * 10.6 * 10.5 * 9.8 →
 10.7 * 10.5 * 10.2 * 10.2 * 10.9 *
 beste Teiler 18.0 (60.) 34.7 (51.) 53.4 (56.)
 Trefferlage 0.27 mm rechts, 0.13 mm tief
 Streuwert 1.01, horizontal: 0.95, vertikal: 1.06

Meyton Elektronik

ISSF AR Women – Wertung – Frauen

StandNr: 113

Höbl, Sabrina #466

StartNr: 103

20. Januar 2020 13:42

GER

Unterschrift des Schützen

Meyton Elektronik

Ergebnis:	566.6	(543)
Serien:	93.4 95.1 94.3 95.4 94.5 93.9	
Zähler:	18 29 11 2 0 0 0 0 0 0	
Innenzehner:	10	
weiteste:	886 (50), 762 (38), 692 (56)	
beste Teiler	67.3 (32.) 85.5 (34.) 132.2 (41.)	
Trefferlage	0.04 mm links, 0.15 mm hoch	
Streuwert	2.94, horizontal: 3.49, vertikal: 2.27	

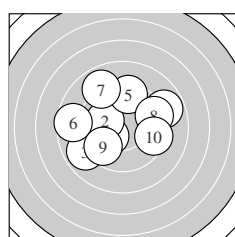
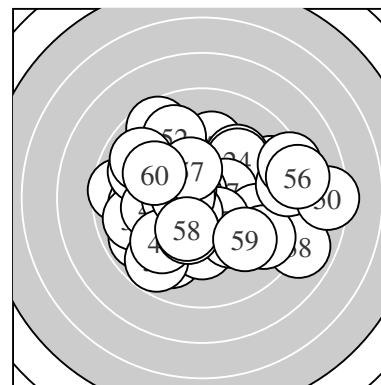

Serie 1:	10.2 *	10.1 ↖	8.9 ↙	8.8 →	9.4 ↑
	8.6 ←	8.9 ↘	9.4 →	9.7 ↙	9.4 →
beste Teiler	183.9 (1.) 221.5 (2.) 321.7 (9.)				
Trefferlage	0.56 mm links, 0.60 mm hoch				
Streuwert	3.10, horizontal: 3.64, vertikal: 2.44				

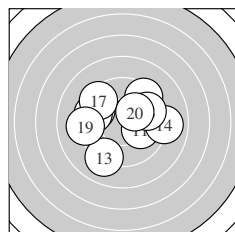

Serie 2:	10.0 →	9.6 ↖	9.1 ↙	9.0 →	9.4 ↗
	9.5 ←	9.4 ↘	9.7 →	9.2 ←	10.2 *
beste Teiler	188.0 (20.) 228.2 (11.) 316.0 (18.)				
Trefferlage	0.22 mm links, 0.45 mm hoch				
Streuwert	2.74, horizontal: 3.31, vertikal: 2.03				

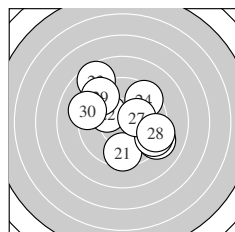

Serie 3:	9.5 ↓	10.1 ↖	8.6 ↘	9.5 ↗	9.1 ↘
	9.3 →	10.3 *	9.3 →	9.4 ↘	9.2 ←
beste Teiler	175.2 (27.) 211.4 (22.) 351.0 (21.)				
Trefferlage	0.40 mm rechts, 0.48 mm hoch				
Streuwert	2.91, horizontal: 3.15, vertikal: 2.64				

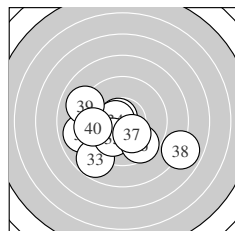

Serie 4:	9.0 ←	10.7 *	8.8 ↙	10.6 *	10.1 ↙
	9.6 ↘	10.2 *	7.9 →	9.0 ↖	9.5 ←
beste Teiler	67.3 (32.) 85.5 (34.) 183.8 (37.)				
Trefferlage	0.84 mm links, 1.35 mm tief				
Streuwert	2.82, horizontal: 3.52, vertikal: 1.88				

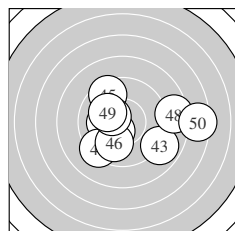

Serie 5:	10.4 *	10.1 ←	8.9 ↘	9.3 ↙	9.5 ↘
	9.9 ↙	10.4 *	8.5 →	10.1 ↖	7.4 →
beste Teiler	132.2 (41.) 140.0 (47.) 201.1 (42.)				
Trefferlage	0.79 mm rechts, 0.34 mm tief				
Streuwert	3.21, horizontal: 4.07, vertikal: 2.00				

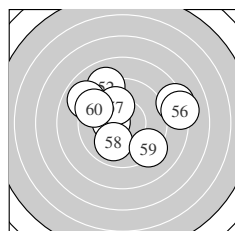

Serie 6:	8.3 →	9.1 ↘	10.2 *	10.4 *	8.9 ↘
	8.2 →	10.1 ↘	10.0 ↙	9.3 ↘	9.4 ↘
beste Teiler	135.2 (54.) 184.6 (53.) 219.3 (57.)				
Trefferlage	0.16 mm rechts, 1.07 mm hoch				
Streuwert	3.13, horizontal: 3.83, vertikal: 2.22				

Meyton Elektronik

ISSF AR Women – Wertung – Frauen

StandNr: 114

Haindl, Marlies #113

StartNr: 104

20. Januar 2020 13:41

Steiermark

Unterschrift des Schützen

Meyton Elektronik

Ergebnis: **612.9** (585)
 Serien: 101.5 102.2 98.6 103.5 103.0 104.1
 Zähler: 45 15 0 0 0 0 0 0 0
 Innenzehner: 37
 weiteste: 485 (6), 450 (22), 383 (26)
 beste Teiler 14.2 (40.) 36.1 (32.) 39.2 (60.)
 Trefferlage 0.28 mm links, 0.33 mm hoch
 Streuwert 1.45, horizontal: 1.69, vertikal: 1.17

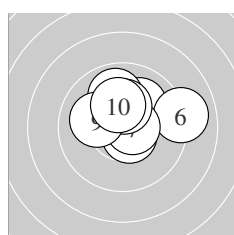
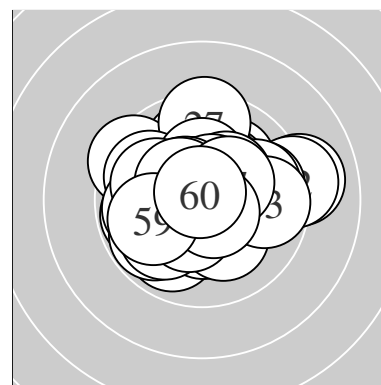

Serie 1:
 10.4 * 10.1 ↗ 10.3 * 9.9 ↑ 10.6 *
 9.0 → 10.6 * 10.3 * 10.1 ← 10.2 *
 beste Teiler 81.0 (7.) 88.2 (5.) 137.5 (1.)
 Trefferlage 0.27 mm rechts, 1.07 mm hoch
 Streuwert 1.49, horizontal: 1.88, vertikal: 0.96

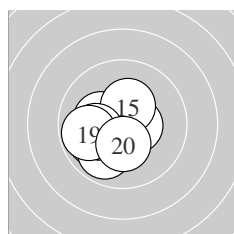

Serie 2:
 10.7 * 10.5 * 10.2 * 10.5 * 10.3 *
 9.9 ↙ 10.1 ← 9.9 ↘ 9.8 ← 10.3 *
 beste Teiler 70.1 (11.) 104.5 (14.) 116.7 (12.)
 Trefferlage 1.02 mm links, 0.57 mm tief
 Streuwert 1.15, horizontal: 1.26, vertikal: 1.04

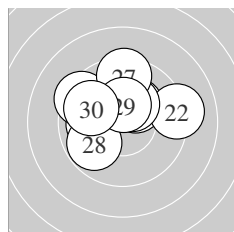

Serie 3:
 10.3 * 9.2 → 10.3 * 10.0 ↘ 10.0 ←
 9.4 ↖ 9.4 ↑ 9.8 ↙ 10.4 * 9.8 ↖
 beste Teiler 140.2 (29.) 165.9 (23.) 172.4 (21.)
 Trefferlage 0.62 mm links, 1.13 mm hoch
 Streuwert 1.94, horizontal: 2.37, vertikal: 1.39

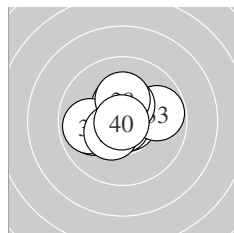

Serie 4:
 10.7 * 10.8 * 9.8 → 10.4 * 10.0 ←
 10.4 * 9.9 ← 10.2 * 10.4 * 10.9 *
 beste Teiler 14.2 (40.) 36.1 (32.) 55.6 (31.)
 Trefferlage 0.25 mm links, 0.24 mm hoch
 Streuwert 1.26, horizontal: 1.52, vertikal: 0.93

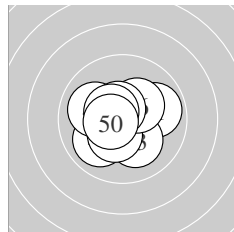

Serie 5:
 9.9 → 10.0 ↙ 10.2 * 10.4 * 10.5 *
 10.3 * 10.0 ↖ 10.6 * 10.5 * 10.6 *
 beste Teiler 90.8 (48.) 99.4 (50.) 108.1 (45.)
 Trefferlage 0.30 mm links, 0.02 mm tief
 Streuwert 1.31, horizontal: 1.48, vertikal: 1.11

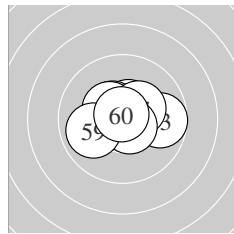

Serie 6:
 10.6 * 10.8 * 9.7 → 10.5 * 10.5 *
 10.4 * 10.3 * 10.6 * 9.9 ← 10.8 *
 beste Teiler 39.2 (60.) 43.8 (52.) 82.7 (58.)
 Trefferlage 0.21 mm rechts, 0.15 mm hoch
 Streuwert 1.15, horizontal: 1.46, vertikal: 0.70

Meyton Elektronik

ISSF AR Women – Wertung – Frauen

StandNr: 115

Hofstetter, Vanessa #467

StartNr: 105

20. Januar 2020 13:35

SUI

Unterschrift des Schützen

Meyton Elektronik

Ergebnis: **630.1** (597)^{QF}
 Serien: 106.1 104.1 104.4 105.2 106.0 104.3
 Zähler: 57 3 0 0 0 0 0 0 0 0
 Innenzehner: 55
 weiteste: 291 (53), 269 (49), 260 (26)
 beste Teiler 17.8 (45.) 23.0 (59.) 28.6 (29.)
 Trefferlage 0.24 mm rechts, 0.04 mm hoch
 Streuwert 0.90, horizontal: 1.06, vertikal: 0.71

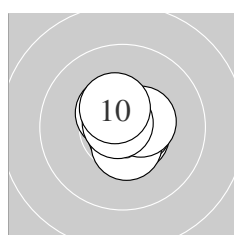
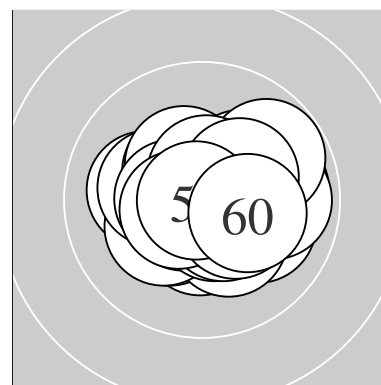

Serie 1:
 10.6 * 10.5 * 10.6 * 10.8 * 10.7 *
 10.5 * 10.7 * 10.5 * 10.8 * 10.4 *
 beste Teiler 33.0 (4.) 40.4 (9.) 56.0 (7.)
 Trefferlage 0.17 mm rechts, 0.06 mm hoch
 Streuwert 0.66, horizontal: 0.60, vertikal: 0.72

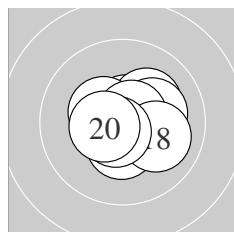

Serie 2:
 10.4 * 10.6 * 10.2 * 10.2 * 10.4 *
 10.4 * 10.7 * 10.0 ↘ 10.7 * 10.5 *
 beste Teiler 69.4 (17.) 74.6 (19.) 77.6 (12.)
 Trefferlage 0.45 mm rechts, 0.09 mm hoch
 Streuwert 1.03, horizontal: 1.19, vertikal: 0.84

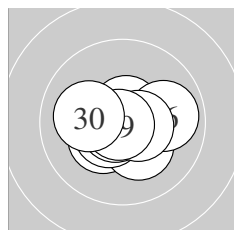

Serie 3:
 10.7 * 10.6 * 10.3 * 10.3 * 10.5 *
 9.9 → 10.7 * 10.5 * 10.8 * 10.1 ←
 beste Teiler 28.6 (29.) 54.9 (27.) 73.3 (21.)
 Trefferlage 0.03 mm rechts, 0.29 mm tief
 Streuwert 1.05, horizontal: 1.33, vertikal: 0.66

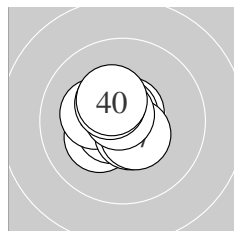

Serie 4:
 10.2 * 10.7 * 10.6 * 10.8 * 10.2 *
 10.6 * 10.5 * 10.8 * 10.4 * 10.4 *
 beste Teiler 45.0 (34.) 47.0 (38.) 65.8 (32.)
 Trefferlage 0.39 mm links, 0.11 mm hoch
 Streuwert 0.83, horizontal: 0.83, vertikal: 0.83

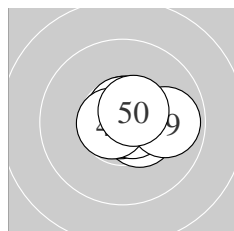

Serie 5:
 10.6 * 10.7 * 10.5 * 10.7 * 10.9 *
 10.7 * 10.7 * 10.7 * 9.9 → 10.6 *
 beste Teiler 17.8 (45.) 54.3 (42.) 63.0 (46.)
 Trefferlage 0.47 mm rechts, 0.13 mm hoch
 Streuwert 0.76, horizontal: 0.98, vertikal: 0.43

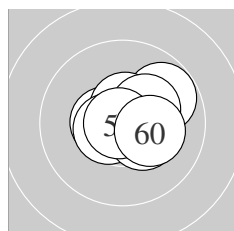

Serie 6:
 10.5 * 10.5 * 9.8 ↗ 10.5 * 10.6 *
 10.3 * 10.6 * 10.4 * 10.9 * 10.2 *
 beste Teiler 23.0 (59.) 96.3 (57.) 98.3 (55.)
 Trefferlage 0.69 mm rechts, 0.14 mm hoch
 Streuwert 0.98, horizontal: 1.16, vertikal: 0.75

Meyton Elektronik

ISSF AR Women – Wertung – Frauen

StandNr: 116

Chandela, Apurvi #468

StartNr: 106

20. Januar 2020 13:28

IND

QF – Schütze hat sich fürs Finale qualifiziert

Unterschrift des Schützen

Meyton Elektronik

Ergebnis:	619.7	(589)						
Serien:	104.7	100.9	105.0	104.0	102.8	102.3		
Zähler:	49	11	0	0	0	0	0	0
Innenzehner:	43							
weiteste:	349 (58), 326 (11), 311 (20)							
beste Teiler	29.6 (46.) 30.1 (21.) 39.2 (29.)							
Trefferlage	0.11 mm links, 0.11 mm hoch							
Streuwert	1.26, horizontal: 1.51, vertikal: 0.94							

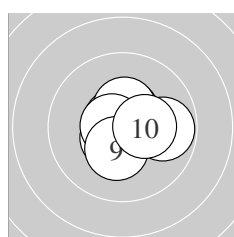
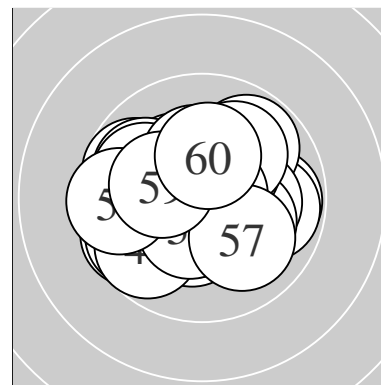

Serie 1:	10.5 *	10.8 *	10.5 *	9.8 →	10.7 *
	10.7 *	10.4 *	10.7 *	10.3 *	10.3 *
beste Teiler	49.4 (2.) 64.4 (5.) 67.8 (6.)				
Trefferlage	0.18 mm rechts, 0.11 mm hoch				
Streuwert	1.00, horizontal: 1.16, vertikal: 0.81				

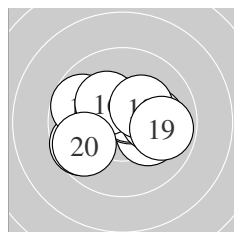

Serie 2:	9.6 ↙	9.7 ↖	10.2 *	10.6 *	10.6 *
	10.3 *	10.1 →	10.3 *	9.8 →	9.7 ↙
beste Teiler	88.2 (14.) 97.2 (15.) 169.1 (18.)				
Trefferlage	0.05 mm links, 0.09 mm hoch				
Streuwert	1.72, horizontal: 2.17, vertikal: 1.10				

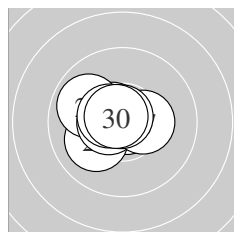

Serie 3:	10.8 *	10.1 ↙	10.6 *	10.6 *	9.9 ↖
	10.6 *	10.4 *	10.5 *	10.8 *	10.7 *
beste Teiler	30.1 (21.) 39.2 (29.) 60.9 (30.)				
Trefferlage	0.66 mm links, 0.19 mm hoch				
Streuwert	0.87, horizontal: 1.07, vertikal: 0.61				

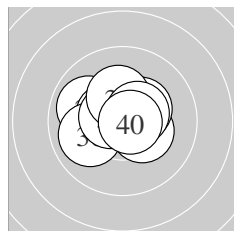

Serie 4:	10.8 *	9.9 ↖	10.5 *	10.3 *	10.4 *
	10.0 ↙	10.6 *	10.3 *	10.5 *	10.7 *
beste Teiler	45.2 (31.) 54.5 (40.) 90.4 (37.)				
Trefferlage	0.24 mm links, 0.33 mm hoch				
Streuwert	1.12, horizontal: 1.38, vertikal: 0.77				

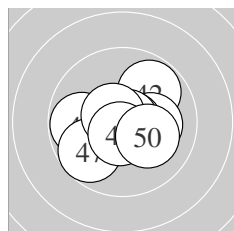

Serie 5:	10.5 *	9.8 ↗	10.2 *	9.8 ←	10.7 *
	10.8 *	9.7 ↙	10.6 *	10.6 *	10.1 ↘
beste Teiler	29.6 (46.) 55.9 (45.) 83.2 (48.)				
Trefferlage	0.15 mm rechts, 0.12 mm tief				
Streuwert	1.42, horizontal: 1.70, vertikal: 1.07				

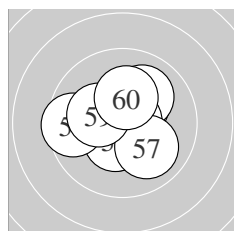

Serie 6:	10.4 *	10.5 *	10.3 *	10.0 ↗	10.7 *
	10.4 *	10.0 ↘	9.6 ←	10.2 *	10.2 *
beste Teiler	54.5 (55.) 118.5 (52.) 127.6 (56.)				
Trefferlage	0.04 mm links, 0.04 mm hoch				
Streuwert	1.44, horizontal: 1.57, vertikal: 1.30				

Meyton Elektronik

ISSF AR Women – Wertung – Frauen

StandNr: 117

Züger, Muriel #420

StartNr: 107

20. Januar 2020 13:45

SUI

Unterschrift des Schützen

Meyton Elektronik

Ergebnis:	625.6	(596)				
Serien:	104.3	104.4	104.3	103.3	104.0	105.3
Zähler:	56	4	0	0	0	0
Innenzehner:	48					
weiteste:	320 (31), 295 (24), 274 (10)					
beste Teiler	25.0 (57.) 30.4 (58.) 35.6 (7.)					
Trefferlage	0.07 mm links, 0.31 mm hoch					
Streuwert	1.04, horizontal: 1.09, vertikal: 1.00					

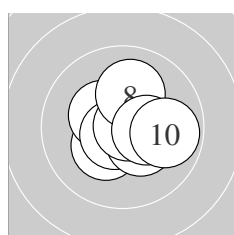
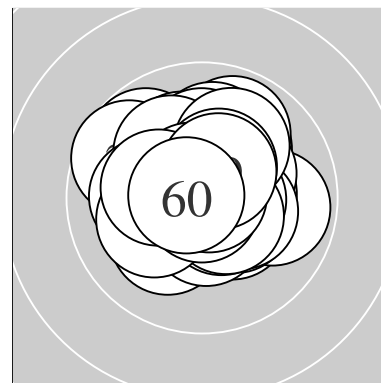

Serie 1:	10.7 *	10.7 *	10.3 *	10.4 *	10.7 *
	10.4 *	10.8 *	10.1 ↑	10.3 *	9.9 →
beste Teiler	35.6 (7.) 58.0 (1.) 65.9 (2.)				
Trefferlage	0.30 mm rechts, 0.00 mm				
Streuwert	1.11, horizontal: 1.24, vertikal: 0.96				

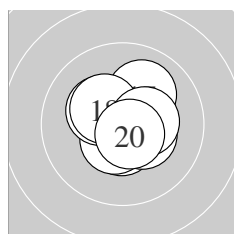

Serie 2:	10.5 *	10.5 *	10.4 *	10.3 *	10.8 *
	10.6 *	10.0 ↗	10.3 *	10.4 *	10.6 *
beste Teiler	44.5 (15.) 78.8 (20.) 90.7 (16.)				
Trefferlage	0.17 mm rechts, 0.16 mm hoch				
Streuwert	0.99, horizontal: 0.99, vertikal: 1.00				

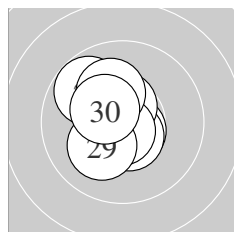

Serie 3:	10.6 *	10.6 *	10.7 *	9.8 ↘	10.7 *
	10.5 *	10.7 *	10.1 ↘	10.2 *	10.4 *
beste Teiler	56.0 (25.) 57.4 (27.) 62.0 (23.)				
Trefferlage	0.53 mm links, 0.22 mm hoch				
Streuwert	1.03, horizontal: 0.84, vertikal: 1.19				

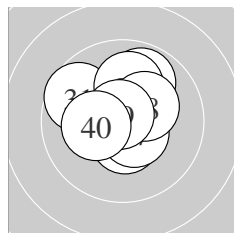

Serie 4:	9.7 ↙	10.5 *	10.6 *	10.7 *	9.9 ↗
	10.0 ↑	10.5 *	10.3 *	10.8 *	10.3 *
beste Teiler	46.9 (39.) 69.1 (34.) 77.7 (33.)				
Trefferlage	0.07 mm links, 0.54 mm hoch				
Streuwert	1.28, horizontal: 1.34, vertikal: 1.23				

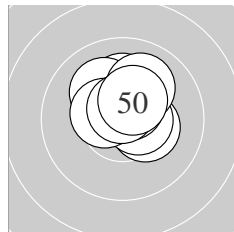

Serie 5:	10.2 *	10.7 *	10.3 *	10.1 ↘	10.5 *
	10.6 *	10.5 *	10.0 ↑	10.7 *	10.4 *
beste Teiler	53.1 (42.) 67.3 (49.) 98.3 (46.)				
Trefferlage	0.24 mm rechts, 0.87 mm hoch				
Streuwert	0.88, horizontal: 0.90, vertikal: 0.86				

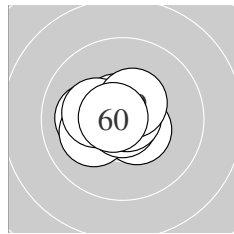

Serie 6:	10.5 *	10.1 ←	10.8 *	10.6 *	10.1 ←
	10.3 *	10.9 *	10.8 *	10.5 *	10.7 *
beste Teiler	25.0 (57.) 30.4 (58.) 50.0 (53.)				
Trefferlage	0.53 mm links, 0.06 mm hoch				
Streuwert	0.85, horizontal: 1.05, vertikal: 0.57				

Meyton Elektronik

ISSF AR Women – Wertung – Frauen

StandNr: 118

Köck, Rebecca #44

StartNr: 108

20. Januar 2020 13:48

AUT

Unterschrift des Schützen

Meyton Elektronik

Ergebnis: **622.2** (596)
 Serien: 102.6 104.1 103.2 104.7 105.1 102.5
 Zähler: 56 4 0 0 0 0 0 0 0
 Innenzehner: 47
 weiteste: 320 (31), 303 (58), 274 (7)
 beste Teiler 31.3 (37.) 37.0 (42.) 40.3 (53.)
 Trefferlage 0.11 mm rechts, 0.00 mm
 Streuwert 1.15, horizontal: 1.27, vertikal: 1.02

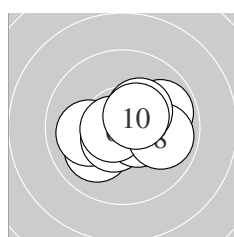
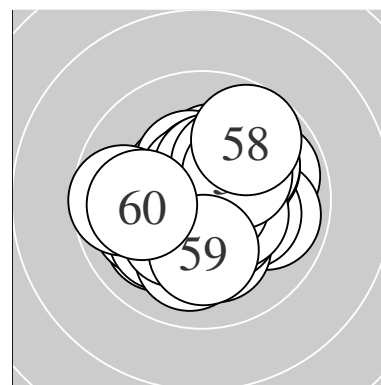

Serie 1:
 10.0 ↙ 10.0 ← 10.2 * 10.6 * 10.5 *
 10.7 * 9.9 → 9.9 → 10.3 * 10.5 *
 beste Teiler 66.2 (6.) 100.0 (4.) 113.2 (5.)
 Trefferlage 0.47 mm rechts, 0.02 mm tief
 Streuwert 1.36, horizontal: 1.71, vertikal: 0.88

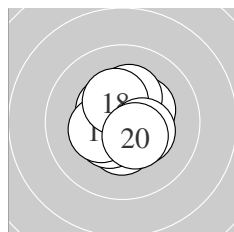

Serie 2:
 10.4 * 10.5 * 10.3 * 10.5 * 10.3 *
 10.5 * 10.3 * 10.4 * 10.4 * 10.5 *
 beste Teiler 121.4 (16.) 125.1 (12.) 125.3 (14.)
 Trefferlage 0.00 mm , 0.16 mm hoch
 Streuwert 1.05, horizontal: 0.97, vertikal: 1.13

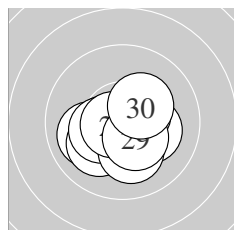

Serie 3:
 10.0 ↙ 10.2 * 10.1 ↙ 10.5 * 10.3 *
 10.2 * 10.5 * 10.7 * 10.4 * 10.3 *
 beste Teiler 65.5 (28.) 116.7 (27.) 125.0 (24.)
 Trefferlage 0.15 mm links, 0.53 mm tief
 Streuwert 1.18, horizontal: 1.41, vertikal: 0.88

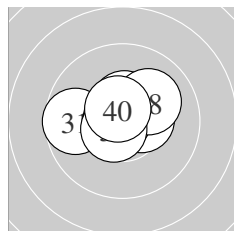

Serie 4:
 9.7 ← 10.4 * 10.8 * 10.4 * 10.5 *
 10.8 * 10.8 * 10.1 ↗ 10.6 * 10.6 *
 beste Teiler 31.3 (37.) 41.7 (33.) 45.2 (36.)
 Trefferlage 0.09 mm links, 0.38 mm hoch
 Streuwert 1.06, horizontal: 1.38, vertikal: 0.58

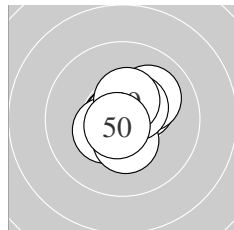

Serie 5:
 10.8 * 10.8 * 10.4 * 10.3 * 10.4 *
 10.7 * 10.1 ↗ 10.5 * 10.4 * 10.7 *
 beste Teiler 37.0 (42.) 50.2 (41.) 58.8 (50.)
 Trefferlage 0.23 mm rechts, 0.21 mm hoch
 Streuwert 0.90, horizontal: 0.88, vertikal: 0.92

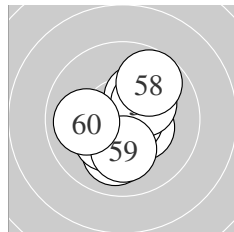

Serie 6:
 10.4 * 10.7 * 10.8 * 10.3 * 10.0 ↓
 10.3 * 10.2 * 9.7 ↗ 10.1 ↓ 10.0 ←
 beste Teiler 40.3 (53.) 51.4 (52.) 140.1 (51.)
 Trefferlage 0.19 mm rechts, 0.19 mm tief
 Streuwert 1.40, horizontal: 1.30, vertikal: 1.50

Meyton Elektronik

ISSF AR Women – Wertung – Frauen

StandNr: 119

Mazurova, Nikola #415

StartNr: 109

20. Januar 2020 13:45

CZE

Unterschrift des Schützen

Meyton Elektronik

Ergebnis:	630.2	(599) ^{QF}						
Serien:	104.4	105.0	106.0	105.0	105.3	104.5		
Zähler:	59	1	0	0	0	0	0	0
Innenzehner:	57							
weiteste:	310 (1),	232 (46),	220 (16)					
beste Teiler	3.0 (39.)	25.7 (41.)	26.9 (38.)					
Trefferlage	0.21 mm links, 0.20 mm tief							
Streuwert	0.86, horizontal: 0.86, vertikal: 0.87							

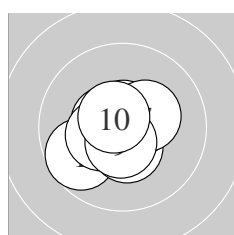
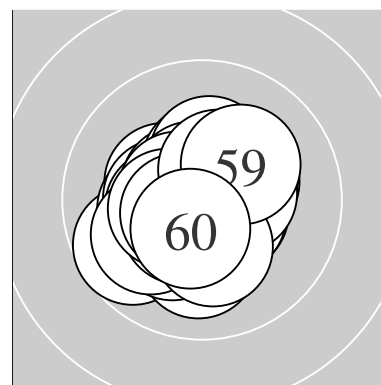

Serie 1:	9.7 ↙	10.7 *	10.4 *	10.7 *	10.5 *
	10.5 *	10.3 *	10.4 *	10.6 *	10.6 *
beste Teiler	59.1 (2.) 69.1 (4.) 83.6 (10.)				
Trefferlage	0.28 mm links, 0.21 mm tief				
Streuwert	1.03, horizontal: 1.16, vertikal: 0.89				

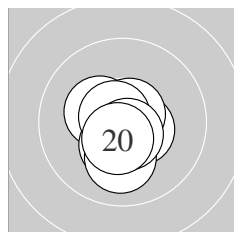

Serie 2:	10.3 *	10.7 *	10.5 *	10.5 *	10.4 *
	10.1 ↓	10.7 *	10.7 *	10.6 *	10.5 *
beste Teiler	54.3 (12.) 61.2 (18.) 65.9 (17.)				
Trefferlage	0.14 mm links, 0.60 mm tief				
Streuwert	0.79, horizontal: 0.65, vertikal: 0.91				

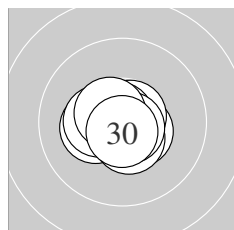

Serie 3:	10.8 *	10.5 *	10.3 *	10.7 *	10.4 *
	10.5 *	10.8 *	10.7 *	10.6 *	10.7 *
beste Teiler	36.4 (21.) 39.6 (27.) 51.6 (28.)				
Trefferlage	0.21 mm links, 0.19 mm tief				
Streuwert	0.70, horizontal: 0.86, vertikal: 0.49				

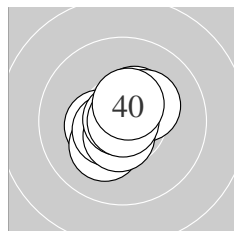

Serie 4:	10.4 *	10.4 *	10.4 *	10.2 *	10.5 *
	10.3 *	10.6 *	10.8 *	10.9 *	10.5 *
beste Teiler	3.0 (39.) 26.9 (38.) 94.8 (37.)				
Trefferlage	0.27 mm links, 0.04 mm tief				
Streuwert	0.91, horizontal: 0.92, vertikal: 0.90				

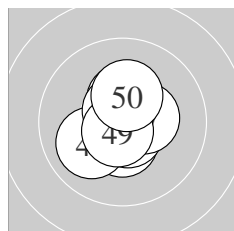

Serie 5:	10.9 *	10.8 *	10.5 *	10.4 *	10.7 *
	10.0 ↙	10.4 *	10.6 *	10.7 *	10.3 *
beste Teiler	25.7 (41.) 31.2 (42.) 64.4 (49.)				
Trefferlage	0.06 mm links, 0.00 mm				
Streuwert	0.91, horizontal: 0.81, vertikal: 1.00				

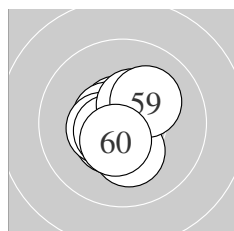

Serie 6:	10.2 *	10.6 *	10.5 *	10.5 *	10.6 *
	10.4 *	10.6 *	10.4 *	10.2 *	10.5 *
beste Teiler	78.2 (52.) 95.5 (55.) 96.3 (57.)				
Trefferlage	0.30 mm links, 0.17 mm tief				
Streuwert	0.94, horizontal: 0.86, vertikal: 1.01				

Meyton Elektronik

ISSF AR Women – Wertung – Frauen

StandNr: 120

Simon, Julia #405

StartNr: 110

20. Januar 2020 13:47

GER

QF – Schütze hat sich fürs Finale qualifiziert

Unterschrift des Schützen

Meyton Elektronik

Ergebnis: **616.3** (587)
 Serien: 101.4 102.0 101.0 104.3 104.3 103.3
 Zähler: 47 13 0 0 0 0 0 0 0
 Innenzehner: 38
 weiteste: 463 (22), 315 (51), 312 (6)
 beste Teiler 16.4 (35.) 39.5 (49.) 43.0 (36.)
 Trefferlage 0.00 mm , 0.21 mm tief
 Streuwert 1.36, horizontal: 1.52, vertikal: 1.19

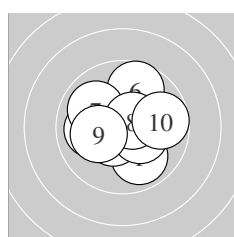
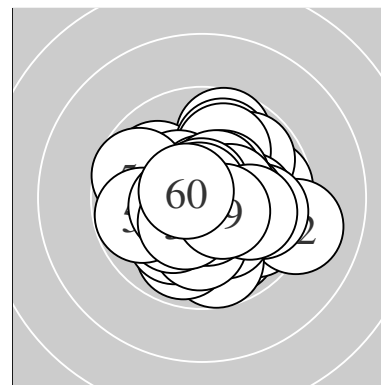

Serie 1:
 9.9 ↘ 10.5 * 10.5 * 10.0 ← 10.4 *
 9.7 ↑ 9.9 ↙ 10.6 * 10.2 * 9.7 →
 beste Teiler 92.3 (8.) 110.4 (2.) 120.7 (3.)
 Trefferlage 0.01 mm links, 0.20 mm hoch
 Streuwert 1.62, horizontal: 1.78, vertikal: 1.43

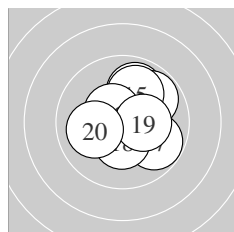

Serie 2:
 9.9 ↑ 10.6 * 10.7 * 9.8 ↗ 10.0 ↑
 10.5 * 9.8 ↘ 10.4 * 10.3 * 10.0 ←
 beste Teiler 55.4 (13.) 81.8 (12.) 112.4 (16.)
 Trefferlage 0.51 mm rechts, 0.39 mm hoch
 Streuwert 1.43, horizontal: 1.42, vertikal: 1.45

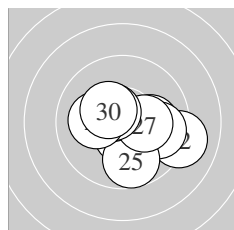

Serie 3:
 10.1 → 9.1 → 9.8 → 10.5 * 9.7 ↓
 10.5 * 10.3 * 10.5 * 10.1 ← 10.4 *
 beste Teiler 103.0 (24.) 111.0 (28.) 115.0 (26.)
 Trefferlage 0.68 mm rechts, 0.35 mm tief
 Streuwert 1.67, horizontal: 2.04, vertikal: 1.19

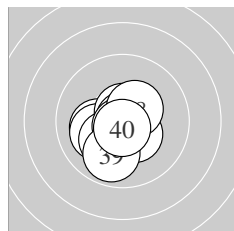

Serie 4:
 10.2 * 10.1 ← 10.2 * 10.7 * 10.9 *
 10.8 * 10.4 * 10.4 * 9.9 ↓ 10.7 *
 beste Teiler 16.4 (35.) 43.0 (36.) 54.1 (40.)
 Trefferlage 0.41 mm links, 0.55 mm tief
 Streuwert 1.03, horizontal: 1.04, vertikal: 1.02

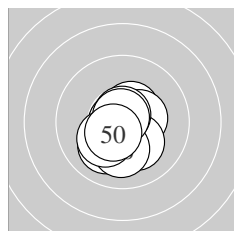

Serie 5:
 10.5 * 10.4 * 10.1 ↗ 10.2 * 10.8 *
 10.1 ↓ 10.2 * 10.7 * 10.8 * 10.5 *
 beste Teiler 39.5 (49.) 45.0 (45.) 57.0 (48.)
 Trefferlage 0.11 mm links, 0.54 mm tief
 Streuwert 1.02, horizontal: 0.91, vertikal: 1.11

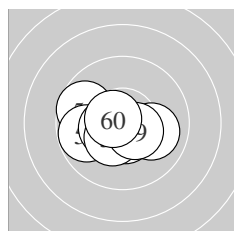

Serie 6:
 9.7 ↙ 9.8 ← 10.7 * 10.4 * 10.6 *
 10.0 → 10.6 * 10.4 * 10.5 * 10.6 *
 beste Teiler 73.2 (53.) 77.1 (57.) 81.5 (60.)
 Trefferlage 0.61 mm links, 0.42 mm tief
 Streuwert 1.21, horizontal: 1.57, vertikal: 0.65

Meyton Elektronik

ISSF AR Women – Wertung – Frauen

StandNr: 121

Martinez, Gabriela #469

StartNr: 111

20. Januar 2020 13:19

MEX

Unterschrift des Schützen

Meyton Elektronik

Ergebnis:	623.8	(595)					
Serien:	102.7	104.4	103.0	105.4	105.0	103.3	
Zähler:	55	5	0	0	0	0	0
Innenzehner:	50						
weiteste:	327 (23), 321 (10), 295 (11)						
beste Teiler	35.3 (43.) 41.4 (33.) 45.0 (20.)						
Trefferlage	0.03 mm rechts, 0.29 mm hoch						
Streuwert	1.09, horizontal: 1.16, vertikal: 1.02						

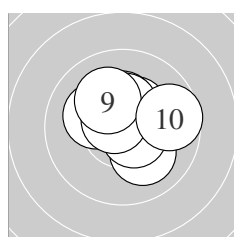
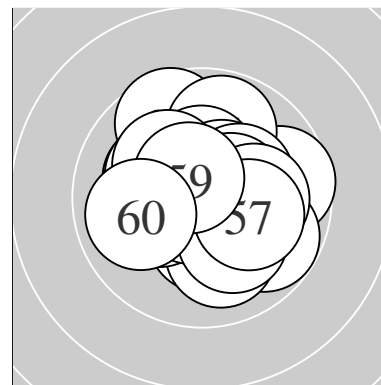

Serie 1:	10.2 *	10.1 ↘	10.4 *	10.3 *	10.6 *
	10.4 *	10.2 *	10.7 *	10.1 ↖	9.7 →
beste Teiler	72.3 (8.) 91.8 (5.) 140.6 (6.)				
Trefferlage	0.19 mm rechts, 0.73 mm hoch				
Streuwert	1.27, horizontal: 1.42, vertikal: 1.10				

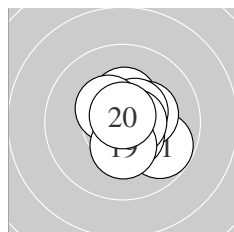

Serie 2:	9.8 ↘	10.4 *	10.3 *	10.5 *	10.7 *
	10.5 *	10.4 *	10.7 *	10.3 *	10.8 *
beste Teiler	45.0 (20.) 66.0 (15.) 73.0 (18.)				
Trefferlage	0.49 mm rechts, 0.06 mm hoch				
Streuwert	1.02, horizontal: 0.99, vertikal: 1.04				

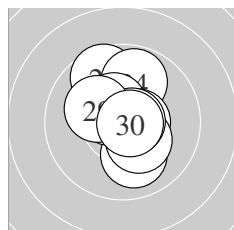

Serie 3:	10.0 ↘	10.5 *	9.6 ↖	9.8 ↑	10.5 *
	10.6 *	10.3 *	10.7 *	10.2 *	10.8 *
beste Teiler	50.8 (30.) 63.1 (28.) 98.0 (26.)				
Trefferlage	0.03 mm rechts, 0.49 mm hoch				
Streuwert	1.33, horizontal: 1.03, vertikal: 1.58				

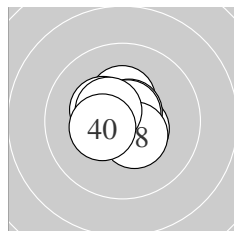

Serie 4:	10.4 *	10.5 *	10.8 *	10.6 *	10.3 *
	10.7 *	10.7 *	10.5 *	10.5 *	10.4 *
beste Teiler	41.4 (33.) 62.4 (37.) 72.2 (36.)				
Trefferlage	0.20 mm links, 0.31 mm hoch				
Streuwert	0.79, horizontal: 0.84, vertikal: 0.73				

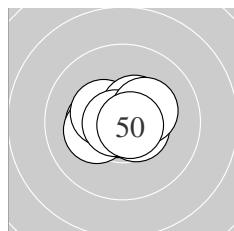

Serie 5:	10.3 *	10.5 *	10.8 *	10.2 *	10.5 *
	10.4 *	10.5 *	10.8 *	10.3 *	10.7 *
beste Teiler	35.3 (43.) 48.6 (48.) 55.1 (50.)				
Trefferlage	0.26 mm links, 0.12 mm hoch				
Streuwert	0.88, horizontal: 1.14, vertikal: 0.52				

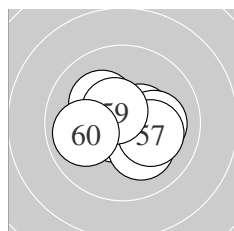

Serie 6:	10.7 *	10.6 *	10.1 ↘	10.5 *	10.1 →
	10.4 *	10.2 *	10.2 *	10.6 *	9.9 ←
beste Teiler	59.4 (51.) 79.5 (52.) 97.3 (59.)				
Trefferlage	0.03 mm links, 0.02 mm hoch				
Streuwert	1.26, horizontal: 1.55, vertikal: 0.88				

Meyton Elektronik

ISSF AR Women – Wertung – Frauen

StandNr: 122

Hofmann, Olivia #30

StartNr: 112

20. Januar 2020 13:47

AUT

Unterschrift des Schützen

Meyton Elektronik

Ergebnis:	622.1	(592)					
Serien:	103.6	103.5	101.5	104.0	104.9	104.6	
Zähler:	52	8	0	0	0	0	0
Innenzehner:	49						
weiteste:	353 (21), 324 (34), 314 (56)						
beste Teiler	10.2 (31.) 40.0 (42.) 50.4 (54.)						
Trefferlage	0.12 mm rechts, 0.03 mm hoch						
Streuwert	1.16, horizontal: 1.39, vertikal: 0.87						

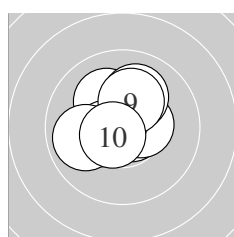
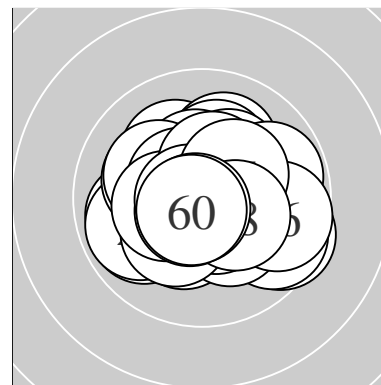

Serie 1:

10.7 *	10.4 *	10.6 *	10.1 ↘	10.5 *
10.5 *	9.9 ←	10.1 ↑	10.2 *	10.6 *
beste Teiler	59.8 (1.) 86.2 (10.) 88.1 (3.)			
Trefferlage	0.38 mm links, 0.43 mm hoch			
Streuwert	1.13, horizontal: 1.18, vertikal: 1.07			

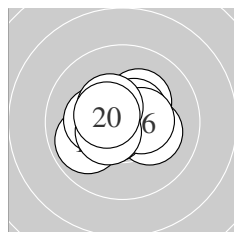

Serie 2:

10.2 *	10.6 *	10.3 *	10.5 *	9.9 ←
10.4 *	10.2 *	10.4 *	10.5 *	10.5 *
beste Teiler	82.4 (12.) 105.4 (14.) 116.7 (19.)			
Trefferlage	0.27 mm links, 0.08 mm hoch			
Streuwert	1.16, horizontal: 1.41, vertikal: 0.84			

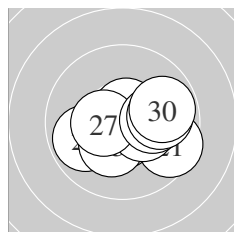

Serie 3:

9.5 ↘	10.6 *	9.9 ←	10.6 *	10.3 *
10.4 *	10.4 *	10.1 →	9.9 →	9.8 →
beste Teiler	77.7 (24.) 90.0 (22.) 128.1 (27.)			
Trefferlage	0.75 mm rechts, 0.33 mm tief			
Streuwert	1.49, horizontal: 1.91, vertikal: 0.88			

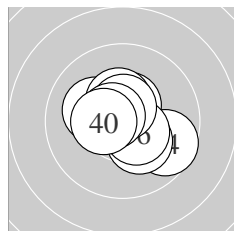

Serie 4:

10.9 *	10.2 *	10.5 *	9.7 ↘	10.2 *
10.5 *	10.4 *	10.6 *	10.6 *	10.4 *
beste Teiler	10.2 (31.) 79.1 (39.) 93.1 (38.)			
Trefferlage	0.12 mm rechts, 0.09 mm hoch			
Streuwert	1.18, horizontal: 1.34, vertikal: 1.00			

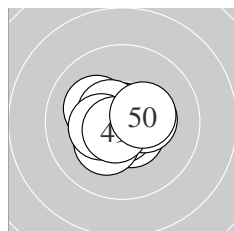

Serie 5:

10.5 *	10.8 *	10.2 *	10.7 *	10.5 *
10.3 *	10.4 *	10.4 *	10.7 *	10.4 *
beste Teiler	40.0 (42.) 54.7 (44.) 72.8 (49.)			
Trefferlage	0.23 mm links, 0.10 mm tief			
Streuwert	0.94, horizontal: 1.11, vertikal: 0.73			

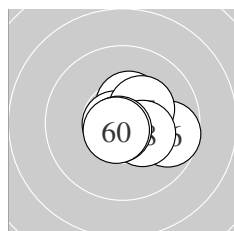

Serie 6:

10.4 *	10.7 *	10.5 *	10.8 *	10.5 *
9.7 →	10.3 *	10.3 *	10.7 *	10.7 *
beste Teiler	50.4 (54.) 51.3 (59.) 65.1 (60.)			
Trefferlage	0.75 mm rechts, 0.04 mm hoch			
Streuwert	0.90, horizontal: 1.07, vertikal: 0.68			

Meyton Elektronik

ISSF AR Women – Wertung – Frauen

StandNr: 123

Leone, Chiara #426

StartNr: 113

20. Januar 2020 13:35

SUI

Unterschrift des Schützen

Meyton Elektronik

Ergebnis: **627.4** (598)
 Serien: 104.9 105.7 104.7 105.3 104.7 102.1
 Zähler: 58 2 0 0 0 0 0 0 0 0
 Innenzehner: 55
 weiteste: 270 (59), 269 (30), 245 (13)
 beste Teiler 12.8 (5.) 20.5 (1.) 32.2 (21.)
 Trefferlage 0.20 mm links, 0.05 mm tief
 Streuwert 0.99, horizontal: 1.08, vertikal: 0.89

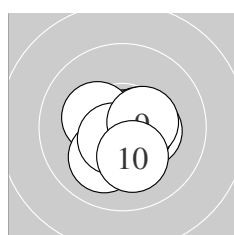
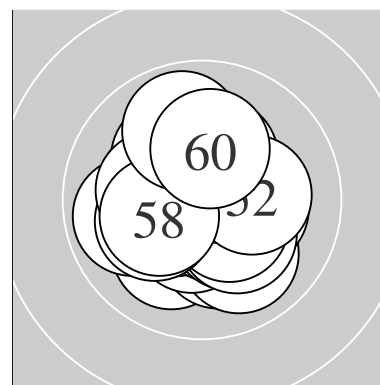

Serie 1:
 10.9 * 10.4 * 10.6 * 10.5 * 10.9 *
 10.3 * 10.1 ↙ 10.6 * 10.4 * 10.2 *
 beste Teiler 12.8 (5.) 20.5 (1.) 93.4 (3.)
 Trefferlage 0.20 mm rechts, 0.37 mm tief
 Streuwert 0.96, horizontal: 1.05, vertikal: 0.86

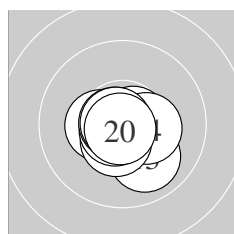

Serie 2:
 10.7 * 10.7 * 10.0 ↘ 10.4 * 10.4 *
 10.5 * 10.7 * 10.7 * 10.8 * 10.8 *
 beste Teiler 34.0 (20.) 42.5 (19.) 51.4 (18.)
 Trefferlage 0.04 mm rechts, 0.43 mm tief
 Streuwert 0.79, horizontal: 0.90, vertikal: 0.66

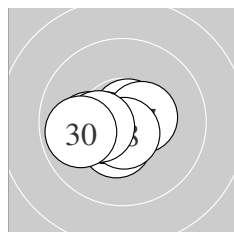

Serie 3:
 10.8 * 10.8 * 10.7 * 10.4 * 10.1 ←
 10.5 * 10.5 * 10.7 * 10.3 * 9.9 ←
 beste Teiler 32.2 (21.) 37.6 (22.) 57.2 (23.)
 Trefferlage 0.56 mm links, 0.32 mm tief
 Streuwert 0.92, horizontal: 1.21, vertikal: 0.48

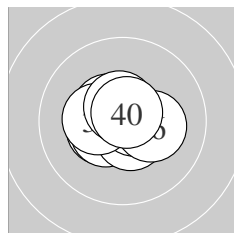

Serie 4:
 10.8 * 10.4 * 10.5 * 10.6 * 10.7 *
 10.2 * 10.5 * 10.3 * 10.6 * 10.7 *
 beste Teiler 44.1 (31.) 59.9 (40.) 75.1 (35.)
 Trefferlage 0.21 mm links, 0.00 mm
 Streuwert 0.85, horizontal: 1.04, vertikal: 0.59

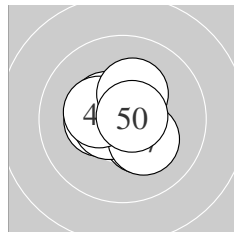

Serie 5:
 10.4 * 10.3 * 10.5 * 10.7 * 10.7 *
 10.6 * 10.2 * 10.3 * 10.3 * 10.7 *
 beste Teiler 52.6 (45.) 61.4 (50.) 66.7 (44.)
 Trefferlage 0.16 mm links, 0.06 mm hoch
 Streuwert 0.95, horizontal: 1.03, vertikal: 0.86

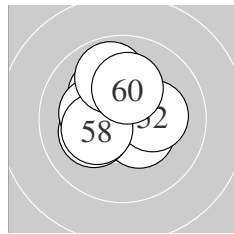

Serie 6:
 10.4 * 10.2 * 10.2 * 10.3 * 10.2 *
 10.2 * 10.2 * 10.3 * 9.9 ↑ 10.2 *
 beste Teiler 132.9 (51.) 171.7 (54.) 172.1 (58.)
 Trefferlage 0.55 mm links, 0.76 mm hoch
 Streuwert 1.25, horizontal: 1.24, vertikal: 1.26

Meyton Elektronik

ISSF AR Women – Wertung – Frauen

StandNr: 124

Tan, Adele Qian Xiu #470

StartNr: 114

20. Januar 2020 13:45

SGP

Unterschrift des Schützen

Meyton Elektronik

Ergebnis: **621.6** (595)
 Serien: 104.8 103.6 103.4 103.8 102.2 103.8
 Zähler: 55 5 0 0 0 0 0 0 0 0
 Innenzehner: 45
 weiteste: 324 (21), 279 (16), 278 (29)
 beste Teiler 13.0 (53.) 43.5 (12.) 51.6 (23.)
 Trefferlage 0.17 mm rechts, 0.04 mm hoch
 Streuwert 1.17, horizontal: 1.39, vertikal: 0.88

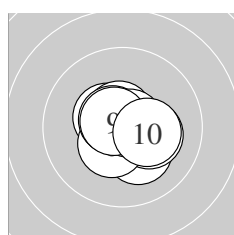
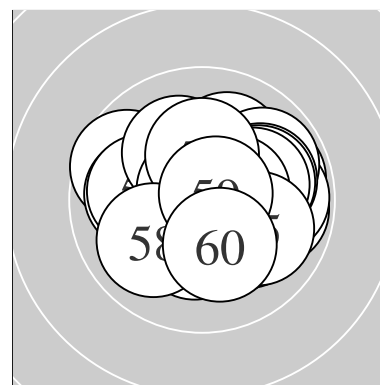

Serie 1:
 10.2 * 10.5 * 10.6 * 10.2 * 10.6 *
 10.4 * 10.6 * 10.7 * 10.7 * 10.3 *
 beste Teiler 52.8 (8.) 68.2 (9.) 81.6 (7.)
 Trefferlage 0.11 mm rechts, 0.16 mm tief
 Streuwert 0.92, horizontal: 1.02, vertikal: 0.79

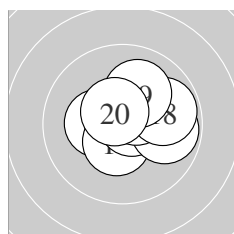

Serie 2:
 10.3 * 10.8 * 10.5 * 10.5 * 10.7 *
 9.8 → 10.5 * 9.8 → 10.1 ↑ 10.6 *
 beste Teiler 43.5 (12.) 62.3 (15.) 97.0 (20.)
 Trefferlage 0.59 mm rechts, 0.37 mm hoch
 Streuwert 1.16, horizontal: 1.37, vertikal: 0.89

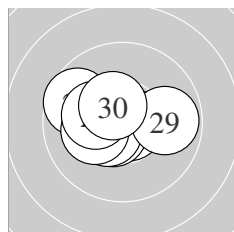

Serie 3:
 9.7 ↖ 10.7 * 10.7 * 10.6 * 10.6 *
 10.5 * 10.2 * 10.2 * 9.8 → 10.4 *
 beste Teiler 51.6 (23.) 65.6 (22.) 82.0 (24.)
 Trefferlage 0.56 mm links, 0.02 mm hoch
 Streuwert 1.23, horizontal: 1.59, vertikal: 0.72

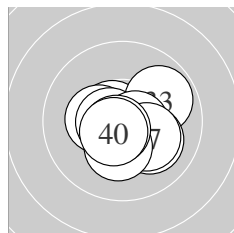

Serie 4:
 10.6 * 10.3 * 9.8 ↗ 10.6 * 10.6 *
 10.1 ↘ 10.2 * 10.3 * 10.7 * 10.6 *
 beste Teiler 68.6 (39.) 79.9 (31.) 85.2 (34.)
 Trefferlage 0.22 mm rechts, 0.35 mm tief
 Streuwert 1.13, horizontal: 1.32, vertikal: 0.89

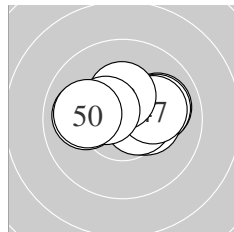

Serie 5:
 10.0 → 10.0 → 10.4 * 10.0 ← 10.3 *
 10.6 * 10.1 → 10.3 * 10.5 * 10.0 ←
 beste Teiler 100.7 (46.) 124.7 (49.) 132.5 (43.)
 Trefferlage 0.45 mm rechts, 0.44 mm hoch
 Streuwert 1.34, horizontal: 1.82, vertikal: 0.52

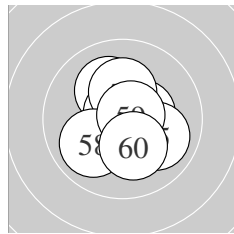

Serie 6:
 10.1 ↖ 10.4 * 10.9 * 10.6 * 10.0 ↘
 10.7 * 10.2 * 10.0 ↙ 10.7 * 10.2 *
 beste Teiler 13.0 (53.) 51.7 (56.) 59.9 (59.)
 Trefferlage 0.22 mm rechts, 0.02 mm tief
 Streuwert 1.20, horizontal: 1.15, vertikal: 1.25

Meyton Elektronik

ISSF AR Women – Wertung – Frauen

StandNr: 125

Engler, Tal #471

StartNr: 115

20. Januar 2020 13:35

ISR

Unterschrift des Schützen

Meyton Elektronik

Ergebnis: **628.7** (594)^{QF}
 Serien: 102.8 106.8 105.2 105.2 104.0 104.7
 Zähler: 54 6 0 0 0 0 0 0 0
 Innenzehner: 51
 weiteste: 372 (47), 339 (45), 276 (9)
 beste Teiler 16.0 (14.) 16.5 (42.) 19.9 (35.)
 Trefferlage 0.07 mm links, 0.13 mm hoch
 Streuwert 1.00, horizontal: 1.19, vertikal: 0.76

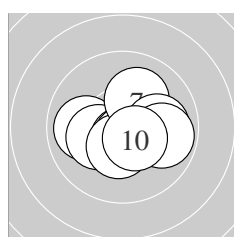
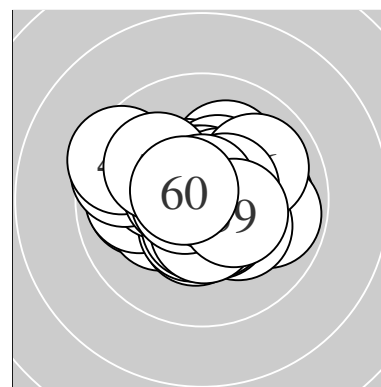

Serie 1:
 9.9 ← 10.2 * 10.6 * 10.7 * 10.6 *
 10.4 * 10.1 ↗ 10.0 → 9.8 → 10.5 *
 beste Teiler 73.7 (4.) 79.5 (5.) 82.0 (3.)
 Trefferlage 0.32 mm rechts, 0.35 mm tief
 Streuwert 1.29, horizontal: 1.60, vertikal: 0.87

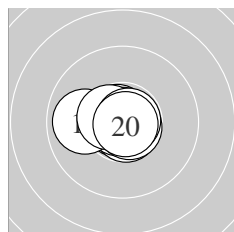

Serie 2:
 10.7 * 10.8 * 10.7 * 10.9 * 10.8 *
 10.7 * 9.9 ← 10.6 * 10.8 * 10.9 *
 beste Teiler 16.0 (14.) 24.4 (20.) 28.4 (15.)
 Trefferlage 0.32 mm links, 0.02 mm tief
 Streuwert 0.67, horizontal: 0.90, vertikal: 0.28

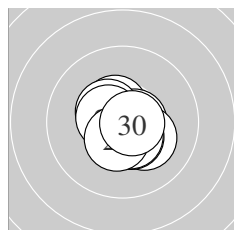

Serie 3:
 10.5 * 10.6 * 10.2 * 10.5 * 10.5 *
 10.7 * 10.5 * 10.5 * 10.5 * 10.7 *
 beste Teiler 60.8 (26.) 66.4 (30.) 81.0 (22.)
 Trefferlage 0.07 mm rechts, 0.26 mm tief
 Streuwert 0.82, horizontal: 0.86, vertikal: 0.79

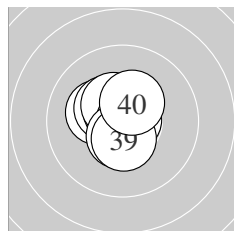

Serie 4:
 10.2 * 10.4 * 10.5 * 10.6 * 10.9 *
 10.4 * 10.8 * 10.5 * 10.5 * 10.4 *
 beste Teiler 19.9 (35.) 45.8 (37.) 87.0 (34.)
 Trefferlage 0.27 mm links, 0.35 mm hoch
 Streuwert 0.80, horizontal: 0.74, vertikal: 0.86

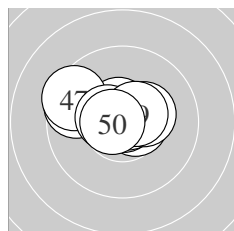

Serie 5:
 10.6 * 10.9 * 10.6 * 10.8 * 9.6 ↖
 10.3 * 9.5 ↖ 10.5 * 10.5 * 10.7 *
 beste Teiler 16.5 (42.) 50.4 (44.) 71.0 (50.)
 Trefferlage 0.48 mm links, 0.54 mm hoch
 Streuwert 1.23, horizontal: 1.65, vertikal: 0.54

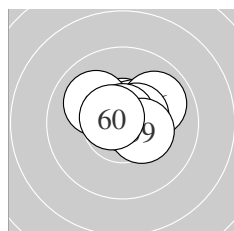

Serie 6:
 10.6 * 10.8 * 10.6 * 10.5 * 10.0 ↘
 9.9 ↗ 10.5 * 10.8 * 10.4 * 10.6 *
 beste Teiler 44.5 (52.) 47.0 (58.) 78.4 (53.)
 Trefferlage 0.25 mm rechts, 0.58 mm hoch
 Streuwert 0.89, horizontal: 1.14, vertikal: 0.56

Meyton Elektronik

ISSF AR Women – Wertung – Frauen

StandNr: 126

Brazdova, Lucie #472

StartNr: 116

20. Januar 2020 13:42

CZE

QF – Schütze hat sich fürs Finale qualifiziert

Unterschrift des Schützen

Meyton Elektronik

Ergebnis: **624.1** (598)
 Serien: 102.3 104.8 104.7 104.8 104.0 103.5
 Zähler: 58 2 0 0 0 0 0 0 0
 Innenzehner: 46
 weiteste: 276 (50), 265 (10), 249 (5)
 beste Teiler 5.0 (15.) 8.6 (23.) 29.9 (38.)
 Trefferlage 0.13 mm links, 0.13 mm hoch
 Streuwert 1.08, horizontal: 1.25, vertikal: 0.89

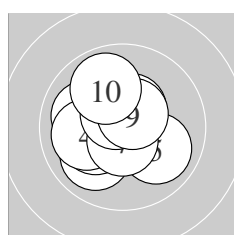
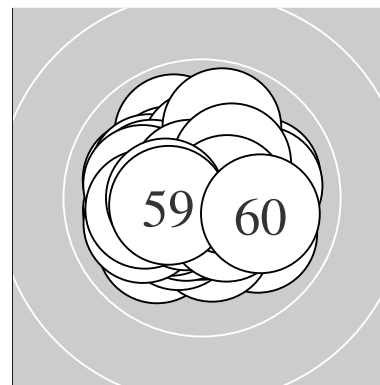

Serie 1:
 10.0 ↙ 10.2 * 10.0 ↖ 10.0 ← 10.0 ↘
 10.5 * 10.6 * 10.6 * 10.5 * 9.9 ↗
 beste Teiler 84.0 (7.) 94.3 (8.) 105.0 (9.)
 Trefferlage 0.61 mm links, 0.08 mm hoch
 Streuwert 1.38, horizontal: 1.44, vertikal: 1.31

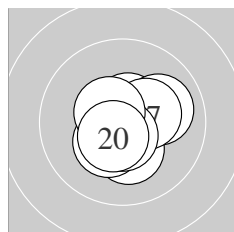

Serie 2:
 10.6 * 10.3 * 10.8 * 10.3 * 10.9 *
 10.0 → 10.3 * 10.6 * 10.5 * 10.5 *
 beste Teiler 5.0 (15.) 45.2 (13.) 85.0 (18.)
 Trefferlage 0.17 mm rechts, 0.21 mm tief
 Streuwert 0.96, horizontal: 1.01, vertikal: 0.91

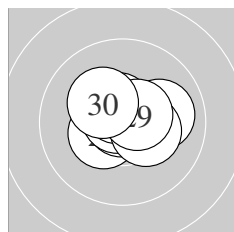

Serie 3:
 10.3 * 10.4 * 10.9 * 10.6 * 10.8 *
 10.6 * 10.0 → 10.3 * 10.5 * 10.3 *
 beste Teiler 8.6 (23.) 43.2 (25.) 80.3 (24.)
 Trefferlage 0.40 mm rechts, 0.21 mm hoch
 Streuwert 0.96, horizontal: 1.22, vertikal: 0.59

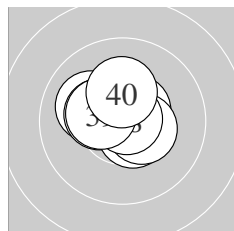

Serie 4:
 10.1 ↖ 10.3 * 10.8 * 10.6 * 10.5 *
 10.7 * 10.4 * 10.8 * 10.4 * 10.2 *
 beste Teiler 29.9 (38.) 32.5 (33.) 71.1 (36.)
 Trefferlage 0.19 mm links, 0.38 mm hoch
 Streuwert 0.92, horizontal: 1.07, vertikal: 0.73

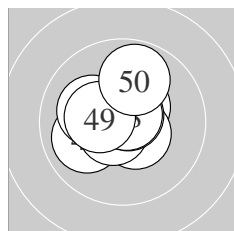

Serie 5:
 10.7 * 10.5 * 10.5 * 10.0 ← 10.1 ↖
 10.6 * 10.7 * 10.7 * 10.4 * 9.8 ↑
 beste Teiler 52.8 (48.) 55.4 (47.) 65.1 (41.)
 Trefferlage 0.37 mm links, 0.28 mm hoch
 Streuwert 1.11, horizontal: 1.15, vertikal: 1.06

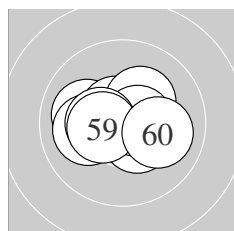

Serie 6:
 10.0 ↖ 10.7 * 10.4 * 10.1 ← 10.6 *
 10.3 * 10.6 * 10.4 * 10.4 * 10.0 →
 beste Teiler 58.6 (52.) 83.5 (55.) 95.8 (57.)
 Trefferlage 0.18 mm links, 0.08 mm hoch
 Streuwert 1.19, horizontal: 1.54, vertikal: 0.67

Meyton Elektronik

ISSF AR Women – Wertung – Frauen

StandNr: 127

Rossiter, Victoria #304

StartNr: 117

20. Januar 2020 13:39

AUS

Unterschrift des Schützen

Meyton Elektronik

Ergebnis: **613.6** (587)
 Serien: 103.1 102.7 102.5 101.8 101.1 102.4
 Zähler: 47 13 0 0 0 0 0 0 0
 Innenzehner: 39
 weiteste: 391 (11), 367 (41), 345 (34)
 beste Teiler 34.1 (8.) 79.3 (25.) 81.0 (56.)
 Trefferlage 0.12 mm rechts, 0.33 mm hoch
 Streuwert 1.42, horizontal: 1.55, vertikal: 1.28

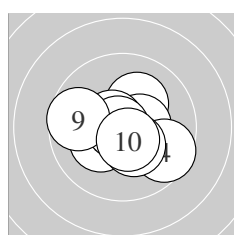
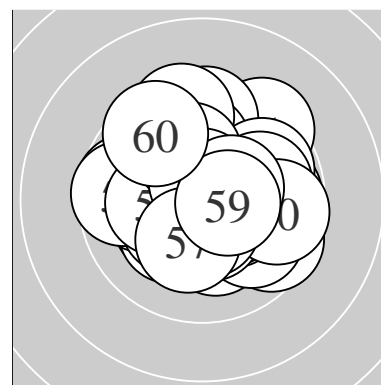

Serie 1:
 10.5 * 10.2 * 10.5 * 9.6 ↘ 10.2 *
 10.4 * 10.6 * 10.8 * 9.7 ← 10.6 *
 beste Teiler 34.1 (8.) 84.5 (7.) 96.7 (10.)
 Trefferlage 0.15 mm rechts, 0.13 mm tief
 Streuwert 1.40, horizontal: 1.69, vertikal: 1.03

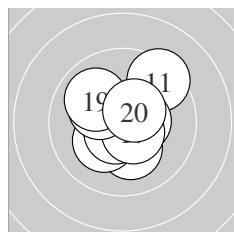

Serie 2:
 9.4 ↗ 10.2 * 10.5 * 10.2 * 10.6 *
 10.6 * 10.5 * 10.2 * 10.0 ↘ 10.5 *
 beste Teiler 84.1 (15.) 89.0 (16.) 103.2 (17.)
 Trefferlage 0.11 mm rechts, 0.24 mm hoch
 Streuwert 1.44, horizontal: 1.42, vertikal: 1.45

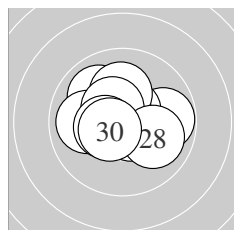

Serie 3:
 10.0 ↘ 9.8 → 10.6 * 10.0 ← 10.6 *
 10.1 ↑ 10.5 * 10.0 ↘ 10.4 * 10.5 *
 beste Teiler 79.3 (25.) 92.1 (23.) 105.3 (30.)
 Trefferlage 0.11 mm links, 0.33 mm hoch
 Streuwert 1.40, horizontal: 1.68, vertikal: 1.04

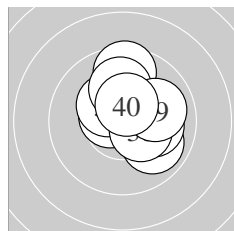

Serie 4:
 10.4 * 9.9 ↘ 10.6 * 9.6 ↑ 10.3 *
 10.1 → 10.0 ↑ 10.4 * 10.0 → 10.5 *
 beste Teiler 94.3 (33.) 120.5 (40.) 144.8 (38.)
 Trefferlage 0.54 mm rechts, 0.80 mm hoch
 Streuwert 1.38, horizontal: 1.32, vertikal: 1.44

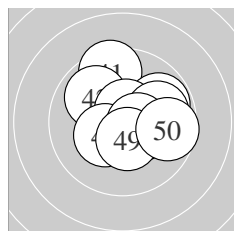

Serie 5:
 9.5 ↑ 9.9 ↘ 9.8 ↗ 10.6 * 10.3 *
 9.9 → 10.4 * 10.5 * 10.5 * 9.7 →
 beste Teiler 84.2 (44.) 108.3 (48.) 125.6 (49.)
 Trefferlage 0.70 mm rechts, 0.46 mm hoch
 Streuwert 1.59, horizontal: 1.71, vertikal: 1.47

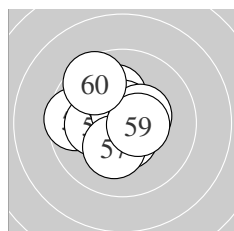

Serie 6:
 10.6 * 10.5 * 9.6 ← 10.2 * 10.2 *
 10.6 * 10.2 * 10.4 * 10.5 * 9.6 ↘
 beste Teiler 81.0 (56.) 82.4 (51.) 107.9 (52.)
 Trefferlage 0.65 mm links, 0.30 mm hoch
 Streuwert 1.38, horizontal: 1.43, vertikal: 1.33

Meyton Elektronik

ISSF AR Women – Wertung – Frauen

StandNr: 128

Oseguera, Andrea #473

StartNr: 118

20. Januar 2020 13:23

ITA– SV Eppan

Unterschrift des Schützen

Meyton Elektronik

Ergebnis:	620.1	(590)						
Serien:	103.0	103.0	103.2	103.0	103.8	104.1		
Zähler:	50	10	0	0	0	0	0	0
Innenzehner:	43							
weiteste:	420 (18), 409 (5), 328 (24)							
beste Teiler	31.9 (38.) 32.6 (49.) 39.8 (56.)							
Trefferlage	0.06 mm links, 0.16 mm hoch							
Streuwert	1.28, horizontal: 1.49, vertikal: 1.03							

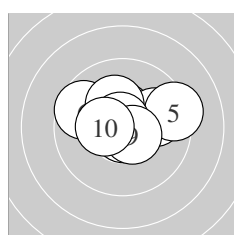
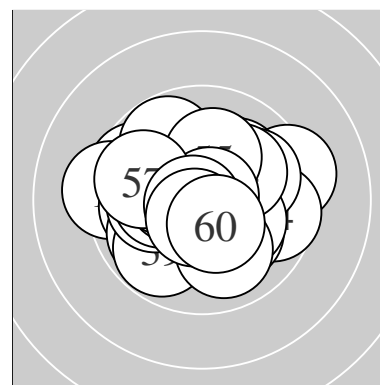

Serie 1:	10.8 *	10.8 *	10.5 *	9.9 →	9.3 →
	9.7 ↖	10.2 *	10.8 *	10.6 *	10.4 *
beste Teiler	46.6 (8.) 47.0 (1.) 47.2 (2.)				
Trefferlage	0.18 mm rechts, 0.60 mm hoch				
Streuwert	1.46, horizontal: 1.91, vertikal: 0.78				

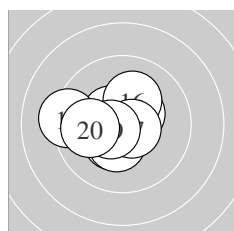

Serie 2:	10.4 *	10.4 *	10.5 *	10.6 *	10.4 *
	10.2 *	10.6 *	9.3 ←	10.6 *	10.0 ←
beste Teiler	78.2 (17.) 80.2 (14.) 98.8 (19.)				
Trefferlage	0.66 mm links, 0.05 mm hoch				
Streuwert	1.35, horizontal: 1.64, vertikal: 0.99				

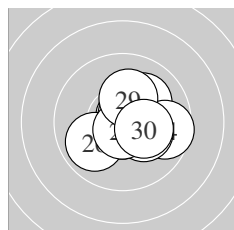

Serie 3:	10.8 *	10.7 *	10.1 ↗	9.6 →	10.2 *
	9.9 ↙	10.7 *	10.7 *	10.2 *	10.3 *
beste Teiler	46.0 (21.) 58.0 (22.) 58.0 (28.)				
Trefferlage	0.68 mm rechts, 0.02 mm tief				
Streuwert	1.26, horizontal: 1.42, vertikal: 1.06				

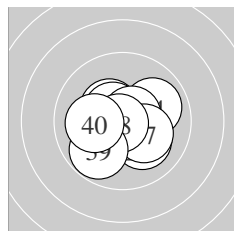

Serie 4:	10.4 *	10.5 *	10.1 ↘	9.9 →	10.6 *
	10.6 *	10.2 *	10.8 *	9.8 ↙	10.1 ←
beste Teiler	31.9 (38.) 81.3 (36.) 87.0 (35.)				
Trefferlage	0.05 mm rechts, 0.24 mm tief				
Streuwert	1.31, horizontal: 1.51, vertikal: 1.08				

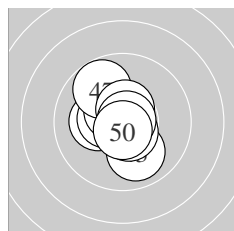

Serie 5:	10.2 *	10.2 *	10.0 ↓	10.4 *	10.5 *
	10.6 *	9.8 ↘	10.6 *	10.8 *	10.7 *
beste Teiler	32.6 (49.) 62.0 (50.) 88.5 (46.)				
Trefferlage	0.45 mm links, 0.26 mm hoch				
Streuwert	1.16, horizontal: 0.97, vertikal: 1.32				

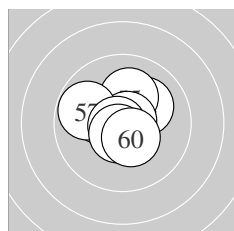

Serie 6:	10.7 *	10.2 *	10.6 *	10.1 ↗	10.1 ↑
	10.8 *	9.8 ↖	10.8 *	10.6 *	10.4 *
beste Teiler	39.8 (56.) 46.9 (58.) 58.0 (51.)				
Trefferlage	0.20 mm links, 0.34 mm hoch				
Streuwert	1.11, horizontal: 1.26, vertikal: 0.94				

Meyton Elektronik

ISSF AR Women – Wertung – Frauen

StandNr: 129

Brühler, Myriam #474

StartNr: 119

20. Januar 2020 13:41

SUI

Unterschrift des Schützen

Meyton Elektronik

Ergebnis:	626.8	(598)					
Serien:	103.2	104.2	105.2	105.6	103.7	104.9	
Zähler:	58	2	0	0	0	0	0
Innenzehner:	52						
weiteste:	437 (2), 289 (13), 240 (49)						
beste Teiler	19.4 (48.) 28.2 (25.) 30.0 (26.)						
Trefferlage	0.17 mm links, 0.44 mm hoch						
Streuwert	0.98, horizontal: 0.95, vertikal: 1.01						

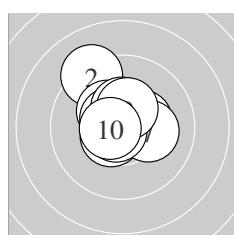
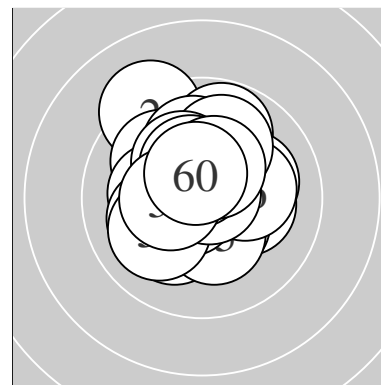

Serie 1:	10.5 *	9.2 ↘	10.4 *	10.3 *	10.5 *
	10.4 *	10.2 *	10.7 *	10.4 *	10.6 *
beste Teiler	56.0 (8.) 90.4 (10.) 105.0 (1.)				
Trefferlage	0.29 mm links, 0.74 mm hoch				
Streuwert	1.25, horizontal: 1.22, vertikal: 1.28				

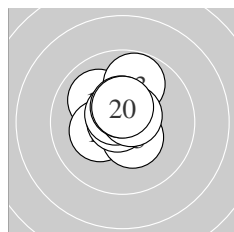

Serie 2:	10.0 ↘	10.7 *	9.8 ↑	10.3 *	10.4 *
	10.8 *	10.6 *	10.6 *	10.5 *	10.5 *
beste Teiler	37.6 (16.) 53.0 (12.) 77.2 (17.)				
Trefferlage	0.17 mm links, 0.62 mm hoch				
Streuwert	1.02, horizontal: 0.92, vertikal: 1.10				

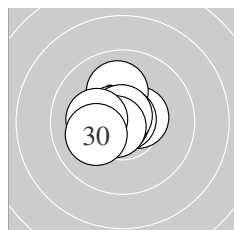

Serie 3:	10.6 *	10.5 *	10.1 ↑	10.6 *	10.8 *
	10.8 *	10.8 *	10.7 *	10.2 *	10.1 ←
beste Teiler	28.2 (25.) 30.0 (26.) 47.8 (27.)				
Trefferlage	0.43 mm links, 0.34 mm hoch				
Streuwert	0.87, horizontal: 0.92, vertikal: 0.81				

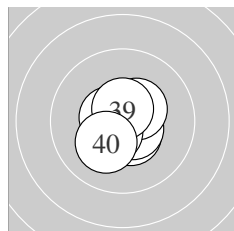

Serie 4:	10.5 *	10.8 *	10.7 *	10.7 *	10.6 *
	10.4 *	10.5 *	10.6 *	10.6 *	10.2 *
beste Teiler	45.2 (32.) 65.7 (33.) 68.6 (34.)				
Trefferlage	0.09 mm links, 0.12 mm tief				
Streuwert	0.80, horizontal: 0.77, vertikal: 0.84				

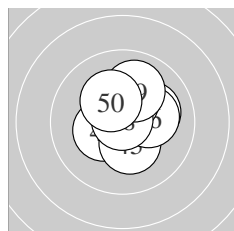

Serie 5:	10.6 *	10.6 *	10.4 *	10.1 →	10.3 *
	10.2 *	10.3 *	10.9 *	10.0 ↑	10.3 *
beste Teiler	19.4 (48.) 78.8 (41.) 83.7 (42.)				
Trefferlage	0.35 mm rechts, 0.57 mm hoch				
Streuwert	1.08, horizontal: 1.07, vertikal: 1.09				

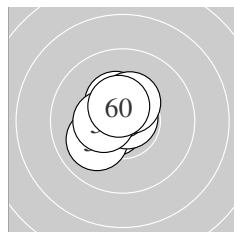

Serie 6:	10.7 *	10.0 ↙	10.4 *	10.7 *	10.8 *
	10.4 *	10.6 *	10.4 *	10.4 *	10.5 *
beste Teiler	38.8 (55.) 66.0 (54.) 70.6 (51.)				
Trefferlage	0.39 mm links, 0.51 mm hoch				
Streuwert	0.82, horizontal: 0.74, vertikal: 0.89				

Meyton Elektronik

ISSF AR Women – Wertung – Frauen

StandNr: 130

Ho, Xiu Yi #424

StartNr: 120

20. Januar 2020 13:13

SGP

Unterschrift des Schützen

Meyton Elektronik

Ergebnis: **626.7** (597)
 Serien: 103.6 104.5 104.8 105.0 105.5 103.3
 Zähler: 57 3 0 0 0 0 0 0 0
 Innenzehner: 54
 weiteste: 286 (55), 282 (57), 264 (5)
 beste Teiler 29.4 (41.) 34.1 (39.) 43.1 (46.)
 Trefferlage 0.19 mm links, 0.09 mm tief
 Streuwert 0.98, horizontal: 0.98, vertikal: 0.98

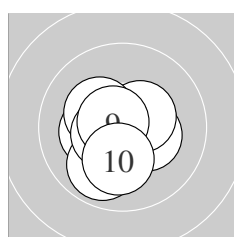
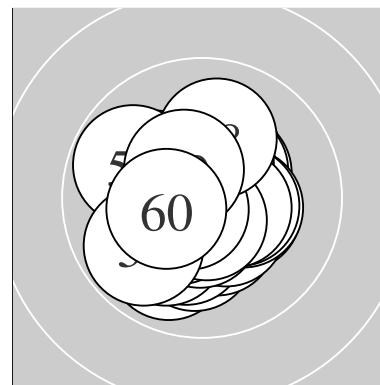

Serie 1:
 10.2 * 10.5 * 10.6 * 10.3 * 9.9 ↙
 10.4 * 10.3 * 10.5 * 10.7 * 10.2 *
 beste Teiler 68.4 (9.) 79.5 (3.) 108.0 (8.)
 Trefferlage 0.34 mm links, 0.31 mm tief
 Streuwert 1.12, horizontal: 1.16, vertikal: 1.07

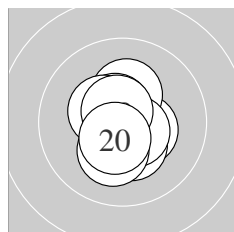

Serie 2:
 10.6 * 10.4 * 10.3 * 10.3 * 10.6 *
 10.2 * 10.6 * 10.4 * 10.6 * 10.5 *
 beste Teiler 77.3 (19.) 89.8 (11.) 91.0 (15.)
 Trefferlage 0.02 mm rechts, 0.20 mm tief
 Streuwert 0.95, horizontal: 0.75, vertikal: 1.12

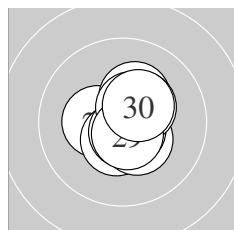

Serie 3:
 10.3 * 10.5 * 10.7 * 10.4 * 10.3 *
 10.7 * 10.5 * 10.4 * 10.6 * 10.4 *
 beste Teiler 62.1 (23.) 65.7 (26.) 78.9 (29.)
 Trefferlage 0.32 mm rechts, 0.04 mm hoch
 Streuwert 0.89, horizontal: 0.80, vertikal: 0.98

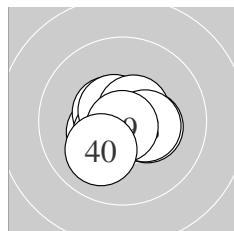

Serie 4:
 10.4 * 10.5 * 10.5 * 10.8 * 10.6 *
 10.3 * 10.6 * 10.4 * 10.8 * 10.1 ↙
 beste Teiler 34.1 (39.) 43.4 (34.) 85.2 (35.)
 Trefferlage 0.11 mm links, 0.20 mm tief
 Streuwert 0.93, horizontal: 1.05, vertikal: 0.78

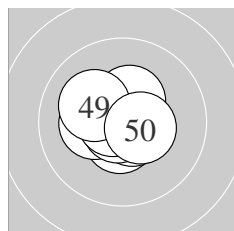

Serie 5:
 10.8 * 10.6 * 10.3 * 10.6 * 10.7 *
 10.8 * 10.7 * 10.4 * 10.1 ↘ 10.5 *
 beste Teiler 29.4 (41.) 43.1 (46.) 61.6 (47.)
 Trefferlage 0.25 mm links, 0.10 mm hoch
 Streuwert 0.83, horizontal: 0.93, vertikal: 0.71

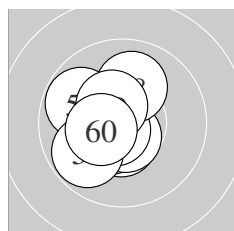

Serie 6:
 10.6 * 10.5 * 10.4 * 10.6 * 9.8 ↘
 10.7 * 9.8 ↙ 10.0 ↑ 10.5 * 10.4 *
 beste Teiler 66.6 (56.) 85.9 (54.) 95.5 (51.)
 Trefferlage 0.78 mm links, 0.01 mm tief
 Streuwert 1.15, horizontal: 1.00, vertikal: 1.29

Meyton Elektronik

ISSF AR Women – Wertung – Frauen

StandNr: 131

Pribitzer, Marlene #38

StartNr: 121

20. Januar 2020 13:46

AUT

Unterschrift des Schützen

Meyton Elektronik

Ergebnis:	617.4	(592)					
Serien:	102.4	101.3	103.7	103.2	103.5	103.3	
Zähler:	52	8	0	0	0	0	0
Innenzehner:	39						
weiteste:	403 (14), 326 (20), 297 (48)						
beste Teiler	23.0 (46.) 26.0 (23.) 34.1 (32.)						
Trefferlage	0.41 mm links, 0.20 mm tief						
Streuwert	1.26, horizontal: 1.37, vertikal: 1.15						

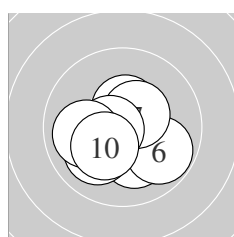
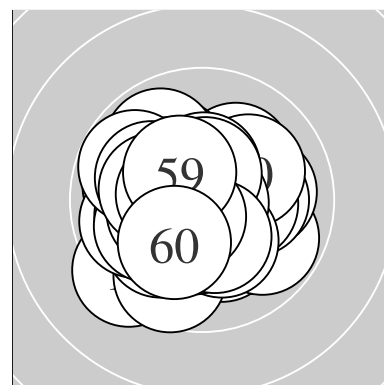

Serie 1:

10.6 *	10.5 *	9.9 ↘	10.2 *	10.0 ↙
9.8 ↘	10.5 *	10.6 *	10.0 ←	10.3 *
beste Teiler	83.3 (8.) 85.0 (1.) 122.3 (2.)			
Trefferlage	0.09 mm rechts, 0.56 mm tief			
Streuwert	1.36, horizontal: 1.57, vertikal: 1.12			

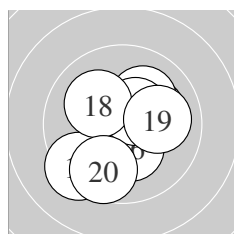

Serie 2:

10.6 *	10.7 *	10.1 ↗	9.3 ↙	10.1 ↗
10.3 *	10.5 *	10.1 ↘	10.0 →	9.6 ↙
beste Teiler	69.1 (12.) 97.0 (11.) 119.5 (17.)			
Trefferlage	0.03 mm rechts, 0.33 mm tief			
Streuwert	1.66, horizontal: 1.66, vertikal: 1.66			

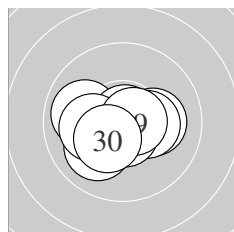

Serie 3:

10.2 *	9.9 ←	10.8 *	10.0 ↙	10.5 *
10.3 *	10.7 *	10.2 *	10.7 *	10.4 *
beste Teiler	26.0 (23.) 71.1 (29.) 73.3 (27.)			
Trefferlage	0.33 mm links, 0.40 mm tief			
Streuwert	1.16, horizontal: 1.50, vertikal: 0.67			

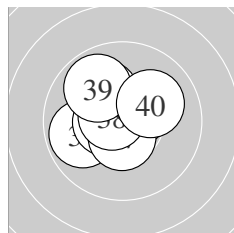

Serie 4:

10.4 *	10.8 *	10.1 ↘	10.5 *	9.8 ←
10.5 *	10.5 *	10.6 *	9.9 ↘	10.1 ↗
beste Teiler	34.1 (32.) 76.9 (38.) 103.0 (37.)			
Trefferlage	0.58 mm links, 0.46 mm hoch			
Streuwert	1.18, horizontal: 1.31, vertikal: 1.03			

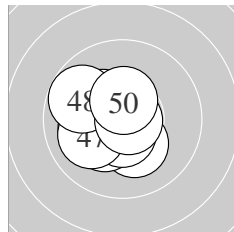

Serie 5:

10.1 ←	10.2 *	10.3 *	10.3 *	10.6 *
10.9 *	10.0 ←	9.8 ↘	10.8 *	10.5 *
beste Teiler	23.0 (46.) 41.4 (49.) 95.0 (45.)			
Trefferlage	0.80 mm links, 0.17 mm tief			
Streuwert	1.14, horizontal: 1.20, vertikal: 1.09			

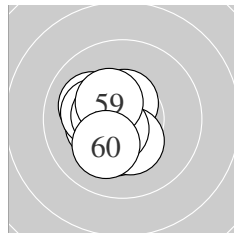

Serie 6:

10.1 ↘	10.3 *	10.3 *	10.2 *	10.5 *
10.5 *	10.3 *	10.6 *	10.4 *	10.1 ↙
beste Teiler	82.8 (58.) 104.6 (55.) 120.2 (56.)			
Trefferlage	0.88 mm links, 0.20 mm tief			
Streuwert	0.97, horizontal: 0.83, vertikal: 1.09			

Meyton Elektronik

ISSF AR Women – Wertung – Frauen

StandNr: 132

Kowplos, Katarina #320

StartNr: 122

20. Januar 2020 13:37

AUS

Unterschrift des Schützen

Meyton Elektronik

Ergebnis:	629.7	(599) ^{QF}					
Serien:	105.6	103.9	105.9	104.9	104.4	105.0	
Zähler:	59	1	0	0	0	0	0
Innenzehner:	55						
weiteste:	294 (20), 229 (43), 220 (48)						
beste Teiler	11.1 (18.) 19.2 (26.) 25.0 (32.)						
Trefferlage	0.21 mm links, 0.12 mm tief						
Streuwert	0.91, horizontal: 1.00, vertikal: 0.81						

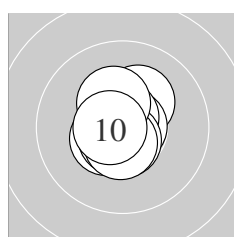
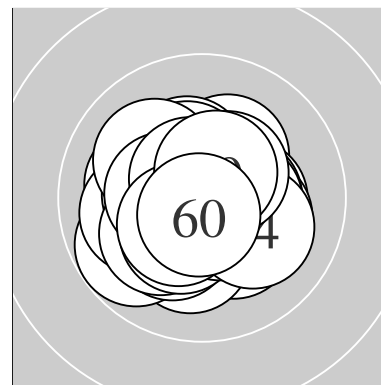

Serie 1:	10.2 *	10.8 *	10.5 *	10.7 *	10.6 *
	10.7 *	10.6 *	10.6 *	10.3 *	10.6 *
beste Teiler	46.2 (2.) 60.1 (4.) 75.0 (6.)				
Trefferlage	0.14 mm links, 0.02 mm tief				
Streuwert	0.77, horizontal: 0.57, vertikal: 0.93				

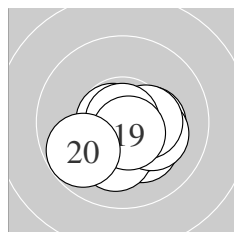

Serie 2:	10.3 *	10.2 *	10.7 *	10.5 *	10.2 *
	10.2 *	10.4 *	10.9 *	10.7 *	9.8 ↙
beste Teiler	11.1 (18.) 60.0 (13.) 75.1 (19.)				
Trefferlage	0.36 mm rechts, 0.71 mm tief				
Streuwert	1.06, horizontal: 1.28, vertikal: 0.77				

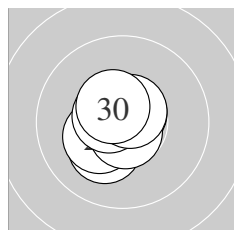

Serie 3:	10.2 *	10.7 *	10.6 *	10.8 *	10.3 *
	10.9 *	10.7 *	10.6 *	10.6 *	10.5 *
beste Teiler	19.2 (26.) 46.0 (24.) 61.4 (27.)				
Trefferlage	0.42 mm links, 0.10 mm tief				
Streuwert	0.71, horizontal: 0.64, vertikal: 0.76				

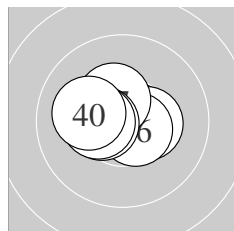

Serie 4:	10.7 *	10.9 *	10.5 *	10.4 *	10.4 *
	10.6 *	10.4 *	10.5 *	10.4 *	10.1 ↖
beste Teiler	25.0 (32.) 63.9 (31.) 93.4 (36.)				
Trefferlage	0.45 mm links, 0.23 mm hoch				
Streuwert	0.89, horizontal: 1.15, vertikal: 0.51				

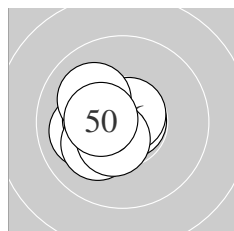

Serie 5:	10.5 *	10.8 *	10.0 ↖	10.8 *	10.4 *
	10.7 *	10.2 *	10.1 ↗	10.5 *	10.4 *
beste Teiler	38.2 (42.) 42.4 (44.) 59.6 (46.)				
Trefferlage	0.85 mm links, 0.02 mm tief				
Streuwert	0.87, horizontal: 0.96, vertikal: 0.77				

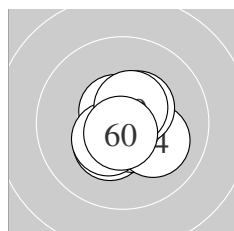

Serie 6:	10.4 *	10.6 *	10.7 *	10.1 ↘	10.6 *
	10.4 *	10.6 *	10.4 *	10.5 *	10.7 *
beste Teiler	54.7 (53.) 63.1 (60.) 81.6 (57.)				
Trefferlage	0.24 mm rechts, 0.08 mm tief				
Streuwert	0.87, horizontal: 0.83, vertikal: 0.91				

Meyton Elektronik

ISSF AR Women – Wertung – Frauen

StandNr: 133

McIntosh, Seonaid #408

StartNr: 123

20. Januar 2020 13:35

GBR

QF – Schütze hat sich fürs Finale qualifiziert

Unterschrift des Schützen

Meyton Elektronik

Ergebnis: **614.5** (589)
 Serien: 100.9 102.5 104.2 102.9 102.7 101.3
 Zähler: 49 11 0 0 0 0 0 0 0
 Innenzehner: 37
 weiteste: 469 (57), 456 (54), 325 (56)
 beste Teiler 14.3 (32.) 29.0 (55.) 47.1 (28.)
 Trefferlage 0.09 mm rechts, 0.12 mm hoch
 Streuwert 1.43, horizontal: 1.51, vertikal: 1.34

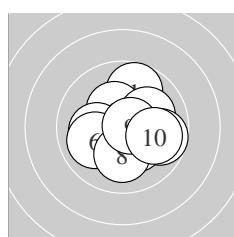
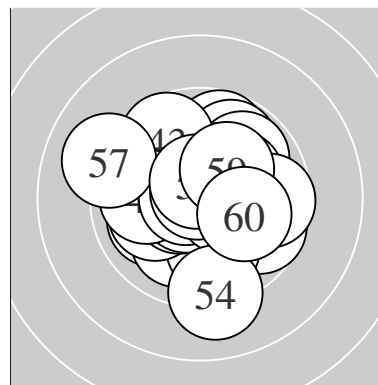

Serie 1:
 9.7 ↗ 10.3 * 10.1 ↘ 9.7 → 10.1 ←
 10.0 ← 10.3 * 10.1 ↓ 10.7 * 9.9 →
 beste Teiler 62.9 (9.) 152.5 (2.) 169.2 (7.)
 Trefferlage 0.50 mm rechts, 0.09 mm tief
 Streuwert 1.62, horizontal: 1.76, vertikal: 1.48

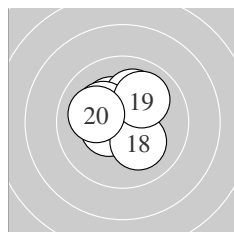

Serie 2:
 10.3 * 10.4 * 10.4 * 10.1 ↗ 10.5 *
 10.3 * 10.2 * 10.2 * 10.0 ↗ 10.1 ←
 beste Teiler 119.6 (15.) 139.4 (13.) 140.3 (12.)
 Trefferlage 0.60 mm links, 0.67 mm hoch
 Streuwert 1.17, horizontal: 1.28, vertikal: 1.05

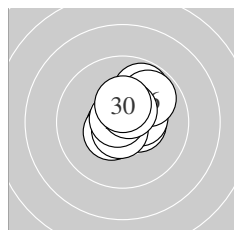

Serie 3:
 10.7 * 10.5 * 10.5 * 9.8 ↗ 10.4 *
 9.9 ↗ 10.7 * 10.8 * 10.5 * 10.4 *
 beste Teiler 47.1 (28.) 67.4 (21.) 67.6 (27.)
 Trefferlage 0.44 mm rechts, 0.54 mm hoch
 Streuwert 1.05, horizontal: 1.01, vertikal: 1.09

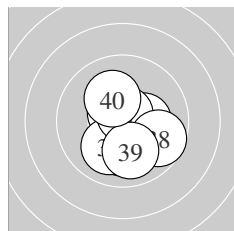

Serie 4:
 10.1 ↓ 10.9 * 10.6 * 10.4 * 10.3 *
 10.0 ↘ 10.7 * 9.7 → 10.0 ↓ 10.2 *
 beste Teiler 14.3 (32.) 55.9 (37.) 83.6 (33.)
 Trefferlage 0.25 mm rechts, 0.62 mm tief
 Streuwert 1.29, horizontal: 1.18, vertikal: 1.40

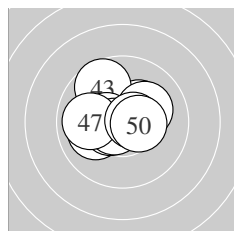

Serie 5:
 10.0 ← 10.3 * 9.7 ↖ 10.5 * 10.4 *
 10.7 * 9.9 ← 10.2 * 10.6 * 10.4 *
 beste Teiler 75.1 (46.) 83.8 (49.) 107.1 (44.)
 Trefferlage 0.40 mm links, 0.34 mm hoch
 Streuwert 1.32, horizontal: 1.56, vertikal: 1.03

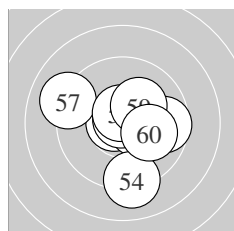

Serie 6:
 10.7 * 10.5 * 10.5 * 9.1 ↓ 10.8 *
 9.7 → 9.1 ↖ 10.6 * 10.2 * 10.1 →
 beste Teiler 29.0 (55.) 67.0 (51.) 79.6 (58.)
 Trefferlage 0.39 mm rechts, 0.06 mm tief
 Streuwert 1.89, horizontal: 2.02, vertikal: 1.76

Meyton Elektronik

ISSF AR Women – Wertung – Frauen

StandNr: 134

Adams, Emma #412

StartNr: 124

20. Januar 2020 13:44

AUS

Unterschrift des Schützen

Meyton Elektronik

Ergebnis: **608.7** (578)
 Serien: 101.2 99.5 101.3 101.0 103.0 102.7
 Zähler: 38 22 0 0 0 0 0 0 0
 Innenzehner: 28
 weiteste: 396 (3), 365 (17), 356 (47)
 beste Teiler 38.2 (7.) 40.5 (53.) 45.0 (48.)
 Trefferlage 0.20 mm links, 0.12 mm hoch
 Streuwert 1.62, horizontal: 1.67, vertikal: 1.56

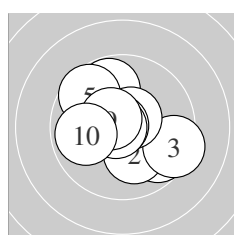
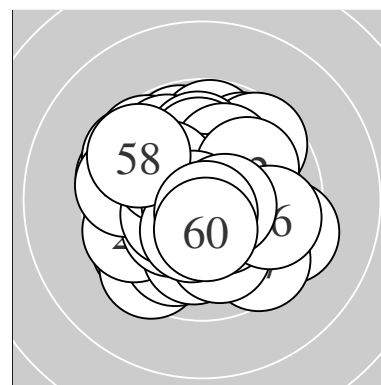

Serie 1:
 9.7 ↘ 10.1 ↓ 9.4 → 9.8 ↑ 9.6 ↖
 10.6 * 10.8 * 10.8 * 10.5 * 9.9 ←
 beste Teiler 38.2 (7.) 49.0 (8.) 89.1 (6.)
 Trefferlage 0.00 mm , 0.08 mm hoch
 Streuwert 1.80, horizontal: 2.00, vertikal: 1.57

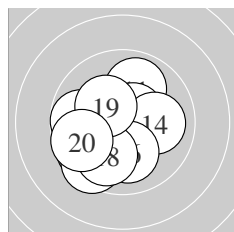

Serie 2:
 9.9 ↑ 9.7 ↙ 10.6 * 10.0 → 9.8 ←
 10.1 ↓ 9.5 ↙ 9.9 ↓ 10.3 * 9.7 ←
 beste Teiler 96.8 (13.) 166.9 (19.) 219.3 (16.)
 Trefferlage 0.87 mm links, 0.65 mm tief
 Streuwert 1.81, horizontal: 1.86, vertikal: 1.75

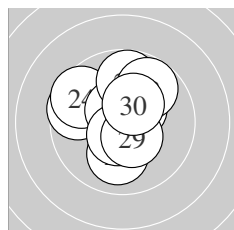

Serie 3:
 10.0 ↓ 10.4 * 9.6 ↖ 9.6 ↖ 10.6 *
 10.6 * 9.8 ↑ 9.8 ↗ 10.5 * 10.4 *
 beste Teiler 97.8 (26.) 98.9 (25.) 123.7 (29.)
 Trefferlage 0.28 mm links, 0.70 mm hoch
 Streuwert 1.64, horizontal: 1.64, vertikal: 1.65

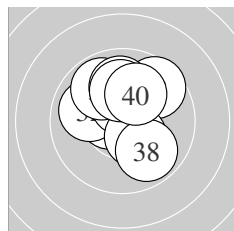

Serie 4:
 10.6 * 10.0 ↖ 9.6 ↗ 10.5 * 10.4 *
 9.8 ↘ 10.0 ↑ 9.9 ↘ 10.1 ↑ 10.1 ↗
 beste Teiler 95.3 (31.) 123.1 (34.) 144.8 (35.)
 Trefferlage 0.07 mm rechts, 1.03 mm hoch
 Streuwert 1.53, horizontal: 1.45, vertikal: 1.60

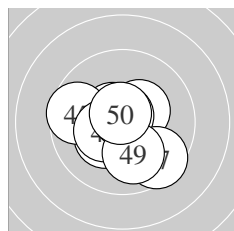

Serie 5:
 10.4 * 10.3 * 10.6 * 10.7 * 9.6 ←
 10.4 * 9.5 ↘ 10.8 * 10.0 ↓ 10.7 *
 beste Teiler 45.0 (48.) 65.0 (50.) 72.1 (44.)
 Trefferlage 0.30 mm links, 0.33 mm tief
 Streuwert 1.42, horizontal: 1.57, vertikal: 1.26

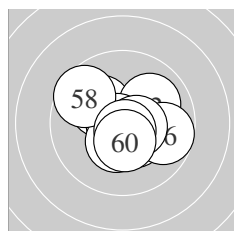

Serie 6:
 10.2 * 10.0 ↗ 10.8 * 10.4 * 10.4 *
 9.7 → 10.5 * 9.6 ↖ 10.7 * 10.4 *
 beste Teiler 40.5 (53.) 58.5 (59.) 102.1 (57.)
 Trefferlage 0.19 mm rechts, 0.08 mm tief
 Streuwert 1.43, horizontal: 1.64, vertikal: 1.17

Meyton Elektronik

ISSF AR Women – Wertung – Frauen

StandNr: 135

Babenko, Mariia #475

StartNr: 125

20. Januar 2020 13:30

HSG

Unterschrift des Schützen

Meyton Elektronik

Ergebnis:	622.5	(591)						
Serien:	103.7	104.2	103.5	103.7	104.7	102.7		
Zähler:	51	9	0	0	0	0	0	0
Innenzehner:	45							
weiteste:	453 (7), 310 (48), 309 (31)							
beste Teiler	10.6 (45.)	12.3 (39.)	15.2 (59.)					
Trefferlage	0.25 mm rechts, 0.01 mm hoch							
Streuwert	1.20, horizontal: 1.15, vertikal: 1.25							

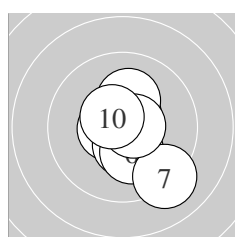
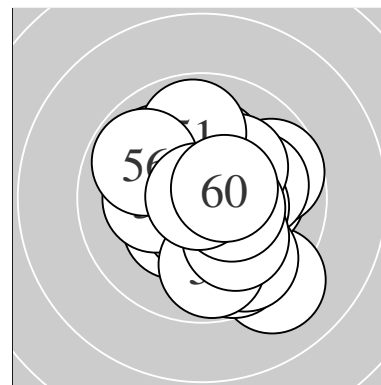

Serie 1:	10.6 *	10.6 *	10.5 *	10.9 *	10.5 *
	10.2 *	9.1 ↘	10.2 *	10.6 *	10.5 *
beste Teiler	20.5 (4.)	77.4 (9.)	82.8 (1.)		
Trefferlage	0.43 mm rechts, 0.20 mm tief				
Streuwert	1.32, horizontal: 1.05, vertikal: 1.54				

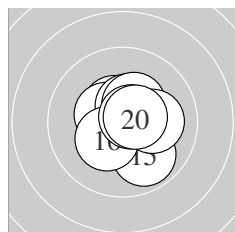

Serie 2:	10.5 *	10.8 *	10.4 *	10.5 *	9.9 ↘
	10.3 *	10.4 *	10.1 →	10.7 *	10.6 *
beste Teiler	38.6 (12.)	67.9 (19.)	95.6 (20.)		
Trefferlage	0.32 mm rechts, 0.16 mm hoch				
Streuwert	1.08, horizontal: 1.07, vertikal: 1.09				

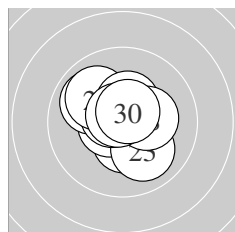

Serie 3:	10.4 *	10.6 *	10.0 ↘	9.9 ↖	10.6 *
	10.0 ↖	10.4 *	10.3 *	10.7 *	10.6 *
beste Teiler	60.2 (29.)	82.2 (30.)	86.8 (25.)		
Trefferlage	0.19 mm links, 0.29 mm hoch				
Streuwert	1.20, horizontal: 1.25, vertikal: 1.16				

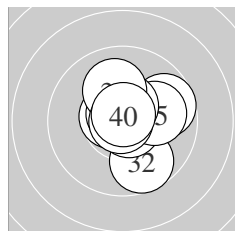

Serie 4:	9.7 →	9.7 ↘	10.7 *	10.6 *	10.0 →
	10.5 *	10.7 *	10.1 ↑	10.9 *	10.8 *
beste Teiler	12.3 (39.)	45.2 (40.)	56.0 (33.)		
Trefferlage	0.54 mm rechts, 0.29 mm hoch				
Streuwert	1.26, horizontal: 1.23, vertikal: 1.28				

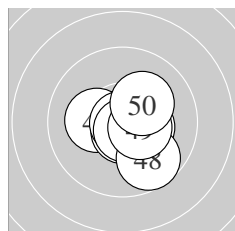

Serie 5:	10.7 *	10.8 *	10.2 *	10.7 *	10.9 *
	10.7 *	10.4 *	9.7 ↘	10.4 *	10.2 *
beste Teiler	10.6 (45.)	29.6 (42.)	59.4 (46.)		
Trefferlage	0.45 mm rechts, 0.31 mm tief				
Streuwert	1.02, horizontal: 1.07, vertikal: 0.95				

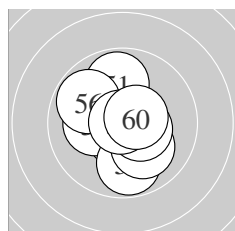

Serie 6:	9.9 ↑	10.6 *	10.2 *	10.5 *	9.8 ↓
	9.8 ↖	10.1 ↘	10.4 *	10.9 *	10.5 *
beste Teiler	15.2 (59.)	95.3 (52.)	102.0 (54.)		
Trefferlage	0.00 mm , 0.11 mm tief				
Streuwert	1.43, horizontal: 1.31, vertikal: 1.54				

ISSF AR Women – Wertung – Frauen

StandNr: 136

Guignard, Silvia #476

StartNr: 126

20. Januar 2020 13:42

SUI

Unterschrift des Schützen

Meyton Elektronik

Ergebnis:	629.5	(597) ^{QF}						
Serien:	105.0	105.6	104.4	105.5	105.2	103.8		
Zähler:	57	3	0	0	0	0	0	0
Innenzehner:	55							
weiteste:	328 (29), 294 (38), 269 (53)							
beste Teiler	9.0 (39.)	29.4 (22.)	29.8 (32.)					
Trefferlage	0.12 mm rechts, 0.03 mm hoch							
Streuwert	0.93, horizontal: 1.02, vertikal: 0.84							

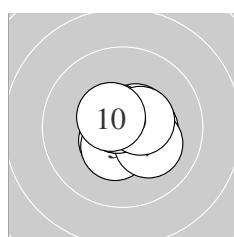
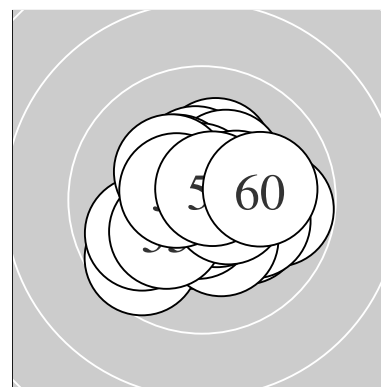

Serie 1:	10.5 *	10.4 *	10.6 *	10.5 *	10.4 *
	10.7 *	10.2 *	10.7 *	10.5 *	10.5 *
beste Teiler	62.7 (6.)	63.2 (8.)	80.6 (3.)		
Trefferlage	0.20 mm rechts, 0.11 mm tief				
Streuwert	0.86, horizontal: 0.95, vertikal: 0.76				

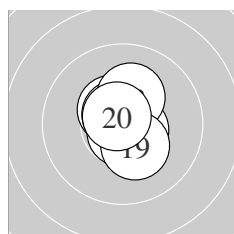

Serie 2:	10.7 *	10.7 *	10.5 *	10.7 *	10.6 *
	10.6 *	10.6 *	10.2 *	10.3 *	10.7 *
beste Teiler	53.3 (11.)	53.6 (14.)	60.1 (12.)		
Trefferlage	0.12 mm rechts, 0.21 mm hoch				
Streuwert	0.75, horizontal: 0.55, vertikal: 0.90				

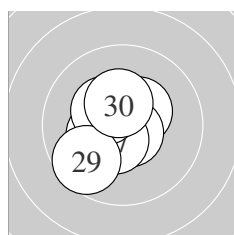

Serie 3:	10.6 *	10.8 *	10.4 *	10.7 *	10.7 *
	10.3 *	10.5 *	10.4 *	9.6 ✓	10.4 *
beste Teiler	29.4 (22.)	65.1 (25.)	74.8 (24.)		
Trefferlage	0.39 mm links, 0.00 mm				
Streuwert	1.08, horizontal: 1.05, vertikal: 1.11				

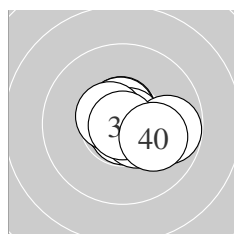

Serie 4:	10.6 *	10.8 *	10.8 *	10.6 *	10.5 *
	10.8 *	10.6 *	9.8 →	10.9 *	10.1 →
beste Teiler	9.0 (39.)	29.8 (32.)	40.1 (36.)		
Trefferlage	0.49 mm rechts, 0.00 mm				
Streuwert	0.91, horizontal: 1.15, vertikal: 0.59				

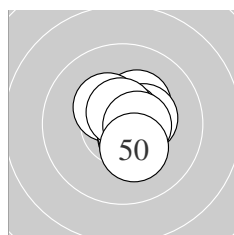

Serie 5:	10.5 *	10.3 *	10.4 *	10.4 *	10.8 *
	10.6 *	10.7 *	10.6 *	10.6 *	10.3 *
beste Teiler	49.5 (45.)	70.0 (47.)	78.2 (48.)		
Trefferlage	0.38 mm rechts, 0.20 mm hoch				
Streuwert	0.82, horizontal: 0.72, vertikal: 0.91				

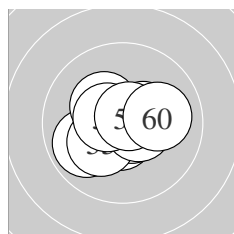

Serie 6:	10.6 *	10.4 *	9.9 ✓	10.7 *	10.2 *
	10.5 *	10.3 *	10.5 *	10.7 *	10.0 →
beste Teiler	60.1 (59.)	69.8 (54.)	86.6 (51.)		
Trefferlage	0.05 mm links, 0.12 mm tief				
Streuwert	1.17, horizontal: 1.43, vertikal: 0.82				

Meyton Elektronik

ISSF AR Women – Wertung – Frauen

StandNr: 138

Zumaya, Goretti #477

StartNr: 127

20. Januar 2020 13:22

MEX

QF – Schütze hat sich fürs Finale qualifiziert

Unterschrift des Schützen

Meyton Elektronik

Ergebnis:	621.6	(592)							
Serien:	103.4	102.8	103.4	104.5	103.5	104.0			
Zähler:	52	8	0	0	0	0	0	0	0
Innenzehner:	48								
weiteste:	333 (23), 303 (13), 302 (6)								
beste Teiler	34.4 (49.)	35.6 (52.)	53.1 (8.)						
Trefferlage	0.19 mm links, 0.05 mm hoch								
Streuwert	1.17, horizontal: 1.15, vertikal: 1.19								

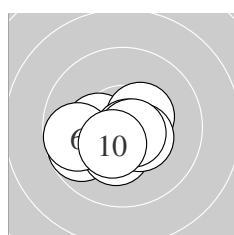
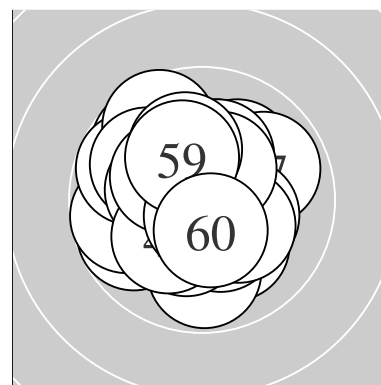

Serie 1:	9.8 ↙	10.7 *	10.3 *	10.3 *	10.4 *
	9.7 ↙	10.4 *	10.7 *	10.7 *	10.4 *
beste Teiler	53.1 (8.) 64.6 (2.) 72.4 (9.)				
Trefferlage	0.55 mm links, 0.59 mm tief				
Streuwert	1.14, horizontal: 1.47, vertikal: 0.66				

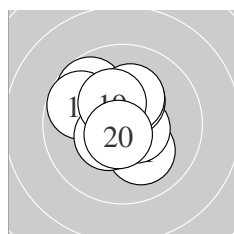

Serie 2:	10.1 ↘	10.6 *	9.7 ↖	10.6 *	10.3 *
	10.2 *	9.8 ↖	10.5 *	10.3 *	10.7 *
beste Teiler	73.9 (20.) 91.7 (12.) 93.3 (14.)				
Trefferlage	0.38 mm links, 0.53 mm hoch				
Streuwert	1.30, horizontal: 1.28, vertikal: 1.31				

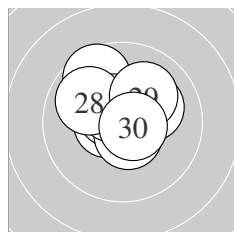

Serie 3:	10.6 *	10.7 *	9.6 ↖	10.6 *	10.6 *
	10.1 ↗	10.5 *	9.9 ↖	10.1 ↗	10.7 *
beste Teiler	70.1 (22.) 74.4 (30.) 92.4 (24.)				
Trefferlage	0.12 mm links, 0.72 mm hoch				
Streuwert	1.21, horizontal: 1.32, vertikal: 1.10				

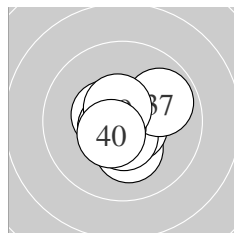

Serie 4:	10.5 *	10.5 *	10.2 *	10.6 *	10.6 *
	10.5 *	9.9 ↗	10.6 *	10.6 *	10.5 *
beste Teiler	79.7 (35.) 81.4 (38.) 81.6 (34.)				
Trefferlage	0.00 mm, 0.34 mm tief				
Streuwert	0.98, horizontal: 1.03, vertikal: 0.93				

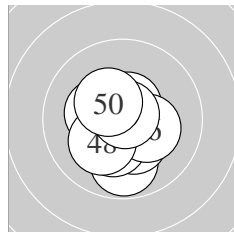

Serie 5:	9.8 ↓	10.3 *	10.5 *	10.3 *	10.6 *
	10.3 *	10.3 *	10.2 *	10.8 *	10.4 *
beste Teiler	34.4 (49.) 90.2 (45.) 110.3 (43.)				
Trefferlage	0.05 mm links, 0.55 mm tief				
Streuwert	1.15, horizontal: 1.04, vertikal: 1.24				

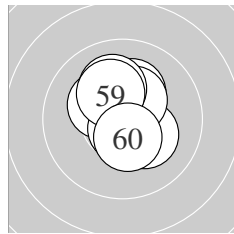

Serie 6:	10.6 *	10.8 *	10.3 *	10.2 *	10.7 *
	10.2 *	10.4 *	10.1 ↖	10.2 *	10.5 *
beste Teiler	35.6 (52.) 63.1 (55.) 94.6 (51.)				
Trefferlage	0.05 mm links, 0.56 mm hoch				
Streuwert	1.02, horizontal: 0.85, vertikal: 1.17				

Meyton Elektronik

ISSF AR Women – Wertung – Frauen

StandNr: 139

Lott, Amy #422

StartNr: 128

20. Januar 2020 13:29

GBR

Unterschrift des Schützen

Meyton Elektronik

Ergebnis:	628.0	(600) ^{QF}
Serien:	103.2	104.4 105.0 104.3 105.5 105.6
Zähler:	60	0 0 0 0 0 0 0 0 0
Innenzehner:	54	
weiteste:	240	(40), 239 (34), 234 (12)
beste Teiler	18.3	(56.) 39.8 (39.) 43.0 (20.)
Trefferlage	0.15	mm links, 0.19 mm hoch
Streuwert	0.93,	horizontal: 0.92, vertikal: 0.94

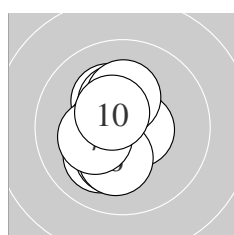
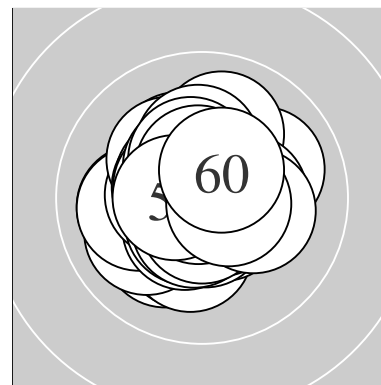

Serie 1:	10.2 *	10.1 ↘	10.6 *	10.6 *	10.2 *
	10.2 *	10.3 *	10.3 *	10.2 *	10.5 *
beste Teiler	87.2	(4.) 98.9 (3.)	107.4 (10.)		
Trefferlage	0.60	mm links, 0.01 mm tief			
Streuwert	1.12,	horizontal: 0.70, vertikal: 1.42			

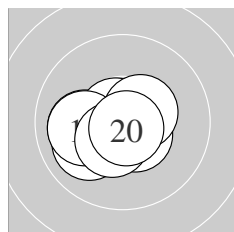

Serie 2:	10.7 *	10.0 ↙	10.7 *	10.0 ←	10.7 *
	10.5 *	10.0 ←	10.5 *	10.5 *	10.8 *
beste Teiler	43.0	(20.) 58.0 (15.)	65.2 (13.)		
Trefferlage	0.65	mm links, 0.36 mm tief			
Streuwert	0.94,	horizontal: 1.19, vertikal: 0.58			

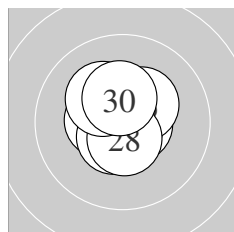

Serie 3:	10.6 *	10.6 *	10.5 *	10.5 *	10.8 *
	10.3 *	10.5 *	10.6 *	10.2 *	10.4 *
beste Teiler	48.0	(25.) 76.2 (22.)	97.6 (28.)		
Trefferlage	0.13	mm links, 0.27 mm hoch			
Streuwert	0.86,	horizontal: 0.84, vertikal: 0.89			

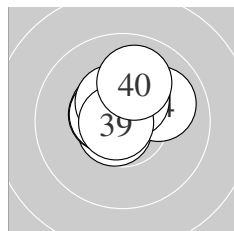

Serie 4:	10.5 *	10.7 *	10.5 *	10.0 ↗	10.5 *
	10.5 *	10.4 *	10.4 *	10.8 *	10.0 ↑
beste Teiler	39.8	(39.) 65.0 (32.)	103.0 (36.)		
Trefferlage	0.12	mm links, 0.77 mm hoch			
Streuwert	0.89,	horizontal: 0.99, vertikal: 0.78			

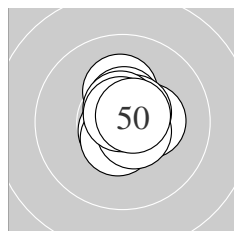

Serie 5:	10.3 *	10.7 *	10.2 *	10.5 *	10.6 *
	10.5 *	10.6 *	10.6 *	10.8 *	10.7 *
beste Teiler	48.2	(49.) 66.8 (42.)	72.7 (50.)		
Trefferlage	0.25	mm rechts, 0.31 mm hoch			
Streuwert	0.74,	horizontal: 0.61, vertikal: 0.84			

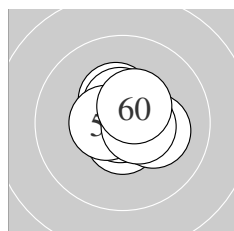

Serie 6:	10.4 *	10.6 *	10.7 *	10.6 *	10.5 *
	10.9 *	10.6 *	10.2 *	10.6 *	10.5 *
beste Teiler	18.3	(56.) 69.4 (53.)	83.0 (52.)		
Trefferlage	0.33	mm rechts, 0.20 mm hoch			
Streuwert	0.77,	horizontal: 0.81, vertikal: 0.72			

Meyton Elektronik

ISSF AR Women – Wertung – Frauen

StandNr: 140

Christen, Nina #478

StartNr: 129

20. Januar 2020 13:24

SUI

QF – Schütze hat sich fürs Finale qualifiziert

Unterschrift des Schützen

Meyton Elektronik

Ergebnis: **620.4** (595)
 Serien: 104.4 102.7 104.0 102.4 102.4 104.5
 Zähler: 55 5 0 0 0 0 0 0 0 0
 Innenzehner: 42
 weiteste: 336 (40), 311 (8), 275 (49)
 beste Teiler 16.7 (26.) 23.0 (4.) 27.4 (53.)
 Trefferlage 0.08 mm links, 0.20 mm hoch
 Streuwert 1.20, horizontal: 1.35, vertikal: 1.02

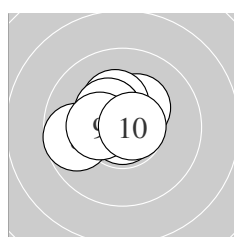
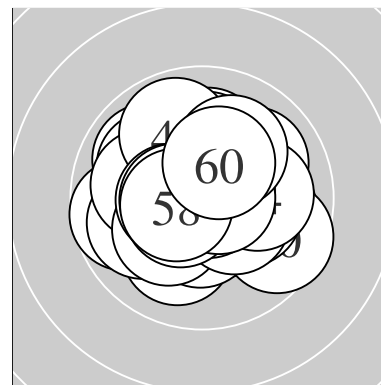

Serie 1:
 10.3 * 10.7 * 10.3 * 10.9 * 10.7 *
 10.4 * 10.4 * 9.7 ← 10.3 * 10.7 *
 beste Teiler 23.0 (4.) 64.3 (2.) 64.3 (10.)
 Trefferlage 0.64 mm links, 0.49 mm hoch
 Streuwert 0.94, horizontal: 1.12, vertikal: 0.71

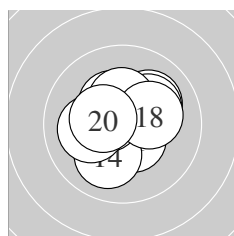

Serie 2:
 10.5 * 10.1 ↗ 10.1 ↗ 10.1 ↓ 10.5 *
 10.4 * 10.3 * 10.2 * 10.1 ← 10.4 *
 beste Teiler 111.4 (15.) 116.4 (11.) 135.1 (20.)
 Trefferlage 0.03 mm links, 0.33 mm hoch
 Streuwert 1.28, horizontal: 1.41, vertikal: 1.14

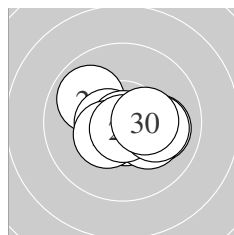

Serie 3:
 9.9 ↘ 10.7 * 10.0 → 10.2 * 10.6 *
 10.9 * 10.4 * 10.8 * 10.1 → 10.4 *
 beste Teiler 16.7 (26.) 43.1 (28.) 67.7 (22.)
 Trefferlage 0.38 mm rechts, 0.21 mm tief
 Streuwert 1.17, horizontal: 1.50, vertikal: 0.69

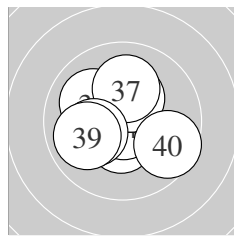

Serie 4:
 10.6 * 10.5 * 10.5 * 10.8 * 10.0 ↘
 10.3 * 10.1 ↑ 10.1 ← 9.9 ← 9.6 ↘
 beste Teiler 32.7 (34.) 96.2 (31.) 110.3 (33.)
 Trefferlage 0.25 mm links, 0.01 mm hoch
 Streuwert 1.45, horizontal: 1.59, vertikal: 1.29

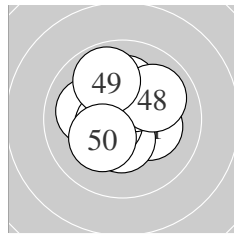

Serie 5:
 10.2 * 10.6 * 10.4 * 10.0 ← 10.6 *
 10.3 * 10.2 * 10.0 ↗ 9.9 ↗ 10.2 *
 beste Teiler 84.3 (42.) 95.5 (45.) 133.1 (43.)
 Trefferlage 0.16 mm links, 0.48 mm hoch
 Streuwert 1.35, horizontal: 1.36, vertikal: 1.34

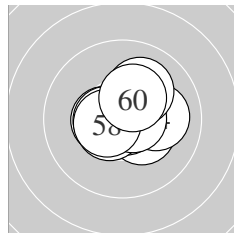

Serie 6:
 10.4 * 10.5 * 10.8 * 10.1 → 10.6 *
 10.5 * 10.7 * 10.5 * 10.1 ↑ 10.3 *
 beste Teiler 27.4 (53.) 67.0 (57.) 100.4 (55.)
 Trefferlage 0.20 mm rechts, 0.14 mm hoch
 Streuwert 1.02, horizontal: 1.19, vertikal: 0.83

Meyton Elektronik

ISSF AR Women – Wertung – Frauen

StandNr: 141

Gleeson,, Katie #479

StartNr: 130

20. Januar 2020 13:42

GBR

Unterschrift des Schützen

Meyton Elektronik

Ergebnis:	622.7	(593)						
Serien:	101.1	103.9	105.4	105.1	105.0	102.2		
Zähler:	53	7	0	0	0	0	0	0
Innenzehner:	49							
weiteste:	365 (9), 361 (60), 325 (6)							
beste Teiler	5.3 (42.)	11.3 (37.)	22.3 (22.)					
Trefferlage	0.22 mm links, 0.26 mm hoch							
Streuwert	1.17, horizontal: 1.18, vertikal: 1.16							

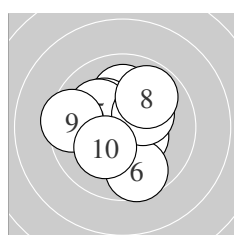
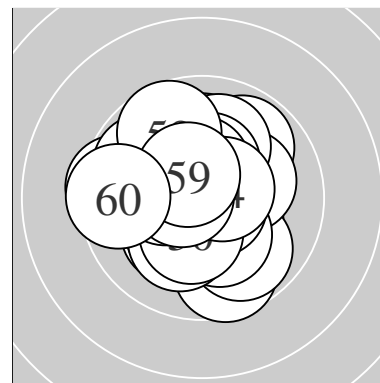

Serie 1:	10.7 *	10.1 ↑	10.5 *	10.2 *	10.1 ↘
	9.7 ↓	10.3 *	9.8 ↗	9.5 ←	10.2 *
beste Teiler	58.2 (1.) 124.3 (3.) 173.1 (7.)				
Trefferlage	0.31 mm links, 0.32 mm hoch				
Streuwert	1.68, horizontal: 1.70, vertikal: 1.66				

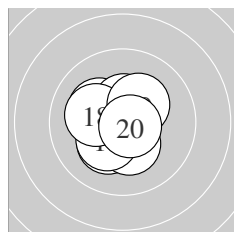

Serie 2:	10.6 *	10.2 *	10.2 *	10.6 *	10.3 *
	10.3 *	10.5 *	10.2 *	10.3 *	10.7 *
beste Teiler	61.7 (20.) 84.8 (11.) 90.1 (14.)				
Trefferlage	0.36 mm links, 0.04 mm tief				
Streuwert	1.08, horizontal: 1.07, vertikal: 1.09				

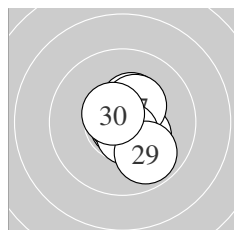

Serie 3:	10.7 *	10.9 *	10.4 *	10.3 *	10.7 *
	10.9 *	10.4 *	10.6 *	9.9 ↓	10.6 *
beste Teiler	22.3 (22.) 23.8 (26.) 56.5 (25.)				
Trefferlage	0.47 mm rechts, 0.17 mm tief				
Streuwert	0.89, horizontal: 0.69, vertikal: 1.05				

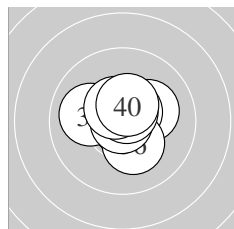

Serie 4:	10.2 *	10.6 *	10.6 *	10.8 *	10.0 ←
	10.3 *	10.9 *	10.7 *	10.5 *	10.5 *
beste Teiler	11.3 (37.) 32.5 (34.) 70.2 (38.)				
Trefferlage	0.09 mm rechts, 0.33 mm hoch				
Streuwert	0.94, horizontal: 1.05, vertikal: 0.81				

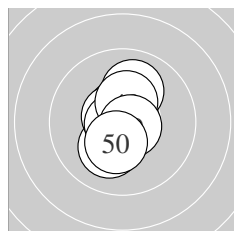

Serie 5:	10.2 *	10.9 *	10.6 *	10.6 *	10.6 *
	10.0 ↑	10.7 *	10.4 *	10.7 *	10.3 *
beste Teiler	5.3 (42.) 52.2 (47.) 62.6 (49.)				
Trefferlage	0.11 mm links, 0.20 mm hoch				
Streuwert	0.95, horizontal: 0.56, vertikal: 1.22				

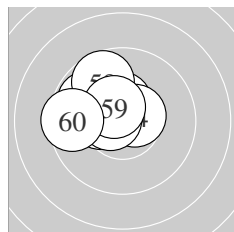

Serie 6:	10.5 *	10.4 *	10.3 *	10.6 *	10.3 *
	9.8 ↘	10.6 *	9.7 ↘	10.5 *	9.5 ←
beste Teiler	87.9 (57.) 94.9 (54.) 101.9 (51.)				
Trefferlage	1.10 mm links, 0.96 mm hoch				
Streuwert	1.07, horizontal: 1.26, vertikal: 0.83				

Meyton Elektronik

ISSF AR Women – Wertung – Frauen

StandNr: 142

Tashtchiev, Olga #342

StartNr: 131

20. Januar 2020 13:43

ISR

Unterschrift des Schützen

Meyton Elektronik

Ergebnis: **624.0** (596)
 Serien: 104.4 103.8 103.2 104.4 103.9 104.3
 Zähler: 56 4 0 0 0 0 0 0 0
 Innenzehner: 49
 weiteste: 293 (44), 273 (26), 259 (23)
 beste Teiler 28.2 (35.) 39.2 (46.) 41.2 (52.)
 Trefferlage 0.18 mm links, 0.02 mm tief
 Streuwert 1.10, horizontal: 1.28, vertikal: 0.88

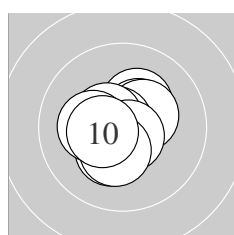
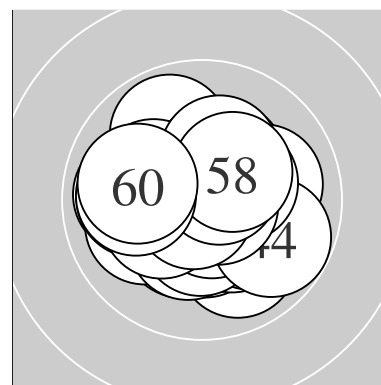

Serie 1:
 10.3 * 10.5 * 10.4 * 10.8 * 10.5 *
 10.3 * 10.7 * 10.3 * 10.2 * 10.4 *
 beste Teiler 48.6 (4.) 65.7 (7.) 110.9 (5.)
 Trefferlage 0.21 mm links, 0.01 mm hoch
 Streuwert 1.00, horizontal: 1.04, vertikal: 0.95

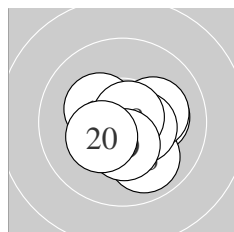

Serie 2:
 10.2 * 10.3 * 10.5 * 10.7 * 9.9 ↘
 10.2 * 10.5 * 10.8 * 10.4 * 10.3 *
 beste Teiler 48.1 (18.) 68.6 (14.) 116.7 (13.)
 Trefferlage 0.54 mm rechts, 0.40 mm tief
 Streuwert 1.07, horizontal: 1.17, vertikal: 0.95

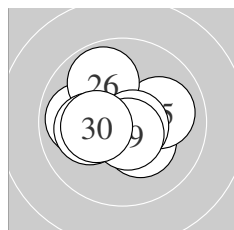

Serie 3:
 10.3 * 10.7 * 9.9 ← 10.7 * 10.0 →
 9.9 ↘ 10.7 * 10.1 ← 10.6 * 10.3 *
 beste Teiler 60.9 (24.) 67.1 (22.) 67.4 (27.)
 Trefferlage 0.37 mm links, 0.14 mm hoch
 Streuwert 1.29, horizontal: 1.52, vertikal: 1.01

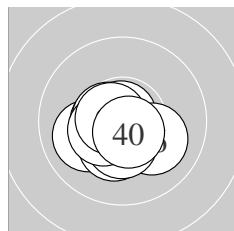

Serie 4:
 10.0 ← 10.5 * 10.6 * 10.3 * 10.8 *
 10.1 ↘ 10.4 * 10.4 * 10.7 * 10.6 *
 beste Teiler 28.2 (35.) 73.5 (39.) 78.2 (40.)
 Trefferlage 0.45 mm links, 0.56 mm tief
 Streuwert 0.89, horizontal: 1.06, vertikal: 0.66

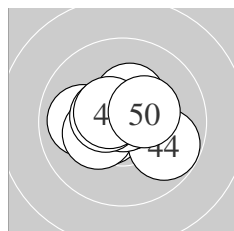

Serie 5:
 10.5 * 10.0 ← 10.3 * 9.8 ↘ 10.7 *
 10.8 * 10.4 * 10.5 * 10.5 * 10.4 *
 beste Teiler 39.2 (46.) 59.9 (45.) 101.0 (49.)
 Trefferlage 0.20 mm links, 0.14 mm hoch
 Streuwert 1.18, horizontal: 1.47, vertikal: 0.80

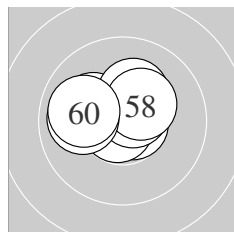

Serie 6:
 10.7 * 10.8 * 10.7 * 10.2 * 10.8 *
 10.6 * 10.2 * 10.3 * 10.0 ← 10.0 ←
 beste Teiler 41.2 (52.) 47.4 (55.) 63.6 (53.)
 Trefferlage 0.39 mm links, 0.52 mm hoch
 Streuwert 1.05, horizontal: 1.36, vertikal: 0.59

Meyton Elektronik

ISSF AR Women – Wertung – Frauen

StandNr: 143

Martina, Lindsay P Veloso #480

StartNr: 132

20. Januar 2020 13:29

SGP

Unterschrift des Schützen

Meyton Elektronik

Ergebnis: **627.3** (599)
 Serien: 104.7 103.6 104.4 104.0 106.2 104.4
 Zähler: 59 1 0 0 0 0 0 0 0
 Innenzehner: 54
 weiteste: 287 (36), 246 (17), 242 (56)
 beste Teiler 13.4 (47.) 33.1 (44.) 42.9 (54.)
 Trefferlage 0.09 mm rechts, 0.10 mm hoch
 Streuwert 0.98, horizontal: 0.95, vertikal: 1.02

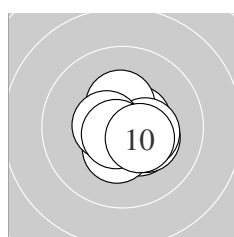
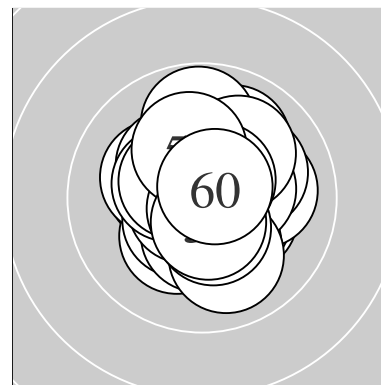

Serie 1:
 10.4 * 10.6 * 10.6 * 10.4 * 10.4 *
 10.3 * 10.4 * 10.5 * 10.7 * 10.4 *
 beste Teiler 62.2 (9.) 90.8 (2.) 100.1 (3.)
 Trefferlage 0.36 mm rechts, 0.32 mm tief
 Streuwert 0.88, horizontal: 0.93, vertikal: 0.82

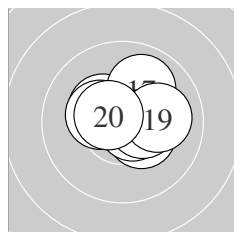

Serie 2:
 10.3 * 10.7 * 10.3 * 10.3 * 10.4 *
 10.7 * 10.0 ↗ 10.4 * 10.0 → 10.5 *
 beste Teiler 69.4 (12.) 70.7 (16.) 101.5 (20.)
 Trefferlage 0.44 mm rechts, 0.49 mm hoch
 Streuwert 1.06, horizontal: 1.26, vertikal: 0.82

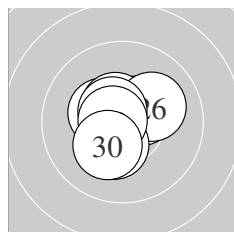

Serie 3:
 10.4 * 10.5 * 10.4 * 10.7 * 10.5 *
 10.1 ↗ 10.3 * 10.6 * 10.7 * 10.2 *
 beste Teiler 56.7 (24.) 65.7 (29.) 95.4 (28.)
 Trefferlage 0.05 mm links, 0.24 mm hoch
 Streuwert 0.99, horizontal: 1.04, vertikal: 0.94

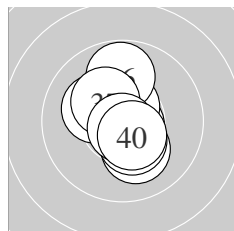

Serie 4:
 10.5 * 10.2 * 10.7 * 10.2 * 10.6 *
 9.8 ↑ 10.3 * 10.4 * 10.8 * 10.5 *
 beste Teiler 44.2 (39.) 54.7 (33.) 94.3 (35.)
 Trefferlage 0.12 mm links, 0.16 mm hoch
 Streuwert 1.16, horizontal: 0.86, vertikal: 1.39

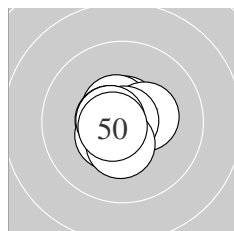

Serie 5:
 10.7 * 10.6 * 10.6 * 10.8 * 10.5 *
 10.4 * 10.9 * 10.6 * 10.4 * 10.7 *
 beste Teiler 13.4 (47.) 33.1 (44.) 71.5 (50.)
 Trefferlage 0.20 mm links, 0.06 mm tief
 Streuwert 0.69, horizontal: 0.69, vertikal: 0.69

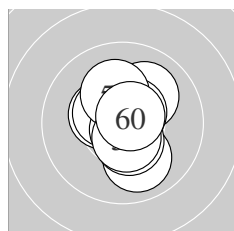

Serie 6:
 10.4 * 10.5 * 10.1 ↗ 10.8 * 10.6 *
 10.0 ↓ 10.2 * 10.5 * 10.6 * 10.7 *
 beste Teiler 42.9 (54.) 66.6 (60.) 93.5 (55.)
 Trefferlage 0.14 mm rechts, 0.12 mm hoch
 Streuwert 1.10, horizontal: 0.85, vertikal: 1.30

Meyton Elektronik

ISSF AR Women – Wertung – Frauen

StandNr: 144

Brabcova, Aneta #29

StartNr: 133

20. Januar 2020 13:38

CZE

Unterschrift des Schützen

Meyton Elektronik

Ergebnis: **625.1** (597)
 Serien: 104.8 104.1 104.5 103.2 103.8 104.7
 Zähler: 57 3 0 0 0 0 0 0 0 0
 Innenzehner: 51
 weiteste: 365 (7), 301 (48), 261 (35)
 beste Teiler 31.7 (37.) 38.4 (4.) 47.4 (52.)
 Trefferlage 0.19 mm links, 0.01 mm hoch
 Streuwert 1.05, horizontal: 1.25, vertikal: 0.80

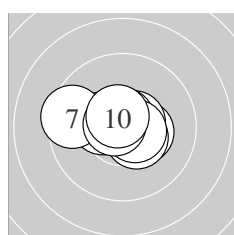
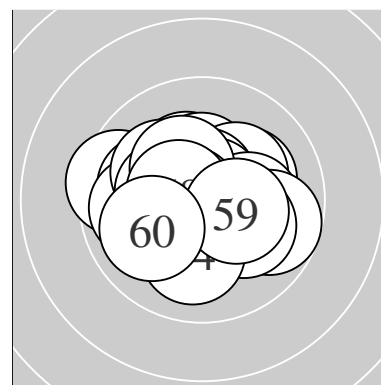

Serie 1:
 10.4 * 10.6 * 10.4 * 10.8 * 10.5 *
 10.7 * 9.5 ← 10.6 * 10.7 * 10.6 *
 beste Teiler 38.4 (4.) 54.0 (6.) 60.4 (9.)
 Trefferlage 0.17 mm links, 0.19 mm hoch
 Streuwert 1.09, horizontal: 1.47, vertikal: 0.49

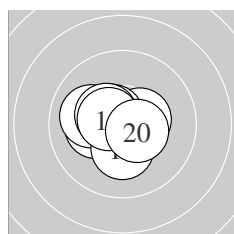

Serie 2:
 10.4 * 10.6 * 10.6 * 10.6 * 10.2 *
 10.0 ← 10.4 * 10.3 * 10.5 * 10.5 *
 beste Teiler 83.1 (14.) 95.4 (12.) 100.9 (13.)
 Trefferlage 0.54 mm links, 0.09 mm tief
 Streuwert 0.97, horizontal: 1.14, vertikal: 0.78

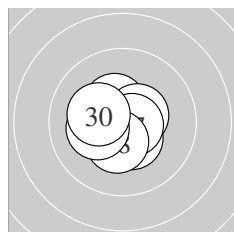

Serie 3:
 10.4 * 10.7 * 10.4 * 10.6 * 10.4 *
 10.5 * 10.7 * 10.4 * 10.2 * 10.2 *
 beste Teiler 55.9 (22.) 69.2 (27.) 91.4 (24.)
 Trefferlage 0.49 mm links, 0.12 mm tief
 Streuwert 0.90, horizontal: 1.01, vertikal: 0.78

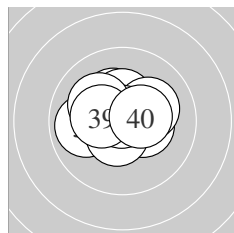

Serie 4:
 10.4 * 10.3 * 10.4 * 10.1 ↗ 9.9 ←
 10.5 * 10.8 * 10.1 ↘ 10.3 * 10.4 *
 beste Teiler 31.7 (37.) 104.5 (36.) 132.9 (40.)
 Trefferlage 0.23 mm links, 0.43 mm hoch
 Streuwert 1.18, horizontal: 1.44, vertikal: 0.83

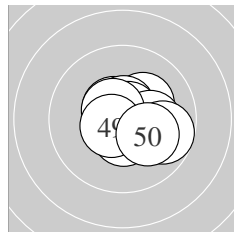

Serie 5:
 10.2 * 10.6 * 10.6 * 10.7 * 10.2 *
 10.6 * 10.5 * 9.7 ↘ 10.6 * 10.1 ↘
 beste Teiler 57.3 (44.) 84.2 (43.) 92.9 (49.)
 Trefferlage 0.64 mm rechts, 0.01 mm tief
 Streuwert 1.09, horizontal: 1.28, vertikal: 0.86

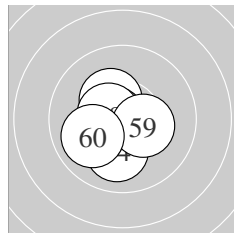

Serie 6:
 10.6 * 10.8 * 10.7 * 10.1 ↓ 10.7 *
 10.3 * 10.7 * 10.5 * 10.3 * 10.0 ←
 beste Teiler 47.4 (52.) 61.2 (57.) 66.0 (55.)
 Trefferlage 0.36 mm links, 0.32 mm tief
 Streuwert 0.97, horizontal: 0.98, vertikal: 0.97

Meyton Elektronik

ISSF AR Women – Wertung – Frauen

StandNr: 145

Benikova, Diana #481

StartNr: 134

20. Januar 2020 13:31

SVK

Unterschrift des Schützen

Meyton Elektronik

Ergebnis:	615.2	(590)							
Serien:	100.6	104.0	102.8	103.5	101.3	103.0			
Zähler:	50	10	0	0	0	0	0	0	0
Innenzehner:	37								
weiteste:	422 (30), 413 (50), 363 (4)								
beste Teiler	22.3 (33.)	22.6 (60.)	38.0 (8.)						
Trefferlage	0.27 mm links, 0.11 mm tief								
Streuwert	1.39, horizontal: 1.62, vertikal: 1.12								

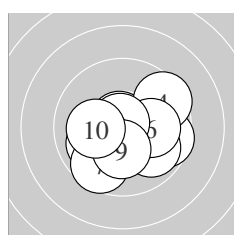
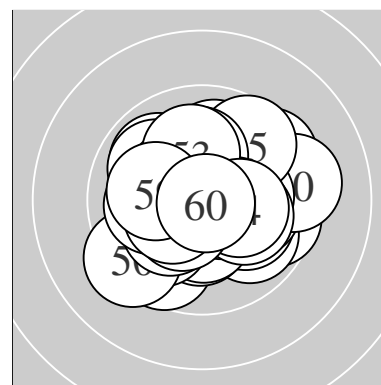

Serie 1:

10.0 ↙	9.6 →	10.7 *	9.5 ↗	9.9 ↘
10.1 →	9.6 ↙	10.8 *	10.3 *	10.1 ←

beste Teiler 38.0 (8.) 55.0 (3.) 168.2 (9.)
 Trefferlage 0.42 mm rechts, 0.54 mm tief
 Streuwert 1.75, horizontal: 2.08, vertikal: 1.35

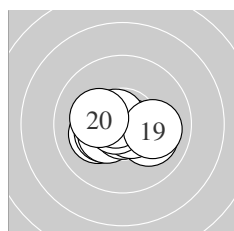

Serie 2:

10.1 ↙	10.3 *	10.4 *	10.1 ↘	10.8 *
10.7 *	10.7 *	10.7 *	10.0 →	10.2 *

beste Teiler 43.0 (15.) 52.1 (17.) 66.8 (18.)
 Trefferlage 0.23 mm links, 0.34 mm tief
 Streuwert 1.10, horizontal: 1.48, vertikal: 0.49

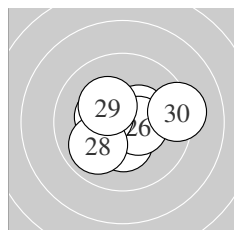

Serie 3:

10.7 *	10.4 *	10.3 *	10.6 *	10.4 *
10.5 *	10.4 *	9.9 ↙	10.3 *	9.3 →

beste Teiler 59.9 (21.) 83.7 (24.) 123.2 (26.)
 Trefferlage 0.03 mm links, 0.08 mm tief
 Streuwert 1.45, horizontal: 1.81, vertikal: 0.96

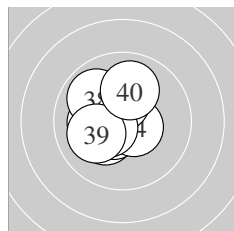

Serie 4:

10.3 *	10.6 *	10.9 *	10.6 *	10.4 *
10.2 *	10.5 *	9.9 ↘	10.1 ↙	10.0 ↑

beste Teiler 22.3 (33.) 96.1 (32.) 97.5 (34.)
 Trefferlage 0.79 mm links, 0.15 mm hoch
 Streuwert 1.15, horizontal: 1.06, vertikal: 1.22

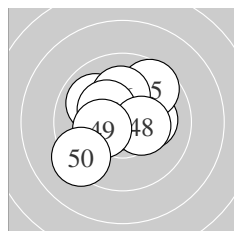

Serie 5:

10.2 *	9.9 ↘	10.7 *	10.5 *	9.6 ↗
10.1 ↑	10.3 *	10.4 *	10.3 *	9.3 ↙

beste Teiler 57.1 (43.) 110.9 (44.) 145.7 (48.)
 Trefferlage 0.42 mm links, 0.41 mm hoch
 Streuwert 1.62, horizontal: 1.76, vertikal: 1.47

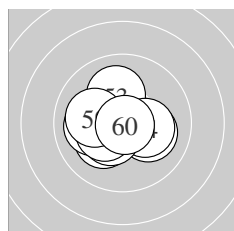

Serie 6:

10.2 *	10.1 ↘	10.1 ↑	10.3 *	10.5 *
10.0 ←	10.4 *	10.4 *	10.1 ↙	10.9 *

beste Teiler 22.6 (60.) 116.8 (55.) 135.2 (57.)
 Trefferlage 0.56 mm links, 0.25 mm tief
 Streuwert 1.23, horizontal: 1.45, vertikal: 0.95

Meyton Elektronik

ISSF AR Women – Wertung – Frauen

StandNr: 141

Auer, Marie–Theres #46

StartNr: 135

19. Januar 2020 13:25

T –SG Roppen

Unterschrift des Schützen

Meyton Elektronik

Ergebnis:	602.9	(576)
Serien:	97.2	102.7 103.8 98.3 101.8 99.1
Zähler:	40	17 2 1 0 0 0 0 0 0
Innenzehner:	32	
weiteste:	820 (8),	517 (35), 502 (5)
beste Teiler	46.0 (18.)	66.6 (17.) 71.6 (23.)
Trefferlage	0.01 mm rechts, 0.53 mm hoch	
Streuwert	1.82, horizontal: 2.19, vertikal: 1.35	

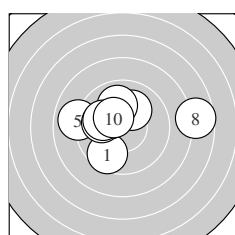
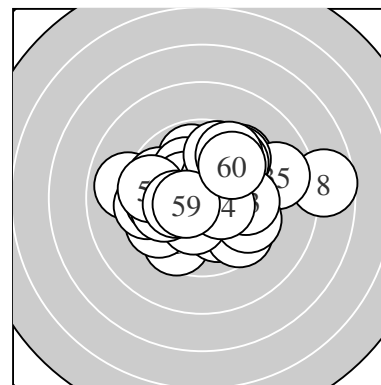

Serie 1:	9.6 ↘	10.2 *	10.3 *	10.1 ↗	8.9 ←
	10.0 ←	10.0 ↑	7.7 →	10.0 ↖	10.4 *
beste Teiler	147.1 (10.) 171.9 (3.) 192.2 (2.)				
Trefferlage	0.51 mm links, 0.83 mm hoch				
Streuwert	2.64, horizontal: 3.43, vertikal: 1.46				

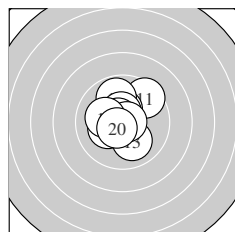

Serie 2:	9.5 ↗	10.4 *	10.0 ↘	10.2 *	9.8 ↑
	10.5 *	10.7 *	10.8 *	10.2 *	10.6 *
beste Teiler	46.0 (18.) 66.6 (17.) 90.5 (20.)				
Trefferlage	0.16 mm links, 0.55 mm hoch				
Streuwert	1.39, horizontal: 1.28, vertikal: 1.50				

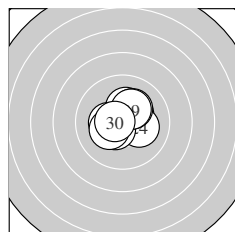

Serie 3:	10.3 *	10.4 *	10.7 *	10.2 *	10.3 *
	10.5 *	10.2 *	10.3 *	10.3 *	10.6 *
beste Teiler	71.6 (23.) 87.2 (30.) 115.9 (26.)				
Trefferlage	0.10 mm rechts, 0.38 mm hoch				
Streuwert	1.09, horizontal: 1.21, vertikal: 0.95				

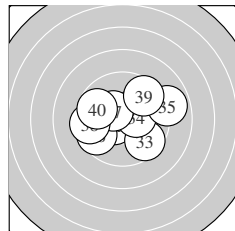

Serie 4:	10.5 *	10.2 *	9.6 ↘	10.3 *	8.9 →
	9.6 ↙	10.4 *	9.5 ←	9.6 ↗	9.7 ↖
beste Teiler	108.7 (31.) 138.9 (37.) 151.4 (34.)				
Trefferlage	0.14 mm rechts, 0.22 mm hoch				
Streuwert	2.28, horizontal: 2.83, vertikal: 1.54				

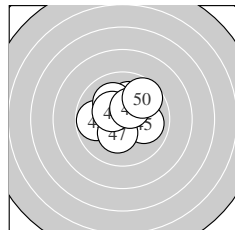

Serie 5:	10.1 ↗	9.8 ←	10.6 *	10.4 *	10.0 →
	10.1 ↘	10.3 *	10.4 *	10.4 *	9.7 ↗
beste Teiler	86.3 (43.) 135.0 (44.) 142.4 (48.)				
Trefferlage	0.19 mm rechts, 0.73 mm hoch				
Streuwert	1.43, horizontal: 1.63, vertikal: 1.20				

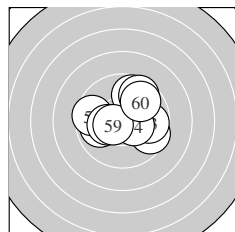

Serie 6:	9.6 ↘	9.7 ↗	9.8 →	10.4 *	9.9 ←
	9.6 ←	10.2 *	9.6 ↗	10.5 *	9.8 ↗
beste Teiler	114.0 (59.) 137.7 (54.) 177.0 (57.)				
Trefferlage	0.34 mm rechts, 0.48 mm hoch				
Streuwert	1.99, horizontal: 2.33, vertikal: 1.58				

Meyton Elektronik

ISSF AR Women – Wertung – Frauen

StandNr: 142

Klingler, Lea #211

StartNr: 136

19. Januar 2020 13:20

T – SG Kramsach

Unterschrift des Schützen

Meyton Elektronik

Ergebnis:	558.8	(531)
Serien:	90.3 95.9 91.7 95.9 86.1 98.9	
Zähler:	21 19 13 4 3 0 0 0 0 0	
Innenzehner:	15	
weiteste:	1197 (7), 1127 (43), 1113 (25)	
beste Teiler	77.8 (48.) 104.4 (53.) 106.0 (55.)	
Trefferlage	1.05 mm links, 0.43 mm hoch	
Streuwert	3.38, horizontal: 4.04, vertikal: 2.54	

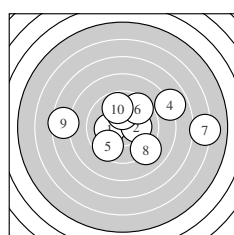
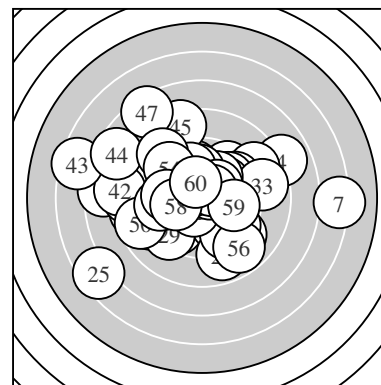

Serie 1:	10.2 *	10.2 *	10.2 *	7.9 ↗	9.6 ↘
	9.6 ↗	6.2 →	9.1 ↘	7.5 ←	9.8 ↑
beste Teiler	189.7 (1.)	190.0 (3.)	200.0 (2.)		
Trefferlage	1.30 mm rechts, 0.48 mm hoch				
Streuwert	4.23, horizontal: 5.54, vertikal: 2.24				

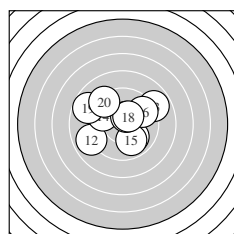

Serie 2:	10.0 ↘	8.9 ↖	8.9 ↗	9.7 ↖	9.9 ↘
	9.6 ↗	10.5 *	10.4 *	8.7 ↖	9.3 ↘
beste Teiler	117.6 (17.)	138.8 (18.)	243.0 (11.)		
Trefferlage	0.34 mm links, 0.70 mm hoch				
Streuwert	2.71, horizontal: 3.22, vertikal: 2.08				

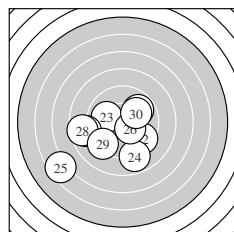

Serie 3:	9.8 ↗	9.5 ↘	10.0 ↖	8.9 ↘	6.5 ↘
	10.4 *	8.8 ←	8.6 ←	9.2 ↗	10.0 ↗
beste Teiler	143.4 (26.)	237.1 (30.)	242.5 (23.)		
Trefferlage	1.54 mm links, 1.65 mm tief				
Streuwert	3.49, horizontal: 4.15, vertikal: 2.68				

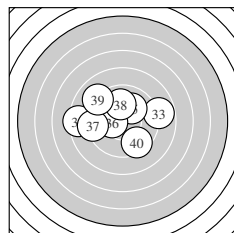

Serie 4:	8.4 ←	10.4 *	8.8 →	10.2 *	10.1 ↗
	10.3 *	9.2 ←	10.0 ↑	9.0 ↖	9.5 ↘
beste Teiler	144.4 (32.)	152.1 (36.)	199.0 (34.)		
Trefferlage	1.05 mm links, 0.56 mm hoch				
Streuwert	2.70, horizontal: 3.38, vertikal: 1.78				

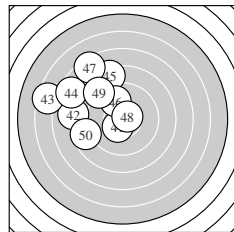

Serie 5:	10.4 *	8.1 ←	6.4 ↖	7.6 ↖	8.3 ↑
	9.8 ↘	7.4 ↘	10.6 *	8.9 ↖	8.6 ←
beste Teiler	77.8 (48.)	133.4 (41.)	277.0 (46.)		
Trefferlage	4.20 mm links, 2.47 mm hoch				
Streuwert	3.36, horizontal: 3.62, vertikal: 3.09				

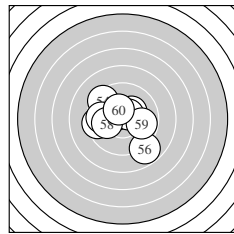

Serie 6:	9.5 ←	10.3 *	10.5 *	9.4 ↖	10.5 *
	8.8 ↘	9.7 ←	10.0 ←	9.8 →	10.4 *
beste Teiler	104.4 (53.)	106.0 (55.)	148.9 (60.)		
Trefferlage	0.51 mm links, 0.04 mm hoch				
Streuwert	2.17, horizontal: 2.47, vertikal: 1.83				

Meyton Elektronik

ISSF AR Women – Wertung – Frauen

StandNr: 143

Außerlechner, Manuela #114

StartNr: 137

19. Januar 2020 13:09

T – SG Kramsach

Unterschrift des Schützen

Meyton Elektronik

Ergebnis:	603.3	(578)
Serien:	100.1 100.3 99.4	100.1 102.0 101.4
Zähler:	42 14 4 0 0 0 0 0 0	
Innenzehner:	30	
weiteste:	670 (8), 658 (56), 647 (26)	
beste Teiler	6.4 (14.) 32.2 (49.) 47.0 (53.)	
Trefferlage	0.48 mm links, 0.66 mm hoch	
Streuwert	1.83, horizontal: 2.24, vertikal: 1.28	

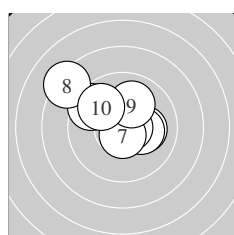
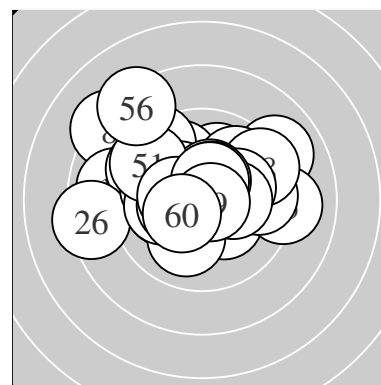

Serie 1:

10.1 →	10.4 *	10.4 *	9.5 ↘	10.2 *
10.7 *	10.7 *	8.3 ↘	10.0 ↑	9.8 ↘
beste Teiler	65.1 (6.) 75.0 (7.) 126.0 (2.)			
Trefferlage	0.39 mm links, 1.01 mm hoch			
Streuwert	1.99, horizontal: 2.36, vertikal: 1.53			

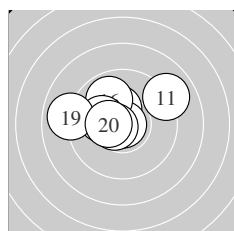

Serie 2:

9.0 ↗	10.3 *	10.1 ↖	10.9 *	10.1 ↖
9.9 ↘	10.6 *	10.1 ↖	8.9 ←	10.4 *
beste Teiler	6.4 (14.) 80.9 (17.) 134.0 (20.)			
Trefferlage	1.05 mm links, 0.86 mm hoch			
Streuwert	1.76, horizontal: 2.29, vertikal: 0.98			

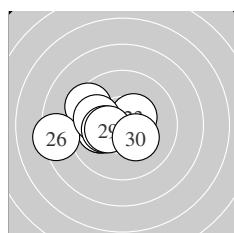

Serie 3:

9.5 ↘	10.0 ←	10.4 *	10.1 ←	10.1 ←
8.4 ←	9.9 ←	10.3 *	10.4 *	10.3 *
beste Teiler	129.6 (23.) 145.8 (29.) 171.9 (30.)			
Trefferlage	1.94 mm links, 0.07 mm tief			
Streuwert	1.65, horizontal: 2.15, vertikal: 0.91			

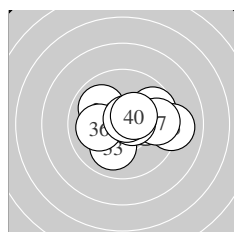

Serie 4:

9.7 ↗	10.1 →	10.0 ↓	9.9 ↘	9.1 →
10.0 ←	9.6 →	10.6 *	10.7 *	10.4 *
beste Teiler	62.8 (39.) 94.9 (38.) 133.2 (40.)			
Trefferlage	1.02 mm rechts, 0.20 mm hoch			
Streuwert	1.77, horizontal: 2.29, vertikal: 1.02			

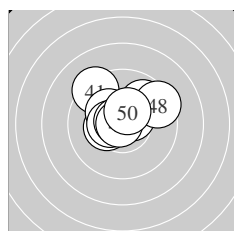

Serie 5:

9.3 ↘	9.8 ↗	10.3 *	10.3 *	10.5 *
10.5 *	10.7 *	9.4 ↗	10.8 *	10.4 *
beste Teiler	32.2 (49.) 58.5 (47.) 103.8 (45.)			
Trefferlage	0.08 mm links, 1.00 mm hoch			
Streuwert	1.48, horizontal: 1.78, vertikal: 1.11			

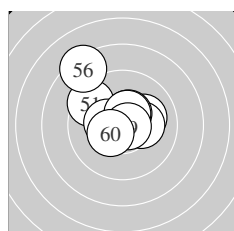

Serie 6:

9.5 ↘	10.1 →	10.8 *	10.2 *	10.5 *
8.3 ↘	10.4 *	10.5 *	10.7 *	10.4 *
beste Teiler	47.0 (53.) 51.6 (59.) 116.0 (58.)			
Trefferlage	0.46 mm links, 0.97 mm hoch			
Streuwert	1.84, horizontal: 1.92, vertikal: 1.75			

Meyton Elektronik

ISSF AR Women – Wertung – Frauen

StandNr: 145

Hofer, Barbara #257

StartNr: 139

19. Januar 2020 13:11

T – SG Kitzbühel

Unterschrift des Schützen

Meyton Elektronik

Ergebnis: **611.7** (583)
 Serien: 102.5 102.3 101.3 100.7 101.7 103.2
 Zähler: 43 17 0 0 0 0 0 0 0
 Innenzehner: 39
 weiteste: 460 (36), 429 (9), 426 (29)
 beste Teiler 22.3 (52.) 36.0 (40.) 56.2 (15.)
 Trefferlage 0.22 mm links, 0.06 mm tief
 Streuwert 1.55, horizontal: 1.60, vertikal: 1.50

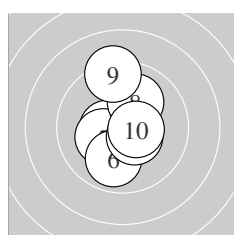
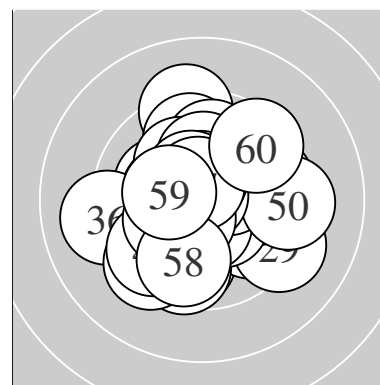

Serie 1:
 10.6 * 10.5 * 10.4 * 10.5 * 10.3 *
 9.9 ↓ 10.5 * 10.1 ↑ 9.2 ↑ 10.5 *
 beste Teiler 99.0 (1.) 101.2 (2.) 108.5 (10.)
 Trefferlage 0.16 mm links, 0.02 mm tief
 Streuwert 1.51, horizontal: 1.05, vertikal: 1.86

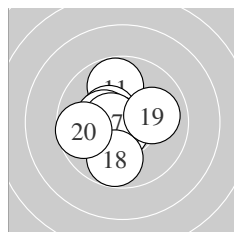

Serie 2:
 9.8 ↑ 10.7 * 10.4 * 10.3 * 10.7 *
 10.3 * 10.6 * 9.8 ↓ 10.0 → 9.7 ←
 beste Teiler 56.2 (15.) 63.3 (12.) 92.3 (17.)
 Trefferlage 0.71 mm links, 0.10 mm tief
 Streuwert 1.41, horizontal: 1.34, vertikal: 1.47

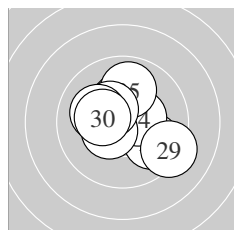

Serie 3:
 9.9 ↘ 10.3 * 10.3 * 10.4 * 9.9 ↑
 10.5 * 10.4 * 10.1 ↙ 9.2 ↘ 10.3 *
 beste Teiler 125.6 (26.) 130.5 (24.) 141.4 (27.)
 Trefferlage 0.22 mm rechts, 0.39 mm hoch
 Streuwert 1.64, horizontal: 1.79, vertikal: 1.48

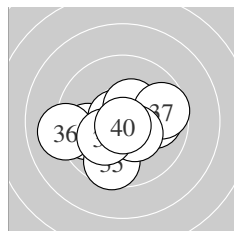

Serie 4:
 10.0 → 9.8 ← 10.7 * 10.4 * 9.6 ↓
 9.1 ← 9.7 → 10.4 * 10.2 * 10.8 *
 beste Teiler 36.0 (40.) 58.1 (33.) 130.1 (34.)
 Trefferlage 0.28 mm links, 0.52 mm tief
 Streuwert 1.84, horizontal: 2.30, vertikal: 1.23

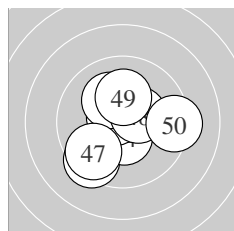

Serie 5:
 10.7 * 9.4 ↙ 10.7 * 10.5 * 10.7 *
 10.2 * 9.6 ↙ 10.4 * 10.2 * 9.3 →
 beste Teiler 64.8 (43.) 72.4 (41.) 73.0 (45.)
 Trefferlage 0.00 mm, 0.20 mm tief
 Streuwert 1.75, horizontal: 1.88, vertikal: 1.61

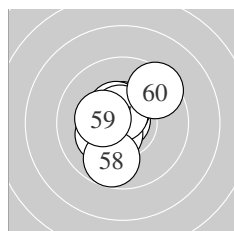

Serie 6:
 10.4 * 10.9 * 10.5 * 10.5 * 10.2 *
 10.5 * 10.6 * 9.8 ↓ 10.3 * 9.5 ↗
 beste Teiler 22.3 (52.) 79.5 (57.) 105.2 (54.)
 Trefferlage 0.37 mm links, 0.05 mm hoch
 Streuwert 1.35, horizontal: 1.17, vertikal: 1.50

Meyton Elektronik

ISSF AR Women – Wertung – Frauen

StandNr: 103

Riccardi, Agata Alina #461

StartNr: 93

20. Januar 2020 13:23

SMR

Unterschrift des Schützen

Meyton Elektronik