

Ergebnis:	<b>617.7</b>	(592) <sup>QF</sup>
Serien:	103.6	102.6 102.8 102.8 103.6 102.3
Zaehler:	52	8 0 0 0 0 0 0 0 0
Innenzehner:	39	
weiteste:	332	(15), 329 (58), 316 (22)
beste Teiler	54.1	(18.) 63.1 (5.) 66.4 (11.)
Trefferlage	0.20 mm	rechts, 0.35 mm hoch
Streuwert	1.25,	horizontal: 1.34, vertikal: 1.16

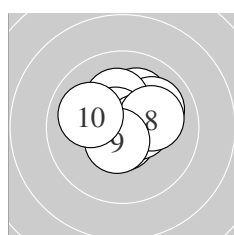

Serie 1:	10.7 *	10.1 ↗	10.0 ↘	10.2 *	10.7 *
	10.7 *	10.5 *	10.1 →	10.6 *	10.0 ↖
beste Teiler	63.1	(5.) 70.7 (6.)	75.0 (1.)		
Trefferlage	0.31 mm	rechts, 0.50 mm hoch			
Streuwert	1.13,	horizontal: 1.28, vertikal: 0.96			

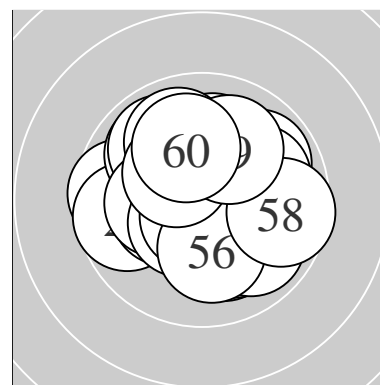
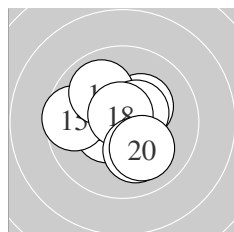

Serie 2:	10.7 *	10.5 *	10.3 *	10.1 ↖	9.6 ←
	10.0 ↘	10.5 *	10.7 *	10.1 ↓	10.1 ↘
beste Teiler	54.1	(18.) 66.4 (11.)	114.2 (17.)		
Trefferlage	0.33 mm	links, 0.25 mm hoch			
Streuwert	1.42,	horizontal: 1.49, vertikal: 1.33			

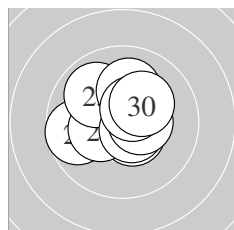

Serie 3:	10.5 *	9.7 ←	10.5 *	10.3 *	9.9 ↖
	10.1 ↑	10.6 *	10.5 *	10.5 *	10.2 *
beste Teiler	83.6	(27.) 104.1 (23.)	106.6 (21.)		
Trefferlage	0.03 mm	links, 0.38 mm hoch			
Streuwert	1.33,	horizontal: 1.52, vertikal: 1.09			

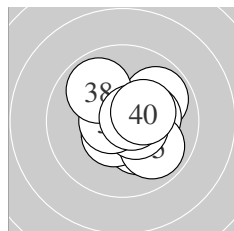

Serie 4:	9.9 ↗	10.2 *	10.5 *	10.2 *	9.9 ↘
	10.6 *	10.6 *	9.9 ↖	10.7 *	10.3 *
beste Teiler	67.4	(39.) 77.0 (37.)	99.0 (36.)		
Trefferlage	0.71 mm	rechts, 0.02 mm hoch			
Streuwert	1.26,	horizontal: 1.31, vertikal: 1.21			

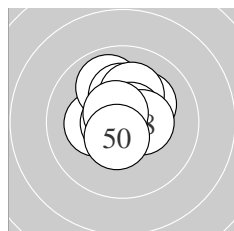

Serie 5:	10.2 *	9.9 ↖	10.7 *	10.2 *	10.2 *
	10.2 *	10.7 *	10.4 *	10.6 *	10.5 *
beste Teiler	67.2	(43.) 72.9 (47.)	76.8 (49.)		
Trefferlage	0.05 mm	links, 0.71 mm hoch			
Streuwert	1.05,	horizontal: 1.03, vertikal: 1.08			

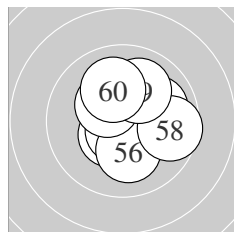

Serie 6:	10.0 →	10.5 *	10.5 *	10.5 *	10.7 *
	10.1 ↓	10.3 *	9.6 →	10.0 ↑	10.1 ↖
beste Teiler	74.6	(55.) 113.2 (53.)	124.7 (52.)		
Trefferlage	0.60 mm	rechts, 0.23 mm hoch			
Streuwert	1.39,	horizontal: 1.40, vertikal: 1.38			

Meyton Elektronik

**ISSF AR Men – Wertung – Junioren**

StandNr: 105

**Thum, Andreas** #86

**StartNr: 82**

21. Januar 2017 13:32

AUT

---

QF – Schütze hat sich fürs Finale qualifiziert

---

Unterschrift des Schuetzen

Meyton Elektronik

Ergebnis:	<b>613.8</b>	(589) <sup>QF</sup>
Serien:	101.4	101.1 102.9 103.2 103.3 101.9
Zaehler:	49	11 0 0 0 0 0 0 0 0
Innenzehner:	36	
weiteste:	429	(40), 407 (13), 352 (10)
beste Teiler	9.4	(43.) 14.2 (15.) 29.0 (48.)
Trefferlage	0.27 mm	links, 0.38 mm hoch
Streuwert	1.41,	horizontal: 1.40, vertikal: 1.42

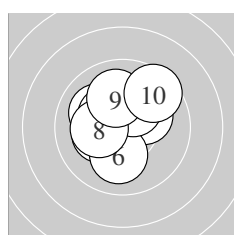
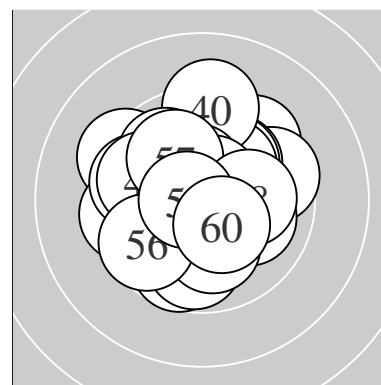

Serie 1:

10.1 ↖	10.5 *	10.2 *	10.3 *	10.2 *
10.1 ↓	10.3 *	10.2 *	10.0 ↑	9.5 ↗
beste Teiler	120.0 (2.)	152.2 (4.)	171.8 (7.)	
Trefferlage	0.26 mm links, 0.77 mm hoch			
Streuwert	1.44, horizontal: 1.49, vertikal: 1.39			

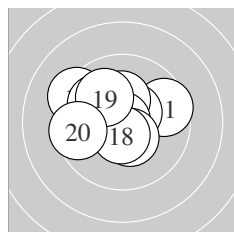

Serie 2:

9.6 →	10.5 *	9.3 ↖	10.3 *	10.9 *
10.4 *	10.0 ↖	10.6 *	10.0 ↖	9.5 ←
beste Teiler	14.2 (15.)	98.7 (18.)	110.3 (12.)	
Trefferlage	0.61 mm links, 0.62 mm hoch			
Streuwert	1.69, horizontal: 2.06, vertikal: 1.22			

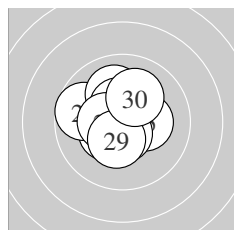

Serie 3:

10.4 *	9.7 ↖	10.5 *	10.0 ↑	10.3 *
10.6 *	10.5 *	10.4 *	10.4 *	10.1 ↗
beste Teiler	88.2 (26.)	109.8 (23.)	123.2 (27.)	
Trefferlage	0.49 mm links, 0.40 mm hoch			
Streuwert	1.23, horizontal: 1.27, vertikal: 1.19			

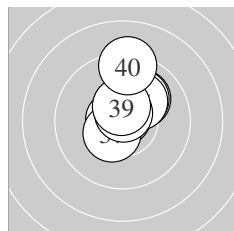

Serie 4:

10.8 *	10.5 *	10.0 ↗	10.1 ↗	10.2 *
10.7 *	10.5 *	10.7 *	10.5 *	9.2 ↑
beste Teiler	33.2 (31.)	62.3 (38.)	62.9 (36.)	
Trefferlage	0.28 mm rechts, 1.16 mm hoch			
Streuwert	1.13, horizontal: 0.81, vertikal: 1.37			

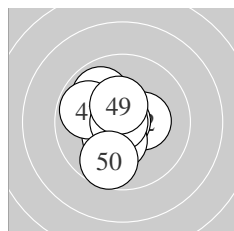

Serie 5:

9.9 ↖	10.3 *	10.9 *	10.4 *	10.7 *
10.4 *	9.8 ↖	10.8 *	10.4 *	9.7 ↓
beste Teiler	9.4 (43.)	29.0 (48.)	71.2 (45.)	
Trefferlage	0.63 mm links, 0.15 mm tief			
Streuwert	1.28, horizontal: 1.09, vertikal: 1.44			

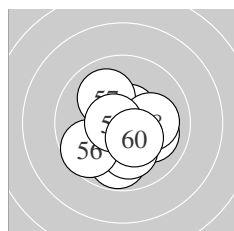

Serie 6:

9.8 ↓	10.5 *	10.6 *	10.0 →	10.1 ↓
9.7 ↗	10.0 ↖	10.1 →	10.7 *	10.4 *
beste Teiler	70.0 (59.)	88.3 (53.)	119.5 (52.)	
Trefferlage	0.05 mm rechts, 0.50 mm tief			
Streuwert	1.50, horizontal: 1.48, vertikal: 1.53			

Meyton Elektronik

**ISSF AR Men – Wertung – Junioren**

StandNr: 106

**Wyrsh, Fabio** #70804628

**StartNr: 83**

21. Januar 2017 13:22

Switzerland

---

QF – Schütze hat sich fürs Finale qualifiziert

---

Unterschrift des Schuetzen

Meyton Elektronik

Ergebnis: **595.7** (570)

Serien: 96.7 101.2 98.4 100.9 99.8 98.7

Zaehler: 33 24 3 0 0 0 0 0 0 0

Innenzehner: 22

weiteste: 647 (54), 542 (8), 501 (3)

beste Teiler 18.6 (28.) 55.0 (55.) 67.0 (51.)

Trefferlage 0.63 mm links, 0.22 mm tief

Streuwert 2.03, horizontal: 2.06, vertikal: 1.99

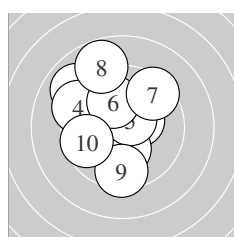
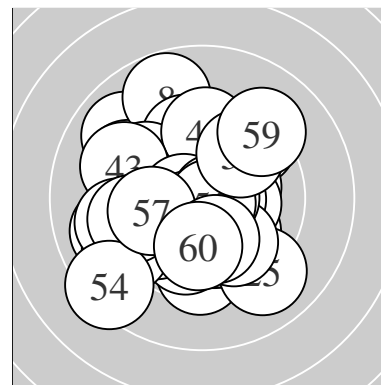

Serie 1:

10.4 *	10.2 *	8.9 ↘	9.3 ↘	10.6 *
10.0 ↘	9.4 ↗	8.8 ↘	9.5 ↓	9.6 ←

beste Teiler 94.7 (5.) 143.7 (1.) 183.8 (2.)

Trefferlage 0.86 mm links, 0.95 mm hoch

Streuwert 2.42, horizontal: 2.20, vertikal: 2.62

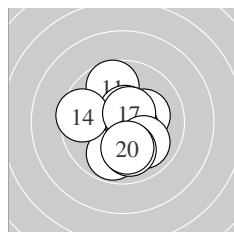

Serie 2:

9.7 ↑	9.8 ↓	10.6 *	9.6 ←	10.2 *
10.6 *	10.6 *	10.0 ↘	10.0 ↓	10.1 ↓

beste Teiler 89.7 (13.) 93.8 (17.) 98.7 (16.)

Trefferlage 0.10 mm rechts, 0.36 mm tief

Streuwert 1.68, horizontal: 1.52, vertikal: 1.83

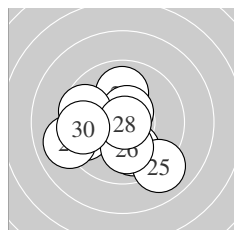

Serie 3:

9.6 ←	10.0 ↑	10.0 ↓	10.6 *	9.0 ↘
10.1 ↓	9.6 ←	10.9 *	9.0 ←	9.6 ←

beste Teiler 18.6 (28.) 92.7 (24.) 216.1 (26.)

Trefferlage 0.94 mm links, 0.71 mm tief

Streuwert 2.16, horizontal: 2.45, vertikal: 1.84

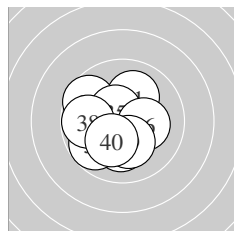

Serie 4:

10.1 ↗	9.6 ↘	10.4 *	10.1 ↓	10.5 *
10.2 *	9.8 ↗	9.8 ←	10.2 *	10.2 *

beste Teiler 101.4 (35.) 142.3 (33.) 181.1 (36.)

Trefferlage 0.52 mm links, 0.36 mm tief

Streuwert 1.61, horizontal: 1.72, vertikal: 1.49

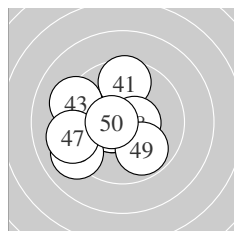

Serie 5:

9.6 ↑	10.6 *	9.2 ↘	10.6 *	9.1 ←
10.6 *	9.2 ←	10.5 *	9.8 ↘	10.6 *

beste Teiler 77.2 (46.) 85.0 (42.) 93.0 (50.)

Trefferlage 1.11 mm links, 0.21 mm tief

Streuwert 1.97, horizontal: 2.18, vertikal: 1.74

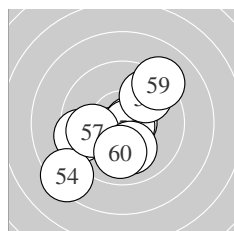

Serie 6:

10.7 *	10.5 *	9.5 ←	8.4 ↗	10.7 *
9.8 ↗	9.9 ←	10.1 ↓	9.1 ↗	10.0 ↓

beste Teiler 55.0 (55.) 67.0 (51.) 105.4 (52.)

Trefferlage 0.48 mm links, 0.62 mm tief

Streuwert 2.34, horizontal: 2.45, vertikal: 2.24

**ISSF AR Men – Wertung – Junioren**

StandNr: 107

**Erler, Sebastian** #70804360

**StartNr: 84**

21. Januar 2017 13:15

T –SG Wattens

---

\_\_\_\_\_  
Unterschrift des Schuetzen

Meyton Elektronik

Ergebnis:	<b>596.8</b>	(570)
Serien:	97.9	100.5 97.3 96.2 101.1 103.8
Zaehler:	35 21 3 1 0 0 0 0 0	
Innenzehner:	27	
weiteste:	909 (35), 595 (28), 550 (30)	
beste Teiler	5.6 (26.) 6.0 (57.) 23.3 (60.)	
Trefferlage	0.60 mm links, 0.65 mm tief	
Streuwert	2.08, horizontal: 2.09, vertikal: 2.07	

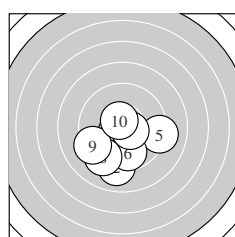
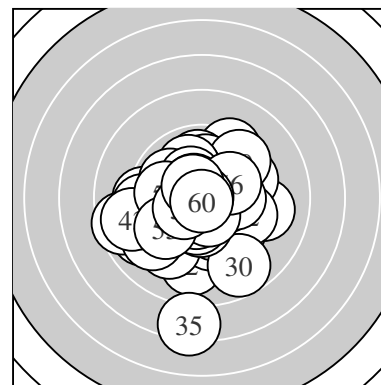

Serie 1:	10.6 *	9.0 ↓	10.1 ↙	9.5 ↘	9.2 →
	9.7 ↓	10.6 *	9.3 ↘	9.3 ↙	10.6 *
beste Teiler	78.6 (1.)	88.5 (10.)	99.8 (7.)		
Trefferlage	0.53 mm links, 1.88 mm tief				
Streuwert	1.96, horizontal: 2.22, vertikal: 1.67				

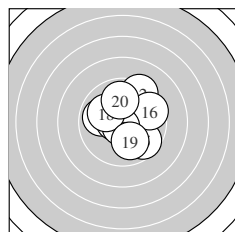

Serie 2:	9.9 ←	9.4 ↗	10.7 *	10.6 *	9.7 ↘
	9.6 →	10.7 *	10.0 ↖	10.0 ↓	9.9 ↑
beste Teiler	57.9 (17.)	63.5 (13.)	91.0 (14.)		
Trefferlage	0.19 mm rechts, 0.44 mm hoch				
Streuwert	1.86, horizontal: 1.89, vertikal: 1.84				

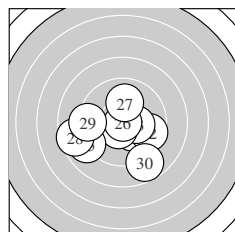

Serie 3:	10.3 *	9.6 →	10.3 *	10.5 *	9.0 ↙
	10.9 *	10.0 ↑	8.6 ←	9.3 ←	8.8 ↓
beste Teiler	5.6 (26.)	105.1 (24.)	163.7 (23.)		
Trefferlage	0.57 mm links, 1.06 mm tief				
Streuwert	2.55, horizontal: 3.09, vertikal: 1.86				

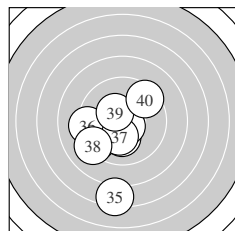

Serie 4:	9.4 ↙	10.2 *	10.2 *	10.6 *	7.3 ↓
	9.3 ←	10.2 *	9.1 ↙	10.4 *	9.5 ↗
beste Teiler	76.4 (34.)	138.9 (39.)	185.7 (37.)		
Trefferlage	1.14 mm links, 1.70 mm tief				
Streuwert	2.61, horizontal: 2.05, vertikal: 3.08				

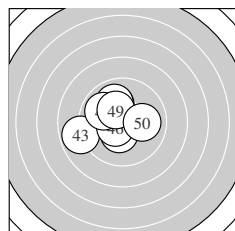

Serie 5:	10.4 *	10.7 *	8.9 ←	10.4 *	10.0 ↖
	10.5 *	10.0 ↖	9.9 ↖	10.3 *	10.0 →
beste Teiler	53.3 (42.)	107.8 (46.)	139.7 (41.)		
Trefferlage	1.00 mm links, 0.40 mm hoch				
Streuwert	1.63, horizontal: 1.82, vertikal: 1.41				

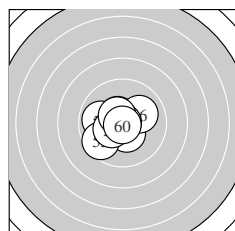

Serie 6:	10.6 *	10.5 *	9.9 ←	10.4 *	9.6 ↙
	10.1 ↗	10.9 *	10.4 *	10.5 *	10.9 *
beste Teiler	6.0 (57.)	23.3 (60.)	79.0 (51.)		
Trefferlage	0.59 mm links, 0.15 mm tief				
Streuwert	1.21, horizontal: 1.38, vertikal: 1.02				

Meyton Elektronik

**ISSF AR Men – Wertung – Junioren**

StandNr: 108

**Einwaller, Dominic** #70804354

**StartNr: 85**

21. Januar 2017 13:27

T – SG Scheffau

---

\_\_\_\_\_  
Unterschrift des Schuetzen

Meyton Elektronik



Ergebnis:	<b>610.0</b>	(587)							
Serien:	101.9	100.6	101.8	102.3	100.6	102.8			
Zaehler:	47	13	0	0	0	0	0	0	0
Innenzehner:	35								
weiteste:	463 (12), 428 (9), 416 (43)								
beste Teiler	13.4 (14.)	40.0 (6.)	44.2 (56.)						
Trefferlage	0.38 mm links, 0.45 mm hoch								
Streuwert	1.48, horizontal: 1.56, vertikal: 1.40								

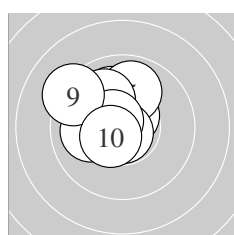
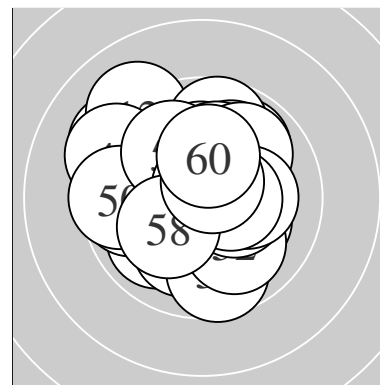

Serie 1:	10.3 *	10.6 *	10.0 ↗	10.0 ←	9.9 ↑
	10.8 *	10.0 ↘	10.6 *	9.2 ↖	10.5 *
beste Teiler	40.0 (6.)	86.8 (8.)	95.2 (2.)		
Trefferlage	0.86 mm links, 1.07 mm hoch				
Streuwert	1.26, horizontal: 1.28, vertikal: 1.23				

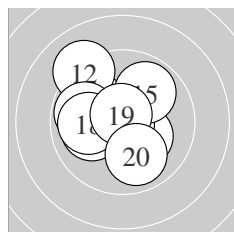

Serie 2:	10.0 ↖	9.1 ↘	10.3 *	10.9 *	9.9 ↗
	10.0 ←	9.8 ←	10.0 ←	10.7 *	9.9 ↘
beste Teiler	13.4 (14.)	57.0 (19.)	174.2 (13.)		
Trefferlage	0.81 mm links, 0.42 mm hoch				
Streuwert	1.74, horizontal: 1.80, vertikal: 1.69				

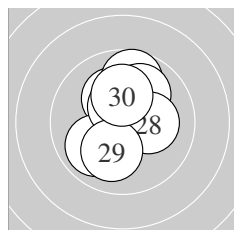

Serie 3:	10.2 *	9.7 ↑	10.5 *	9.9 ↙	10.5 *
	10.0 ↗	10.5 *	10.2 *	10.1 ↓	10.2 *
beste Teiler	115.7 (25.)	115.9 (27.)	121.1 (23.)		
Trefferlage	0.20 mm rechts, 0.69 mm hoch				
Streuwert	1.42, horizontal: 1.17, vertikal: 1.64				

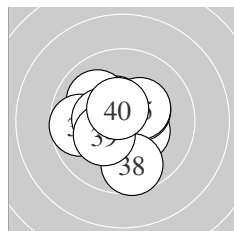

Serie 4:	10.4 *	10.5 *	10.4 *	10.0 ↖	10.3 *
	9.7 ←	10.4 *	9.7 ↓	10.3 *	10.6 *
beste Teiler	97.8 (40.)	114.4 (32.)	139.4 (31.)		
Trefferlage	0.42 mm links, 0.00 mm				
Streuwert	1.44, horizontal: 1.50, vertikal: 1.37				

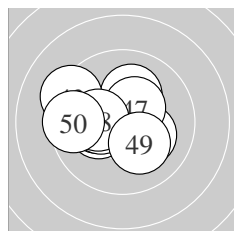

Serie 5:	10.2 *	10.1 ↑	9.3 ↖	10.2 *	10.2 *
	10.3 *	10.4 *	10.2 *	10.2 *	9.5 ←
beste Teiler	135.5 (47.)	157.2 (46.)	177.5 (48.)		
Trefferlage	0.98 mm links, 0.20 mm hoch				
Streuwert	1.59, horizontal: 1.95, vertikal: 1.12				

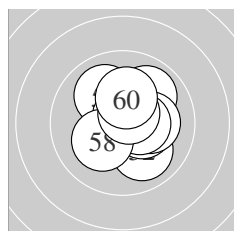

Serie 6:	9.9 ↗	10.0 ↘	10.4 *	10.0 ↖	10.2 *
	10.8 *	10.5 *	10.2 *	10.6 *	10.2 *
beste Teiler	44.2 (56.)	84.0 (59.)	125.0 (57.)		
Trefferlage	0.57 mm rechts, 0.33 mm hoch				
Streuwert	1.27, horizontal: 1.20, vertikal: 1.33				

Meyton Elektronik

**ISSF AR Men – Wertung – Junioren**

StandNr: 109

**Rossiter, Jack** #70804629

**StartNr: 86**

21. Januar 2017 13:32

Australia

---

\_\_\_\_\_  
Unterschrift des Schuetzen

Meyton Elektronik

Ergebnis:	<b>609.5</b>	(584)
Serien:	100.4	102.0 102.1 102.2 100.4 102.4
Zaehler:	45	14 1 0 0 0 0 0 0 0
Innenzehner:	30	
weiteste:	509 (10), 439 (22), 389 (39)	
beste Teiler	23.0 (5.)	30.0 (26.) 52.0 (37.)
Trefferlage	0.28 mm links, 0.28 mm hoch	
Streuwert	1.57, horizontal: 1.57, vertikal: 1.56	

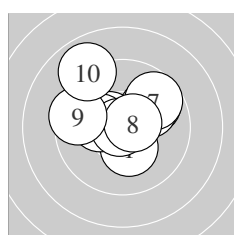
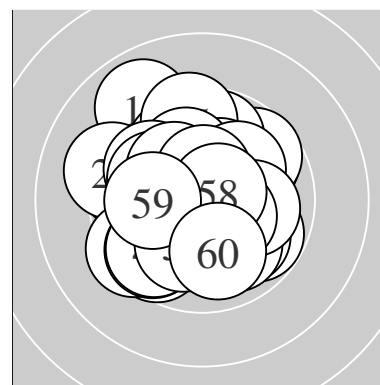

Serie 1:	10.3 *	10.5 *	10.2 *	9.8 ↗	10.9 *
	10.0 ↗	9.7 ↗	10.6 *	9.5 ↖	8.9 ↘
beste Teiler	23.0 (5.)	85.6 (8.)	114.9 (2.)		
Trefferlage	0.12 mm links, 0.99 mm hoch				
Streuwert	1.84, horizontal: 2.09, vertikal: 1.54				

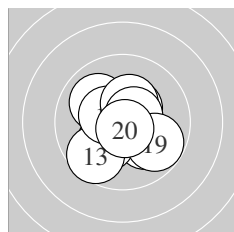

Serie 2:	10.1 ↘	10.1 ↙	9.6 ↙	10.0 ↖	10.4 *
	10.4 *	10.3 *	10.6 *	9.8 ↘	10.7 *
beste Teiler	52.8 (20.)	98.9 (18.)	128.8 (16.)		
Trefferlage	0.01 mm rechts, 0.24 mm tief				
Streuwert	1.51, horizontal: 1.56, vertikal: 1.45				

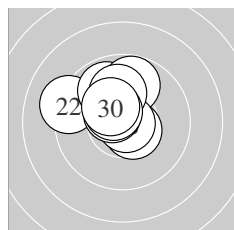

Serie 3:	10.5 *	9.2 ↖	9.9 ↘	10.6 *	9.8 ↑
	10.8 *	10.5 *	10.0 ↑	10.5 *	10.3 *
beste Teiler	30.0 (26.)	92.4 (24.)	101.8 (21.)		
Trefferlage	0.69 mm links, 1.16 mm hoch				
Streuwert	1.26, horizontal: 1.40, vertikal: 1.11				

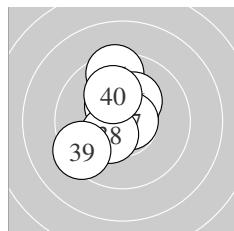

Serie 4:	10.5 *	10.4 *	10.4 *	10.6 *	9.5 ↑
	10.2 *	10.7 *	10.4 *	9.4 ↙	10.1 ↑
beste Teiler	52.0 (37.)	77.8 (34.)	118.1 (31.)		
Trefferlage	0.43 mm links, 0.81 mm hoch				
Streuwert	1.43, horizontal: 1.16, vertikal: 1.65				

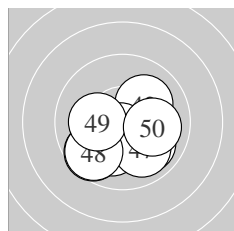

Serie 5:	10.1 ↘	10.1 ↗	10.0 ↘	9.7 ↙	10.6 *
	10.1 ↙	9.9 ↘	9.7 ↙	10.2 *	10.0 →
beste Teiler	77.8 (45.)	195.0 (49.)	209.3 (46.)		
Trefferlage	0.15 mm rechts, 1.12 mm tief				
Streuwert	1.56, horizontal: 1.86, vertikal: 1.20				

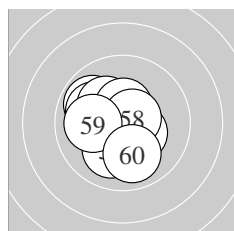

Serie 6:	9.9 ↖	10.7 *	10.4 *	10.0 ↖	10.1 ↙
	10.2 *	10.5 *	10.6 *	10.0 ←	10.0 ↓
beste Teiler	69.0 (52.)	84.0 (58.)	123.1 (57.)		
Trefferlage	0.61 mm links, 0.09 mm hoch				
Streuwert	1.37, horizontal: 1.36, vertikal: 1.38				

Meyton Elektronik

**ISSF AR Men** – Wertung – **Junioren**

StandNr: 110

**Riedo, Sven** #70804630

**StartNr: 87**

21. Januar 2017 13:36

Switzerland

---

\_\_\_\_\_  
Unterschrift des Schuetzen

Meyton Elektronik

Ergebnis: **605.3** (575)  
 Serien: 98.4 102.9 101.6 100.8 98.6 103.0  
 Zaehler: 37 21 2 0 0 0 0 0 0 0  
 Innenzehner: 30  
 weiteste: 644 (4), 511 (46), 482 (57)  
 beste Teiler 33.0 (37.) 49.4 (52.) 50.1 (58.)  
 Trefferlage 0.30 mm links, 0.05 mm tief  
 Streuwert 1.76, horizontal: 2.10, vertikal: 1.33

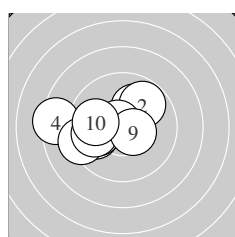
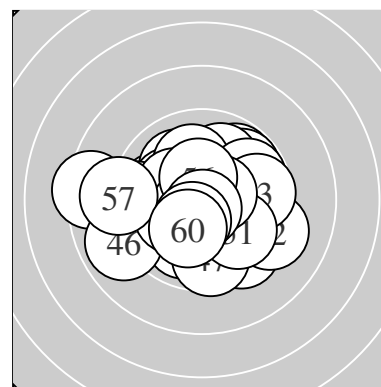

Serie 1:  
 10.1 ↗ 9.8 ↗ 9.9 ← 8.4 ← 10.7 \*  
 10.0 ← 9.3 ← 9.8 ← 10.5 \* 9.9 ←  
 beste Teiler 58.4 (5.) 111.4 (9.) 221.4 (1.)  
 Trefferlage 1.71 mm links, 0.17 mm hoch  
 Streuwert 2.01, horizontal: 2.59, vertikal: 1.16

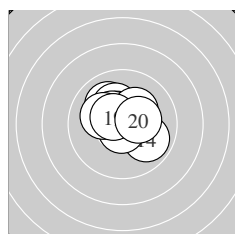

Serie 2:  
 10.0 ↘ 10.2 \* 10.5 \* 9.9 ↘ 10.7 \*  
 10.4 \* 10.3 \* 10.1 ↖ 10.5 \* 10.3 \*  
 beste Teiler 56.8 (15.) 106.6 (13.) 112.6 (19.)  
 Trefferlage 0.15 mm links, 0.66 mm hoch  
 Streuwert 1.19, horizontal: 1.36, vertikal: 0.99

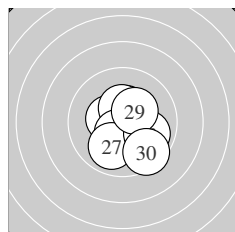

Serie 3:  
 9.9 ↘ 10.4 \* 10.4 \* 10.4 \* 10.4 \*  
 10.5 \* 9.9 ↓ 9.9 ↘ 10.3 \* 9.5 ↘  
 beste Teiler 114.5 (26.) 128.4 (23.) 131.2 (24.)  
 Trefferlage 0.63 mm rechts, 0.44 mm tief  
 Streuwert 1.46, horizontal: 1.36, vertikal: 1.55

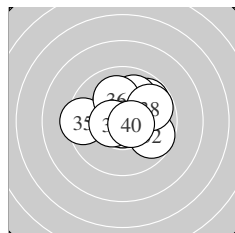

Serie 4:  
 9.8 ↗ 9.7 ↘ 10.1 ↑ 10.0 ↗ 9.4 ←  
 10.1 ↑ 10.8 \* 9.8 ↗ 10.5 \* 10.6 \*  
 beste Teiler 33.0 (37.) 86.9 (40.) 102.8 (39.)  
 Trefferlage 0.35 mm rechts, 0.72 mm hoch  
 Streuwert 1.69, horizontal: 2.01, vertikal: 1.29

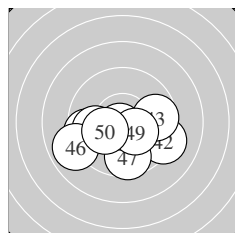

Serie 5:  
 10.6 \* 9.2 ↘ 9.7 → 9.5 ← 9.9 ←  
 8.9 ← 9.6 ↓ 10.7 \* 10.3 \* 10.2 \*  
 beste Teiler 51.6 (48.) 77.3 (41.) 152.0 (49.)  
 Trefferlage 0.40 mm links, 1.16 mm tief  
 Streuwert 2.08, horizontal: 2.74, vertikal: 1.06

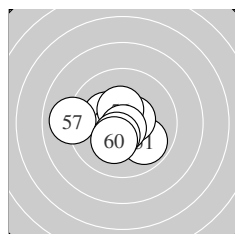

Serie 6:  
 9.9 ↘ 10.8 \* 10.3 \* 10.6 \* 10.6 \*  
 10.4 \* 9.0 ← 10.8 \* 10.4 \* 10.2 \*  
 beste Teiler 49.4 (52.) 50.1 (58.) 93.2 (54.)  
 Trefferlage 0.56 mm links, 0.25 mm tief  
 Streuwert 1.47, horizontal: 1.80, vertikal: 1.04

**ISSF AR Men – Wertung – Junioren**

StandNr: 111

**Alther, Christian** #70804631

**StartNr: 88**

21. Januar 2017 13:40

Switzerland

---

\_\_\_\_\_  
Unterschrift des Schuetzen

Meyton Elektronik

Ergebnis: **612.0** (583)

Serien: 103.1 103.1 103.0 103.8 99.2 99.8

Zaehler: 44 15 1 0 0 0 0 0 0 0

Innenzehner: 38

weiteste: 516 (42), 445 (58), 416 (41)

beste Teiler 5.0 (12.) 49.4 (33.) 52.0 (9.)

Trefferlage 0.32 mm rechts, 0.30 mm hoch

Streuwert 1.53, horizontal: 1.40, vertikal: 1.65

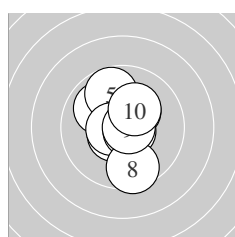
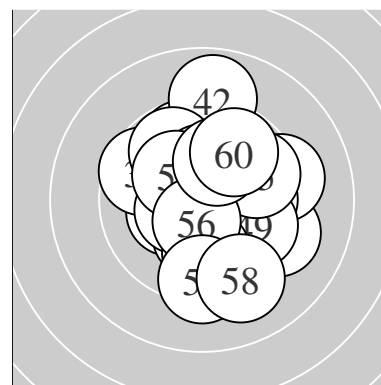

Serie 1:

10.0 ↘	10.3 *	10.6 *	10.6 *	9.8 ↗
10.6 *	10.7 *	9.6 ↓	10.7 *	10.2 *

beste Teiler 52.0 (9.) 67.2 (7.) 81.0 (3.)

Trefferlage 0.07 mm links, 0.19 mm hoch

Streuwert 1.42, horizontal: 1.02, vertikal: 1.74

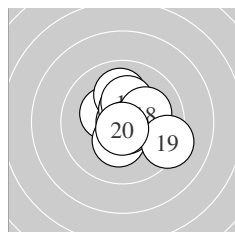

Serie 2:

10.3 *	10.9 *	10.0 ↑	10.5 *	10.3 *
10.3 *	10.7 *	10.1 →	9.3 ↘	10.7 *

beste Teiler 5.0 (12.) 55.7 (17.) 56.1 (20.)

Trefferlage 0.46 mm rechts, 0.24 mm hoch

Streuwert 1.38, horizontal: 1.43, vertikal: 1.32

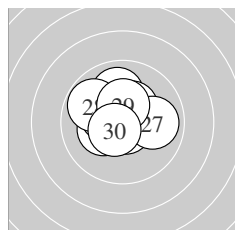

Serie 3:

10.0 ↑	10.5 *	10.3 *	10.4 *	10.4 *
10.7 *	9.9 →	9.8 ↘	10.4 *	10.6 *

beste Teiler 54.1 (26.) 95.4 (30.) 109.1 (22.)

Trefferlage 0.19 mm links, 0.57 mm hoch

Streuwert 1.26, horizontal: 1.44, vertikal: 1.04

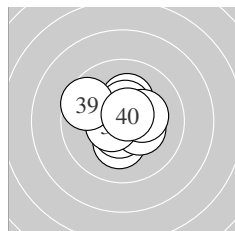

Serie 4:

10.2 *	10.2 *	10.8 *	10.6 *	10.3 *
10.5 *	10.6 *	10.3 *	9.6 ↘	10.7 *

beste Teiler 49.4 (33.) 70.0 (40.) 93.6 (34.)

Trefferlage 0.01 mm rechts, 0.19 mm hoch

Streuwert 1.23, horizontal: 1.31, vertikal: 1.13

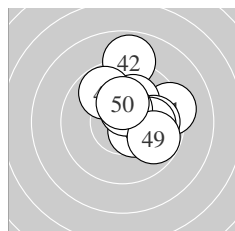

Serie 5:

9.3 →	8.9 ↑	10.2 *	9.8 ↘	10.5 *
9.9 →	10.0 →	10.5 *	9.8 ↘	10.3 *

beste Teiler 109.8 (48.) 123.6 (45.) 161.0 (50.)

Trefferlage 1.28 mm rechts, 1.10 mm hoch

Streuwert 1.73, horizontal: 1.60, vertikal: 1.85

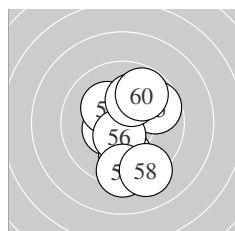

Serie 6:

10.4 *	10.7 *	10.2 *	9.9 ↓	9.7 →
10.5 *	9.3 ↓	9.2 ↓	10.1 ↑	9.8 ↗

beste Teiler 71.4 (52.) 110.6 (56.) 130.7 (51.)

Trefferlage 0.47 mm rechts, 0.46 mm tief

Streuwert 1.95, horizontal: 1.33, vertikal: 2.41

**ISSF AR Men – Wertung – Junioren**

StandNr: 113

**Chan, Emmanuel En Yue** #70804632

**StartNr: 90**

21. Januar 2017 13:24

Singapore

---

Unterschrift des Schuetzen

---

Meyton Elektronik



Ergebnis:	<b>611.3</b>	(581)							
Serien:	101.7	101.9	102.9	100.9	102.1	101.8			
Zaehler:	41	19	0	0	0	0	0	0	0
Innenzehner:	37								
weiteste:	490 (10), 432 (5), 406 (59)								
beste Teiler	48.0 (49.)	49.4 (4.)	52.6 (30.)						
Trefferlage	0.11 mm links, 0.07 mm hoch								
Streuwert	1.56, horizontal: 1.62, vertikal: 1.50								

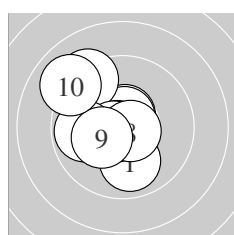
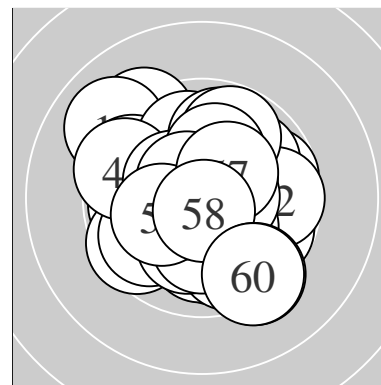

Serie 1:	9.9 ↓	10.6 *	10.7 *	10.8 *	9.2 ↗
	10.7 *	9.8 ←	10.7 *	10.3 *	9.0 ↖
beste Teiler	49.4 (4.)	64.4 (8.)	72.8 (6.)		
Trefferlage	1.03 mm links, 0.37 mm hoch				
Streuwert	1.67, horizontal: 1.55, vertikal: 1.78				

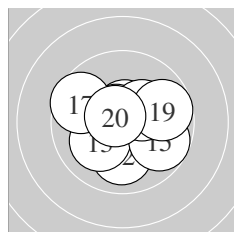

Serie 2:	10.4 *	10.0 ↓	10.1 ↙	10.6 *	9.8 ↘
	10.7 *	9.6 ↖	10.3 *	9.7 →	10.7 *
beste Teiler	70.4 (20.)	70.8 (16.)	87.4 (14.)		
Trefferlage	0.13 mm rechts, 0.13 mm tief				
Streuwert	1.59, horizontal: 1.83, vertikal: 1.31				

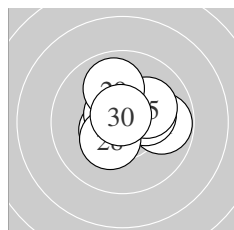

Serie 3:	9.8 →	10.3 *	10.2 *	10.5 *	10.1 ↗
	10.5 *	10.6 *	10.3 *	9.9 ↑	10.7 *
beste Teiler	52.6 (30.)	84.1 (27.)	101.6 (24.)		
Trefferlage	0.24 mm rechts, 0.56 mm hoch				
Streuwert	1.21, horizontal: 1.35, vertikal: 1.05				

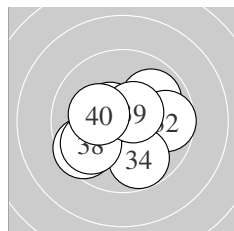

Serie 4:	9.9 ↗	9.7 →	10.3 *	9.8 ↓	10.5 *
	10.5 *	9.6 ↙	9.8 ↙	10.6 *	10.2 *
beste Teiler	100.7 (39.)	109.0 (36.)	123.4 (35.)		
Trefferlage	0.33 mm links, 0.23 mm tief				
Streuwert	1.72, horizontal: 2.01, vertikal: 1.38				

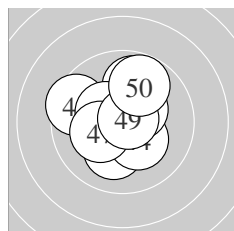

Serie 5:	10.1 ↓	9.9 ↑	10.7 *	10.3 *	9.5 ↖
	10.4 *	10.2 *	10.4 *	10.8 *	9.8 ↑
beste Teiler	48.0 (49.)	59.4 (43.)	143.2 (48.)		
Trefferlage	0.27 mm links, 0.40 mm hoch				
Streuwert	1.52, horizontal: 1.50, vertikal: 1.54				

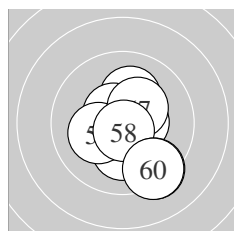

Serie 6:	10.2 *	10.5 *	10.2 *	10.6 *	10.5 *
	10.2 *	10.3 *	10.7 *	9.3 ↓	9.3 ↓
beste Teiler	57.5 (58.)	95.4 (54.)	109.6 (52.)		
Trefferlage	0.57 mm rechts, 0.54 mm tief				
Streuwert	1.57, horizontal: 1.25, vertikal: 1.83				

Meyton Elektronik

**ISSF AR Men – Wertung – Junioren**

StandNr: 114

**Moser, Manuel** #70804356

**StartNr: 91**

21. Januar 2017 13:24

T – SG Münster

---

\_\_\_\_\_  
Unterschrift des Schuetzen

Meyton Elektronik

Ergebnis:	<b>599.1</b>	(573)
Serien:	102.6	100.5 98.6 100.4 99.5 97.5
Zaehler:	35 23 2 0 0 0 0 0 0 0	
Innenzehner:	30	
weiteste:	645 (54), 524 (35), 500 (58)	
beste Teiler	36.4 (6.) 46.8 (4.) 54.8 (22.)	
Trefferlage	1.35 mm rechts, 0.01 mm hoch	
Streuwert	1.80, horizontal: 2.10, vertikal: 1.42	

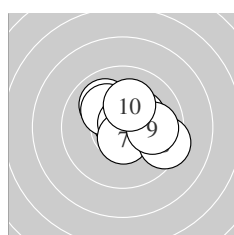
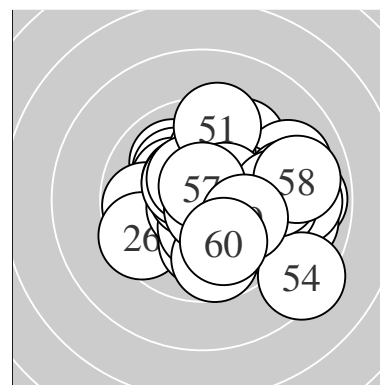

Serie 1:	10.0 ↘	10.3 *	10.4 *	10.8 *	10.2 *
	10.8 *	10.6 *	9.4 →	9.9 →	10.2 *
beste Teiler	36.4 (6.)	46.8 (4.)	92.3 (7.)		
Trefferlage	0.61 mm rechts, 0.55 mm hoch				
Streuwert	1.38, horizontal: 1.60, vertikal: 1.11				

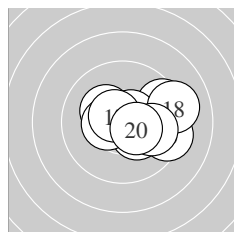

Serie 2:	10.3 *	10.3 *	9.5 →	10.6 *	9.4 →
	10.4 *	10.6 *	9.1 →	9.9 →	10.4 *
beste Teiler	87.6 (17.)	88.6 (14.)	129.2 (20.)		
Trefferlage	1.37 mm rechts, 0.13 mm hoch				
Streuwert	1.64, horizontal: 2.11, vertikal: 0.95				

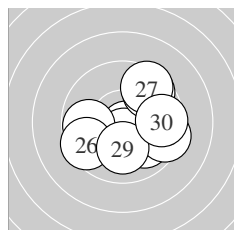

Serie 3:	9.9 ↘	10.7 *	10.5 *	9.8 ←	9.6 ↗
	9.5 ↙	9.5 ↗	9.4 →	10.1 ↓	9.6 →
beste Teiler	54.8 (22.)	105.6 (23.)	221.0 (29.)		
Trefferlage	0.76 mm rechts, 0.30 mm tief				
Streuwert	2.08, horizontal: 2.34, vertikal: 1.77				

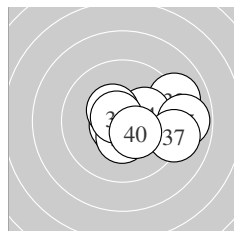

Serie 4:	10.6 *	9.0 →	10.7 *	10.2 *	8.9 →
	10.4 *	9.1 →	10.4 *	10.7 *	10.4 *
beste Teiler	61.5 (39.)	72.2 (33.)	84.1 (31.)		
Trefferlage	1.46 mm rechts, 0.09 mm tief				
Streuwert	1.84, horizontal: 2.39, vertikal: 1.05				

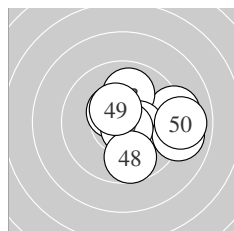

Serie 5:	9.2 →	10.5 *	10.0 ↑	10.5 *	10.4 *
	9.0 →	10.7 *	9.7 ↓	10.5 *	9.0 →
beste Teiler	65.7 (47.)	106.5 (44.)	121.6 (42.)		
Trefferlage	1.61 mm rechts, 0.08 mm tief				
Streuwert	1.90, horizontal: 2.24, vertikal: 1.48				

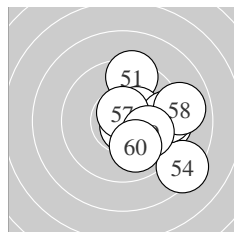

Serie 6:	9.4 ↑	9.5 →	10.7 *	8.4 ↘	10.4 *
	9.4 →	10.7 *	9.0 →	10.0 →	10.0 ↓
beste Teiler	56.0 (53.)	71.0 (57.)	138.0 (55.)		
Trefferlage	2.30 mm rechts, 0.11 mm tief				
Streuwert	1.98, horizontal: 1.92, vertikal: 2.04				

**ISSF AR Men – Wertung – Junioren**

StandNr: 115

**Sohm, Jodok** #103

**StartNr: 92**

21. Januar 2017 13:26

AUT

---

\_\_\_\_\_  
Unterschrift des Schuetzen

Meyton Elektronik

Ergebnis:	<b>611.5</b>	(585)						
Serien:	102.4	102.5	104.2	101.3	100.7	100.4		
Zaehler:	45	15	0	0	0	0	0	0
Innenzehner:	36							
weiteste:	453 (50), 444 (49), 411 (54)							
beste Teiler	8.2 (17.) 41.3 (25.) 46.0 (43.)							
Trefferlage	0.20 mm links, 0.31 mm hoch							
Streuwert	1.53, horizontal: 1.64, vertikal: 1.40							

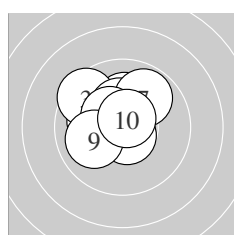
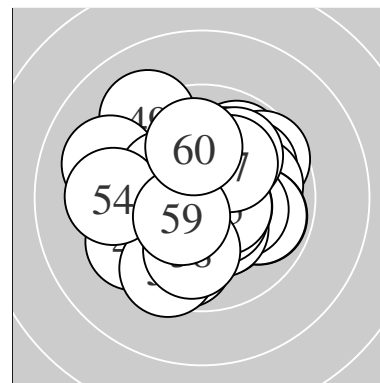

Serie 1:					
	10.2 *	10.1 ←	9.5 ↘	10.7 *	10.7 *
	10.3 *	9.8 ↗	10.4 *	10.0 ←	10.7 *
beste Teiler	72.9 (5.) 74.2 (10.) 74.4 (4.)				
Trefferlage	0.55 mm links, 0.92 mm hoch				
Streuwert	1.27, horizontal: 1.40, vertikal: 1.12				

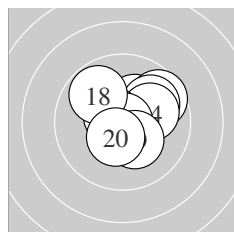

Serie 2:					
	10.3 *	9.6 ↗	9.9 ↗	10.1 →	10.6 *
	10.6 *	10.9 *	9.8 ↘	10.3 *	10.4 *
beste Teiler	8.2 (17.) 85.0 (16.) 91.0 (15.)				
Trefferlage	0.58 mm rechts, 0.46 mm hoch				
Streuwert	1.37, horizontal: 1.47, vertikal: 1.26				

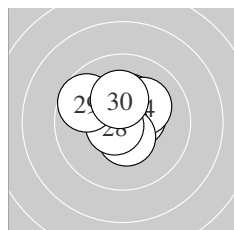

Serie 3:					
	10.7 *	10.5 *	10.3 *	10.2 *	10.8 *
	10.6 *	10.5 *	10.7 *	9.7 ↘	10.2 *
beste Teiler	41.3 (25.) 56.1 (21.) 67.5 (28.)				
Trefferlage	0.10 mm links, 0.46 mm hoch				
Streuwert	1.09, horizontal: 1.16, vertikal: 1.01				

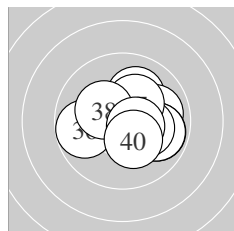

Serie 4:					
	10.1 ↗	10.0 →	9.9 →	9.9 →	10.2 *
	9.8 ←	10.3 *	10.3 *	10.5 *	10.3 *
beste Teiler	107.7 (39.) 163.6 (40.) 166.4 (37.)				
Trefferlage	0.88 mm rechts, 0.01 mm hoch				
Streuwert	1.49, horizontal: 1.79, vertikal: 1.10				

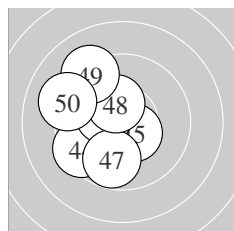

Serie 5:					
	10.7 *	10.4 *	10.8 *	9.5 ←	10.5 *
	10.3 *	9.8 ↓	10.4 *	9.2 ↘	9.1 ←
beste Teiler	46.0 (43.) 58.7 (41.) 116.6 (45.)				
Trefferlage	1.37 mm links, 0.00 mm				
Streuwert	1.71, horizontal: 1.52, vertikal: 1.89				

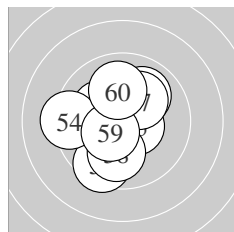

Serie 6:					
	10.4 *	9.5 ↓	10.2 *	9.3 ←	10.5 *
	10.0 ↗	10.1 ↗	10.0 ↓	10.4 *	10.0 ↑
beste Teiler	105.8 (55.) 128.1 (59.) 136.3 (51.)				
Trefferlage	0.67 mm links, 0.03 mm hoch				
Streuwert	1.76, horizontal: 1.68, vertikal: 1.83				

**ISSF AR Men – Wertung – Junioren**

StandNr: 116

**Diem, Patrick #81**

**StartNr: 93**

21. Januar 2017 13:34

AUT

---

Unterschrift des Schuetzen

Meyton Elektronik

Ergebnis:	<b>606.9</b>	(578)
Serien:	100.0	100.7 101.4 102.1 100.0 102.7
Zaehler:	38 22 0 0 0 0 0 0 0	
Innenzehner:	34	
weiteste:	465 (50), 445 (6), 427 (17)	
beste Teiler	3.6 (39.) 15.2 (1.) 32.2 (53.)	
Trefferlage	0.14 mm links, 0.66 mm tief	
Streuwert	1.64, horizontal: 1.71, vertikal: 1.57	

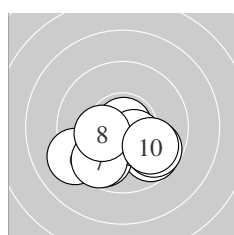
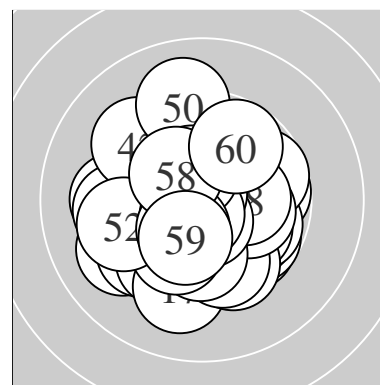

Serie 1:	10.9 *	9.7 ↘	9.8 ✓	10.3 *	10.5 *
	9.2 ↙	9.7 ✓	10.3 *	9.7 ↘	9.9 ↘
beste Teiler	15.2 (1.)	123.8 (5.)	156.9 (4.)		
Trefferlage	0.19 mm links, 1.51 mm tief				
Streuwert	1.64, horizontal: 2.12, vertikal: 0.92				

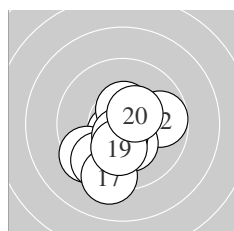

Serie 2:	10.6 *	9.8 →	9.5 ↙	9.6 ✓	10.5 *
	10.3 *	9.2 ↓	10.6 *	10.2 *	10.4 *
beste Teiler	92.8 (11.)	96.5 (18.)	117.3 (15.)		
Trefferlage	0.22 mm links, 1.20 mm tief				
Streuwert	1.65, horizontal: 1.59, vertikal: 1.70				

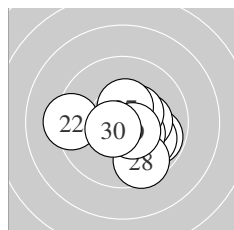

Serie 3:	9.8 ↘	9.3 ←	10.0 ↘	10.3 *	10.4 *
	10.4 *	10.5 *	9.6 ↓	10.5 *	10.6 *
beste Teiler	93.8 (30.)	105.5 (29.)	122.8 (27.)		
Trefferlage	0.62 mm rechts, 0.56 mm tief				
Streuwert	1.59, horizontal: 1.91, vertikal: 1.19				

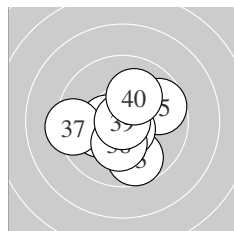

Serie 4:	10.7 *	10.2 *	9.7 ↓	10.5 *	9.7 →
	10.7 *	9.4 ←	10.2 *	10.9 *	10.1 ↗
beste Teiler	3.6 (39.)	65.7 (31.)	74.7 (36.)		
Trefferlage	0.17 mm links, 0.40 mm tief				
Streuwert	1.61, horizontal: 1.84, vertikal: 1.35				

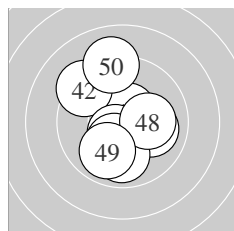

Serie 5:	10.6 *	9.3 ↘	10.0 →	10.3 *	10.5 *
	10.3 *	9.9 ↓	10.1 →	9.9 ✓	9.1 ↑
beste Teiler	97.0 (41.)	102.9 (45.)	166.6 (44.)		
Trefferlage	0.22 mm links, 0.12 mm tief				
Streuwert	1.94, horizontal: 1.54, vertikal: 2.28				

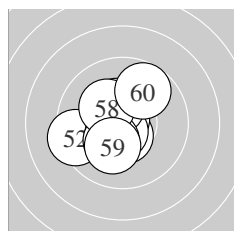

Serie 6:	10.5 *	9.4 ←	10.8 *	10.5 *	10.7 *
	10.4 *	10.3 *	10.2 *	10.2 *	9.7 ↗
beste Teiler	32.2 (53.)	70.2 (55.)	102.9 (51.)		
Trefferlage	0.64 mm links, 0.14 mm tief				
Streuwert	1.40, horizontal: 1.36, vertikal: 1.43				

Meyton Elektronik

**ISSF AR Men – Wertung – Junioren**

StandNr: 117

**Hoberg, Alex** #70804633

**StartNr: 94**

21. Januar 2017 13:25

Australia

---

Unterschrift des Schuetzen

---

Meyton Elektronik



Ergebnis:	<b>597.9</b>	(571)						
Serien:	96.6	100.0	99.9	100.4	97.0	104.0		
Zaehler:	34	23	3	0	0	0	0	0
Innenzehner:	24							
weiteste:	634 (30), 606 (47), 531 (49)							
beste Teiler	8.5 (54.) 15.0 (25.) 38.9 (11.)							
Trefferlage	0.53 mm rechts, 0.42 mm tief							
Streuwert	1.99, horizontal: 2.30, vertikal: 1.63							

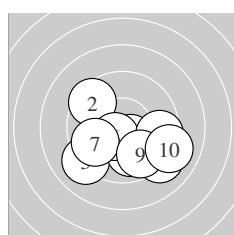
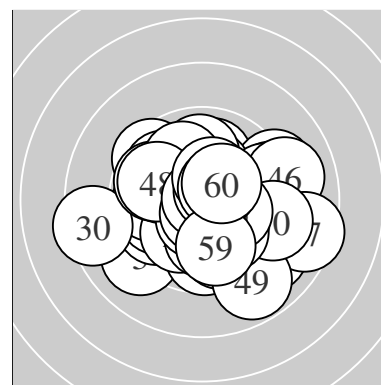

Serie 1:				
10.4 *	9.5 ↖	9.1 ↙	10.0 ↓	9.1 ↘
10.5 *	9.8 ↖	9.5 →	9.7 ↓	9.0 ↘
beste Teiler	113.0 (6.) 129.0 (1.) 249.6 (4.)			
Trefferlage	0.48 mm rechts, 1.47 mm tief			
Streuwert	2.30, horizontal: 2.83, vertikal: 1.60			

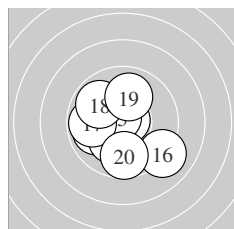

Serie 2:				
10.8 *	10.0 ↖	9.9 ↖	10.2 *	10.7 *
9.0 ↘	9.8 ←	9.9 ↖	10.0 ↑	9.7 ↓
beste Teiler	38.9 (11.) 64.3 (15.) 193.1 (14.)			
Trefferlage	0.63 mm links, 0.29 mm tief			
Streuwert	1.92, horizontal: 1.98, vertikal: 1.85			

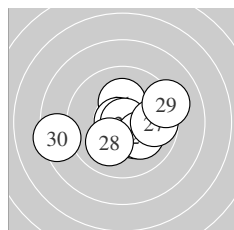

Serie 3:				
10.2 *	10.8 *	10.3 *	10.1 →	10.9 *
10.1 ↘	9.8 →	10.1 ↙	9.2 →	8.4 ←
beste Teiler	15.0 (25.) 43.5 (22.) 168.2 (23.)			
Trefferlage	0.40 mm rechts, 0.27 mm tief			
Streuwert	2.19, horizontal: 2.82, vertikal: 1.27			

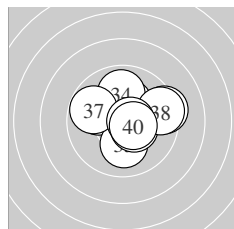

Serie 4:				
10.0 ↖	10.2 *	10.1 ↓	9.9 ↑	10.4 *
9.3 →	9.8 ↖	9.5 →	10.7 *	10.5 *
beste Teiler	75.0 (39.) 108.8 (40.) 127.9 (35.)			
Trefferlage	0.58 mm rechts, 0.50 mm hoch			
Streuwert	1.77, horizontal: 2.11, vertikal: 1.34			

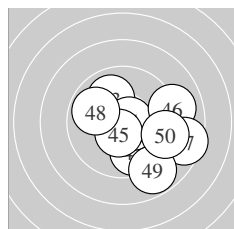

Serie 5:				
9.8 ↓	10.5 *	10.0 ↖	10.7 *	10.5 *
9.0 →	8.5 →	9.9 ↖	8.8 ↓	9.3 →
beste Teiler	61.9 (44.) 108.0 (42.) 110.3 (45.)			
Trefferlage	1.59 mm rechts, 0.70 mm tief			
Streuwert	2.36, horizontal: 2.67, vertikal: 2.01			

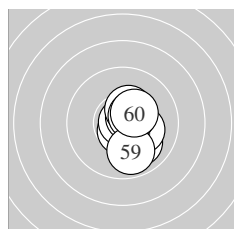

Serie 6:				
10.0 ↘	10.7 *	10.4 *	10.9 *	10.2 *
10.6 *	10.4 *	10.5 *	9.9 ↓	10.4 *
beste Teiler	8.5 (54.) 75.3 (52.) 83.0 (56.)			
Trefferlage	0.79 mm rechts, 0.32 mm tief			
Streuwert	0.98, horizontal: 0.59, vertikal: 1.25			

Meyton Elektronik

**ISSF AR Men – Wertung – Junioren**

StandNr: 118

**Sommavilla, Manuel** #322

**StartNr: 95**

21. Januar 2017 13:30

T –SG Wattens

---

\_\_\_\_\_  
Unterschrift des Schuetzen

Meyton Elektronik

Ergebnis: **608.8** (585)

Serien: 103.2 101.1 100.4 100.5 102.5 101.1

Zaehler: 46 13 1 0 0 0 0 0 0 0

Innenzehner: 31

weiteste: 513 (32), 428 (27), 426 (18)

beste Teiler 26.6 (17.) 31.7 (12.) 51.4 (41.)

Trefferlage 0.28 mm rechts, 0.12 mm hoch

Streuwert 1.62, horizontal: 1.83, vertikal: 1.38

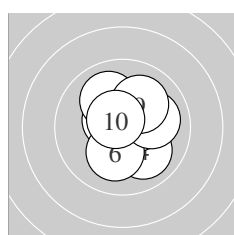
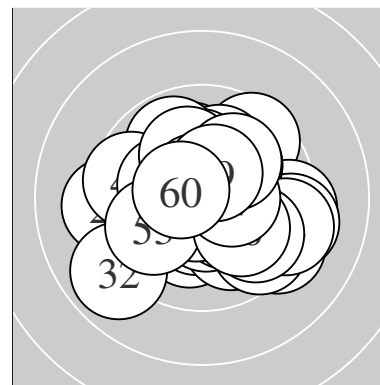

Serie 1:

10.7 *	10.6 *	10.5 *	10.0 ↘	10.5 *
10.2 *	10.0 →	10.0 ↖	10.1 ↗	10.6 *

beste Teiler 70.7 (1.) 80.7 (10.) 88.0 (2.)

Trefferlage 0.34 mm rechts, 0.27 mm hoch

Streuwert 1.23, horizontal: 1.19, vertikal: 1.28

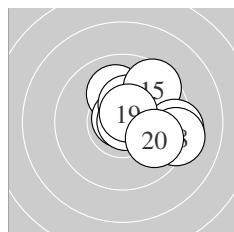

Serie 2:

10.1 ↑	10.8 *	10.5 *	10.4 *	9.6 ↗
9.3 →	10.8 *	9.2 →	10.6 *	9.8 ↘

beste Teiler 26.6 (17.) 31.7 (12.) 82.6 (19.)

Trefferlage 1.39 mm rechts, 0.51 mm hoch

Streuwert 1.52, horizontal: 1.71, vertikal: 1.30

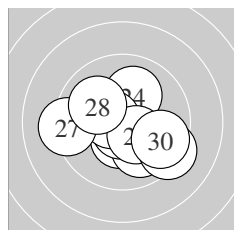

Serie 3:

10.4 *	10.0 ↘	10.7 *	10.1 ↗	10.6 *
10.4 *	9.2 ←	10.0 ↖	9.3 ↘	9.7 ↘

beste Teiler 62.5 (23.) 90.2 (25.) 135.1 (21.)

Trefferlage 0.21 mm rechts, 0.52 mm tief

Streuwert 1.88, horizontal: 2.28, vertikal: 1.38

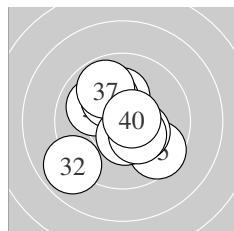

Serie 4:

10.0 ↖	8.9 ↙	10.2 *	10.2 *	9.6 ↘
10.3 *	9.8 ↖	10.5 *	10.3 *	10.7 *

beste Teiler 73.0 (40.) 118.5 (38.) 156.4 (39.)

Trefferlage 0.22 mm links, 0.13 mm tief

Streuwert 1.91, horizontal: 1.91, vertikal: 1.92

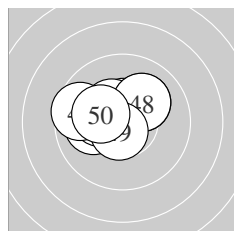

Serie 5:

10.7 *	10.5 *	10.4 *	10.0 ←	10.2 *
9.6 ←	10.1 ↗	10.1 ↗	10.7 *	10.2 *

beste Teiler 51.4 (41.) 75.3 (49.) 113.2 (42.)

Trefferlage 0.75 mm links, 0.61 mm hoch

Streuwert 1.21, horizontal: 1.54, vertikal: 0.75

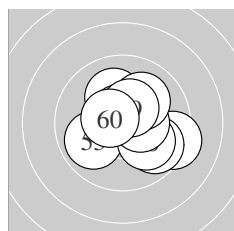

Serie 6:

10.1 ↑	10.6 *	9.9 ↙	9.3 →	9.8 ↘
10.0 ↘	10.4 *	10.1 ↗	10.4 *	10.5 *

beste Teiler 77.7 (52.) 104.7 (60.) 128.8 (59.)

Trefferlage 0.74 mm rechts, 0.02 mm hoch

Streuwert 1.61, horizontal: 1.82, vertikal: 1.38

Meyton Elektronik

**ISSF AR Men – Wertung – Junioren**

StandNr: 119

**Henchoz, Valentin** #70804634

**StartNr: 96**

21. Januar 2017 13:32

Switzerland

---

\_\_\_\_\_  
Unterschrift des Schuetzen

Meyton Elektronik

Ergebnis:	<b>622.8</b>	(594) <sup>QF</sup>							
Serien:	104.7	103.6	103.7	104.1	103.1	103.6			
Zaehler:	54	6	0	0	0	0	0	0	0
Innenzehner:	51								
weiteste:	334 (26), 328 (14), 299 (36)								
beste Teiler	33.2 (52.)	39.9 (18.)	41.0 (37.)						
Trefferlage	0.03 mm links, 0.18 mm hoch								
Streuwert	1.12, horizontal: 1.06, vertikal: 1.18								

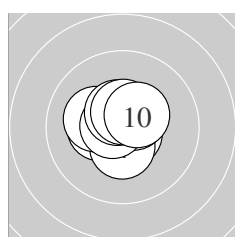
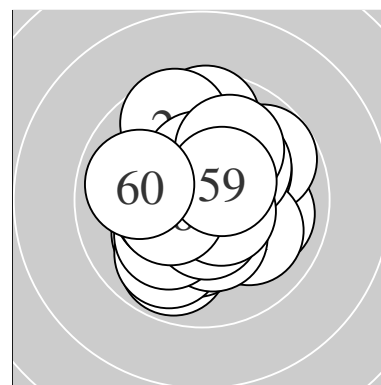

Serie 1:	10.3 *	10.7 *	10.5 *	10.4 *	10.2 *
	10.5 *	10.7 *	10.5 *	10.5 *	10.4 *
beste Teiler	65.0 (2.)	69.7 (7.)	101.3 (6.)		
Trefferlage	0.32 mm links, 0.28 mm hoch				
Streuwert	0.85, horizontal: 0.95, vertikal: 0.74				

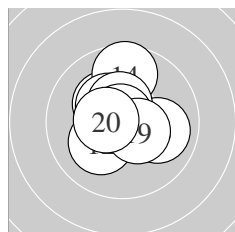

Serie 2:	10.8 *	10.2 *	10.3 *	9.6 ↑	10.4 *
	10.0 →	10.5 *	10.8 *	10.5 *	10.5 *
beste Teiler	39.9 (18.)	50.5 (11.)	113.8 (20.)		
Trefferlage	0.13 mm links, 0.43 mm hoch				
Streuwert	1.26, horizontal: 1.18, vertikal: 1.33				

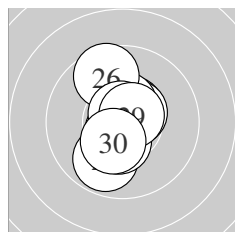

Serie 3:	10.5 *	9.8 ↘	10.5 *	10.7 *	10.5 *
	9.6 ↑	10.7 *	10.4 *	10.6 *	10.4 *
beste Teiler	58.2 (27.)	65.8 (24.)	76.4 (29.)		
Trefferlage	0.15 mm links, 0.12 mm hoch				
Streuwert	1.24, horizontal: 0.70, vertikal: 1.60				

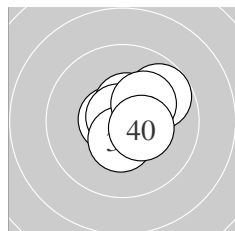

Serie 4:	10.3 *	10.5 *	10.6 *	10.5 *	10.5 *
	9.8 ↗	10.8 *	10.5 *	10.2 *	10.4 *
beste Teiler	41.0 (37.)	80.7 (33.)	109.1 (35.)		
Trefferlage	0.70 mm rechts, 0.53 mm hoch				
Streuwert	0.93, horizontal: 0.98, vertikal: 0.88				

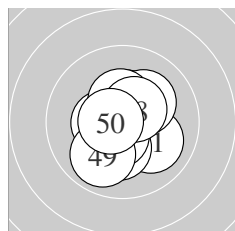

Serie 5:	10.0 ↘	10.4 *	10.2 *	10.4 *	10.2 *
	10.5 *	10.4 *	10.5 *	9.9 ↘	10.6 *
beste Teiler	82.1 (50.)	102.0 (46.)	117.5 (48.)		
Trefferlage	0.01 mm rechts, 0.12 mm tief				
Streuwert	1.24, horizontal: 1.10, vertikal: 1.35				

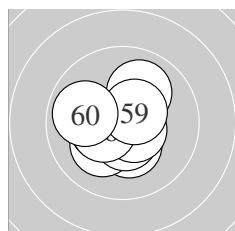

Serie 6:	10.0 ↗	10.8 *	10.3 *	10.2 *	10.5 *
	10.6 *	10.4 *	10.4 *	10.5 *	9.9 ←
beste Teiler	33.2 (52.)	91.4 (56.)	104.9 (55.)		
Trefferlage	0.29 mm links, 0.17 mm tief				
Streuwert	1.18, horizontal: 1.25, vertikal: 1.10				

**ISSF AR Men – Wertung – Junioren**

StandNr: 121

**Abdul, Rahman Mohamad Irwan #70804635**

**StartNr: 98**

21. Januar 2017 13:02

Singapore

---

QF – Schütze hat sich fürs Finale qualifiziert

---

Unterschrift des Schuetzen

Meyton Elektronik

Ergebnis: **616.4** (593)<sup>QF</sup>  
 Serien: 103.0 101.4 101.9 104.3 103.2 102.6  
 Zaehler: 53 7 0 0 0 0 0 0 0 0  
 Innenzehner: 42  
 weiteste: 411 (18), 404 (13), 323 (44)  
 beste Teiler 32.5 (45.) 51.0 (31.) 52.1 (39.)  
 Trefferlage 0.10 mm links, 0.01 mm hoch  
 Streuwert 1.32, horizontal: 1.37, vertikal: 1.27

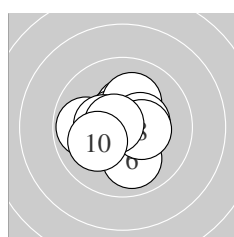
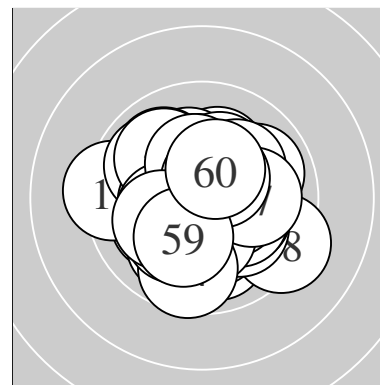

Serie 1:  
 10.4 \*                      10.6 \*                      10.2 \*                      9.8 ←                      10.4 \*  
 10.0 ↓                      10.4 \*                      10.4 \*                      10.7 \*                      10.1 ←  
 beste Teiler 69.2 (9.) 84.1 (2.) 136.8 (7.)  
 Trefferlage 0.30 mm links, 0.10 mm hoch  
 Streuwert 1.30, horizontal: 1.41, vertikal: 1.19

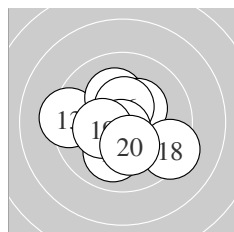

Serie 2:  
 10.6 \*                      10.0 ↓                      9.3 ←                      10.2 \*                      10.3 \*  
 10.5 \*                      10.7 \*                      9.3 ↘                      10.3 \*                      10.2 \*  
 beste Teiler 55.3 (17.) 78.0 (11.) 117.6 (16.)  
 Trefferlage 0.16 mm links, 0.18 mm tief  
 Streuwert 1.71, horizontal: 1.93, vertikal: 1.45

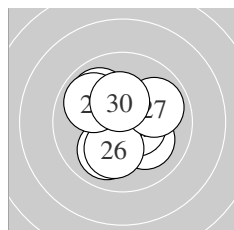

Serie 3:  
 10.5 \*                      10.1 ↘                      10.0 ↓                      10.5 \*                      10.7 \*  
 10.1 ↓                      9.9 →                      9.9 ↖                      9.9 ↖                      10.3 \*  
 beste Teiler 53.6 (25.) 103.1 (21.) 107.8 (24.)  
 Trefferlage 0.06 mm links, 0.01 mm tief  
 Streuwert 1.48, horizontal: 1.47, vertikal: 1.50

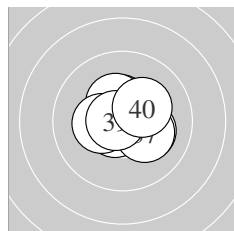

Serie 4:  
 10.7 \*                      10.5 \*                      10.2 \*                      10.7 \*                      10.4 \*  
 10.4 \*                      10.2 \*                      10.3 \*                      10.7 \*                      10.2 \*  
 beste Teiler 51.0 (31.) 52.1 (39.) 74.4 (34.)  
 Trefferlage 0.09 mm rechts, 0.28 mm hoch  
 Streuwert 0.99, horizontal: 1.13, vertikal: 0.84

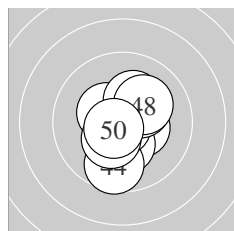

Serie 5:  
 10.4 \*                      10.4 \*                      10.3 \*                      9.7 ↓                      10.8 \*  
 10.3 \*                      10.2 \*                      10.1 ↗                      10.4 \*                      10.6 \*  
 beste Teiler 32.5 (45.) 82.4 (50.) 138.5 (41.)  
 Trefferlage 0.17 mm rechts, 0.25 mm tief  
 Streuwert 1.28, horizontal: 1.02, vertikal: 1.50

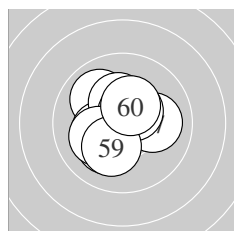

Serie 6:  
 10.0 ↖                      10.3 \*                      10.3 \*                      10.1 ↓                      10.6 \*  
 10.1 ←                      10.1 →                      10.5 \*                      10.2 \*                      10.4 \*  
 beste Teiler 84.9 (55.) 121.0 (58.) 143.1 (60.)  
 Trefferlage 0.35 mm links, 0.13 mm hoch  
 Streuwert 1.33, horizontal: 1.34, vertikal: 1.31

Meyton Elektronik

**ISSF AR Men – Wertung – Junioren**

StandNr: 124

**Clopatofsky, Daniel** #70804637

**StartNr: 100**

21. Januar 2017 13:36

Australia

---

QF – Schütze hat sich fürs Finale qualifiziert

---

Unterschrift des Schuetzen

Meyton Elektronik



Ergebnis:	<b>596.4</b>	(565)
Serien:	100.8 98.7 98.2 100.5 99.0 99.2	
Zaehler:	31 23 6 0 0 0 0 0 0 0	
Innenzehner:	27	
weiteste:	677 (19), 587 (36), 546 (29)	
beste Teiler	9.0 (39.) 28.7 (60.) 29.4 (50.)	
Trefferlage	0.41 mm rechts, 0.58 mm hoch	
Streuwert	2.05, horizontal: 2.49, vertikal: 1.48	

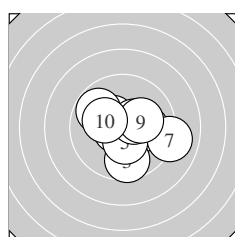
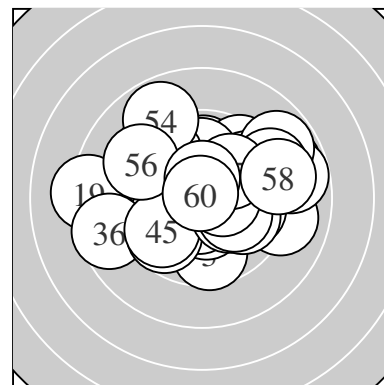

Serie 1:				
10.0 →	10.4 *	9.6 ↓	10.7 *	10.4 *
10.5 *	9.0 →	9.8 ↖	10.2 *	10.2 *
beste Teiler	72.9 (4.)	123.8 (6.)	135.1 (2.)	
Trefferlage	0.48 mm rechts, 0.18 mm tief			
Streuwert	1.80, horizontal: 2.11, vertikal: 1.43			

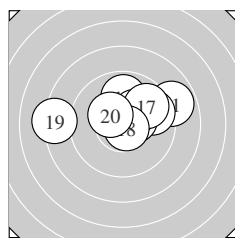

Serie 2:				
8.9 →	9.9 ↑	9.7 →	10.5 *	10.4 *
10.3 *	9.8 ↗	10.7 *	8.2 ←	10.3 *
beste Teiler	55.1 (18.)	112.6 (14.)	126.4 (15.)	
Trefferlage	0.61 mm rechts, 1.04 mm hoch			
Streuwert	2.28, horizontal: 3.08, vertikal: 0.93			

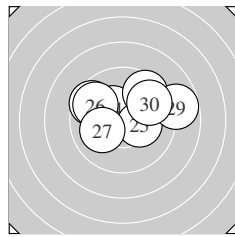

Serie 3:				
10.4 *	9.7 ↗	9.6 ↖	10.3 *	10.3 *
9.7 ↖	10.1 ←	9.6 ↗	8.8 →	9.7 ↗
beste Teiler	144.2 (21.)	151.3 (24.)	173.4 (25.)	
Trefferlage	0.65 mm rechts, 1.16 mm hoch			
Streuwert	2.08, horizontal: 2.73, vertikal: 1.09			

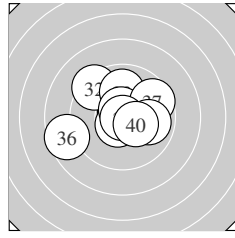

Serie 4:				
10.7 *	9.3 ↖	9.9 ↑	10.6 *	10.6 *
8.6 ←	9.6 ↗	9.9 →	10.9 *	10.4 *
beste Teiler	9.0 (39.)	61.3 (31.)	76.4 (35.)	
Trefferlage	0.24 mm links, 0.43 mm hoch			
Streuwert	2.07, horizontal: 2.48, vertikal: 1.55			

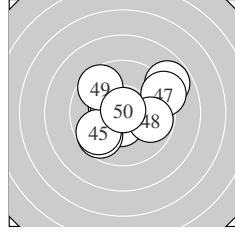

Serie 5:				
10.5 *	10.4 *	9.7 ↙	10.5 *	9.7 ↙
8.8 ↗	9.2 →	9.8 →	9.6 ↖	10.8 *
beste Teiler	29.4 (50.)	101.2 (44.)	110.0 (41.)	
Trefferlage	0.22 mm rechts, 0.28 mm hoch			
Streuwert	2.23, horizontal: 2.61, vertikal: 1.79			

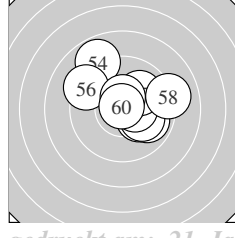

Serie 6:				
10.2 *	9.9 →	10.1 →	8.8 ↖	10.5 *
9.3 ↖	10.0 ↗	9.1 →	10.5 *	10.8 *
beste Teiler	28.7 (60.)	116.0 (59.)	124.0 (55.)	
Trefferlage	0.72 mm rechts, 0.79 mm hoch			
Streuwert	2.11, horizontal: 2.39, vertikal: 1.79			

Meyton Elektronik

**ISSF AR Men – Wertung – Junioren**

StandNr: 125

**Koota,, Luukas** #70804638

**StartNr: 101**

21. Januar 2017 13:29

F – Esbo Skytteförening

---

\_\_\_\_\_  
Unterschrift des Schuetzen

Meyton Elektronik

Ergebnis:	<b>612.0</b>	(586)
Serien:	102.5	102.4 102.3 100.6 102.4 101.8
Zaehler:	46	14 0 0 0 0 0 0 0 0
Innenzehner:	31	
weiteste:	381	(57), 373 (52), 355 (30)
beste Teiler	48.3	(1.) 54.4 (48.) 55.9 (24.)
Trefferlage	0.27 mm	rechts, 0.46 mm hoch
Streuwert	1.42,	horizontal: 1.47, vertikal: 1.38

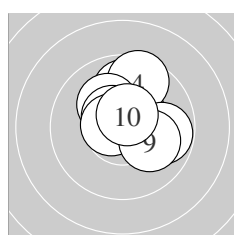
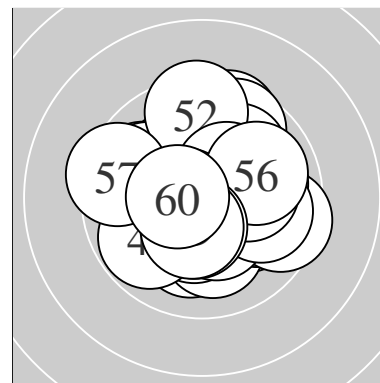

Serie 1:	10.8 *	9.9 ↑	10.4 *	9.6 ↑	10.2 *
	10.5 *	10.6 *	9.8 →	10.1 ↘	10.6 *
beste Teiler	48.3 (1.)	82.7 (7.)	95.8 (10.)		
Trefferlage	0.43 mm	rechts, 0.94 mm	hoch		
Streuwert	1.29,	horizontal: 1.27,	vertikal: 1.32		

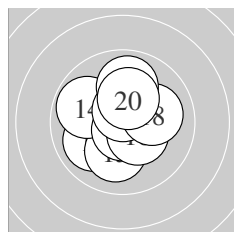

Serie 2:	10.5 *	10.0 ↙	10.1 ↓	9.8 ↖	10.7 *
	10.4 *	10.6 *	10.1 →	9.9 ↑	10.3 *
beste Teiler	56.0 (15.)	83.0 (17.)	122.3 (11.)		
Trefferlage	0.15 mm	links, 0.30 mm	hoch		
Streuwert	1.42,	horizontal: 1.38,	vertikal: 1.46		

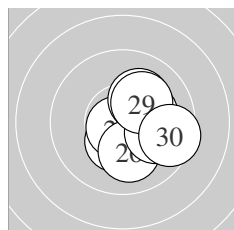

Serie 3:	10.7 *	10.4 *	10.4 *	10.7 *	10.2 *
	10.1 ↓	10.0 →	10.1 ↗	10.2 *	9.5 →
beste Teiler	55.9 (24.)	60.3 (21.)	142.6 (22.)		
Trefferlage	1.12 mm	rechts, 0.14 mm	tief		
Streuwert	1.22,	horizontal: 1.21,	vertikal: 1.23		

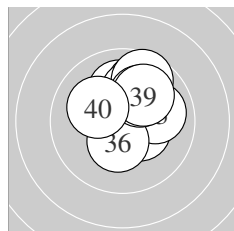

Serie 4:	10.1 ↑	10.4 *	10.0 →	9.8 ↑	10.1 ↑
	10.4 *	9.6 ↑	10.1 ↗	10.0 ↗	10.1 ↖
beste Teiler	140.8 (32.)	149.9 (36.)	205.9 (40.)		
Trefferlage	0.71 mm	rechts, 1.30 mm	hoch		
Streuwert	1.32,	horizontal: 1.20,	vertikal: 1.43		

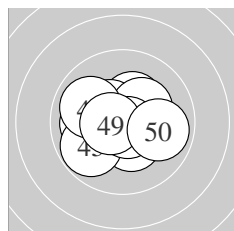

Serie 5:	10.3 *	10.4 *	10.5 *	10.0 ←	9.8 ↙
	10.3 *	9.9 ↖	10.7 *	10.6 *	9.9 →
beste Teiler	54.4 (48.)	86.8 (49.)	123.1 (43.)		
Trefferlage	0.30 mm	links, 0.00 mm			
Streuwert	1.42,	horizontal: 1.71,	vertikal: 1.05		

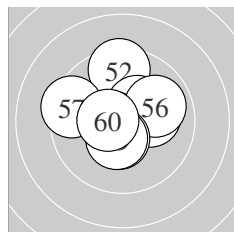

Serie 6:	10.5 *	9.5 ↑	10.4 *	10.1 →	10.7 *
	9.9 →	9.4 ↖	10.4 *	10.4 *	10.5 *
beste Teiler	72.4 (55.)	107.1 (60.)	111.3 (51.)		
Trefferlage	0.14 mm	links, 0.36 mm	hoch		
Streuwert	1.61,	horizontal: 1.70,	vertikal: 1.50		

**ISSF AR Men – Wertung – Junioren**

StandNr: 126

**Roope, Pohjoisaho** #70804639

**StartNr: 102**

21. Januar 2017 13:18

Finland

---

\_\_\_\_\_  
Unterschrift des Schuetzen

Meyton Elektronik

Ergebnis:	<b>619.1</b>	(592) <sup>QF</sup>							
Serien:	102.3	102.9	103.7	102.9	103.3	104.0			
Zaehler:	52	8	0	0	0	0	0	0	0
Innenzehner:	42								
weiteste:	314 (55), 302 (40), 300 (47)								
beste Teiler	23.1 (50.)	31.0 (52.)	31.6 (35.)						
Trefferlage	0.11 mm rechts, 0.02 mm tief								
Streuwert	1.25, horizontal: 1.42, vertikal: 1.06								

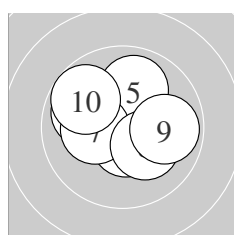
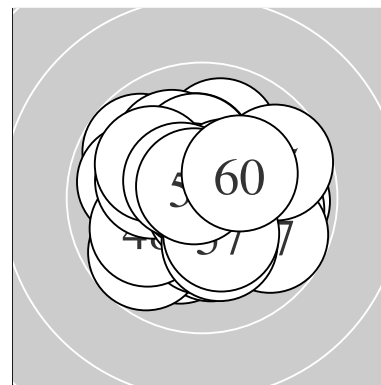

Serie 1:	10.6 *	10.3 *	10.8 *	10.6 *	10.0 ↑
	9.9 ↖	10.2 *	10.2 *	9.9 →	9.8 ↘
beste Teiler	40.5 (3.)	88.0 (1.)	99.2 (4.)		
Trefferlage	0.04 mm links, 0.22 mm hoch				
Streuwert	1.49, horizontal: 1.76, vertikal: 1.16				

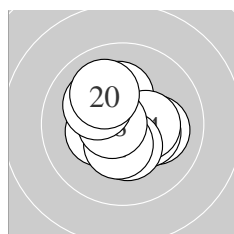

Serie 2:	10.2 *	10.1 →	10.3 *	10.4 *	10.3 *
	10.4 *	10.4 *	10.7 *	10.1 ↖	10.0 ↘
beste Teiler	67.0 (18.)	132.7 (17.)	143.8 (16.)		
Trefferlage	0.00 mm, 0.08 mm hoch				
Streuwert	1.26, horizontal: 1.32, vertikal: 1.19				

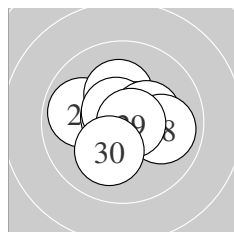

Serie 3:	9.9 ↖	10.7 *	10.2 *	10.5 *	10.8 *
	10.6 *	10.3 *	9.9 →	10.7 *	10.1 ↙
beste Teiler	46.0 (25.)	54.4 (29.)	56.3 (22.)		
Trefferlage	0.14 mm rechts, 0.18 mm hoch				
Streuwert	1.19, horizontal: 1.41, vertikal: 0.93				

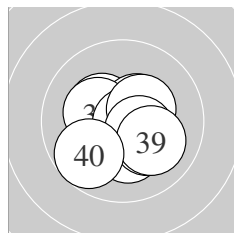

Serie 4:	10.3 *	10.2 *	10.5 *	10.3 *	10.8 *
	10.4 *	10.1 ↘	10.5 *	10.1 ↘	9.7 ↙
beste Teiler	31.6 (35.)	121.0 (33.)	124.0 (38.)		
Trefferlage	0.21 mm rechts, 0.41 mm tief				
Streuwert	1.29, horizontal: 1.42, vertikal: 1.14				

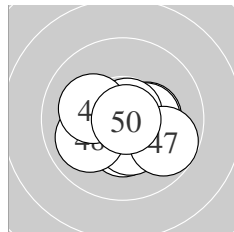

Serie 5:	10.4 *	10.3 *	10.2 *	10.4 *	10.4 *
	10.8 *	9.8 ↘	10.0 ↙	10.1 ↖	10.9 *
beste Teiler	23.1 (50.)	49.8 (46.)	146.1 (45.)		
Trefferlage	0.09 mm rechts, 0.45 mm tief				
Streuwert	1.28, horizontal: 1.60, vertikal: 0.83				

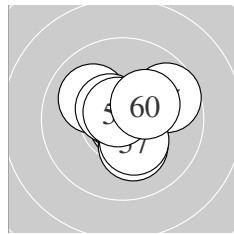

Serie 6:	10.0 ↖	10.8 *	10.8 *	10.2 *	9.7 →
	10.7 *	10.3 *	10.5 *	10.7 *	10.3 *
beste Teiler	31.0 (52.)	45.9 (53.)	51.9 (56.)		
Trefferlage	0.27 mm rechts, 0.21 mm hoch				
Streuwert	1.18, horizontal: 1.29, vertikal: 1.06				

Meyton Elektronik

**ISSF AR Men – Wertung – Junioren**

StandNr: 127

**Friman,, Cristian** #70804640

**StartNr: 103**

21. Januar 2017 13:35

F – Esbo Skytteförening

---

QF – Schütze hat sich fürs Finale qualifiziert

---

Unterschrift des Schuetzen

Meyton Elektronik

Ergebnis:	<b>598.8</b>	(574)							
Serien:	99.7	97.8	100.2	101.8	100.1	99.2			
Zaehler:	34	26	0	0	0	0	0	0	0
Innenzehner:	26								
weiteste:	486 (4), 430 (49), 423 (20)								
beste Teiler	53.0 (46.)	53.7 (43.)	55.4 (27.)						
Trefferlage	0.27 mm rechts, 0.12 mm hoch								
Streuwert	1.89, horizontal: 2.03, vertikal: 1.75								

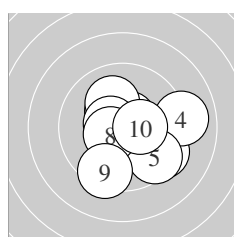
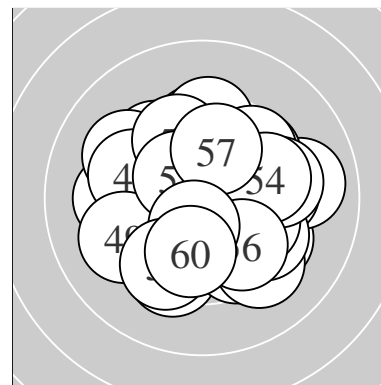

Serie 1:	9.4 ↘	10.6 *	10.3 *	9.0 →	9.5 ↘
	10.1 ↖	10.5 *	10.5 *	9.4 ↓	10.4 *
beste Teiler	85.4 (2.) 102.4 (7.) 113.3 (8.)				
Trefferlage	0.75 mm rechts, 0.35 mm tief				
Streuwert	1.99, horizontal: 2.18, vertikal: 1.78				

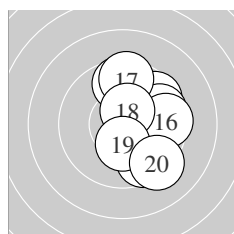

Serie 2:	9.6 ↑	9.6 ↗	9.7 →	10.2 *	9.6 ↓
	9.5 →	9.5 ↑	10.5 *	10.3 *	9.3 ↘
beste Teiler	117.6 (18.) 161.0 (19.) 195.0 (14.)				
Trefferlage	1.49 mm rechts, 0.20 mm hoch				
Streuwert	2.02, horizontal: 1.42, vertikal: 2.48				

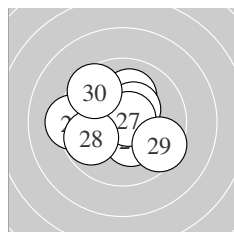

Serie 3:	10.3 *	10.4 *	10.1 ↑	10.1 ↖	9.3 ←
	10.4 *	10.7 *	9.8 ↙	9.5 ↘	9.6 ↖
beste Teiler	55.4 (27.) 136.3 (22.) 137.0 (26.)				
Trefferlage	0.65 mm links, 0.27 mm hoch				
Streuwert	1.82, horizontal: 2.13, vertikal: 1.46				

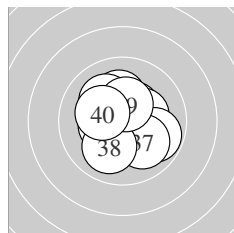

Serie 4:	10.2 *	10.4 *	10.1 ↖	10.4 *	10.3 *
	9.8 ↘	10.0 ↘	10.0 ↓	10.4 *	10.2 *
beste Teiler	132.5 (32.) 139.4 (39.) 144.5 (34.)				
Trefferlage	0.11 mm rechts, 0.18 mm hoch				
Streuwert	1.46, horizontal: 1.50, vertikal: 1.42				

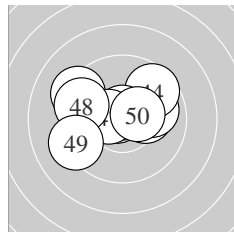

Serie 5:	10.2 *	10.0 →	10.7 *	9.6 ↗	9.3 ↖
	10.7 *	10.5 *	9.5 ↙	9.2 ↙	10.4 *
beste Teiler	53.0 (46.) 53.7 (43.) 115.5 (47.)				
Trefferlage	0.45 mm links, 0.59 mm hoch				
Streuwert	1.94, horizontal: 2.48, vertikal: 1.17				

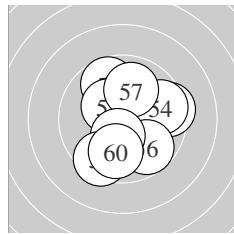

Serie 6:	9.4 →	10.7 *	9.7 ↖	9.6 →	10.3 *
	9.7 ↘	10.0 ↑	10.4 *	9.5 ↓	9.9 ↓
beste Teiler	57.2 (52.) 144.6 (58.) 156.4 (55.)				
Trefferlage	0.38 mm rechts, 0.13 mm tief				
Streuwert	2.04, horizontal: 1.92, vertikal: 2.14				

Meyton Elektronik

**ISSF AR Men – Wertung – Junioren**

StandNr: 129

**Moser, Matthias** #70804353

**StartNr: 105**

21. Januar 2017 13:28

T – SG Münster

---

\_\_\_\_\_  
Unterschrift des Schuetzen

Meyton Elektronik



Ergebnis: **612.0** (584)<sup>QF</sup>  
 Serien: 102.2 100.0 103.1 100.2 102.1 104.4  
 Zaehler: 44 16 0 0 0 0 0 0 0  
 Innenzehner: 37  
 weiteste: 481 (1), 443 (31), 430 (13)  
 beste Teiler 11.7 (51.) 33.0 (24.) 34.9 (2.)  
 Trefferlage 0.10 mm rechts, 0.32 mm hoch  
 Streuwert 1.51, horizontal: 1.35, vertikal: 1.66

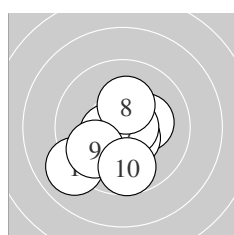
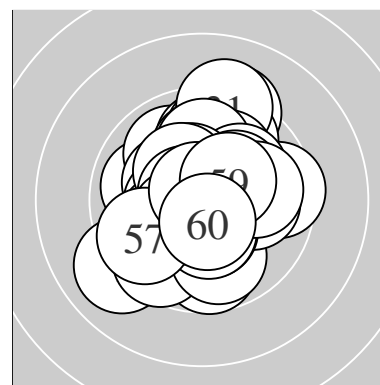

Serie 1:  
 9.0 ↙ 10.8 \* 10.2 \* 10.6 \* 10.5 \*  
 10.5 \* 10.7 \* 10.3 \* 9.9 ↘ 9.7 ↓  
 beste Teiler 34.9 (2.) 56.0 (7.) 81.3 (4.)  
 Trefferlage 0.39 mm links, 0.76 mm tief  
 Streuwert 1.54, horizontal: 1.58, vertikal: 1.50

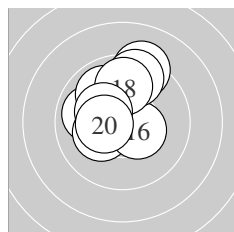

Serie 2:  
 9.9 ↖ 9.9 ↗ 9.2 ↑ 10.4 \* 10.2 \*  
 10.4 \* 9.5 ↑ 9.8 ↑ 10.3 \* 10.4 \*  
 beste Teiler 131.5 (16.) 142.7 (20.) 150.6 (14.)  
 Trefferlage 0.51 mm links, 1.37 mm hoch  
 Streuwert 1.54, horizontal: 1.37, vertikal: 1.69

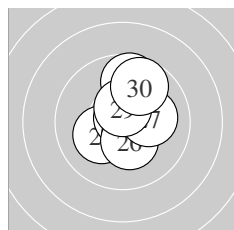

Serie 3:  
 10.2 \* 10.7 \* 10.6 \* 10.8 \* 10.5 \*  
 10.3 \* 10.1 → 9.7 ↑ 10.5 \* 9.7 ↑  
 beste Teiler 33.0 (24.) 68.4 (22.) 86.3 (23.)  
 Trefferlage 0.44 mm rechts, 0.55 mm hoch  
 Streuwert 1.25, horizontal: 0.94, vertikal: 1.50

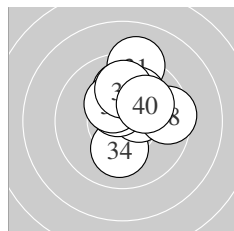

Serie 4:  
 9.2 ↑ 10.1 ↗ 10.0 ↑ 10.1 ↓ 10.4 \*  
 10.5 \* 10.3 \* 9.5 → 10.0 ↑ 10.1 ↗  
 beste Teiler 110.3 (36.) 140.4 (35.) 152.6 (37.)  
 Trefferlage 0.73 mm rechts, 1.36 mm hoch  
 Streuwert 1.49, horizontal: 1.28, vertikal: 1.66

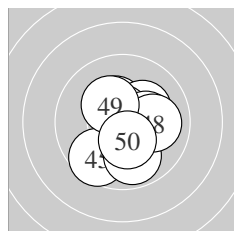

Serie 5:  
 10.4 \* 10.2 \* 10.4 \* 10.7 \* 9.6 ↙  
 9.9 ↓ 10.2 \* 10.0 → 10.3 \* 10.4 \*  
 beste Teiler 64.4 (44.) 143.0 (43.) 143.8 (50.)  
 Trefferlage 0.38 mm rechts, 0.36 mm tief  
 Streuwert 1.44, horizontal: 1.32, vertikal: 1.55

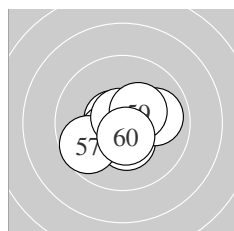

Serie 6:  
 10.9 \* 10.8 \* 10.6 \* 10.4 \* 9.9 →  
 10.4 \* 9.7 ↙ 10.8 \* 10.4 \* 10.5 \*  
 beste Teiler 11.7 (51.) 39.0 (52.) 50.5 (58.)  
 Trefferlage 0.03 mm links, 0.23 mm tief  
 Streuwert 1.16, horizontal: 1.36, vertikal: 0.91

Meyton Elektronik

**ISSF AR Men – Wertung – Junioren**

StandNr: 130

**Hammermann, Marcel #80**

**StartNr: 106**

21. Januar 2017 13:41

VSB

---

QF – Schütze hat sich fürs Finale qualifiziert

---

Unterschrift des Schuetzen

Meyton Elektronik

Ergebnis: **600.4** (576)

Serien: 101.8 99.1 99.9 100.5 100.5 98.6

Zaehler: 37 22 1 0 0 0 0 0 0 0

Innenzehner: 24

weiteste: 575 (58), 496 (30), 480 (2)

beste Teiler 63.1 (22.) 70.3 (5.) 84.8 (48.)

Trefferlage 0.28 mm links, 0.02 mm tief

Streuwert 1.85, horizontal: 1.98, vertikal: 1.70

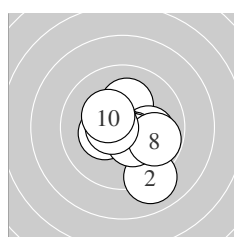
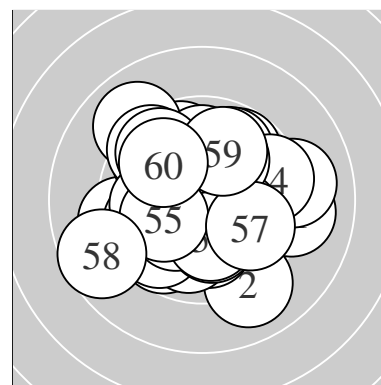

Serie 1:

10.2 *	9.0 ↘	10.1 →	10.4 *	10.7 *
10.3 *	10.4 *	9.8 ↘	10.6 *	10.3 *

beste Teiler 70.3 (5.) 90.0 (9.) 127.4 (4.)

Trefferlage 0.49 mm rechts, 0.54 mm tief

Streuwert 1.57, horizontal: 1.55, vertikal: 1.59

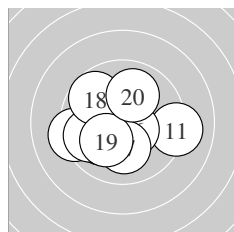

Serie 2:

9.1 →	10.0 ↙	10.5 *	9.3 ←	9.8 ←
10.5 *	10.1 ↓	9.7 ↘	10.1 ↙	10.0 ↑

beste Teiler 105.6 (16.) 124.2 (13.) 205.2 (19.)

Trefferlage 0.71 mm links, 0.37 mm tief

Streuwert 2.01, horizontal: 2.42, vertikal: 1.48

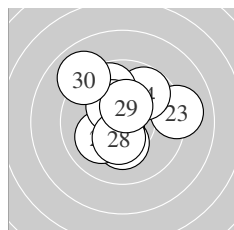

Serie 3:

10.3 *	10.7 *	9.1 →	9.8 ↗	9.8 ↖
10.1 ↙	10.3 *	10.4 *	10.4 *	9.0 ↘

beste Teiler 63.1 (22.) 135.8 (28.) 138.2 (29.)

Trefferlage 0.10 mm links, 0.76 mm hoch

Streuwert 2.01, horizontal: 2.11, vertikal: 1.89

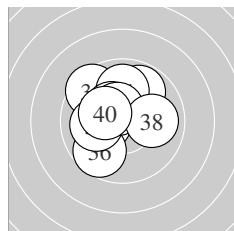

Serie 4:

9.5 ↘	10.3 *	9.8 ↗	9.9 ↑	10.4 *
9.7 ↙	10.5 *	10.0 →	10.1 ←	10.3 *

beste Teiler 111.0 (37.) 143.1 (35.) 151.4 (32.)

Trefferlage 0.72 mm links, 0.73 mm hoch

Streuwert 1.60, horizontal: 1.61, vertikal: 1.59

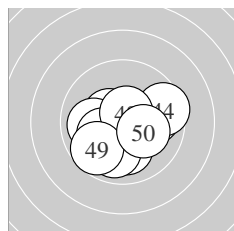

Serie 5:

10.4 *	9.9 →	10.0 ←	9.5 →	10.1 ↓
10.2 *	9.9 ↓	10.6 *	9.7 ↙	10.2 *

beste Teiler 84.8 (48.) 127.4 (41.) 191.5 (50.)

Trefferlage 0.03 mm rechts, 0.61 mm tief

Streuwert 1.71, horizontal: 2.02, vertikal: 1.34

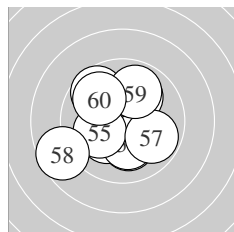

Serie 6:

10.1 ↓	10.2 *	10.0 ↗	10.2 *	10.1 ←
9.7 ↘	9.8 ↘	8.7 ↙	9.9 ↗	9.9 ↘

beste Teiler 188.7 (52.) 190.1 (54.) 201.3 (51.)

Trefferlage 0.68 mm links, 0.13 mm tief

Streuwert 2.14, horizontal: 2.21, vertikal: 2.06

**ISSF AR Men – Wertung – Junioren**

StandNr: 131

**Lüthi, Julius** #70804363

**StartNr: 107**

21. Januar 2017 13:23

T – SG Thierberg

---

\_\_\_\_\_  
Unterschrift des Schuetzen

Meyton Elektronik

Ergebnis: **617.7** (592)<sup>QF</sup>  
 Serien: 103.1 101.9 104.2 101.6 104.1 102.8  
 Zaehler: 52 8 0 0 0 0 0 0 0 0  
 Innenzehner: 44  
 weiteste: 484 (11), 428 (37), 412 (5)  
 beste Teiler 41.4 (60.) 48.2 (50.) 49.8 (41.)  
 Trefferlage 0.11 mm rechts, 0.22 mm tief  
 Streuwert 1.34, horizontal: 1.56, vertikal: 1.06

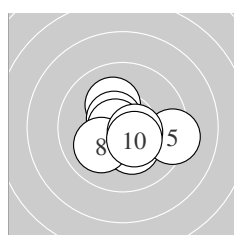
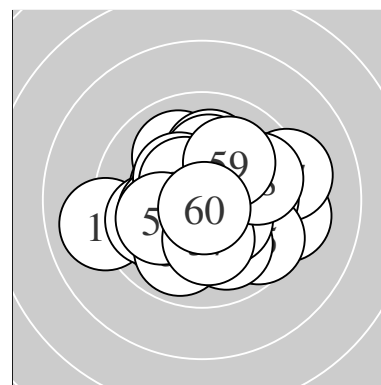

Serie 1:  
 10.2 \* 10.4 \* 10.3 \* 10.6 \* 9.3 →  
 10.6 \* 10.7 \* 10.1 ↙ 10.5 \* 10.4 \*  
 beste Teiler 59.1 (7.) 78.7 (6.) 96.1 (4.)  
 Trefferlage 0.34 mm rechts, 0.45 mm tief  
 Streuwert 1.34, horizontal: 1.57, vertikal: 1.05

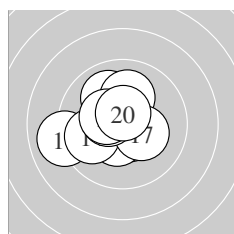

Serie 2:  
 9.0 ← 10.6 \* 10.5 \* 9.9 ← 10.0 ↘  
 10.1 ↑ 10.3 \* 10.5 \* 10.4 \* 10.6 \*  
 beste Teiler 89.0 (20.) 96.0 (12.) 123.1 (18.)  
 Trefferlage 0.87 mm links, 0.13 mm hoch  
 Streuwert 1.54, horizontal: 1.76, vertikal: 1.30

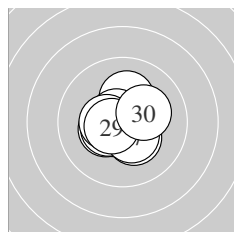

Serie 3:  
 10.6 \* 10.2 \* 10.3 \* 10.4 \* 10.4 \*  
 10.7 \* 10.4 \* 10.4 \* 10.6 \* 10.2 \*  
 beste Teiler 67.2 (26.) 93.9 (29.) 95.4 (21.)  
 Trefferlage 0.22 mm links, 0.11 mm tief  
 Streuwert 1.01, horizontal: 1.08, vertikal: 0.94

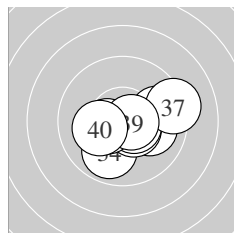

Serie 4:  
 9.8 → 10.0 → 10.3 \* 9.9 ↘ 10.5 \*  
 10.6 \* 9.2 → 10.4 \* 10.7 \* 10.2 \*  
 beste Teiler 70.7 (39.) 99.5 (36.) 112.2 (35.)  
 Trefferlage 0.65 mm rechts, 0.45 mm tief  
 Streuwert 1.55, horizontal: 1.96, vertikal: 0.97

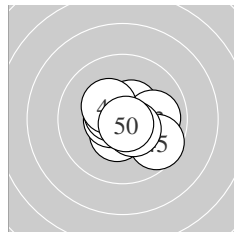

Serie 5:  
 10.8 \* 10.5 \* 10.0 → 10.4 \* 9.6 ↘  
 10.5 \* 10.6 \* 10.6 \* 10.3 \* 10.8 \*  
 beste Teiler 48.2 (50.) 49.8 (41.) 93.2 (47.)  
 Trefferlage 0.36 mm rechts, 0.23 mm tief  
 Streuwert 1.16, horizontal: 1.36, vertikal: 0.91

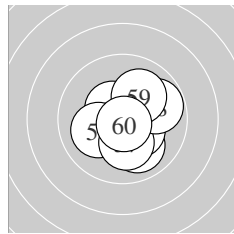

Serie 6:  
 10.6 \* 10.4 \* 10.0 ↘ 10.3 \* 10.5 \*  
 10.1 ← 10.2 \* 9.8 → 10.1 ↑ 10.8 \*  
 beste Teiler 41.4 (60.) 76.0 (51.) 116.6 (55.)  
 Trefferlage 0.46 mm rechts, 0.25 mm tief  
 Streuwert 1.31, horizontal: 1.35, vertikal: 1.27

Meyton Elektronik

**ISSF AR Men – Wertung – Junioren**

StandNr: 133

**Will, Shaner** #70804641

**StartNr: 109**

21. Januar 2017 13:39

USA

---

QF – Schütze hat sich fürs Finale qualifiziert

---

Unterschrift des Schuetzen

Meyton Elektronik

Ergebnis: **606.2** (579)

Serien: 97.5 102.4 101.3 102.1 100.1 102.8

Zaehler: 40 19 1 0 0 0 0 0 0 0

Innenzehner: 31

weiteste: 508 (12), 487 (8), 449 (46)

beste Teiler 48.0 (25.) 50.6 (18.) 61.9 (17.)

Trefferlage 0.44 mm rechts, 0.28 mm hoch

Streuwert 1.68, horizontal: 1.89, vertikal: 1.45

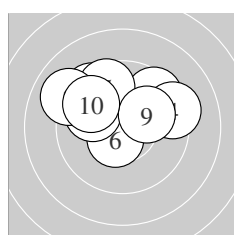
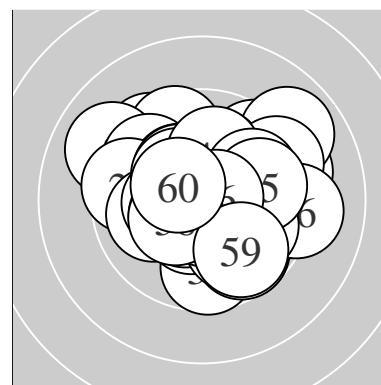

Serie 1:

10.3 *	9.5 ↘	9.6 ↗	9.3 →	9.6 ↖
10.5 *	9.9 ↖	9.0 ↖	10.1 ↗	9.7 ↖

beste Teiler 108.2 (6.) 168.6 (1.) 215.5 (9.)

Trefferlage 0.39 mm links, 1.64 mm hoch

Streuwert 2.04, horizontal: 2.64, vertikal: 1.18

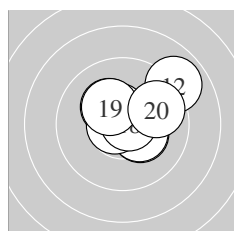

Serie 2:

10.3 *	8.9 ↗	10.3 *	10.5 *	10.5 *
10.3 *	10.7 *	10.8 *	10.3 *	9.8 →

beste Teiler 50.6 (18.) 61.9 (17.) 104.3 (15.)

Trefferlage 0.63 mm rechts, 0.74 mm hoch

Streuwert 1.46, horizontal: 1.71, vertikal: 1.17

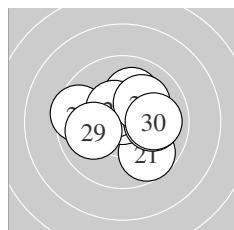

Serie 3:

9.7 ↘	9.5 ←	10.6 *	10.1 ↑	10.8 *
10.5 *	10.0 →	10.1 ↗	10.0 ←	10.0 →

beste Teiler 48.0 (25.) 96.8 (23.) 124.0 (26.)

Trefferlage 0.30 mm rechts, 0.34 mm hoch

Streuwert 1.65, horizontal: 1.97, vertikal: 1.25

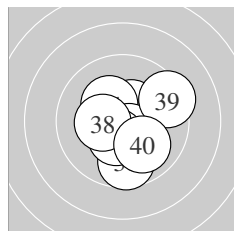

Serie 4:

10.5 *	10.4 *	10.5 *	10.3 *	10.6 *
9.7 ↓	10.4 *	10.3 *	9.4 →	10.0 ↘

beste Teiler 99.9 (35.) 116.1 (31.) 123.1 (33.)

Trefferlage 0.14 mm rechts, 0.18 mm tief

Streuwert 1.56, horizontal: 1.53, vertikal: 1.58

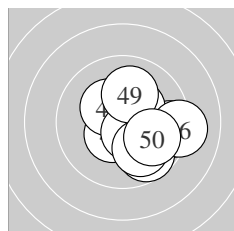

Serie 5:

9.5 →	10.5 *	9.7 ↘	10.3 *	10.3 *
9.2 →	10.6 *	10.0 ↘	10.1 ↑	9.9 ↘

beste Teiler 96.7 (47.) 124.1 (42.) 155.5 (44.)

Trefferlage 1.40 mm rechts, 0.41 mm tief

Streuwert 1.63, horizontal: 1.78, vertikal: 1.47

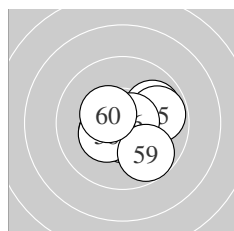

Serie 6:

9.9 ↗	10.6 *	10.3 *	10.6 *	9.8 →
10.7 *	10.4 *	10.3 *	9.8 ↘	10.4 *

beste Teiler 67.2 (56.) 84.2 (54.) 93.5 (52.)

Trefferlage 0.58 mm rechts, 0.40 mm tief

Streuwert 1.28, horizontal: 1.47, vertikal: 1.06

**ISSF AR Men – Wertung – Junioren**

StandNr: 134

**Karlon, Alexander** #101

**StartNr: 110**

21. Januar 2017 13:27

ST – Kapfenberger SV

---

\_\_\_\_\_  
Unterschrift des Schuetzen

Meyton Elektronik





**ISSF AR Men – Wertung – Junioren**

StandNr: 135

**Schöfbeck, Marcel** #102

**StartNr: 111**

21. Januar 2017 13:30

T – SG Walchsee

---

\_\_\_\_\_  
Unterschrift des Schuetzen

*Meyton Elektronik*

Ergebnis:	<b>616.2</b>	(590) <sup>QF</sup>
Serien:	102.4	102.4 101.8 104.8 101.9 102.9
Zaehler:	50	10 0 0 0 0 0 0 0 0
Innenzehner:	40	
weiteste:	378	(60), 369 (12), 356 (15)
beste Teiler	15.6	(28.) 16.1 (14.) 18.3 (31.)
Trefferlage	0.21 mm	rechts, 0.05 mm hoch
Streuwert	1.38,	horizontal: 1.50, vertikal: 1.25

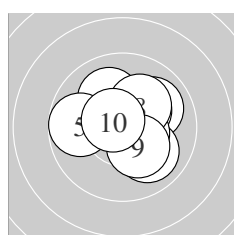
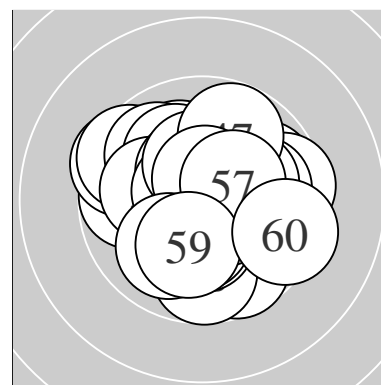

Serie 1:	10.0 ↗	10.3 *	10.1 ↘	10.0 ↘	9.8 ←
	10.6 *	10.5 *	10.2 *	10.3 *	10.6 *
beste Teiler	83.8	(10.) 87.6 (6.) 116.2 (7.)			
Trefferlage	0.44 mm	rechts, 0.38 mm hoch			
Streuwert	1.39,	horizontal: 1.54, vertikal: 1.22			

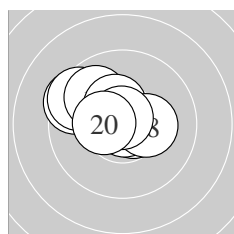

Serie 2:	10.1 ↖	9.5 ↖	10.6 *	10.9 *	9.5 ↖
	9.9 ↖	10.4 *	10.3 *	10.8 *	10.4 *
beste Teiler	16.1	(14.) 45.7 (19.) 79.0 (13.)			
Trefferlage	0.96 mm	links, 0.77 mm hoch			
Streuwert	1.30,	horizontal: 1.64, vertikal: 0.83			

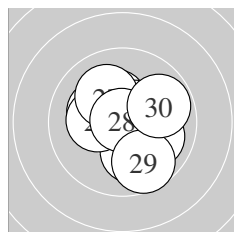

Serie 3:	10.2 *	10.1 ↓	10.0 ↘	10.3 *	10.2 *
	10.5 *	10.1 ↘	10.9 *	9.7 ↓	9.8 ↗
beste Teiler	15.6	(28.) 110.6 (26.) 155.9 (24.)			
Trefferlage	0.25 mm	rechts, 0.03 mm hoch			
Streuwert	1.54,	horizontal: 1.54, vertikal: 1.53			

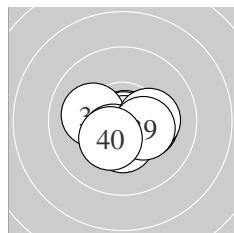

Serie 4:	10.9 *	10.9 *	10.8 *	10.1 ←	10.3 *
	10.4 *	10.5 *	10.2 *	10.3 *	10.4 *
beste Teiler	18.3	(31.) 18.9 (32.) 46.0 (33.)			
Trefferlage	0.17 mm	rechts, 0.47 mm tief			
Streuwert	0.97,	horizontal: 1.23, vertikal: 0.59			

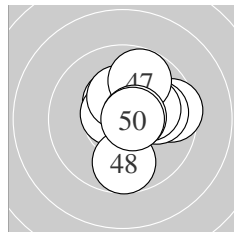

Serie 5:	10.4 *	9.6 →	10.0 →	10.6 *	10.2 *
	10.3 *	9.8 ↗	9.7 ↓	10.6 *	10.7 *
beste Teiler	71.0	(50.) 84.0 (44.) 86.3 (49.)			
Trefferlage	0.89 mm	rechts, 0.47 mm hoch			
Streuwert	1.42,	horizontal: 1.37, vertikal: 1.47			

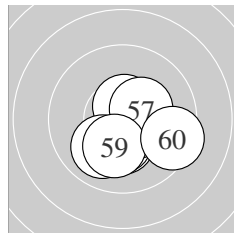

Serie 6:	10.3 *	10.6 *	10.6 *	10.3 *	10.5 *
	10.6 *	10.4 *	10.0 ↗	10.2 *	9.4 ↘
beste Teiler	83.2	(52.) 91.0 (53.) 91.7 (56.)			
Trefferlage	0.51 mm	rechts, 0.84 mm tief			
Streuwert	1.19,	horizontal: 1.32, vertikal: 1.04			

Meyton Elektronik

**ISSF AR Men – Wertung – Junioren**

StandNr: 136

**Fankhauser, Thomas #88**

**StartNr: 112**

21. Januar 2017 13:14

T – SG Fügenberg

---

QF – Schütze hat sich fürs Finale qualifiziert

---

Unterschrift des Schuetzen

Meyton Elektronik

Ergebnis:	<b>608.5</b>	(583)
Serien:	100.4	102.4 101.3 100.7 101.4 102.3
Zaehler:	43	17 0 0 0 0 0 0 0 0
Innenzehner:	32	
weiteste:	480 (5), 410 (24), 385 (12)	
beste Teiler	21.4 (43.)	53.1 (52.) 54.7 (56.)
Trefferlage	0.12 mm rechts, 0.05 mm tief	
Streuwert	1.59, horizontal: 1.58, vertikal: 1.60	

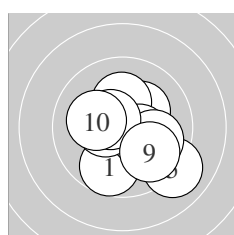
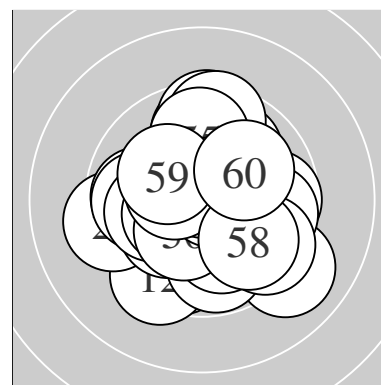

Serie 1:	9.7 ↘	10.2 *	10.2 *	10.4 *	9.0 ↘
	10.0 ↗	10.4 *	10.5 *	9.9 ↘	10.1 ↖
beste Teiler	105.6 (8.) 127.0 (7.) 135.3 (4.)				
Trefferlage	0.54 mm rechts, 0.50 mm tief				
Streuwert	1.77, horizontal: 1.86, vertikal: 1.67				

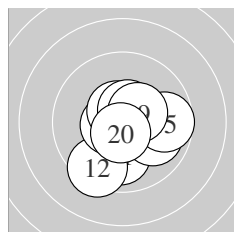

Serie 2:	10.0 ↓	9.4 ↙	10.0 ↗	10.5 *	9.7 →
	10.6 *	10.6 *	10.6 *	10.4 *	10.6 *
beste Teiler	81.3 (20.) 94.3 (17.) 95.3 (16.)				
Trefferlage	0.43 mm rechts, 0.48 mm tief				
Streuwert	1.47, horizontal: 1.50, vertikal: 1.45				

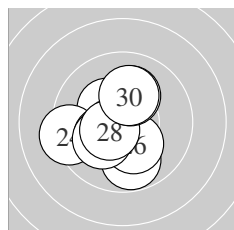

Serie 3:	10.6 *	9.8 ↓	10.3 *	9.3 ←	10.2 *
	10.2 *	10.2 *	10.5 *	10.1 ↑	10.1 ↑
beste Teiler	81.8 (21.) 114.0 (28.) 155.7 (23.)				
Trefferlage	0.71 mm links, 0.28 mm tief				
Streuwert	1.53, horizontal: 1.47, vertikal: 1.60				

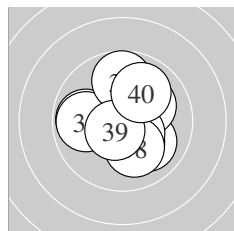

Serie 4:	10.0 ↘	9.8 ←	10.2 *	10.1 ↗	9.9 ←
	9.7 ↑	10.4 *	10.1 ↓	10.6 *	9.9 ↗
beste Teiler	90.1 (39.) 129.4 (37.) 184.4 (33.)				
Trefferlage	0.15 mm rechts, 0.03 mm tief				
Streuwert	1.68, horizontal: 1.70, vertikal: 1.67				

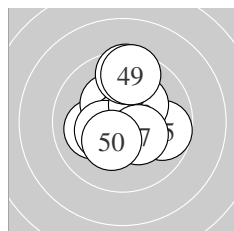

Serie 5:	10.1 ←	10.3 *	10.9 *	10.4 *	9.7 →
	10.3 *	10.4 *	9.5 ↑	9.5 ↑	10.3 *
beste Teiler	21.4 (43.) 149.8 (44.) 150.7 (47.)				
Trefferlage	0.07 mm rechts, 0.55 mm hoch				
Streuwert	1.66, horizontal: 1.49, vertikal: 1.82				

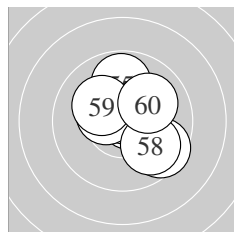

Serie 6:	10.5 *	10.7 *	10.5 *	9.6 ↘	9.8 ↑
	10.7 *	10.4 *	9.9 ↘	10.2 *	10.0 ↗
beste Teiler	53.1 (52.) 54.7 (56.) 114.2 (51.)				
Trefferlage	0.28 mm rechts, 0.42 mm hoch				
Streuwert	1.47, horizontal: 1.52, vertikal: 1.42				

Meyton Elektronik

**ISSF AR Men – Wertung – Junioren**

StandNr: 137

**Wadlegger, Stefan #98**

**StartNr: 113**

21. Januar 2017 13:07

AUT

---

\_\_\_\_\_  
Unterschrift des Schuetzen

Meyton Elektronik

Ergebnis:	<b>608.3</b>	(581)
Serien:	100.8	102.0 101.2 101.6 101.3 101.4
Zähler:	41	19 0 0 0 0 0 0 0 0
Innenzehner:	31	
weiteste:	470 (22), 460 (34), 451 (57)	
beste Teiler	12.3 (5.)	51.2 (36.) 53.4 (27.)
Trefferlage	0.22 mm links, 0.09 mm hoch	
Streuwert	1.64, horizontal: 1.81, vertikal: 1.46	

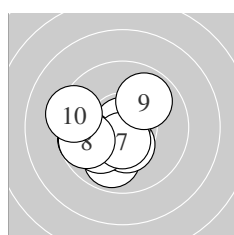
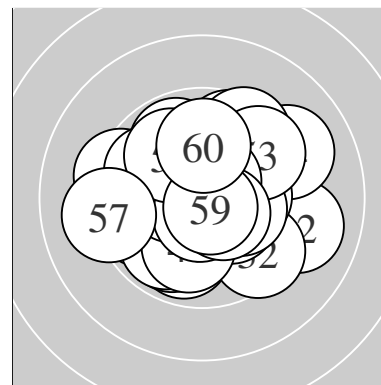

Serie 1:	10.3 *	9.9 ↘	10.4 *	10.1 ↙	10.9 *
	9.7 ←	10.5 *	9.7 ←	9.9 ↗	9.4 ←
beste Teiler	12.3 (5.)	106.0 (7.)	141.6 (3.)		
Trefferlage	1.13 mm links, 0.63 mm tief				
Streuwert	1.54, horizontal: 1.72, vertikal: 1.34				

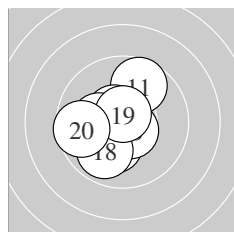

Serie 2:	9.7 ↗	10.2 *	10.5 *	10.6 *	10.0 ←
	10.6 *	10.2 *	9.9 ↘	10.7 *	9.6 ←
beste Teiler	64.0 (19.)	89.8 (16.)	96.9 (14.)		
Trefferlage	0.86 mm links, 0.29 mm tief				
Streuwert	1.41, horizontal: 1.35, vertikal: 1.47				

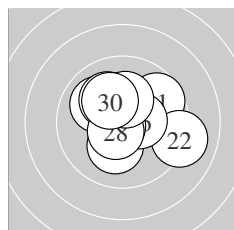

Serie 3:	9.7 ↗	9.1 →	10.0 ↘	10.2 *	10.1 ↘
	10.4 *	10.7 *	10.6 *	10.2 *	10.2 *
beste Teiler	53.4 (27.)	90.6 (28.)	130.5 (26.)		
Trefferlage	0.30 mm rechts, 0.41 mm hoch				
Streuwert	1.72, horizontal: 1.99, vertikal: 1.41				

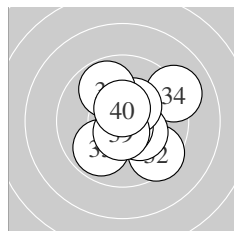

Serie 4:	10.7 *	9.5 ↘	9.9 ↙	9.1 ↗	10.3 *
	10.7 *	10.4 *	9.8 ↘	10.6 *	10.6 *
beste Teiler	51.2 (36.)	71.0 (31.)	87.5 (39.)		
Trefferlage	0.67 mm rechts, 0.00 mm				
Streuwert	1.71, horizontal: 1.72, vertikal: 1.70				

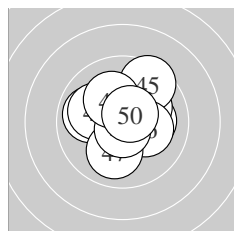

Serie 5:	9.9 ←	10.0 ↘	10.1 →	10.1 ↗	9.5 ↗
	10.2 *	10.0 ↘	10.7 *	10.2 *	10.6 *
beste Teiler	58.0 (48.)	87.0 (50.)	187.3 (46.)		
Trefferlage	0.19 mm rechts, 0.48 mm hoch				
Streuwert	1.58, horizontal: 1.71, vertikal: 1.44				

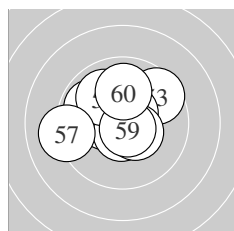

Serie 6:	9.9 ↘	10.4 *	9.6 ↗	10.6 *	10.6 *
	10.0 ↘	9.1 ←	10.5 *	10.7 *	10.0 ↑
beste Teiler	60.2 (59.)	80.6 (54.)	98.8 (55.)		
Trefferlage	0.50 mm links, 0.59 mm hoch				
Streuwert	1.69, horizontal: 1.99, vertikal: 1.31				

Meyton Elektronik

**ISSF AR Men – Wertung – Junioren**

StandNr: 138

**Friman, Björn** #70804642

**StartNr: 114**

21. Januar 2017 13:40

F – Esbo Skytteförening

---

\_\_\_\_\_  
Unterschrift des Schuetzen

Meyton Elektronik