

Ergebnis:	595.5	(572)							
Serien:	98.2	99.1	97.3	101.1	100.2	99.6			
Zähler:	34	24	2	0	0	0	0	0	0
Innenzehner:	24								
weiteste:	716 (16), 626 (2), 477 (26)								
beste Teiler	56.8 (45.)	59.6 (25.)	66.0 (8.)						
Trefferlage	0.41 mm rechts,	0.52 mm hoch							
Streuwert	2.02, horizontal: 2.31, vertikal: 1.69								

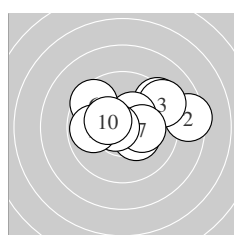

Serie 1:

9.3 ↗	8.4 →	9.2 ↗	10.4 *	10.3 *
9.5 ↘	10.2 *	10.7 *	9.9 ←	10.3 *
beste Teiler	66.0 (8.)	143.1 (4.)	151.2 (10.)	
Trefferlage	0.97 mm rechts, 0.83 mm hoch			
Streuwert	2.22, horizontal: 2.92, vertikal: 1.17			

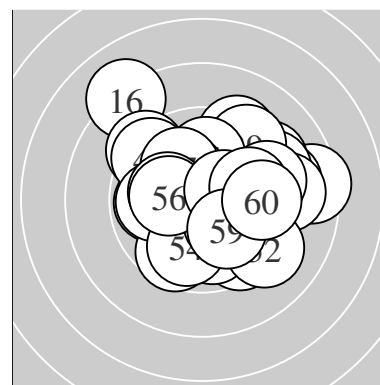
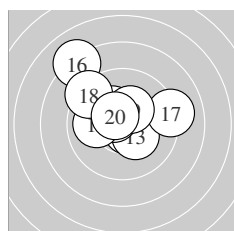

Serie 2:

10.3 *	10.6 *	10.3 *	10.6 *	10.0 ←
8.1 ↘	9.1 →	9.3 ↘	10.3 *	10.5 *
beste Teiler	77.8 (12.)	96.7 (14.)	106.2 (20.)	
Trefferlage	0.54 mm links, 1.19 mm hoch			
Streuwert	2.24, horizontal: 2.51, vertikal: 1.93			

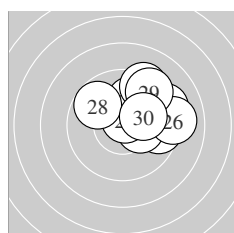

Serie 3:

10.0 ↑	9.6 →	10.3 *	9.2 ↗	10.7 *
9.0 →	9.3 ↑	9.8 ↘	9.3 ↗	10.1 →
beste Teiler	59.6 (25.)	171.4 (23.)	211.1 (30.)	
Trefferlage	1.88 mm rechts, 1.36 mm hoch			
Streuwert	1.75, horizontal: 2.03, vertikal: 1.41			

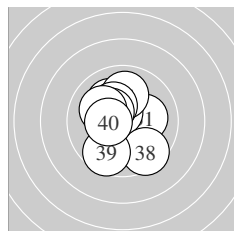

Serie 4:

10.1 →	10.1 ↘	10.6 *	10.0 ↑	10.3 *
10.4 *	10.1 ↘	9.5 ↘	9.6 ↓	10.4 *
beste Teiler	87.8 (33.)	134.3 (40.)	145.0 (36.)	
Trefferlage	0.38 mm links, 0.28 mm hoch			
Streuwert	1.64, horizontal: 1.43, vertikal: 1.82			

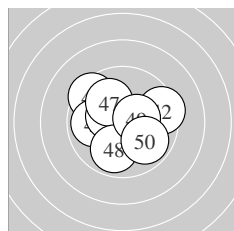

Serie 5:

10.0 ↘	9.4 →	9.5 ↘	9.9 ←	10.7 *
10.4 *	10.1 ↘	9.9 ↓	10.4 *	9.9 ↘
beste Teiler	56.8 (45.)	136.8 (49.)	137.3 (46.)	
Trefferlage	0.36 mm links, 0.33 mm hoch			
Streuwert	1.86, horizontal: 2.10, vertikal: 1.58			

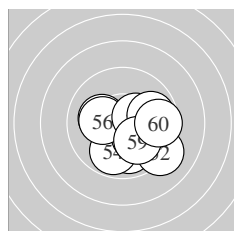

Serie 6:

9.9 ↓	9.2 ↘	10.2 *	9.8 ↓	10.3 *
10.2 *	10.4 *	9.9 →	10.1 ↘	9.6 →
beste Teiler	136.4 (57.)	175.5 (55.)	189.4 (56.)	
Trefferlage	0.93 mm rechts, 0.88 mm tief			
Streuwert	1.73, horizontal: 1.99, vertikal: 1.42			

Meyton Elektronik

ISSF AR Men – Wertung – Junioren

StandNr: 101

Egger, Martin #117

StartNr: 98

2. Dezember 2017 15:00

NÖ

Unterschrift des Schützen

Meyton Elektronik

Ergebnis:	605.0	(579)
Serien:	98.6	100.6 99.8 102.0 102.3 101.7
Zähler:	41	17 2 0 0 0 0 0 0 0
Innenzehner:	31	
weiteste:	628 (7), 566 (17), 477 (21)	
beste Teiler	3.6 (40.)	43.1 (9.) 49.5 (50.)
Trefferlage	0.15 mm rechts,	0.48 mm tief
Streuwert	1.77, horizontal:	1.87, vertikal: 1.66

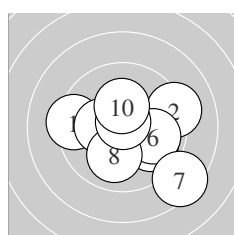
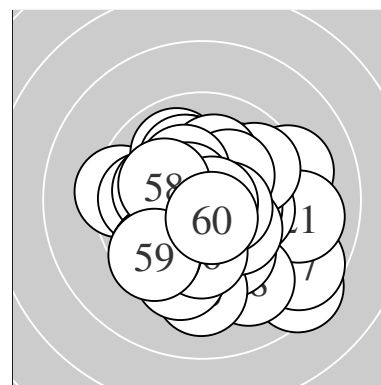

Serie 1:	9.4 ←	9.2 →	10.4 *	9.9 ↘	10.3 *
	9.9 →	8.4 ↘	10.0 ↓	10.8 *	10.3 *
beste Teiler	43.1 (9.)	136.4 (3.)	170.1 (5.)		
Trefferlage	0.59 mm rechts, 0.47 mm tief				
Streuwert	2.31, horizontal: 2.75, vertikal: 1.77				

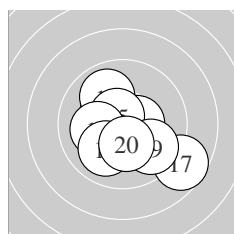

Serie 2:	10.5 *	10.2 *	9.9 ↖	10.5 *	10.6 *
	10.1 ←	8.7 ↘	10.0 ↙	9.8 ↘	10.3 *
beste Teiler	81.0 (15.)	117.2 (11.)	118.6 (14.)		
Trefferlage	0.15 mm rechts, 0.55 mm tief				
Streuwert	1.88, horizontal: 2.07, vertikal: 1.67				

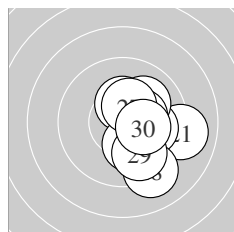

Serie 3:	9.0 →	10.0 →	10.4 *	10.1 ↗	10.2 *
	10.4 *	10.4 *	9.2 ↘	9.8 ↘	10.3 *
beste Teiler	142.2 (27.)	148.0 (23.)	149.5 (26.)		
Trefferlage	1.64 mm rechts, 0.51 mm tief				
Streuwert	1.58, horizontal: 1.31, vertikal: 1.81				

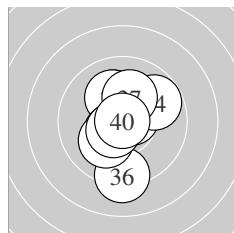

Serie 4:	10.1 ↖	10.7 *	10.1 ↖	9.8 ↗	10.4 *
	9.2 ↓	10.2 *	10.1 ↙	10.5 *	10.9 *
beste Teiler	3.6 (40.)	75.9 (32.)	103.9 (39.)		
Trefferlage	0.08 mm links, 0.00 mm				
Streuwert	1.63, horizontal: 1.14, vertikal: 2.01				

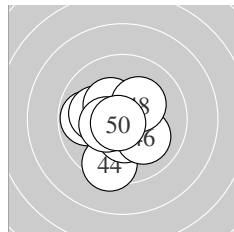

Serie 5:	10.6 *	9.8 ←	10.1 ←	9.4 ↓	10.4 *
	10.1 ↘	10.4 *	10.3 *	10.4 *	10.8 *
beste Teiler	49.5 (50.)	77.1 (41.)	132.0 (45.)		
Trefferlage	0.58 mm links, 0.50 mm tief				
Streuwert	1.41, horizontal: 1.40, vertikal: 1.41				

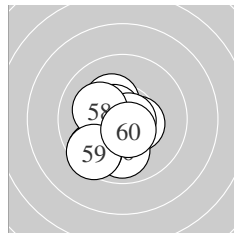

Serie 6:	9.7 ↙	10.3 *	10.5 *	10.6 *	10.8 *
	9.9 ↓	9.6 ↙	10.2 *	9.5 ↙	10.6 *
beste Teiler	49.7 (55.)	91.2 (54.)	99.7 (60.)		
Trefferlage	0.80 mm links, 0.89 mm tief				
Streuwert	1.44, horizontal: 1.30, vertikal: 1.57				

Meyton Elektronik

ISSF AR Men – Wertung – Junioren

StandNr: 102

Einwaller, Dominic #70804354

StartNr: 99

2. Dezember 2017 15:03

TLSB

Unterschrift des Schützen

Meyton Elektronik

Ergebnis:	598.4	(572)
Serien:	99.4	96.2 100.8 103.0 100.1 98.9
Zähler:	36	20 4 0 0 0 0 0 0 0
Innenzehner:	29	
weiteste:	620 (53),	579 (20), 575 (15)
beste Teiler	32.6 (49.)	44.1 (12.) 66.0 (32.)
Trefferlage	0.59 mm links, 0.22 mm hoch	
Streuwert	1.97, horizontal: 2.48, vertikal: 1.27	

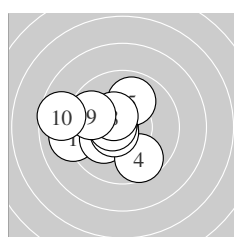
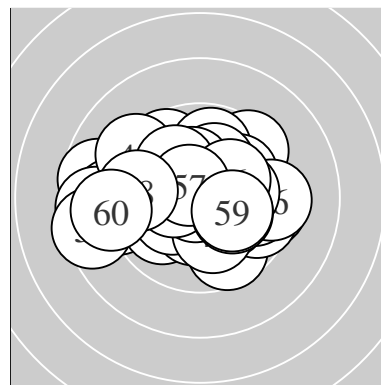

Serie 1:	9.1 ←	10.6 *	10.1 ↙	9.7 ↘	9.9 ↑
	10.6 *	10.6 *	10.4 *	9.7 ↖	8.7 ←
beste Teiler	81.3 (2.) 91.2 (6.) 94.1 (7.)				
Trefferlage	1.58 mm links, 0.03 mm hoch				
Streuwert	1.89, horizontal: 2.23, vertikal: 1.47				

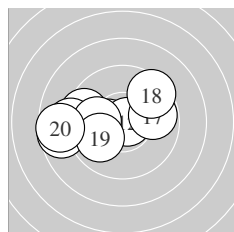

Serie 2:	10.4 *	10.8 *	9.5 ↖	9.0 ←	8.7 ←
	10.0 ←	9.8 →	9.5 ↗	9.9 ↙	8.6 ←
beste Teiler	44.1 (12.) 132.5 (11.) 237.1 (16.)				
Trefferlage	1.96 mm links, 0.10 mm hoch				
Streuwert	2.36, horizontal: 3.14, vertikal: 1.12				

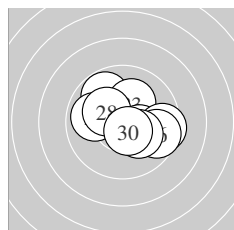

Serie 3:	10.5 *	9.8 ↘	10.2 *	10.3 *	9.5 →
	9.6 →	9.9 ←	10.2 *	10.2 *	10.6 *
beste Teiler	96.5 (30.) 108.0 (21.) 169.9 (24.)				
Trefferlage	0.59 mm rechts, 0.24 mm hoch				
Streuwert	1.68, horizontal: 2.02, vertikal: 1.25				

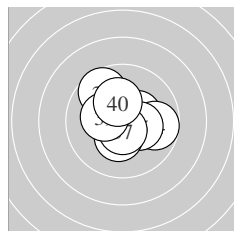

Serie 4:	10.4 *	10.7 *	10.7 *	9.8 →	10.3 *
	10.3 *	10.6 *	9.7 ↘	10.3 *	10.2 *
beste Teiler	66.0 (32.) 74.4 (33.) 85.0 (37.)				
Trefferlage	0.09 mm rechts, 0.09 mm hoch				
Streuwert	1.38, horizontal: 1.47, vertikal: 1.28				

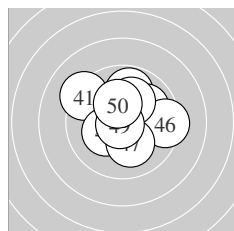

Serie 5:	9.2 ↘	10.2 *	10.2 *	9.8 ↑	10.0 ↗
	9.4 →	10.1 ↘	10.1 ↑	10.8 *	10.3 *
beste Teiler	32.6 (49.) 174.8 (50.) 177.5 (42.)				
Trefferlage	0.32 mm rechts, 0.86 mm hoch				
Streuwert	1.79, horizontal: 2.01, vertikal: 1.55				

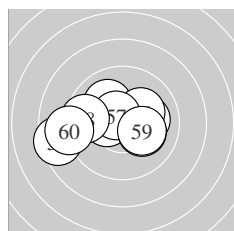

Serie 6:	10.1 →	10.1 ↘	8.5 ←	10.4 *	10.2 *
	10.2 *	10.6 *	9.6 ←	10.2 *	9.0 ←
beste Teiler	92.1 (57.) 144.1 (54.) 192.0 (59.)				
Trefferlage	1.04 mm links, 0.03 mm hoch				
Streuwert	2.22, horizontal: 2.97, vertikal: 1.02				

Meyton Elektronik

ISSF AR Men – Wertung – Junioren

StandNr: 103

Moravek, Tomas #70817534

StartNr: 100

2. Dezember 2017 15:28

CZE – Dukla Pilsen

Unterschrift des Schützen

Meyton Elektronik

Ergebnis:	602.0	(575)
Serien:	97.7	99.5 100.1 101.1 101.1 102.5
Zähler:	38	19 3 0 0 0 0 0 0 0
Innenzehner:	27	
weiteste:	545 (18), 533 (15), 518 (23)	
beste Teiler	29.0 (26.)	33.5 (59.) 52.7 (19.)
Trefferlage	0.13 mm rechts, 0.28 mm tief	
Streuwert	1.84, horizontal: 2.11, vertikal: 1.51	

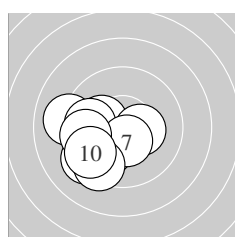
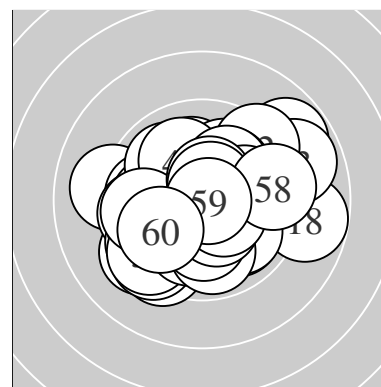

Serie 1:	10.2 *	10.3 *	10.0 ✓	9.3 ✓	9.1 ←
	9.8 ←	10.5 *	9.6 ←	9.4 ✓	9.5 ✓
beste Teiler	124.3 (7.)	154.0 (2.)	189.5 (1.)		
Trefferlage	1.99 mm links, 1.09 mm tief				
Streuwert	1.62, horizontal: 1.81, vertikal: 1.41				

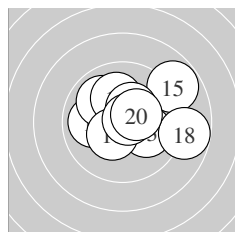

Serie 2:	9.9 ←	9.9 ↘	10.1 ↘	10.1 ↑	8.8 ↗
	10.4 *	10.4 *	8.8 →	10.7 *	10.4 *
beste Teiler	52.7 (19.)	136.4 (20.)	138.4 (16.)		
Trefferlage	0.84 mm rechts, 0.62 mm hoch				
Streuwert	2.05, horizontal: 2.53, vertikal: 1.41				

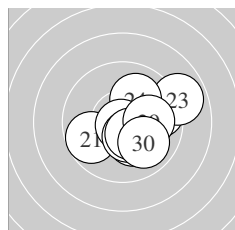

Serie 3:	9.7 ←	9.7 →	8.9 →	10.0 ↗	10.2 *
	10.8 *	10.4 *	10.5 *	10.0 →	9.9 ↘
beste Teiler	29.0 (26.)	124.2 (28.)	132.2 (27.)		
Trefferlage	1.23 mm rechts, 0.22 mm tief				
Streuwert	1.74, horizontal: 2.00, vertikal: 1.42				

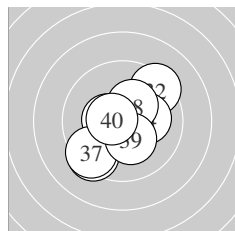

Serie 4:	9.4 ✓	9.4 ↗	10.5 *	10.1 →	10.7 *
	10.4 *	9.4 ✓	10.3 *	10.3 *	10.6 *
beste Teiler	74.0 (35.)	94.5 (40.)	106.3 (33.)		
Trefferlage	0.12 mm links, 0.43 mm tief				
Streuwert	1.79, horizontal: 1.82, vertikal: 1.76				

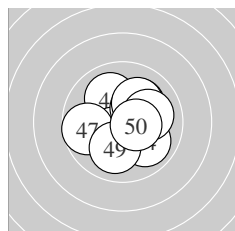

Serie 5:	10.0 ↘	10.5 *	10.3 *	9.9 ↘	10.1 ↗
	10.1 ↗	9.7 ←	10.0 →	10.0 ↓	10.5 *
beste Teiler	119.4 (42.)	119.6 (50.)	166.9 (43.)		
Trefferlage	0.36 mm rechts, 0.13 mm hoch				
Streuwert	1.58, horizontal: 1.67, vertikal: 1.48				

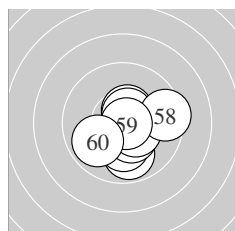

Serie 6:	9.9 ↓	10.4 *	10.2 *	10.5 *	10.4 *
	10.4 *	10.6 *	9.4 →	10.8 *	9.9 ←
beste Teiler	33.5 (59.)	90.4 (57.)	114.2 (54.)		
Trefferlage	0.47 mm rechts, 0.70 mm tief				
Streuwert	1.37, horizontal: 1.46, vertikal: 1.28				

Meyton Elektronik

ISSF AR Men – Wertung – Junioren

StandNr: 104

Hammermann, Marcel #80

StartNr: 101

2. Dezember 2017 15:24

VSB NWLZ

Unterschrift des Schützen

Meyton Elektronik

Ergebnis:	615.6	(587) ^{QF}							
Serien:	101.6	101.7	103.4	102.8	104.1	102.0			
Zähler:	47	13	0	0	0	0	0	0	0
Innenzehner:	39								
weiteste:	465 (60), 373 (34), 360 (52)								
beste Teiler	14.2 (26.) 16.7 (51.) 40.8 (16.)								
Trefferlage	0.30 mm links, 0.22 mm hoch								
Streuwert	1.41, horizontal: 1.32, vertikal: 1.49								

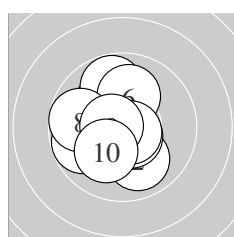
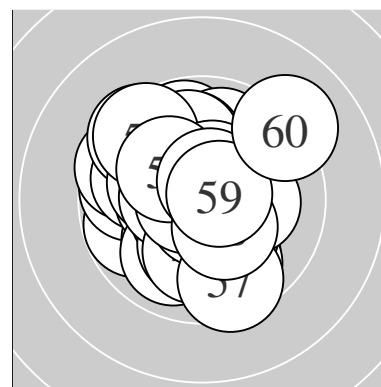

Serie 1:	9.8 ↙	10.0 ↘	10.6 *	10.2 *	9.8 ↑
	10.1 ↑	10.7 *	9.7 ↖	10.6 *	10.1 ↘
beste Teiler	64.4 (7.) 78.5 (9.) 87.7 (3.)				
Trefferlage	0.70 mm links, 0.11 mm hoch				
Streuwert	1.53, horizontal: 1.40, vertikal: 1.65				

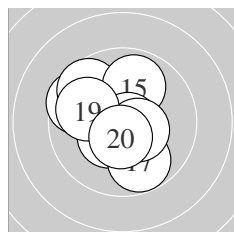

Serie 2:	10.4 *	10.7 *	9.6 ↖	9.6 ↖	9.9 ↑
	10.8 *	9.8 ↘	10.5 *	9.9 ↖	10.5 *
beste Teiler	40.8 (16.) 71.3 (12.) 105.9 (20.)				
Trefferlage	0.53 mm links, 0.10 mm hoch				
Streuwert	1.62, horizontal: 1.61, vertikal: 1.64				

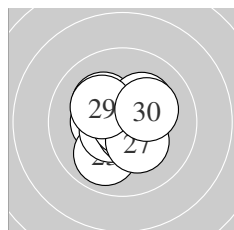

Serie 3:	10.4 *	10.2 *	9.9 ↘	10.5 *	10.6 *
	10.9 *	10.3 *	10.2 *	10.2 *	10.2 *
beste Teiler	14.2 (26.) 76.2 (25.) 101.0 (24.)				
Trefferlage	0.17 mm links, 0.03 mm tief				
Streuwert	1.22, horizontal: 1.24, vertikal: 1.19				

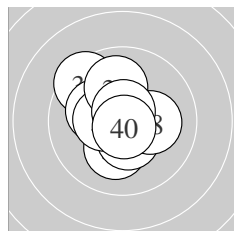

Serie 4:	10.4 *	10.2 *	10.4 *	9.5 ↖	10.2 *
	10.4 *	10.0 ↑	10.2 *	10.7 *	10.8 *
beste Teiler	43.1 (40.) 68.2 (39.) 127.1 (33.)				
Trefferlage	0.53 mm links, 0.37 mm hoch				
Streuwert	1.35, horizontal: 1.28, vertikal: 1.42				

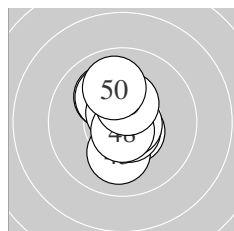

Serie 5:	10.1 ↖	10.6 *	10.1 ↓	10.7 *	10.1 ↖
	10.7 *	10.7 *	10.7 *	10.4 *	10.0 ↑
beste Teiler	57.5 (46.) 60.0 (48.) 74.3 (47.)				
Trefferlage	0.15 mm links, 0.37 mm hoch				
Streuwert	1.13, horizontal: 0.68, vertikal: 1.44				

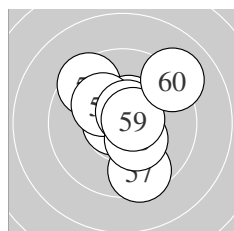

Serie 6:	10.9 *	9.5 ↖	10.7 *	10.5 *	10.2 *
	10.6 *	9.5 ↘	10.4 *	10.6 *	9.1 ↗
beste Teiler	16.7 (51.) 60.0 (53.) 77.4 (59.)				
Trefferlage	0.27 mm rechts, 0.45 mm hoch				
Streuwert	1.72, horizontal: 1.59, vertikal: 1.85				

Meyton Elektronik

ISSF AR Men – Wertung – Junioren

StandNr: 105

Riccardo, Ranzani #70804224

StartNr: 102

2. Dezember 2017 15:09

ITA – TSN Veroli

QF – Schütze hat sich fürs Finale qualifiziert

Unterschrift des Schützen

Meyton Elektronik

Ergebnis:	621.8	(594) ^{QF}
Serien:	104.2	100.9 104.7 105.1 103.4 103.5
Zähler:	54	6 0 0 0 0 0 0 0 0
Innenzehner:	43	
weiteste:	340	(17), 274 (12), 266 (52)
beste Teiler	14.1	(24.) 33.2 (13.) 45.1 (36.)
Trefferlage	0.41	mm rechts, 0.11 mm tief
Streuwert	1.14,	horizontal: 1.25, vertikal: 1.03

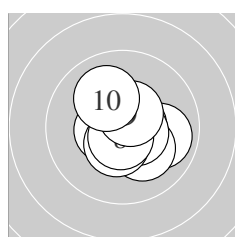
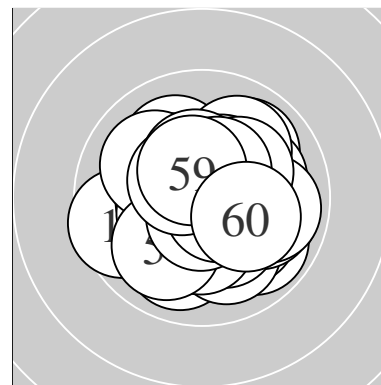

Serie 1:	9.9 →	10.5 *	10.2 *	10.6 *	10.6 *
	10.5 *	10.6 *	10.7 *	10.5 *	10.1 ↖
beste Teiler	67.2	(8.) 77.7 (4.)	88.4 (7.)		
Trefferlage	0.32	mm rechts, 0.05 mm tief			
Streuwert	1.08,	horizontal: 1.12, vertikal: 1.04			

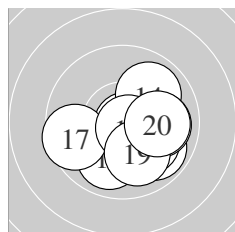

Serie 2:	9.9 ↙	9.9 ↘	10.8 *	9.9 ↗	10.1 ↘
	10.0 →	9.6 ←	10.7 *	10.0 ↘	10.0 →
beste Teiler	33.2	(13.) 55.8 (18.)	213.4 (15.)		
Trefferlage	0.79	mm rechts, 0.75 mm tief			
Streuwert	1.53,	horizontal: 1.78, vertikal: 1.24			

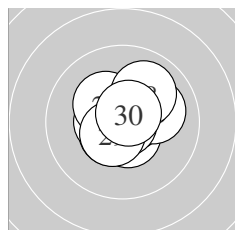

Serie 3:	10.6 *	10.6 *	10.1 →	10.9 *	10.5 *
	10.5 *	10.3 *	10.0 ↗	10.5 *	10.7 *
beste Teiler	14.1	(24.) 72.9 (30.)	78.7 (22.)		
Trefferlage	0.13	mm rechts, 0.24 mm hoch			
Streuwert	1.00,	horizontal: 1.08, vertikal: 0.92			

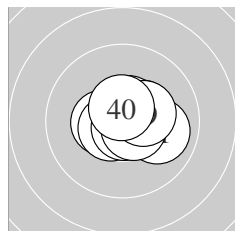

Serie 4:	10.0 →	10.4 *	10.6 *	10.4 *	10.6 *
	10.8 *	10.7 *	10.6 *	10.4 *	10.6 *
beste Teiler	45.1	(36.) 66.0 (37.)	86.9 (38.)		
Trefferlage	0.47	mm rechts, 0.07 mm hoch			
Streuwert	0.87,	horizontal: 1.08, vertikal: 0.60			

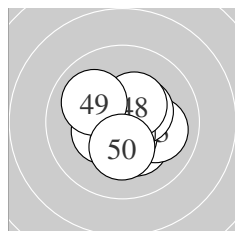

Serie 5:	10.4 *	10.3 *	10.0 →	10.6 *	10.4 *
	10.6 *	10.4 *	10.4 *	10.0 ↖	10.3 *
beste Teiler	85.0	(46.) 96.7 (44.)	140.8 (47.)		
Trefferlage	0.34	mm rechts, 0.29 mm tief			
Streuwert	1.17,	horizontal: 1.26, vertikal: 1.06			

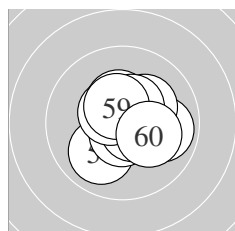

Serie 6:	10.0 ↙	9.9 →	10.2 *	10.7 *	10.6 *
	10.4 *	10.5 *	10.5 *	10.5 *	10.2 *
beste Teiler	74.1	(54.) 80.1 (55.)	109.1 (57.)		
Trefferlage	0.42	mm rechts, 0.11 mm hoch			
Streuwert	1.19,	horizontal: 1.27, vertikal: 1.11			

Meyton Elektronik

ISSF AR Men – Wertung – Junioren

StandNr: 106

Vas, Péter #70817535

StartNr: 103

2. Dezember 2017 15:14

HUN

QF – Schütze hat sich fürs Finale qualifiziert

Unterschrift des Schützen

Meyton Elektronik

Ergebnis:	616.4	(590) ^{QF}					
Serien:	103.4	99.9	103.0	102.7	104.0	103.4	
Zähler:	50	10	0	0	0	0	0
Innenzehner:	37						
weiteste:	347 (48), 335 (15), 316 (13)						
beste Teiler	38.3 (55.) 40.3 (49.) 43.6 (9.)						
Trefferlage	0.13 mm links, 0.15 mm tief						
Streuwert	1.33, horizontal: 1.46, vertikal: 1.19						

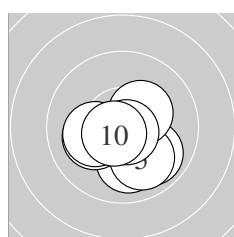
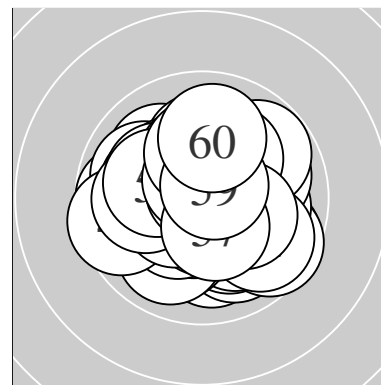

Serie 1:					
	10.7 *	10.0 ↓	9.9 ↘	10.7 *	10.0 ↓
	10.3 *	10.1 ←	10.2 *	10.8 *	10.7 *
beste Teiler	43.6 (9.) 61.8 (1.) 67.2 (4.)				
Trefferlage	0.15 mm rechts, 0.78 mm tief				
Streuwert	1.16, horizontal: 1.30, vertikal: 1.00				

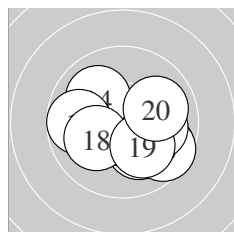

Serie 2:					
	10.1 ↘	10.5 *	9.7 ↘	10.0 ↘	9.6 ↘
	10.0 →	9.8 ←	10.1 ←	10.1 ↓	10.0 →
beste Teiler	102.0 (12.) 205.7 (11.) 211.4 (19.)				
Trefferlage	0.64 mm rechts, 0.66 mm tief				
Streuwert	1.72, horizontal: 2.10, vertikal: 1.21				

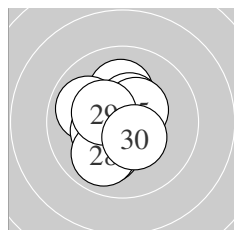

Serie 3:					
	10.1 ↓	10.1 ↑	10.5 *	10.8 *	10.5 *
	9.9 ↖	10.4 *	9.9 ↓	10.4 *	10.4 *
beste Teiler	44.2 (24.) 124.5 (25.) 125.5 (23.)				
Trefferlage	0.54 mm links, 0.05 mm tief				
Streuwert	1.26, horizontal: 1.09, vertikal: 1.41				

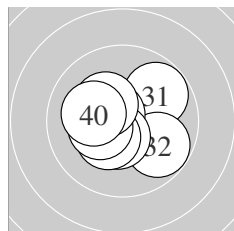

Serie 4:					
	9.8 ↗	9.8 ↘	10.5 *	10.4 *	10.6 *
	10.5 *	10.4 *	10.3 *	10.3 *	10.1 ←
beste Teiler	83.2 (35.) 112.9 (36.) 120.1 (33.)				
Trefferlage	0.44 mm links, 0.08 mm tief				
Streuwert	1.33, horizontal: 1.54, vertikal: 1.08				

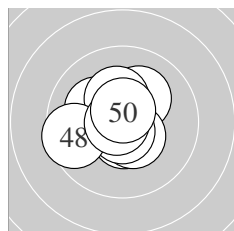

Serie 5:					
	10.2 *	10.5 *	10.6 *	10.2 *	10.5 *
	10.7 *	10.3 *	9.6 ←	10.8 *	10.6 *
beste Teiler	40.3 (49.) 64.0 (46.) 80.0 (50.)				
Trefferlage	0.37 mm links, 0.23 mm hoch				
Streuwert	1.19, horizontal: 1.30, vertikal: 1.08				

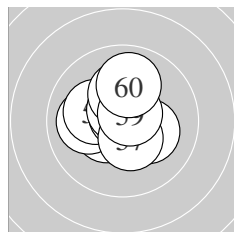

Serie 6:					
	10.4 *	10.2 *	10.0 ←	10.2 *	10.8 *
	10.6 *	10.4 *	10.2 *	10.7 *	9.9 ↑
beste Teiler	38.3 (55.) 72.8 (59.) 80.6 (56.)				
Trefferlage	0.26 mm links, 0.40 mm hoch				
Streuwert	1.18, horizontal: 1.21, vertikal: 1.14				

ISSF AR Men – Wertung – Junioren

StandNr: 107

Smetana, Frantisek #70817160

StartNr: 104

2. Dezember 2017 15:17

CZE – Dukla Pilsen

QF – Schütze hat sich fürs Finale qualifiziert

Unterschrift des Schützen

Meyton Elektronik

Ergebnis:	609.7	(582)
Serien:	102.9	101.1 101.6 104.2 100.0 99.9
Zähler:	43	16 1 0 0 0 0 0 0 0
Innenzehner:	36	
weiteste:	530	(60), 476 (58), 454 (45)
beste Teiler	8.2	(14.) 24.3 (35.) 40.1 (10.)
Trefferlage	0.13 mm	rechts, 0.03 mm hoch
Streuwert	1.62,	horizontal: 1.82, vertikal: 1.39

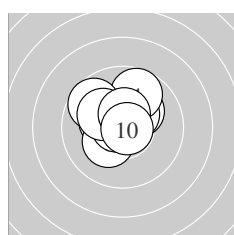
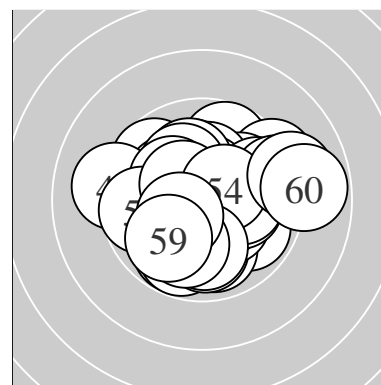

Serie 1:

10.2 *	10.3 *	10.4 *	9.7 ↗	9.7 ↘
10.3 *	10.8 *	10.2 *	10.5 *	10.8 *
beste Teiler	40.1 (10.)	50.0 (7.)	115.8 (9.)	
Trefferlage	0.34 mm links, 0.87 mm hoch			
Streuwert	1.24, horizontal: 1.34, vertikal: 1.13			

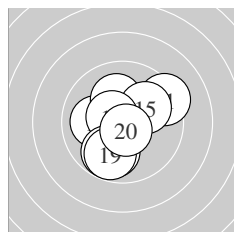

Serie 2:

9.3 ↗	10.0 ←	10.2 *	10.9 *	10.0 ↗
9.9 ↓	10.5 *	9.8 ↓	9.8 ↓	10.7 *
beste Teiler	8.2 (14.)	74.8 (20.)	101.9 (17.)	
Trefferlage	0.11 mm links, 0.28 mm tief			
Streuwert	1.76, horizontal: 1.72, vertikal: 1.80			

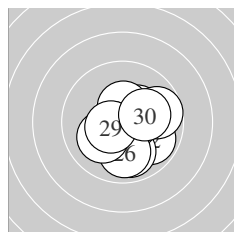

Serie 3:

10.3 *	9.9 ↘	9.9 ↓	9.7 →	10.7 *
9.9 ↓	10.4 *	10.1 ↙	10.5 *	10.2 *
beste Teiler	75.3 (25.)	109.3 (29.)	129.1 (27.)	
Trefferlage	0.73 mm rechts, 0.46 mm tief			
Streuwert	1.43, horizontal: 1.45, vertikal: 1.42			

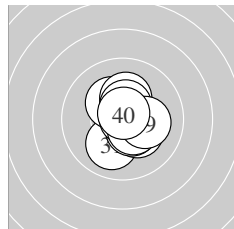

Serie 4:

10.0 ↓	10.3 *	10.5 *	10.3 *	10.9 *
10.5 *	10.2 *	10.5 *	10.2 *	10.8 *
beste Teiler	24.3 (35.)	50.8 (40.)	115.9 (38.)	
Trefferlage	0.38 mm rechts, 0.04 mm tief			
Streuwert	1.09, horizontal: 0.90, vertikal: 1.25			

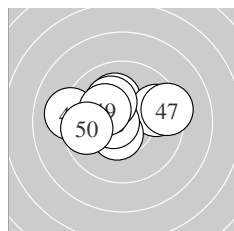

Serie 5:

10.1 ↖	10.5 *	9.7 →	10.5 *	9.1 ←
10.6 *	9.4 →	10.2 *	10.2 *	9.7 ←
beste Teiler	80.0 (46.)	112.0 (42.)	113.2 (44.)	
Trefferlage	0.64 mm links, 0.59 mm hoch			
Streuwert	1.87, horizontal: 2.46, vertikal: 0.97			

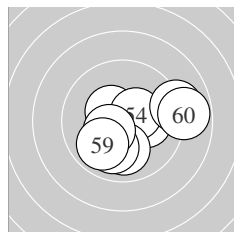

Serie 6:

10.8 *	10.4 *	10.2 *	10.4 *	10.0 ↓
10.0 ↓	10.4 *	9.0 →	9.9 ↙	8.8 →
beste Teiler	43.9 (51.)	128.5 (52.)	129.2 (54.)	
Trefferlage	0.80 mm rechts, 0.45 mm tief			
Streuwert	1.98, horizontal: 2.44, vertikal: 1.37			

ISSF AR Men – Wertung – Junioren

StandNr: 108

Diem, Patrick #81

StartNr: 105

2. Dezember 2017 15:29

AUT

Unterschrift des Schützen

Meyton Elektronik

Ergebnis: **600.9** (573)

Serien: 99.7 100.5 101.0 100.4 100.2 99.1

Zähler: 34 25 1 0 0 0 0 0 0

Innenzehner: 18

weiteste: 526 (8), 459 (32), 433 (2)

beste Teiler 48.2 (28.) 62.0 (29.) 74.8 (37.)

Trefferlage 0.04 mm links, 0.13 mm hoch

Streuwert 1.82, horizontal: 1.78, vertikal: 1.86

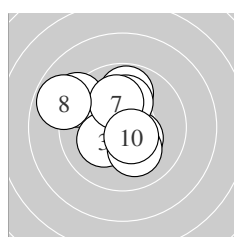
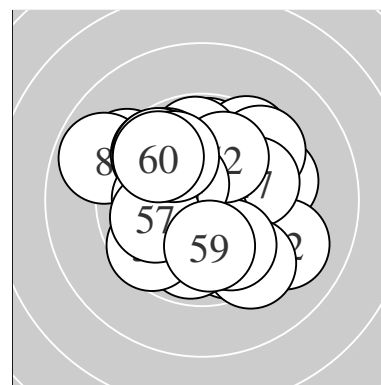

Serie 1:

10.5 *	9.2 ↘	10.2 *	10.4 *	9.8 ↑
10.1 ↑	10.1 ↑	8.8 ↙	10.1 ↓	10.5 *

beste Teiler 104.0 (10.) 123.8 (1.) 142.1 (4.)

Trefferlage 0.80 mm links, 0.76 mm hoch

Streuwert 1.87, horizontal: 2.02, vertikal: 1.71

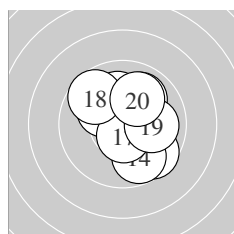

Serie 2:

10.0 ↗	9.6 ↘	10.2 *	9.8 ↓	10.1 ↑
10.5 *	10.6 *	9.7 ↘	10.0 →	10.0 ↗

beste Teiler 94.5 (17.) 106.1 (16.) 194.0 (13.)

Trefferlage 0.57 mm rechts, 0.35 mm hoch

Streuwert 1.72, horizontal: 1.57, vertikal: 1.85

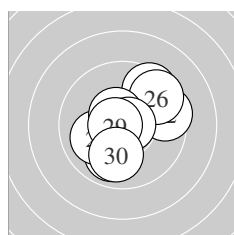

Serie 3:

10.6 *	9.5 →	9.9 ↓	10.0 ↙	9.5 ↗
9.5 ↗	10.5 *	10.8 *	10.7 *	10.0 ↓

beste Teiler 48.2 (28.) 62.0 (29.) 93.1 (21.)

Trefferlage 0.37 mm rechts, 0.04 mm hoch

Streuwert 1.80, horizontal: 1.82, vertikal: 1.78

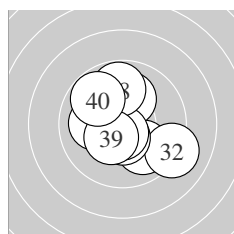

Serie 4:

9.9 ↘	9.1 ↘	10.1 ←	10.1 ↑	10.5 *
10.0 ↘	10.7 *	9.8 ↑	10.4 *	9.8 ↘

beste Teiler 74.8 (37.) 113.0 (35.) 143.9 (39.)

Trefferlage 0.05 mm links, 0.20 mm hoch

Streuwert 1.87, horizontal: 1.85, vertikal: 1.88

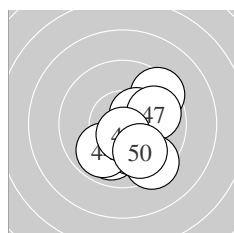

Serie 5:

9.9 ↓	9.5 ↗	10.1 ↓	9.9 ↗	10.6 *
10.4 *	9.9 →	10.6 *	9.4 ↓	9.9 ↓

beste Teiler 86.2 (48.) 95.3 (45.) 136.4 (46.)

Trefferlage 0.88 mm rechts, 0.95 mm tief

Streuwert 1.64, horizontal: 1.49, vertikal: 1.77

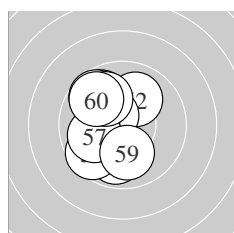

Serie 6:

9.9 ↓	10.0 ↗	9.8 ↘	10.5 *	9.7 ↘
9.6 ↗	10.0 ←	9.9 ↘	10.0 ↓	9.7 ↘

beste Teiler 119.8 (54.) 230.9 (59.) 235.6 (52.)

Trefferlage 1.23 mm links, 0.37 mm hoch

Streuwert 1.74, horizontal: 1.21, vertikal: 2.14

ISSF AR Men – Wertung – Junioren

StandNr: 109

Mair, Tobias #124

StartNr: 106

2. Dezember 2017 15:08

TLSB

Unterschrift des Schützen

Meyton Elektronik

Ergebnis:	620.8	(596) ^{QF}
Serien:	100.9	104.3 104.4 104.2 103.8 103.2
Zähler:	56	4 0 0 0 0 0 0 0 0
Innenzehner:	49	
weiteste:	379	(41), 343 (4), 319 (1)
beste Teiler	7.2	(42.) 29.5 (29.) 46.4 (17.)
Trefferlage	0.11 mm	links, 0.32 mm hoch
Streuwert	1.15,	horizontal: 1.16, vertikal: 1.15

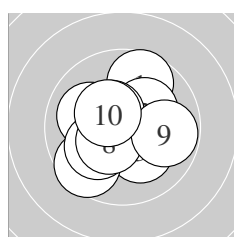
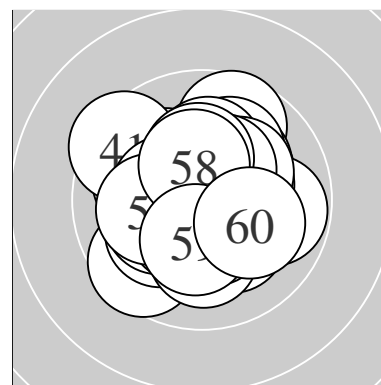

Serie 1:	9.7 ↗	10.2 *	10.2 *	9.6 ↙	10.5 *
	10.0 ↖	10.1 ↙	10.4 *	9.8 →	10.4 *
beste Teiler	119.2 (5.) 129.4 (8.) 137.2 (10.)				
Trefferlage	0.22 mm links, 0.00 mm				
Streuwert	1.69, horizontal: 1.77, vertikal: 1.61				

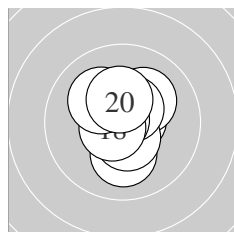

Serie 2:	10.1 ↓	10.5 *	10.7 *	10.2 *	10.5 *
	10.5 *	10.8 *	10.6 *	10.1 ↖	10.3 *
beste Teiler	46.4 (17.) 74.2 (13.) 78.2 (18.)				
Trefferlage	0.03 mm rechts, 0.32 mm hoch				
Streuwert	1.03, horizontal: 0.79, vertikal: 1.21				

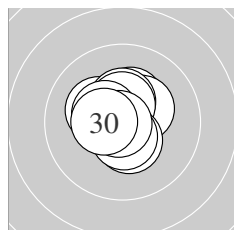

Serie 3:	10.3 *	10.2 *	10.3 *	10.4 *	10.5 *
	10.4 *	10.4 *	10.6 *	10.8 *	10.5 *
beste Teiler	29.5 (29.) 97.5 (28.) 114.1 (25.)				
Trefferlage	0.20 mm links, 0.39 mm hoch				
Streuwert	0.92, horizontal: 0.90, vertikal: 0.94				

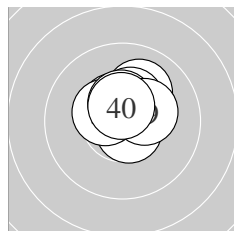

Serie 4:	10.3 *	10.5 *	10.5 *	10.7 *	10.4 *
	10.1 ↗	10.4 *	10.5 *	10.3 *	10.5 *
beste Teiler	71.6 (34.) 102.3 (40.) 114.3 (32.)				
Trefferlage	0.39 mm rechts, 0.85 mm hoch				
Streuwert	0.77, horizontal: 0.87, vertikal: 0.65				

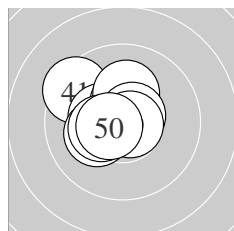

Serie 5:	9.4 ↖	10.9 *	10.4 *	10.4 *	10.2 *
	10.2 *	10.6 *	10.4 *	10.7 *	10.6 *
beste Teiler	7.2 (42.) 52.4 (49.) 77.9 (47.)				
Trefferlage	0.72 mm links, 0.44 mm hoch				
Streuwert	1.11, horizontal: 1.21, vertikal: 1.01				

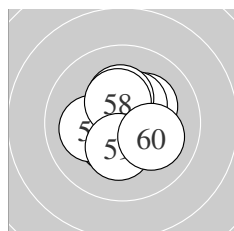

Serie 6:	10.5 *	10.2 *	10.4 *	10.5 *	10.1 ←
	10.4 *	10.3 *	10.4 *	10.3 *	10.1 →
beste Teiler	101.6 (51.) 115.6 (54.) 133.0 (53.)				
Trefferlage	0.05 mm rechts, 0.07 mm tief				
Streuwert	1.20, horizontal: 1.13, vertikal: 1.27				

Meyton Elektronik

ISSF AR Men – Wertung – Junioren

StandNr: 110

Chatziplis, Alexandros #70817168

StartNr: 107

2. Dezember 2017 15:18

ITA

QF – Schütze hat sich fürs Finale qualifiziert

Unterschrift des Schützen

Meyton Elektronik

Ergebnis: **615.0** (588)

Serien: 102.3 102.4 103.6 103.0 102.2 101.5

Zähler: 48 12 0 0 0 0 0 0 0

Innenzehner: 39

weiteste: 369 (50), 364 (10), 339 (54)

beste Teiler 33.5 (37.) 51.0 (4.) 60.8 (34.)

Trefferlage 0.19 mm rechts, 0.33 mm tief

Streuwert 1.36, horizontal: 1.47, vertikal: 1.24

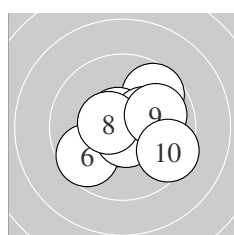
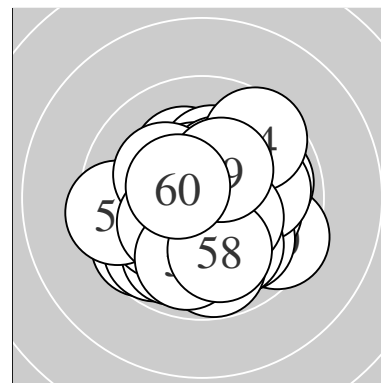

Serie 1:

9.7 ↗	10.7 *	10.3 *	10.7 *	10.6 *
9.7 ↙	10.7 *	10.5 *	9.9 →	9.5 ↘

beste Teiler 51.0 (4.) 68.7 (7.) 70.3 (2.)

Trefferlage 0.51 mm rechts, 0.06 mm tief

Streuwert 1.55, horizontal: 1.78, vertikal: 1.29

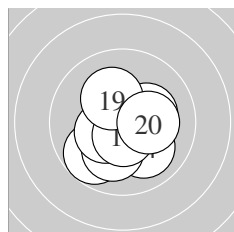

Serie 2:

10.2 *	10.6 *	10.3 *	10.0 ↘	9.8 ↙
10.1 ↓	10.4 *	10.6 *	10.2 *	10.2 *

beste Teiler 94.1 (18.) 97.4 (12.) 140.6 (17.)

Trefferlage 0.14 mm rechts, 0.70 mm tief

Streuwert 1.29, horizontal: 1.37, vertikal: 1.20

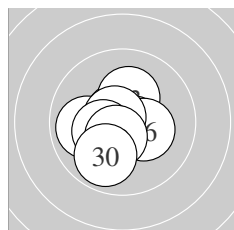

Serie 3:

10.5 *	10.7 *	10.2 *	9.9 ←	10.6 *
10.3 *	10.7 *	10.3 *	10.5 *	9.9 ↓

beste Teiler 66.8 (27.) 67.6 (22.) 81.3 (25.)

Trefferlage 0.37 mm links, 0.16 mm tief

Streuwert 1.16, horizontal: 1.17, vertikal: 1.15

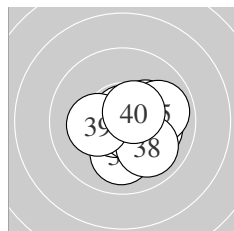

Serie 4:

10.1 →	10.2 *	10.0 ↓	10.7 *	9.9 →
10.6 *	10.8 *	10.0 ↘	10.2 *	10.5 *

beste Teiler 33.5 (37.) 60.8 (34.) 90.0 (36.)

Trefferlage 0.71 mm rechts, 0.35 mm tief

Streuwert 1.19, horizontal: 1.33, vertikal: 1.03

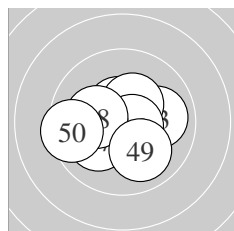

Serie 5:

10.5 *	10.3 *	10.0 →	10.5 *	10.4 *
10.7 *	10.1 ↙	10.2 *	10.0 ↘	9.5 ←

beste Teiler 73.1 (46.) 106.2 (44.) 121.4 (41.)

Trefferlage 0.03 mm links, 0.27 mm tief

Streuwert 1.50, horizontal: 1.86, vertikal: 1.03

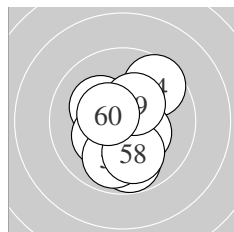

Serie 6:

10.2 *	9.8 ↓	10.2 *	9.6 ↗	9.9 ↓
10.6 *	10.3 *	10.0 ↓	10.4 *	10.5 *

beste Teiler 90.4 (56.) 114.9 (60.) 146.1 (59.)

Trefferlage 0.17 mm rechts, 0.46 mm tief

Streuwert 1.55, horizontal: 1.28, vertikal: 1.78

Meyton Elektronik

ISSF AR Men – Wertung – Junioren

StandNr: 111

Wadlegger, Stefan #98

StartNr: 108

2. Dezember 2017 15:15

AUT

Unterschrift des Schützen

Meyton Elektronik

ISSF AR Men – Wertung – Junioren

StandNr: 112

Sommavilla, Manuel #322

StartNr: 109

2. Dezember 2017 13:25

T – SG Wattens

Ergebnis: **0.0** (0)_{DNS}
Serien:
Zähler: 0 0 0 0 0 0 0 0 0 0
Innenzehner: 0
weiteste:
~~beste Teiler~~ – Schütze ist nicht zum Wettkampf angetreten
Trefferlage 0.00 mm , 0.00 mm
Streuwert
Unterschrift des Schützen

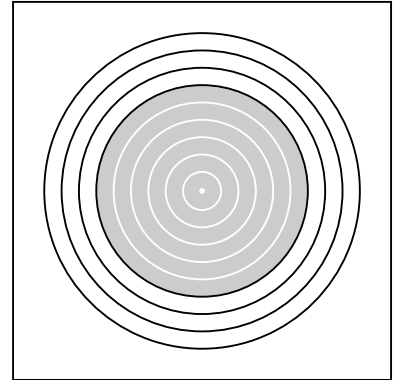

Ergebnis:	576.6	(549)
Serien:	94.9 97.1 97.0 94.8 95.3 97.5	
Zähler:	19 33 6 2 0 0 0 0 0 0	
Innenzehner:	12	
weiteste:	857 (47), 813 (8), 610 (57)	
beste Teiler	50.4 (11.) 84.1 (48.) 91.0 (30.)	
Trefferlage	0.44 mm links, 0.06 mm hoch	
Streuwert	2.64, horizontal: 2.84, vertikal: 2.42	

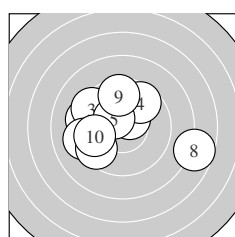
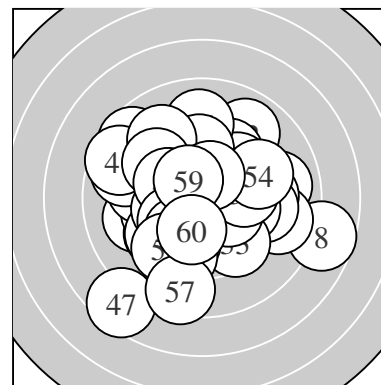

Serie 1:	9.3 ←	10.5 *	9.4 ↘	9.6 ↗	10.4 *
	9.2 ←	9.5 ↙	7.7 →	9.6 ↑	9.7 ←
beste Teiler	119.2 (2.) 133.6 (5.) 315.7 (10.)				
Trefferlage	0.82 mm links, 0.38 mm hoch				
Streuwert	2.96, horizontal: 3.65, vertikal: 2.05				

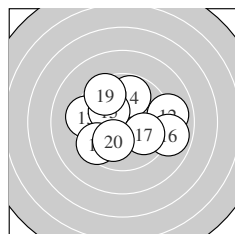

Serie 2:	10.8 *	9.0 →	9.4 ←	9.8 ↑	10.2 *
	8.9 →	9.9 ↘	9.5 ↙	9.5 ↘	10.1 ↙
beste Teiler	50.4 (11.) 188.3 (15.) 222.7 (20.)				
Trefferlage	0.15 mm rechts, 0.09 mm hoch				
Streuwert	2.54, horizontal: 3.05, vertikal: 1.89				

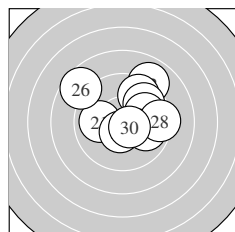

Serie 3:	10.0 ←	8.9 ↗	9.6 ↗	9.7 ↗	9.9 →
	8.6 ↘	9.9 →	9.3 →	10.5 *	10.6 *
beste Teiler	91.0 (30.) 109.6 (29.) 246.0 (21.)				
Trefferlage	0.92 mm rechts, 1.14 mm hoch				
Streuwert	2.31, horizontal: 2.64, vertikal: 1.92				

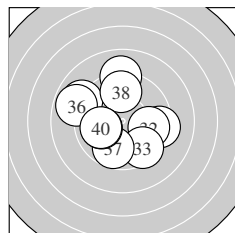

Serie 4:	9.3 →	9.8 →	9.5 ↘	9.0 ↘	9.0 ↑
	8.8 ←	9.7 ↓	9.7 ↑	10.0 ←	10.0 ←
beste Teiler	240.3 (39.) 245.4 (40.) 291.0 (32.)				
Trefferlage	0.64 mm links, 0.33 mm hoch				
Streuwert	2.77, horizontal: 2.99, vertikal: 2.54				

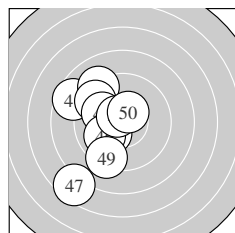

Serie 5:	8.6 ↘	10.2 *	9.1 ↘	9.5 ↘	10.0 ↘
	10.0 ↙	7.5 ↙	10.6 *	9.3 ↓	10.5 *
beste Teiler	84.1 (48.) 122.6 (50.) 176.0 (42.)				
Trefferlage	2.32 mm links, 0.21 mm tief				
Streuwert	2.62, horizontal: 1.86, vertikal: 3.20				

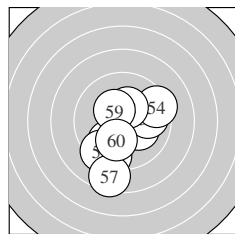

Serie 6:	10.2 *	9.9 →	9.9 ↙	9.4 →	9.4 ↓
	9.4 ↙	8.5 ↓	10.3 *	10.4 *	10.1 ↓
beste Teiler	146.2 (59.) 153.1 (58.) 195.4 (51.)				
Trefferlage	0.05 mm rechts, 1.35 mm tief				
Streuwert	2.28, horizontal: 2.02, vertikal: 2.52				

Meyton Elektronik

ISSF AR Men – Wertung – Junioren

StandNr: 113

Nußbaumer, Dustin #70817473

StartNr: 110

2. Dezember 2017 14:59

VSBB-TZ Höchst

Unterschrift des Schützen

Meyton Elektronik

Ergebnis:	566.9	(541)
Serien:	94.3 91.5 97.5 94.5 93.2 95.9	
Zähler:	15 32 12 1 0 0 0 0 0 0	
Innenzehner:	10	
weiteste:	802 (47), 747 (20), 684 (11)	
beste Teiler	91.7 (21.) 96.8 (50.) 101.2 (9.)	
Trefferlage	0.15 mm rechts, 0.07 mm hoch	
Streuwert	2.93, horizontal: 3.26, vertikal: 2.55	

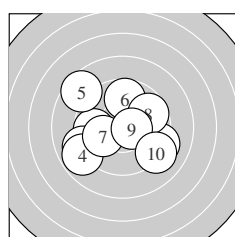
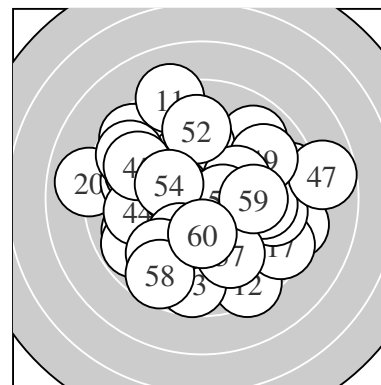

Serie 1:	9.7 ←	9.2 →	9.0 ←	8.8 ↙	8.6 ↘
	9.7 ↑	10.0 ←	9.7 →	10.5 *	9.1 ↘
beste Teiler	101.2 (9.)	234.0 (7.)	310.0 (6.)		
Trefferlage	0.67 mm links, 0.26 mm tief				
Streuwert	2.96, horizontal: 3.43, vertikal: 2.40				

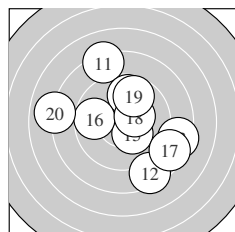

Serie 2:	8.2 ↑	8.4 ↘	8.4 →	9.8 ↑	10.3 *
	9.7 ←	8.6 ↘	10.4 *	9.7 ↑	8.0 ←
beste Teiler	146.6 (18.)	163.0 (15.)	299.4 (14.)		
Trefferlage	0.57 mm rechts, 0.27 mm hoch				
Streuwert	3.70, horizontal: 3.97, vertikal: 3.41				

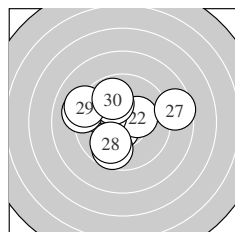

Serie 3:	10.6 *	10.3 *	10.2 *	9.7 ↓	9.1 ↘
	10.1 ↘	8.6 →	9.9 ↓	9.2 ↘	9.8 ↘
beste Teiler	91.7 (21.)	169.5 (22.)	190.0 (23.)		
Trefferlage	0.79 mm links, 0.38 mm hoch				
Streuwert	2.40, horizontal: 2.87, vertikal: 1.82				

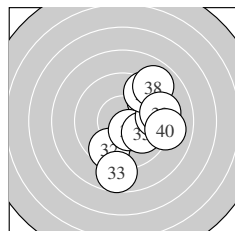

Serie 4:	9.5 ↗	9.6 ↓	8.7 ↓	10.5 *	10.0 ↘
	9.5 →	9.4 ↗	8.9 ↗	9.3 →	9.1 →
beste Teiler	120.6 (34.)	246.1 (35.)	337.2 (32.)		
Trefferlage	2.15 mm rechts, 0.11 mm tief				
Streuwert	2.48, horizontal: 2.03, vertikal: 2.86				

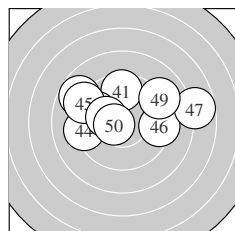

Serie 5:	9.6 ↑	8.8 ↘	9.7 ↘	9.2 ←	9.1 ↘
	9.3 →	7.7 →	10.2 *	9.0 ↗	10.6 *
beste Teiler	96.8 (50.)	187.2 (48.)	307.3 (43.)		
Trefferlage	0.29 mm links, 1.25 mm hoch				
Streuwert	3.19, horizontal: 4.26, vertikal: 1.49				

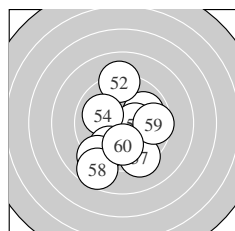

Serie 6:	9.9 ↗	9.1 ↑	10.4 *	10.0 ↘	9.8 ↓
	9.1 ↙	9.3 ↘	8.7 ↓	9.6 →	10.0 ↓
beste Teiler	135.1 (53.)	234.0 (54.)	235.0 (60.)		
Trefferlage	0.06 mm links, 1.07 mm tief				
Streuwert	2.56, horizontal: 2.21, vertikal: 2.87				

Meyton Elektronik

ISSF AR Men – Wertung – Junioren

StandNr: 114

Gruber, Robert jr. #70817536

StartNr: 111

2. Dezember 2017 14:51

T – SG Wattens

Unterschrift des Schützen

Meyton Elektronik

Ergebnis:	615.7	(596) ^{QF}							
Serien:	101.9	103.4	103.8	102.6	102.9	101.1			
Zähler:	56	4	0	0	0	0	0	0	0
Innenzehner:	38								
weiteste:	398 (37), 338 (2), 265 (32)								
beste Teiler	29.8 (3.)	37.6 (22.)	42.4 (39.)						
Trefferlage	0.13 mm rechts, 0.74 mm hoch								
Streuwert	1.23, horizontal: 1.35, vertikal: 1.09								

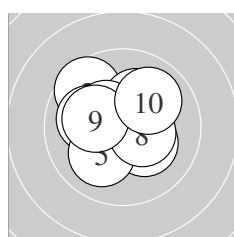
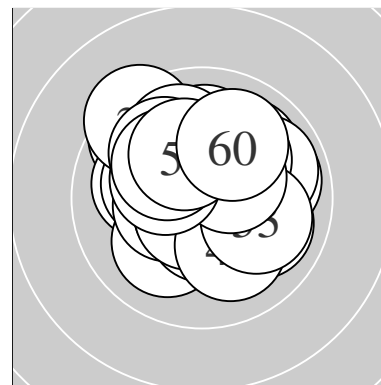

Serie 1:	10.2 *	9.6 ↖	10.8 *	10.0 ↖	10.1 ↗
	10.2 *	10.4 *	10.4 *	10.2 *	10.0 ↗
beste Teiler	29.8 (3.)	137.9 (8.)	142.2 (7.)		
Trefferlage	0.31 mm links, 0.46 mm hoch				
Streuwert	1.47, horizontal: 1.62, vertikal: 1.32				

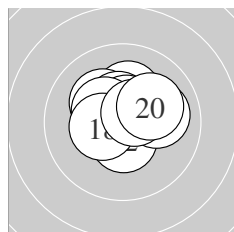

Serie 2:	10.2 *	10.5 *	10.0 →	10.2 *	10.5 *
	10.6 *	10.4 *	10.4 *	10.5 *	10.1 ↗
beste Teiler	93.6 (16.)	101.0 (19.)	114.2 (12.)		
Trefferlage	0.14 mm rechts, 0.67 mm hoch				
Streuwert	1.07, horizontal: 1.26, vertikal: 0.85				

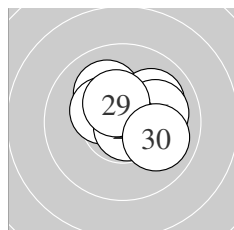

Serie 3:	10.6 *	10.8 *	10.8 *	10.1 ↖	10.0 ↗
	10.0 →	10.3 *	10.8 *	10.4 *	10.0 ↗
beste Teiler	37.6 (22.)	42.9 (23.)	46.0 (28.)		
Trefferlage	0.50 mm rechts, 0.48 mm hoch				
Streuwert	1.10, horizontal: 1.29, vertikal: 0.88				

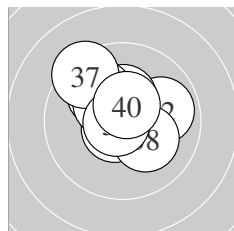

Serie 4:	10.7 *	9.9 →	10.3 *	10.0 ↖	10.3 *
	10.5 *	9.4 ↖	10.2 *	10.8 *	10.5 *
beste Teiler	42.4 (39.)	73.5 (31.)	102.0 (36.)		
Trefferlage	0.16 mm links, 0.86 mm hoch				
Streuwert	1.34, horizontal: 1.45, vertikal: 1.23				

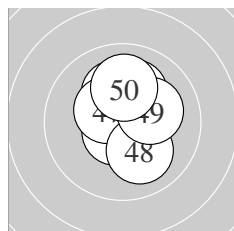

Serie 5:	10.6 *	10.1 ↗	10.3 *	10.2 *	10.4 *
	10.6 *	10.4 *	10.1 ↘	10.2 *	10.0 ↑
beste Teiler	80.8 (46.)	89.6 (41.)	131.0 (47.)		
Trefferlage	0.39 mm rechts, 0.69 mm hoch				
Streuwert	1.16, horizontal: 0.93, vertikal: 1.35				

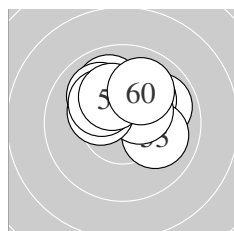

Serie 6:	9.9 →	10.1 ↗	10.0 →	10.0 ↖	10.4 *
	10.0 ↖	10.3 *	10.2 *	10.2 *	10.0 ↗
beste Teiler	141.8 (55.)	165.4 (57.)	188.8 (59.)		
Trefferlage	0.23 mm rechts, 1.27 mm hoch				
Streuwert	1.28, horizontal: 1.58, vertikal: 0.89				

ISSF AR Men – Wertung – Junioren

StandNr: 115

Kelnar, Václav #70804364

StartNr: 112

2. Dezember 2017 15:19

CZE – Dukla Pilsen

QF – Schütze hat sich fürs Finale qualifiziert

Unterschrift des Schützen

Meyton Elektronik

Ergebnis:	556.0	(531)
Serien:	90.9 92.8 95.2 93.5 91.1 92.5	
Zähler:	15 24 19 1 1 0 0 0 0 0	
Innenzehner:	8	
weiteste:	1097 (11), 907 (44), 750 (24)	
beste Teiler	110.0 (45.) 120.3 (25.) 140.0 (28.)	
Trefferlage	0.45 mm rechts, 0.05 mm hoch	
Streuwert	3.33, horizontal: 3.61, vertikal: 3.04	

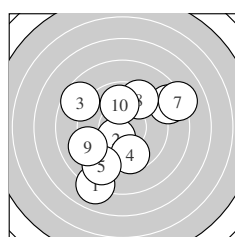
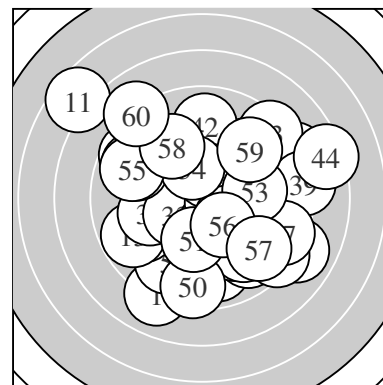

Serie 1:	8.0 ↙	10.4 *	8.7 ↘	9.7 ↓	8.9 ↙
	8.6 ↗	8.1 ↗	9.5 ↑	9.1 ↖	9.9 ↑
beste Teiler	143.2 (2.) 263.4 (10.) 324.8 (4.)				
Trefferlage	0.12 mm links, 0.31 mm tief				
Streuwert	3.72, horizontal: 3.79, vertikal: 3.65				

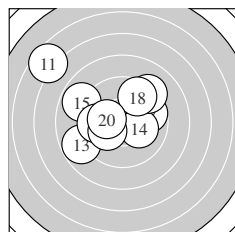

Serie 2:	6.6 ↘	9.7 ↗	8.8 ↖	10.1 ↘	8.8 ↘
	9.7 ←	9.2 ↗	9.6 ↑	10.1 ↖	10.2 *
beste Teiler	186.1 (20.) 202.6 (14.) 202.9 (19.)				
Trefferlage	1.52 mm links, 1.22 mm hoch				
Streuwert	3.34, horizontal: 3.88, vertikal: 2.69				

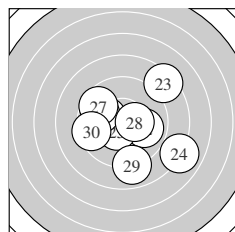

Serie 3:	10.2 *	9.9 ↘	8.3 ↗	8.0 ↘	10.5 *
	9.9 ↖	9.6 ↘	10.4 *	8.9 ↓	9.5 ↖
beste Teiler	120.3 (25.) 140.0 (28.) 194.7 (21.)				
Trefferlage	0.47 mm rechts, 0.33 mm tief				
Streuwert	3.05, horizontal: 3.40, vertikal: 2.66				

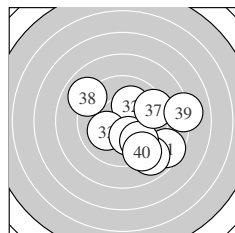

Serie 4:	8.6 ↘	10.1 ↑	10.1 ↖	10.2 *	8.9 ↘
	9.8 ↘	9.4 ↗	9.0 ↘	8.1 →	9.3 ↘
beste Teiler	184.5 (34.) 204.4 (32.) 215.4 (33.)				
Trefferlage	1.87 mm rechts, 0.87 mm tief				
Streuwert	2.86, horizontal: 3.21, vertikal: 2.45				

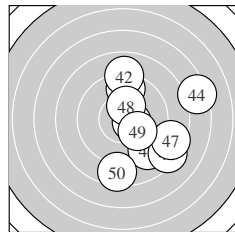

Serie 5:	9.5 ↑	9.0 ↑	9.1 ↘	7.3 →	10.5 *
	8.3 ↘	8.5 ↘	10.3 *	10.1 ↘	8.5 ↓
beste Teiler	110.0 (45.) 159.1 (48.) 221.1 (49.)				
Trefferlage	2.53 mm rechts, 0.48 mm tief				
Streuwert	3.34, horizontal: 3.00, vertikal: 3.64				

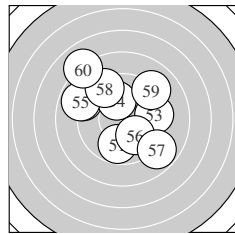

Serie 6:	9.8 ↓	9.0 ↖	9.5 →	10.1 ↑	8.9 ↖
	10.0 ↘	8.8 ↘	9.3 ↘	9.1 ↗	8.0 ↖
beste Teiler	222.6 (54.) 236.6 (56.) 294.9 (51.)				
Trefferlage	0.49 mm links, 1.11 mm hoch				
Streuwert	3.27, horizontal: 3.49, vertikal: 3.03				

Meyton Elektronik

ISSF AR Men – Wertung – Junioren

StandNr: 116

Gopp, Manuel #70817475

StartNr: 113

2. Dezember 2017 14:51

VSB-TZ Altach

Unterschrift des Schützen

Meyton Elektronik

Ergebnis:	599.2	(571)
Serien:	102.1 97.6 98.6 101.2 98.4 101.3	
Zähler:	32 27 1 0 0 0 0 0 0 0	
Innenzehner:	28	
weiteste:	565 (26), 476 (24), 472 (31)	
beste Teiler	49.5 (9.) 52.2 (2.) 56.7 (36.)	
Trefferlage	0.07 mm rechts, 0.46 mm tief	
Streuwert	1.93, horizontal: 2.19, vertikal: 1.63	

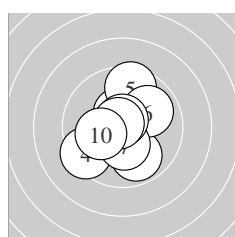
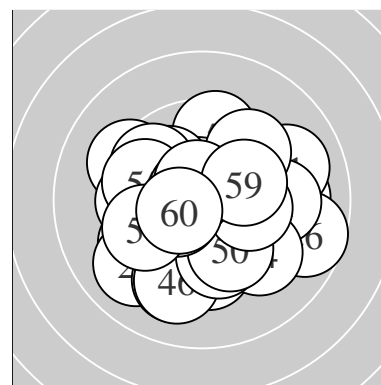

Serie 1:	10.5 *	10.7 *	9.9 ↘	9.4 ↙	9.6 ↑
	9.9 ↗	10.4 *	10.7 *	10.8 *	10.2 *
beste Teiler	49.5 (9.)	52.2 (2.)	63.0 (8.)		
Trefferlage	0.17 mm links, 0.02 mm tief				
Streuwert	1.66, horizontal: 1.50, vertikal: 1.81				

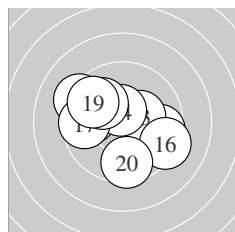

Serie 2:	9.8 ←	9.6 →	10.3 *	10.5 *	9.3 ↖
	9.3 ↘	9.6 ←	10.0 ↘	9.7 ↖	9.5 ↓
beste Teiler	104.3 (14.)	158.7 (13.)	238.4 (18.)		
Trefferlage	0.56 mm links, 0.11 mm hoch				
Streuwert	2.27, horizontal: 2.71, vertikal: 1.73				

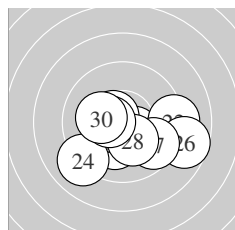

Serie 3:	10.4 *	9.2 →	10.2 *	9.0 ↙	10.6 *
	8.7 →	9.6 ↘	10.2 *	10.5 *	10.2 *
beste Teiler	96.0 (25.)	112.0 (29.)	133.3 (21.)		
Trefferlage	0.65 mm rechts, 1.02 mm tief				
Streuwert	2.18, horizontal: 2.81, vertikal: 1.26				

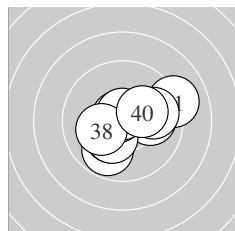

Serie 4:	9.1 →	9.8 ↙	10.3 *	10.0 →	10.3 *
	10.7 *	10.7 *	10.2 *	9.9 →	10.2 *
beste Teiler	56.7 (36.)	61.0 (37.)	169.4 (35.)		
Trefferlage	0.56 mm rechts, 0.17 mm tief				
Streuwert	1.73, horizontal: 2.09, vertikal: 1.29				

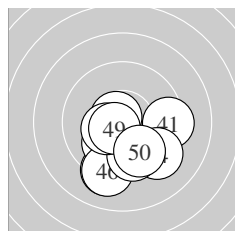

Serie 5:	9.4 →	10.7 *	9.2 ↙	9.3 ↘	10.1 ↙
	9.2 ↙	9.7 ↘	10.4 *	10.6 *	9.8 ↘
beste Teiler	70.2 (42.)	89.8 (49.)	150.0 (48.)		
Trefferlage	0.26 mm rechts, 1.91 mm tief				
Streuwert	1.83, horizontal: 1.98, vertikal: 1.66				

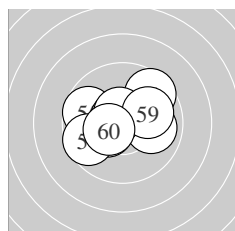

Serie 6:	9.6 ↗	10.3 *	9.9 →	10.5 *	9.7 ↖
	9.6 ↙	10.7 *	10.6 *	10.0 →	10.4 *
beste Teiler	71.0 (57.)	91.0 (58.)	102.4 (54.)		
Trefferlage	0.32 mm links, 0.26 mm hoch				
Streuwert	1.65, horizontal: 2.05, vertikal: 1.12				

Meyton Elektronik

ISSF AR Men – Wertung – **Junioren**

StandNr: 117

Lintner, Stefan #325

StartNr: 114

2. Dezember 2017 15:18

T – SG Hötting

Unterschrift des Schützen

Meyton Elektronik

Ergebnis: **608.2** (584)

Serien: 101.8 100.2 101.1 103.4 100.4 101.3

Zähler: 44 16 0 0 0 0 0 0 0 0

Innenzehner: 30

weiteste: 469 (11), 460 (6), 437 (55)

beste Teiler 74.2 (58.) 78.1 (36.) 78.2 (23.)

Trefferlage 0.07 mm rechts, 0.42 mm hoch

Streuwert 1.61, horizontal: 1.76, vertikal: 1.45

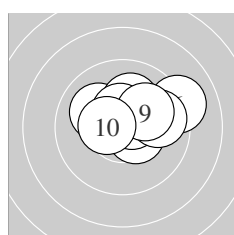
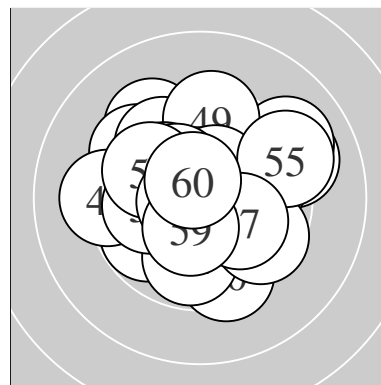

Serie 1:

10.1 ↘	10.5 *	10.5 *	10.1 ↑	10.6 *
9.1 →	9.8 →	10.5 *	10.1 →	10.5 *

beste Teiler 88.8 (5.) 114.6 (3.) 117.3 (8.)

Trefferlage 0.85 mm rechts, 0.88 mm hoch

Streuwert 1.37, horizontal: 1.79, vertikal: 0.76

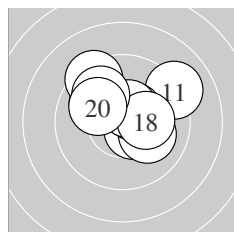

Serie 2:

9.1 →	10.0 ↘	10.5 *	9.4 ↘	10.1 →
10.5 *	10.5 *	10.2 *	9.9 ↘	10.0 ↘

beste Teiler 102.4 (13.) 113.7 (17.) 118.1 (16.)

Trefferlage 0.20 mm rechts, 1.10 mm hoch

Streuwert 1.75, horizontal: 2.09, vertikal: 1.34

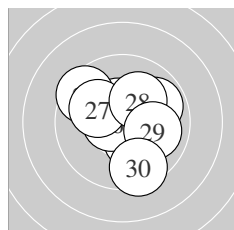

Serie 3:

10.3 *	10.5 *	10.6 *	9.9 →	9.5 ↘
10.6 *	10.1 ↘	10.1 ↑	10.0 →	9.5 ↓

beste Teiler 78.2 (23.) 88.0 (26.) 123.0 (22.)

Trefferlage 0.14 mm rechts, 0.23 mm hoch

Streuwert 1.73, horizontal: 1.77, vertikal: 1.70

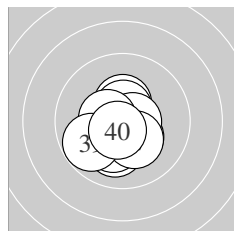

Serie 4:

10.3 *	10.1 ↓	10.4 *	10.6 *	10.2 *
10.6 *	10.3 *	10.5 *	9.8 ↙	10.6 *

beste Teiler 78.1 (36.) 81.4 (40.) 93.1 (34.)

Trefferlage 0.26 mm links, 0.64 mm tief

Streuwert 1.13, horizontal: 1.05, vertikal: 1.20

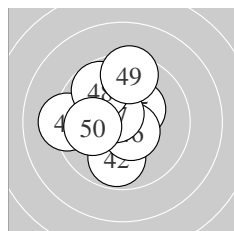

Serie 5:

9.2 ←	9.8 ↓	10.1 ↘	10.5 *	10.4 *
10.6 *	10.6 *	9.7 ↘	9.5 ↑	10.0 ←

beste Teiler 86.3 (47.) 99.1 (46.) 108.3 (44.)

Trefferlage 0.78 mm links, 0.67 mm hoch

Streuwert 1.72, horizontal: 1.64, vertikal: 1.80

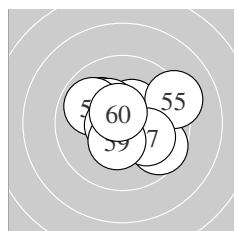

Serie 6:

10.4 *	10.1 ↘	9.6 ↘	10.3 *	9.2 →
9.9 ↘	10.1 ↘	10.7 *	10.4 *	10.6 *

beste Teiler 74.2 (58.) 88.7 (60.) 134.3 (51.)

Trefferlage 0.27 mm rechts, 0.31 mm hoch

Streuwert 1.71, horizontal: 2.03, vertikal: 1.30

ISSF AR Men – Wertung – Junioren

StandNr: 118

Kryzs, Lucas #70817537

StartNr: 115

2. Dezember 2017 15:02

FRA

Unterschrift des Schützen

Meyton Elektronik

Ergebnis:	582.8	(554)
Serien:	96.2 98.9 94.1 96.2 100.6 96.8	
Zähler:	23 28 9 0 0 0 0 0 0	
Innenzehner:	19	
weiteste:	727 (8), 658 (4), 641 (29)	
beste Teiler	70.7 (48.) 81.2 (41.) 88.6 (11.)	
Trefferlage	0.71 mm links, 0.35 mm hoch	
Streuwert	2.44, horizontal: 2.90, vertikal: 1.87	

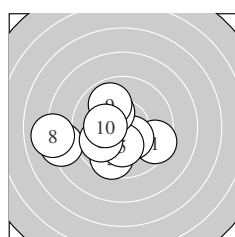
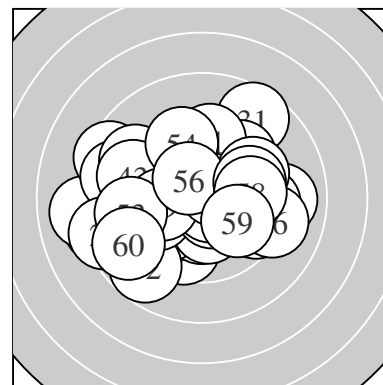

Serie 1:	9.5 ↘	10.4 *	9.6 ↓	8.3 ←	10.2 *
	9.9 ↙	10.2 *	8.0 ←	9.9 ↗	10.2 *
beste Teiler	145.9 (2.)	178.4 (10.)	181.9 (7.)		
Trefferlage	1.67 mm links, 0.76 mm tief				
Streuwert	2.51, horizontal: 3.14, vertikal: 1.65				

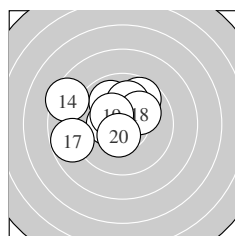

Serie 2:	10.6 *	9.7 ↗	9.9 ↘	8.5 ↖	10.0 ↑
	10.4 *	8.8 ←	10.1 ↗	10.4 *	10.5 *
beste Teiler	88.6 (11.)	121.7 (20.)	147.5 (19.)		
Trefferlage	1.20 mm links, 0.86 mm hoch				
Streuwert	2.10, horizontal: 2.52, vertikal: 1.57				

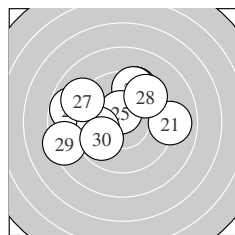

Serie 3:	9.0 →	9.5 ↑	9.5 ↑	8.8 ↖	10.5 *
	9.9 ←	9.1 ↖	9.5 ↗	8.4 ←	9.9 ↙
beste Teiler	102.6 (25.)	265.8 (26.)	275.6 (30.)		
Trefferlage	1.07 mm links, 0.96 mm hoch				
Streuwert	2.91, horizontal: 3.56, vertikal: 2.06				

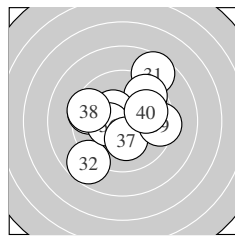

Serie 4:	8.6 ↗	8.7 ↙	9.6 ↗	9.5 ↖	10.4 *
	10.4 *	10.2 *	9.5 ↖	9.4 →	9.9 →
beste Teiler	137.8 (35.)	150.1 (36.)	186.7 (37.)		
Trefferlage	0.07 mm links, 0.46 mm hoch				
Streuwert	2.69, horizontal: 2.90, vertikal: 2.45				

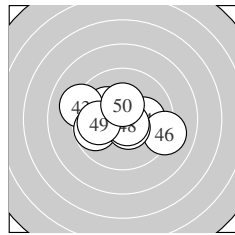

Serie 5:	10.6 *	10.2 *	9.2 ↖	10.1 →	9.8 ←
	9.1 ↘	10.5 *	10.7 *	10.0 ←	10.4 *
beste Teiler	70.7 (48.)	81.2 (41.)	106.5 (47.)		
Trefferlage	0.43 mm links, 0.02 mm tief				
Streuwert	1.93, horizontal: 2.53, vertikal: 1.03				

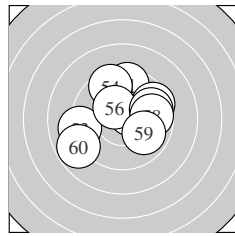

Serie 6:	9.5 ↑	10.6 *	9.1 ←	9.5 ↗	9.6 →
	10.4 *	9.7 →	9.7 →	9.9 ↘	8.8 ←
beste Teiler	94.1 (52.)	146.1 (56.)	261.5 (59.)		
Trefferlage	0.15 mm rechts, 0.63 mm hoch				
Streuwert	2.50, horizontal: 2.90, vertikal: 2.01				

ISSF AR Men – Wertung – Junioren

StandNr: 127

Eder, Fabian #70817156

StartNr: 116

2. Dezember 2017 14:56

TLSB

Unterschrift des Schützen

Meyton Elektronik

Ergebnis:	617.0	(590) ^{QF}
Serien:	102.2	100.2 104.4 103.6 104.3 102.3
Zähler:	50	10 0 0 0 0 0 0 0 0
Innenzehner:	45	
weiteste:	423	(6), 394 (11), 378 (58)
beste Teiler	36.6	(43.) 38.2 (34.) 42.1 (30.)
Trefferlage	0.05 mm	rechts, 0.04 mm tief
Streuwert	1.34,	horizontal: 1.47, vertikal: 1.21

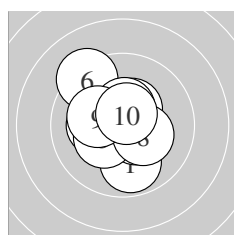
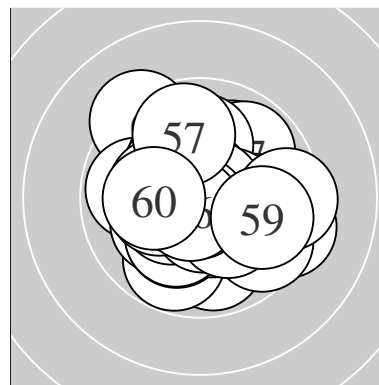

Serie 1:	9.9 ↓	10.2 *	10.4 *	10.5 *	10.3 *
	9.3 ↘	10.5 *	10.3 *	10.2 *	10.6 *
beste Teiler	88.5 (10.) 117.5 (4.) 123.6 (7.)				
Trefferlage	0.34 mm links, 0.23 mm hoch				
Streuwert	1.52, horizontal: 1.42, vertikal: 1.62				

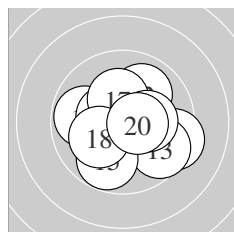

Serie 2:	9.4 →	10.0 ↗	9.6 ↘	9.8 ←	9.8 ↓
	10.5 *	10.3 *	10.1 ↙	10.2 *	10.5 *
beste Teiler	109.4 (20.) 123.3 (16.) 170.2 (17.)				
Trefferlage	0.36 mm rechts, 0.24 mm tief				
Streuwert	1.82, horizontal: 2.10, vertikal: 1.49				

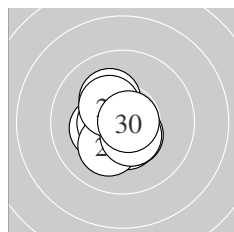

Serie 3:	10.2 *	10.6 *	10.3 *	10.5 *	10.4 *
	10.2 *	10.5 *	10.5 *	10.4 *	10.8 *
beste Teiler	42.1 (30.) 88.8 (22.) 109.1 (24.)				
Trefferlage	0.30 mm links, 0.31 mm tief				
Streuwert	0.98, horizontal: 0.90, vertikal: 1.05				

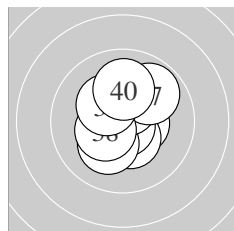

Serie 4:	10.6 *	10.5 *	10.4 *	10.8 *	10.2 *
	10.5 *	9.9 ↗	10.4 *	10.3 *	10.0 ↑
beste Teiler	38.2 (34.) 93.1 (31.) 119.2 (32.)				
Trefferlage	0.01 mm links, 0.23 mm hoch				
Streuwert	1.22, horizontal: 1.07, vertikal: 1.35				

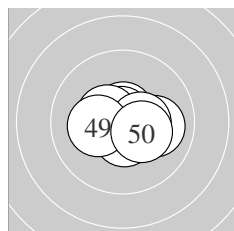

Serie 5:	10.7 *	10.0 →	10.8 *	10.4 *	10.5 *
	10.5 *	10.5 *	10.4 *	10.2 *	10.3 *
beste Teiler	36.6 (43.) 68.1 (41.) 102.9 (47.)				
Trefferlage	0.43 mm rechts, 0.17 mm tief				
Streuwert	0.96, horizontal: 1.25, vertikal: 0.54				

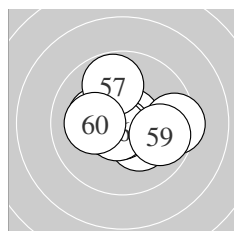

Serie 6:	10.5 *	10.7 *	10.3 *	10.8 *	10.2 *
	10.7 *	9.8 ↑	9.4 →	9.8 →	10.1 ←
beste Teiler	44.6 (54.) 56.9 (52.) 65.4 (56.)				
Trefferlage	0.20 mm rechts, 0.01 mm hoch				
Streuwert	1.54, horizontal: 1.89, vertikal: 1.09				

ISSF AR Men – Wertung – Junioren

StandNr: 120

Hammerl, Soma #70817538

StartNr: 117

2. Dezember 2017 14:44

HUN

QF – Schütze hat sich fürs Finale qualifiziert

Unterschrift des Schützen

Meyton Elektronik

Ergebnis: **613.7** (587)
 Serien: 100.7 101.4 104.8 102.8 103.5 100.5
 Zähler: 48 11 1 0 0 0 0 0 0
 Innenzehner: 37
 weiteste: 504 (57), 446 (31), 397 (4)
 beste Teiler 10.8 (37.) 37.3 (27.) 41.9 (53.)
 Trefferlage 0.04 mm links, 0.36 mm tief
 Streuwert 1.48, horizontal: 1.62, vertikal: 1.32

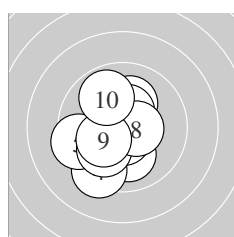
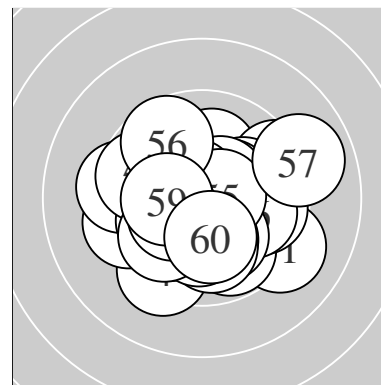

Serie 1:
 10.1 ↑ 10.1 ↓ 10.4 * 9.4 ↙ 9.5 ←
 10.6 * 10.0 ↘ 10.5 * 10.2 * 9.9 ↘
 beste Teiler 86.2 (6.) 110.6 (8.) 128.1 (3.)
 Trefferlage 0.71 mm links, 0.50 mm tief
 Streuwert 1.68, horizontal: 1.47, vertikal: 1.87

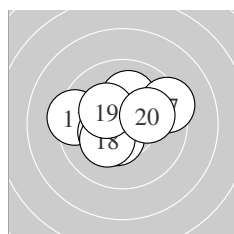

Serie 2:
 9.4 ← 10.6 * 10.1 ↑ 10.5 * 10.4 *
 10.3 * 9.4 → 10.3 * 10.3 * 10.1 →
 beste Teiler 89.9 (12.) 121.4 (14.) 134.2 (15.)
 Trefferlage 0.41 mm links, 0.33 mm hoch
 Streuwert 1.66, horizontal: 2.05, vertikal: 1.13

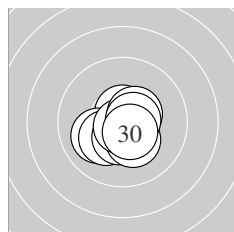

Serie 3:
 10.6 * 10.1 ↘ 10.6 * 10.2 * 10.5 *
 10.3 * 10.8 * 10.5 * 10.6 * 10.6 *
 beste Teiler 37.3 (27.) 76.0 (21.) 78.4 (23.)
 Trefferlage 0.01 mm rechts, 0.51 mm tief
 Streuwert 0.90, horizontal: 0.98, vertikal: 0.80

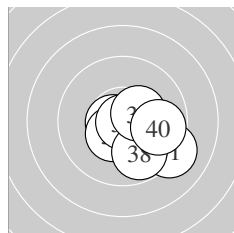

Serie 4:
 9.2 ↘ 10.6 * 10.6 * 10.5 * 10.6 *
 10.4 * 10.9 * 9.8 ↓ 10.4 * 9.8 →
 beste Teiler 10.8 (37.) 78.7 (33.) 79.4 (35.)
 Trefferlage 0.92 mm rechts, 0.77 mm tief
 Streuwert 1.27, horizontal: 1.48, vertikal: 1.01

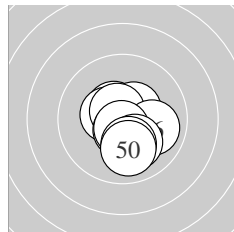

Serie 5:
 10.5 * 10.5 * 10.4 * 10.6 * 10.6 *
 10.0 → 10.7 * 10.1 ↓ 10.1 ↓ 10.0 ↓
 beste Teiler 75.5 (47.) 78.4 (44.) 90.4 (45.)
 Trefferlage 0.26 mm rechts, 0.60 mm tief
 Streuwert 1.12, horizontal: 1.02, vertikal: 1.21

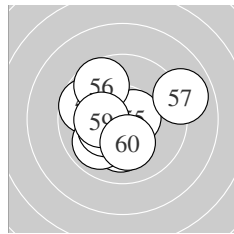

Serie 6:
 10.1 ↓ 9.7 ← 10.8 * 9.9 ↙ 10.6 *
 9.7 ↘ 8.9 → 10.3 * 10.3 * 10.2 *
 beste Teiler 41.9 (53.) 87.9 (55.) 160.8 (58.)
 Trefferlage 0.33 mm links, 0.10 mm tief
 Streuwert 1.91, horizontal: 2.16, vertikal: 1.62

Meyton Elektronik

ISSF AR Men – Wertung – Junioren

StandNr: 121

Pauzies, Bastien #70817539

StartNr: 118

2. Dezember 2017 15:07

FRA

Unterschrift des Schützen

Meyton Elektronik

Ergebnis: **605.5** (578)
 Serien: 94.8 101.1 101.7 100.9 102.9 104.1
 Zähler: 40 18 2 0 0 0 0 0 0
 Innenzehner: 31
 weiteste: 554 (6), 530 (39), 496 (10)
 beste Teiler 24.6 (52.) 32.2 (45.) 34.7 (42.)
 Trefferlage 0.29 mm links, 0.10 mm tief
 Streuwert 1.74, horizontal: 1.96, vertikal: 1.49

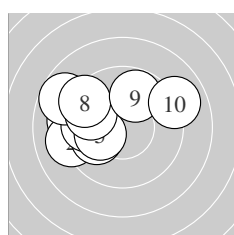
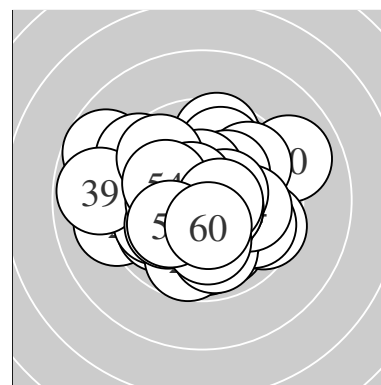

Serie 1:
 9.2 ← 9.1 ← 10.0 ← 9.7 ← 10.1 ←
 8.7 ↖ 9.8 ↖ 9.4 ↖ 9.8 ↑ 9.0 →
 beste Teiler 202.1 (5.) 243.5 (3.) 290.0 (9.)
 Trefferlage 2.13 mm links, 0.85 mm hoch
 Streuwert 2.29, horizontal: 2.88, vertikal: 1.48

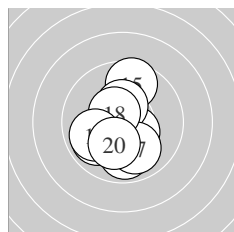

Serie 2:
 9.9 ↙ 10.4 * 10.3 * 9.9 ↓ 9.6 ↑
 10.4 * 10.0 ↓ 10.5 * 9.9 ← 10.2 *
 beste Teiler 106.2 (18.) 128.9 (12.) 142.1 (16.)
 Trefferlage 0.42 mm links, 0.59 mm tief
 Streuwert 1.58, horizontal: 1.23, vertikal: 1.86

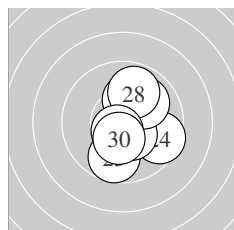

Serie 3:
 10.2 * 10.7 * 9.7 ↓ 9.6 ↘ 10.4 *
 10.2 * 10.0 ↗ 9.9 ↑ 10.6 * 10.4 *
 beste Teiler 58.0 (22.) 90.2 (29.) 129.2 (25.)
 Trefferlage 0.79 mm rechts, 0.20 mm tief
 Streuwert 1.50, horizontal: 1.21, vertikal: 1.74

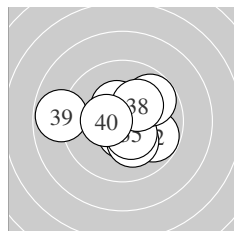

Serie 4:
 10.4 * 9.8 ↘ 10.5 * 10.2 * 10.4 *
 9.8 ↗ 10.4 * 10.2 * 8.8 ← 10.4 *
 beste Teiler 102.1 (33.) 128.7 (35.) 135.0 (37.)
 Trefferlage 0.21 mm rechts, 0.01 mm hoch
 Streuwert 1.84, horizontal: 2.29, vertikal: 1.24

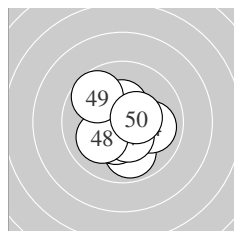

Serie 5:
 9.9 ↓ 10.8 * 10.3 * 10.0 → 10.8 *
 10.4 * 10.4 * 10.1 ↙ 9.7 ↘ 10.5 *
 beste Teiler 32.2 (45.) 34.7 (42.) 123.9 (50.)
 Trefferlage 0.01 mm rechts, 0.30 mm tief
 Streuwert 1.38, horizontal: 1.34, vertikal: 1.41

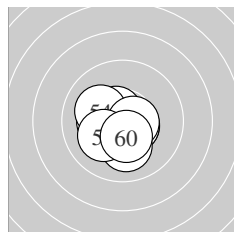

Serie 6:
 10.3 * 10.9 * 10.6 * 10.1 ↖ 10.5 *
 10.5 * 10.1 ↓ 10.6 * 10.1 ← 10.4 *
 beste Teiler 24.6 (52.) 91.6 (58.) 94.2 (53.)
 Trefferlage 0.26 mm links, 0.40 mm tief
 Streuwert 1.04, horizontal: 1.14, vertikal: 0.94

Meyton Elektronik

ISSF AR Men – Wertung – Junioren

StandNr: 122

Zogg, Lukas #70804107

StartNr: 119

2. Dezember 2017 15:16

VSBL NWLZ

Unterschrift des Schützen

Meyton Elektronik

Ergebnis: **606.4** (582)
 Serien: 100.3 101.4 102.9 102.4 100.7 98.7
 Zähler: 42 18 0 0 0 0 0 0 0
 Innenzehner: 32
 weiteste: 484 (53), 392 (57), 388 (47)
 beste Teiler 47.4 (27.) 64.6 (18.) 72.4 (37.)
 Trefferlage 0.01 mm links, 0.82 mm hoch
 Streuwert 1.55, horizontal: 1.65, vertikal: 1.43

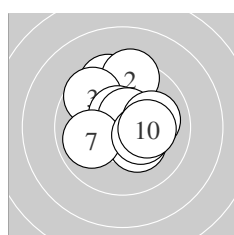
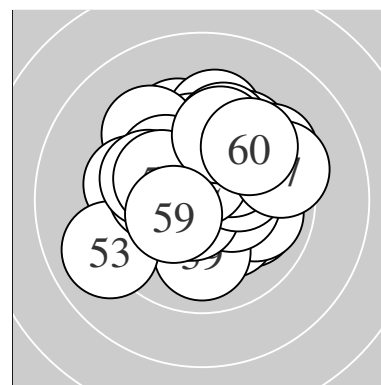

Serie 1:
 9.5 ↕ 9.4 ↑ 9.6 ↘ 10.3 * 10.5 *
 10.6 * 9.9 ← 10.0 → 10.3 * 10.2 *
 beste Teiler 86.0 (6.) 102.6 (5.) 153.1 (9.)
 Trefferlage 0.13 mm rechts, 0.89 mm hoch
 Streuwert 1.71, horizontal: 1.65, vertikal: 1.77

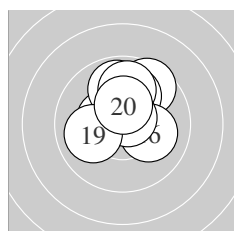

Serie 2:
 10.4 * 9.6 ↗ 10.4 * 10.0 ↑ 9.9 ↑
 10.1 → 9.9 ↑ 10.7 * 10.0 ← 10.4 *
 beste Teiler 64.6 (18.) 135.4 (11.) 147.1 (20.)
 Trefferlage 0.14 mm rechts, 1.27 mm hoch
 Streuwert 1.33, horizontal: 1.30, vertikal: 1.35

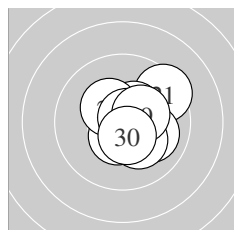

Serie 3:
 9.4 ↗ 10.4 * 10.0 → 10.5 * 10.5 *
 10.3 * 10.8 * 10.2 * 10.3 * 10.5 *
 beste Teiler 47.4 (27.) 108.7 (30.) 113.2 (24.)
 Trefferlage 0.90 mm rechts, 0.16 mm hoch
 Streuwert 1.19, horizontal: 1.20, vertikal: 1.19

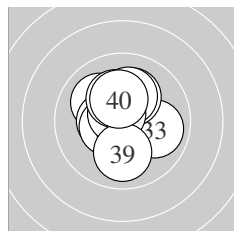

Serie 4:
 10.0 ↘ 10.4 * 9.9 → 10.5 * 10.2 *
 10.2 * 10.7 * 10.2 * 10.0 ↓ 10.3 *
 beste Teiler 72.4 (37.) 119.0 (34.) 132.0 (32.)
 Trefferlage 0.19 mm links, 0.57 mm hoch
 Streuwert 1.32, horizontal: 1.21, vertikal: 1.43

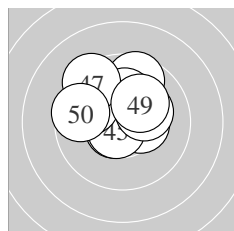

Serie 5:
 9.6 ↑ 10.4 * 10.2 * 10.6 * 10.7 *
 9.8 ↘ 9.4 ↘ 10.2 * 10.2 * 9.6 ←
 beste Teiler 75.1 (45.) 85.1 (44.) 138.9 (42.)
 Trefferlage 0.37 mm links, 1.11 mm hoch
 Streuwert 1.60, horizontal: 1.81, vertikal: 1.35

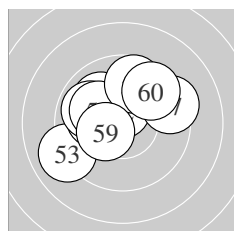

Serie 6:
 10.0 ↘ 10.5 * 9.0 ← 10.1 ← 9.9 ↘
 10.1 ↘ 9.4 → 9.7 ↑ 10.4 * 9.6 ↗
 beste Teiler 105.3 (52.) 148.0 (59.) 211.5 (56.)
 Trefferlage 0.71 mm links, 0.89 mm hoch
 Streuwert 2.00, horizontal: 2.37, vertikal: 1.53

Meyton Elektronik

ISSF AR Men – Wertung – Junioren

StandNr: 123

Mompach, Nicolas #70817540

StartNr: 120

2. Dezember 2017 15:19

FRA

Unterschrift des Schützen

Meyton Elektronik

Ergebnis:	613.5	(588)
Serien:	103.5	103.9 103.0 102.3 99.4 101.4
Zähler:	48	12 0 0 0 0 0 0 0 0
Innenzehner:	42	
weiteste:	409 (57), 376 (55), 369 (31)	
beste Teiler	35.5 (2.)	44.4 (3.) 58.6 (26.)
Trefferlage	0.30 mm rechts, 0.11 mm hoch	
Streuwert	1.41, horizontal: 1.51, vertikal: 1.30	

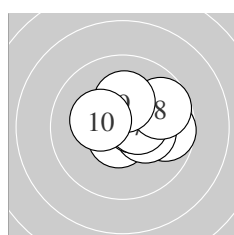
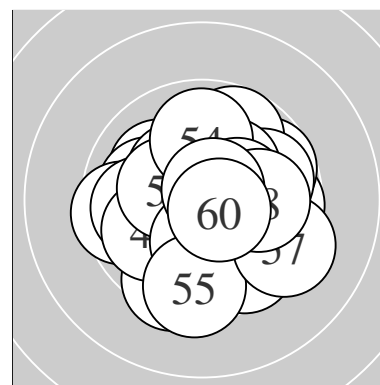

Serie 1:	9.7 →	10.8 *	10.8 *	10.6 *	10.3 *
	10.6 *	10.5 *	9.7 ↗	10.2 *	10.3 *
beste Teiler	35.5 (2.) 44.4 (3.) 76.6 (4.)				
Trefferlage	0.76 mm rechts, 0.29 mm hoch				
Streuwert	1.17, horizontal: 1.45, vertikal: 0.80				

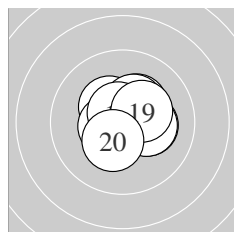

Serie 2:	10.3 *	10.4 *	10.5 *	10.2 *	10.4 *
	10.5 *	10.3 *	10.7 *	10.3 *	10.3 *
beste Teiler	75.5 (18.) 105.3 (16.) 112.9 (13.)				
Trefferlage	0.45 mm rechts, 0.37 mm hoch				
Streuwert	0.99, horizontal: 1.11, vertikal: 0.86				

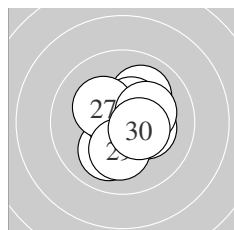

Serie 3:	10.1 ↘	10.0 ↗	10.4 *	10.3 *	10.5 *
	10.7 *	10.2 *	10.2 *	10.2 *	10.4 *
beste Teiler	58.6 (26.) 121.5 (25.) 129.2 (30.)				
Trefferlage	0.46 mm rechts, 0.07 mm hoch				
Streuwert	1.23, horizontal: 1.15, vertikal: 1.30				

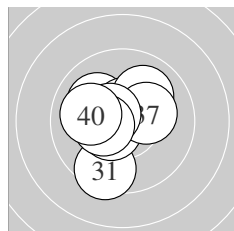

Serie 4:	9.5 ↘	10.5 *	10.5 *	10.1 ↖	10.6 *
	10.0 ↗	10.2 *	10.5 *	10.4 *	10.0 ←
beste Teiler	92.9 (35.) 104.4 (33.) 104.7 (38.)				
Trefferlage	0.64 mm links, 0.13 mm hoch				
Streuwert	1.40, horizontal: 1.34, vertikal: 1.45				

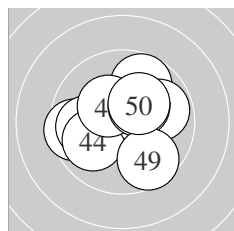

Serie 5:	9.7 ↗	9.5 ←	9.9 ←	9.9 ↙	10.2 *
	10.3 *	9.8 →	10.3 *	9.6 ↘	10.2 *
beste Teiler	156.4 (46.) 166.1 (48.) 179.2 (50.)				
Trefferlage	0.07 mm rechts, 0.25 mm hoch				
Streuwert	1.89, horizontal: 2.18, vertikal: 1.54				

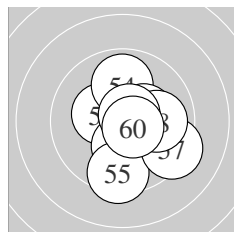

Serie 6:	10.7 *	10.3 *	10.2 *	9.9 ↑	9.4 ↓
	10.3 *	9.3 ↘	10.0 →	10.7 *	10.6 *
beste Teiler	65.7 (59.) 71.4 (51.) 86.9 (60.)				
Trefferlage	0.71 mm rechts, 0.46 mm tief				
Streuwert	1.61, horizontal: 1.46, vertikal: 1.74				

Meyton Elektronik

ISSF AR Men – Wertung – Junioren

StandNr: 124

Thum, Andreas #86

StartNr: 121

2. Dezember 2017 15:18

AUT

Unterschrift des Schützen

Meyton Elektronik

Ergebnis:	616.8	(591) ^{QF}						
Serien:	102.5	104.1	102.4	101.9	103.2	102.7		
Zähler:	51	9	0	0	0	0	0	0
Innenzehner:	43							
weiteste:	374 (52), 320 (9), 296 (47)							
beste Teiler	32.9 (13.)	53.0 (58.)	66.0 (44.)					
Trefferlage	0.31 mm rechts, 0.07 mm hoch							
Streuwert	1.29, horizontal: 1.48, vertikal: 1.07							

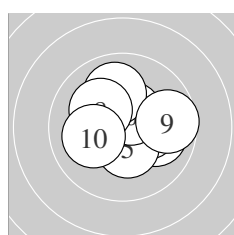
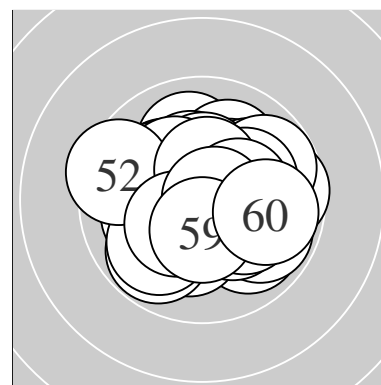

Serie 1:	10.0 →	10.3 *	10.6 *	10.7 *	10.4 *
	10.5 *	10.0 ↑	10.2 *	9.7 →	10.1 ←
beste Teiler	66.8 (4.)	89.8 (3.)	113.5 (6.)		
Trefferlage	0.43 mm rechts, 0.28 mm hoch				
Streuwert	1.40, horizontal: 1.67, vertikal: 1.06				

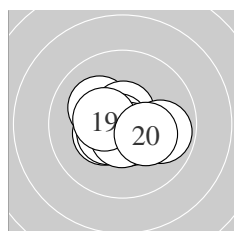

Serie 2:	10.1 ↖	10.6 *	10.8 *	10.6 *	9.9 →
	10.4 *	10.5 *	10.6 *	10.4 *	10.2 *
beste Teiler	32.9 (13.)	81.1 (12.)	84.2 (18.)		
Trefferlage	0.07 mm links, 0.18 mm tief				
Streuwert	1.10, horizontal: 1.39, vertikal: 0.72				

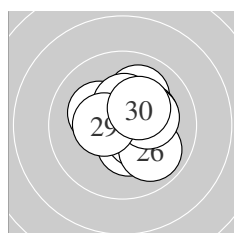

Serie 3:	10.4 *	10.2 *	10.0 ↗	10.4 *	10.4 *
	9.9 ↘	10.2 *	10.2 *	10.4 *	10.3 *
beste Teiler	128.8 (25.)	131.0 (29.)	142.4 (24.)		
Trefferlage	0.62 mm rechts, 0.29 mm hoch				
Streuwert	1.25, horizontal: 1.26, vertikal: 1.24				

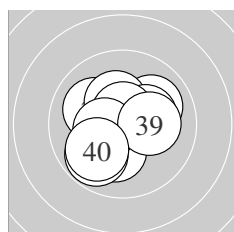

Serie 4:	10.2 *	9.8 ↙	10.1 ↖	10.0 ↗	10.3 *
	10.3 *	10.7 *	10.4 *	10.2 *	9.9 ↘
beste Teiler	75.0 (37.)	133.8 (38.)	161.3 (35.)		
Trefferlage	0.24 mm links, 0.10 mm tief				
Streuwert	1.49, horizontal: 1.59, vertikal: 1.39				

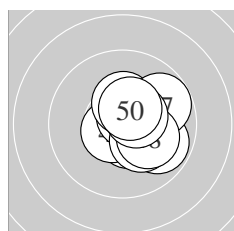

Serie 5:	10.5 *	9.8 ↘	10.6 *	10.7 *	10.3 *
	10.4 *	9.8 ↗	10.1 ↘	10.5 *	10.5 *
beste Teiler	66.0 (44.)	87.0 (43.)	101.0 (41.)		
Trefferlage	0.98 mm rechts, 0.02 mm hoch				
Streuwert	1.08, horizontal: 1.07, vertikal: 1.09				

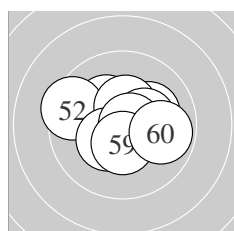

Serie 6:	10.3 *	9.5 ↖	10.2 *	10.6 *	10.4 *
	10.3 *	10.4 *	10.7 *	10.4 *	9.9 →
beste Teiler	53.0 (58.)	76.0 (54.)	128.0 (59.)		
Trefferlage	0.14 mm rechts, 0.15 mm hoch				
Streuwert	1.44, horizontal: 1.78, vertikal: 0.98				

Meyton Elektronik

ISSF AR Men – Wertung – Junioren

StandNr: 125

Dutendas, Dimitri #70817541

StartNr: 122

2. Dezember 2017 15:15

FRA

QF – Schütze hat sich fürs Finale qualifiziert

Unterschrift des Schützen

Meyton Elektronik

Ergebnis:	578.7	(555)
Serien:	95.9 96.2 93.4 98.8 97.9 96.5	
Zähler:	27 22 10 1 0 0 0 0 0 0	
Innenzehner:	19	
weiteste:	779 (11), 734 (26), 725 (5)	
beste Teiler	25.9 (8.) 27.4 (55.) 59.5 (18.)	
Trefferlage	0.07 mm links, 1.29 mm hoch	
Streuwert	2.52, horizontal: 2.73, vertikal: 2.29	

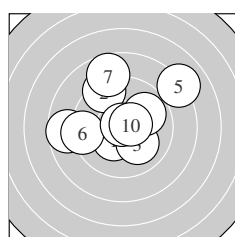
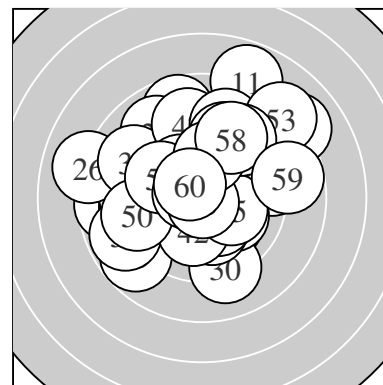

Serie 1:	10.3 *	9.3 ↘	10.1 ↘	8.7 ←	8.1 ↗
	9.3 ←	8.7 ↗	10.9 *	9.9 ↗	10.6 *
beste Teiler	25.9 (8.)	89.8 (10.)	154.6 (1.)		
Trefferlage	0.38 mm links, 1.15 mm hoch				
Streuwert	2.92, horizontal: 3.30, vertikal: 2.49				

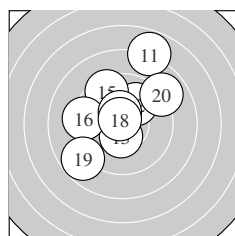

Serie 2:	7.8 ↗	10.0 ↗	10.4 *	10.5 *	9.4 ↘
	9.3 ←	10.4 *	10.7 *	8.8 ↙	8.9 ↗
beste Teiler	59.5 (18.)	103.8 (14.)	127.1 (13.)		
Trefferlage	0.28 mm links, 1.42 mm hoch				
Streuwert	2.76, horizontal: 2.61, vertikal: 2.90				

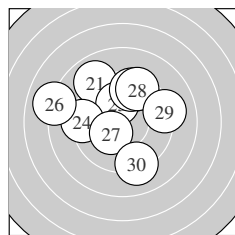

Serie 3:	8.9 ↘	9.5 ↗	10.2 *	9.3 ←	9.6 ↗
	8.0 ←	10.3 *	9.4 ↗	9.1 →	9.1 ↘
beste Teiler	164.1 (27.)	199.4 (23.)	348.3 (25.)		
Trefferlage	0.62 mm links, 1.39 mm hoch				
Streuwert	2.99, horizontal: 3.33, vertikal: 2.60				

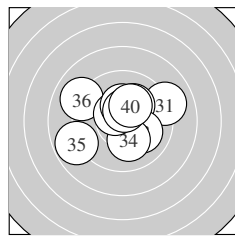

Serie 4:	9.1 →	10.2 *	10.1 ↘	10.1 ↘	8.8 ←
	9.0 ↘	10.5 *	10.3 *	10.5 *	10.2 *
beste Teiler	108.2 (37.)	109.4 (39.)	162.1 (38.)		
Trefferlage	0.08 mm links, 0.54 mm hoch				
Streuwert	2.26, horizontal: 2.72, vertikal: 1.68				

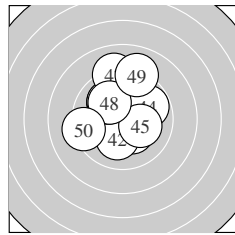

Serie 5:	10.3 *	10.1 ↘	10.0 ↘	9.8 ↗	10.2 *
	10.0 ↘	9.1 ↗	10.1 ↘	9.0 ↗	9.3 ←
beste Teiler	170.4 (41.)	197.2 (45.)	207.4 (42.)		
Trefferlage	0.29 mm links, 1.05 mm hoch				
Streuwert	2.18, horizontal: 2.00, vertikal: 2.34				

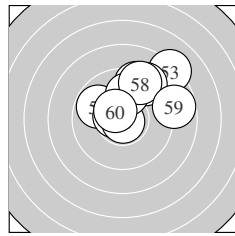

Serie 6:	9.4 ↗	9.8 ↘	8.2 ↗	10.6 *	10.8 *
	9.2 ↗	9.9 ↗	9.3 ↗	8.8 →	10.5 *
beste Teiler	27.4 (55.)	89.4 (54.)	113.2 (60.)		
Trefferlage	1.21 mm rechts, 2.20 mm hoch				
Streuwert	2.17, horizontal: 2.51, vertikal: 1.76				

Meyton Elektronik

ISSF AR Men – Wertung – Junioren

StandNr: 126

Hinteregger, Vinzenz #127

StartNr: 123

2. Dezember 2017 15:03

VSBL NWLZ

Unterschrift des Schützen

Meyton Elektronik

Ergebnis:	604.0	(575)							
Serien:	99.7	98.7	101.7	103.3	99.5	101.1			
Zähler:	36	23	1	0	0	0	0	0	0
Innenzehner:	26								
weiteste:	522 (9), 467 (19), 423 (16)								
beste Teiler	18.4 (21.)	54.6 (37.)	55.9 (28.)						
Trefferlage	0.57 mm rechts,	0.75 mm hoch							
Streuwert	1.63, horizontal: 1.83, vertikal: 1.41								

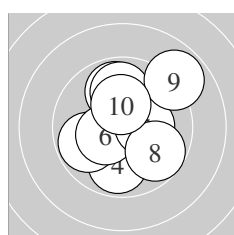
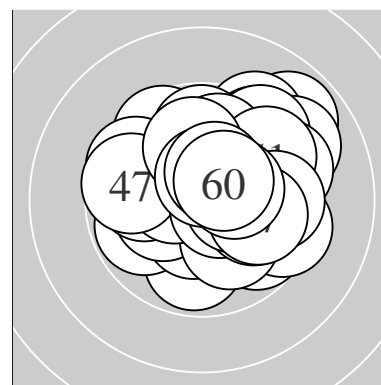

Serie 1:	9.9 ↑	10.6 *	9.9 ↑	9.9 ↓	9.8 ←
	10.4 *	10.3 *	9.7 ↘	8.9 ↗	10.3 *
beste Teiler	91.2 (2.)	139.2 (6.)	165.1 (7.)		
Trefferlage	0.32 mm rechts,	0.52 mm hoch			
Streuwert	1.98, horizontal: 1.87, vertikal: 2.09				

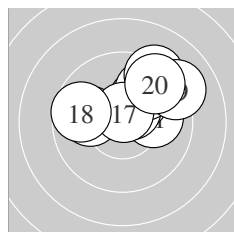

Serie 2:	10.0 →	10.0 ←	10.1 ↗	10.5 *	9.8 ↗
	9.3 ↗	10.7 *	9.7 ←	9.1 ↗	9.5 ↗
beste Teiler	73.4 (17.)	112.3 (14.)	207.0 (13.)		
Trefferlage	0.91 mm rechts,	1.60 mm hoch			
Streuwert	1.76, horizontal: 2.22, vertikal: 1.13				

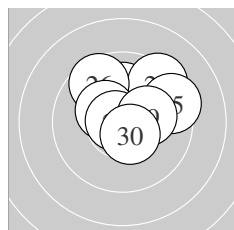

Serie 3:	10.9 *	10.1 ↑	9.4 ↗	10.6 *	9.4 →
	9.6 ↘	10.3 *	10.7 *	10.2 *	10.5 *
beste Teiler	18.4 (21.)	55.9 (28.)	91.2 (24.)		
Trefferlage	0.54 mm rechts,	0.93 mm hoch			
Streuwert	1.55, horizontal: 1.71, vertikal: 1.39				

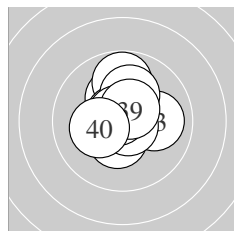

Serie 4:	10.4 *	10.2 *	10.0 →	9.8 ↑	10.7 *
	10.1 ↑	10.7 *	10.7 *	10.5 *	10.2 *
beste Teiler	54.6 (37.)	55.9 (38.)	66.6 (35.)		
Trefferlage	0.02 mm rechts,	0.62 mm hoch			
Streuwert	1.17, horizontal: 1.07, vertikal: 1.27				

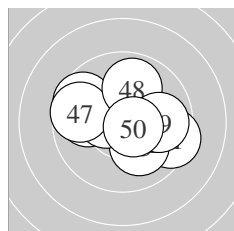

Serie 5:	9.4 ↘	9.9 ←	10.1 ↘	10.4 *	10.0 →
	9.6 ↘	9.7 ←	9.9 ↑	9.9 →	10.6 *
beste Teiler	87.7 (50.)	126.3 (44.)	216.6 (43.)		
Trefferlage	0.14 mm rechts,	0.20 mm hoch			
Streuwert	1.96, horizontal: 2.48, vertikal: 1.23				

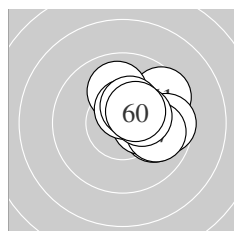

Serie 6:	9.6 ↗	10.0 →	10.0 ↑	10.4 *	9.6 →
	10.5 *	9.9 →	10.3 *	10.4 *	10.4 *
beste Teiler	103.8 (56.)	129.6 (60.)	137.8 (59.)		
Trefferlage	1.51 mm rechts,	0.64 mm hoch			
Streuwert	1.14, horizontal: 1.22, vertikal: 1.04				

Meyton Elektronik

ISSF AR Men – Wertung – Junioren

StandNr: 128

Löschl, Michael #70817155

StartNr: 125

2. Dezember 2017 15:14

NÖ

Unterschrift des Schützen

Meyton Elektronik

Ergebnis:	572.9	(549)
Serien:	92.8 94.0 95.3 95.6 96.6 98.6	
Zähler:	23 25 10 2 0 0 0 0 0 0	
Innenzehner:	15	
weiteste:	905 (13), 897 (3), 699 (40)	
beste Teiler	43.0 (17.) 68.3 (46.) 92.3 (55.)	
Trefferlage	1.10 mm links, 1.76 mm hoch	
Streuwert	2.46, horizontal: 3.00, vertikal: 1.77	

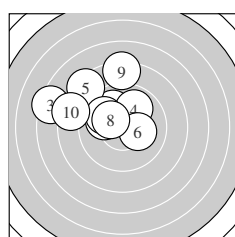
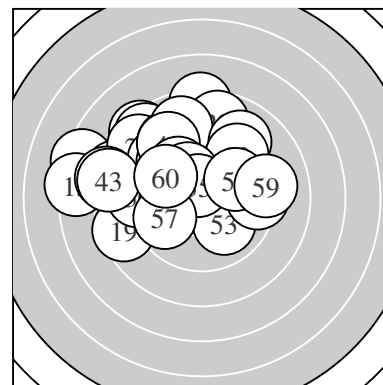

Serie 1:	10.0 ↘	10.0 ←	7.4 ←	9.9 ↗	8.4 ↘
	10.2 *	9.9 ↘	10.3 *	8.3 ↑	8.4 ←
beste Teiler	166.2 (8.)	188.6 (6.)	230.2 (2.)		
Trefferlage	2.30 mm links, 2.28 mm hoch				
Streuwert	2.74, horizontal: 3.27, vertikal: 2.08				

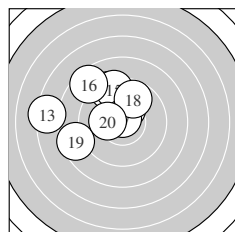

Serie 2:	10.3 *	10.1 ↑	7.3 ←	9.3 ↘	9.3 ↑
	8.5 ↘	10.8 *	9.7 ↑	8.5 ←	10.2 *
beste Teiler	43.0 (17.)	157.8 (11.)	179.4 (20.)		
Trefferlage	2.14 mm links, 1.79 mm hoch				
Streuwert	2.70, horizontal: 3.19, vertikal: 2.08				

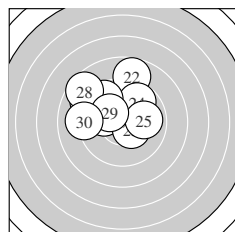

Serie 3:	10.0 ←	8.7 ↑	10.4 *	9.8 ↗	9.9 →
	9.1 ↘	9.5 ↘	8.6 ↘	10.2 *	9.1 ←
beste Teiler	136.1 (23.)	189.8 (29.)	227.5 (21.)		
Trefferlage	1.26 mm links, 1.78 mm hoch				
Streuwert	2.33, horizontal: 2.69, vertikal: 1.91				

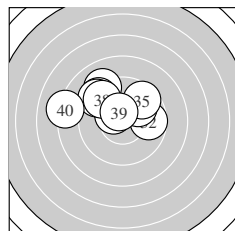

Serie 4:	9.1 ↘	9.7 →	9.3 ↘	10.0 ↗	9.6 ↗
	10.4 *	9.3 ↘	9.5 ↘	10.5 *	8.2 ←
beste Teiler	117.1 (39.)	128.7 (36.)	244.0 (34.)		
Trefferlage	1.18 mm links, 1.95 mm hoch				
Streuwert	2.29, horizontal: 3.02, vertikal: 1.20				

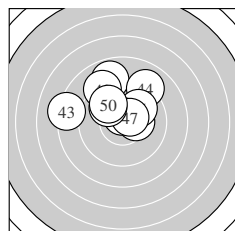

Serie 5:	10.3 *	8.9 ↘	8.2 ←	9.0 ↗	10.0 ↗
	10.7 *	10.5 *	9.1 ↘	10.0 ↘	9.9 ↘
beste Teiler	68.3 (46.)	104.8 (47.)	158.0 (41.)		
Trefferlage	0.70 mm links, 2.09 mm hoch				
Streuwert	2.27, horizontal: 2.74, vertikal: 1.67				

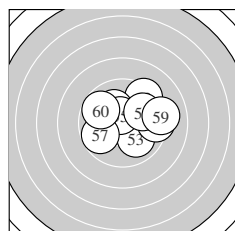

Serie 6:	10.5 *	9.4 ↗	10.0 ↘	10.2 *	10.6 *
	9.4 →	9.8 ←	9.9 ↗	9.1 →	9.7 ↘
beste Teiler	92.3 (55.)	125.2 (51.)	200.8 (54.)		
Trefferlage	0.95 mm rechts, 0.67 mm hoch				
Streuwert	2.07, horizontal: 2.54, vertikal: 1.46				

ISSF AR Men – Wertung – Junioren

StandNr: 129

Waibel, Kiano #84

StartNr: 126

2. Dezember 2017 15:04

VSB NWLZ

Unterschrift des Schützen

Meyton Elektronik

Ergebnis:	616.7	(590) ^{QF}							
Serien:	104.0	103.0	101.0	102.5	103.1	103.1			
Zähler:	50	10	0	0	0	0	0	0	0
Innenzehner:	39								
weiteste:	449 (8), 435 (37), 410 (26)								
beste Teiler	11.1 (2.)	11.1 (10.)	26.3 (48.)						
Trefferlage	0.03 mm links, 0.27 mm hoch								
Streuwert	1.38, horizontal: 1.60, vertikal: 1.12								

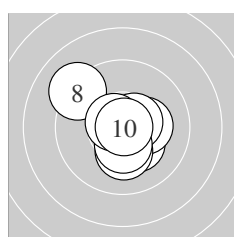
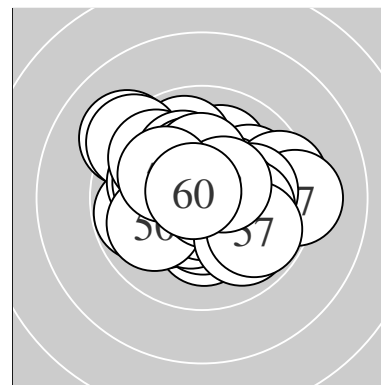

Serie 1:	10.6 *	10.9 *	10.3 *	10.3 *	10.6 *
	10.2 *	10.4 *	9.2 ↘	10.6 *	10.9 *
beste Teiler	11.1 (2.)	11.1 (10.)	77.0 (9.)		
Trefferlage	0.05 mm rechts, 0.12 mm tief				
Streuwert	1.36, horizontal: 1.42, vertikal: 1.30				

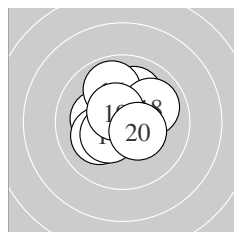

Serie 2:	10.6 *	10.8 *	10.2 *	10.0 ↗	10.1 ↙
	9.9 ↗	10.4 *	10.0 ↗	10.6 *	10.4 *
beste Teiler	27.8 (12.)	83.2 (11.)	97.9 (19.)		
Trefferlage	0.25 mm links, 0.48 mm hoch				
Streuwert	1.27, horizontal: 1.32, vertikal: 1.22				

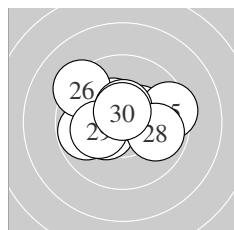

Serie 3:	10.4 *	9.8 ←	10.4 *	10.4 *	9.5 →
	9.3 ↘	10.5 *	9.9 →	10.2 *	10.6 *
beste Teiler	83.0 (30.)	107.1 (27.)	140.1 (24.)		
Trefferlage	0.23 mm links, 0.44 mm hoch				
Streuwert	1.76, horizontal: 2.22, vertikal: 1.11				

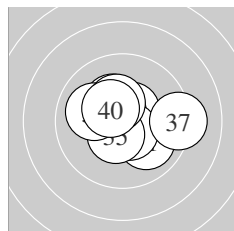

Serie 4:	10.0 ↘	10.5 *	10.6 *	10.6 *	10.5 *
	10.3 *	9.2 →	10.0 ←	10.4 *	10.4 *
beste Teiler	93.0 (33.)	97.9 (34.)	103.0 (32.)		
Trefferlage	0.20 mm rechts, 0.27 mm hoch				
Streuwert	1.49, horizontal: 1.82, vertikal: 1.07				

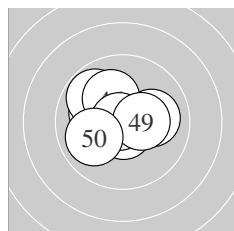

Serie 5:	10.7 *	10.6 *	10.1 ↘	9.8 ↘	10.6 *
	10.1 ↘	10.0 →	10.8 *	10.4 *	10.0 ←
beste Teiler	26.3 (48.)	67.4 (41.)	77.0 (45.)		
Trefferlage	0.52 mm links, 0.36 mm hoch				
Streuwert	1.25, horizontal: 1.49, vertikal: 0.97				

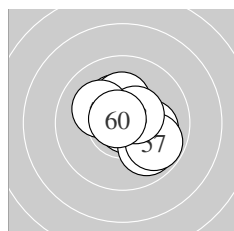

Serie 6:	10.1 →	10.6 *	10.3 *	10.8 *	9.9 ↘
	10.3 *	9.8 ↘	10.5 *	10.1 ↘	10.7 *
beste Teiler	31.0 (54.)	52.0 (60.)	81.3 (52.)		
Trefferlage	0.54 mm rechts, 0.20 mm hoch				
Streuwert	1.26, horizontal: 1.32, vertikal: 1.19				

Meyton Elektronik

ISSF AR Men – Wertung – Junioren

StandNr: 130

Pekler, Zalan #70817542

StartNr: 127

2. Dezember 2017 15:01

HUN

QF – Schütze hat sich fürs Finale qualifiziert

Unterschrift des Schützen

Meyton Elektronik

Ergebnis: **565.7** (541)

Serien: 94.2 93.6 96.4 95.3 93.6 92.6

Zähler: 18 25 17 0 0 0 0 0 0 0

Innenzehner: 12

weiteste: 730 (18), 726 (48), 660 (31)

beste Teiler 32.0 (44.) 62.6 (6.) 99.4 (21.)

Trefferlage 0.10 mm rechts, 0.20 mm tief

Streuwert 2.98, horizontal: 3.17, vertikal: 2.78

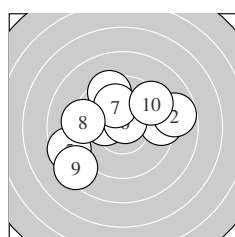
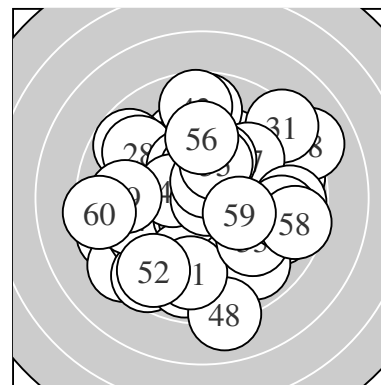

Serie 1:

9.4 →	8.8 →	9.4 ↗	10.2 *	8.6 ←
10.7 *	10.0 ↗	9.3 ←	8.4 ↘	9.4 ↗

beste Teiler 62.6 (6.) 183.3 (4.) 230.8 (7.)

Trefferlage 0.57 mm links, 0.49 mm hoch

Streuwert 3.08, horizontal: 3.72, vertikal: 2.26

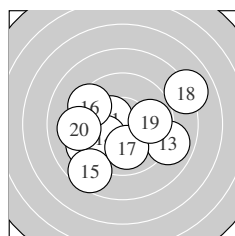

Serie 2:

10.4 *	9.3 ↘	8.9 ↘	10.0 ↘	8.6 ↘
9.4 ↘	10.0 ↓	8.0 ↗	9.8 →	9.2 ←

beste Teiler 137.8 (11.) 229.4 (14.) 241.6 (17.)

Trefferlage 0.34 mm links, 0.68 mm tief

Streuwert 3.17, horizontal: 3.82, vertikal: 2.33

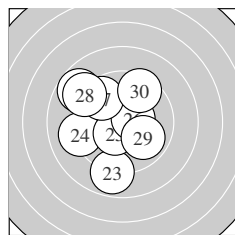

Serie 3:

10.6 *	8.8 ↘	8.9 ↓	9.1 ←	10.4 *
10.5 *	9.7 ↘	9.0 ↘	9.9 ↘	9.5 ↗

beste Teiler 99.4 (21.) 113.8 (26.) 138.3 (25.)

Trefferlage 1.25 mm links, 0.34 mm hoch

Streuwert 2.57, horizontal: 2.44, vertikal: 2.70

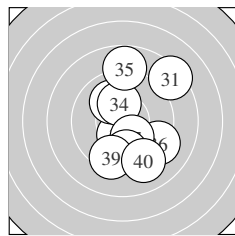

Serie 4:

8.3 ↗	10.4 *	10.0 ↗	10.2 *	8.8 ↑
9.2 ↘	10.2 *	9.7 ↓	9.4 ↓	9.1 ↓

beste Teiler 145.8 (32.) 181.4 (34.) 189.6 (37.)

Trefferlage 0.91 mm rechts, 0.26 mm tief

Streuwert 2.82, horizontal: 2.05, vertikal: 3.42

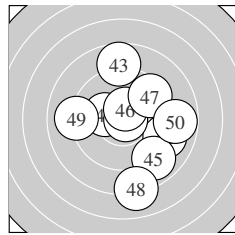

Serie 5:

10.2 *	9.1 ↘	8.7 ↑	10.8 *	8.9 ↓
10.5 *	9.5 ↗	8.0 ↓	9.1 ←	8.8 →

beste Teiler 32.0 (44.) 106.0 (46.) 185.5 (41.)

Trefferlage 1.07 mm rechts, 0.37 mm tief

Streuwert 3.25, horizontal: 3.02, vertikal: 3.46

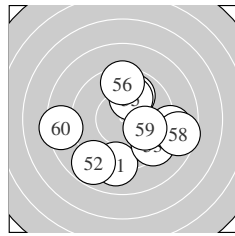

Serie 6:

9.1 ↓	8.8 ↘	9.3 ↘	9.9 ↗	10.0 ↗
9.5 ↑	9.0 →	8.6 →	10.0 →	8.4 ←

beste Teiler 228.7 (55.) 247.5 (59.) 260.8 (54.)

Trefferlage 0.79 mm rechts, 0.76 mm tief

Streuwert 3.22, horizontal: 3.60, vertikal: 2.80

ISSF AR Men – Wertung – Junioren

StandNr: 131

Ender, Lukas #70817478

StartNr: 128

2. Dezember 2017 15:14

VSB–TZ Altach

Unterschrift des Schützen

Meyton Elektronik

Ergebnis:	589.8	(565)
Serien:	98.0	100.9 99.0 97.6 96.6 97.7
Zähler:	31 24 4 1 0 0 0 0 0	
Innenzehner:	19	
weiteste:	787 (41), 677 (33), 562 (3)	
beste Teiler	13.0 (49.)	74.8 (18.) 102.4 (27.)
Trefferlage	0.05 mm rechts, 0.16 mm hoch	
Streuwert	2.27, horizontal: 2.76, vertikal: 1.63	

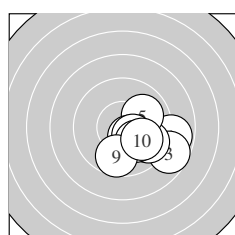
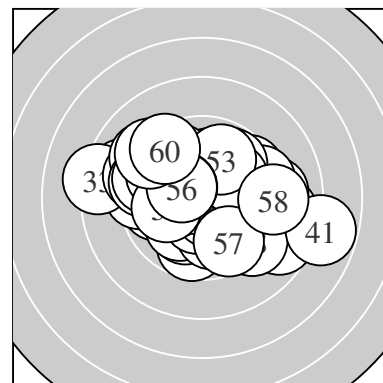

Serie 1:

8.9 →	10.0 ↘	8.7 ↘	9.7 ↘	10.0 ↗
10.5 *	10.4 *	10.1 ↘	9.7 ↓	10.0 ↘
beste Teiler	117.5 (6.)	138.8 (7.)	207.2 (8.)	
Trefferlage	2.16 mm rechts, 1.28 mm tief			
Streuwert	1.51, horizontal: 1.80, vertikal: 1.16			

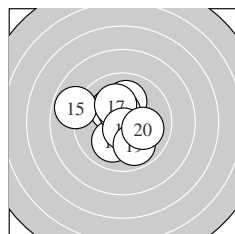

Serie 2:

10.3 *	10.2 *	10.0 ✓	10.1 ↑	8.9 ↖
10.5 *	10.2 *	10.7 *	9.9 ↘	10.1 →
beste Teiler	74.8 (18.)	118.2 (16.)	161.4 (11.)	
Trefferlage	0.54 mm links, 0.36 mm hoch			
Streuwert	1.79, horizontal: 1.90, vertikal: 1.66			

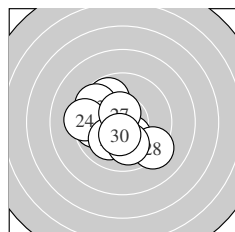

Serie 3:

9.8 ←	9.8 ↖	9.6 ↖	9.3 ←	10.0 ✓
10.3 *	10.5 *	9.3 ↘	10.0 ↓	10.4 *
beste Teiler	102.4 (27.)	136.5 (30.)	171.8 (26.)	
Trefferlage	0.86 mm links, 0.46 mm tief			
Streuwert	1.97, horizontal: 2.14, vertikal: 1.79			

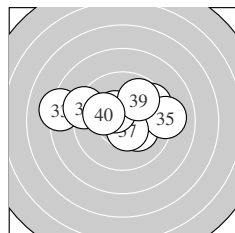

Serie 4:

10.5 *	10.2 *	8.2 ←	9.6 ↗	9.1 →
9.2 ↖	10.5 *	10.4 *	9.8 ↗	10.1 ↖
beste Teiler	106.4 (37.)	116.1 (31.)	127.9 (38.)	
Trefferlage	0.30 mm links, 0.77 mm hoch			
Streuwert	2.48, horizontal: 3.35, vertikal: 1.06			

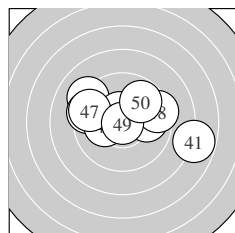

Serie 5:

7.8 →	9.2 ↖	10.5 *	9.9 →	9.4 ↖
10.2 *	9.5 ↖	9.4 →	10.9 *	9.8 ↗
beste Teiler	13.0 (49.)	105.0 (43.)	193.7 (46.)	
Trefferlage	0.26 mm rechts, 0.66 mm hoch			
Streuwert	2.80, horizontal: 3.73, vertikal: 1.34			

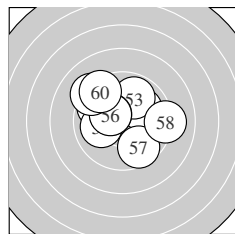

Serie 6:

9.7 ↖	10.0 ↗	9.9 ↑	10.0 ←	10.4 *
10.4 *	9.6 ↘	9.1 →	9.2 ↖	9.4 ↖
beste Teiler	146.3 (55.)	146.7 (56.)	234.5 (54.)	
Trefferlage	0.37 mm links, 0.91 mm hoch			
Streuwert	2.22, horizontal: 2.58, vertikal: 1.78			

Meyton Elektronik

ISSF AR Men – Wertung – Junioren

StandNr: 132

Achenrainer, Maximilian #70817148

StartNr: 129

2. Dezember 2017 15:02

T – SG Kaunertal

Unterschrift des Schützen

Meyton Elektronik

Ergebnis:	582.0	(550)
Serien:	96.3	95.0 94.6 97.2 98.7 100.2
Zähler:	20 32 6 2 0 0 0 0 0 0	
Innenzehner:	16	
weiteste:	847 (2), 764 (43), 627 (11)	
beste Teiler	47.6 (27.) 67.1 (15.) 89.1 (50.)	
Trefferlage	0.57 mm rechts, 0.60 mm hoch	
Streuwert	2.45, horizontal: 2.90, vertikal: 1.89	

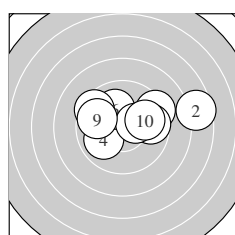
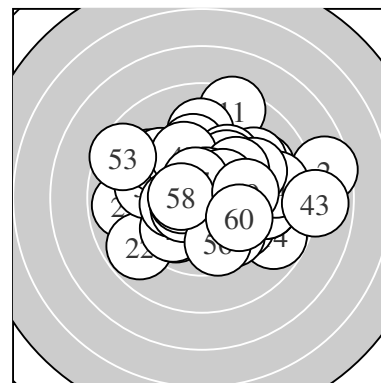

Serie 1:	10.3 *	7.6 →	9.3 ↘	9.9 ↙	9.7 →
	10.1 ↘	10.3 *	9.5 ↙	9.7 ↙	9.9 →
beste Teiler	151.5 (7.)	167.2 (1.)	219.1 (6.)		
Trefferlage	0.85 mm rechts, 0.96 mm hoch				
Streuwert	2.67, horizontal: 3.63, vertikal: 1.05				

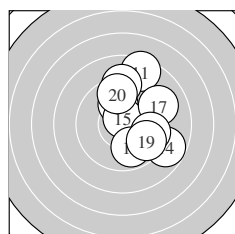

Serie 2:	8.4 ↑	10.0 ↑	9.2 ↑	8.8 ↘	10.7 *
	9.9 ↓	9.1 →	9.6 →	9.7 ↘	9.6 ↑
beste Teiler	67.1 (15.)	229.9 (12.)	273.6 (16.)		
Trefferlage	1.64 mm rechts, 1.09 mm hoch				
Streuwert	2.55, horizontal: 1.98, vertikal: 3.02				

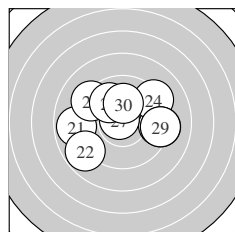

Serie 3:	8.9 ←	8.8 ↙	9.3 →	9.2 ↗	9.2 ↘
	9.2 →	10.8 *	9.9 ↘	9.2 →	10.1 ↑
beste Teiler	47.6 (27.)	211.1 (30.)	263.4 (28.)		
Trefferlage	0.13 mm rechts, 0.42 mm hoch				
Streuwert	2.94, horizontal: 3.71, vertikal: 1.85				

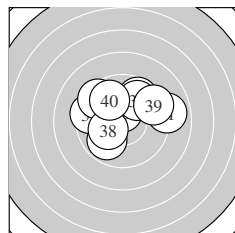

Serie 4:	8.9 →	9.7 ↑	9.9 ↙	9.4 ↙	10.6 *
	9.5 ↘	9.8 ↑	10.2 *	9.4 →	9.8 ↘
beste Teiler	100.0 (35.)	188.6 (38.)	274.7 (33.)		
Trefferlage	0.04 mm rechts, 1.13 mm hoch				
Streuwert	2.29, horizontal: 2.82, vertikal: 1.58				

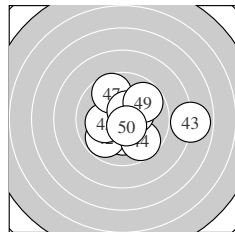

Serie 5:	10.2 *	9.8 ↙	7.9 →	9.7 ↘	10.1 ←
	10.4 *	9.7 ↘	10.5 *	9.8 ↗	10.6 *
beste Teiler	89.1 (50.)	104.2 (48.)	143.6 (46.)		
Trefferlage	0.90 mm rechts, 0.15 mm tief				
Streuwert	2.33, horizontal: 2.81, vertikal: 1.73				

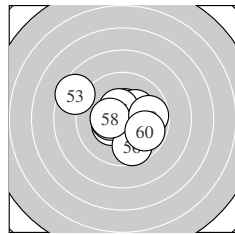

Serie 6:	10.5 *	10.4 *	8.5 ↘	10.4 *	10.2 *
	9.7 ↓	10.5 *	10.4 *	9.8 →	9.8 ↘
beste Teiler	118.8 (51.)	124.0 (57.)	133.7 (54.)		
Trefferlage	0.15 mm links, 0.14 mm hoch				
Streuwert	2.04, horizontal: 2.40, vertikal: 1.59				

ISSF AR Men – Wertung – Junioren

StandNr: 133

Hammerer, Sebastian #70804104

StartNr: 130

2. Dezember 2017 15:11

VSBB-TZ Höchst

Unterschrift des Schützen

Meyton Elektronik