

Ergebnis:	623.1	(592) ^{QF}
Serien:	102.8	104.6 103.7 104.1 104.1 103.8
Zähler:	52	8 0 0 0 0 0 0 0 0
Innenzehner:	48	
weiteste:	315 (34), 313 (48), 295 (1)	
beste Teiler	3.6 (24.)	8.5 (36.) 9.8 (19.)
Trefferlage	0.04 mm rechts, 0.03 mm hoch	
Streuwert	1.17, horizontal: 1.45, vertikal: 0.78	

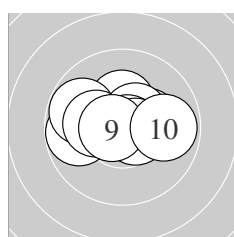

Serie 1:

9.8 ←	10.3 *	9.8 ↖	10.2 *	10.3 *
10.5 *	10.8 *	10.6 *	10.7 *	9.8 →
beste Teiler	32.7 (7.) 71.2 (9.) 92.0 (8.)			
Trefferlage	0.17 mm links, 0.31 mm hoch			
Streuwert	1.39, horizontal: 1.86, vertikal: 0.63			

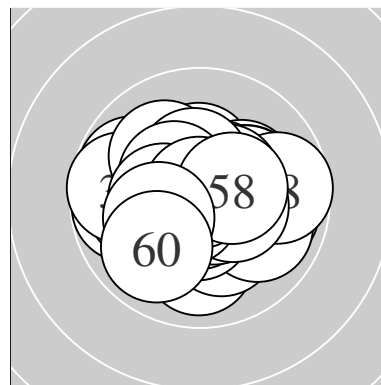
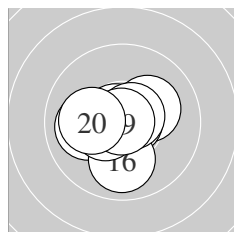

Serie 2:

10.7 *	10.7 *	10.2 *	10.0 ←	10.8 *
10.0 ↓	10.5 *	10.7 *	10.9 *	10.1 ←
beste Teiler	9.8 (19.) 46.2 (15.) 58.0 (11.)			
Trefferlage	0.40 mm links, 0.13 mm tief			
Streuwert	1.07, horizontal: 1.21, vertikal: 0.90			

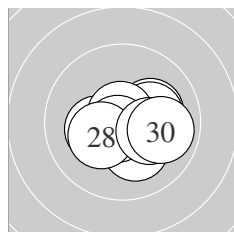

Serie 3:

10.2 *	10.2 *	10.3 *	10.9 *	10.2 *
10.8 *	10.7 *	10.3 *	10.2 *	9.9 →
beste Teiler	3.6 (24.) 50.9 (26.) 56.4 (27.)			
Trefferlage	0.53 mm rechts, 0.30 mm tief			
Streuwert	1.16, horizontal: 1.47, vertikal: 0.73			

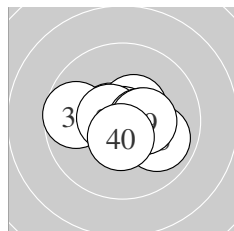

Serie 4:

10.6 *	10.5 *	10.5 *	9.7 ←	9.9 ↘
10.9 *	10.6 *	10.5 *	10.4 *	10.5 *
beste Teiler	8.5 (36.) 84.8 (31.) 88.0 (37.)			
Trefferlage	0.17 mm rechts, 0.09 mm tief			
Streuwert	1.18, horizontal: 1.53, vertikal: 0.65			

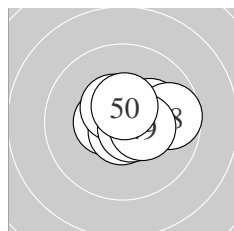

Serie 5:

10.2 *	10.5 *	10.7 *	10.7 *	10.2 *
10.5 *	10.7 *	9.7 →	10.4 *	10.5 *
beste Teiler	61.9 (44.) 63.3 (43.) 71.2 (47.)			
Trefferlage	0.75 mm rechts, 0.22 mm hoch			
Streuwert	0.99, horizontal: 1.27, vertikal: 0.58			

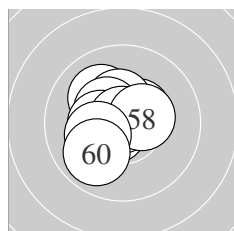

Serie 6:

10.5 *	10.1 ↖	10.4 *	10.4 *	10.6 *
10.4 *	10.9 *	10.4 *	10.2 *	9.9 ↙
beste Teiler	22.5 (57.) 76.4 (55.) 124.4 (51.)			
Trefferlage	0.60 mm links, 0.19 mm hoch			
Streuwert	1.09, horizontal: 1.09, vertikal: 1.08			

Meyton Elektronik

ISSF AR Men Jun – Wertung – Junioren

StandNr: 101

Friman, Cristian #167

StartNr: 1

21. Januar 2018 9:55

FIN – Esbo Skytteförening

QF – Schütze hat sich fürs Finale qualifiziert

Unterschrift des Schützen

Meyton Elektronik

Ergebnis:	621.3	(591) ^{QF}							
Serien:	102.6	103.8	102.1	103.1	105.1	104.6			
Zähler:	51	9	0	0	0	0	0	0	0
Innenzehner:	46								
weiteste:	346 (35), 341 (24), 325 (10)								
beste Teiler	31.7 (47.)	32.0 (42.)	35.3 (37.)						
Trefferlage	0.08 mm links, 0.18 mm hoch								
Streuwert	1.21, horizontal: 1.43, vertikal: 0.94								

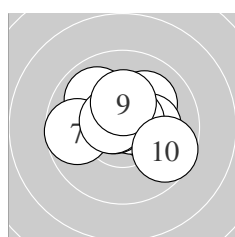
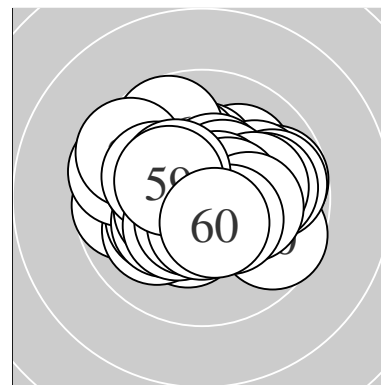

Serie 1:

10.1 ↗	10.2 *	10.7 *	10.7 *	9.9 ↖
10.7 *	9.7 ←	10.6 *	10.3 *	9.7 ↘
beste Teiler	64.0 (3.)	71.2 (6.)	73.4 (4.)	
Trefferlage	0.07 mm rechts, 0.53 mm hoch			
Streuwert	1.43, horizontal: 1.74, vertikal: 1.02			

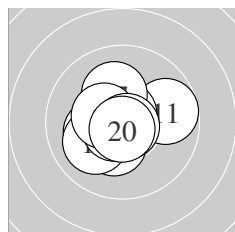

Serie 2:

9.7 →	10.3 *	10.2 *	10.7 *	10.0 ↙
10.7 *	10.2 *	10.4 *	10.8 *	10.8 *
beste Teiler	39.6 (19.)	48.1 (20.)	54.7 (14.)	
Trefferlage	0.33 mm links, 0.10 mm tief			
Streuwert	1.20, horizontal: 1.36, vertikal: 1.01			

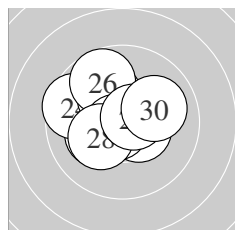

Serie 3:

10.2 *	10.4 *	10.5 *	9.6 ↖	10.2 *
9.7 ↖	10.7 *	10.2 *	10.6 *	10.0 →
beste Teiler	56.2 (27.)	80.5 (29.)	120.4 (23.)	
Trefferlage	0.56 mm links, 0.53 mm hoch			
Streuwert	1.39, horizontal: 1.56, vertikal: 1.21			

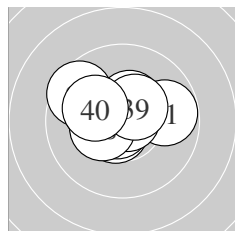

Serie 4:

9.8 →	10.6 *	10.4 *	10.8 *	9.6 ↖
10.2 *	10.8 *	10.4 *	10.4 *	10.1 ↖
beste Teiler	35.3 (37.)	49.5 (34.)	78.6 (32.)	
Trefferlage	0.42 mm links, 0.49 mm hoch			
Streuwert	1.30, horizontal: 1.66, vertikal: 0.80			

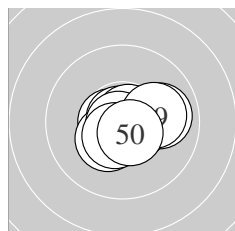

Serie 5:

10.6 *	10.8 *	10.8 *	9.9 →	10.6 *
10.4 *	10.8 *	10.5 *	10.1 →	10.6 *
beste Teiler	31.7 (47.)	32.0 (42.)	50.4 (43.)	
Trefferlage	0.34 mm rechts, 0.18 mm tief			
Streuwert	0.93, horizontal: 1.19, vertikal: 0.58			

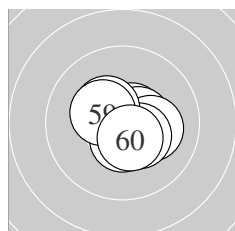

Serie 6:

10.7 *	10.6 *	10.5 *	10.5 *	10.2 *
10.5 *	10.4 *	10.4 *	10.3 *	10.5 *
beste Teiler	69.1 (51.)	78.2 (52.)	108.4 (54.)	
Trefferlage	0.39 mm rechts, 0.15 mm tief			
Streuwert	0.90, horizontal: 1.02, vertikal: 0.75			

Meyton Elektronik

ISSF AR Men Jun – Wertung – Junioren

StandNr: 102

Andriushin, Nikolai #174

StartNr: 2

21. Januar 2018 9:53

RUS

QF – Schütze hat sich fürs Finale qualifiziert

Unterschrift des Schützen

Meyton Elektronik

Ergebnis: **618.5** (592)

Serien: 102.3 103.8 103.8 103.2 103.7 101.7

Zähler: 52 8 0 0 0 0 0 0 0 0

Innenzehner: 46

weiteste: 386 (60), 319 (32), 305 (10)

beste Teiler 36.4 (38.) 40.8 (50.) 48.0 (13.)

Trefferlage 0.27 mm rechts, 0.10 mm hoch

Streuwert 1.24, horizontal: 1.48, vertikal: 0.95

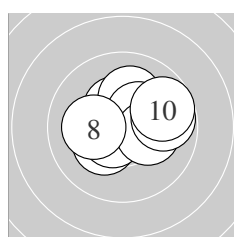
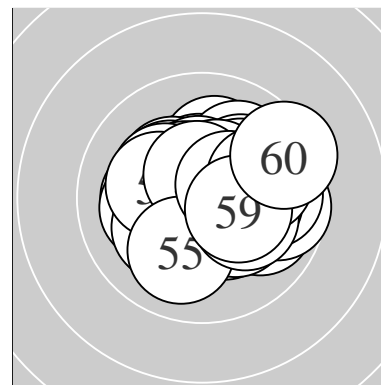

Serie 1:

10.7 *	10.3 *	10.4 *	10.6 *	10.1 ↑
10.4 *	10.2 *	10.1 ←	9.8 →	9.7 →

beste Teiler 52.4 (1.) 90.7 (4.) 140.2 (3.)

Trefferlage 0.46 mm rechts, 0.45 mm hoch

Streuwert 1.36, horizontal: 1.66, vertikal: 0.98

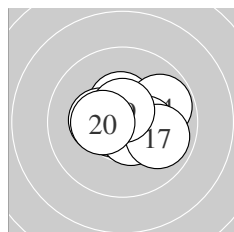

Serie 2:

10.7 *	10.4 *	10.8 *	9.8 →	10.3 *
10.6 *	9.9 ↘	10.3 *	10.6 *	10.4 *

beste Teiler 48.0 (13.) 69.3 (11.) 81.0 (19.)

Trefferlage 0.29 mm rechts, 0.08 mm hoch

Streuwert 1.17, horizontal: 1.47, vertikal: 0.76

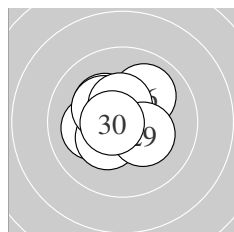

Serie 3:

10.7 *	10.1 ←	10.3 *	10.3 *	10.6 *
10.0 ↗	10.3 *	10.5 *	10.3 *	10.7 *

beste Teiler 70.7 (21.) 73.2 (30.) 94.0 (25.)

Trefferlage 0.41 mm links, 0.43 mm hoch

Streuwert 1.07, horizontal: 1.15, vertikal: 0.97

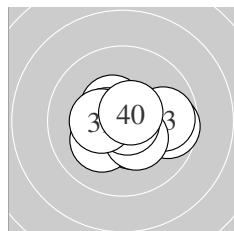

Serie 4:

10.4 *	9.7 →	9.8 →	10.5 *	10.5 *
10.2 *	10.3 *	10.8 *	10.4 *	10.6 *

beste Teiler 36.4 (38.) 81.3 (40.) 109.2 (35.)

Trefferlage 0.37 mm rechts, 0.23 mm tief

Streuwert 1.28, horizontal: 1.64, vertikal: 0.77

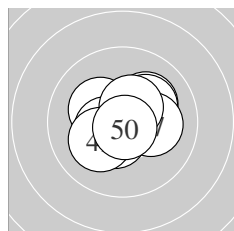

Serie 5:

10.1 ↗	10.5 *	10.2 *	10.2 *	10.5 *
10.5 *	10.2 *	10.5 *	10.2 *	10.8 *

beste Teiler 40.8 (50.) 113.1 (42.) 120.0 (48.)

Trefferlage 0.01 mm rechts, 0.03 mm hoch

Streuwert 1.18, horizontal: 1.37, vertikal: 0.94

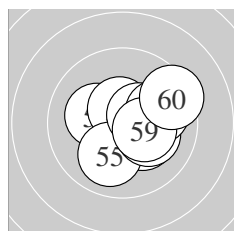

Serie 6:

10.5 *	10.2 *	10.2 *	10.6 *	10.0 ↓
10.2 *	10.4 *	9.9 →	10.3 *	9.4 →

beste Teiler 100.2 (54.) 123.6 (51.) 126.1 (57.)

Trefferlage 0.90 mm rechts, 0.11 mm tief

Streuwert 1.41, horizontal: 1.58, vertikal: 1.22

Meyton Elektronik

ISSF AR Men Jun – Wertung – Junioren

StandNr: 103

Chan, – En Yue Emmanuel #198

StartNr: 3

21. Januar 2018 9:30

SGP

Unterschrift des Schützen

Meyton Elektronik

Ergebnis: **609.3** (587)
 Serien: 101.9 100.9 101.8 101.9 101.5 101.3
 Zähler: 47 13 0 0 0 0 0 0 0
 Innenzehner: 32
 weiteste: 384 (58), 365 (25), 342 (47)
 beste Teiler 60.0 (32.) 96.5 (40.) 98.3 (29.)
 Trefferlage 0.03 mm rechts, 0.33 mm hoch
 Streuwert 1.50, horizontal: 1.68, vertikal: 1.30

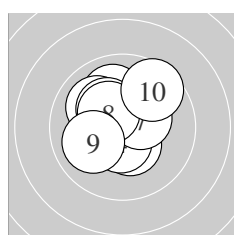
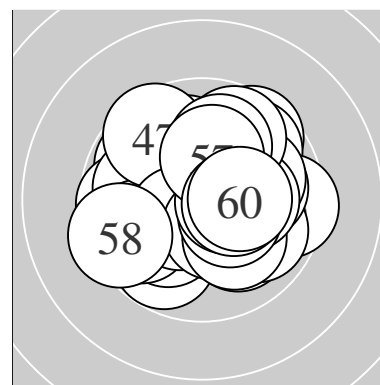

Serie 1:
 10.0 ↗ 10.4 * 10.3 * 10.5 * 10.0 ↘
 10.3 * 10.4 * 10.4 * 10.0 ← 9.6 ↗
 beste Teiler 104.8 (4.) 135.6 (2.) 144.8 (7.)
 Trefferlage 0.17 mm links, 0.71 mm hoch
 Streuwert 1.41, horizontal: 1.42, vertikal: 1.39

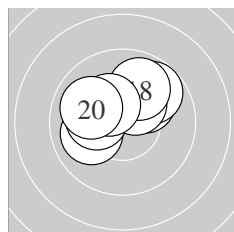

Serie 2:
 10.0 ← 10.1 ↗ 10.2 * 9.8 ↗ 10.1 ↗
 10.2 * 10.3 * 9.9 ↗ 10.3 * 10.0 ↘
 beste Teiler 156.8 (19.) 160.6 (17.) 187.6 (16.)
 Trefferlage 0.24 mm links, 1.14 mm hoch
 Streuwert 1.40, horizontal: 1.73, vertikal: 0.95

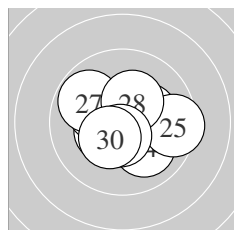

Serie 3:
 10.4 * 10.2 * 10.4 * 10.0 ↘ 9.5 →
 10.2 * 9.8 ↘ 10.3 * 10.6 * 10.4 *
 beste Teiler 98.3 (29.) 134.2 (21.) 140.4 (23.)
 Trefferlage 0.19 mm rechts, 0.14 mm tief
 Streuwert 1.53, horizontal: 1.84, vertikal: 1.15

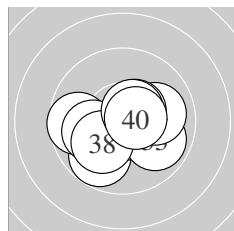

Serie 4:
 9.8 ↗ 10.7 * 9.9 ↘ 10.0 → 9.7 ←
 10.1 ← 10.5 * 10.1 ↗ 10.5 * 10.6 *
 beste Teiler 60.0 (32.) 96.5 (40.) 102.5 (39.)
 Trefferlage 0.12 mm links, 0.45 mm tief
 Streuwert 1.54, horizontal: 1.90, vertikal: 1.07

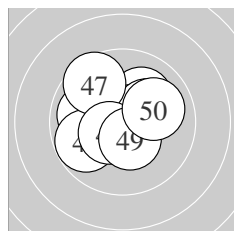

Serie 5:
 10.4 * 10.1 ↗ 10.6 * 9.9 ← 10.2 *
 9.8 ← 9.6 ↘ 10.5 * 10.4 * 10.0 →
 beste Teiler 98.9 (43.) 122.1 (48.) 128.0 (41.)
 Trefferlage 0.21 mm links, 0.49 mm hoch
 Streuwert 1.56, horizontal: 1.79, vertikal: 1.30

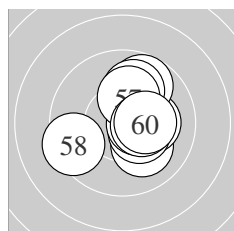

Serie 6:
 10.1 ↘ 10.2 * 10.4 * 9.8 ↗ 10.0 ↗
 10.5 * 10.2 * 9.4 ← 10.4 * 10.3 *
 beste Teiler 108.2 (56.) 137.8 (53.) 138.0 (59.)
 Trefferlage 0.76 mm rechts, 0.28 mm hoch
 Streuwert 1.54, horizontal: 1.57, vertikal: 1.51

Meyton Elektronik

ISSF AR Men Jun – Wertung – Junioren

StandNr: 104

Davis, Michael #164

StartNr: 4

21. Januar 2018 9:33

AUS

Unterschrift des Schützen

Meyton Elektronik

Ergebnis: **613.1** (588)
 Serien: 101.8 101.7 101.1 102.4 103.4 102.7
 Zähler: 48 12 0 0 0 0 0 0 0
 Innenzehner: 40
 weiteste: 398 (25), 366 (26), 349 (45)
 beste Teiler 34.4 (7.) 42.1 (14.) 67.4 (50.)
 Trefferlage 0.40 mm links, 0.06 mm tief
 Streuwert 1.42, horizontal: 1.45, vertikal: 1.40

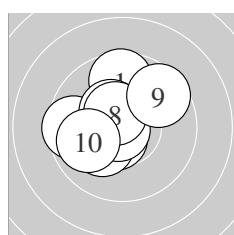
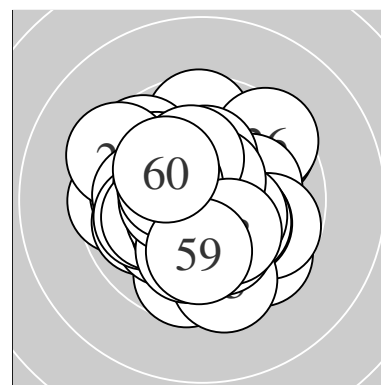

Serie 1:
 9.6 ↑ 10.6 * 9.6 ← 10.4 * 10.6 *
 10.2 * 10.8 * 10.5 * 9.6 ↗ 9.9 ←
 beste Teiler 34.4 (7.) 92.1 (2.) 92.4 (5.)
 Trefferlage 0.74 mm links, 0.52 mm hoch
 Streuwert 1.51, horizontal: 1.57, vertikal: 1.45

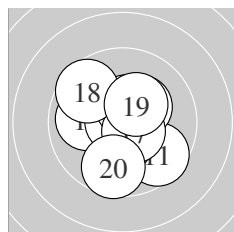

Serie 2:
 9.6 ↘ 10.4 * 9.9 ← 10.8 * 10.5 *
 10.3 * 10.6 * 9.6 ↖ 10.3 * 9.7 ↓
 beste Teiler 42.1 (14.) 100.7 (17.) 115.8 (15.)
 Trefferlage 0.04 mm links, 0.15 mm tief
 Streuwert 1.64, horizontal: 1.57, vertikal: 1.70

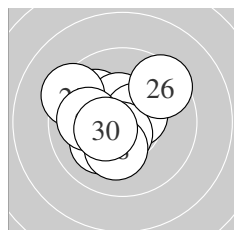

Serie 3:
 10.0 ↘ 10.4 * 10.5 * 10.6 * 9.4 ↖
 9.5 ↗ 10.1 ↙ 10.2 * 10.0 ← 10.4 *
 beste Teiler 83.0 (24.) 106.4 (23.) 126.9 (22.)
 Trefferlage 0.78 mm links, 0.32 mm hoch
 Streuwert 1.61, horizontal: 1.76, vertikal: 1.46

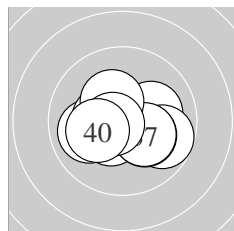

Serie 4:
 10.1 → 10.5 * 9.8 ↘ 10.0 ← 10.2 *
 10.4 * 10.2 * 10.3 * 10.7 * 10.2 *
 beste Teiler 73.3 (39.) 123.2 (32.) 133.8 (36.)
 Trefferlage 0.01 mm rechts, 0.34 mm tief
 Streuwert 1.39, horizontal: 1.79, vertikal: 0.82

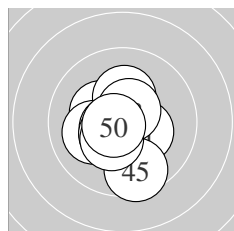

Serie 5:
 10.3 * 10.3 * 10.3 * 10.1 ← 9.6 ↓
 10.6 * 10.5 * 10.6 * 10.4 * 10.7 *
 beste Teiler 67.4 (50.) 92.1 (46.) 93.5 (48.)
 Trefferlage 0.37 mm links, 0.42 mm tief
 Streuwert 1.24, horizontal: 1.07, vertikal: 1.38

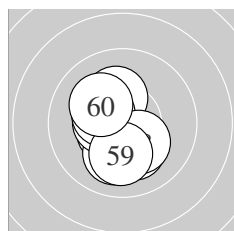

Serie 6:
 10.5 * 10.2 * 10.1 ↓ 10.4 * 10.4 *
 10.2 * 10.4 * 10.2 * 10.1 ↓ 10.2 *
 beste Teiler 118.7 (51.) 129.0 (54.) 141.2 (55.)
 Trefferlage 0.52 mm links, 0.33 mm tief
 Streuwert 1.23, horizontal: 0.90, vertikal: 1.49

Meyton Elektronik

ISSF AR Men Jun – Wertung – Junioren

StandNr: 105

Diem, Patrick #157

StartNr: 5

21. Januar 2018 9:57

AUT

Unterschrift des Schützen

Meyton Elektronik

Ergebnis:	600.3	(578)			
Serien:	99.4	99.5	100.9	99.7	100.4 100.4
Zähler:	40	18	2	0	0 0 0 0 0
Innenzehner:	25				
weiteste:	668	(53), 501	(1), 458	(15)	
beste Teiler	20.5	(56.)	23.3	(57.)	85.2 (36.)
Trefferlage	0.27	mm links,	0.25	mm hoch	
Streuwert	1.87,	horizontal: 1.98,	vertikal: 1.74		

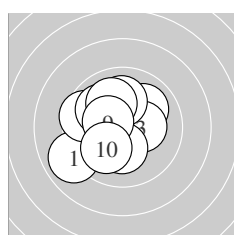
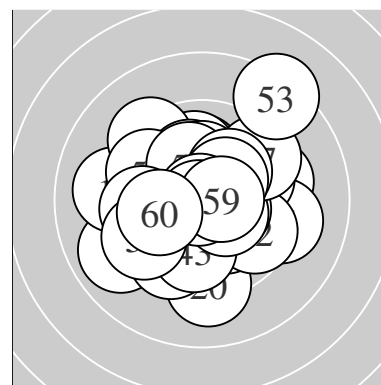

Serie 1:	8.9 ↙	10.0 ↗	10.3 *	9.6 ↖	10.0 ↘
	10.0 ↑	10.0 ↘	10.2 *	10.4 *	10.0 ↙
beste Teiler	137.4	(9.)	163.0	(3.)	183.0 (8.)
Trefferlage	0.99	mm links,	0.26	mm hoch	
Streuwert	1.85,	horizontal: 1.93,	vertikal: 1.77		

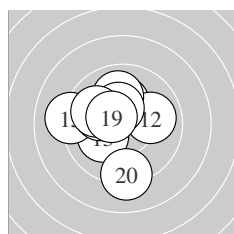

Serie 2:	10.2 *	10.0 →	10.1 ↙	10.0 ↑	9.1 ←
	10.4 *	10.1 ↖	9.9 ↖	10.5 *	9.2 ↓
beste Teiler	116.2	(19.)	146.4	(16.)	192.1 (11.)
Trefferlage	0.94	mm links,	0.39	mm hoch	
Streuwert	1.89,	horizontal: 1.86,	vertikal: 1.93		

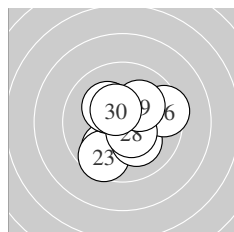

Serie 3:	10.2 *	9.9 ↙	9.6 ↙	10.1 ↘	10.3 *
	9.5 →	10.2 *	10.5 *	10.1 ↗	10.5 *
beste Teiler	116.1	(28.)	123.5	(30.)	170.4 (25.)
Trefferlage	0.20	mm rechts,	0.31	mm tief	
Streuwert	1.70,	horizontal: 1.70,	vertikal: 1.69		

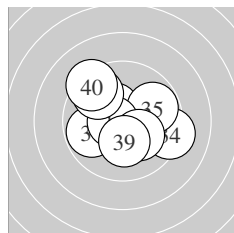

Serie 4:	9.8 ↙	10.4 *	10.4 *	9.3 →	9.8 →
	10.6 *	9.7 ↘	10.2 *	10.2 *	9.3 ↘
beste Teiler	85.2	(36.)	134.5	(33.)	144.6 (32.)
Trefferlage	0.02	mm rechts,	0.17	mm hoch	
Streuwert	2.01,	horizontal: 2.30,	vertikal: 1.68		

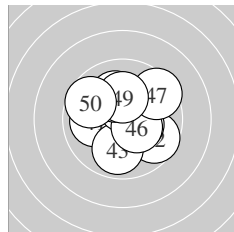

Serie 5:	10.0 ←	9.7 ↘	9.9 ↓	10.4 *	10.5 *
	10.4 *	9.5 ↗	10.1 ↘	10.2 *	9.7 ↖
beste Teiler	110.2	(45.)	142.8	(46.)	146.1 (44.)
Trefferlage	0.21	mm rechts,	0.30	mm hoch	
Streuwert	1.80,	horizontal: 1.93,	vertikal: 1.66		

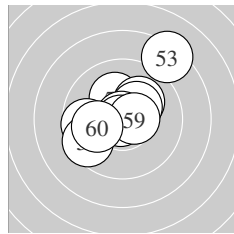

Serie 6:	10.2 *	10.1 ↗	8.3 ↗	9.7 ←	10.3 *
	10.9 *	10.9 *	9.5 ↙	10.5 *	10.0 ←
beste Teiler	20.5	(56.)	23.3	(57.)	101.0 (59.)
Trefferlage	0.18	mm links,	0.67	mm hoch	
Streuwert	2.11,	horizontal: 2.21,	vertikal: 2.00		

Meyton Elektronik

ISSF AR Men Jun – Wertung – Junioren

StandNr: 106

Egger, Martin #153

StartNr: 6

21. Januar 2018 9:37

NÖ

Unterschrift des Schützen

Meyton Elektronik

Ergebnis:	600.7	(577)
Serien:	99.9	100.7 103.6 98.5 98.7 99.3
Zähler:	39	19 2 0 0 0 0 0 0 0
Innenzehner:	27	
weiteste:	635 (32), 567 (13), 437 (39)	
beste Teiler	40.4 (18.) 46.1 (59.) 67.0 (27.)	
Trefferlage	0.63 mm rechts, 0.04 mm hoch	
Streuwert	1.86, horizontal: 1.96, vertikal: 1.76	

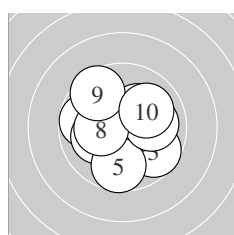
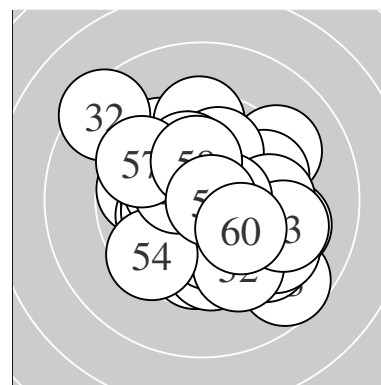

Serie 1:	9.8 ↖	10.1 ↖	9.7 ↘	10.5 *	9.7 ↓
	10.2 *	10.0 →	10.3 *	9.6 ↖	10.0 ↗
beste Teiler	109.8 (4.) 175.2 (8.) 179.0 (6.)				
Trefferlage	0.00 mm , 0.06 mm hoch				
Streuwert	1.89, horizontal: 2.07, vertikal: 1.68				

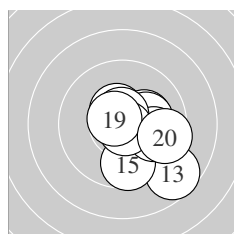

Serie 2:	10.5 *	10.2 *	8.7 ↘	10.2 *	9.7 ↓
	9.9 →	10.6 *	10.8 *	10.6 *	9.5 →
beste Teiler	40.4 (18.) 77.6 (17.) 80.7 (19.)				
Trefferlage	1.31 mm rechts, 0.60 mm tief				
Streuwert	1.70, horizontal: 1.68, vertikal: 1.71				

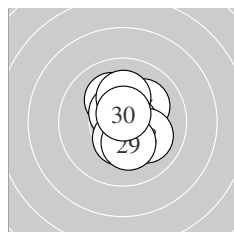

Serie 3:	10.1 ↖	10.6 *	10.4 *	10.4 *	10.1 ↗
	10.2 *	10.7 *	10.1 ↘	10.3 *	10.7 *
beste Teiler	67.0 (27.) 70.3 (30.) 93.4 (22.)				
Trefferlage	0.43 mm rechts, 0.30 mm hoch				
Streuwert	1.13, horizontal: 0.92, vertikal: 1.31				

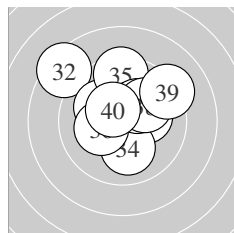

Serie 4:	10.2 *	8.4 ↖	10.1 ↖	10.1 ↓	9.4 ↑
	10.2 *	10.3 *	10.1 ↗	9.2 ↗	10.5 *
beste Teiler	123.4 (40.) 172.5 (37.) 183.0 (36.)				
Trefferlage	0.02 mm links, 1.26 mm hoch				
Streuwert	2.16, horizontal: 2.40, vertikal: 1.90				

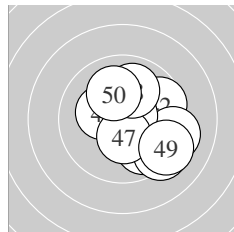

Serie 5:	9.8 ↘	9.7 →	9.3 ↘	10.3 *	9.2 →
	10.7 *	10.4 *	10.0 ↑	9.2 ↘	10.1 ↑
beste Teiler	67.6 (46.) 142.5 (47.) 171.0 (44.)				
Trefferlage	1.47 mm rechts, 0.36 mm tief				
Streuwert	1.92, horizontal: 1.94, vertikal: 1.90				

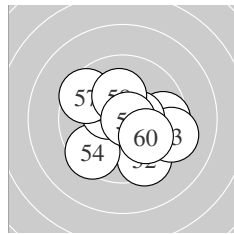

Serie 6:	9.6 →	9.5 ↘	9.3 →	9.5 ↗	10.4 *
	10.5 *	9.5 ↖	10.2 *	10.8 *	10.0 ↘
beste Teiler	46.1 (59.) 120.2 (56.) 131.0 (55.)				
Trefferlage	0.57 mm rechts, 0.42 mm tief				
Streuwert	2.05, horizontal: 2.32, vertikal: 1.73				

Meyton Elektronik

ISSF AR Men Jun – Wertung – Junioren

StandNr: 107

Einwaller, Dominic #169

StartNr: 7

21. Januar 2018 9:32

T – SG Scheffau

Unterschrift des Schützen

Meyton Elektronik

Ergebnis:	618.5	(592)						
Serien:	101.2	103.8	104.7	104.3	103.1	101.4		
Zähler:	52	8	0	0	0	0	0	0
Innenzehner:	44							
weiteste:	414 (3), 340 (52), 329 (11)							
beste Teiler	29.1 (20.)	33.2 (28.)	43.1 (24.)					
Trefferlage	0.12 mm rechts, 0.11 mm tief							
Streuwert	1.28, horizontal: 1.34, vertikal: 1.20							

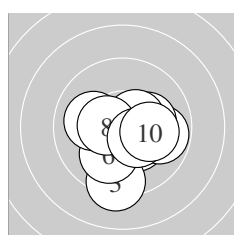
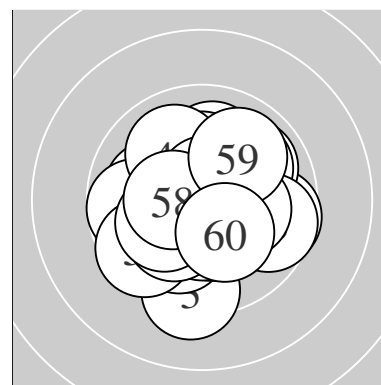

Serie 1:

10.3 *	9.8 →	9.3 ↓	10.2 *	10.5 *
10.0 ↙	10.1 ←	10.5 *	10.4 *	10.1 →
beste Teiler	114.9 (5.)	120.7 (8.)	135.0 (9.)	
Trefferlage	0.47 mm rechts, 0.73 mm tief			
Streuwert	1.54, horizontal: 1.63, vertikal: 1.44			

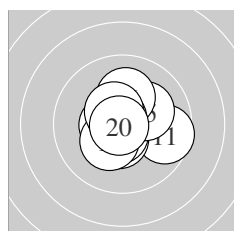

Serie 2:

9.6 →	10.5 *	10.5 *	10.6 *	10.2 *
10.1 ↑	10.3 *	10.7 *	10.5 *	10.8 *
beste Teiler	29.1 (20.)	59.4 (18.)	81.3 (14.)	
Trefferlage	0.11 mm rechts, 0.03 mm hoch			
Streuwert	1.21, horizontal: 1.33, vertikal: 1.07			

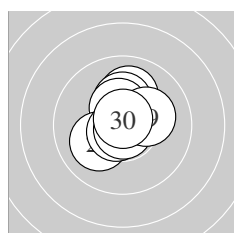

Serie 3:

10.0 ↑	10.7 *	10.2 *	10.8 *	10.4 *
10.1 ↙	10.7 *	10.8 *	10.2 *	10.8 *
beste Teiler	33.2 (28.)	43.1 (24.)	48.0 (30.)	
Trefferlage	0.03 mm links, 0.47 mm hoch			
Streuwert	0.99, horizontal: 0.88, vertikal: 1.09			

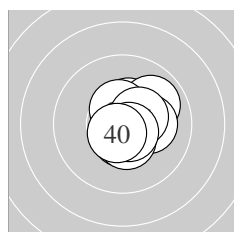

Serie 4:

10.5 *	10.4 *	9.9 ↗	10.5 *	10.7 *
10.2 *	10.4 *	10.5 *	10.6 *	10.6 *
beste Teiler	54.4 (35.)	76.8 (39.)	80.4 (40.)	
Trefferlage	0.61 mm rechts, 0.05 mm hoch			
Streuwert	0.93, horizontal: 0.88, vertikal: 0.98			

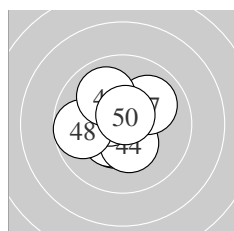

Serie 5:

10.6 *	10.5 *	10.4 *	10.3 *	10.4 *
10.5 *	10.0 ↗	9.7 ←	10.0 ↘	10.7 *
beste Teiler	71.1 (50.)	97.5 (41.)	114.2 (46.)	
Trefferlage	0.44 mm links, 0.23 mm hoch			
Streuwert	1.26, horizontal: 1.34, vertikal: 1.17			

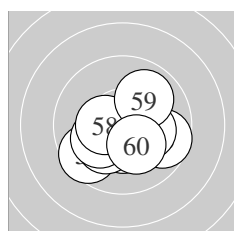

Serie 6:

10.6 *	9.6 ↙	9.7 →	10.4 *	10.2 *
10.2 *	10.2 *	10.4 *	9.9 ↗	10.2 *
beste Teiler	76.5 (51.)	133.0 (58.)	142.0 (54.)	
Trefferlage	0.02 mm rechts, 0.77 mm tief			
Streuwert	1.51, horizontal: 1.81, vertikal: 1.14			

Meyton Elektronik

ISSF AR Men Jun – Wertung – Junioren

StandNr: 108

Filippov, Artem #163

StartNr: 8

21. Januar 2018 9:50

RUS

Unterschrift des Schützen

Meyton Elektronik

Ergebnis: **617.3** (591)
 Serien: 101.3 104.3 104.0 101.8 101.4 104.5
 Zähler: 51 9 0 0 0 0 0 0 0
 Innenzehner: 41
 weiteste: 378 (47), 338 (1), 338 (36)
 beste Teiler 35.3 (25.) 43.5 (49.) 45.1 (51.)
 Trefferlage 0.17 mm rechts, 0.40 mm tief
 Streuwert 1.28, horizontal: 1.41, vertikal: 1.14

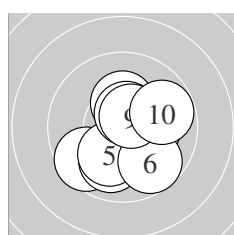
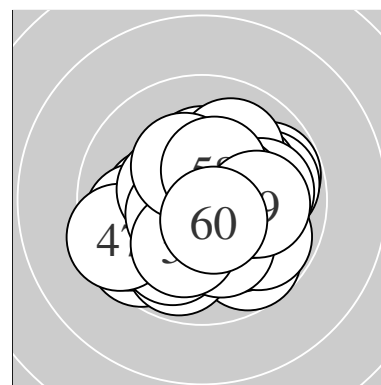

Serie 1:
 9.6 ↙ 10.0 ↘ 10.4 * 10.2 * 10.1 ↘
 9.7 ↘ 10.3 * 10.6 * 10.6 * 9.8 →
 beste Teiler 97.6 (9.) 99.4 (8.) 132.2 (3.)
 Trefferlage 0.41 mm rechts, 0.37 mm tief
 Streuwert 1.61, horizontal: 1.58, vertikal: 1.65

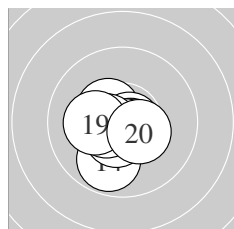

Serie 2:
 10.4 * 10.4 * 10.8 * 9.8 ↘ 10.6 *
 10.7 * 10.5 * 10.5 * 10.2 * 10.4 *
 beste Teiler 48.3 (13.) 65.4 (16.) 81.3 (15.)
 Trefferlage 0.38 mm links, 0.62 mm tief
 Streuwert 0.92, horizontal: 0.95, vertikal: 0.89

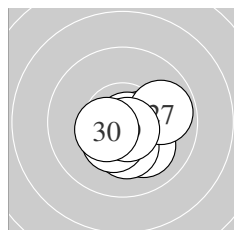

Serie 3:
 10.6 * 10.4 * 10.4 * 10.1 ↘ 10.8 *
 10.3 * 9.8 → 10.4 * 10.7 * 10.5 *
 beste Teiler 35.3 (25.) 62.1 (29.) 80.7 (21.)
 Trefferlage 0.60 mm rechts, 0.62 mm tief
 Streuwert 0.94, horizontal: 1.10, vertikal: 0.75

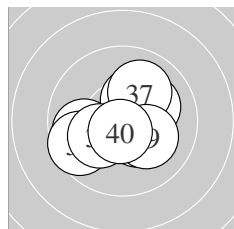

Serie 4:
 10.5 * 9.8 ← 10.3 * 10.4 * 10.1 →
 9.6 ↙ 10.0 ↗ 10.2 * 10.2 * 10.7 *
 beste Teiler 74.9 (40.) 112.1 (31.) 142.8 (34.)
 Trefferlage 0.01 mm links, 0.10 mm tief
 Streuwert 1.55, horizontal: 1.79, vertikal: 1.25

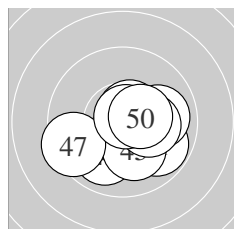

Serie 5:
 9.8 ↘ 10.0 → 10.1 ↘ 10.0 ↘ 10.1 ↘
 10.2 * 9.4 ← 10.6 * 10.8 * 10.4 *
 beste Teiler 43.5 (49.) 86.0 (48.) 130.9 (50.)
 Trefferlage 0.36 mm rechts, 0.73 mm tief
 Streuwert 1.54, horizontal: 1.85, vertikal: 1.14

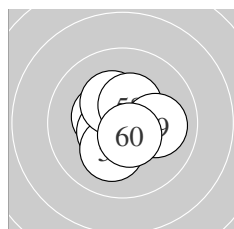

Serie 6:
 10.8 * 10.4 * 10.7 * 10.6 * 10.5 *
 10.2 * 10.3 * 10.4 * 10.0 → 10.6 *
 beste Teiler 45.1 (51.) 71.8 (53.) 98.1 (60.)
 Trefferlage 0.07 mm rechts, 0.00 mm
 Streuwert 1.04, horizontal: 1.07, vertikal: 1.01

Meyton Elektronik

ISSF AR Men Jun – Wertung – Junioren

StandNr: 109

Hoberg, Alex #177

StartNr: 9

21. Januar 2018 9:29

AUS

Unterschrift des Schützen

Meyton Elektronik

Ergebnis:	581.4	(553)
Serien:	96.4	98.3 95.7 93.4 97.4 100.2
Zähler:	18	37 5 0 0 0 0 0 0 0
Innenzehner:	12	
weiteste:	703	(34), 616 (21), 562 (40)
beste Teiler	35.4	(35.) 45.6 (51.) 99.4 (27.)
Trefferlage	0.11 mm links, 0.16 mm tief	
Streuwert	2.44, horizontal: 2.62, vertikal: 2.24	

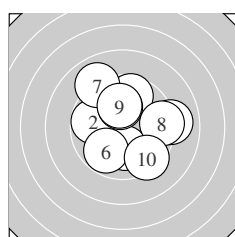
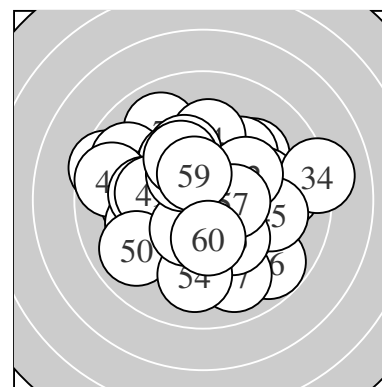

Serie 1:	10.1 ↓	9.8 ←	9.7 ↑	10.1 ↑	9.0 →
	9.8 ↙	9.0 ↘	9.4 →	10.1 ↑	9.4 ↘
beste Teiler	202.5 (4.) 210.2 (1.) 217.2 (9.)				
Trefferlage	0.45 mm rechts, 0.54 mm hoch				
Streuwert	2.52, horizontal: 2.61, vertikal: 2.43				

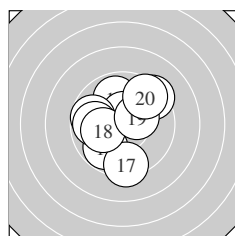

Serie 2:	9.9 ↑	9.4 ↗	10.5 *	9.8 ↙	9.7 ←
	9.8 ←	9.3 ↓	10.1 ←	10.3 *	9.5 ↗
beste Teiler	103.3 (13.) 158.3 (19.) 205.9 (18.)				
Trefferlage	0.31 mm links, 0.35 mm hoch				
Streuwert	2.15, horizontal: 2.08, vertikal: 2.22				

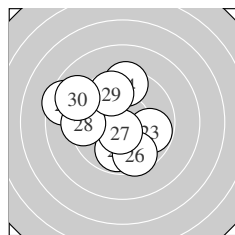

Serie 3:	8.5 ←	10.0 ↘	9.8 →	9.4 ↑	9.8 ↓
	9.6 ↓	10.6 *	9.4 ←	9.7 ↑	8.9 ←
beste Teiler	99.4 (27.) 226.4 (22.) 277.3 (25.)				
Trefferlage	1.06 mm links, 0.13 mm hoch				
Streuwert	2.65, horizontal: 2.82, vertikal: 2.47				

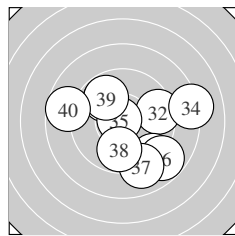

Serie 4:	9.8 ↘	9.5 →	9.1 ↘	8.1 →	10.8 *
	8.8 ↘	9.0 ↓	9.8 ↓	9.8 ↘	8.7 ←
beste Teiler	35.4 (35.) 276.4 (31.) 284.9 (38.)				
Trefferlage	0.97 mm rechts, 0.63 mm tief				
Streuwert	3.16, horizontal: 3.57, vertikal: 2.68				

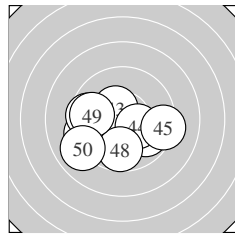

Serie 5:	9.8 ↘	10.2 *	10.4 *	10.3 *	9.3 →
	9.4 ←	9.6 ←	9.7 ↓	9.7 ←	9.0 ←
beste Teiler	129.2 (43.) 166.8 (44.) 192.3 (42.)				
Trefferlage	0.89 mm links, 0.94 mm tief				
Streuwert	2.20, horizontal: 2.80, vertikal: 1.36				

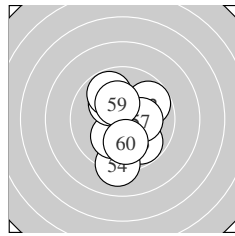

Serie 6:	10.8 *	9.8 ↗	9.8 ↘	9.1 ↓	10.2 *
	10.2 *	10.2 *	9.8 ↘	10.3 *	10.0 ↓
beste Teiler	45.6 (51.) 165.7 (59.) 180.2 (57.)				
Trefferlage	0.17 mm rechts, 0.41 mm tief				
Streuwert	1.88, horizontal: 1.39, vertikal: 2.26				

ISSF AR Men Jun – Wertung – Junioren

StandNr: 110

Kaiser, Elias #160

StartNr: 10

21. Januar 2018 9:51

VLSV

Unterschrift des Schützen

Meyton Elektronik

Ergebnis:	619.9	(594) ^{QF}							
Serien:	103.4	101.8	102.5	103.6	103.5	105.1			
Zähler:	54	6	0	0	0	0	0	0	0
Innenzehner:	46								
weiteste:	418 (21), 315 (16), 302 (18)								
beste Teiler	8.0 (57.)	36.8 (5.)	40.1 (25.)						
Trefferlage	0.12 mm links, 0.21 mm hoch								
Streuwert	1.23, horizontal: 1.21, vertikal: 1.26								

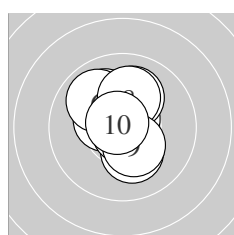
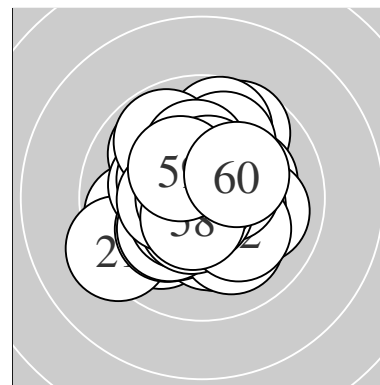

Serie 1:	10.4 *	10.0 ↘	10.2 *	10.7 *	10.8 *
	9.9 ↘	10.1 ↑	10.1 ↑	10.4 *	10.8 *
beste Teiler	36.8 (5.) 49.8 (10.) 70.8 (4.)				
Trefferlage	0.15 mm links, 0.60 mm hoch				
Streuwert	1.20, horizontal: 0.96, vertikal: 1.41				

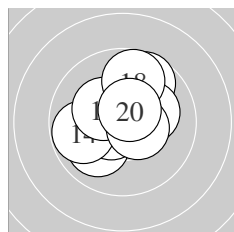

Serie 2:	10.0 ↙	10.6 *	10.4 *	9.8 ↖	10.3 *
	9.7 ↑	10.2 *	9.7 ↑	10.5 *	10.6 *
beste Teiler	91.3 (12.) 100.3 (20.) 115.8 (19.)				
Trefferlage	0.02 mm rechts, 0.56 mm hoch				
Streuwert	1.52, horizontal: 1.58, vertikal: 1.46				

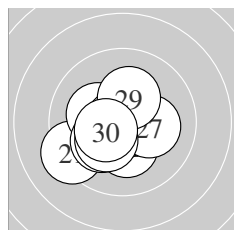

Serie 3:	9.3 ↙	10.3 *	10.2 *	10.2 *	10.8 *
	10.6 *	10.2 *	10.3 *	10.2 *	10.4 *
beste Teiler	40.1 (25.) 78.8 (26.) 132.3 (30.)				
Trefferlage	0.74 mm links, 0.56 mm tief				
Streuwert	1.32, horizontal: 1.48, vertikal: 1.15				

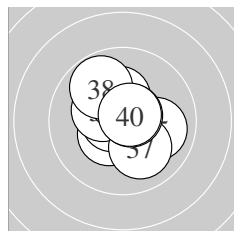

Serie 4:	10.6 *	10.4 *	10.7 *	10.3 *	10.0 →
	10.3 *	10.1 ↘	9.8 ↘	10.7 *	10.7 *
beste Teiler	68.0 (40.) 72.1 (39.) 72.2 (33.)				
Trefferlage	0.05 mm links, 0.32 mm hoch				
Streuwert	1.24, horizontal: 1.23, vertikal: 1.24				

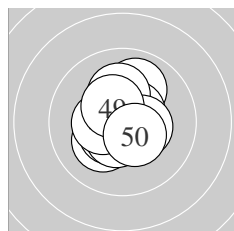

Serie 5:	10.2 *	10.5 *	10.0 ↑	10.5 *	10.5 *
	10.4 *	10.2 *	10.4 *	10.4 *	10.4 *
beste Teiler	105.5 (45.) 109.6 (44.) 118.2 (42.)				
Trefferlage	0.12 mm links, 0.16 mm hoch				
Streuwert	1.16, horizontal: 1.02, vertikal: 1.29				

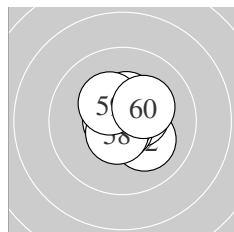

Serie 6:	10.4 *	10.1 ↘	10.7 *	10.6 *	10.5 *
	10.8 *	10.9 *	10.6 *	10.3 *	10.2 *
beste Teiler	8.0 (57.) 48.2 (56.) 60.0 (53.)				
Trefferlage	0.31 mm rechts, 0.19 mm hoch				
Streuwert	0.87, horizontal: 0.86, vertikal: 0.88				

Meyton Elektronik

ISSF AR Men Jun – Wertung – Junioren

StandNr: 111

Goncharenko, Denis #154

StartNr: 11

21. Januar 2018 9:53

RUS

QF – Schütze hat sich fürs Finale qualifiziert

Unterschrift des Schützen

Meyton Elektronik

Ergebnis:	596.6	(567)
Serien:	97.9 99.4 101.4 100.9 99.6 97.4	
Zähler:	28 31 1 0 0 0 0 0 0 0	
Innenzehner:	26	
weiteste:	503 (37), 480 (52), 446 (7)	
beste Teiler	48.8 (21.) 54.1 (26.) 62.2 (46.)	
Trefferlage	0.25 mm links, 0.19 mm hoch	
Streuwert	2.00, horizontal: 2.45, vertikal: 1.42	

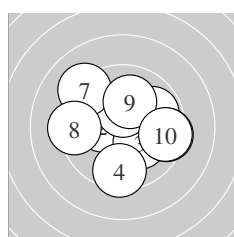
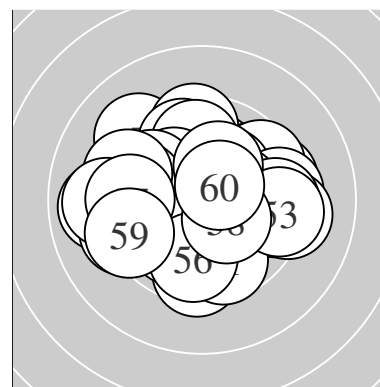

Serie 1:				
9.9 ↗	10.3 *	10.2 *	9.5 ↓	9.5 →
10.4 *	9.2 ↘	9.3 ←	10.1 ↑	9.5 →
beste Teiler	140.0 (6.)	173.8 (2.)	192.7 (3.)	
Trefferlage	0.26 mm rechts, 0.17 mm hoch			
Streuwert	2.32, horizontal: 2.67, vertikal: 1.91			

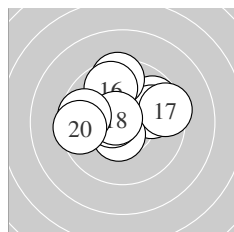

Serie 2:				
9.8 ↗	9.9 →	10.5 *	9.5 ↑	10.6 *
9.7 ↑	9.5 →	10.7 *	9.7 ←	9.5 ←
beste Teiler	66.7 (18.)	86.5 (15.)	108.1 (13.)	
Trefferlage	0.14 mm links, 0.95 mm hoch			
Streuwert	1.95, horizontal: 2.36, vertikal: 1.42			

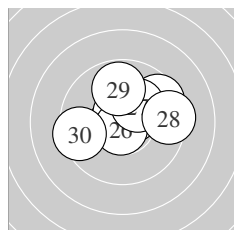

Serie 3:				
10.8 *	9.6 ↗	10.5 *	10.3 *	10.6 *
10.7 *	10.2 *	9.4 →	9.8 ↑	9.5 ←
beste Teiler	48.8 (21.)	54.1 (26.)	77.1 (25.)	
Trefferlage	0.43 mm rechts, 0.78 mm hoch			
Streuwert	1.66, horizontal: 2.05, vertikal: 1.14			

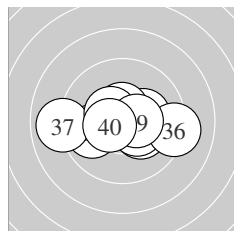

Serie 4:				
9.9 ←	10.2 *	10.2 *	10.4 *	10.6 *
9.2 →	8.9 ←	10.5 *	10.5 *	10.5 *
beste Teiler	100.2 (35.)	114.7 (40.)	117.0 (39.)	
Trefferlage	0.02 mm rechts, 0.18 mm tief			
Streuwert	1.90, horizontal: 2.60, vertikal: 0.69			

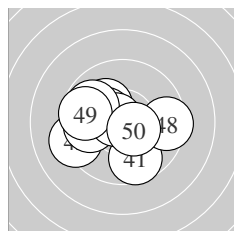

Serie 5:				
9.7 ↓	9.3 ←	10.2 *	10.3 *	9.9 ←
10.7 *	9.8 ↘	9.5 →	9.7 ←	10.5 *
beste Teiler	62.2 (46.)	110.6 (50.)	158.8 (44.)	
Trefferlage	1.00 mm links, 0.13 mm tief			
Streuwert	1.91, horizontal: 2.33, vertikal: 1.35			

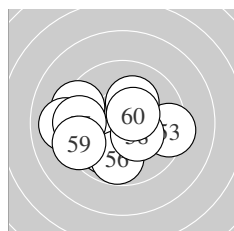

Serie 6:				
9.4 ↖	9.0 ←	9.4 →	10.0 ↙	10.2 *
9.8 ↓	9.5 ←	10.3 *	9.3 ←	10.5 *
beste Teiler	114.9 (60.)	155.4 (58.)	189.2 (55.)	
Trefferlage	1.08 mm links, 0.45 mm tief			
Streuwert	2.26, horizontal: 2.83, vertikal: 1.48			

Meyton Elektronik

ISSF AR Men Jun – Wertung – Junioren

StandNr: 113

Löschl, Michael #148

StartNr: 13

21. Januar 2018 9:42

NÖ

Unterschrift des Schützen

Meyton Elektronik

Ergebnis: **627.3** (598)^{QF}
 Serien: 104.9 105.7 103.8 104.4 104.0 104.5
 Zähler: 58 2 0 0 0 0 0 0 0
 Innenzehner: 53
 weiteste: 261 (27), 254 (28), 244 (26)
 beste Teiler 22.8 (8.) 37.4 (20.) 43.4 (58.)
 Trefferlage 0.17 mm rechts, 0.06 mm hoch
 Streuwert 0.97, horizontal: 1.05, vertikal: 0.88

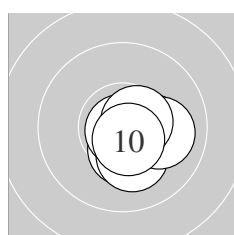
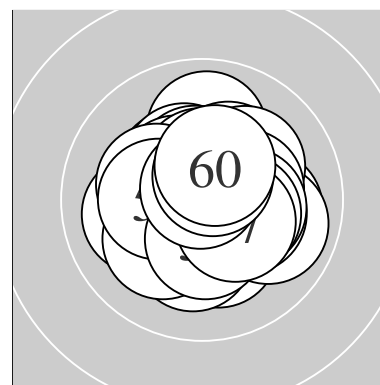

Serie 1:
 10.7 * 10.6 * 10.7 * 10.2 * 10.4 *
 10.2 * 10.0 → 10.9 * 10.6 * 10.6 *
 beste Teiler 22.8 (8.) 62.3 (1.) 63.1 (3.)
 Trefferlage 0.69 mm rechts, 0.60 mm tief
 Streuwert 0.68, horizontal: 0.76, vertikal: 0.60

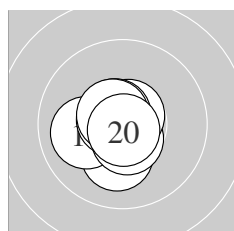

Serie 2:
 10.2 * 10.7 * 10.0 ← 10.6 * 10.7 *
 10.7 * 10.7 * 10.7 * 10.6 * 10.8 *
 beste Teiler 37.4 (20.) 52.1 (12.) 64.0 (17.)
 Trefferlage 0.43 mm links, 0.17 mm tief
 Streuwert 0.77, horizontal: 0.73, vertikal: 0.81

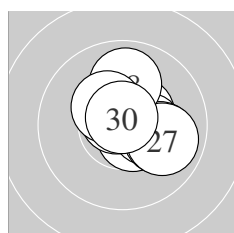

Serie 3:
 10.6 * 10.5 * 10.7 * 10.7 * 10.3 *
 10.0 → 9.9 → 9.9 ↑ 10.4 * 10.8 *
 beste Teiler 48.3 (30.) 60.3 (24.) 66.4 (23.)
 Trefferlage 0.65 mm rechts, 0.34 mm hoch
 Streuwert 1.09, horizontal: 1.15, vertikal: 1.04

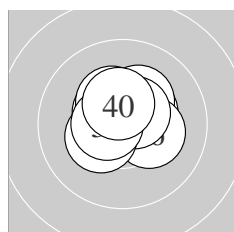

Serie 4:
 10.5 * 10.7 * 10.4 * 10.4 * 10.3 *
 10.3 * 10.5 * 10.3 * 10.6 * 10.4 *
 beste Teiler 68.1 (32.) 96.0 (39.) 101.1 (37.)
 Trefferlage 0.02 mm links, 0.49 mm hoch
 Streuwert 0.93, horizontal: 1.06, vertikal: 0.77

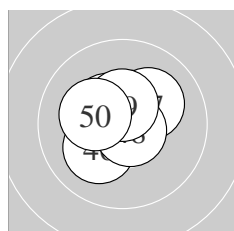

Serie 5:
 10.4 * 10.5 * 10.4 * 10.6 * 10.5 *
 10.1 ↙ 10.1 ↗ 10.7 * 10.5 * 10.2 *
 beste Teiler 61.8 (48.) 82.0 (44.) 108.6 (42.)
 Trefferlage 0.43 mm links, 0.37 mm hoch
 Streuwert 0.97, horizontal: 1.05, vertikal: 0.87

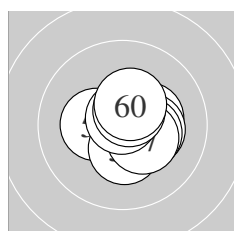

Serie 6:
 10.3 * 10.3 * 10.7 * 10.3 * 10.4 *
 10.3 * 10.4 * 10.8 * 10.6 * 10.4 *
 beste Teiler 43.4 (58.) 64.4 (53.) 98.4 (59.)
 Trefferlage 0.57 mm rechts, 0.03 mm tief
 Streuwert 0.91, horizontal: 0.99, vertikal: 0.81

Meyton Elektronik

QF – Schütze hat sich fürs Finale qualifiziert

Unterschrift des Schützen

Meyton Elektronik

Ergebnis:	618.8	(592) ^{QF}						
Serien:	103.1	102.1	103.7	103.9	103.4	102.6		
Zähler:	52	8	0	0	0	0	0	0
Innenzehner:	45							
weiteste:	470 (48), 323 (34), 317 (52)							
beste Teiler	7.0 (25.)	49.9 (51.)	54.2 (49.)					
Trefferlage	0.00 mm , 0.10 mm tief							
Streuwert	1.28, horizontal: 1.35, vertikal: 1.21							

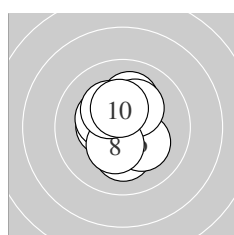
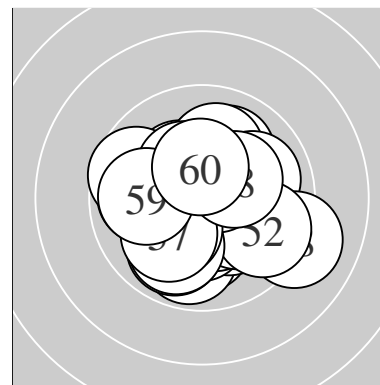

Serie 1:	10.4 *	10.1 ↑	10.6 *	10.2 *	10.3 *
	10.2 *	10.2 *	10.4 *	10.3 *	10.4 *
beste Teiler	100.1 (3.)	138.1 (1.)	147.8 (8.)		
Trefferlage	0.24 mm links, 0.31 mm hoch				
Streuwert	1.20, horizontal: 1.00, vertikal: 1.38				

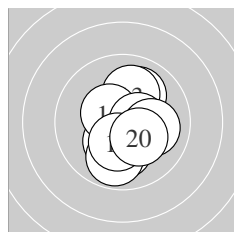

Serie 2:	10.3 *	10.0 ↗	10.1 ↑	10.1 ↓	10.5 *
	10.5 *	10.1 →	9.9 ↓	10.3 *	10.3 *
beste Teiler	119.0 (16.)	123.4 (15.)	159.1 (19.)		
Trefferlage	0.36 mm rechts, 0.44 mm tief				
Streuwert	1.41, horizontal: 1.08, vertikal: 1.67				

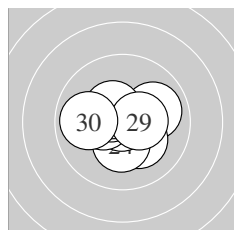

Serie 3:	10.0 →	10.6 *	10.2 *	10.3 *	10.9 *
	10.4 *	10.5 *	10.5 *	10.4 *	9.9 ←
beste Teiler	7.0 (25.)	97.9 (22.)	114.6 (27.)		
Trefferlage	0.18 mm links, 0.04 mm hoch				
Streuwert	1.21, horizontal: 1.47, vertikal: 0.88				

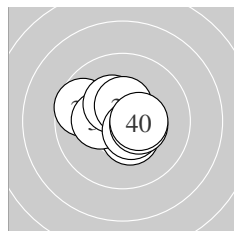

Serie 4:	10.7 *	10.6 *	10.4 *	9.7 ↖	10.3 *
	10.3 *	10.5 *	10.6 *	10.4 *	10.4 *
beste Teiler	55.1 (31.)	83.6 (32.)	99.0 (38.)		
Trefferlage	0.13 mm links, 0.19 mm hoch				
Streuwert	1.15, horizontal: 1.40, vertikal: 0.82				

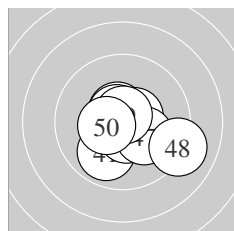

Serie 5:	9.9 ↙	10.7 *	10.6 *	10.6 *	10.6 *
	10.6 *	10.2 *	9.1 ↘	10.7 *	10.4 *
beste Teiler	54.2 (49.)	75.6 (42.)	79.6 (45.)		
Trefferlage	0.33 mm rechts, 0.35 mm tief				
Streuwert	1.43, horizontal: 1.66, vertikal: 1.14				

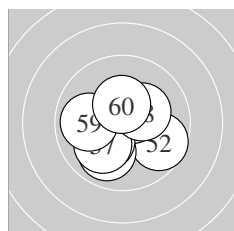

Serie 6:	10.8 *	9.7 ↘	10.6 *	10.7 *	9.9 ↙
	10.2 *	10.1 ↙	10.3 *	9.9 ←	10.4 *
beste Teiler	49.9 (51.)	65.8 (54.)	92.6 (53.)		
Trefferlage	0.18 mm links, 0.36 mm tief				
Streuwert	1.43, horizontal: 1.59, vertikal: 1.25				

Meyton Elektronik

QF – Schütze hat sich fürs Finale qualifiziert

Unterschrift des Schützen

Meyton Elektronik

Ergebnis: **612.8** (588)
 Serien: 100.8 103.0 100.8 103.5 104.2 100.5
 Zähler: 48 12 0 0 0 0 0 0 0
 Innenzehner: 37
 weiteste: 434 (2), 377 (27), 349 (11)
 beste Teiler 30.0 (31.) 53.7 (37.) 55.3 (33.)
 Trefferlage 0.24 mm links, 0.13 mm hoch
 Streuwert 1.46, horizontal: 1.42, vertikal: 1.50

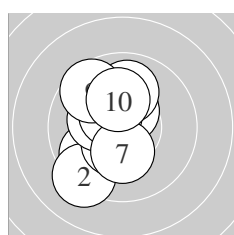
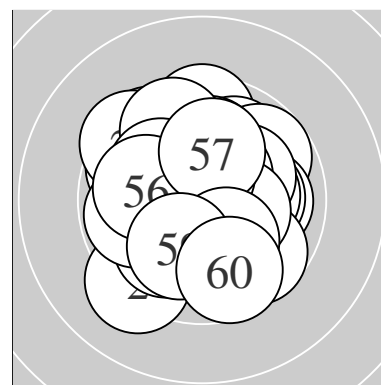

Serie 1:
 9.8 ↙ 9.2 ↙ 10.4 * 10.3 * 10.5 *
 10.5 * 10.3 * 10.0 ↑ 9.6 ↘ 10.2 *
 beste Teiler 118.0 (5.) 122.3 (6.) 135.6 (3.)
 Trefferlage 0.99 mm links, 0.13 mm hoch
 Streuwert 1.65, horizontal: 1.12, vertikal: 2.05

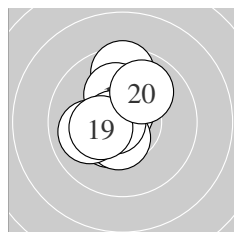

Serie 2:
 9.6 ↑ 10.7 * 10.7 * 10.2 * 10.4 *
 10.5 * 10.7 * 10.0 ← 10.3 * 9.9 ↗
 beste Teiler 61.0 (17.) 62.3 (13.) 74.2 (12.)
 Trefferlage 0.53 mm links, 0.56 mm hoch
 Streuwert 1.27, horizontal: 0.96, vertikal: 1.52

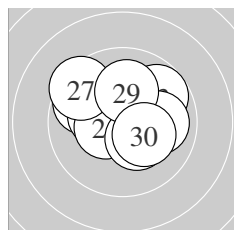

Serie 3:
 9.8 ↘ 10.3 * 9.8 ↗ 10.3 * 10.5 *
 10.3 * 9.4 ↘ 10.0 → 10.1 ↑ 10.3 *
 beste Teiler 122.1 (25.) 152.3 (26.) 170.8 (24.)
 Trefferlage 0.20 mm links, 0.69 mm hoch
 Streuwert 1.67, horizontal: 2.00, vertikal: 1.27

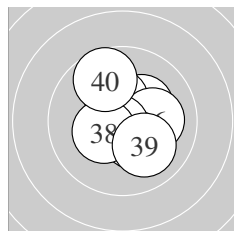

Serie 4:
 10.8 * 10.3 * 10.7 * 10.4 * 10.4 *
 10.1 → 10.7 * 10.4 * 10.0 ↘ 9.7 ↘
 beste Teiler 30.0 (31.) 53.7 (37.) 55.3 (33.)
 Trefferlage 0.23 mm rechts, 0.11 mm hoch
 Streuwert 1.27, horizontal: 1.17, vertikal: 1.36

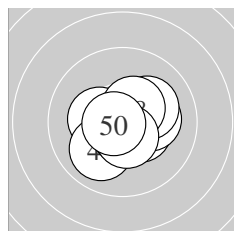

Serie 5:
 10.4 * 10.7 * 10.3 * 10.2 * 10.2 *
 10.0 ↙ 10.7 * 10.5 * 10.5 * 10.7 *
 beste Teiler 63.1 (50.) 68.0 (42.) 73.1 (47.)
 Trefferlage 0.14 mm rechts, 0.19 mm tief
 Streuwert 1.09, horizontal: 1.26, vertikal: 0.89

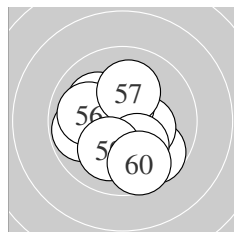

Serie 6:
 10.1 ↘ 9.7 ↘ 10.3 * 10.5 * 9.8 ←
 10.0 ← 10.1 ↑ 10.2 * 10.1 ↙ 9.7 ↘
 beste Teiler 109.0 (54.) 157.4 (53.) 199.9 (58.)
 Trefferlage 0.14 mm links, 0.50 mm tief
 Streuwert 1.70, horizontal: 1.72, vertikal: 1.68

Meyton Elektronik

Unterschrift des Schützen

Meyton Elektronik

Ergebnis:	613.2	(587)							
Serien:	101.9	102.2	103.1	102.1	101.0	102.9			
Zähler:	48	11	1	0	0	0	0	0	0
Innenzehner:	38								
weiteste:	545 (16), 428 (48), 362 (34)								
beste Teiler	23.4 (11.)	49.4 (57.)	68.1 (2.)						
Trefferlage	0.17 mm links, 0.40 mm hoch								
Streuwert	1.44, horizontal: 1.55, vertikal: 1.31								

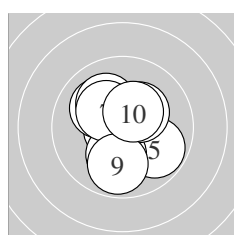
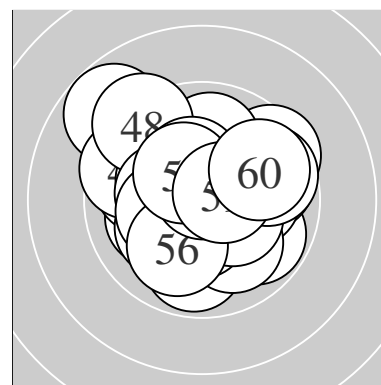

Serie 1:	10.2 *	10.7 *	10.1 ↖	10.1 ↖	9.8 ↘
	10.1 ↓	10.3 *	10.3 *	9.9 ↓	10.4 *
beste Teiler	68.1 (2.)	138.9 (10.)	164.9 (8.)		
Trefferlage	0.01 mm links, 0.12 mm tief				
Streuwert	1.50, horizontal: 1.32, vertikal: 1.66				

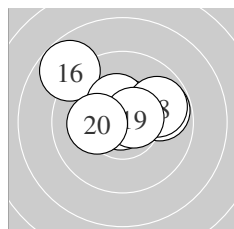

Serie 2:	10.9 *	10.5 *	9.8 →	10.6 *	10.6 *
	8.8 ↖	10.4 *	9.8 →	10.6 *	10.2 *
beste Teiler	23.4 (11.)	88.3 (19.)	93.1 (15.)		
Trefferlage	0.10 mm links, 1.04 mm hoch				
Streuwert	1.57, horizontal: 1.95, vertikal: 1.08				

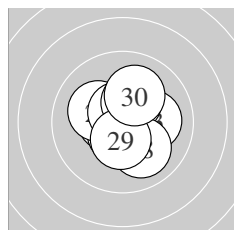

Serie 3:	10.5 *	10.3 *	10.1 →	10.6 *	10.2 *
	10.6 *	10.3 *	10.0 ↘	10.4 *	10.1 ↗
beste Teiler	81.4 (26.)	91.2 (24.)	111.5 (21.)		
Trefferlage	0.20 mm rechts, 0.01 mm tief				
Streuwert	1.24, horizontal: 1.19, vertikal: 1.29				

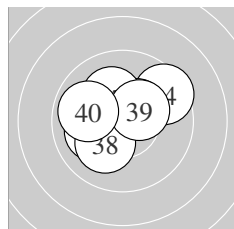

Serie 4:	10.1 ↖	10.6 *	10.4 *	9.5 →	10.5 *
	10.4 *	10.2 *	10.1 ↗	10.4 *	9.9 ↖
beste Teiler	89.0 (32.)	123.6 (35.)	136.7 (36.)		
Trefferlage	0.47 mm links, 0.45 mm hoch				
Streuwert	1.44, horizontal: 1.72, vertikal: 1.09				

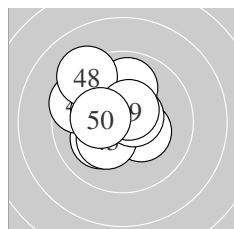

Serie 5:	10.3 *	10.1 ↖	10.3 *	10.6 *	9.6 ↖
	10.2 *	9.9 ↑	9.2 ↖	10.5 *	10.3 *
beste Teiler	90.7 (44.)	101.0 (49.)	154.7 (41.)		
Trefferlage	0.89 mm links, 0.66 mm hoch				
Streuwert	1.53, horizontal: 1.55, vertikal: 1.52				

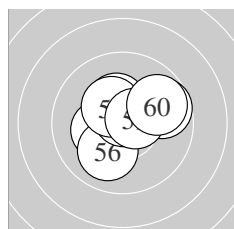

Serie 6:	10.5 *	10.5 *	10.3 *	9.7 →	10.3 *
	10.0 ↓	10.8 *	10.4 *	10.6 *	9.8 →
beste Teiler	49.4 (57.)	99.6 (59.)	116.7 (52.)		
Trefferlage	0.22 mm rechts, 0.39 mm hoch				
Streuwert	1.34, horizontal: 1.57, vertikal: 1.07				

Meyton Elektronik

Unterschrift des Schützen

Meyton Elektronik

Ergebnis:	618.5	(590)					
Serien:	102.9	103.3	102.4	102.8	103.2	103.9	
Zähler:	50	10	0	0	0	0	0
Innenzehner:	40						
weiteste:	329 (29), 327 (15), 301 (23)						
beste Teiler	6.7 (18.) 11.1 (1.) 14.2 (8.)						
Trefferlage	0.53 mm links, 0.34 mm hoch						
Streuwert	1.22, horizontal: 1.25, vertikal: 1.19						

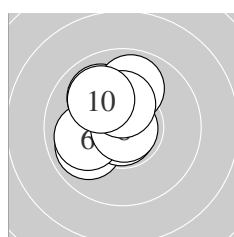
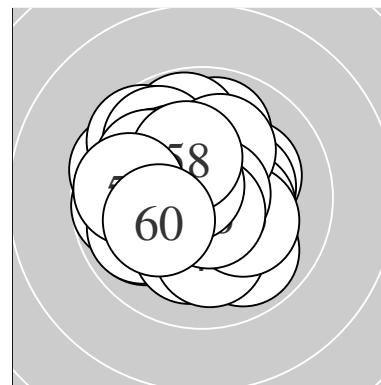

Serie 1:	10.9 *	10.2 *	10.0 ↘	9.9 ↙	10.8 *
	10.0 ←	9.9 ↑	10.9 *	10.3 *	10.0 ↘
beste Teiler	11.1 (1.) 14.2 (8.) 33.9 (5.)				
Trefferlage	0.81 mm links, 0.73 mm hoch				
Streuwert	1.19, horizontal: 1.03, vertikal: 1.33				

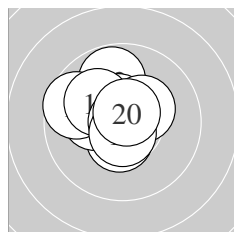

Serie 2:	10.5 *	9.8 ↑	10.5 *	10.2 *	9.6 ↖
	10.1 ↘	10.3 *	10.9 *	10.7 *	10.7 *
beste Teiler	6.7 (18.) 70.3 (20.) 72.0 (19.)				
Trefferlage	0.63 mm links, 0.63 mm hoch				
Streuwert	1.17, horizontal: 1.25, vertikal: 1.09				

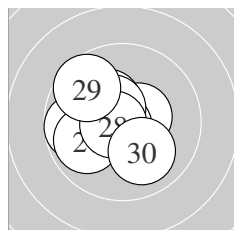

Serie 3:	10.5 *	10.8 *	9.7 ←	10.3 *	10.4 *
	10.5 *	9.9 ↙	10.7 *	9.6 ↘	10.0 ↘
beste Teiler	39.5 (22.) 64.0 (28.) 112.2 (21.)				
Trefferlage	0.91 mm links, 0.18 mm hoch				
Streuwert	1.33, horizontal: 1.41, vertikal: 1.23				

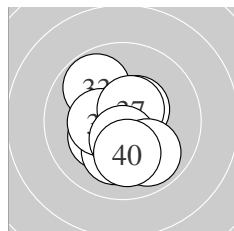

Serie 4:	10.3 *	10.5 *	9.8 ↘	10.1 ↓	10.6 *
	10.4 *	10.6 *	10.5 *	9.9 ↘	10.1 ↓
beste Teiler	81.3 (35.) 95.6 (37.) 119.0 (32.)				
Trefferlage	0.25 mm links, 0.48 mm tief				
Streuwert	1.31, horizontal: 1.12, vertikal: 1.47				

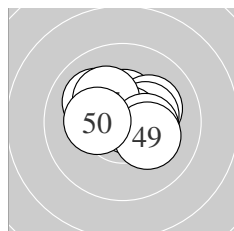

Serie 5:	10.4 *	10.4 *	10.2 *	10.3 *	10.8 *
	10.1 ↘	10.2 *	10.3 *	10.2 *	10.3 *
beste Teiler	35.8 (45.) 127.3 (42.) 140.4 (41.)				
Trefferlage	0.16 mm rechts, 0.56 mm hoch				
Streuwert	1.15, horizontal: 1.41, vertikal: 0.81				

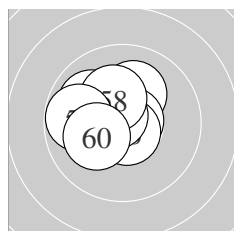

Serie 6:	10.0 ↘	10.1 ↑	10.7 *	10.6 *	10.8 *
	10.7 *	10.7 *	10.3 *	9.8 ←	10.2 *
beste Teiler	44.1 (55.) 52.4 (53.) 64.8 (56.)				
Trefferlage	0.77 mm links, 0.40 mm hoch				
Streuwert	1.07, horizontal: 1.17, vertikal: 0.95				

Meyton Elektronik

ISSF AR Men Jun – Wertung – Junioren

StandNr: 118

Riccardo, Ranzani #168

StartNr: 18

21. Januar 2018 9:33

ITA – TSN Veroli

Unterschrift des Schützen

Meyton Elektronik

Ergebnis: **624.5** (593)^{QF}
 Serien: 102.7 106.6 103.3 103.6 104.6 103.7
 Zähler: 53 7 0 0 0 0 0 0 0 0
 Innenzehner: 49
 weiteste: 389 (30), 332 (3), 315 (32)
 beste Teiler 17.7 (17.) 25.4 (48.) 29.1 (60.)
 Trefferlage 0.14 mm links, 0.29 mm tief
 Streuwert 1.11, horizontal: 1.26, vertikal: 0.94

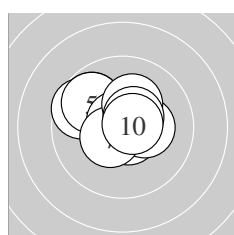
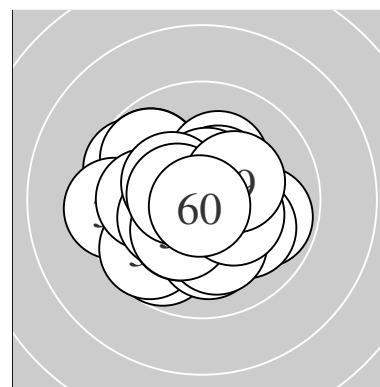

Serie 1:
 9.8 ↘ 10.7 * 9.6 ↘ 10.3 * 9.8 ↘
 10.7 * 10.5 * 10.2 * 10.5 * 10.6 *
 beste Teiler 60.1 (6.) 69.0 (2.) 76.8 (10.)
 Trefferlage 0.46 mm links, 0.68 mm hoch
 Streuwert 1.32, horizontal: 1.59, vertikal: 0.96

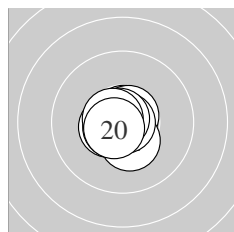

Serie 2:
 10.8 * 10.7 * 10.7 * 10.4 * 10.5 *
 10.6 * 10.9 * 10.8 * 10.6 * 10.6 *
 beste Teiler 17.7 (17.) 36.7 (18.) 47.6 (11.)
 Trefferlage 0.25 mm links, 0.16 mm tief
 Streuwert 0.55, horizontal: 0.53, vertikal: 0.56

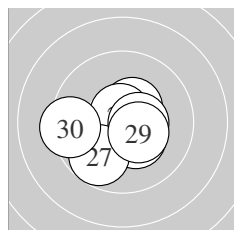

Serie 3:
 10.5 * 10.7 * 10.3 * 10.6 * 10.4 *
 10.7 * 9.8 ↙ 10.5 * 10.4 * 9.4 ←
 beste Teiler 55.2 (22.) 62.6 (26.) 89.5 (24.)
 Trefferlage 0.14 mm links, 0.51 mm tief
 Streuwert 1.32, horizontal: 1.59, vertikal: 0.98

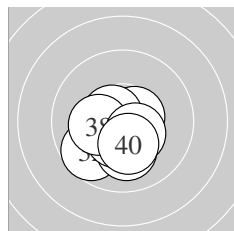

Serie 4:
 10.6 * 9.7 ↙ 10.7 * 10.6 * 10.6 *
 10.1 ↓ 10.4 * 10.2 * 10.4 * 10.3 *
 beste Teiler 67.1 (33.) 88.1 (35.) 89.7 (34.)
 Trefferlage 0.33 mm links, 0.91 mm tief
 Streuwert 0.99, horizontal: 1.06, vertikal: 0.91

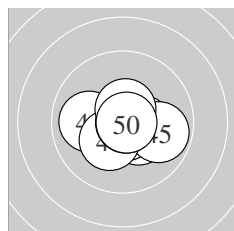

Serie 5:
 10.4 * 10.4 * 10.7 * 10.7 * 9.8 →
 10.0 ← 10.3 * 10.9 * 10.6 * 10.8 *
 beste Teiler 25.4 (48.) 29.2 (50.) 65.7 (44.)
 Trefferlage 0.28 mm rechts, 0.36 mm tief
 Streuwert 1.07, horizontal: 1.37, vertikal: 0.64

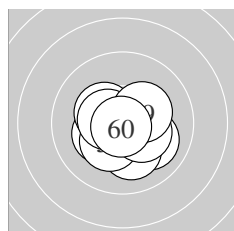

Serie 6:
 10.8 * 10.3 * 10.3 * 10.0 ↘ 10.1 ↓
 10.3 * 10.3 * 10.5 * 10.3 * 10.8 *
 beste Teiler 29.1 (60.) 32.3 (51.) 112.8 (58.)
 Trefferlage 0.02 mm rechts, 0.47 mm tief
 Streuwert 1.10, horizontal: 1.26, vertikal: 0.90

ISSF AR Men Jun – Wertung – Junioren

StandNr: 119

Shamakov, Grigorii #166

StartNr: 19

21. Januar 2018 9:50

RUS

QF – Schütze hat sich fürs Finale qualifiziert

Unterschrift des Schützen

Meyton Elektronik

Ergebnis: **620.4** (593)^{QF}
 Serien: 104.2 101.7 103.9 103.1 104.1 103.4
 Zähler: 53 7 0 0 0 0 0 0 0
 Innenzehner: 43
 weiteste: 424 (15), 338 (36), 318 (12)
 beste Teiler 12.1 (49.) 13.6 (46.) 37.1 (21.)
 Trefferlage 0.40 mm links, 0.10 mm hoch
 Streuwert 1.20, horizontal: 1.25, vertikal: 1.15

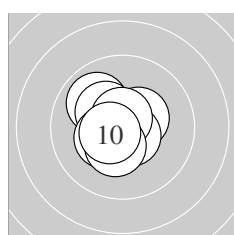
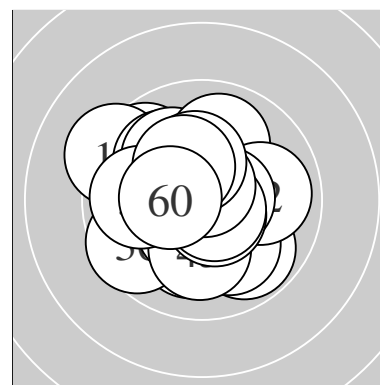

Serie 1:
 9.9 ↘ 10.5 * 10.4 * 10.6 * 10.3 *
 10.6 * 10.3 * 10.7 * 10.4 * 10.5 *
 beste Teiler 65.4 (8.) 82.1 (6.) 98.3 (4.)
 Trefferlage 0.58 mm links, 0.12 mm hoch
 Streuwert 0.94, horizontal: 0.90, vertikal: 0.98

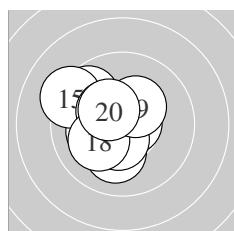

Serie 2:
 10.2 * 9.7 ↘ 10.7 * 10.1 ↓ 9.3 ↘
 10.4 * 10.5 * 10.1 ↙ 10.3 * 10.4 *
 beste Teiler 63.2 (13.) 115.9 (17.) 144.2 (20.)
 Trefferlage 1.12 mm links, 0.24 mm hoch
 Streuwert 1.42, horizontal: 1.42, vertikal: 1.41

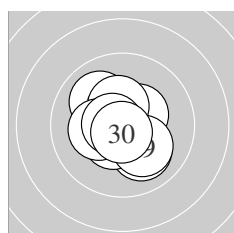

Serie 3:
 10.8 * 10.0 ↘ 10.0 ↘ 10.4 * 10.4 *
 10.5 * 10.3 * 10.7 * 10.1 ↘ 10.7 *
 beste Teiler 37.1 (21.) 52.6 (30.) 75.3 (28.)
 Trefferlage 0.09 mm links, 0.12 mm tief
 Streuwert 1.16, horizontal: 1.15, vertikal: 1.16

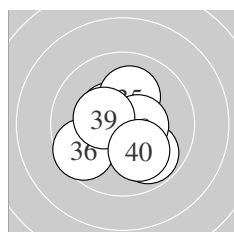

Serie 4:
 10.7 * 10.5 * 9.8 ↘ 10.8 * 10.1 ↑
 9.6 ↙ 10.6 * 10.5 * 10.4 * 10.1 ↘
 beste Teiler 50.3 (34.) 74.2 (31.) 77.8 (37.)
 Trefferlage 0.07 mm rechts, 0.19 mm tief
 Streuwert 1.38, horizontal: 1.41, vertikal: 1.35

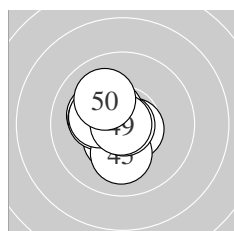

Serie 5:
 10.2 * 10.6 * 10.4 * 10.2 * 10.1 ↓
 10.9 * 10.5 * 10.2 * 10.9 * 10.1 ↘
 beste Teiler 12.1 (49.) 13.6 (46.) 85.0 (42.)
 Trefferlage 0.73 mm links, 0.04 mm hoch
 Streuwert 1.00, horizontal: 0.90, vertikal: 1.09

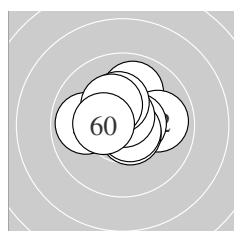

Serie 6:
 10.0 ↑ 9.9 → 10.6 * 10.6 * 10.7 *
 10.7 * 10.3 * 9.9 ← 10.3 * 10.4 *
 beste Teiler 62.6 (56.) 69.8 (55.) 86.5 (54.)
 Trefferlage 0.02 mm rechts, 0.56 mm hoch
 Streuwert 1.22, horizontal: 1.43, vertikal: 0.97

Meyton Elektronik

ISSF AR Men Jun – Wertung – Junioren

StandNr: 120

Shaner, William #178

StartNr: 20

21. Januar 2018 9:54

USA

QF – Schütze hat sich fürs Finale qualifiziert

Unterschrift des Schützen

Meyton Elektronik

Ergebnis:	618.8	(593) ^{QF}							
Serien:	100.9	103.9	103.7	103.2	103.3	103.8			
Zähler:	53	7	0	0	0	0	0	0	0
Innenzehner:	45								
weiteste:	367 (3), 314 (6), 285 (5)								
beste Teiler	9.2 (37.)	17.0 (53.)	37.6 (15.)						
Trefferlage	0.08 mm links, 0.07 mm tief								
Streuwert	1.25, horizontal: 1.28, vertikal: 1.21								

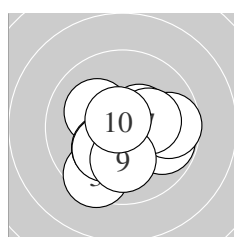
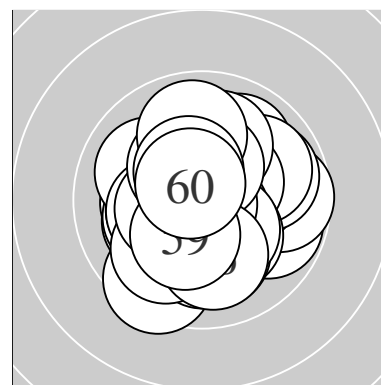

Serie 1:	10.4 *	10.1 ↖	9.5 ↙	10.2 *	9.8 ↘
	9.7 →	10.2 *	10.2 *	10.1 ↓	10.7 *
beste Teiler	58.8 (10.)	131.3 (1.)	179.7 (7.)		
Trefferlage	0.25 mm rechts, 0.64 mm tief				
Streuwert	1.63, horizontal: 1.83, vertikal: 1.41				

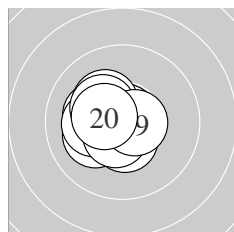

Serie 2:	10.2 *	10.1 ↙	10.2 *	10.5 *	10.8 *
	10.2 *	10.3 *	10.6 *	10.6 *	10.4 *
beste Teiler	37.6 (15.)	82.0 (19.)	97.1 (18.)		
Trefferlage	0.87 mm links, 0.04 mm hoch				
Streuwert	0.90, horizontal: 0.97, vertikal: 0.82				

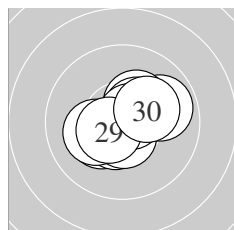

Serie 3:	9.9 →	10.3 *	10.3 *	10.5 *	10.5 *
	10.6 *	10.2 *	10.7 *	10.5 *	10.2 *
beste Teiler	66.0 (28.)	90.3 (26.)	107.1 (29.)		
Trefferlage	0.20 mm rechts, 0.02 mm hoch				
Streuwert	1.17, horizontal: 1.38, vertikal: 0.92				

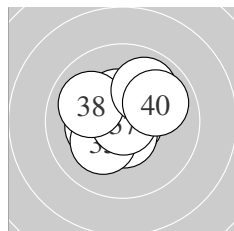

Serie 4:	10.3 *	10.2 *	10.8 *	10.6 *	10.2 *
	10.4 *	10.9 *	10.0 ↖	9.9 ↗	9.9 ↗
beste Teiler	9.2 (37.)	49.6 (33.)	94.5 (34.)		
Trefferlage	0.02 mm rechts, 0.40 mm hoch				
Streuwert	1.29, horizontal: 1.44, vertikal: 1.13				

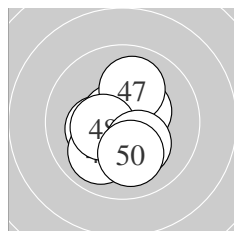

Serie 5:	10.3 *	10.6 *	10.6 *	10.7 *	10.4 *
	10.0 ↙	10.0 ↑	10.4 *	10.2 *	10.1 ↓
beste Teiler	64.6 (44.)	84.0 (42.)	86.0 (43.)		
Trefferlage	0.06 mm links, 0.43 mm tief				
Streuwert	1.20, horizontal: 1.09, vertikal: 1.31				

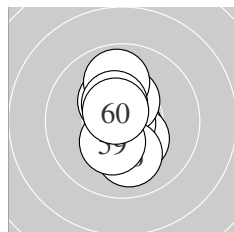

Serie 6:	10.7 *	10.3 *	10.9 *	10.3 *	10.4 *
	10.0 ↓	9.9 ↑	10.4 *	10.3 *	10.6 *
beste Teiler	17.0 (53.)	73.5 (51.)	82.4 (60.)		
Trefferlage	0.07 mm links, 0.16 mm hoch				
Streuwert	1.16, horizontal: 0.59, vertikal: 1.52				

Meyton Elektronik

ISSF AR Men Jun – Wertung – Junioren

StandNr: 121

Tichy, Radek #158

StartNr: 21

21. Januar 2018 9:48

CZE

QF – Schütze hat sich fürs Finale qualifiziert

Unterschrift des Schützen

Meyton Elektronik

Ergebnis:	614.1	(586)
Serien:	102.8 99.7	102.0 102.2 104.9 102.5
Zähler:	46 14 0 0 0 0 0 0 0	
Innenzehner:	36	
weiteste:	347 (38), 341 (12), 330 (54)	
beste Teiler	10.0 (41.) 36.4 (33.) 52.6 (29.)	
Trefferlage	0.20 mm links, 0.06 mm tief	
Streuwert	1.42, horizontal: 1.32, vertikal: 1.51	

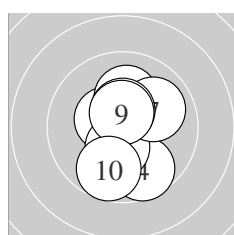
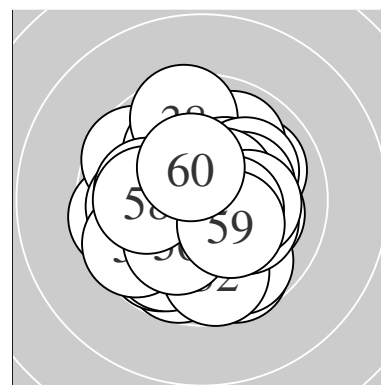

Serie 1:				
	10.7 *	10.7 *	10.5 *	9.7 ↘
	10.4 *	10.0 ↗	10.5 *	10.5 *
beste Teiler	56.5 (1.)	59.0 (2.)	101.2 (9.)	10.1 ↑
Trefferlage	0.07 mm rechts, 0.06 mm tief			
Streuwert	1.42, horizontal: 1.01, vertikal: 1.74			

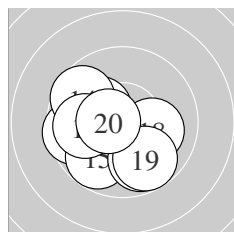

Serie 2:				
	10.2 *	9.6 ←	10.2 *	9.7 ↖
	9.8 ↘	9.9 ←	10.1 →	9.8 ↘
beste Teiler	100.1 (20.)	185.9 (11.)	197.1 (13.)	9.8 ↙
Trefferlage	0.81 mm links, 0.83 mm tief			
Streuwert	1.73, horizontal: 1.94, vertikal: 1.50			

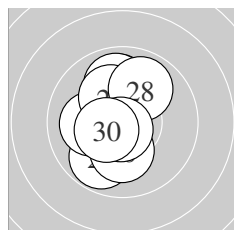

Serie 3:				
	10.0 ↑	10.7 *	9.8 ↙	9.9 ↑
	10.2 *	10.2 *	9.9 ↗	10.7 *
beste Teiler	52.6 (29.)	64.3 (22.)	124.7 (30.)	10.1 ←
Trefferlage	0.59 mm links, 0.36 mm hoch			
Streuwert	1.44, horizontal: 0.92, vertikal: 1.82			

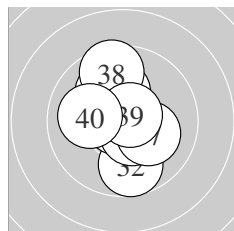

Serie 4:				
	10.5 *	9.7 ↘	10.8 *	10.1 ↖
	10.1 ↑	10.2 *	9.6 ↑	10.7 *
beste Teiler	36.4 (33.)	66.8 (39.)	105.3 (31.)	10.5 *
Trefferlage	0.19 mm links, 0.40 mm hoch			
Streuwert	1.50, horizontal: 1.13, vertikal: 1.80			

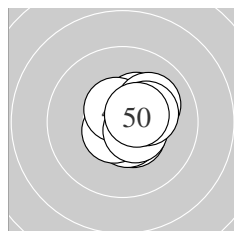

Serie 5:				
	10.9 *	10.5 *	10.6 *	10.3 *
	10.6 *	10.5 *	10.1 ↗	10.3 *
beste Teiler	10.0 (41.)	84.8 (45.)	97.0 (46.)	10.6 *
Trefferlage	0.62 mm rechts, 0.12 mm hoch			
Streuwert	0.83, horizontal: 0.81, vertikal: 0.85			

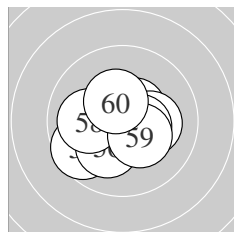

Serie 6:				
	10.5 *	10.2 *	10.2 *	9.6 ↙
	10.2 *	10.5 *	10.0 ←	10.3 *
beste Teiler	79.9 (55.)	109.6 (51.)	123.3 (57.)	10.6 *
Trefferlage	0.33 mm links, 0.38 mm tief			
Streuwert	1.35, horizontal: 1.57, vertikal: 1.09			

Meyton Elektronik

ISSF AR Men Jun – Wertung – Junioren

StandNr: 122

Roth, Lukas #147

StartNr: 22

21. Januar 2018 9:36

SUI

Unterschrift des Schützen

Meyton Elektronik

Ergebnis: **616.0** (590)

Serien: 103.2 102.9 102.3 102.3 102.0 103.3

Zähler: 50 10 0 0 0 0 0 0 0

Innenzehner: 39

weiteste: 360 (35), 323 (20), 318 (10)

beste Teiler 2.8 (52.) 18.8 (6.) 35.3 (17.)

Trefferlage 0.17 mm rechts, 0.33 mm hoch

Streuwert 1.33, horizontal: 1.27, vertikal: 1.39

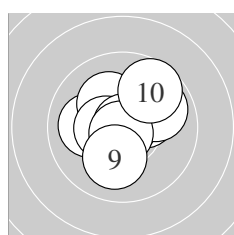
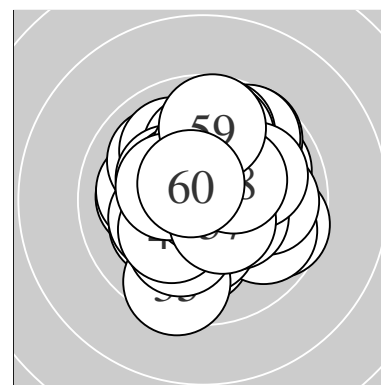

Serie 1:

10.0 ←	10.3 *	10.8 *	10.2 *	10.5 *
10.9 *	9.9 →	10.8 *	10.1 ↓	9.7 ↗

beste Teiler 18.8 (6.) 39.8 (3.) 43.4 (8.)

Trefferlage 0.04 mm rechts, 0.36 mm hoch

Streuwert 1.37, horizontal: 1.46, vertikal: 1.27

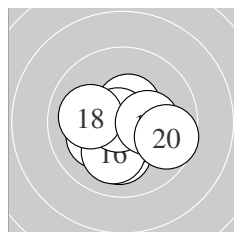

Serie 2:

10.1 ↓	10.6 *	10.6 *	10.2 *	10.5 *
10.1 ↓	10.8 *	10.0 ←	10.3 *	9.7 →

beste Teiler 35.3 (17.) 91.9 (13.) 97.4 (12.)

Trefferlage 0.13 mm rechts, 0.60 mm tief

Streuwert 1.32, horizontal: 1.55, vertikal: 1.03

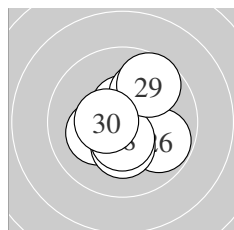

Serie 3:

10.5 *	10.5 *	10.0 ↗	10.2 *	10.3 *
9.8 ↘	10.3 *	10.5 *	9.7 ↗	10.5 *

beste Teiler 102.0 (22.) 113.2 (30.) 114.4 (21.)

Trefferlage 0.47 mm rechts, 0.10 mm hoch

Streuwert 1.40, horizontal: 1.32, vertikal: 1.47

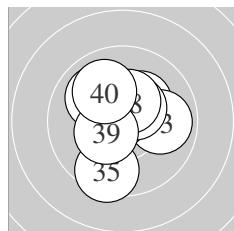

Serie 4:

10.3 *	10.0 ↖	9.9 →	10.5 *	9.5 ↓
10.8 *	10.5 *	10.4 *	10.4 *	10.0 ↖

beste Teiler 49.5 (36.) 122.6 (34.) 124.5 (37.)

Trefferlage 0.03 mm links, 0.45 mm hoch

Streuwert 1.49, horizontal: 1.36, vertikal: 1.60

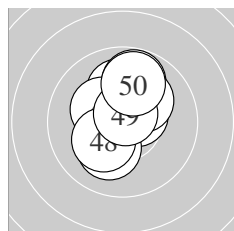

Serie 5:

10.1 ↑	10.3 *	9.8 ↑	10.5 *	10.3 *
10.1 ↓	10.2 *	10.2 *	10.7 *	9.8 ↑

beste Teiler 62.6 (49.) 108.3 (44.) 167.5 (45.)

Trefferlage 0.08 mm rechts, 0.96 mm hoch

Streuwert 1.30, horizontal: 1.01, vertikal: 1.53

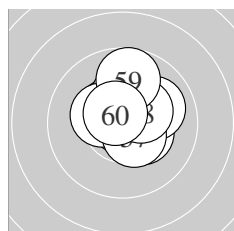

Serie 6:

10.5 *	10.9 *	10.3 *	10.2 *	10.3 *
10.0 →	10.5 *	10.3 *	9.7 ↑	10.6 *

beste Teiler 2.8 (52.) 85.0 (60.) 117.4 (57.)

Trefferlage 0.32 mm rechts, 0.73 mm hoch

Streuwert 1.12, horizontal: 1.10, vertikal: 1.14

ISSF AR Men Jun – Wertung – Junioren

StandNr: 123

Vasilyev, Alexander #152

StartNr: 23

21. Januar 2018 9:34

RUS

Unterschrift des Schützen

Meyton Elektronik

Ergebnis: **612.1** (587)

Serien: 99.1 102.2 103.1 102.8 103.8 101.1

Zähler: 47 13 0 0 0 0 0 0 0 0

Innenzehner: 37

weiteste: 484 (1), 455 (52), 451 (16)

beste Teiler 45.1 (23.) 49.2 (41.) 53.6 (33.)

Trefferlage 0.08 mm links, 0.08 mm hoch

Streuwert 1.53, horizontal: 1.73, vertikal: 1.31

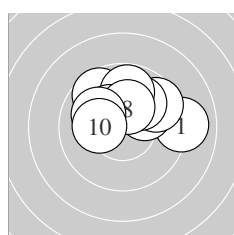
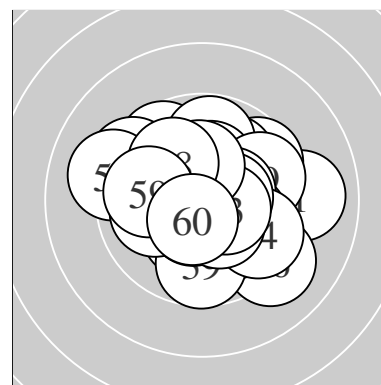

Serie 1:

9.0 →	10.1 ↗	9.7 ↘	9.6 ↗	10.0 ↗
9.8 ↑	10.3 *	10.3 *	10.1 ↖	10.2 *

beste Teiler 165.3 (7.) 170.9 (8.) 191.3 (10.)

Trefferlage 0.47 mm rechts, 1.47 mm hoch

Streuwert 1.74, horizontal: 2.28, vertikal: 0.91

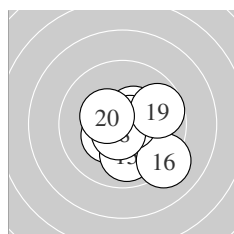

Serie 2:

10.4 *	10.5 *	10.2 *	10.6 *	10.0 ↓
9.1 ↘	10.7 *	10.6 *	9.7 →	10.4 *

beste Teiler 62.1 (17.) 76.9 (18.) 80.3 (14.)

Trefferlage 0.78 mm rechts, 0.48 mm tief

Streuwert 1.46, horizontal: 1.55, vertikal: 1.36

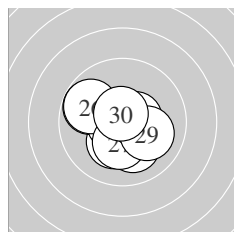

Serie 3:

10.3 *	9.8 ↖	10.8 *	10.1 ↓	10.7 *
9.8 ↖	10.3 *	10.5 *	10.1 ↘	10.7 *

beste Teiler 45.1 (23.) 70.4 (30.) 71.1 (25.)

Trefferlage 0.36 mm links, 0.29 mm tief

Streuwert 1.34, horizontal: 1.48, vertikal: 1.19

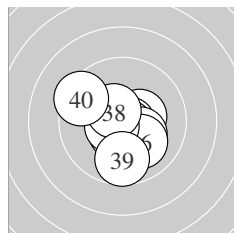

Serie 4:

10.4 *	10.5 *	10.7 *	10.7 *	10.2 *
10.1 ↘	10.6 *	10.5 *	9.7 ↓	9.4 ↖

beste Teiler 53.6 (33.) 61.6 (34.) 97.9 (37.)

Trefferlage 0.05 mm links, 0.49 mm tief

Streuwert 1.43, horizontal: 1.48, vertikal: 1.37

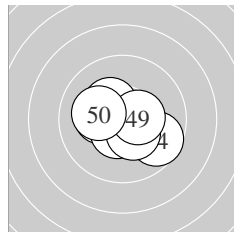

Serie 5:

10.8 *	10.3 *	10.7 *	9.7 ↘	10.5 *
10.3 *	10.6 *	10.4 *	10.4 *	10.1 ←

beste Teiler 49.2 (41.) 55.0 (43.) 88.5 (47.)

Trefferlage 0.02 mm rechts, 0.29 mm tief

Streuwert 1.18, horizontal: 1.45, vertikal: 0.83

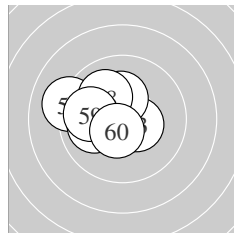

Serie 6:

10.2 *	9.1 ↖	10.5 *	10.4 *	10.0 ←
10.2 *	10.3 *	10.0 ↘	9.9 ←	10.5 *

beste Teiler 107.7 (60.) 123.4 (53.) 126.2 (54.)

Trefferlage 1.39 mm links, 0.61 mm hoch

Streuwert 1.29, horizontal: 1.52, vertikal: 1.01

Meyton Elektronik

ISSF AR Men Jun – Wertung – Junioren

StandNr: 124

Veloso, Marat Lleyton P #156

StartNr: 24

21. Januar 2018 9:48

SGP

Unterschrift des Schützen

Meyton Elektronik

Ergebnis:	608.9	(581)
Serien:	102.6 103.8 98.8	102.7 102.3 98.7
Zähler:	45 13 1 0 1 0 0 0 0 0	
Innenzehner:	37	
weiteste:	1085 (30), 552 (60), 442 (59)	
beste Teiler	35.4 (14.) 48.8 (37.) 67.1 (27.)	
Trefferlage	0.62 mm rechts, 0.06 mm hoch	
Streuwert	1.74, horizontal: 2.16, vertikal: 1.19	

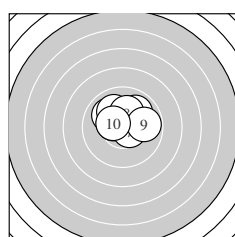
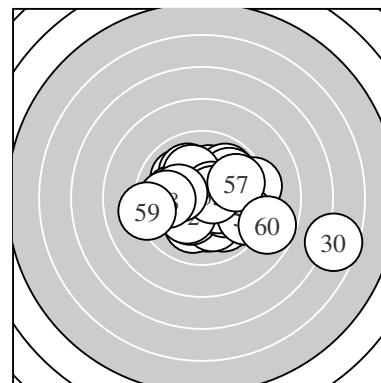

Serie 1:

9.9 ↗	10.0 ↘	10.7 *	10.6 *	10.4 *
10.0 ↘	10.6 *	10.2 *	9.8 →	10.4 *
beste Teiler	72.4 (3.)	86.8 (4.)	97.0 (7.)	
Trefferlage	0.01 mm rechts, 0.98 mm hoch			
Streuwert	1.18, horizontal: 1.46, vertikal: 0.82			

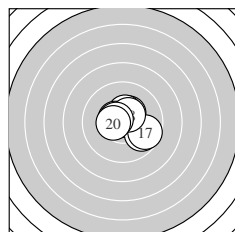

Serie 2:

10.4 *	10.6 *	10.4 *	10.8 *	10.5 *
9.8 ↘	9.7 ↘	10.5 *	10.6 *	10.5 *
beste Teiler	35.4 (14.)	81.0 (12.)	92.8 (19.)	
Trefferlage	0.39 mm rechts, 0.23 mm hoch			
Streuwert	1.20, horizontal: 1.40, vertikal: 0.97			

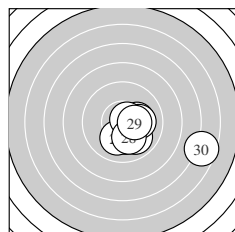

Serie 3:

10.6 *	10.2 *	10.2 *	10.1 ↓	9.9 ↘
10.1 →	10.7 *	10.1 ↓	10.3 *	6.6 →
beste Teiler	67.1 (27.)	98.4 (21.)	156.0 (29.)	
Trefferlage	1.94 mm rechts, 1.11 mm tief			
Streuwert	2.35, horizontal: 3.05, vertikal: 1.32			

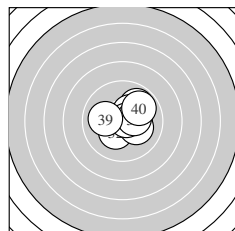

Serie 4:

9.9 ↗	10.3 *	10.3 *	10.6 *	10.2 *
10.4 *	10.8 *	10.3 *	10.0 ←	9.9 ↗
beste Teiler	48.8 (37.)	99.1 (34.)	149.8 (36.)	
Trefferlage	0.80 mm rechts, 0.33 mm hoch			
Streuwert	1.23, horizontal: 1.39, vertikal: 1.05			

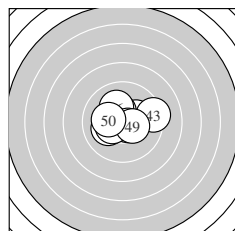

Serie 5:

10.6 *	10.2 *	9.3 →	10.4 *	10.1 ←
10.1 ↘	10.6 *	10.4 *	10.4 *	10.2 *
beste Teiler	78.1 (41.)	80.9 (47.)	138.1 (49.)	
Trefferlage	0.05 mm rechts, 0.28 mm hoch			
Streuwert	1.47, horizontal: 1.87, vertikal: 0.92			

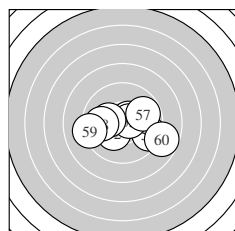

Serie 6:

9.9 →	10.3 *	10.6 *	9.5 ↘	10.6 *
10.2 *	9.8 →	9.9 ←	9.2 ←	8.7 →
beste Teiler	88.6 (55.)	96.2 (53.)	175.7 (52.)	
Trefferlage	0.53 mm rechts, 0.36 mm tief			
Streuwert	2.24, horizontal: 2.99, vertikal: 1.05			

Meyton Elektronik

ISSF AR Men Jun – Wertung – Junioren

StandNr: 125

Wadlegger, Stefan #150

StartNr: 25

21. Januar 2018 9:40

AUT

Unterschrift des Schützen

Meyton Elektronik

Ergebnis: **617.8** (588)
 Serien: 103.1 102.0 103.6 103.1 102.4 103.6
 Zähler: 48 12 0 0 0 0 0 0 0
 Innenzehner: 43
 weiteste: 364 (45), 359 (20), 344 (57)
 beste Teiler 35.0 (22.) 41.1 (40.) 44.1 (7.)
 Trefferlage 0.32 mm links, 0.06 mm tief
 Streuwert 1.32, horizontal: 1.61, vertikal: 0.95

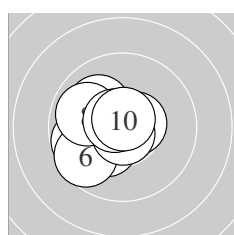
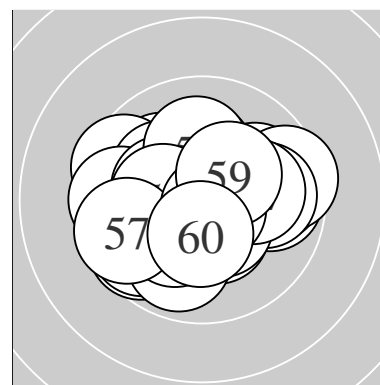

Serie 1:
 10.6 * 10.6 * 10.1 ↘ 9.8 ← 10.3 *
 9.6 ↙ 10.8 * 9.9 ↖ 10.7 * 10.7 *
 beste Teiler 44.1 (7.) 57.3 (10.) 72.4 (9.)
 Trefferlage 1.11 mm links, 0.13 mm tief
 Streuwert 1.17, horizontal: 1.27, vertikal: 1.07

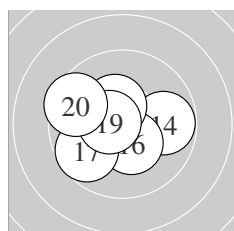

Serie 2:
 10.2 * 10.8 * 10.6 * 9.8 → 10.0 ↙
 10.4 * 9.7 ↙ 10.4 * 10.6 * 9.5 ↖
 beste Teiler 44.1 (12.) 94.0 (19.) 96.0 (13.)
 Trefferlage 0.72 mm links, 0.30 mm tief
 Streuwert 1.49, horizontal: 1.81, vertikal: 1.07

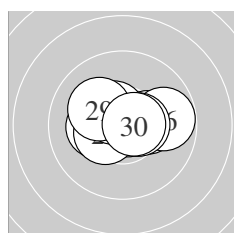

Serie 3:
 10.4 * 10.8 * 10.2 * 10.4 * 10.2 *
 9.8 → 10.5 * 10.5 * 10.2 * 10.6 *
 beste Teiler 35.0 (22.) 80.2 (30.) 107.6 (28.)
 Trefferlage 0.02 mm rechts, 0.18 mm hoch
 Streuwert 1.18, horizontal: 1.60, vertikal: 0.50

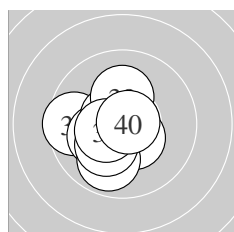

Serie 4:
 9.6 ← 10.2 * 10.6 * 10.5 * 10.6 *
 9.9 ↘ 10.2 * 10.2 * 10.5 * 10.8 *
 beste Teiler 41.1 (40.) 85.2 (33.) 89.8 (35.)
 Trefferlage 0.81 mm links, 0.45 mm tief
 Streuwert 1.20, horizontal: 1.20, vertikal: 1.19

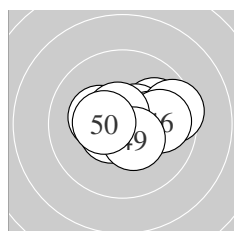

Serie 5:
 10.0 → 10.5 * 10.2 * 10.3 * 9.5 →
 9.9 → 10.6 * 10.6 * 10.4 * 10.4 *
 beste Teiler 80.0 (47.) 96.2 (48.) 108.4 (42.)
 Trefferlage 0.78 mm rechts, 0.25 mm hoch
 Streuwert 1.33, horizontal: 1.77, vertikal: 0.65

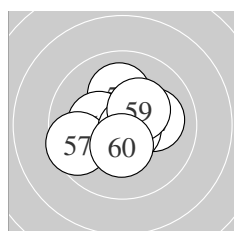

Serie 6:
 10.6 * 10.1 → 10.8 * 10.1 ↑ 10.7 *
 10.3 * 9.6 ↙ 10.7 * 10.3 * 10.4 *
 beste Teiler 49.0 (53.) 51.2 (55.) 59.4 (58.)
 Trefferlage 0.10 mm links, 0.03 mm hoch
 Streuwert 1.30, horizontal: 1.48, vertikal: 1.08

Meyton Elektronik

ISSF AR Men Jun – Wertung – Junioren

StandNr: 126

Firmapaz, Facundo #146

StartNr: 26

21. Januar 2018 9:42

ARG

Unterschrift des Schützen

Meyton Elektronik

Ergebnis: **598.5** (572)

Serien: 101.8 98.6 101.2 100.7 100.2 96.0

Zähler: 36 21 2 1 0 0 0 0 0 0

Innenzehner: 25

weiteste: 781 (51), 542 (52), 526 (19)

beste Teiler 62.6 (29.) 62.6 (36.) 77.4 (33.)

Trefferlage 0.15 mm rechts, 0.21 mm hoch

Streuwert 1.97, horizontal: 2.33, vertikal: 1.52

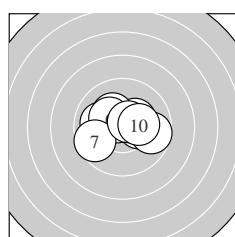
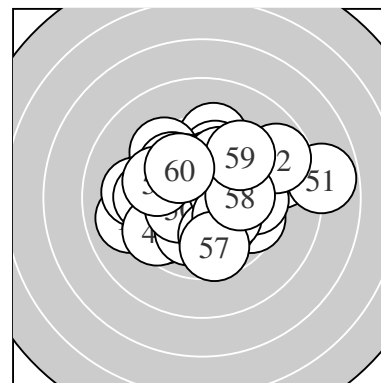

Serie 1:

10.3 *	10.3 *	10.6 *	10.0 ←	10.2 *
10.3 *	9.6 ←	10.6 *	9.7 →	10.2 *

beste Teiler 82.0 (3.) 84.1 (8.) 158.3 (1.)

Trefferlage 0.01 mm rechts, 0.30 mm hoch

Streuwert 1.53, horizontal: 1.99, vertikal: 0.84

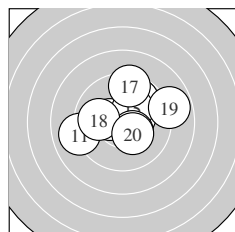

Serie 2:

9.0 ←	10.4 *	9.8 ↗	10.4 *	10.2 *
10.4 *	9.4 ↑	9.9 ←	8.8 →	10.3 *

beste Teiler 141.7 (12.) 144.8 (14.) 146.4 (16.)

Trefferlage 0.33 mm rechts, 0.68 mm hoch

Streuwert 2.21, horizontal: 2.64, vertikal: 1.68

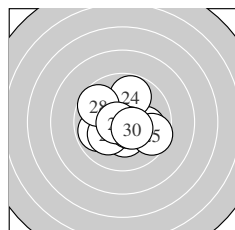

Serie 3:

10.3 *	10.0 →	9.9 ←	9.8 ↑	9.6 →
10.1 ←	10.6 *	9.7 ↘	10.7 *	10.5 *

beste Teiler 62.6 (29.) 94.4 (27.) 120.6 (30.)

Trefferlage 0.09 mm rechts, 0.23 mm tief

Streuwert 1.69, horizontal: 1.94, vertikal: 1.40

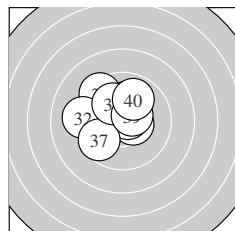

Serie 4:

9.4 ↘	9.2 ←	10.6 *	10.5 *	10.1 ↑
10.7 *	9.7 ←	10.1 ↘	10.5 *	9.9 ↑

beste Teiler 62.6 (36.) 77.4 (33.) 117.0 (34.)

Trefferlage 0.60 mm links, 0.88 mm hoch

Streuwert 1.69, horizontal: 1.89, vertikal: 1.47

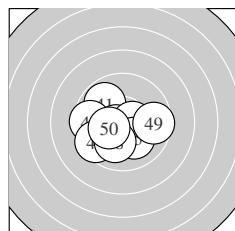

Serie 5:

9.8 ↘	10.6 *	10.2 *	10.5 *	10.1 ↓
9.6 ←	9.5 ←	10.0 ↓	9.6 →	10.3 *

beste Teiler 81.8 (42.) 106.0 (44.) 159.4 (50.)

Trefferlage 0.66 mm links, 0.67 mm tief

Streuwert 1.71, horizontal: 2.05, vertikal: 1.29

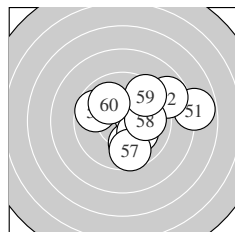

Serie 6:

7.8 →	8.8 ↗	9.7 ↘	10.0 ↓	10.4 *
10.1 ↘	9.7 ↓	10.0 →	9.5 ↗	10.0 ↘

beste Teiler 144.2 (55.) 201.6 (56.) 241.2 (60.)

Trefferlage 1.75 mm rechts, 0.34 mm hoch

Streuwert 2.54, horizontal: 2.98, vertikal: 2.01

ISSF AR Men Jun – Wertung – Junioren

StandNr: 127

Kuen, Johannes #199

StartNr: 27

21. Januar 2018 9:33

T – SG Matri

Unterschrift des Schützen

Meyton Elektronik

Ergebnis: **598.6** (571)
 Serien: 100.2 97.1 101.1 101.8 97.9 100.5
 Zähler: 34 23 3 0 0 0 0 0 0 0
 Innenzehner: 28
 weiteste: 746 (44), 534 (13), 510 (51)
 beste Teiler 17.4 (32.) 51.6 (22.) 52.6 (35.)
 Trefferlage 0.26 mm rechts, 0.09 mm hoch
 Streuwert 2.02, horizontal: 2.42, vertikal: 1.53

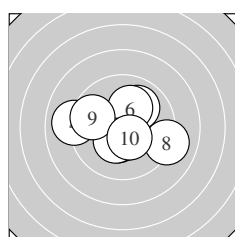
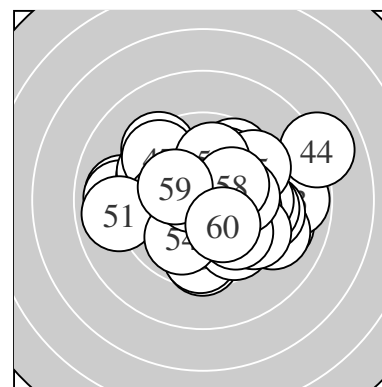

Serie 1:
 10.4 * 10.6 * 10.0 ↗ 9.0 ← 10.5 *
 10.1 ↗ 10.3 * 9.1 → 9.7 ↖ 10.5 *
 beste Teiler 77.0 (2.) 114.0 (5.) 123.9 (10.)
 Trefferlage 0.16 mm links, 0.15 mm tief
 Streuwert 2.01, horizontal: 2.50, vertikal: 1.37

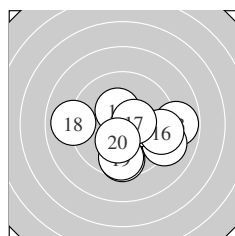

Serie 2:
 10.4 * 9.6 ↓ 8.8 → 9.1 → 10.4 *
 9.4 → 10.5 * 9.0 ← 9.6 ↓ 10.3 *
 beste Teiler 116.2 (17.) 135.2 (15.) 145.2 (11.)
 Trefferlage 0.97 mm rechts, 0.95 mm tief
 Streuwert 2.39, horizontal: 2.97, vertikal: 1.61

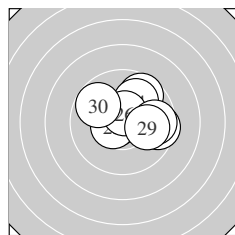

Serie 3:
 10.7 * 10.7 * 9.7 ↗ 10.0 ↗ 10.5 *
 10.6 * 9.5 → 9.7 → 9.9 → 9.8 ↖
 beste Teiler 51.6 (22.) 64.5 (21.) 90.4 (26.)
 Trefferlage 0.87 mm rechts, 0.61 mm hoch
 Streuwert 1.60, horizontal: 1.93, vertikal: 1.16

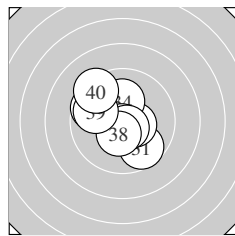

Serie 4:
 9.7 ↘ 10.9 * 10.5 * 10.2 * 10.7 *
 9.7 ↖ 10.6 * 10.4 * 9.8 ↖ 9.3 ↖
 beste Teiler 17.4 (32.) 52.6 (35.) 77.6 (37.)
 Trefferlage 0.52 mm links, 0.18 mm hoch
 Streuwert 1.67, horizontal: 1.69, vertikal: 1.65

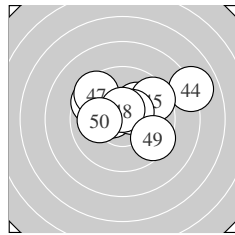

Serie 5:
 9.6 ↖ 10.5 * 10.2 * 8.0 → 9.5 ↗
 10.5 * 9.5 ↖ 10.6 * 9.5 ↘ 10.0 ←
 beste Teiler 92.0 (48.) 114.4 (42.) 115.2 (46.)
 Trefferlage 0.62 mm rechts, 1.05 mm hoch
 Streuwert 2.40, horizontal: 3.09, vertikal: 1.42

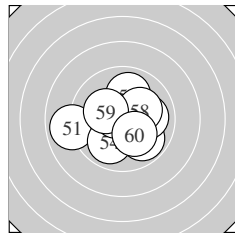

Serie 6:
 8.9 ← 10.5 * 9.9 ↘ 9.9 ↗ 10.7 *
 10.0 ↗ 10.0 → 10.2 * 10.2 * 10.2 *
 beste Teiler 72.0 (55.) 106.6 (52.) 184.3 (59.)
 Trefferlage 0.19 mm links, 0.20 mm tief
 Streuwert 1.88, horizontal: 2.24, vertikal: 1.44

Meyton Elektronik

ISSF AR Men Jun – Wertung – Junioren

StandNr: 128

Rohrbasser, Ludovic #179

StartNr: 28

21. Januar 2018 9:56

SUI

Unterschrift des Schützen

Meyton Elektronik

Ergebnis: **613.1** (584)
 Serien: 103.3 101.9 102.0 103.5 100.7 101.7
 Zähler: 44 16 0 0 0 0 0 0 0 0
 Innenzehner: 36
 weiteste: 421 (24), 345 (34), 342 (18)
 beste Teiler 28.4 (2.) 46.1 (3.) 53.5 (16.)
 Trefferlage 0.28 mm rechts, 0.21 mm tief
 Streuwert 1.44, horizontal: 1.78, vertikal: 0.98

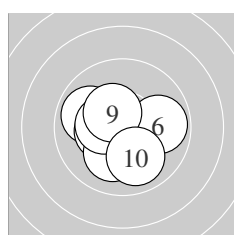
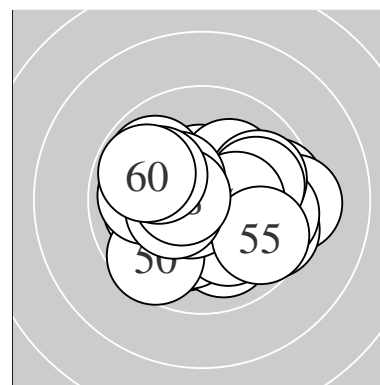

Serie 1:
 10.6 * 10.8 * 10.8 * 9.9 ↖ 10.4 *
 9.9 → 10.1 ↙ 10.4 * 10.4 * 10.0 ↘
 beste Teiler 28.4 (2.) 46.1 (3.) 87.4 (1.)
 Trefferlage 0.42 mm links, 0.22 mm tief
 Streuwert 1.28, horizontal: 1.46, vertikal: 1.08

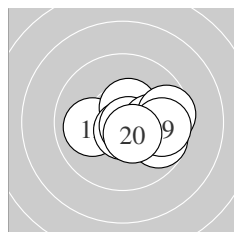

Serie 2:
 10.4 * 10.0 ← 9.7 ↘ 10.5 * 10.7 *
 10.7 * 10.1 → 9.6 → 9.7 → 10.5 *
 beste Teiler 53.5 (16.) 63.0 (15.) 117.0 (20.)
 Trefferlage 1.20 mm rechts, 0.28 mm tief
 Streuwert 1.31, horizontal: 1.71, vertikal: 0.69

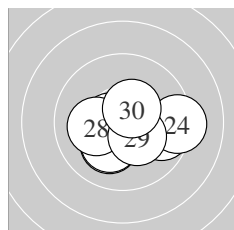

Serie 3:
 10.2 * 9.7 → 10.4 * 9.3 → 10.7 *
 10.6 * 10.2 * 10.1 ← 10.3 * 10.5 *
 beste Teiler 57.4 (25.) 92.0 (26.) 125.3 (30.)
 Trefferlage 0.49 mm rechts, 0.56 mm tief
 Streuwert 1.49, horizontal: 1.95, vertikal: 0.80

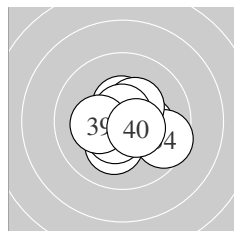

Serie 4:
 10.2 * 10.3 * 10.5 * 9.6 ↘ 10.4 *
 10.6 * 10.7 * 10.5 * 10.2 * 10.5 *
 beste Teiler 59.2 (37.) 86.4 (36.) 116.7 (40.)
 Trefferlage 0.29 mm rechts, 0.28 mm tief
 Streuwert 1.24, horizontal: 1.44, vertikal: 1.01

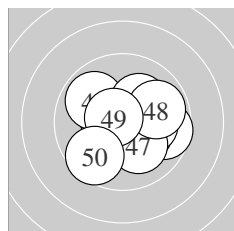

Serie 5:
 9.7 → 10.4 * 10.2 * 10.1 → 9.9 ↖
 10.2 * 10.1 ↘ 9.9 → 10.6 * 9.6 ↙
 beste Teiler 76.0 (49.) 130.5 (42.) 178.5 (43.)
 Trefferlage 0.56 mm rechts, 0.09 mm tief
 Streuwert 1.68, horizontal: 1.94, vertikal: 1.37

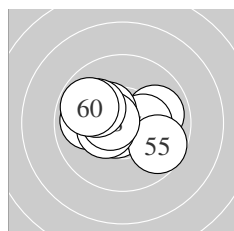

Serie 6:
 9.9 → 10.7 * 9.9 ← 10.3 * 9.7 ↖
 10.4 * 10.4 * 10.6 * 10.0 ↖ 9.8 ↖
 beste Teiler 68.7 (52.) 95.1 (58.) 136.9 (57.)
 Trefferlage 0.42 mm links, 0.17 mm hoch
 Streuwert 1.53, horizontal: 1.98, vertikal: 0.88

Meyton Elektronik

ISSF AR Men Jun – Wertung – Junioren

StandNr: 129

Zmatlo, Matej #149

StartNr: 29

21. Januar 2018 9:35

CZE

Unterschrift des Schützen

Meyton Elektronik

Ergebnis: **609.6** (580)
 Serien: 101.0 102.2 100.8 102.2 102.7 100.7
 Zähler: 42 16 2 0 0 0 0 0 0 0
 Innenzehner: 35
 weiteste: 592 (54), 570 (47), 425 (21)
 beste Teiler 52.9 (16.) 53.7 (51.) 55.4 (42.)
 Trefferlage 0.13 mm rechts, 0.03 mm hoch
 Streuwert 1.61, horizontal: 1.99, vertikal: 1.12

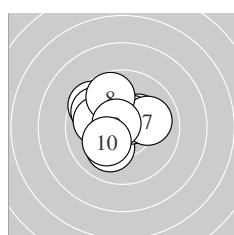
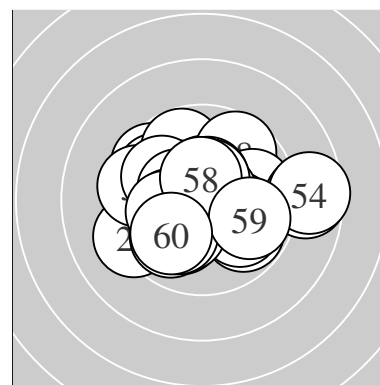

Serie 1:
 10.3 * 9.6 ↘ 10.1 ✓ 9.8 ↘ 10.0 ←
 10.5 * 10.0 → 9.8 ↘ 10.7 * 10.2 *
 beste Teiler 65.0 (9.) 101.1 (6.) 162.4 (1.)
 Trefferlage 0.73 mm links, 0.60 mm hoch
 Streuwert 1.56, horizontal: 1.72, vertikal: 1.38

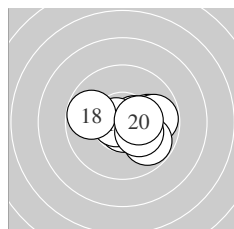

Serie 2:
 10.3 * 10.0 → 9.8 → 9.8 ↘ 10.5 *
 10.7 * 10.7 * 9.8 ← 10.2 * 10.4 *
 beste Teiler 52.9 (16.) 59.0 (17.) 109.4 (15.)
 Trefferlage 0.98 mm rechts, 0.16 mm tief
 Streuwert 1.30, horizontal: 1.70, vertikal: 0.71

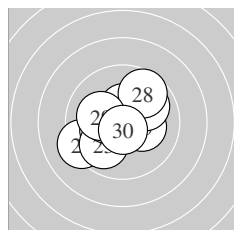

Serie 3:
 9.3 ← 10.2 * 9.9 ✓ 10.4 * 10.2 *
 10.4 * 9.9 ↗ 9.7 ↗ 10.1 ← 10.7 *
 beste Teiler 71.0 (30.) 129.3 (26.) 145.9 (24.)
 Trefferlage 0.47 mm links, 0.03 mm hoch
 Streuwert 1.75, horizontal: 1.96, vertikal: 1.51

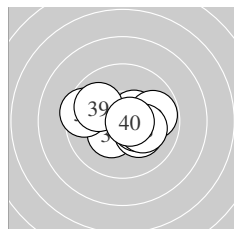

Serie 4:
 10.6 * 10.5 * 9.8 → 10.4 * 9.5 ←
 10.2 * 10.4 * 10.2 * 9.9 ↘ 10.7 *
 beste Teiler 66.2 (40.) 99.0 (31.) 119.5 (32.)
 Trefferlage 0.13 mm rechts, 0.02 mm tief
 Streuwert 1.52, horizontal: 1.99, vertikal: 0.82

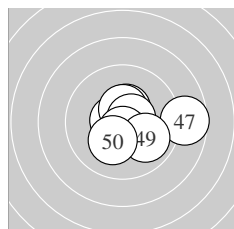

Serie 5:
 10.5 * 10.7 * 10.6 * 10.4 * 10.5 *
 10.6 * 8.7 → 10.6 * 9.9 ↘ 10.2 *
 beste Teiler 55.4 (42.) 78.6 (43.) 81.0 (48.)
 Trefferlage 0.76 mm rechts, 0.03 mm tief
 Streuwert 1.55, horizontal: 1.92, vertikal: 1.06

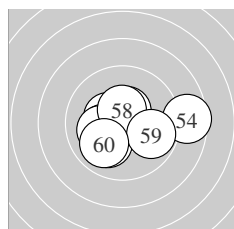

Serie 6:
 10.7 * 10.4 * 10.2 * 8.6 → 10.0 ✓
 10.1 ← 10.5 * 10.5 * 9.8 → 9.9 ✓
 beste Teiler 53.7 (51.) 117.0 (57.) 122.2 (58.)
 Trefferlage 0.11 mm rechts, 0.22 mm tief
 Streuwert 1.92, horizontal: 2.48, vertikal: 1.12

Meyton Elektronik

ISSF AR Men Jun – Wertung – Junioren

StandNr: 130

Henchoz, Valentin #165

StartNr: 30

21. Januar 2018 9:51

SUI

Unterschrift des Schützen

Meyton Elektronik