

Ergebnis:	619.3	(594) ^{QF}							
Serien:	104.1	104.7	102.6	103.2	101.9	102.8			
Zähler:	54	6	0	0	0	0	0	0	0
Innenzehner:	43								
weiteste:	423 (46), 353 (25), 313 (60)								
beste Teiler	56.6 (7.)	58.0 (14.)	58.8 (11.)						
Trefferlage	0.05 mm rechts, 0.14 mm hoch								
Streuwert	1.24, horizontal: 1.40, vertikal: 1.06								

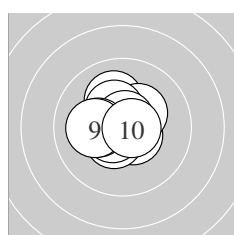

Serie 1:	10.5 *	10.1 ↗	10.3 *	10.5 *	10.6 *
	10.4 *	10.7 *	10.2 *	10.1 ←	10.7 *
beste Teiler	56.6 (7.)	68.3 (10.)	88.8 (5.)		
Trefferlage	0.38 mm links, 0.28 mm hoch				
Streuwert	1.02, horizontal: 1.09, vertikal: 0.95				

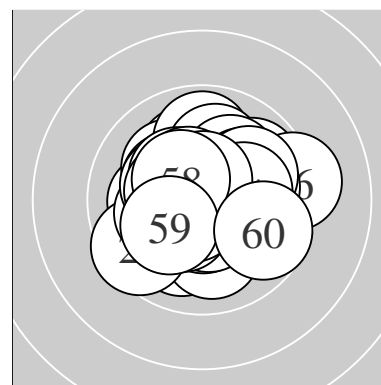
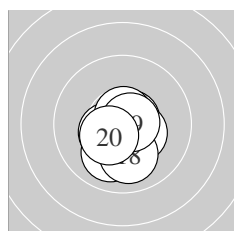

Serie 2:	10.7 *	10.4 *	10.7 *	10.7 *	10.0 ↘
	10.4 *	10.7 *	10.0 ↓	10.7 *	10.4 *
beste Teiler	58.0 (14.)	58.8 (11.)	60.4 (19.)		
Trefferlage	0.01 mm links, 0.55 mm tief				
Streuwert	0.91, horizontal: 0.80, vertikal: 1.01				

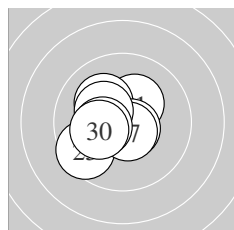

Serie 3:	10.3 *	10.4 *	10.3 *	10.1 ↘	9.5 ↘
	10.6 *	10.6 *	10.3 *	10.3 *	10.2 *
beste Teiler	79.2 (26.)	81.4 (27.)	127.9 (22.)		
Trefferlage	0.95 mm links, 0.10 mm hoch				
Streuwert	1.17, horizontal: 1.20, vertikal: 1.14				

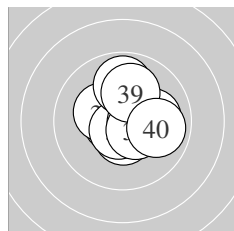

Serie 4:	10.7 *	10.3 *	10.5 *	10.7 *	10.5 *
	10.1 →	9.9 ↑	10.5 *	10.1 ↑	9.9 →
beste Teiler	72.9 (34.)	75.5 (31.)	107.1 (35.)		
Trefferlage	0.49 mm rechts, 0.26 mm hoch				
Streuwert	1.26, horizontal: 1.27, vertikal: 1.26				

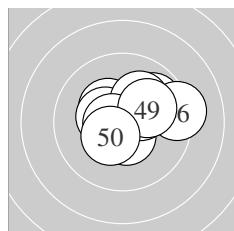

Serie 5:	10.5 *	9.9 ↗	10.3 *	10.3 *	10.4 *
	9.3 →	10.1 ↗	10.6 *	10.1 →	10.4 *
beste Teiler	79.5 (48.)	109.2 (41.)	138.5 (45.)		
Trefferlage	0.70 mm rechts, 0.51 mm hoch				
Streuwert	1.44, horizontal: 1.79, vertikal: 0.96				

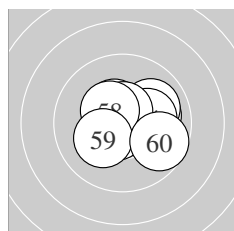

Serie 6:	10.7 *	10.0 →	10.0 ↗	10.2 *	10.6 *
	10.4 *	10.6 *	10.4 *	10.2 *	9.7 ↘
beste Teiler	74.2 (51.)	90.0 (55.)	90.1 (57.)		
Trefferlage	0.48 mm rechts, 0.24 mm hoch				
Streuwert	1.31, horizontal: 1.59, vertikal: 0.95				

Meyton Elektronik

ISSF AR Men – Wertung – Junioren

StandNr: 114

Vas, Péter #70817535

StartNr: 63

3. Dezember 2017 12:49

HUN

QF – Schütze hat sich fürs Finale qualifiziert

Unterschrift des Schützen

Meyton Elektronik

Ergebnis:	608.1	(582)							
Serien:	101.4	101.6	101.8	101.1	102.9	99.3			
Zähler:	43	16	1	0	0	0	0	0	0
Innenzehner:	32								
weiteste:	507 (12), 413 (58), 386 (35)								
beste Teiler	26.0 (59.)	35.1 (48.)	46.5 (21.)						
Trefferlage	0.05 mm rechts, 0.25 mm hoch								
Streuwert	1.59, horizontal: 1.56, vertikal: 1.61								

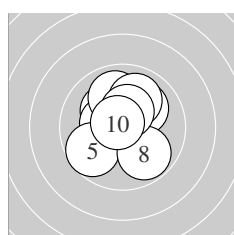
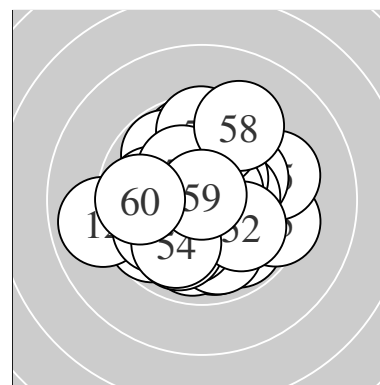

Serie 1:

10.2 *	10.1 ↗	10.2 *	10.4 *	9.7 ↙
9.9 ↑	10.0 ↗	9.8 ↘	10.4 *	10.7 *
beste Teiler	57.3 (10.)	136.4 (9.)	138.2 (4.)	
Trefferlage	0.19 mm links, 0.74 mm hoch			
Streuwert	1.49, horizontal: 1.38, vertikal: 1.60			

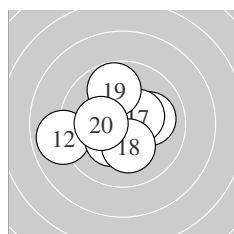

Serie 2:

10.1 →	8.9 ←	10.6 *	10.5 *	10.6 *
10.3 *	10.4 *	10.2 *	9.8 ↑	10.2 *
beste Teiler	92.1 (15.)	99.8 (13.)	106.0 (14.)	
Trefferlage	0.43 mm links, 0.00 mm			
Streuwert	1.69, horizontal: 1.98, vertikal: 1.34			

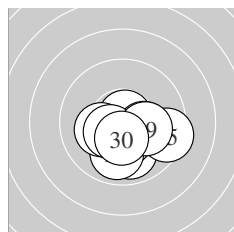

Serie 3:

10.8 *	9.9 ↓	10.4 *	9.9 ↓	9.4 →
10.2 *	10.2 *	10.4 *	10.2 *	10.4 *
beste Teiler	46.5 (21.)	130.4 (28.)	134.3 (30.)	
Trefferlage	0.50 mm rechts, 1.09 mm tief			
Streuwert	1.29, horizontal: 1.58, vertikal: 0.91			

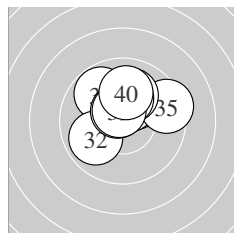

Serie 4:

9.8 ↘	9.9 ↙	10.2 *	10.4 *	9.4 →
10.6 *	10.0 ↑	10.2 *	10.6 *	10.0 ↑
beste Teiler	92.5 (36.)	92.6 (39.)	140.4 (34.)	
Trefferlage	0.17 mm rechts, 1.30 mm hoch			
Streuwert	1.38, horizontal: 1.62, vertikal: 1.10			

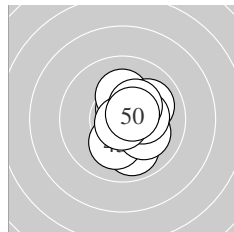

Serie 5:

9.9 ↓	10.6 *	10.1 ↓	10.1 ↘	10.2 *
10.0 ↗	10.3 *	10.8 *	10.3 *	10.6 *
beste Teiler	35.1 (48.)	82.0 (42.)	91.6 (50.)	
Trefferlage	0.74 mm rechts, 0.04 mm tief			
Streuwert	1.19, horizontal: 0.90, vertikal: 1.42			

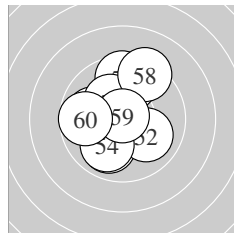

Serie 6:

9.9 ↓	10.0 ↘	10.0 ←	10.0 ↓	9.8 ↑
9.6 ↑	10.2 *	9.3 ↑	10.8 *	9.7 ←
beste Teiler	26.0 (59.)	179.1 (57.)	236.3 (52.)	
Trefferlage	0.46 mm links, 0.64 mm hoch			
Streuwert	1.95, horizontal: 1.67, vertikal: 2.20			

ISSF AR Men – Wertung – Junioren

StandNr: 115

Mompach, Nicolas #70817540

StartNr: 64

3. Dezember 2017 12:55

FRA

Unterschrift des Schützen

Meyton Elektronik

Ergebnis:	615.7	(589) ^{QF}							
Serien:	103.6	102.5	101.7	102.2	102.8	102.9			
Zähler:	50	9	1	0	0	0	0	0	0
Innenzehner:	39								
weiteste:	543 (24), 454 (11), 332 (38)								
beste Teiler	39.9 (51.)	43.9 (6.)	62.6 (57.)						
Trefferlage	0.07 mm rechts, 0.05 mm hoch								
Streuwert	1.41, horizontal: 1.59, vertikal: 1.21								

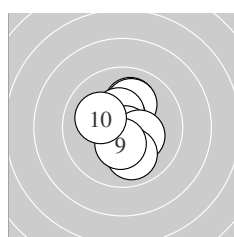
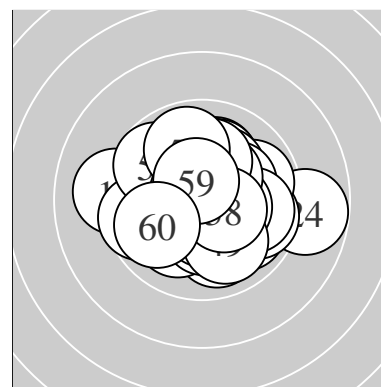

Serie 1:

10.1 ↗	10.1 ↗	10.6 *	10.5 *	10.7 *
10.8 *	10.3 *	10.0 ↓	10.4 *	10.1 ↖
beste Teiler	43.9 (6.)	67.7 (5.)	78.1 (3.)	
Trefferlage	0.16 mm rechts, 0.13 mm hoch			
Streuwert	1.22, horizontal: 0.91, vertikal: 1.47			

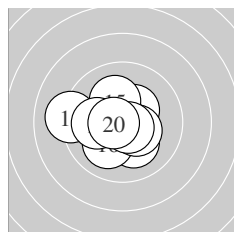

Serie 2:

9.1 ←	10.2 *	10.7 *	10.4 *	10.2 *
10.1 ↘	10.1 ←	10.4 *	10.7 *	10.6 *
beste Teiler	68.6 (19.)	75.6 (13.)	78.4 (20.)	
Trefferlage	0.56 mm links, 0.23 mm tief			
Streuwert	1.49, horizontal: 1.78, vertikal: 1.14			

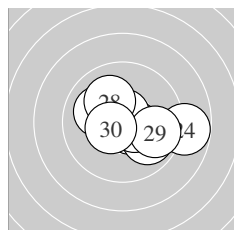

Serie 3:

10.6 *	10.7 *	9.9 ↘	8.8 →	10.1 ↖
10.5 *	10.7 *	10.1 ↖	9.8 →	10.5 *
beste Teiler	64.9 (27.)	72.1 (22.)	87.9 (21.)	
Trefferlage	0.73 mm rechts, 0.10 mm tief			
Streuwert	1.73, horizontal: 2.24, vertikal: 0.97			

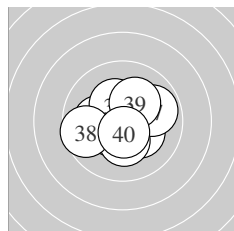

Serie 4:

10.6 *	10.2 *	10.4 *	10.3 *	10.1 ←
10.3 *	9.9 →	9.6 ←	10.2 *	10.6 *
beste Teiler	80.4 (31.)	98.6 (40.)	129.4 (33.)	
Trefferlage	0.11 mm links, 0.21 mm tief			
Streuwert	1.45, horizontal: 1.70, vertikal: 1.14			

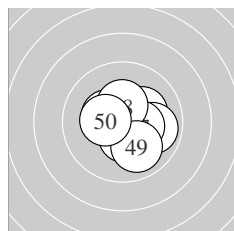

Serie 5:

10.5 *	10.2 *	10.2 *	10.4 *	10.4 *
9.9 →	10.4 *	10.4 *	10.0 ↓	10.4 *
beste Teiler	122.7 (41.)	129.8 (45.)	145.0 (48.)	
Trefferlage	0.58 mm rechts, 0.14 mm tief			
Streuwert	1.26, horizontal: 1.32, vertikal: 1.19			

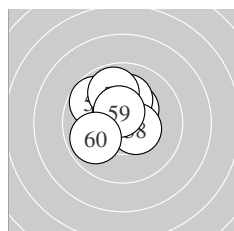

Serie 6:

10.8 *	9.7 ↘	10.4 *	10.4 *	10.1 ↗
9.9 ↗	10.7 *	10.5 *	10.5 *	9.9 ↖
beste Teiler	39.9 (51.)	62.6 (57.)	103.7 (59.)	
Trefferlage	0.36 mm links, 0.90 mm hoch			
Streuwert	1.21, horizontal: 1.22, vertikal: 1.20			

ISSF AR Men – Wertung – Junioren

StandNr: 116

Pekler, Zalan #70817542

StartNr: 65

3. Dezember 2017 12:37

HUN

QF – Schütze hat sich fürs Finale qualifiziert

Unterschrift des Schützen

Meyton Elektronik

Ergebnis:	573.2	(545)
Serien:	95.2 96.1 93.6 96.5 93.6 98.2	
Zähler:	19 29 10 2 0 0 0 0 0 0	
Innenzehner:	12	
weiteste:	911 (23), 847 (27), 686 (48)	
beste Teiler	55.9 (55.) 61.8 (11.) 103.0 (17.)	
Trefferlage	0.20 mm rechts, 0.26 mm hoch	
Streuwert	2.80, horizontal: 2.92, vertikal: 2.68	

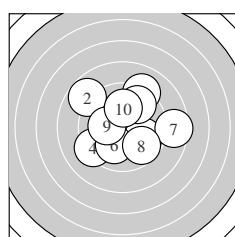
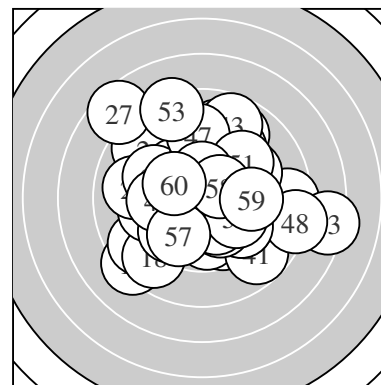

Serie 1:	9.9 ↘	8.8 ↖	9.1 ↗	9.3 ↙	9.7 ↗
	10.0 ↙	8.5 →	9.7 ↘	10.2 *	10.0 ↑
beste Teiler	186.6 (9.)	226.1 (10.)	229.9 (6.)		
Trefferlage	0.43 mm rechts, 0.47 mm hoch				
Streuwert	2.82, horizontal: 3.13, vertikal: 2.48				

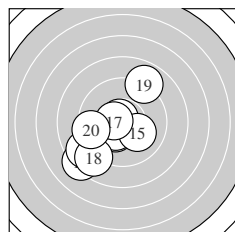

Serie 2:	10.7 *	8.2 ↙	10.3 *	10.4 *	10.1 ↘
	8.8 ↙	10.5 *	8.8 ↙	8.9 ↗	9.4 ←
beste Teiler	61.8 (11.)	103.0 (17.)	136.4 (14.)		
Trefferlage	1.53 mm links, 1.13 mm tief				
Streuwert	2.58, horizontal: 2.55, vertikal: 2.62				

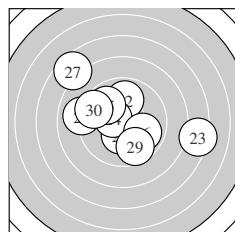

Serie 3:	10.3 *	9.9 ↑	7.3 →	10.5 *	9.9 ↖
	9.9 ↘	7.6 ↖	9.0 ←	9.7 ↘	9.5 ↖
beste Teiler	122.1 (24.)	155.5 (21.)	265.1 (26.)		
Trefferlage	0.44 mm links, 0.60 mm hoch				
Streuwert	3.52, horizontal: 4.22, vertikal: 2.64				

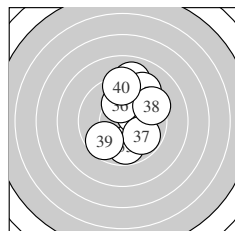

Serie 4:	9.8 ↗	9.0 ↑	9.8 ↓	10.3 *	9.3 ↗
	10.1 ↑	9.8 ↘	9.4 ↗	9.7 ↙	9.3 ↑
beste Teiler	168.1 (34.)	206.7 (36.)	279.8 (37.)		
Trefferlage	1.01 mm rechts, 1.24 mm hoch				
Streuwert	2.23, horizontal: 1.61, vertikal: 2.72				

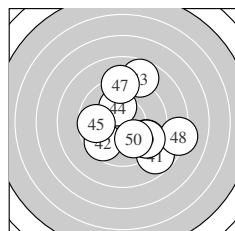

Serie 5:	8.8 ↘	9.6 ↙	8.7 ↗	10.2 *	9.7 ←
	9.6 ↘	9.2 ↑	8.2 →	9.6 ↘	10.0 ↘
beste Teiler	188.1 (44.)	237.6 (50.)	313.5 (45.)		
Trefferlage	1.31 mm rechts, 0.26 mm tief				
Streuwert	3.02, horizontal: 2.96, vertikal: 3.07				

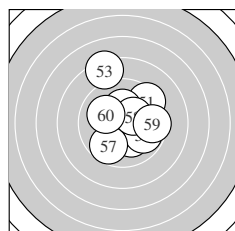

Serie 6:	9.4 ↗	10.1 ↘	8.3 ↗	10.2 *	10.7 *
	9.8 ↘	9.7 ↙	10.4 *	9.5 →	10.1 ↖
beste Teiler	55.9 (55.)	149.2 (58.)	176.0 (54.)		
Trefferlage	0.47 mm rechts, 0.66 mm hoch				
Streuwert	2.31, horizontal: 2.07, vertikal: 2.54				

Meyton Elektronik

ISSF AR Men – Wertung – **Junioren**

StandNr: 117

Gopp, Manuel #70817475

StartNr: 66

3. Dezember 2017 12:22

VSB-TZ Altach

Unterschrift des Schützen

Meyton Elektronik

Ergebnis:	605.0	(572)							
Serien:	98.6	97.0	99.9	103.9	101.9	103.7			
Zähler:	36	21	2	1	0	0	0	0	0
Innenzehner:	33								
weiteste:	865 (13), 586 (14), 514 (10)								
beste Teiler	32.1 (48.)	41.6 (51.)	59.0 (16.)						
Trefferlage	0.78 mm rechts,	0.00 mm							
Streuwert	1.78, horizontal: 1.99, vertikal: 1.53								

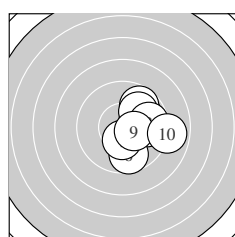
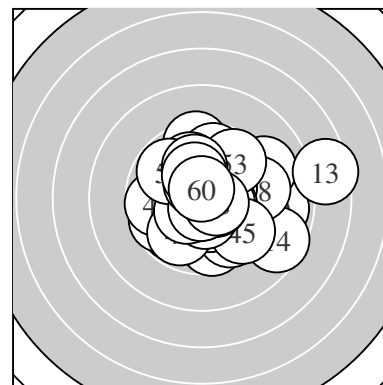

Serie 1:

9.9 ↗	9.7 ↗	10.2 *	9.9 ↗	9.8 →
9.7 ↓	10.4 *	9.7 →	10.4 *	8.9 →
beste Teiler	137.2 (9.)	146.1 (7.)	188.8 (3.)	
Trefferlage	2.04 mm rechts, 0.11 mm hoch			
Streuwert	1.53, horizontal: 1.40, vertikal: 1.64			

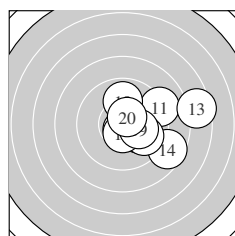

Serie 2:

9.1 ↗	10.1 ↘	7.5 →	8.6 ↘	9.8 ↘
10.7 *	10.5 *	9.9 ↑	10.2 *	10.6 *
beste Teiler	59.0 (16.)	95.7 (20.)	102.0 (17.)	
Trefferlage	2.44 mm rechts, 0.02 mm tief			
Streuwert	2.31, horizontal: 2.77, vertikal: 1.74			

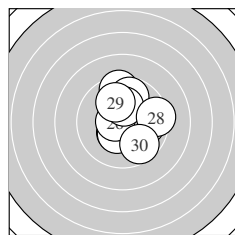

Serie 3:

9.5 ↑	10.4 *	9.8 ↑	9.9 →	10.4 *
10.6 *	10.2 *	9.4 →	10.0 ↑	9.7 ↘
beste Teiler	85.2 (26.)	138.7 (22.)	147.5 (25.)	
Trefferlage	0.57 mm rechts, 0.59 mm hoch			
Streuwert	1.85, horizontal: 1.66, vertikal: 2.02			

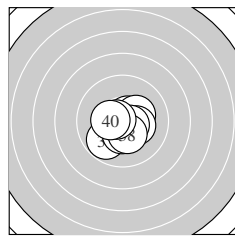

Serie 4:

10.6 *	10.3 *	10.5 *	9.8 ✓	10.3 *
10.4 *	10.6 *	10.3 *	10.7 *	10.4 *
beste Teiler	73.9 (39.)	82.2 (31.)	91.7 (37.)	
Trefferlage	0.03 mm rechts, 0.52 mm tief			
Streuwert	1.07, horizontal: 1.17, vertikal: 0.95			

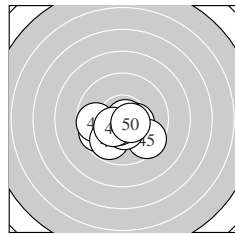

Serie 5:

9.7 ↙	10.4 *	9.7 ←	9.8 ✓	9.5 ↘
10.4 *	10.6 *	10.8 *	10.4 *	10.6 *
beste Teiler	32.1 (48.)	88.3 (47.)	100.1 (50.)	
Trefferlage	0.32 mm links, 1.03 mm tief			
Streuwert	1.41, horizontal: 1.83, vertikal: 0.81			

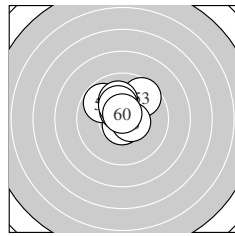

Serie 6:

10.8 *	9.8 ↖	9.6 ↗	10.7 *	10.1 ↑
10.7 *	10.5 *	10.5 *	10.3 *	10.7 *
beste Teiler	41.6 (51.)	62.1 (60.)	67.0 (54.)	
Trefferlage	0.08 mm links, 0.82 mm hoch			
Streuwert	1.14, horizontal: 1.12, vertikal: 1.16			

Meyton Elektronik

ISSF AR Men – Wertung – Junioren

StandNr: 118

Einwaller, Dominic #70804354

StartNr: 67

3. Dezember 2017 12:33

TLSB

Unterschrift des Schützen

Meyton Elektronik

Ergebnis:	591.1	(565)
Serien:	102.1 97.5 97.7 93.7 101.0 99.1	
Zähler:	33 20 6 1 0 0 0 0 0	
Innenzehner:	19	
weiteste:	761 (38), 705 (26), 664 (22)	
beste Teiler	23.7 (3.) 34.0 (18.) 55.1 (43.)	
Trefferlage	0.85 mm links, 0.73 mm tief	
Streuwert	2.12, horizontal: 2.62, vertikal: 1.46	

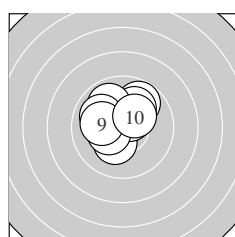
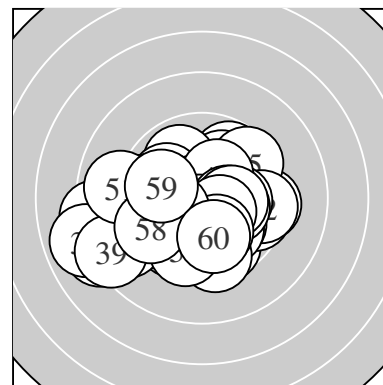

Serie 1:

9.8 ↗	10.0 ↗	10.9 *	10.3 *	10.5 *
9.9 ↘	10.0 ↘	10.3 *	10.1 ←	10.3 *
beste Teiler	23.7 (3.)	106.1 (5.)	151.9 (8.)	
Trefferlage	0.32 mm links, 0.79 mm hoch			
Streuwert	1.36, horizontal: 1.45, vertikal: 1.28			

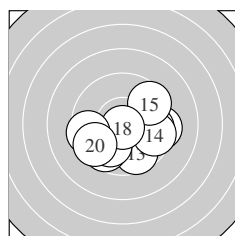

Serie 2:

9.4 →	9.7 →	9.7 ↘	9.6 →	9.6 ↗
9.7 ↙	10.0 ↙	10.8 *	9.5 ←	9.5 ↖
beste Teiler	34.0 (18.)	248.8 (17.)	307.2 (12.)	
Trefferlage	0.48 mm rechts, 1.06 mm tief			
Streuwert	2.20, horizontal: 2.74, vertikal: 1.49			

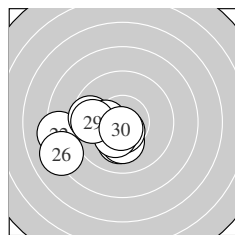

Serie 3:

10.1 ↓	8.3 ←	10.1 ↓	9.6 ←	10.6 *
8.1 ←	10.2 *	10.3 *	9.7 ←	10.7 *
beste Teiler	68.1 (30.)	95.0 (25.)	157.9 (28.)	
Trefferlage	2.22 mm links, 1.08 mm tief			
Streuwert	1.95, horizontal: 2.52, vertikal: 1.13			

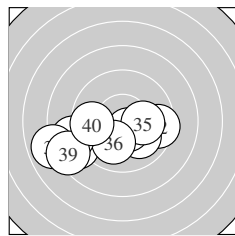

Serie 4:

8.8 ↖	9.5 →	10.0 ↘	10.5 *	10.1 →
10.0 ↙	8.8 ←	7.9 ←	8.4 ↖	9.7 ←
beste Teiler	105.1 (34.)	208.8 (35.)	234.9 (33.)	
Trefferlage	1.85 mm links, 1.59 mm tief			
Streuwert	2.77, horizontal: 3.76, vertikal: 1.10			

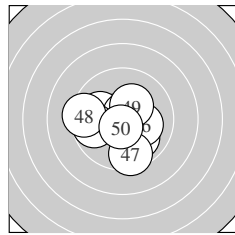

Serie 5:

10.6 *	10.0 ←	10.7 *	9.8 ←	10.0 ↘
10.1 →	9.5 ↓	9.4 ←	10.3 *	10.6 *
beste Teiler	55.1 (43.)	77.3 (41.)	82.9 (50.)	
Trefferlage	0.46 mm links, 0.43 mm tief			
Streuwert	1.73, horizontal: 1.99, vertikal: 1.44			

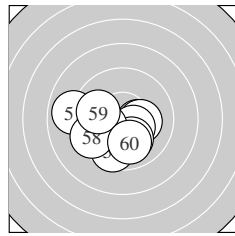

Serie 6:

8.9 ←	10.3 *	9.6 ↓	10.2 *	10.4 *
10.1 ↘	10.2 *	9.5 ↖	9.9 ←	10.0 ↓
beste Teiler	138.4 (55.)	157.9 (52.)	183.7 (54.)	
Trefferlage	0.74 mm links, 1.00 mm tief			
Streuwert	1.89, horizontal: 2.32, vertikal: 1.31			

Meyton Elektronik

ISSF AR Men – Wertung – Junioren

StandNr: 119

Zogg, Lukas #70804107

StartNr: 68

3. Dezember 2017 12:44

VSB NWLZ

Unterschrift des Schützen

Meyton Elektronik

Ergebnis:	610.4	(581)
Serien:	102.4	102.5 103.3 100.3 100.0 101.9
Zähler:	41	19 0 0 0 0 0 0 0 0
Innenzehner:	29	
weiteste:	420	(49), 364 (36), 355 (33)
beste Teiler	39.8	(55.) 44.4 (26.) 50.9 (20.)
Trefferlage	0.12 mm	rechts, 0.30 mm hoch
Streuwert	1.53,	horizontal: 1.61, vertikal: 1.45

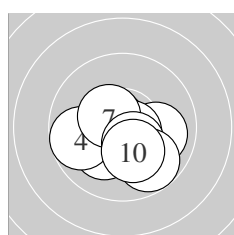
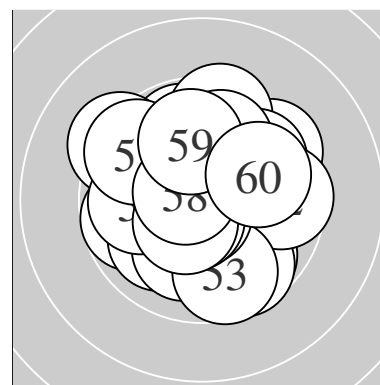

Serie 1:	10.3 *	10.6 *	10.2 *	9.7 ←	10.0 →
	10.7 *	10.5 *	10.4 *	9.8 ↘	10.2 *
beste Teiler	62.9	(6.) 79.3 (2.)	123.6 (7.)		
Trefferlage	0.11 mm	rechts, 0.84 mm tief			
Streuwert	1.31,	horizontal: 1.58, vertikal: 0.97			

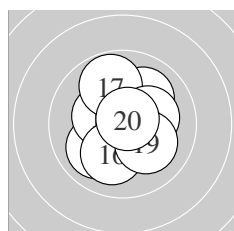

Serie 2:	10.5 *	10.6 *	10.0 ↙	10.4 *	10.0 ↗
	10.1 ↓	9.8 ↑	10.2 *	10.1 ↘	10.8 *
beste Teiler	50.9	(20.) 85.0 (12.)	125.3 (11.)		
Trefferlage	0.03 mm	rechts, 0.00 mm			
Streuwert	1.43,	horizontal: 1.32, vertikal: 1.53			

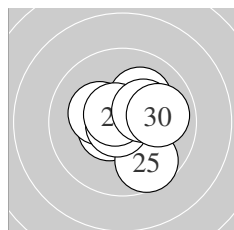

Serie 3:	10.5 *	10.5 *	10.5 *	10.3 *	9.7 ↘
	10.8 *	10.1 ↗	10.7 *	10.3 *	9.9 →
beste Teiler	44.4	(26.) 75.6 (28.)	105.5 (21.)		
Trefferlage	0.55 mm	rechts, 0.01 mm tief			
Streuwert	1.26,	horizontal: 1.33, vertikal: 1.18			

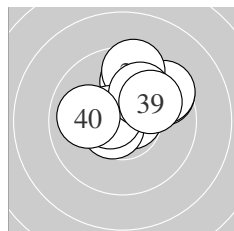

Serie 4:	10.7 *	9.6 ↗	9.5 ↗	10.6 *	9.8 ↑
	9.5 ↑	10.6 *	10.0 ↗	10.0 ↗	10.0 ←
beste Teiler	63.1	(31.) 83.5 (34.)	92.0 (37.)		
Trefferlage	0.69 mm	rechts, 1.40 mm hoch			
Streuwert	1.50,	horizontal: 1.69, vertikal: 1.28			

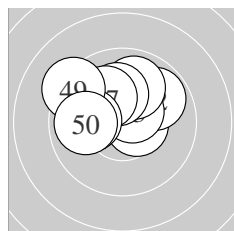

Serie 5:	10.5 *	9.8 ↗	10.5 *	9.9 ↖	9.9 ↑
	10.1 ↑	10.1 ↖	10.0 ←	9.3 ↖	9.9 ←
beste Teiler	102.7	(41.) 103.3 (43.)	201.0 (46.)		
Trefferlage	0.76 mm	links, 1.20 mm hoch			
Streuwert	1.52,	horizontal: 1.91, vertikal: 0.99			

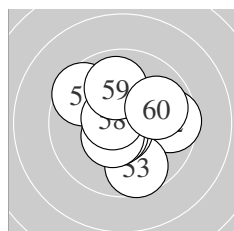

Serie 6:	9.6 ↖	9.6 →	9.7 ↓	10.7 *	10.8 *
	10.6 *	10.5 *	10.6 *	9.9 ↑	9.9 →
beste Teiler	39.8	(55.) 56.8 (54.)	78.7 (58.)		
Trefferlage	0.11 mm	rechts, 0.08 mm hoch			
Streuwert	1.66,	horizontal: 1.74, vertikal: 1.59			

Meyton Elektronik

ISSF AR Men – Wertung – Junioren

StandNr: 120

Kryzs, Lucas #70817537

StartNr: 69

3. Dezember 2017 12:47

FRA

Unterschrift des Schützen

Meyton Elektronik

Ergebnis:	583.5	(558)							
Serien:	96.9	95.4	99.9	96.3	98.6	96.4			
Zähler:	25	28	7	0	0	0	0	0	0
Innenzehner:	21								
weiteste:	671 (7), 667 (41), 581 (23)								
beste Teiler	61.2 (49.)	64.1 (46.)	91.0 (27.)						
Trefferlage	0.82 mm links, 0.46 mm hoch								
Streuwert	2.37, horizontal: 2.79, vertikal: 1.85								

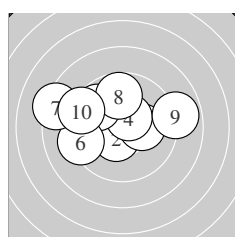
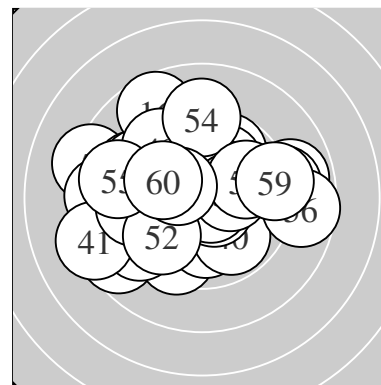

Serie 1:	10.6 *	10.5 *	10.2 *	10.5 *	9.7 ↘
	9.3 ←	8.3 ↙	9.7 ↑	8.9 →	9.2 ↙
beste Teiler	98.8 (1.)	111.5 (4.)	121.4 (2.)		
Trefferlage	1.08 mm links, 0.73 mm hoch				
Streuwert	2.55, horizontal: 3.29, vertikal: 1.47				

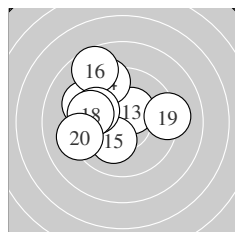

Serie 2:	9.5 ↘	9.4 ↙	10.4 *	9.3 ↑	10.2 *
	8.7 ↘	9.8 ↙	9.7 ↙	9.2 →	9.2 ←
beste Teiler	139.0 (13.)	192.7 (15.)	276.7 (17.)		
Trefferlage	1.54 mm links, 1.40 mm hoch				
Streuwert	2.32, horizontal: 2.50, vertikal: 2.12				

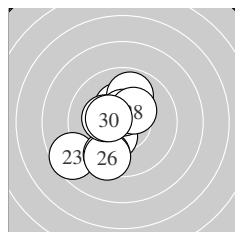

Serie 3:	10.3 *	9.9 ↑	8.6 ↙	10.3 *	9.6 ↘
	9.5 ↘	10.6 *	10.4 *	10.3 *	10.4 *
beste Teiler	91.0 (27.)	137.7 (30.)	150.6 (28.)		
Trefferlage	1.03 mm links, 0.42 mm tief				
Streuwert	1.93, horizontal: 1.64, vertikal: 2.18				

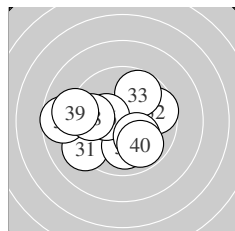

Serie 4:	9.2 ↙	9.6 →	9.7 ↑	8.7 ←	10.0 ↓
	10.3 *	10.2 *	9.7 ←	9.1 ←	9.8 ↘
beste Teiler	160.8 (36.)	197.3 (37.)	238.0 (35.)		
Trefferlage	1.05 mm links, 0.31 mm tief				
Streuwert	2.47, horizontal: 3.04, vertikal: 1.73				

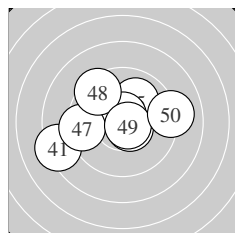

Serie 5:	8.3 ↙	10.6 *	10.1 ↘	10.3 *	10.0 ↑
	10.7 *	9.4 ←	9.4 ↘	10.7 *	9.1 →
beste Teiler	61.2 (49.)	64.1 (46.)	91.0 (42.)		
Trefferlage	0.58 mm links, 0.48 mm hoch				
Streuwert	2.42, horizontal: 3.06, vertikal: 1.53				

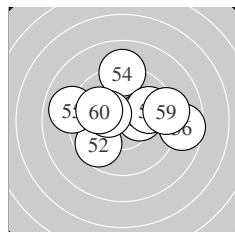

Serie 6:	10.2 *	9.7 ↙	10.3 *	9.1 ↑	9.0 ←
	8.7 →	9.9 →	10.3 *	9.2 →	10.0 ↙
beste Teiler	154.7 (58.)	166.3 (53.)	182.1 (51.)		
Trefferlage	0.33 mm rechts, 0.88 mm hoch				
Streuwert	2.60, horizontal: 3.24, vertikal: 1.73				

Meyton Elektronik

ISSF AR Men – Wertung – Junioren

StandNr: 121

Waibel, Kiano #84

StartNr: 70

3. Dezember 2017 12:39

VSB NWLZ

Unterschrift des Schützen

Meyton Elektronik

Ergebnis:	598.1	(572)
Serien:	102.8 98.5 98.1 97.3 100.7 100.7	
Zähler:	34 24 2 0 0 0 0 0 0 0	
Innenzehner:	24	
weiteste:	633 (24), 567 (57), 466 (20)	
beste Teiler	24.6 (59.) 28.6 (51.) 58.1 (7.)	
Trefferlage	0.23 mm rechts, 0.02 mm tief	
Streuwert	1.96, horizontal: 2.01, vertikal: 1.92	

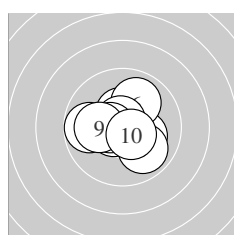
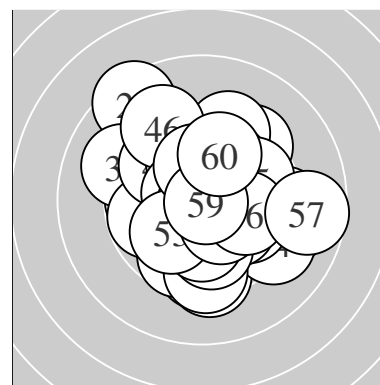

Serie 1:					
	10.2 *	10.4 *	9.9 ↘	10.6 *	9.8 ←
	10.0 ↗	10.7 *	10.5 *	10.1 ←	10.6 *
beste Teiler	58.1 (7.)	87.6 (4.)	100.1 (10.)		
Trefferlage	0.17 mm links, 0.02 mm hoch				
Streuwert	1.38, horizontal: 1.60, vertikal: 1.13				

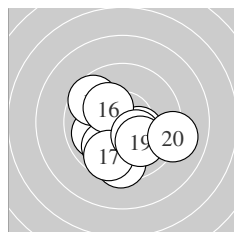

Serie 2:					
	10.3 *	9.9 ←	9.5 ↓	9.9 ↙	9.6 ↘
	10.2 *	9.7 ↓	10.3 *	10.0 ↘	9.1 →
beste Teiler	166.2 (18.)	166.3 (11.)	181.0 (16.)		
Trefferlage	0.03 mm links, 1.15 mm tief				
Streuwert	1.97, horizontal: 2.20, vertikal: 1.71				

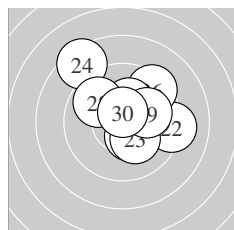

Serie 3:					
	10.4 *	9.2 →	10.2 *	8.4 ↘	9.9 ↗
	9.4 ↗	10.2 *	9.8 ↘	10.0 →	10.6 *
beste Teiler	88.0 (30.)	139.0 (21.)	178.9 (27.)		
Trefferlage	0.77 mm rechts, 1.18 mm hoch				
Streuwert	2.17, horizontal: 2.33, vertikal: 1.99				

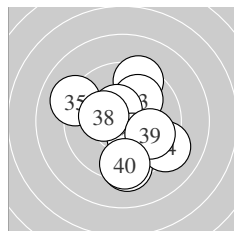

Serie 4:					
	9.4 ↗	9.3 ↓	10.0 ↗	9.2 ↘	9.1 ↘
	10.5 *	10.2 *	10.3 *	9.9 ↘	9.4 ↓
beste Teiler	113.5 (36.)	174.8 (38.)	176.3 (37.)		
Trefferlage	0.40 mm rechts, 0.40 mm tief				
Streuwert	2.40, horizontal: 2.23, vertikal: 2.56				

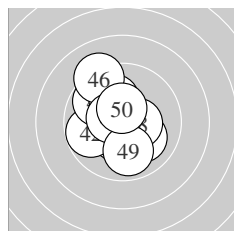

Serie 5:					
	10.4 *	9.8 ←	9.8 ↘	10.1 ↗	10.1 ↘
	9.2 ↘	10.5 *	10.4 *	9.9 ↓	10.5 *
beste Teiler	107.2 (47.)	123.2 (50.)	132.5 (48.)		
Trefferlage	0.60 mm links, 0.31 mm hoch				
Streuwert	1.75, horizontal: 1.52, vertikal: 1.95				

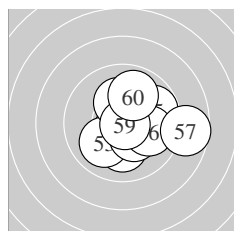

Serie 6:					
	10.8 *	10.1 ↓	10.0 ↙	10.3 *	9.8 →
	10.0 →	8.7 →	10.2 *	10.9 *	9.9 ↗
beste Teiler	24.6 (59.)	28.6 (51.)	157.4 (54.)		
Trefferlage	1.06 mm rechts, 0.13 mm tief				
Streuwert	1.80, horizontal: 2.05, vertikal: 1.50				

ISSF AR Men – Wertung – Junioren
StandNr: 122
Hammerer, Sebastian #70804104

StartNr: 71
3. Dezember 2017 12:50
VSB–TZ Höchst

Unterschrift des Schützen

Meyton Elektronik

Ergebnis: **614.4** (587)^{QF}
 Serien: 101.1 103.1 103.1 102.6 101.8 102.7
 Zähler: 47 13 0 0 0 0 0 0 0
 Innenzehner: 38
 weiteste: 495 (4), 451 (33), 347 (18)
 beste Teiler 19.1 (36.) 35.4 (57.) 35.5 (14.)
 Trefferlage 0.11 mm rechts, 0.05 mm tief
 Streuwert 1.48, horizontal: 1.75, vertikal: 1.14

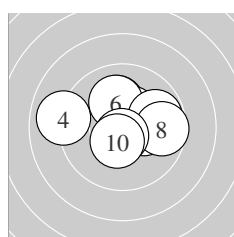
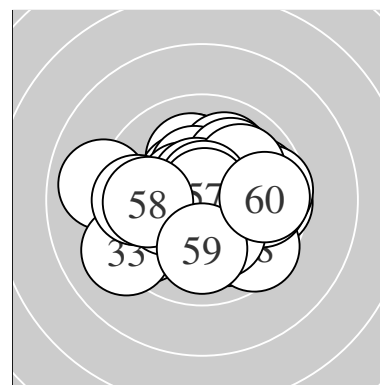

Serie 1:
 10.1 ↑ 10.4 * 10.6 * 9.0 ← 10.2 *
 10.1 ↑ 9.8 → 9.7 → 10.7 * 10.5 *
 beste Teiler 70.5 (9.) 99.9 (3.) 123.4 (10.)
 Trefferlage 0.26 mm rechts, 0.54 mm hoch
 Streuwert 1.77, horizontal: 2.26, vertikal: 1.08

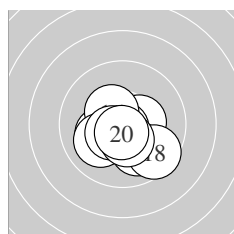

Serie 2:
 10.4 * 10.2 * 10.0 ↘ 10.8 * 10.4 *
 10.1 ↙ 10.5 * 9.6 ↘ 10.4 * 10.7 *
 beste Teiler 35.5 (14.) 70.5 (20.) 114.3 (17.)
 Trefferlage 0.01 mm rechts, 0.83 mm tief
 Streuwert 1.22, horizontal: 1.42, vertikal: 0.99

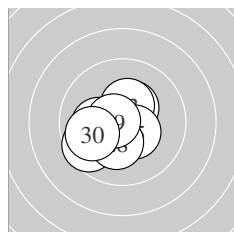

Serie 3:
 10.4 * 10.6 * 10.4 * 10.6 * 10.5 *
 9.6 ↙ 10.2 * 10.3 * 10.6 * 9.9 ←
 beste Teiler 76.5 (29.) 86.0 (22.) 98.9 (24.)
 Trefferlage 0.67 mm links, 0.42 mm tief
 Streuwert 1.23, horizontal: 1.36, vertikal: 1.08

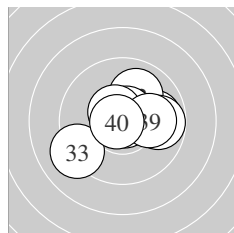

Serie 4:
 9.9 → 10.0 ↗ 9.1 ↙ 10.7 * 10.7 *
 10.9 * 10.6 * 9.8 → 10.1 → 10.8 *
 beste Teiler 19.1 (36.) 48.3 (40.) 71.0 (34.)
 Trefferlage 0.40 mm rechts, 0.17 mm hoch
 Streuwert 1.61, horizontal: 1.98, vertikal: 1.14

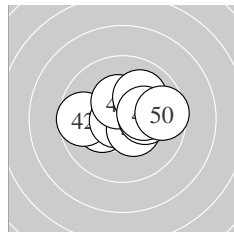

Serie 5:
 10.3 * 9.7 ← 10.7 * 10.5 * 10.2 *
 10.4 * 10.2 * 10.0 ↗ 10.2 * 9.6 →
 beste Teiler 52.8 (43.) 123.7 (44.) 147.9 (46.)
 Trefferlage 0.48 mm rechts, 0.40 mm hoch
 Streuwert 1.49, horizontal: 1.93, vertikal: 0.86

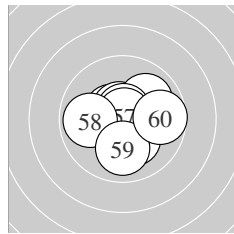

Serie 6:
 10.5 * 10.6 * 10.2 * 10.0 ↗ 10.3 *
 10.7 * 10.8 * 9.9 ← 10.0 ↓ 9.7 →
 beste Teiler 35.4 (57.) 69.4 (56.) 88.8 (52.)
 Trefferlage 0.21 mm rechts, 0.17 mm tief
 Streuwert 1.43, horizontal: 1.56, vertikal: 1.30

Meyton Elektronik

ISSF AR Men – Wertung – Junioren

StandNr: 123

Wadlegger, Stefan #98

StartNr: 72

3. Dezember 2017 12:38

AUT

QF – Schütze hat sich fürs Finale qualifiziert

Unterschrift des Schützen

Meyton Elektronik

Ergebnis:	597.8	(570)
Serien:	99.1	102.1 98.6 99.8 99.2 99.0
Zähler:	34	22 4 0 0 0 0 0 0 0
Innenzehner:	26	
weiteste:	614 (41), 610 (4), 587 (23)	
beste Teiler	18.0 (50.)	33.0 (10.) 41.6 (8.)
Trefferlage	0.13 mm links, 0.28 mm hoch	
Streuwert	2.03, horizontal: 2.33, vertikal: 1.67	

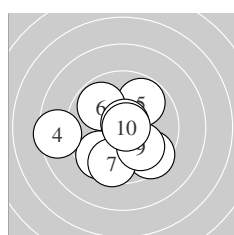
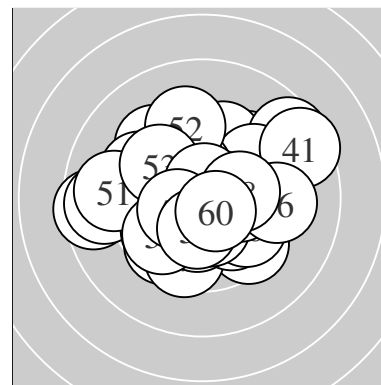

Serie 1:

10.7 *	9.6 ↙	9.5 ↘	8.5 ←	9.8 ↗
9.8 ↘	9.6 ↓	10.8 *	10.0 ↘	10.8 *
beste Teiler	33.0 (10.) 41.6 (8.) 57.4 (1.)			
Trefferlage	0.43 mm links, 0.67 mm tief			
Streuwert	2.23, horizontal: 2.52, vertikal: 1.91			

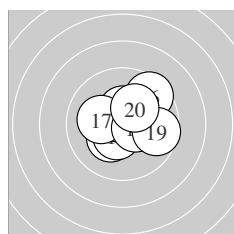

Serie 2:

10.3 *	10.5 *	10.7 *	10.2 *	10.4 *
9.5 ↗	10.1 ←	10.5 *	9.7 →	10.2 *
beste Teiler	57.2 (13.) 120.3 (12.) 125.9 (18.)			
Trefferlage	0.59 mm rechts, 0.27 mm hoch			
Streuwert	1.46, horizontal: 1.64, vertikal: 1.25			

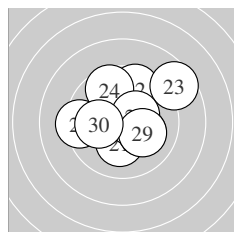

Serie 3:

10.2 *	9.6 ↑	8.6 ↗	9.6 ↑	9.3 ←
10.1 ↘	10.6 *	10.4 *	10.1 ↘	10.1 ←
beste Teiler	97.0 (27.) 136.9 (28.) 190.9 (21.)			
Trefferlage	0.41 mm rechts, 0.60 mm hoch			
Streuwert	2.20, horizontal: 2.46, vertikal: 1.92			

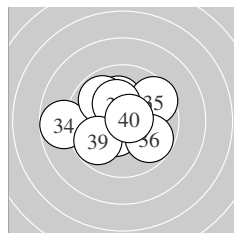

Serie 4:

10.2 *	10.5 *	10.2 *	8.8 ←	9.6 ↗
9.8 ↘	9.9 ↘	10.3 *	9.8 ↙	10.7 *
beste Teiler	65.5 (40.) 122.4 (32.) 172.0 (38.)			
Trefferlage	0.70 mm links, 0.38 mm hoch			
Streuwert	2.01, horizontal: 2.42, vertikal: 1.51			

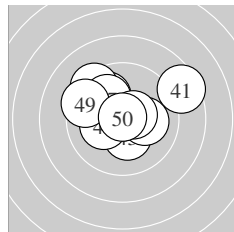

Serie 5:

8.5 ↗	9.9 ↘	10.3 *	10.2 *	10.1 →
9.4 ↘	10.0 ↘	10.5 *	9.4 ↖	10.9 *
beste Teiler	18.0 (50.) 106.4 (48.) 165.2 (43.)			
Trefferlage	0.18 mm links, 0.94 mm hoch			
Streuwert	2.14, horizontal: 2.61, vertikal: 1.53			

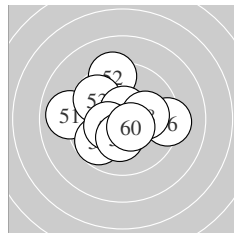

Serie 6:

9.0 ←	9.3 ↑	9.8 ↘	9.8 ↙	10.6 *
9.3 →	10.3 *	10.1 →	10.3 *	10.5 *
beste Teiler	82.0 (55.) 106.0 (60.) 152.1 (57.)			
Trefferlage	0.49 mm links, 0.20 mm hoch			
Streuwert	2.18, horizontal: 2.53, vertikal: 1.76			

ISSF AR Men – Wertung – Junioren

StandNr: 124

Sommavilla, Manuel #322

StartNr: 73

3. Dezember 2017 12:46

T – SG Wattens

Unterschrift des Schützen

Meyton Elektronik

Ergebnis: **611.2** (584)
 Serien: 103.7 101.3 99.4 102.2 101.8 102.8
 Zähler: 45 14 1 0 0 0 0 0 0
 Innenzehner: 35
 weiteste: 553 (27), 428 (41), 363 (19)
 beste Teiler 33.0 (35.) 52.7 (44.) 60.2 (29.)
 Trefferlage 0.25 mm links, 0.03 mm tief
 Streuwert 1.52, horizontal: 1.75, vertikal: 1.25

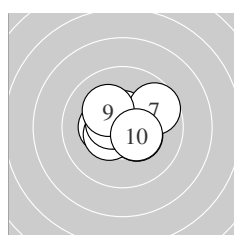
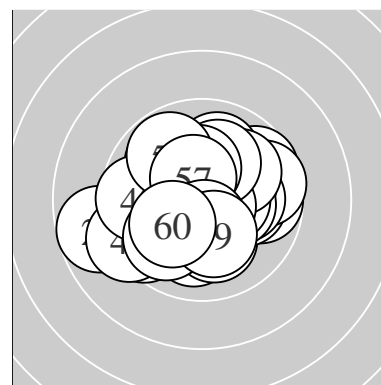

Serie 1:
 10.4 * 10.3 * 10.4 * 10.7 * 10.5 *
 10.6 * 9.7 ↗ 10.5 * 10.2 * 10.4 *
 beste Teiler 73.4 (4.) 93.0 (6.) 103.1 (8.)
 Trefferlage 0.06 mm rechts, 0.27 mm hoch
 Streuwert 1.17, horizontal: 1.43, vertikal: 0.84

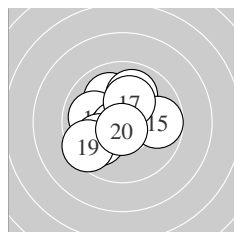

Serie 2:
 10.0 ↘ 10.0 ← 10.5 * 10.0 ↑ 9.8 →
 10.7 * 10.2 * 9.9 ↙ 9.5 ↙ 10.7 *
 beste Teiler 63.6 (20.) 64.0 (16.) 104.6 (13.)
 Trefferlage 0.55 mm links, 0.12 mm hoch
 Streuwert 1.64, horizontal: 1.76, vertikal: 1.50

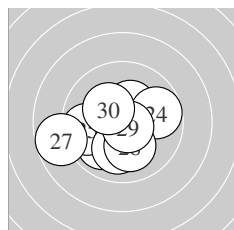

Serie 3:
 9.9 ↙ 10.3 * 9.9 ↙ 9.8 → 9.7 ←
 10.0 ↓ 8.7 ← 10.1 ↓ 10.7 * 10.3 *
 beste Teiler 60.2 (29.) 152.5 (22.) 168.3 (30.)
 Trefferlage 0.97 mm links, 0.63 mm tief
 Streuwert 1.91, horizontal: 2.34, vertikal: 1.35

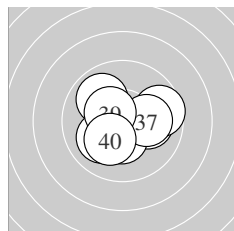

Serie 4:
 10.7 * 10.1 → 9.6 → 9.9 ↘ 10.8 *
 10.4 * 10.1 → 10.0 ↙ 10.4 * 10.2 *
 beste Teiler 33.0 (35.) 63.6 (31.) 130.3 (39.)
 Trefferlage 0.13 mm rechts, 0.19 mm tief
 Streuwert 1.47, horizontal: 1.75, vertikal: 1.13

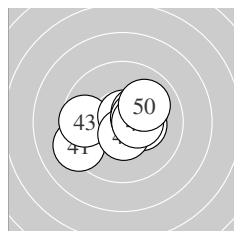

Serie 5:
 9.2 ↙ 10.2 * 9.6 ← 10.7 * 10.4 *
 10.3 * 10.5 * 10.5 * 10.4 * 10.0 ↗
 beste Teiler 52.7 (44.) 107.4 (47.) 125.2 (48.)
 Trefferlage 0.19 mm rechts, 0.06 mm hoch
 Streuwert 1.62, horizontal: 2.06, vertikal: 1.00

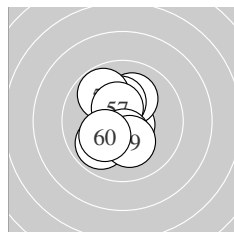

Serie 6:
 10.7 * 10.6 * 10.1 ↑ 10.3 * 9.8 ↘
 9.9 ↙ 10.5 * 10.5 * 10.2 * 10.2 *
 beste Teiler 63.6 (51.) 97.0 (52.) 121.5 (58.)
 Trefferlage 0.36 mm links, 0.14 mm hoch
 Streuwert 1.35, horizontal: 0.99, vertikal: 1.62

Meyton Elektronik

ISSF AR Men – Wertung – Junioren

StandNr: 125

Mair, Tobias #124

StartNr: 74

3. Dezember 2017 12:36

TLSB

Unterschrift des Schützen

Meyton Elektronik

Ergebnis: **565.9** (543)

Serien: 94.2 98.4 94.0 91.3 97.6 90.4

Zähler: 20 26 11 3 0 0 0 0 0 0

Innenzehner: 12

weiteste: 959 (39), 842 (13), 789 (55)

beste Teiler 50.4 (59.) 84.1 (50.) 93.7 (41.)

Trefferlage 0.02 mm links, 0.54 mm tief

Streuwert 3.05, horizontal: 3.44, vertikal: 2.61

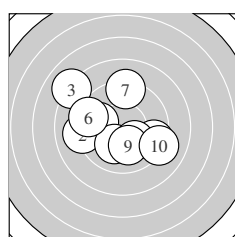
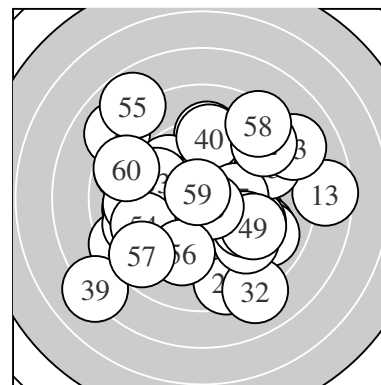

Serie 1:

9.8 ↖	9.1 ↖	8.0 ↘	9.4 →	10.1 ↙
9.3 ↖	9.2 ↑	10.1 ↘	10.1 ↓	9.1 →

beste Teiler 202.4 (8.) 213.7 (5.) 214.4 (9.)

Trefferlage 0.79 mm links, 0.07 mm hoch

Streuwert 2.99, horizontal: 3.40, vertikal: 2.51

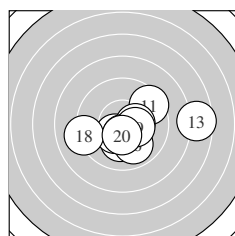

Serie 2:

9.5 ↗	10.1 ↓	7.6 →	10.4 *	10.4 *
9.9 ↘	10.5 *	9.1 ↖	10.4 *	10.5 *

beste Teiler 116.0 (17.) 125.2 (20.) 140.7 (14.)

Trefferlage 0.98 mm rechts, 0.68 mm tief

Streuwert 2.49, horizontal: 3.27, vertikal: 1.30

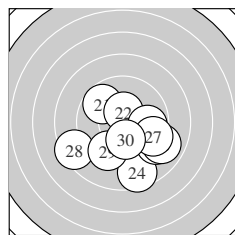

Serie 3:

9.7 ↘	10.5 *	9.8 →	8.6 ↓	9.1 ↘
8.9 ↘	9.4 ↘	8.4 ↖	9.5 ↙	10.1 ↓

beste Teiler 118.5 (22.) 201.8 (30.) 284.9 (23.)

Trefferlage 0.71 mm rechts, 1.78 mm tief

Streuwert 2.75, horizontal: 3.16, vertikal: 2.27

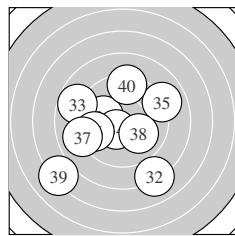

Serie 4:

10.0 ↖	8.0 ↓	8.8 ↖	10.5 *	9.0 →
9.6 ↖	9.0 ↖	10.0 ↘	7.1 ↙	9.3 ↑

beste Teiler 120.0 (34.) 226.6 (31.) 231.6 (38.)

Trefferlage 1.27 mm links, 0.90 mm tief

Streuwert 3.66, horizontal: 3.90, vertikal: 3.40

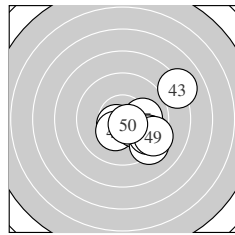

Serie 5:

10.6 *	10.3 *	8.1 ↗	9.4 ↘	10.3 *
9.3 ↘	10.0 →	9.6 ↘	9.4 ↘	10.6 *

beste Teiler 84.1 (50.) 93.7 (41.) 158.8 (42.)

Trefferlage 2.17 mm rechts, 0.83 mm tief

Streuwert 1.95, horizontal: 2.14, vertikal: 1.75

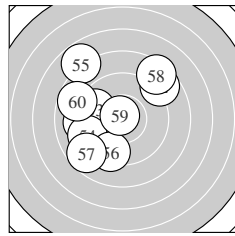

Serie 6:

9.1 ↖	8.7 ↗	9.6 ↖	9.2 ↖	7.8 ↖
9.4 ↓	8.7 ↖	8.4 ↗	10.8 *	8.7 ↖

beste Teiler 50.4 (59.) 330.7 (53.) 397.3 (56.)

Trefferlage 1.92 mm links, 0.88 mm hoch

Streuwert 3.49, horizontal: 3.49, vertikal: 3.49

ISSF AR Men – Wertung – Junioren
StandNr: 126
Dornauer, Jonathan #70817572

StartNr: 75
3. Dezember 2017 12:42
T – SG Fügenberg

Unterschrift des Schützen

Meyton Elektronik

Ergebnis:	619.5	(593) ^{QF}						
Serien:	102.7	104.5	103.6	103.5	103.1	102.1		
Zähler:	53	7	0	0	0	0	0	0
Innenzehner:	43							
weiteste:	323 (60), 296 (33), 289 (59)							
beste Teiler	15.0 (32.)	30.2 (56.)	53.3 (1.)					
Trefferlage	0.22 mm links, 0.11 mm tief							
Streuwert	1.21, horizontal: 1.19, vertikal: 1.24							

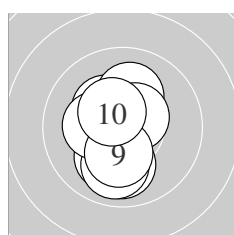
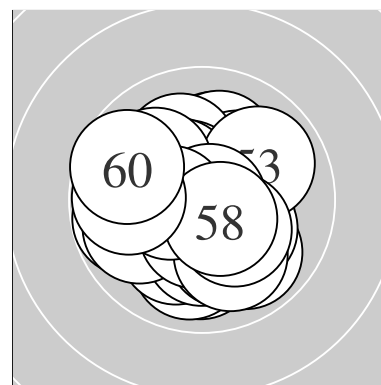

Serie 1:	10.7 *	10.0 ↓	10.1 ↘	9.9 ↓	10.3 *
	10.1 ↑	10.5 *	10.3 *	10.3 *	10.5 *
beste Teiler	53.3 (1.)	105.8 (7.)	122.8 (10.)		
Trefferlage	0.38 mm links, 0.30 mm tief				
Streuwert	1.30, horizontal: 0.77, vertikal: 1.67				

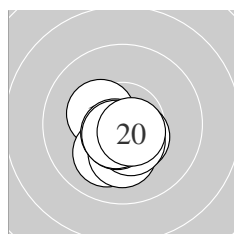

Serie 2:	10.6 *	10.3 *	10.1 ↘	10.2 *	10.5 *
	10.4 *	10.6 *	10.6 *	10.6 *	10.6 *
beste Teiler	76.4 (20.)	77.9 (17.)	80.9 (19.)		
Trefferlage	0.14 mm links, 0.84 mm tief				
Streuwert	0.74, horizontal: 0.74, vertikal: 0.74				

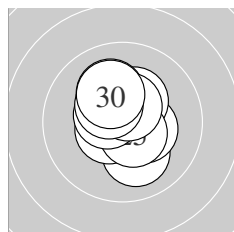

Serie 3:	10.1 ↘	10.4 *	10.5 *	10.3 *	10.6 *
	10.1 ↘	10.5 *	10.5 *	10.4 *	10.2 *
beste Teiler	99.7 (25.)	102.0 (23.)	106.8 (28.)		
Trefferlage	0.03 mm links, 0.40 mm hoch				
Streuwert	1.11, horizontal: 0.93, vertikal: 1.28				

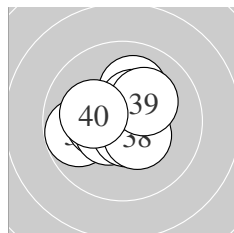

Serie 4:	10.1 ↑	10.9 *	9.8 ←	10.4 *	10.4 *
	10.5 *	10.6 *	10.4 *	10.2 *	10.2 *
beste Teiler	15.0 (32.)	80.0 (37.)	112.6 (36.)		
Trefferlage	0.32 mm links, 0.16 mm hoch				
Streuwert	1.23, horizontal: 1.40, vertikal: 1.03				

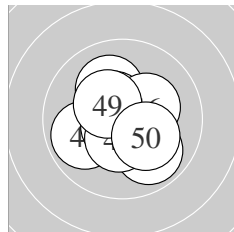

Serie 5:	10.1 ↘	10.5 *	10.7 *	9.9 ↘	9.9 ←
	10.3 *	10.7 *	10.4 *	10.4 *	10.2 *
beste Teiler	63.7 (43.)	69.3 (47.)	107.6 (42.)		
Trefferlage	0.02 mm links, 0.11 mm tief				
Streuwert	1.31, horizontal: 1.35, vertikal: 1.27				

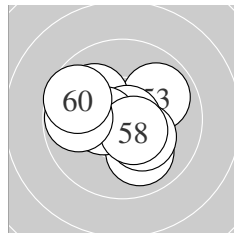

Serie 6:	10.6 *	10.0 ↘	9.9 ↗	10.0 ↘	10.3 *
	10.8 *	10.5 *	10.5 *	9.8 ←	9.7 ↘
beste Teiler	30.2 (56.)	91.4 (51.)	103.9 (58.)		
Trefferlage	0.42 mm links, 0.00 mm				
Streuwert	1.52, horizontal: 1.81, vertikal: 1.17				

Meyton Elektronik

ISSF AR Men – Wertung – Junioren

StandNr: 127

Smetana, Frantisek #70817160

StartNr: 76

3. Dezember 2017 12:47

CZE – Dukla Pilsen

QF – Schütze hat sich fürs Finale qualifiziert

Unterschrift des Schützen

Meyton Elektronik

Ergebnis: **608.8** (582)

Serien: 102.0 100.9 102.3 100.5 102.2 100.9

Zähler: 43 16 1 0 0 0 0 0 0 0

Innenzehner: 34

weiteste: 548 (39), 415 (52), 370 (30)

beste Teiler 25.7 (26.) 31.3 (53.) 43.0 (46.)

Trefferlage 0.22 mm rechts, 0.39 mm tief

Streuwert 1.56, horizontal: 1.69, vertikal: 1.41

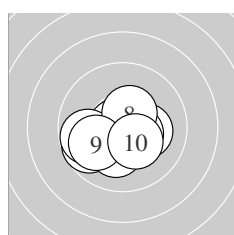
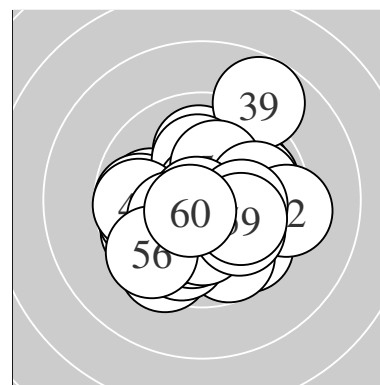

Serie 1:

9.7 ↙	10.2 *	10.2 *	10.2 *	10.5 *
10.7 *	9.8 ↙	10.4 *	10.0 ↙	10.3 *

beste Teiler 52.3 (6.) 119.8 (5.) 127.0 (8.)

Trefferlage 0.60 mm links, 0.69 mm tief

Streuwert 1.35, horizontal: 1.70, vertikal: 0.86

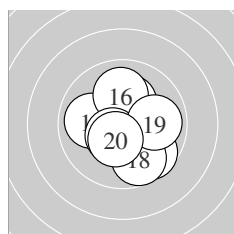

Serie 2:

9.7 ↘	10.3 *	10.2 *	9.9 ←	10.3 *
10.0 ↑	10.5 *	9.7 ↘	9.9 →	10.4 *

beste Teiler 122.5 (17.) 135.9 (20.) 161.9 (12.)

Trefferlage 0.47 mm rechts, 0.47 mm tief

Streuwert 1.60, horizontal: 1.55, vertikal: 1.65

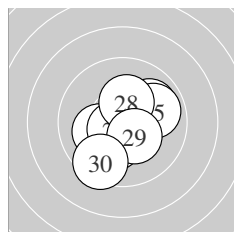

Serie 3:

10.5 *	9.9 ↗	10.2 *	10.1 ↙	9.9 →
10.9 *	10.6 *	10.3 *	10.4 *	9.5 ↘

beste Teiler 25.7 (26.) 86.4 (27.) 117.2 (21.)

Trefferlage 0.19 mm rechts, 0.31 mm tief

Streuwert 1.50, horizontal: 1.49, vertikal: 1.50

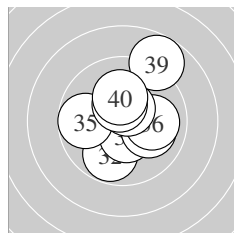

Serie 4:

10.5 *	9.8 ↘	10.5 *	10.1 ↗	9.7 ←
10.0 →	10.5 *	10.4 *	8.8 ↗	10.2 *

beste Teiler 109.9 (37.) 118.4 (33.) 121.5 (31.)

Trefferlage 0.44 mm rechts, 0.36 mm hoch

Streuwert 1.89, horizontal: 1.74, vertikal: 2.03

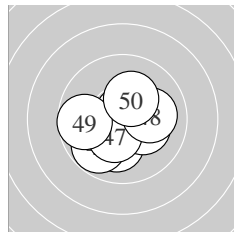

Serie 5:

10.1 ↓	10.3 *	9.8 ↙	10.6 *	10.2 *
10.8 *	10.4 *	10.1 →	9.7 ←	10.2 *

beste Teiler 43.0 (46.) 86.1 (44.) 144.9 (47.)

Trefferlage 0.08 mm rechts, 0.36 mm tief

Streuwert 1.46, horizontal: 1.67, vertikal: 1.20

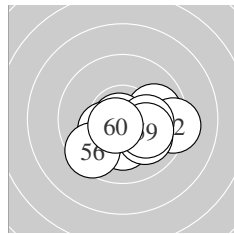

Serie 6:

9.9 →	9.3 →	10.8 *	10.2 *	10.3 *
9.5 ↙	10.0 ↘	10.2 *	10.1 ↗	10.6 *

beste Teiler 31.3 (53.) 78.5 (60.) 164.6 (55.)

Trefferlage 0.76 mm rechts, 0.85 mm tief

Streuwert 1.57, horizontal: 2.02, vertikal: 0.92

ISSF AR Men – Wertung – Junioren

StandNr: 128

Kuen, Johannes #70817441

StartNr: 77

3. Dezember 2017 12:32

T – SG Matri

Unterschrift des Schützen

Meyton Elektronik

Ergebnis:	610.5	(586)
Serien:	101.5	99.1 101.4 102.9 102.2 103.4
Zähler:	46	14 0 0 0 0 0 0 0 0
Innenzehner:	32	
weiteste:	480	(12), 407 (11), 363 (18)
beste Teiler	50.0	(25.) 51.0 (5.) 51.7 (50.)
Trefferlage	0.25 mm links, 0.03 mm hoch	
Streuwert	1.53, horizontal: 1.59, vertikal: 1.46	

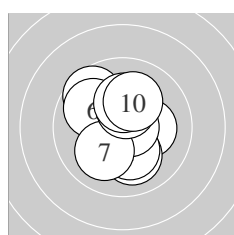
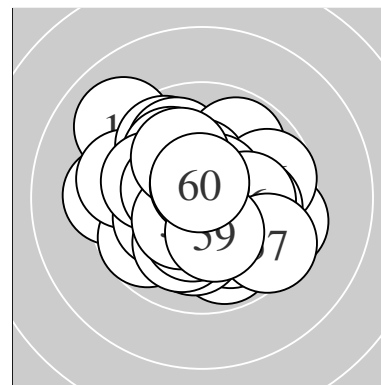

Serie 1:	10.2 *	10.1 ↘	9.6 ↖	10.2 *	10.7 *
	9.9 ↖	10.1 ↙	10.4 *	10.2 *	10.1 ↗
beste Teiler	51.0 (5.) 140.2 (8.) 181.8 (4.)				
Trefferlage	0.11 mm links, 0.32 mm hoch				
Streuwert	1.55, horizontal: 1.38, vertikal: 1.71				

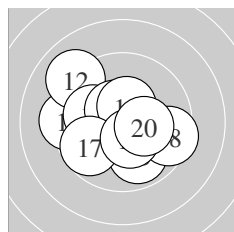

Serie 2:	9.3 ←	9.0 ↖	10.0 ←	10.5 *	10.5 *
	9.9 ↘	9.7 ↙	9.5 →	10.4 *	10.3 *
beste Teiler	111.5 (14.) 123.6 (15.) 135.1 (19.)				
Trefferlage	0.58 mm links, 0.07 mm tief				
Streuwert	2.09, horizontal: 2.44, vertikal: 1.66				

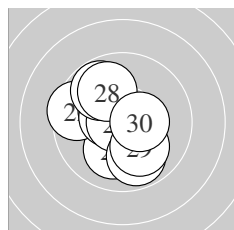

Serie 3:	10.1 ↘	9.5 ←	10.4 *	10.5 *	10.8 *
	9.8 ↖	9.9 ↘	9.9 ↖	10.1 ↘	10.4 *
beste Teiler	50.0 (25.) 112.2 (24.) 129.0 (30.)				
Trefferlage	0.61 mm links, 0.03 mm hoch				
Streuwert	1.61, horizontal: 1.49, vertikal: 1.72				

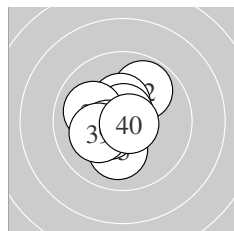

Serie 4:	10.3 *	9.8 ↗	10.3 *	10.4 *	10.1 ↘
	10.7 *	10.0 ←	10.4 *	10.2 *	10.7 *
beste Teiler	52.9 (40.) 58.4 (36.) 128.7 (38.)				
Trefferlage	0.35 mm links, 0.10 mm hoch				
Streuwert	1.30, horizontal: 1.14, vertikal: 1.44				

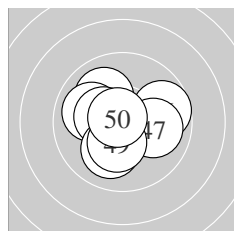

Serie 5:	10.0 ↖	10.3 *	10.0 ←	10.7 *	10.4 *
	9.7 →	10.0 →	10.1 ↘	10.3 *	10.7 *
beste Teiler	51.7 (50.) 52.7 (44.) 149.7 (45.)				
Trefferlage	0.29 mm links, 0.13 mm tief				
Streuwert	1.47, horizontal: 1.66, vertikal: 1.25				

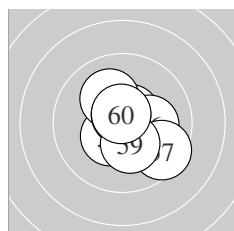

Serie 6:	10.5 *	10.4 *	10.6 *	10.1 ↖	10.5 *
	10.1 →	9.5 ↘	10.7 *	10.3 *	10.7 *
beste Teiler	61.1 (58.) 69.8 (60.) 87.3 (53.)				
Trefferlage	0.44 mm rechts, 0.06 mm tief				
Streuwert	1.25, horizontal: 1.26, vertikal: 1.24				

Meyton Elektronik

ISSF AR Men – Wertung – Junioren

StandNr: 129

Riccardo, Ranzani #70804224

StartNr: 78

3. Dezember 2017 12:37

ITA – TSN Veroli

Unterschrift des Schützen

Meyton Elektronik

Ergebnis:	596.3	(570)
Serien:	101.8 97.3 101.9 99.8 98.4 97.1	
Zähler:	34 22 4 0 0 0 0 0 0 0	
Innenzehner:	23	
weiteste:	649 (49), 547 (52), 532 (15)	
beste Teiler	45.8 (30.) 54.1 (60.) 71.0 (2.)	
Trefferlage	0.02 mm links, 0.36 mm hoch	
Streuwert	2.04, horizontal: 2.34, vertikal: 1.70	

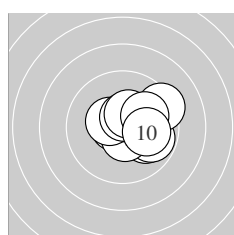
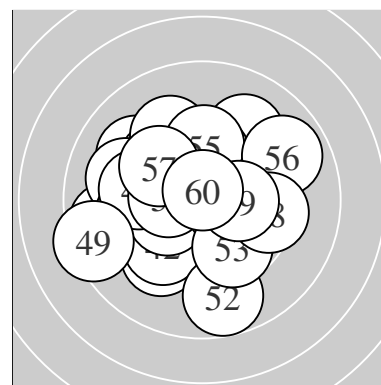

Serie 1:	10.0 ↘	10.7 *	9.8 ↘	10.6 *	10.4 *
	9.3 ↗	10.6 *	10.4 *	10.0 ↗	10.0 →
beste Teiler	71.0 (2.)	94.5 (7.)	97.7 (4.)		
Trefferlage	1.15 mm rechts, 0.21 mm hoch				
Streuwert	1.34, horizontal: 1.58, vertikal: 1.06				

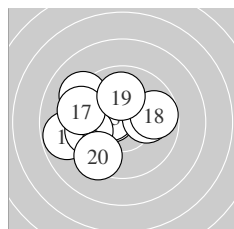

Serie 2:	9.2 ↖	10.5 *	10.4 *	10.1 →	8.8 ←
	9.7 ←	9.4 ←	9.8 →	10.0 ↑	9.4 ↙
beste Teiler	111.3 (12.)	126.2 (13.)	225.0 (14.)		
Trefferlage	1.53 mm links, 0.26 mm hoch				
Streuwert	2.21, horizontal: 2.64, vertikal: 1.68				

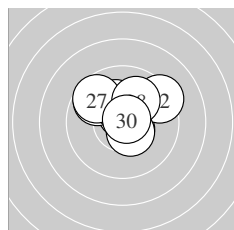

Serie 3:	10.6 *	9.3 ↗	10.4 *	10.7 *	9.7 ↖
	10.2 *	9.7 ↖	10.0 ↗	10.5 *	10.8 *
beste Teiler	45.8 (30.)	74.0 (24.)	99.1 (21.)		
Trefferlage	0.06 mm rechts, 1.06 mm hoch				
Streuwert	1.47, horizontal: 1.72, vertikal: 1.16				

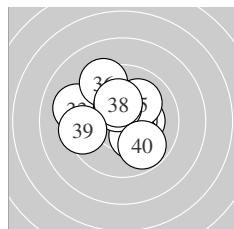

Serie 4:	10.3 *	10.6 *	9.2 ↖	10.3 *	10.1 ↗
	9.4 ↖	10.4 *	10.3 *	9.4 ←	9.8 ↘
beste Teiler	96.0 (32.)	134.4 (37.)	165.4 (34.)		
Trefferlage	0.37 mm links, 0.51 mm hoch				
Streuwert	1.98, horizontal: 2.22, vertikal: 1.71				

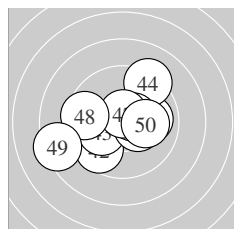

Serie 5:	10.0 →	9.6 ↙	10.1 ←	9.2 ↗	10.4 *
	10.5 *	10.6 *	9.5 ←	8.4 ←	10.1 →
beste Teiler	76.2 (47.)	109.5 (46.)	150.5 (45.)		
Trefferlage	0.43 mm links, 0.05 mm tief				
Streuwert	2.38, horizontal: 2.89, vertikal: 1.74				

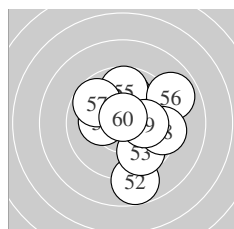

Serie 6:	9.9 ↑	8.8 ↓	9.7 ↘	10.2 *	9.7 ↑
	8.9 ↗	9.7 ↖	9.4 →	10.1 →	10.7 *
beste Teiler	54.1 (60.)	188.6 (54.)	205.0 (59.)		
Trefferlage	0.94 mm rechts, 0.18 mm hoch				
Streuwert	2.40, horizontal: 2.18, vertikal: 2.61				

ISSF AR Men – Wertung – Junioren

StandNr: 130

Lüthi, Julius #70804363

StartNr: 79

3. Dezember 2017 12:51

T – SG Thierberg

Unterschrift des Schützen

Meyton Elektronik

Ergebnis:	610.4	(583)
Serien:	102.9	102.9 102.7 103.6 98.1 100.2
Zähler:	45	13 2 0 0 0 0 0 0 0
Innenzehner:	36	
weiteste:	572 (43), 501 (57), 470 (24)	
beste Teiler	7.2 (10.)	37.2 (55.) 45.6 (53.)
Trefferlage	0.11 mm links,	0.22 mm hoch
Streuwert	1.65,	horizontal: 2.06, vertikal: 1.11

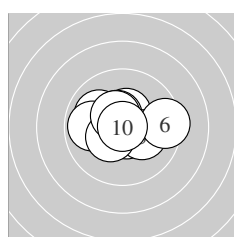
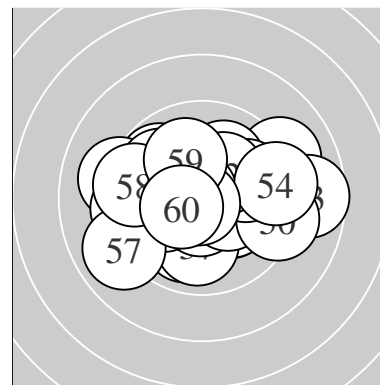

Serie 1:

10.4 *	10.0 ↖	10.7 *	9.9 ←	10.2 *
9.4 →	10.5 *	10.4 *	10.5 *	10.9 *
beste Teiler	7.2 (10.)	71.3 (3.)	117.6 (7.)	
Trefferlage	0.08 mm links, 0.28 mm hoch			
Streuwert	1.44, horizontal: 1.87, vertikal: 0.81			

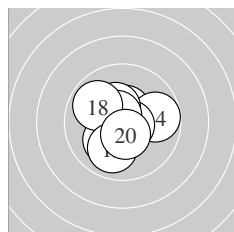

Serie 2:

10.1 ↙	10.4 *	10.5 *	9.8 →	10.7 *
10.4 *	10.6 *	9.9 ↘	10.0 ↓	10.5 *
beste Teiler	68.5 (15.)	80.8 (17.)	110.3 (13.)	
Trefferlage	0.24 mm links, 0.07 mm hoch			
Streuwert	1.37, horizontal: 1.41, vertikal: 1.33			

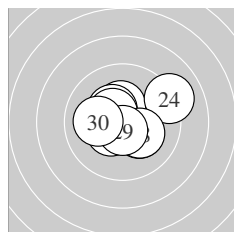

Serie 3:

10.4 *	10.7 *	10.4 *	9.1 →	10.4 *
10.5 *	10.2 *	10.2 *	10.7 *	10.1 ←
beste Teiler	62.6 (22.)	75.0 (29.)	119.7 (26.)	
Trefferlage	0.16 mm rechts, 0.15 mm hoch			
Streuwert	1.52, horizontal: 1.82, vertikal: 1.15			

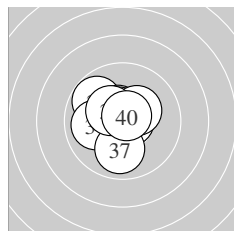

Serie 4:

10.7 *	9.8 ↘	10.6 *	10.0 ←	10.5 *
10.6 *	10.0 ↓	10.3 *	10.4 *	10.7 *
beste Teiler	59.0 (31.)	60.0 (40.)	88.3 (36.)	
Trefferlage	0.39 mm links, 0.38 mm hoch			
Streuwert	1.20, horizontal: 1.23, vertikal: 1.17			

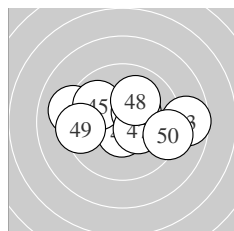

Serie 5:

9.1 ↖	10.5 *	8.7 →	10.6 *	9.9 ↘
10.3 *	10.3 *	10.0 ↗	9.4 ←	9.3 →
beste Teiler	91.3 (44.)	111.0 (42.)	151.6 (46.)	
Trefferlage	0.39 mm rechts, 0.28 mm hoch			
Streuwert	2.39, horizontal: 3.21, vertikal: 1.07			

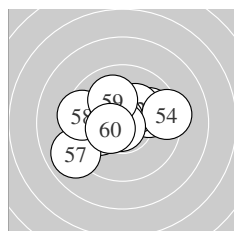

Serie 6:

9.9 →	10.3 *	10.8 *	9.3 →	10.8 *
10.1 ←	8.9 ↙	9.5 ←	10.1 ↗	10.5 *
beste Teiler	37.2 (55.)	45.6 (53.)	121.3 (60.)	
Trefferlage	0.50 mm links, 0.18 mm hoch			
Streuwert	2.03, horizontal: 2.54, vertikal: 1.33			

Meyton Elektronik

ISSF AR Men – Wertung – Junioren

StandNr: 131

Löschl, Michael #70817155

StartNr: 80

3. Dezember 2017 12:56

NÖ

Unterschrift des Schützen

Meyton Elektronik

Ergebnis:	614.1	(589) ^{QF}							
Serien:	101.5	101.8	103.4	101.6	103.3	102.5			
Zähler:	49	11	0	0	0	0	0	0	0
Innenzehner:	38								
weiteste:	327 (6), 322 (35), 309 (18)								
beste Teiler	53.1 (43.)	59.4 (32.)	65.1 (22.)						
Trefferlage	0.06 mm links, 0.17 mm hoch								
Streuwert	1.37, horizontal: 1.56, vertikal: 1.15								

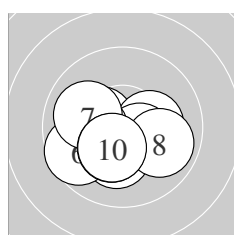
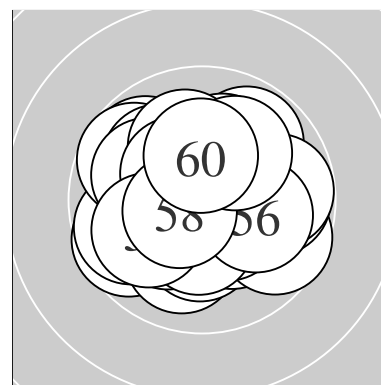

Serie 1:	10.3 *	10.2 *	10.4 *	10.2 *	10.2 *
	9.6 ↙	10.0 ↖	9.9 ↘	10.3 *	10.4 *
beste Teiler	130.5 (3.)	150.7 (10.)	153.8 (1.)		
Trefferlage	0.50 mm links, 0.64 mm tief				
Streuwert	1.40, horizontal: 1.77, vertikal: 0.90				

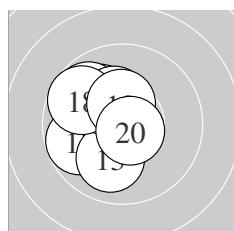

Serie 2:	9.8 ↙	10.7 *	10.0 ↓	10.1 ↘	9.8 ↘
	10.3 *	10.3 *	9.7 ↖	10.4 *	10.7 *
beste Teiler	65.9 (20.)	73.7 (12.)	134.3 (19.)		
Trefferlage	1.15 mm links, 0.60 mm hoch				
Streuwert	1.26, horizontal: 1.11, vertikal: 1.39				

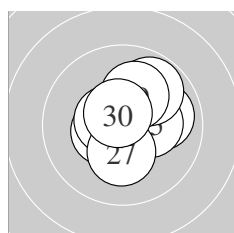

Serie 3:	10.5 *	10.7 *	9.9 →	10.6 *	10.3 *
	10.6 *	10.3 *	9.8 ↗	10.1 ↑	10.6 *
beste Teiler	65.1 (22.)	83.9 (30.)	98.4 (24.)		
Trefferlage	0.54 mm rechts, 0.46 mm hoch				
Streuwert	1.16, horizontal: 1.19, vertikal: 1.12				

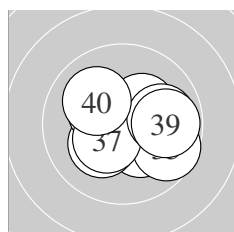

Serie 4:	10.3 *	10.7 *	10.2 *	10.3 *	9.7 ↘
	10.3 *	10.4 *	9.9 →	9.8 →	10.0 ↖
beste Teiler	59.4 (32.)	140.8 (37.)	154.6 (34.)		
Trefferlage	0.49 mm rechts, 0.06 mm tief				
Streuwert	1.51, horizontal: 1.84, vertikal: 1.09				

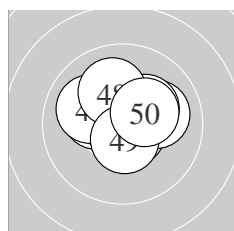

Serie 5:	10.6 *	10.1 →	10.7 *	10.2 *	10.5 *
	10.2 *	10.0 ↖	10.1 ↖	10.6 *	10.3 *
beste Teiler	53.1 (43.)	76.4 (41.)	100.9 (49.)		
Trefferlage	0.01 mm links, 0.52 mm hoch				
Streuwert	1.17, horizontal: 1.42, vertikal: 0.85				

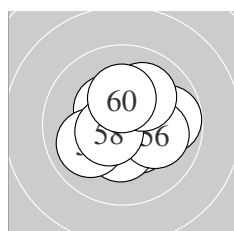

Serie 6:	10.4 *	10.4 *	9.8 →	10.4 *	10.4 *
	10.1 →	10.0 ↙	10.6 *	10.1 ↑	10.3 *
beste Teiler	97.9 (58.)	131.5 (51.)	134.3 (54.)		
Trefferlage	0.26 mm rechts, 0.15 mm hoch				
Streuwert	1.40, horizontal: 1.54, vertikal: 1.24				

ISSF AR Men – Wertung – Junioren

StandNr: 132

Fankhauser, Thomas #88

StartNr: 81

3. Dezember 2017 12:30

T – SG Fügenberg

QF – Schütze hat sich fürs Finale qualifiziert

Unterschrift des Schützen

Meyton Elektronik

Ergebnis: **592.8** (567)

Serien: 96.8 101.1 98.8 97.2 97.7 101.2

Zähler: 32 23 5 0 0 0 0 0 0 0

Innenzehner: 22

weiteste: 632 (12), 622 (48), 611 (37)

beste Teiler 70.0 (24.) 75.5 (16.) 112.0 (19.)

Trefferlage 0.37 mm rechts, 0.29 mm hoch

Streuwert 2.13, horizontal: 2.28, vertikal: 1.95

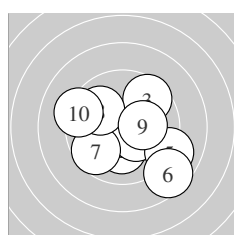
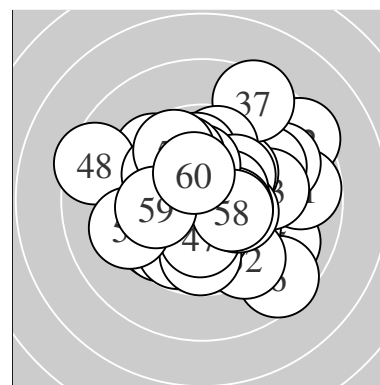

Serie 1:

10.1 ↙	10.1 ↓	9.6 ↗	10.3 *	9.0 →
8.6 ↘	9.7 ↖	9.9 ↖	10.2 *	9.3 ↖

beste Teiler 151.8 (4.) 185.8 (9.) 203.1 (2.)

Trefferlage 0.36 mm rechts, 0.72 mm tief

Streuwert 2.51, horizontal: 2.86, vertikal: 2.10

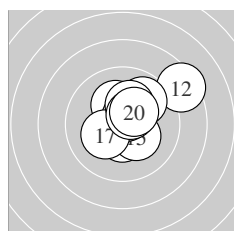

Serie 2:

10.2 *	8.4 ↗	9.8 ↗	10.5 *	10.3 *
10.7 *	10.2 *	10.2 *	10.5 *	10.3 *

beste Teiler 75.5 (16.) 112.0 (19.) 124.0 (14.)

Trefferlage 0.89 mm rechts, 0.83 mm hoch

Streuwert 1.69, horizontal: 1.85, vertikal: 1.53

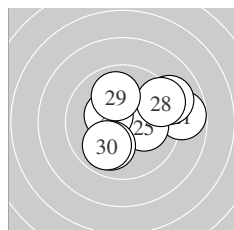

Serie 3:

8.8 →	10.4 *	9.1 ↗	10.7 *	10.1 →
10.4 *	10.0 ↙	9.4 ↗	10.0 ↑	9.9 ↙

beste Teiler 70.0 (24.) 142.2 (26.) 148.9 (22.)

Trefferlage 1.27 mm rechts, 0.33 mm hoch

Streuwert 2.08, horizontal: 2.47, vertikal: 1.59

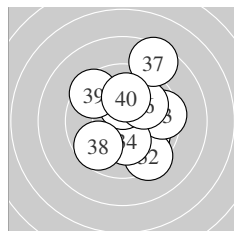

Serie 4:

9.9 ↘	9.4 ↘	9.5 →	10.2 *	10.4 *
10.0 ↗	8.5 ↑	9.7 ↖	9.5 ↖	10.1 ↑

beste Teiler 148.0 (35.) 182.7 (34.) 219.2 (40.)

Trefferlage 0.87 mm rechts, 0.50 mm hoch

Streuwert 2.39, horizontal: 2.10, vertikal: 2.65

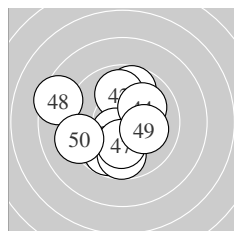

Serie 5:

9.7 ↑	9.9 ↑	10.5 *	10.1 ↗	9.8 ↙
9.8 ↓	10.1 ↓	8.5 ↖	10.1 →	9.2 ↖

beste Teiler 116.7 (43.) 201.3 (47.) 207.4 (49.)

Trefferlage 0.77 mm links, 0.20 mm tief

Streuwert 2.35, horizontal: 2.47, vertikal: 2.22

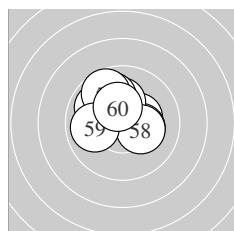

Serie 6:

10.4 *	10.3 *	10.2 *	10.3 *	9.9 ↖
9.9 ↘	9.7 ↘	10.3 *	9.9 ↖	10.3 *

beste Teiler 149.6 (51.) 151.9 (54.) 154.6 (60.)

Trefferlage 0.40 mm links, 1.01 mm hoch

Streuwert 1.38, horizontal: 1.54, vertikal: 1.20

ISSF AR Men – Wertung – Junioren

StandNr: 133

Erler, Sebastian #70804360

StartNr: 82

3. Dezember 2017 12:35

T – SG Wattens

Unterschrift des Schützen

Meyton Elektronik

Ergebnis:	596.7	(574)
Serien:	101.5 97.0 98.8 98.1 100.5 100.8	
Zähler:	36 22 2 0 0 0 0 0 0 0	
Innenzehner:	19	
weiteste:	642 (15), 542 (34), 470 (25)	
beste Teiler	97.5 (59.) 113.6 (47.) 117.1 (22.)	
Trefferlage	0.22 mm rechts, 0.69 mm hoch	
Streuwert	1.88, horizontal: 2.06, vertikal: 1.67	

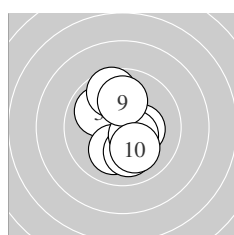
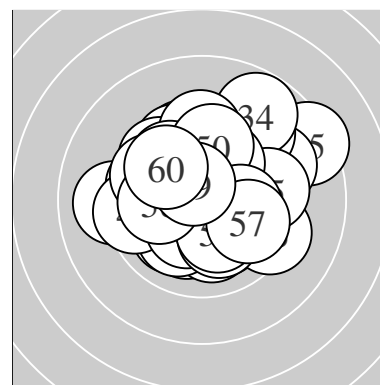

Serie 1:	10.5 *	10.4 *	9.9 ↖	10.1 ↙	10.1 ↘
	10.3 *	9.6 ↗	10.5 *	10.0 ↑	10.1 ↘
beste Teiler	120.2 (8.)	120.9 (1.)	142.2 (2.)		
Trefferlage	0.00 mm , 0.04 mm tief				
Streuwert	1.57, horizontal: 1.15, vertikal: 1.90				

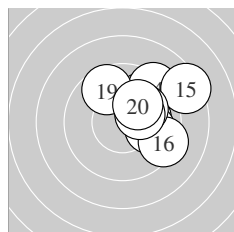

Serie 2:	9.8 ↗	10.1 →	9.9 →	9.3 ↗	8.4 ↗
	9.3 ↘	10.1 ↗	10.3 *	9.7 ↖	10.1 ↗
beste Teiler	169.6 (18.)	206.9 (20.)	215.3 (12.)		
Trefferlage	2.16 mm rechts, 1.26 mm hoch				
Streuwert	1.71, horizontal: 1.80, vertikal: 1.63				

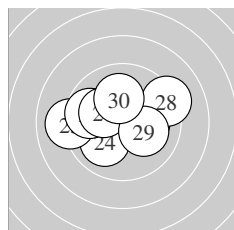

Serie 3:	10.1 →	10.5 *	9.8 ↖	10.0 ↙	9.1 ←
	9.7 ↖	10.2 *	9.2 ↗	10.1 ↘	10.1 ↑
beste Teiler	117.1 (22.)	189.6 (27.)	201.0 (21.)		
Trefferlage	0.72 mm links, 0.31 mm hoch				
Streuwert	2.05, horizontal: 2.65, vertikal: 1.19				

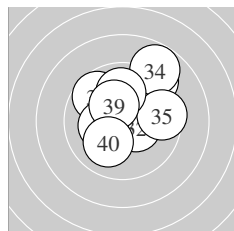

Serie 4:	10.2 *	10.4 *	9.1 ↗	8.8 ↗	9.5 →
	9.7 ↖	9.9 ↑	10.2 *	10.3 *	10.0 ↙
beste Teiler	129.4 (32.)	162.4 (39.)	179.5 (38.)		
Trefferlage	0.53 mm rechts, 1.35 mm hoch				
Streuwert	2.03, horizontal: 2.08, vertikal: 1.98				

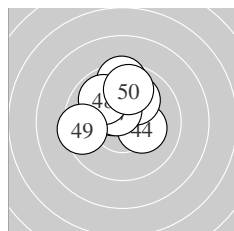

Serie 5:	10.2 *	10.5 *	9.5 ↑	10.2 *	10.0 ↗
	10.4 *	10.5 *	9.9 ↖	9.5 ←	9.8 ↑
beste Teiler	113.6 (47.)	120.8 (42.)	138.7 (46.)		
Trefferlage	0.27 mm links, 1.41 mm hoch				
Streuwert	1.46, horizontal: 1.55, vertikal: 1.36				

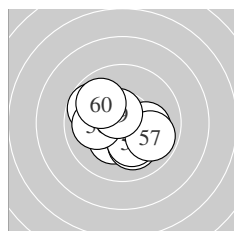

Serie 6:	9.7 ↖	10.3 *	10.1 →	10.0 ↖	10.1 ↘
	10.2 *	9.9 ↘	10.0 ←	10.6 *	9.9 ↖
beste Teiler	97.5 (59.)	164.8 (52.)	185.5 (56.)		
Trefferlage	0.37 mm links, 0.13 mm tief				
Streuwert	1.64, horizontal: 1.86, vertikal: 1.39				

Meyton Elektronik

ISSF AR Men – Wertung – Junioren

StandNr: 134

Egger, Martin #117

StartNr: 83

3. Dezember 2017 12:30

NÖ

Unterschrift des Schützen

Meyton Elektronik

Ergebnis:	569.5	(544)
Serien:	99.6 94.4 95.6 94.8 98.3 86.8	
Zähler:	23 21 13 3 0 0 0 0 0 0	
Innenzehner:	13	
weiteste:	849 (55), 815 (23), 754 (60)	
beste Teiler	95.2 (47.) 102.7 (14.) 117.3 (7.)	
Trefferlage	0.92 mm links, 0.30 mm tief	
Streuwert	2.84, horizontal: 3.20, vertikal: 2.42	

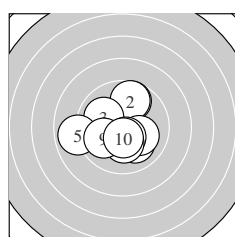
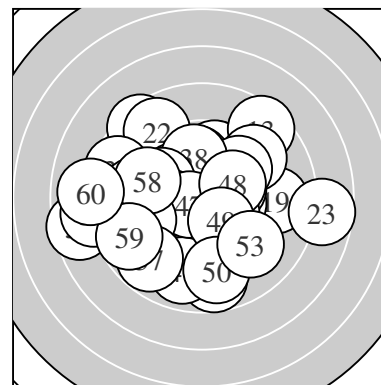

Serie 1:	9.7 ↑	9.7 ↑	10.0 ↘	10.0 ↘	8.9 ←
	10.1 ↘	10.5 *	10.2 *	10.0 ↙	10.5 *
beste Teiler	117.3 (7.)	121.2 (10.)	179.6 (8.)		
Trefferlage	0.35 mm links, 0.19 mm tief				
Streuwert	1.99, horizontal: 2.12, vertikal: 1.85				

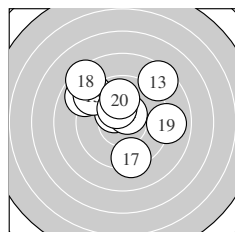

Serie 2:	8.9 ↘	10.4 *	8.5 ↗	10.5 *	9.2 ↘
	10.3 *	9.3 ↓	8.4 ↘	9.0 →	9.9 ↑
beste Teiler	102.7 (14.)	139.6 (12.)	165.8 (16.)		
Trefferlage	0.32 mm links, 1.72 mm hoch				
Streuwert	2.86, horizontal: 3.13, vertikal: 2.56				

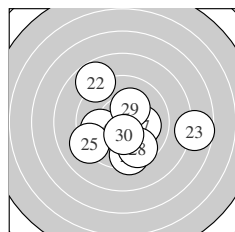

Serie 3:	9.5 ↓	8.8 ↘	7.7 →	9.9 ←	9.2 ↘
	10.2 *	10.1 →	9.6 ↘	10.2 *	10.4 *
beste Teiler	140.6 (30.)	180.2 (29.)	196.6 (26.)		
Trefferlage	0.61 mm rechts, 0.71 mm tief				
Streuwert	2.91, horizontal: 3.39, vertikal: 2.34				

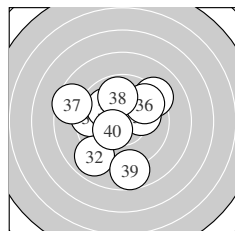

Serie 4:	9.5 ←	8.9 ↙	9.2 ↗	10.1 →	10.0 ↘
	9.7 ↗	8.5 ←	9.8 ↑	8.7 ↓	10.4 *
beste Teiler	148.9 (40.)	218.2 (34.)	236.1 (35.)		
Trefferlage	0.71 mm links, 0.15 mm hoch				
Streuwert	2.89, horizontal: 2.96, vertikal: 2.81				

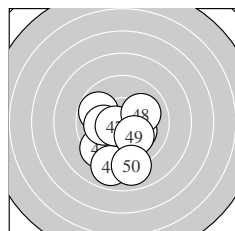

Serie 5:	9.8 ↘	10.2 *	9.4 ↙	10.1 ←	10.2 *
	8.9 ↓	10.6 *	10.0 →	10.1 ↘	9.0 ↓
beste Teiler	95.2 (47.)	189.3 (45.)	195.6 (42.)		
Trefferlage	0.23 mm links, 1.53 mm tief				
Streuwert	2.00, horizontal: 1.87, vertikal: 2.12				

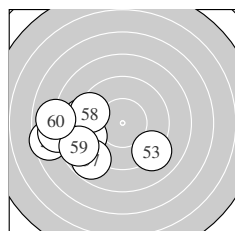

Serie 6:	8.9 ←	9.1 ←	9.1 ↘	9.3 ←	7.6 ←
	8.0 ←	8.8 ↙	9.4 ←	8.7 ←	7.9 ←
beste Teiler	388.0 (58.)	425.5 (54.)	453.3 (53.)		
Trefferlage	4.55 mm links, 1.26 mm tief				
Streuwert	2.58, horizontal: 3.23, vertikal: 1.70				

Meyton Elektronik

ISSF AR Men – Wertung – Junioren

StandNr: 135

Greber, Alexander #70809022

StartNr: 84

3. Dezember 2017 12:29

T – SG Fügenberg

Unterschrift des Schützen

Meyton Elektronik

Ergebnis:	609.7	(586)
Serien:	102.6	101.3 101.1 102.9 100.9 100.9
Zähler:	46	14 0 0 0 0 0 0 0 0
Innenzehner:	35	
weiteste:	491	(52), 485 (14), 435 (28)
beste Teiler	14.0	(22.) 18.0 (9.) 63.3 (29.)
Trefferlage	0.28 mm links, 0.17 mm hoch	
Streuwert	1.58, horizontal: 1.81, vertikal: 1.29	

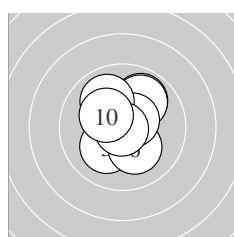
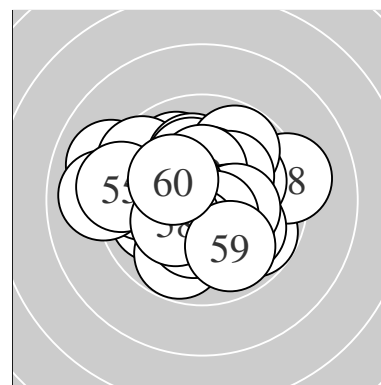

Serie 1:	9.9 ↗	10.3 *	10.1 ↘	9.9 ↗	10.4 *
	10.2 *	10.6 *	10.0 ↘	10.9 *	10.3 *
beste Teiler	18.0 (9.) 100.2 (7.) 136.5 (5.)				
Trefferlage	0.12 mm links, 0.67 mm hoch				
Streuwert	1.32, horizontal: 1.21, vertikal: 1.42				

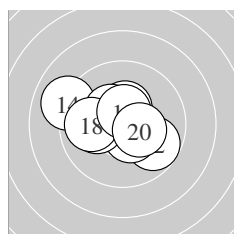

Serie 2:	10.3 *	9.8 ↘	10.4 *	9.0 ↖	10.4 *
	10.5 *	10.1 ←	9.9 ←	10.5 *	10.4 *
beste Teiler	103.5 (19.) 116.4 (16.) 135.4 (13.)				
Trefferlage	0.67 mm links, 0.25 mm hoch				
Streuwert	1.66, horizontal: 2.08, vertikal: 1.08				

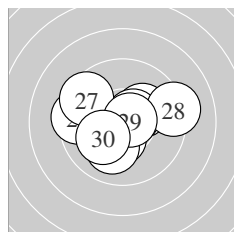

Serie 3:	10.4 *	10.9 *	10.1 ↘	9.5 ←	10.2 *
	10.5 *	9.5 ↖	9.2 →	10.7 *	10.1 ↘
beste Teiler	14.0 (22.) 63.3 (29.) 101.2 (26.)				
Trefferlage	0.19 mm links, 0.03 mm hoch				
Streuwert	1.84, horizontal: 2.29, vertikal: 1.24				

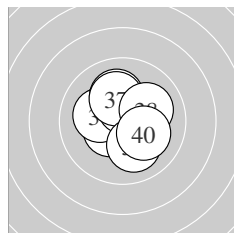

Serie 4:	10.7 *	10.5 *	10.3 *	10.2 *	10.5 *
	10.1 ↑	10.2 *	10.1 ↗	10.1 ↘	10.2 *
beste Teiler	73.6 (31.) 115.1 (35.) 125.9 (32.)				
Trefferlage	0.01 mm links, 0.40 mm hoch				
Streuwert	1.29, horizontal: 1.31, vertikal: 1.28				

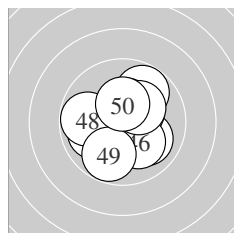

Serie 5:	10.0 ←	10.0 ↘	9.8 ↗	10.4 *	10.4 *
	10.1 ↘	10.2 *	9.8 ←	9.8 ↘	10.4 *
beste Teiler	143.6 (45.) 146.4 (44.) 149.0 (50.)				
Trefferlage	0.13 mm rechts, 0.10 mm hoch				
Streuwert	1.68, horizontal: 1.71, vertikal: 1.65				

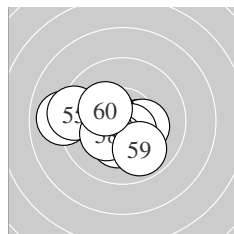

Serie 6:	10.4 *	9.0 ←	10.3 *	10.5 *	9.3 ←
	10.6 *	10.3 *	10.3 *	9.9 ↘	10.3 *
beste Teiler	97.4 (56.) 125.3 (54.) 140.4 (51.)				
Trefferlage	0.83 mm links, 0.43 mm tief				
Streuwert	1.75, horizontal: 2.25, vertikal: 1.06				

ISSF AR Men – Wertung – Junioren

StandNr: 136

Moravek, Tomas #70817534

StartNr: 85

3. Dezember 2017 12:49

CZE – Dukla Pilsen

Unterschrift des Schützen

Meyton Elektronik

Ergebnis:	610.5	(586)
Serien:	99.7	102.7 101.7 101.4 102.0 103.0
Zähler:	46	14 0 0 0 0 0 0 0 0
Innenzehner:	35	
weiteste:	490 (3), 478 (48), 320 (52)	
beste Teiler	53.0 (58.)	61.0 (15.) 69.0 (59.)
Trefferlage	0.29 mm rechts, 0.13 mm hoch	
Streuwert	1.51, horizontal: 1.64, vertikal: 1.38	

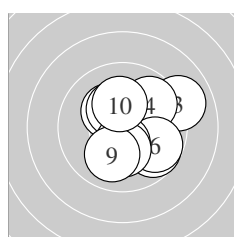
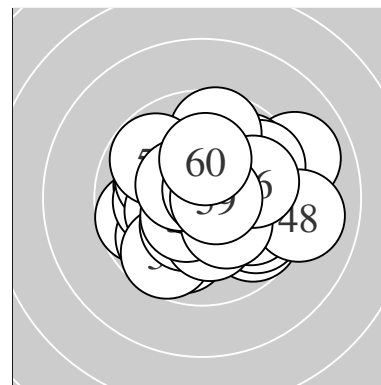

Serie 1:

10.3 *	10.3 *	9.0 ↗	9.8 ↗	9.7 ↘
9.8 ↘	10.4 *	10.2 *	10.0 ↓	10.2 *
beste Teiler	129.0 (7.)	163.2 (2.)	172.9 (1.)	
Trefferlage	0.89 mm rechts, 0.00 mm			
Streuwert	1.86, horizontal: 1.91, vertikal: 1.82			

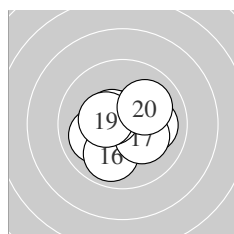

Serie 2:

10.3 *	10.7 *	10.0 ↖	10.0 →	10.7 *
9.9 ↓	10.2 *	10.5 *	10.4 *	10.0 ↗
beste Teiler	61.0 (15.)	71.5 (12.)	103.1 (18.)	
Trefferlage	0.00 mm , 0.37 mm tief			
Streuwert	1.32, horizontal: 1.48, vertikal: 1.14			

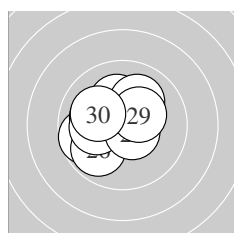

Serie 3:

9.7 ↖	10.6 *	10.2 *	10.1 ↖	10.1 ↗
9.9 ↙	10.1 ←	10.6 *	10.3 *	10.1 ↖
beste Teiler	83.6 (22.)	96.0 (28.)	157.0 (29.)	
Trefferlage	0.77 mm links, 0.32 mm hoch			
Streuwert	1.43, horizontal: 1.62, vertikal: 1.21			

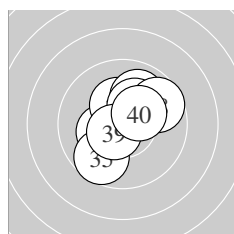

Serie 4:

10.3 *	10.3 *	10.0 ↗	10.3 *	9.7 ↓
10.0 ↗	10.2 *	9.7 ↗	10.6 *	10.3 *
beste Teiler	94.0 (39.)	151.7 (31.)	159.4 (40.)	
Trefferlage	0.43 mm rechts, 0.68 mm hoch			
Streuwert	1.49, horizontal: 1.46, vertikal: 1.52			

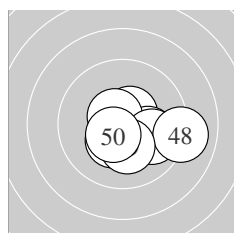

Serie 5:

10.3 *	10.2 *	10.5 *	10.7 *	10.1 ↘
10.6 *	9.9 ↘	9.0 →	10.2 *	10.5 *
beste Teiler	75.2 (44.)	88.3 (46.)	101.6 (43.)	
Trefferlage	0.96 mm rechts, 0.69 mm tief			
Streuwert	1.35, horizontal: 1.73, vertikal: 0.81			

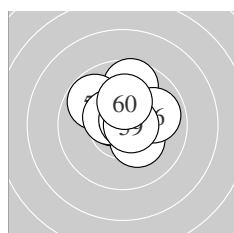

Serie 6:

10.6 *	9.7 ↑	10.3 *	10.6 *	9.8 ↘
9.9 →	10.5 *	10.7 *	10.7 *	10.2 *
beste Teiler	53.0 (58.)	69.0 (59.)	86.2 (51.)	
Trefferlage	0.22 mm rechts, 0.86 mm hoch			
Streuwert	1.24, horizontal: 1.30, vertikal: 1.19			

Meyton Elektronik

ISSF AR Men – Wertung – Junioren

StandNr: 137

Diem, Patrick #81

StartNr: 86

3. Dezember 2017 13:02

AUT

Unterschrift des Schützen

Meyton Elektronik

Ergebnis:	616.4	(591) ^{QF}							
Serien:	102.1	101.8	102.3	104.1	102.4	103.7			
Zähler:	51	9	0	0	0	0	0	0	0
Innenzehner:	43								
weiteste:	383 (24), 335 (17), 318 (21)								
beste Teiler	41.7 (31.)	51.1 (60.)	54.6 (35.)						
Trefferlage	0.07 mm links, 0.15 mm hoch								
Streuwert	1.32, horizontal: 1.57, vertikal: 1.02								

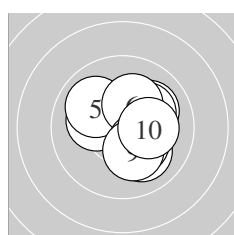
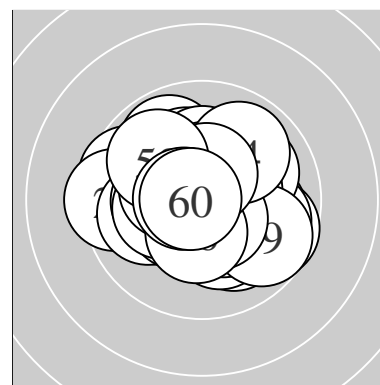

Serie 1:	10.1 ↗	10.2 *	10.2 *	10.6 *	10.0 ↘
	10.2 *	10.1 ↘	10.3 *	10.2 *	10.2 *
beste Teiler	88.7 (4.)	166.1 (8.)	182.7 (6.)		
Trefferlage	0.64 mm rechts, 0.17 mm hoch				
Streuwert	1.37, horizontal: 1.43, vertikal: 1.30				

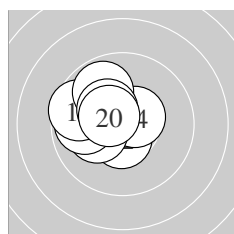

Serie 2:	10.3 *	10.5 *	10.3 *	10.5 *	10.2 *
	9.8 ←	9.6 ←	9.8 ↘	10.3 *	10.5 *
beste Teiler	102.3 (12.)	104.4 (14.)	115.7 (20.)		
Trefferlage	1.36 mm links, 0.47 mm hoch				
Streuwert	1.08, horizontal: 1.19, vertikal: 0.97				

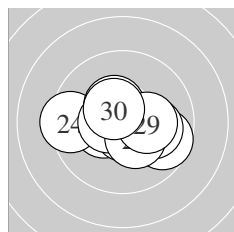

Serie 3:	9.7 ↘	10.4 *	10.7 *	9.4 ←	10.1 →
	10.5 *	10.4 *	10.4 *	10.2 *	10.5 *
beste Teiler	68.6 (23.)	104.0 (26.)	115.3 (30.)		
Trefferlage	0.04 mm rechts, 0.18 mm tief				
Streuwert	1.52, horizontal: 2.00, vertikal: 0.80				

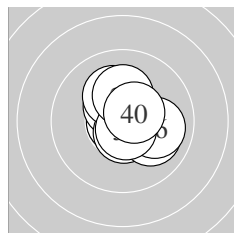

Serie 4:	10.8 *	10.4 *	10.6 *	10.0 ↘	10.7 *
	10.0 →	10.2 *	10.7 *	10.2 *	10.5 *
beste Teiler	41.7 (31.)	54.6 (35.)	65.0 (38.)		
Trefferlage	0.41 mm rechts, 0.28 mm hoch				
Streuwert	1.06, horizontal: 1.05, vertikal: 1.07				

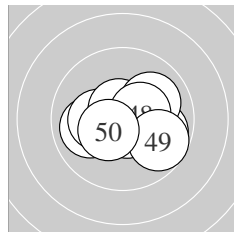

Serie 5:	9.9 ↘	10.0 ←	10.5 *	10.2 *	10.7 *
	10.6 *	10.0 ↗	10.4 *	9.7 ↘	10.4 *
beste Teiler	71.5 (45.)	76.6 (46.)	118.0 (43.)		
Trefferlage	0.21 mm rechts, 0.22 mm tief				
Streuwert	1.43, horizontal: 1.83, vertikal: 0.84				

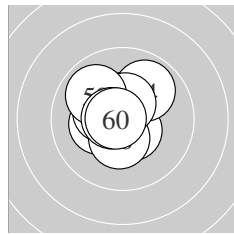

Serie 6:	10.5 *	10.5 *	10.3 *	9.9 ↗	10.4 *
	10.4 *	10.5 *	9.9 ↘	10.6 *	10.7 *
beste Teiler	51.1 (60.)	80.2 (59.)	105.4 (51.)		
Trefferlage	0.39 mm links, 0.41 mm hoch				
Streuwert	1.12, horizontal: 1.12, vertikal: 1.13				

Meyton Elektronik

ISSF AR Men – Wertung – Junioren

StandNr: 138

Dutendas, Dimitri #70817541

StartNr: 87

3. Dezember 2017 12:47

FRA

QF – Schütze hat sich fürs Finale qualifiziert

Unterschrift des Schützen

Meyton Elektronik

Ergebnis:	606.7	(580)
Serien:	102.1	102.2 99.4 102.4 101.1 99.5
Zähler:	40	20 0 0 0 0 0 0 0 0
Innenzehner:	30	
weiteste:	491 (23),	438 (7), 408 (54)
beste Teiler	12.6 (51.)	59.0 (2.) 63.5 (9.)
Trefferlage	0.47 mm links, 0.10 mm tief	
Streuwert	1.61, horizontal: 1.65, vertikal: 1.58	

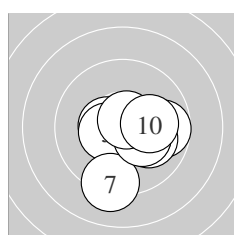
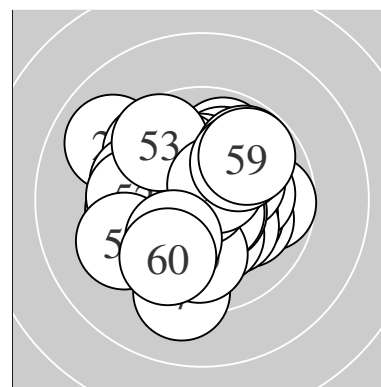

Serie 1:	10.5 *	10.7 *	10.5 *	9.7 →	10.1 →
	10.3 *	9.2 ↓	10.3 *	10.7 *	10.1 →
beste Teiler	59.0 (2.) 63.5 (9.) 120.4 (1.)				
Trefferlage	0.66 mm rechts, 0.64 mm tief				
Streuwert	1.47, horizontal: 1.56, vertikal: 1.36				

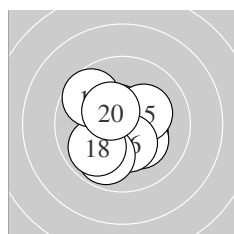

Serie 2:	10.6 *	10.4 *	10.2 *	10.6 *	10.2 *
	10.3 *	9.9 ↙	9.9 ↗	9.7 ↘	10.4 *
beste Teiler	84.1 (14.) 91.2 (11.) 136.6 (20.)				
Trefferlage	0.19 mm links, 0.36 mm tief				
Streuwert	1.44, horizontal: 1.43, vertikal: 1.45				

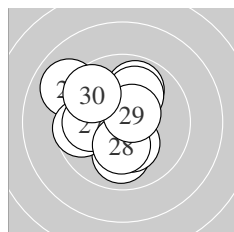

Serie 3:	10.0 ↓	10.3 *	9.0 ↘	9.7 ←	9.9 ↑
	10.0 ↗	10.0 ←	10.2 *	10.6 *	9.7 ↘
beste Teiler	99.0 (29.) 175.1 (22.) 177.2 (28.)				
Trefferlage	0.90 mm links, 0.37 mm hoch				
Streuwert	1.93, horizontal: 1.92, vertikal: 1.94				

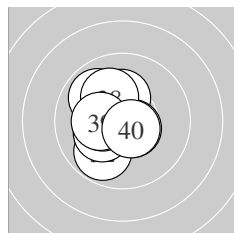

Serie 4:	10.2 *	9.8 ↗	10.2 *	10.6 *	10.4 *
	9.9 ↘	10.3 *	10.1 ↘	10.3 *	10.6 *
beste Teiler	88.4 (40.) 95.0 (34.) 133.7 (35.)				
Trefferlage	0.93 mm links, 0.10 mm hoch				
Streuwert	1.20, horizontal: 1.00, vertikal: 1.36				

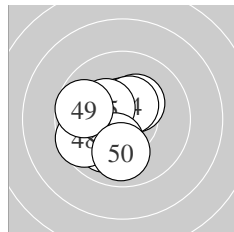

Serie 5:	10.6 *	10.0 ↗	10.3 *	10.5 *	10.3 *
	10.0 ↗	10.2 *	9.6 ↗	9.7 ←	9.9 ↓
beste Teiler	95.0 (41.) 120.7 (44.) 155.3 (45.)				
Trefferlage	0.97 mm links, 0.41 mm tief				
Streuwert	1.45, horizontal: 1.38, vertikal: 1.51				

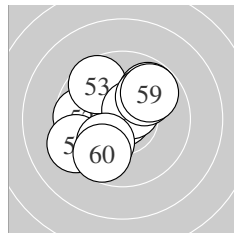

Serie 6:	10.9 *	9.7 ←	9.6 ↘	9.3 ↗	10.6 *
	10.1 ↗	9.8 ↗	10.0 ↗	9.8 ↗	9.7 ↗
beste Teiler	12.6 (51.) 94.1 (55.) 223.8 (56.)				
Trefferlage	0.53 mm links, 0.31 mm hoch				
Streuwert	1.99, horizontal: 2.10, vertikal: 1.89				

Meyton Elektronik

ISSF AR Men – Wertung – Junioren

StandNr: 139

Hammermann, Marcel #80

StartNr: 88

3. Dezember 2017 12:46

VSB NWLZ

Unterschrift des Schützen

Meyton Elektronik

Ergebnis:	615.3	(592) ^{QF}							
Serien:	102.3	102.4	101.5	102.4	103.7	103.0			
Zähler:	52	8	0	0	0	0	0	0	0
Innenzehner:	40								
weiteste:	386 (4), 382 (37), 318 (30)								
beste Teiler	11.4 (40.) 34.7 (42.) 44.1 (35.)								
Trefferlage	0.28 mm rechts, 0.27 mm hoch								
Streuwert	1.33, horizontal: 1.38, vertikal: 1.29								

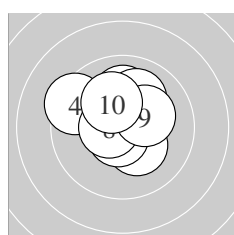
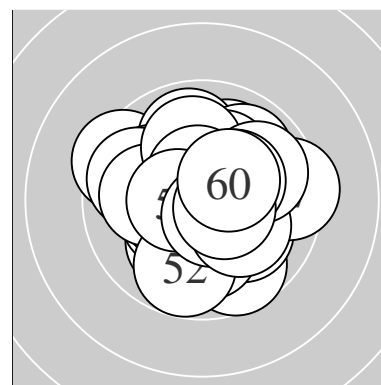

Serie 1:	10.4 *	10.4 *	10.3 *	9.4 ↖	10.7 *
	10.0 ↑	10.1 ↗	10.6 *	10.2 *	10.2 *
beste Teiler	72.4 (5.) 97.0 (8.) 141.6 (2.)				
Trefferlage	0.42 mm links, 0.82 mm hoch				
Streuwert	1.34, horizontal: 1.47, vertikal: 1.19				

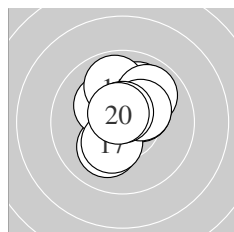

Serie 2:	10.1 ↙	10.0 ↗	10.2 *	10.3 *	9.9 ↑
	9.9 ↗	10.3 *	10.3 *	10.7 *	10.7 *
beste Teiler	71.1 (20.) 73.0 (19.) 151.4 (14.)				
Trefferlage	0.13 mm rechts, 0.77 mm hoch				
Streuwert	1.30, horizontal: 1.13, vertikal: 1.44				

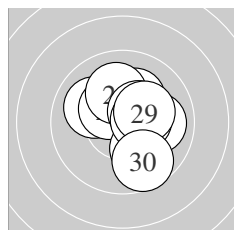

Serie 3:	10.2 *	10.0 ↖	10.4 *	10.1 ↑	10.0 ↘
	10.0 →	10.4 *	10.4 *	10.3 *	9.7 ↘
beste Teiler	135.7 (28.) 138.1 (27.) 138.5 (23.)				
Trefferlage	0.66 mm rechts, 0.27 mm hoch				
Streuwert	1.47, horizontal: 1.38, vertikal: 1.55				

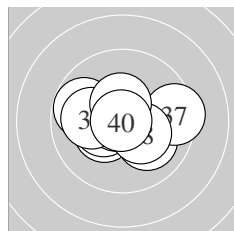

Serie 4:	10.3 *	10.4 *	10.1 ↘	9.8 ↖	10.8 *
	10.0 ←	9.4 →	10.3 *	10.4 *	10.9 *
beste Teiler	11.4 (40.) 44.1 (35.) 127.8 (39.)				
Trefferlage	0.15 mm links, 0.04 mm tief				
Streuwert	1.53, horizontal: 2.00, vertikal: 0.82				

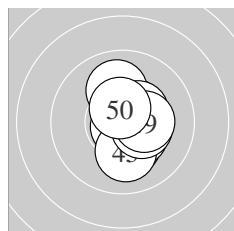

Serie 5:	10.5 *	10.8 *	10.3 *	10.4 *	10.1 ↓
	10.4 *	10.0 ↑	10.4 *	10.3 *	10.5 *
beste Teiler	34.7 (42.) 103.7 (50.) 121.2 (41.)				
Trefferlage	0.60 mm rechts, 0.04 mm tief				
Streuwert	1.07, horizontal: 0.70, vertikal: 1.34				

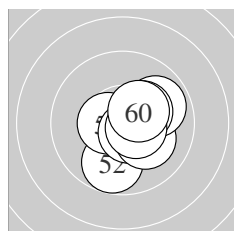

Serie 6:	10.6 *	9.8 ↓	10.5 *	10.6 *	10.2 *
	10.2 *	9.9 ↗	10.3 *	10.5 *	10.4 *
beste Teiler	82.9 (54.) 83.1 (51.) 104.0 (59.)				
Trefferlage	0.88 mm rechts, 0.15 mm tief				
Streuwert	1.15, horizontal: 1.09, vertikal: 1.20				

ISSF AR Men – Wertung – Junioren

StandNr: 140

Hammerl, Soma #70817538

StartNr: 89

3. Dezember 2017 12:15

HUN

QF – Schütze hat sich fürs Finale qualifiziert

Unterschrift des Schützen

Meyton Elektronik

Ergebnis:	613.4	(586)
Serien:	102.4	101.1 103.5 101.1 101.7 103.6
Zähler:	46	14 0 0 0 0 0 0 0 0
Innenzehner:	32	
weiteste:	379	(39), 349 (41), 337 (34)
beste Teiler	25.8	(30.) 36.7 (40.) 37.6 (57.)
Trefferlage	0.61 mm links, 0.38 mm hoch	
Streuwert	1.35, horizontal: 1.45, vertikal: 1.23	

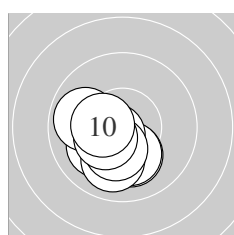
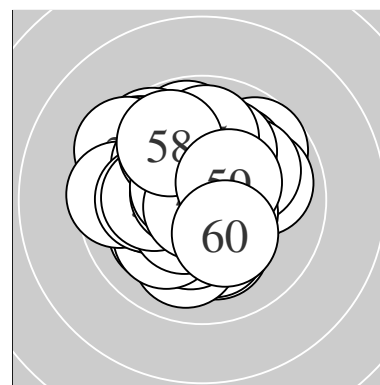

Serie 1:	10.1 ↘	10.1 ↗	10.4 *	10.2 *	10.0 ↘
	10.6 *	10.3 *	9.9 ←	10.4 *	10.4 *
beste Teiler	86.5 (6.) 138.2 (3.) 141.5 (9.)				
Trefferlage	0.90 mm links, 0.98 mm tief				
Streuwert	0.97, horizontal: 0.98, vertikal: 0.96				

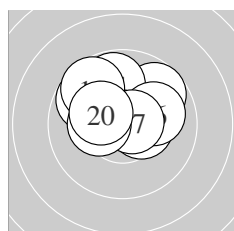

Serie 2:	10.5 *	9.7 ↗	9.8 ↘	9.8 ↑	10.4 *
	10.0 →	10.7 *	9.6 ↘	10.3 *	10.3 *
beste Teiler	68.8 (17.) 117.7 (11.) 133.6 (15.)				
Trefferlage	0.31 mm links, 1.08 mm hoch				
Streuwert	1.47, horizontal: 1.77, vertikal: 1.10				

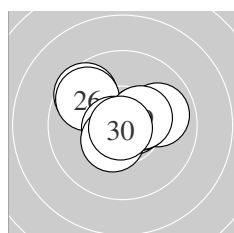

Serie 3:	10.7 *	9.6 ↘	9.9 →	10.7 *	10.5 *
	9.7 ↘	10.7 *	10.4 *	10.4 *	10.9 *
beste Teiler	25.8 (30.) 63.9 (24.) 68.6 (27.)				
Trefferlage	0.16 mm links, 0.42 mm hoch				
Streuwert	1.33, horizontal: 1.61, vertikal: 0.97				

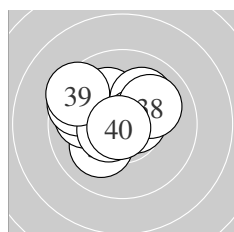

Serie 4:	10.1 ↗	9.9 ←	10.1 ↘	9.6 ↘	10.1 ↗
	10.6 *	10.5 *	10.0 →	9.4 ↘	10.8 *
beste Teiler	36.7 (40.) 87.0 (36.) 106.6 (37.)				
Trefferlage	0.84 mm links, 0.68 mm hoch				
Streuwert	1.52, horizontal: 1.81, vertikal: 1.17				

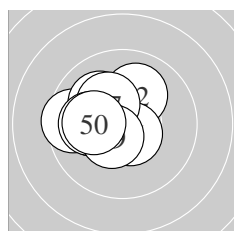

Serie 5:	9.6 ←	10.1 ↗	10.3 *	10.1 ↘	10.1 ←
	10.6 *	10.3 *	10.0 ←	10.5 *	10.1 ←
beste Teiler	88.8 (46.) 115.6 (49.) 152.3 (43.)				
Trefferlage	1.32 mm links, 0.40 mm hoch				
Streuwert	1.15, horizontal: 1.32, vertikal: 0.95				

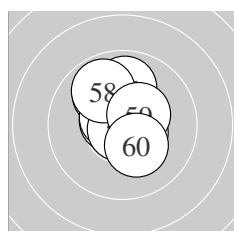

Serie 6:	10.0 ↘	10.6 *	10.5 *	10.6 *	9.9 ↑
	10.6 *	10.8 *	9.9 ↘	10.4 *	10.3 *
beste Teiler	37.6 (57.) 80.6 (52.) 85.4 (54.)				
Trefferlage	0.13 mm links, 0.72 mm hoch				
Streuwert	1.15, horizontal: 0.93, vertikal: 1.32				

Meyton Elektronik

ISSF AR Men – Wertung – Junioren

StandNr: 141

Chatziplis, Alexandros #70817168

StartNr: 90

3. Dezember 2017 12:56

ITA

Unterschrift des Schützen

Meyton Elektronik

Ergebnis:	575.8	(549)
Serien:	97.1 97.4 94.4 96.3 98.1 92.5	
Zähler:	25 24 7 3 1 0 0 0 0 0	
Innenzehner:	14	
weiteste:	1066 (59), 910 (31), 881 (2)	
beste Teiler	9.4 (22.) 50.4 (13.) 69.0 (47.)	
Trefferlage	0.97 mm rechts, 0.14 mm tief	
Streuwert	2.75, horizontal: 3.11, vertikal: 2.34	

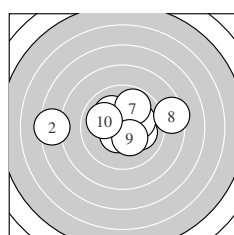
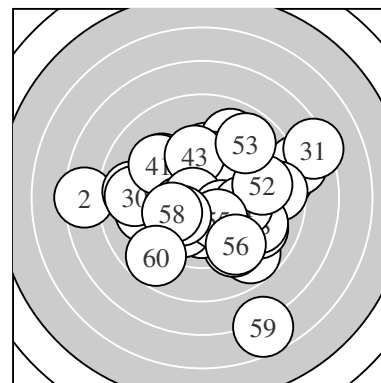

Serie 1:	10.1 ↘	7.4 ←	10.4 *	10.1 →	10.1 →
	10.5 *	9.8 ↗	8.4 →	10.3 *	10.0 ↖
beste Teiler	112.6 (6.)	150.0 (3.)	158.3 (9.)		
Trefferlage	0.05 mm rechts, 0.49 mm hoch				
Streuwert	2.87, horizontal: 3.87, vertikal: 1.22				

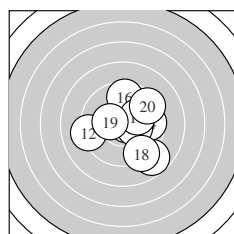

Serie 2:	8.8 ↘	9.2 ←	10.8 *	9.7 →	10.3 *
	9.6 ↑	10.1 →	9.2 ↘	10.3 *	9.4 ↗
beste Teiler	50.4 (13.)	156.2 (15.)	159.8 (19.)		
Trefferlage	1.05 mm rechts, 0.23 mm tief				
Streuwert	2.39, horizontal: 2.45, vertikal: 2.33				

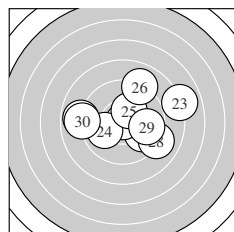

Serie 3:	9.8 ↘	10.9 *	7.9 →	10.0 ←	10.3 *
	9.0 ↗	8.9 ←	9.0 ↘	9.7 →	8.9 ←
beste Teiler	9.4 (22.)	164.3 (25.)	246.0 (24.)		
Trefferlage	0.73 mm rechts, 0.35 mm hoch				
Streuwert	3.13, horizontal: 3.95, vertikal: 1.98				

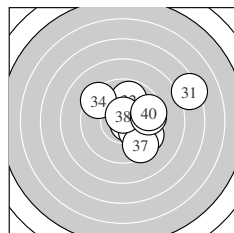

Serie 4:	7.3 →	9.8 ↑	10.7 *	9.4 ↘	9.6 ↘
	10.1 ↘	9.5 ↘	10.7 *	9.6 →	9.6 →
beste Teiler	72.4 (33.)	74.5 (38.)	213.2 (36.)		
Trefferlage	2.01 mm rechts, 0.50 mm hoch				
Streuwert	2.54, horizontal: 2.91, vertikal: 2.11				

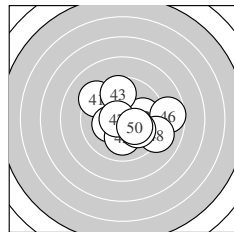

Serie 5:	9.3 ↘	9.9 →	9.7 ↑	10.3 *	10.1 ↓
	8.7 →	10.7 *	9.1 ↘	10.0 ↘	10.3 *
beste Teiler	69.0 (47.)	171.3 (44.)	175.9 (50.)		
Trefferlage	0.96 mm rechts, 0.04 mm tief				
Streuwert	2.29, horizontal: 2.71, vertikal: 1.78				

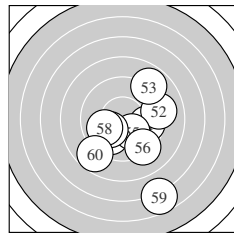

Serie 6:	9.7 →	9.1 →	8.9 ↗	9.9 ↙	10.2 *
	9.2 ↘	10.1 ↙	10.0 ←	6.7 ↘	8.7 ↙
beste Teiler	197.6 (55.)	205.7 (57.)	249.5 (58.)		
Trefferlage	1.03 mm rechts, 1.92 mm tief				
Streuwert	3.29, horizontal: 2.97, vertikal: 3.58				

Meyton Elektronik

ISSF AR Men – Wertung – Junioren

StandNr: 142

Gruber, Robert jr. #70817536

StartNr: 91

3. Dezember 2017 12:29

T – SG Wattens

Unterschrift des Schützen

Meyton Elektronik

Ergebnis:	561.0	(539)
Serien:	92.3 95.7 93.4 94.6 93.6 91.4	
Zähler:	14 32 13 1 0 0 0 0 0 0	
Innenzehner:	7	
weiteste:	790 (56), 721 (40), 651 (25)	
beste Teiler	66.8 (3.) 106.8 (39.) 116.3 (46.)	
Trefferlage	0.46 mm links, 0.29 mm hoch	
Streuwert	3.04, horizontal: 3.31, vertikal: 2.74	

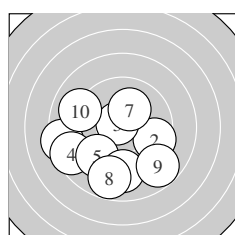
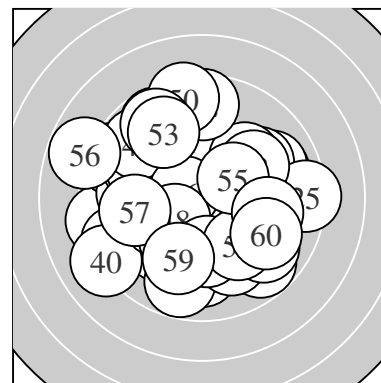

Serie 1:	8.4 ←	9.5 →	10.7 *	8.5 ←	9.3 ↙
	9.1 ↓	10.2 *	8.8 ↓	8.8 ↘	9.0 ↖
beste Teiler	66.8 (3.)	200.7 (7.)	358.6 (2.)		
Trefferlage	1.29 mm links, 1.83 mm tief				
Streuwert	3.03, horizontal: 3.44, vertikal: 2.55				

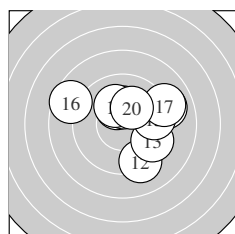

Serie 2:	10.2 *	9.2 ↘	9.5 ↘	9.0 →	9.6 →
	8.6 ↖	9.0 →	10.3 *	10.1 ↗	10.2 *
beste Teiler	175.3 (18.)	177.4 (11.)	197.4 (20.)		
Trefferlage	1.14 mm rechts, 0.81 mm hoch				
Streuwert	2.57, horizontal: 3.02, vertikal: 2.02				

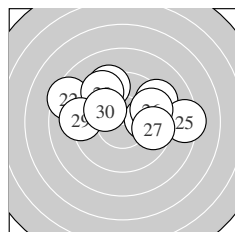

Serie 3:	9.4 ↗	8.5 ↖	9.3 ↗	10.0 →	8.3 →
	9.6 →	9.6 →	9.4 ↖	9.2 ←	10.1 ↖
beste Teiler	223.3 (30.)	243.5 (24.)	327.3 (27.)		
Trefferlage	0.32 mm rechts, 1.42 mm hoch				
Streuwert	2.97, horizontal: 3.95, vertikal: 1.43				

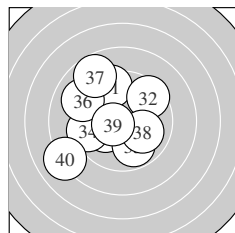

Serie 4:	9.4 ↗	9.5 ↗	10.1 ←	9.4 ←	9.8 ↘
	9.1 ↖	8.7 ↖	10.0 ↘	10.5 *	8.1 ←
beste Teiler	106.8 (39.)	207.0 (33.)	235.7 (38.)		
Trefferlage	1.48 mm links, 0.31 mm hoch				
Streuwert	2.82, horizontal: 2.83, vertikal: 2.81				

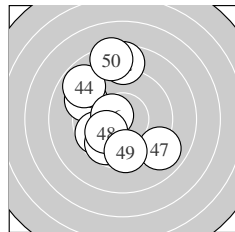

Serie 5:	9.2 ↖	8.6 ↑	9.7 ←	8.8 ↖	9.7 ↙
	10.5 *	9.0 ↘	10.1 ←	9.6 ↓	8.4 ↑
beste Teiler	116.3 (46.)	218.4 (48.)	307.8 (45.)		
Trefferlage	1.21 mm links, 0.61 mm hoch				
Streuwert	3.03, horizontal: 2.30, vertikal: 3.61				

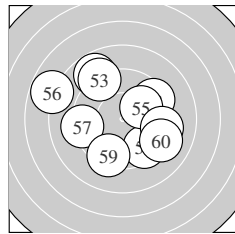

Serie 6:	8.8 ↖	9.4 ↗	9.0 ↖	9.5 ↘	10.0 →
	7.8 ↖	9.2 ←	9.3 →	9.3 ↓	9.1 ↘
beste Teiler	231.0 (55.)	371.2 (54.)	379.9 (52.)		
Trefferlage	0.28 mm links, 0.41 mm hoch				
Streuwert	3.50, horizontal: 3.96, vertikal: 2.98				

ISSF AR Men – Wertung – Junioren

StandNr: 143

Nußbaumer, Dustin #70817473

StartNr: 92

3. Dezember 2017 12:32

VSBB–TZ Höchst

Unterschrift des Schützen

Meyton Elektronik

Ergebnis:	613.9	(588) ^{QF}							
Serien:	102.2	103.4	102.7	101.0	102.8	101.8			
Zähler:	48	12	0	0	0	0	0	0	0
Innenzehner:	38								
weiteste:	392 (33), 391 (1), 349 (28)								
beste Teiler	45.8 (12.)	53.7 (30.)	64.3 (59.)						
Trefferlage	0.05 mm rechts, 0.27 mm hoch								
Streuwert	1.43, horizontal: 1.73, vertikal: 1.05								

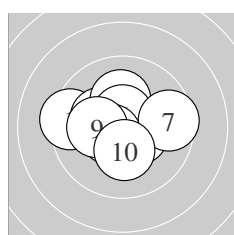
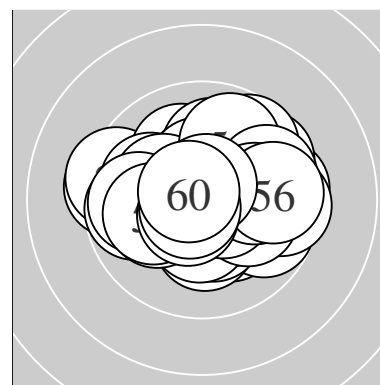

Serie 1:

9.4 ←	10.2 *	10.7 *	10.5 *	10.2 *
10.6 *	9.6 →	10.5 *	10.2 *	10.3 *
beste Teiler	69.6 (3.)	88.0 (6.)	103.2 (8.)	
Trefferlage	0.31 mm links, 0.22 mm hoch			
Streuwert	1.54, horizontal: 1.95, vertikal: 0.99			

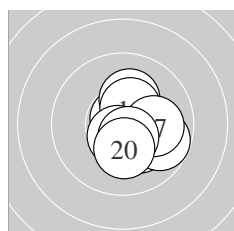

Serie 2:

10.2 *	10.8 *	9.8 ↘	10.2 *	10.7 *
10.4 *	10.0 →	10.6 *	10.5 *	10.2 *
beste Teiler	45.8 (12.)	73.4 (15.)	94.5 (18.)	
Trefferlage	0.74 mm rechts, 0.35 mm tief			
Streuwert	1.10, horizontal: 1.04, vertikal: 1.17			

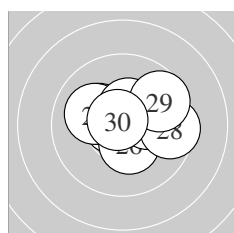

Serie 3:

10.7 *	10.7 *	10.2 *	10.1 ↖	10.4 *
10.4 *	10.2 *	9.6 →	9.7 ↗	10.7 *
beste Teiler	53.7 (30.)	66.6 (22.)	67.8 (21.)	
Trefferlage	0.48 mm rechts, 0.40 mm hoch			
Streuwert	1.41, horizontal: 1.81, vertikal: 0.86			

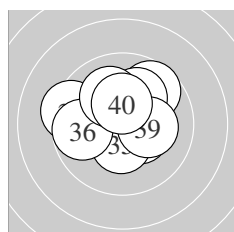

Serie 4:

9.7 ↗	10.4 *	9.4 ←	10.6 *	10.4 *
9.8 ←	10.1 ↗	10.1 ↘	10.2 *	10.3 *
beste Teiler	76.1 (34.)	140.6 (32.)	141.4 (35.)	
Trefferlage	0.24 mm links, 0.60 mm hoch			
Streuwert	1.67, horizontal: 1.95, vertikal: 1.33			

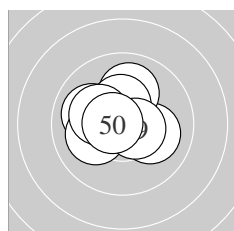

Serie 5:

10.3 *	10.4 *	10.1 ↘	10.0 ↖	10.1 ←
10.0 ↑	10.4 *	10.2 *	10.6 *	10.7 *
beste Teiler	75.3 (50.)	99.9 (49.)	134.2 (42.)	
Trefferlage	0.61 mm links, 0.41 mm hoch			
Streuwert	1.21, horizontal: 1.41, vertikal: 0.96			

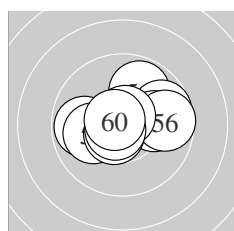

Serie 6:

9.8 ↗	9.8 ←	9.7 ↘	10.0 →	10.1 ←
9.7 →	10.6 *	10.7 *	10.7 *	10.7 *
beste Teiler	64.3 (59.)	69.3 (58.)	69.6 (60.)	
Trefferlage	0.30 mm rechts, 0.34 mm hoch			
Streuwert	1.59, horizontal: 2.04, vertikal: 0.93			

ISSF AR Men – Wertung – Junioren

StandNr: 144

Thum, Andreas #86

StartNr: 93

3. Dezember 2017 12:40

AUT

QF – Schütze hat sich fürs Finale qualifiziert

Unterschrift des Schützen

Meyton Elektronik

Ergebnis:	539.5	(511)
Serien:	92.4 92.2 92.2 90.0 90.3 82.4	
Zähler:	14 20 14 8 3 1 0 0 0 0	
Innenzehner:	8	
weiteste:	1261 (51), 1244 (53), 1220 (14)	
beste Teiler	16.1 (54.) 60.5 (9.) 98.4 (37.)	
Trefferlage	1.04 mm links, 0.10 mm hoch	
Streuwert	4.03, horizontal: 4.54, vertikal: 3.44	

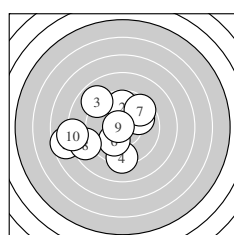
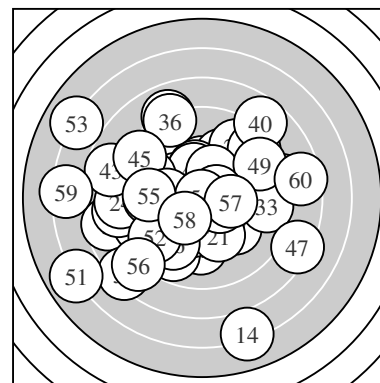

Serie 1:	9.9 ↗	9.7 ↑	8.9 ↘	9.2 ↓	7.6 ←
	10.1 ↙	9.6 ↗	8.6 ←	10.7 *	8.1 ←
beste Teiler	60.5 (9.)	219.1 (6.)	257.6 (1.)		
Trefferlage	2.12 mm links, 0.14 mm tief				
Streuwert	3.22, horizontal: 3.71, vertikal: 2.64				

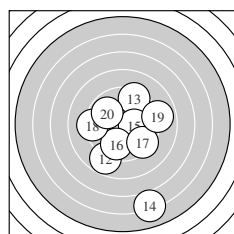

Serie 2:	10.4 *	8.8 ↙	9.4 ↑	6.1 ↓	10.3 *
	9.8 ↓	9.4 ↘	9.2 ←	8.9 →	9.9 ↘
beste Teiler	139.3 (11.)	164.3 (15.)	271.2 (20.)		
Trefferlage	0.41 mm rechts, 1.67 mm tief				
Streuwert	3.68, horizontal: 3.01, vertikal: 4.25				

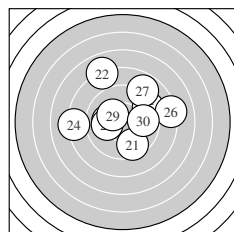

Serie 3:	9.6 ↓	7.9 ↘	10.1 ←	8.2 ←	9.3 ↗
	8.1 →	8.8 ↗	10.1 ←	10.3 *	9.8 →
beste Teiler	173.2 (29.)	213.9 (23.)	222.6 (28.)		
Trefferlage	0.21 mm rechts, 1.24 mm hoch				
Streuwert	3.47, horizontal: 4.03, vertikal: 2.79				

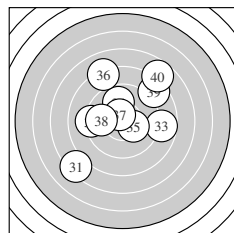

Serie 4:	7.3 ↙	9.2 ←	8.7 →	9.9 ↑	10.3 *
	8.1 ↘	10.6 *	9.7 ←	8.5 ↗	7.7 ↗
beste Teiler	98.4 (37.)	169.0 (35.)	272.4 (34.)		
Trefferlage	0.14 mm links, 1.29 mm hoch				
Streuwert	4.04, horizontal: 4.19, vertikal: 3.88				

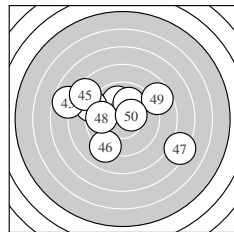

Serie 5:	9.9 ↑	9.0 ↘	7.7 ↘	10.0 ↑	8.4 ↘
	9.1 ↙	7.3 ↘	9.8 ←	8.7 ↗	10.4 *
beste Teiler	133.8 (50.)	241.9 (44.)	252.8 (41.)		
Trefferlage	0.85 mm links, 0.80 mm hoch				
Streuwert	3.91, horizontal: 4.82, vertikal: 2.73				

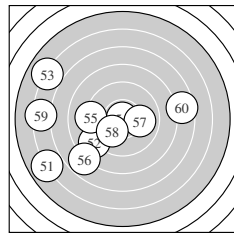

Serie 6:	5.9 ↙	8.9 ↙	6.0 ↘	10.9 *	9.1 ←
	7.8 ↙	10.0 →	10.0 ↙	6.3 ←	7.5 →
beste Teiler	16.1 (54.)	226.2 (58.)	246.7 (57.)		
Trefferlage	3.76 mm links, 0.86 mm tief				
Streuwert	5.24, horizontal: 6.38, vertikal: 3.75				

Meyton Elektronik

ISSF AR Men – Wertung – Junioren

StandNr: 145

Ender, Lukas #70817478

StartNr: 94

3. Dezember 2017 12:55

VSB-TZ Altach

Unterschrift des Schützen

Meyton Elektronik

Ergebnis:	612.7	(589)
Serien:	103.3	101.1 102.0 101.8 102.9 101.6
Zähler:	49	11 0 0 0 0 0 0 0 0
Innenzehner:	40	
weiteste:	445 (57), 412 (13), 383 (24)	
beste Teiler	34.4 (56.)	58.0 (48.) 61.0 (40.)
Trefferlage	0.68 mm links, 0.06 mm tief	
Streuwert	1.39, horizontal: 1.53, vertikal: 1.22	

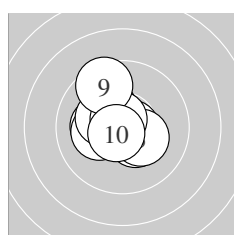
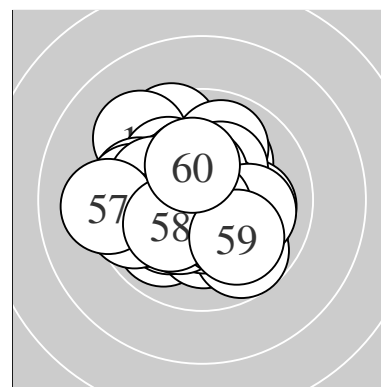

Serie 1:	10.4 *	10.7 *	10.3 *	10.3 *	10.2 *
	10.2 *	10.3 *	10.7 *	9.5 ↖	10.7 *
beste Teiler	66.7 (2.) 68.6 (10.) 69.7 (8.)				
Trefferlage	0.54 mm links, 0.33 mm hoch				
Streuwert	1.23, horizontal: 1.21, vertikal: 1.25				

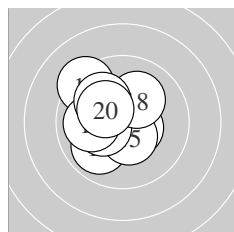

Serie 2:	10.5 *	10.2 *	9.3 ↘	9.9 ↗	10.5 *
	10.3 *	10.0 ←	10.1 ↗	10.0 ↘	10.3 *
beste Teiler	107.4 (11.) 123.5 (15.) 159.8 (16.)				
Trefferlage	1.05 mm links, 0.24 mm hoch				
Streuwert	1.47, horizontal: 1.42, vertikal: 1.53				

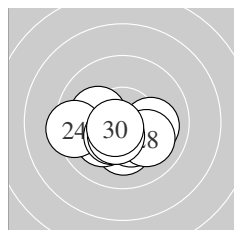

Serie 3:	10.2 *	10.1 ↖	10.2 *	9.4 ←	10.4 *
	10.1 →	10.4 *	10.0 ↘	10.5 *	10.7 *
beste Teiler	74.8 (30.) 119.8 (29.) 137.2 (25.)				
Trefferlage	0.43 mm links, 0.86 mm tief				
Streuwert	1.36, horizontal: 1.79, vertikal: 0.70				

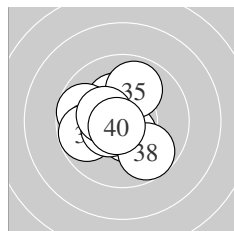

Serie 4:	10.3 *	10.3 *	10.5 *	9.7 ↖	9.9 ↗
	9.8 ←	10.5 *	9.7 ↘	10.4 *	10.7 *
beste Teiler	61.0 (40.) 111.0 (33.) 119.4 (37.)				
Trefferlage	0.62 mm links, 0.15 mm hoch				
Streuwert	1.51, horizontal: 1.53, vertikal: 1.49				

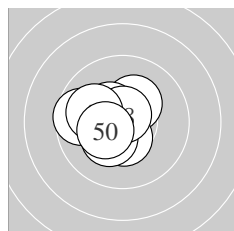

Serie 5:	10.5 *	10.3 *	10.4 *	10.5 *	10.3 *
	10.2 *	9.6 ←	10.7 *	10.0 ↖	10.4 *
beste Teiler	58.0 (48.) 106.8 (41.) 123.4 (44.)				
Trefferlage	1.07 mm links, 0.06 mm hoch				
Streuwert	1.08, horizontal: 1.21, vertikal: 0.93				

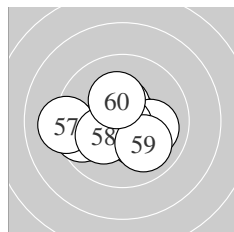

Serie 6:	10.7 *	10.3 *	10.5 *	9.6 ←	10.0 →
	10.8 *	9.2 ←	10.2 *	10.0 ↘	10.3 *
beste Teiler	34.4 (56.) 71.0 (51.) 118.2 (53.)				
Trefferlage	0.40 mm links, 0.34 mm tief				
Streuwert	1.67, horizontal: 2.10, vertikal: 1.07				

Meyton Elektronik

ISSF AR Men – Wertung – Junioren

StandNr: 146

Pauzies, Bastien #70817539

StartNr: 95

3. Dezember 2017 12:39

FRA

Unterschrift des Schützen

Meyton Elektronik

Ergebnis: **612.9** (585)
 Serien: 101.3 101.8 101.6 102.0 104.5 101.7
 0.0
 Zähler: 45 15 0 0 0 0 0 0 0 0
 Innenzehner: 38
 weiteste: 484 (26), 399 (34), 394 (16)
 beste Teiler 28.4 (59.) 36.0 (42.) 42.4 (50.)
 Trefferlage 0.32 mm rechts, 0.35 mm hoch
 Streuwert 1.48, horizontal: 1.85, vertikal: 0.97

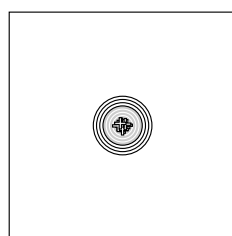
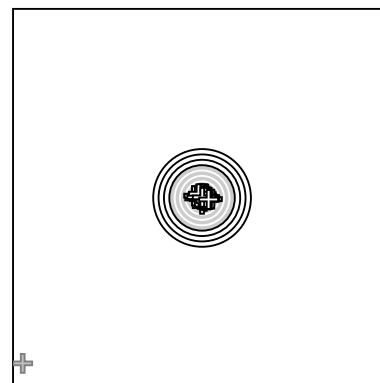

Serie 1:
 9.7 → 10.3 * 10.1 ↘ 10.6 * 10.7 *
 10.5 * 9.8 ↓ 10.0 ↗ 9.6 ← 10.0 ↖
 beste Teiler 67.1 (5.) 83.3 (4.) 110.4 (6.)
 Trefferlage 0.07 mm rechts, 0.04 mm tief
 Streuwert 1.69, horizontal: 1.93, vertikal: 1.42

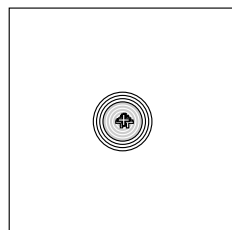

Serie 2:
 10.7 * 9.5 → 10.4 * 9.9 ↗ 10.5 *
 9.4 → 10.4 * 10.6 * 10.0 ↗ 10.4 *
 beste Teiler 75.1 (11.) 85.5 (18.) 106.1 (15.)
 Trefferlage 1.17 mm rechts, 0.77 mm hoch
 Streuwert 1.29, horizontal: 1.60, vertikal: 0.87

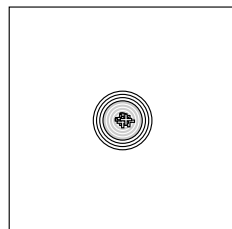

Serie 3:
 10.2 * 10.3 * 10.4 * 10.3 * 10.3 *
 9.0 → 10.4 * 10.4 * 10.4 * 9.9 →
 beste Teiler 130.3 (29.) 132.6 (27.) 143.1 (23.)
 Trefferlage 0.66 mm rechts, 0.54 mm hoch
 Streuwert 1.54, horizontal: 1.99, vertikal: 0.87

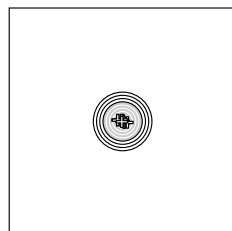

Serie 4:
 10.3 * 10.6 * 10.6 * 9.4 ← 10.5 *
 9.4 → 10.7 * 10.4 * 9.4 ← 10.7 *
 beste Teiler 59.4 (37.) 67.2 (40.) 91.0 (33.)
 Trefferlage 0.38 mm links, 0.31 mm hoch
 Streuwert 1.68, horizontal: 2.24, vertikal: 0.79

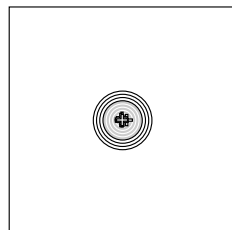

Serie 5:
 10.6 * 10.8 * 10.4 * 9.7 → 10.1 ↑
 10.6 * 10.4 * 10.3 * 10.8 * 10.8 *
 beste Teiler 36.0 (42.) 42.4 (50.) 48.0 (49.)
 Trefferlage 0.25 mm links, 0.21 mm hoch
 Streuwert 1.10, horizontal: 1.31, vertikal: 0.84

Meyton Elektronik

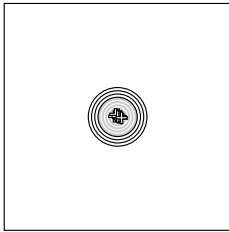

Serie 6:

10.0 →	9.7 ↗	10.2 *	10.5 *	10.0 ←
10.7 *	10.2 *	9.9 ↘	10.8 *	9.7 →

beste Teiler 28.4 (59.) 71.8 (56.) 101.2 (54.)
 Trefferlage 0.66 mm rechts, 0.36 mm hoch
 Streuwert 1.48, horizontal: 1.86, vertikal: 0.96

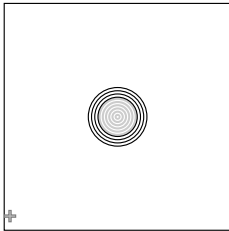

Serie 7:

0.0+
AST.NSC

beste Teiler
 Trefferlage 0.00 mm , 0.00 mm
 Streuwert 0.00, horizontal: 0.00, vertikal: 0.00

AST – Treffer wurde nach Ende der Schießzeit abgegeben
 NSC – Treffer wurde vermessen, geht aber nicht in die Wertung ein

Unterschrift des Schützen

Ergebnis: **571.3** (542)
 Serien: 92.5 95.9 93.5 96.0 99.2 94.2
 0.0
 Zähler: 18 27 14 1 0 0 0 0 0 0
 Innenzehner: 15
 weiteste: 787 (60), 736 (20), 729 (55)
 beste Teiler 13.0 (15.) 39.6 (24.) 54.4 (39.)
 Trefferlage 0.88 mm rechts, 0.95 mm hoch
 Streuwert 2.72, horizontal: 2.92, vertikal: 2.51

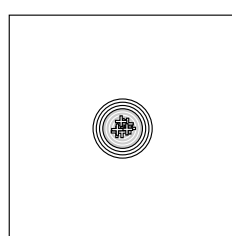
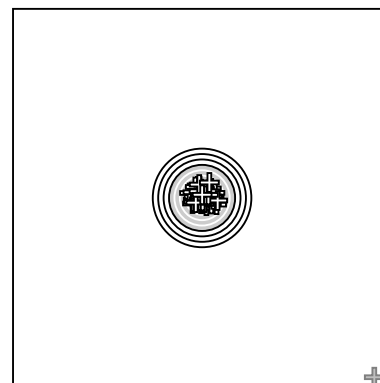

Serie 1:
 9.6 ↗ 9.3 ↗ 8.7 → 9.6 ↑ 8.9 ↙
 8.9 ↗ 8.7 ↑ 9.9 ↓ 9.6 → 9.3 ←
 beste Teiler 271.9 (8.) 337.5 (9.) 344.4 (4.)
 Trefferlage 0.92 mm rechts, 0.99 mm hoch
 Streuwert 3.11, horizontal: 3.42, vertikal: 2.76

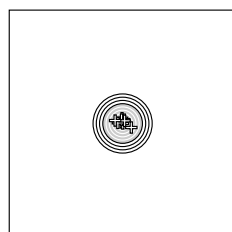

Serie 2:
 10.0 ↑ 9.3 ↑ 10.4 * 9.7 ↑ 10.9 *
 9.7 ↑ 9.5 ← 9.9 ↗ 8.5 ↖ 8.0 →
 beste Teiler 13.0 (15.) 130.3 (13.) 234.0 (11.)
 Trefferlage 0.14 mm links, 1.48 mm hoch
 Streuwert 2.73, horizontal: 3.29, vertikal: 2.02

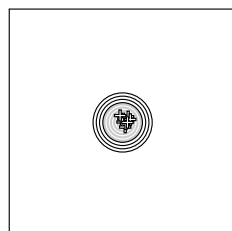

Serie 3:
 9.8 ↑ 9.2 → 9.5 → 10.8 * 9.3 ↓
 9.8 → 8.5 ↗ 8.7 ↑ 8.4 → 9.5 →
 beste Teiler 39.6 (24.) 277.3 (26.) 287.3 (21.)
 Trefferlage 2.49 mm rechts, 1.29 mm hoch
 Streuwert 2.49, horizontal: 2.38, vertikal: 2.60

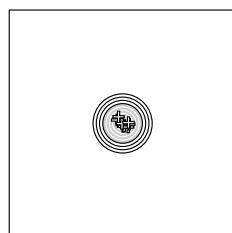

Serie 4:
 10.1 ↓ 10.2 * 9.9 ↓ 10.6 * 9.0 ↖
 8.6 ↖ 8.9 → 8.9 → 10.7 * 9.1 →
 beste Teiler 54.4 (39.) 97.0 (34.) 200.8 (32.)
 Trefferlage 0.80 mm rechts, 0.06 mm tief
 Streuwert 2.82, horizontal: 3.17, vertikal: 2.43

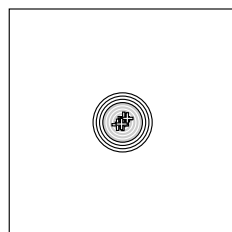

Serie 5:
 10.3 * 9.5 ↑ 10.4 * 9.3 ↗ 10.5 *
 10.4 * 10.2 * 9.2 ↙ 9.0 ↗ 10.4 *
 beste Teiler 120.8 (45.) 142.0 (43.) 145.7 (46.)
 Trefferlage 0.19 mm rechts, 0.26 mm hoch
 Streuwert 2.17, horizontal: 2.14, vertikal: 2.20

Meyton Elektronik

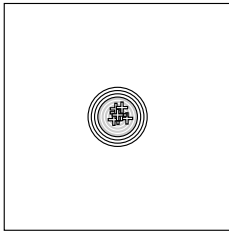

Serie 6:

10.4 *	9.6 ↖	10.3 *	9.5 ↙	8.0 →
10.1 ↗	8.4 ↑	9.7 ↘	10.4 *	7.8 ↗

beste Teiler 140.8 (51.) 145.0 (59.) 152.2 (53.)
 Trefferlage 1.04 mm rechts, 1.73 mm hoch
 Streuwert 2.98, horizontal: 2.91, vertikal: 3.06

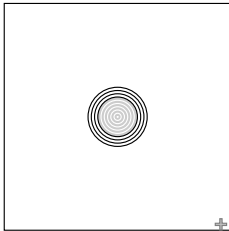

Serie 7:

0.0+
AST.NSC

beste Teiler
 Trefferlage 0.00 mm , 0.00 mm
 Streuwert 0.00, horizontal: 0.00, vertikal: 0.00

AST – Treffer wurde nach Ende der Schießzeit abgegeben
 NSC – Treffer wurde vermessen, geht aber nicht in die Wertung ein

Unterschrift des Schützen