

Ergebnis: **407.3** (387)
 Serien: 102.2 100.6 100.6 103.9
 Zähler: 27 13 0 0 0 0 0 0 0 0
 Innenzehner: 26
 weiteste: 474 (7), 416 (29), 398 (13)
 beste Teiler 17.8 (1.) 40.1 (40.) 45.1 (15.)
 Trefferlage 0.18 mm rechts, 0.44 mm tief
 Streuwert 1.60, horizontal: 1.86, vertikal: 1.28

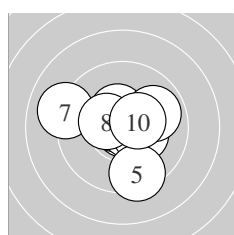

Serie 1:
 10.9 * 10.7 * 10.7 * 10.3 * 9.4 ↘
 10.4 * 9.1 ← 10.4 * 9.9 ↗ 10.4 *
 beste Teiler 17.8 (1.) 51.6 (3.) 58.5 (2.)
 Trefferlage 0.00 mm , 0.02 mm hoch
 Streuwert 1.71, horizontal: 1.94, vertikal: 1.44

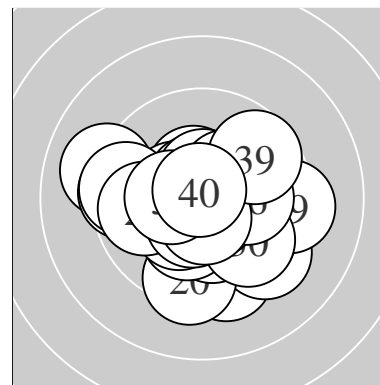
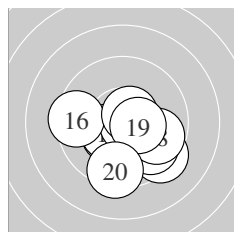

Serie 2:
 10.4 * 10.4 * 9.4 ↘ 9.8 ↘ 10.8 *
 9.5 ← 10.6 * 9.8 ↗ 10.5 * 9.4 ↓
 beste Teiler 45.1 (15.) 84.2 (17.) 125.9 (19.)
 Trefferlage 0.37 mm rechts, 1.08 mm tief
 Streuwert 1.75, horizontal: 2.07, vertikal: 1.37

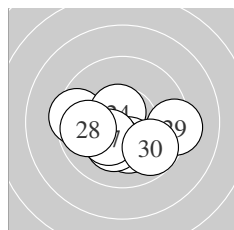

Serie 3:
 10.4 * 9.5 ← 10.5 * 10.6 * 10.2 *
 10.2 * 10.3 * 9.8 ← 9.3 → 9.8 ↘
 beste Teiler 86.7 (24.) 118.8 (23.) 142.1 (21.)
 Trefferlage 0.22 mm links, 0.90 mm tief
 Streuwert 1.71, horizontal: 2.23, vertikal: 0.95

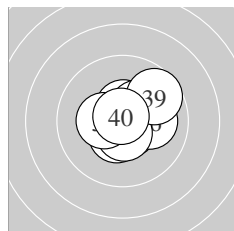

Serie 4:
 10.5 * 10.6 * 10.5 * 10.4 * 10.3 *
 10.1 → 10.6 * 10.4 * 9.7 ↗ 10.8 *
 beste Teiler 40.1 (40.) 81.8 (32.) 95.7 (37.)
 Trefferlage 0.59 mm rechts, 0.18 mm hoch
 Streuwert 1.10, horizontal: 1.23, vertikal: 0.96

Unterschrift des Schützen

Meyton Elektronik

Ergebnis: **406.6** (388)
 Serien: 102.3 98.9 102.2 103.2
 Zähler: 28 12 0 0 0 0 0 0 0 0
 Innenzehner: 23
 weiteste: 381 (11), 367 (20), 332 (13)
 beste Teiler 42.5 (4.) 54.3 (28.) 71.7 (35.)
 Trefferlage 0.62 mm rechts, 0.34 mm hoch
 Streuwert 1.46, horizontal: 1.61, vertikal: 1.29

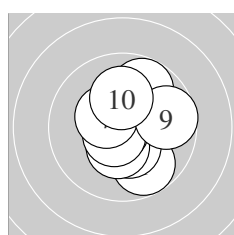
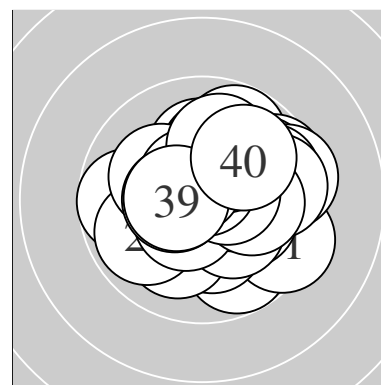

Serie 1:
 9.8 ↘ 10.4 * 10.4 * 10.8 * 10.3 *
 10.6 * 10.4 * 9.8 ↑ 9.7 → 10.1 ↑
 beste Teiler 42.5 (4.) 80.6 (6.) 136.4 (7.)
 Trefferlage 0.43 mm rechts, 0.15 mm hoch
 Streuwert 1.48, horizontal: 1.25, vertikal: 1.67

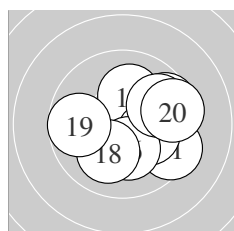

Serie 2:
 9.4 ↘ 10.3 * 9.6 → 10.1 ↑ 10.2 *
 10.2 * 9.8 → 10.1 ↓ 9.7 ← 9.5 →
 beste Teiler 152.0 (12.) 177.2 (16.) 195.4 (15.)
 Trefferlage 1.24 mm rechts, 0.03 mm hoch
 Streuwert 1.82, horizontal: 2.11, vertikal: 1.46

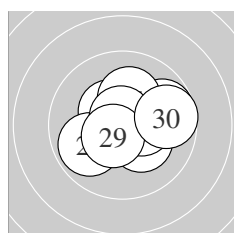

Serie 3:
 10.4 * 10.3 * 10.3 * 9.8 → 9.9 ↙
 10.4 * 10.2 * 10.7 * 10.5 * 9.7 →
 beste Teiler 54.3 (28.) 102.7 (29.) 132.3 (21.)
 Trefferlage 0.56 mm rechts, 0.32 mm hoch
 Streuwert 1.41, horizontal: 1.67, vertikal: 1.09

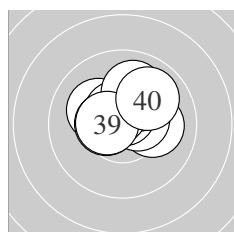

Serie 4:
 10.2 * 10.1 → 10.5 * 10.5 * 10.7 *
 10.2 * 10.6 * 10.0 ↑ 10.5 * 9.9 ↗
 beste Teiler 71.7 (35.) 94.1 (37.) 109.2 (39.)
 Trefferlage 0.22 mm rechts, 0.86 mm hoch
 Streuwert 1.10, horizontal: 1.31, vertikal: 0.83

Unterschrift des Schützen

Meyton Elektronik

Ergebnis: **402.3** (385)
 Serien: 101.1 99.3 100.3 101.6
 Zähler: 25 15 0 0 0 0 0 0 0 0
 Innenzehner: 20
 weiteste: 480 (11), 421 (28), 395 (19)
 beste Teiler 31.0 (5.) 47.0 (2.) 83.2 (22.)
 Trefferlage 0.17 mm rechts, 0.01 mm hoch
 Streuwert 1.77, horizontal: 1.78, vertikal: 1.77

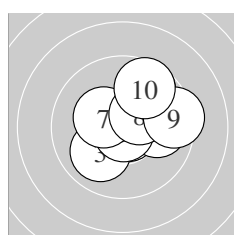
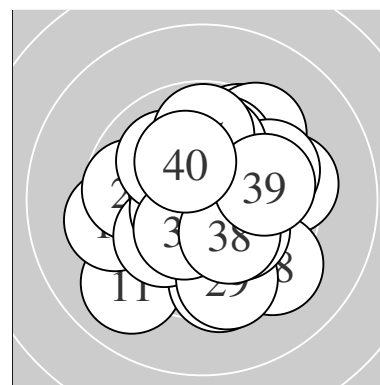

Serie 1:
 10.3 * 10.8 * 10.0 ↙ 9.9 → 10.8 *
 9.7 ↗ 10.3 * 10.3 * 9.4 → 9.6 ↗
 beste Teiler 31.0 (5.) 47.0 (2.) 151.6 (1.)
 Trefferlage 0.70 mm rechts, 0.47 mm hoch
 Streuwert 1.64, horizontal: 1.79, vertikal: 1.48

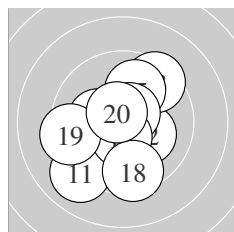

Serie 2:
 9.0 ↙ 10.2 * 9.4 ↗ 10.2 * 9.9 ↗
 10.6 * 10.5 * 9.5 ↓ 9.4 ← 10.6 *
 beste Teiler 83.8 (20.) 84.0 (16.) 109.2 (17.)
 Trefferlage 0.29 mm links, 0.32 mm tief
 Streuwert 2.11, horizontal: 2.03, vertikal: 2.19

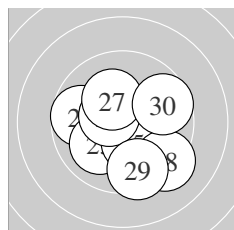

Serie 3:
 9.7 ← 10.6 * 10.0 ↙ 10.5 * 10.3 *
 10.5 * 10.2 * 9.3 ↘ 9.5 ↓ 9.7 →
 beste Teiler 83.2 (22.) 107.8 (24.) 109.1 (26.)
 Trefferlage 0.02 mm links, 0.54 mm tief
 Streuwert 1.86, horizontal: 1.98, vertikal: 1.74

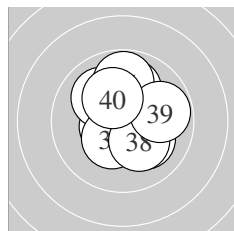

Serie 4:
 10.6 * 10.0 ↑ 10.5 * 10.0 ↘ 9.8 ↑
 10.1 ↘ 10.4 * 10.2 * 9.8 → 10.2 *
 beste Teiler 91.2 (31.) 103.0 (33.) 149.0 (37.)
 Trefferlage 0.31 mm rechts, 0.47 mm hoch
 Streuwert 1.48, horizontal: 1.35, vertikal: 1.61

Unterschrift des Schützen

Meyton Elektronik

Ergebnis: **372.2** (354)
 Serien: 92.7 92.9 94.9 91.7
 Zähler: 9 19 10 1 1 0 0 0 0 0
 Innenzehner: 4
 weiteste: 1206 (36), 888 (29), 732 (11)
 beste Teiler 89.1 (32.) 157.4 (30.) 182.2 (1.)
 Trefferlage 0.78 mm rechts, 0.03 mm tief
 Streuwert 3.26, horizontal: 3.95, vertikal: 2.38

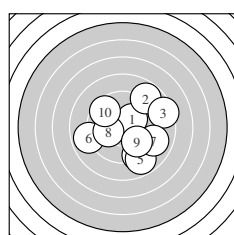
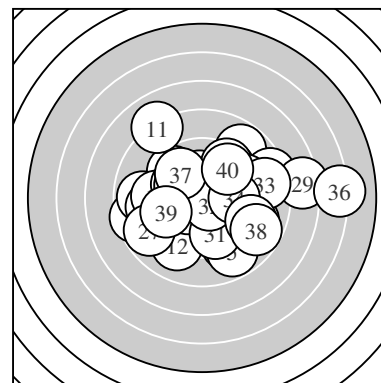

Serie 1:
 10.2 * 8.8 ↗ 8.4 → 9.1 ↘ 8.8 ↘
 8.9 ← 9.0 ↘ 10.1 ← 9.8 ↘ 9.6 ↖
 beste Teiler 182.2 (1.) 216.0 (8.) 295.5 (9.)
 Trefferlage 1.25 mm rechts, 0.50 mm tief
 Streuwert 3.16, horizontal: 3.41, vertikal: 2.89

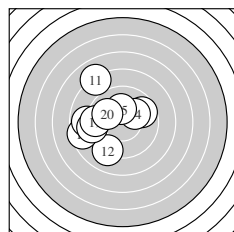

Serie 2:
 8.0 ↖ 9.1 ↙ 9.7 ↗ 10.1 ↗ 10.2 *
 8.5 ← 8.9 ← 9.1 ← 9.4 ← 9.9 ↖
 beste Teiler 192.3 (15.) 216.3 (14.) 252.7 (20.)
 Trefferlage 2.34 mm links, 0.56 mm hoch
 Streuwert 2.81, horizontal: 2.95, vertikal: 2.66

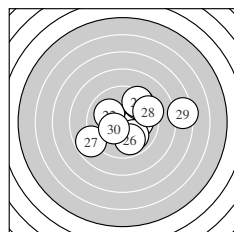

Serie 3:
 10.1 → 10.1 ↖ 9.5 ↗ 10.0 ↘ 9.5 ↗
 9.9 ↘ 8.8 ← 9.3 → 7.4 → 10.3 *
 beste Teiler 157.4 (30.) 223.0 (21.) 224.0 (22.)
 Trefferlage 1.40 mm rechts, 0.13 mm hoch
 Streuwert 2.95, horizontal: 3.60, vertikal: 2.10

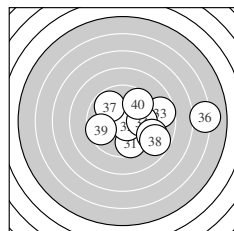

Serie 4:
 9.6 ↘ 10.6 * 8.7 → 9.8 → 9.1 ↘
 6.1 → 9.8 ↖ 8.8 ↘ 9.6 ← 9.6 ↗
 beste Teiler 89.1 (32.) 281.0 (34.) 284.1 (37.)
 Trefferlage 2.83 mm rechts, 0.32 mm tief
 Streuwert 3.32, horizontal: 4.27, vertikal: 1.97

Unterschrift des Schützen

Meyton Elektronik

Ergebnis: **415.0** (397)
 Serien: 102.7 104.5 104.4 103.4
 Zähler: 37 3 0 0 0 0 0 0 0 0
 Innenzehner: 31
 weiteste: 390 (3), 265 (35), 265 (40)
 beste Teiler 18.1 (24.) 23.5 (18.) 44.9 (21.)
 Trefferlage 0.04 mm links, 0.00 mm
 Streuwert 1.17, horizontal: 1.35, vertikal: 0.97

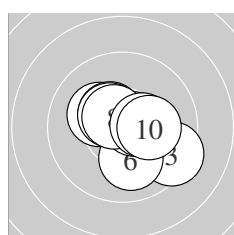
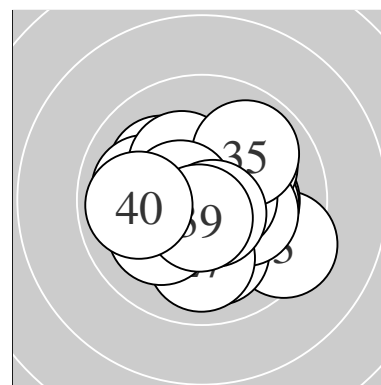

Serie 1:
 10.2 * 10.3 * 9.4 ↘ 10.4 * 10.5 *
 10.1 ↓ 10.6 * 10.6 * 10.4 * 10.2 *
 beste Teiler 82.9 (7.) 93.7 (8.) 123.7 (5.)
 Trefferlage 0.54 mm rechts, 0.08 mm tief
 Streuwert 1.36, horizontal: 1.56, vertikal: 1.13

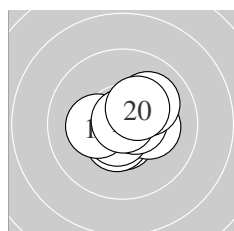

Serie 2:
 10.6 * 10.5 * 10.2 * 10.5 * 10.6 *
 10.6 * 10.3 * 10.9 * 10.0 ↗ 10.3 *
 beste Teiler 23.5 (18.) 78.2 (15.) 89.1 (16.)
 Trefferlage 0.39 mm rechts, 0.06 mm hoch
 Streuwert 0.98, horizontal: 1.10, vertikal: 0.85

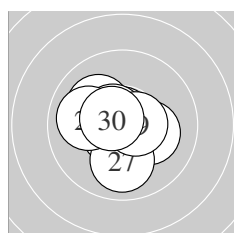

Serie 3:
 10.8 * 10.1 ↖ 10.6 * 10.9 * 10.2 *
 10.6 * 10.0 ↓ 10.0 ← 10.6 * 10.6 *
 beste Teiler 18.1 (24.) 44.9 (21.) 81.0 (23.)
 Trefferlage 0.35 mm links, 0.00 mm
 Streuwert 1.10, horizontal: 1.19, vertikal: 1.01

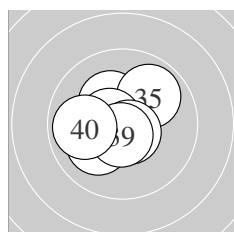

Serie 4:
 10.7 * 10.3 * 10.3 * 10.3 * 9.9 ↗
 10.6 * 10.7 * 10.1 ↙ 10.6 * 9.9 ←
 beste Teiler 63.5 (31.) 72.6 (37.) 76.9 (39.)
 Trefferlage 0.76 mm links, 0.05 mm hoch
 Streuwert 1.14, horizontal: 1.26, vertikal: 1.00

Unterschrift des Schützen

Meyton Elektronik

Ergebnis: **413.5** (396)
 Serien: 103.5 102.2 103.2 104.6
 Zähler: 36 4 0 0 0 0 0 0 0 0
 Innenzehner: 32
 weiteste: 362 (19), 334 (6), 318 (26)
 beste Teiler 39.0 (27.) 53.4 (33.) 53.6 (40.)
 Trefferlage 0.20 mm rechts, 0.18 mm tief
 Streuwert 1.19, horizontal: 1.23, vertikal: 1.15

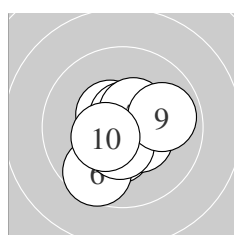
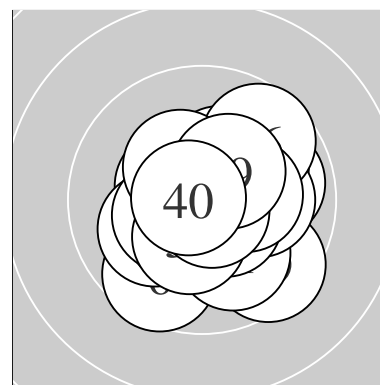

Serie 1:
 10.4 * 10.6 * 10.4 * 10.5 * 10.7 *
 9.6 ↙ 10.5 * 10.5 * 9.9 → 10.4 *
 beste Teiler 70.3 (5.) 97.1 (2.) 115.2 (4.)
 Trefferlage 0.09 mm rechts, 0.29 mm tief
 Streuwert 1.25, horizontal: 1.22, vertikal: 1.29

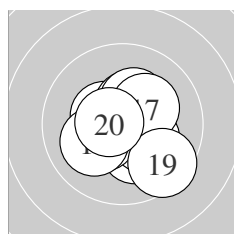

Serie 2:
 10.2 * 10.2 * 10.4 * 10.3 * 10.4 *
 10.3 * 10.2 * 10.1 ↙ 9.5 ↘ 10.6 *
 beste Teiler 87.9 (20.) 128.8 (13.) 129.3 (15.)
 Trefferlage 0.22 mm rechts, 0.27 mm tief
 Streuwert 1.40, horizontal: 1.45, vertikal: 1.34

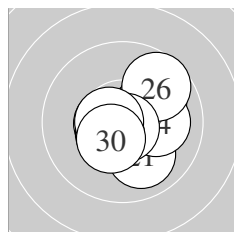

Serie 3:
 10.0 ↘ 10.5 * 10.0 ↗ 10.1 → 10.6 *
 9.7 ↗ 10.8 * 10.5 * 10.6 * 10.4 *
 beste Teiler 39.0 (27.) 88.0 (29.) 95.4 (25.)
 Trefferlage 0.53 mm rechts, 0.03 mm tief
 Streuwert 1.28, horizontal: 1.34, vertikal: 1.21

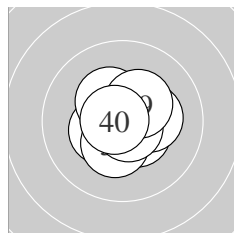

Serie 4:
 10.4 * 10.4 * 10.7 * 10.3 * 10.5 *
 10.3 * 10.3 * 10.7 * 10.3 * 10.7 *
 beste Teiler 53.4 (33.) 53.6 (40.) 56.5 (38.)
 Trefferlage 0.04 mm links, 0.13 mm tief
 Streuwert 0.93, horizontal: 0.98, vertikal: 0.88

Unterschrift des Schützen

Meyton Elektronik

Ergebnis: **415.2** (396)
 Serien: 105.0 103.9 104.9 101.4
 Zähler: 36 4 0 0 0 0 0 0 0 0
 Innenzehner: 32
 weiteste: 387 (36), 336 (35), 296 (32)
 beste Teiler 16.4 (7.) 20.3 (24.) 50.0 (30.)
 Trefferlage 0.04 mm rechts, 0.46 mm hoch
 Streuwert 1.15, horizontal: 1.38, vertikal: 0.85

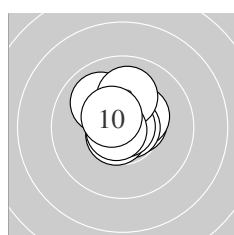
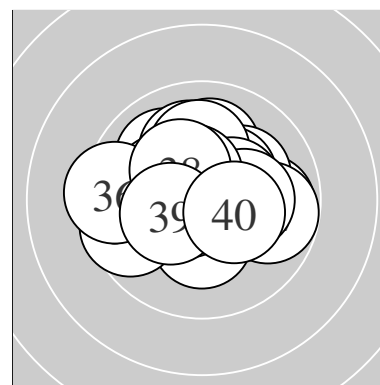

Serie 1:
 10.5 * 10.0 ↘ 10.5 * 10.4 * 10.7 *
 10.7 * 10.9 * 10.0 ↑ 10.8 * 10.5 *
 beste Teiler 16.4 (7.) 50.5 (9.) 52.0 (5.)
 Trefferlage 0.09 mm rechts, 0.58 mm hoch
 Streuwert 0.90, horizontal: 0.92, vertikal: 0.88

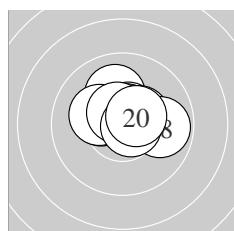

Serie 2:
 10.1 ↑ 10.3 * 10.2 * 10.6 * 10.6 *
 10.4 * 10.6 * 9.9 → 10.7 * 10.5 *
 beste Teiler 64.0 (19.) 77.1 (15.) 94.3 (14.)
 Trefferlage 0.19 mm rechts, 0.67 mm hoch
 Streuwert 1.05, horizontal: 1.34, vertikal: 0.65

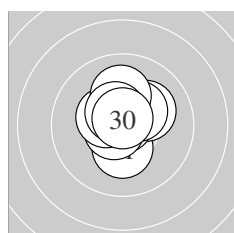

Serie 3:
 10.3 * 10.6 * 10.2 * 10.9 * 10.4 *
 10.7 * 10.4 * 10.1 ↑ 10.5 * 10.8 *
 beste Teiler 20.3 (24.) 50.0 (30.) 69.7 (26.)
 Trefferlage 0.02 mm rechts, 0.54 mm hoch
 Streuwert 0.92, horizontal: 0.83, vertikal: 1.01

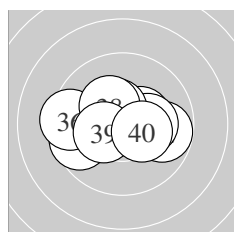

Serie 4:
 10.6 * 9.8 → 10.4 * 10.2 * 9.6 ←
 9.4 ← 10.5 * 10.3 * 10.3 * 10.3 *
 beste Teiler 90.2 (31.) 118.8 (37.) 140.0 (33.)
 Trefferlage 0.14 mm links, 0.04 mm hoch
 Streuwert 1.66, horizontal: 2.22, vertikal: 0.79

Unterschrift des Schützen

Meyton Elektronik

Ergebnis: **416.5** (396)
 Serien: 104.7 104.5 103.0 104.3
 Zähler: 36 4 0 0 0 0 0 0 0 0
 Innenzehner: 31
 weiteste: 331 (27), 325 (7), 325 (12)
 beste Teiler 6.3 (10.) 25.0 (5.) 26.0 (29.)
 Trefferlage 0.16 mm rechts, 0.03 mm hoch
 Streuwert 1.13, horizontal: 1.23, vertikal: 1.03

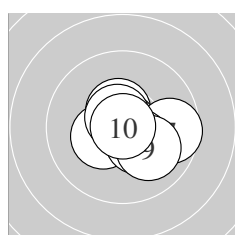
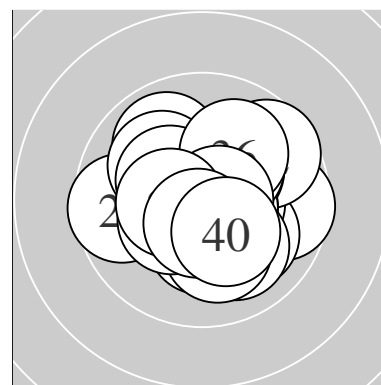

Serie 1:
 10.6 * 10.7 * 10.5 * 10.4 * 10.9 *
 10.6 * 9.7 → 10.4 * 10.0 ↘ 10.9 *
 beste Teiler 6.3 (10.) 25.0 (5.) 70.4 (2.)
 Trefferlage 0.46 mm rechts, 0.13 mm tief
 Streuwert 1.07, horizontal: 1.30, vertikal: 0.79

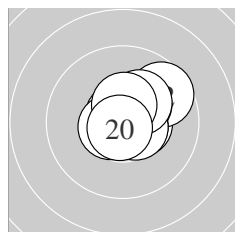

Serie 2:
 10.5 * 9.7 ↗ 10.3 * 10.6 * 10.6 *
 10.7 * 10.6 * 10.2 * 10.5 * 10.8 *
 beste Teiler 43.8 (20.) 54.2 (16.) 88.3 (17.)
 Trefferlage 0.66 mm rechts, 0.45 mm hoch
 Streuwert 0.94, horizontal: 1.00, vertikal: 0.87

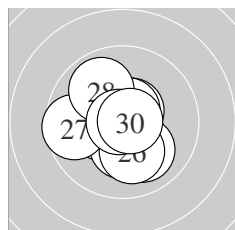

Serie 3:
 10.0 ↘ 10.4 * 10.6 * 10.6 * 10.3 *
 10.1 ↓ 9.6 ← 9.9 ↖ 10.8 * 10.7 *
 beste Teiler 26.0 (29.) 51.4 (30.) 87.4 (24.)
 Trefferlage 0.29 mm links, 0.24 mm tief
 Streuwert 1.35, horizontal: 1.37, vertikal: 1.34

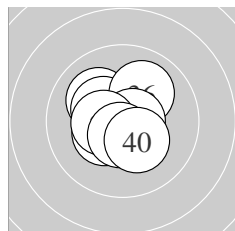

Serie 4:
 10.1 ↖ 10.4 * 10.7 * 10.3 * 10.8 *
 10.0 ↗ 10.7 * 10.4 * 10.6 * 10.3 *
 beste Teiler 42.0 (35.) 62.8 (33.) 69.0 (37.)
 Trefferlage 0.19 mm links, 0.04 mm hoch
 Streuwert 1.07, horizontal: 1.10, vertikal: 1.05

Unterschrift des Schützen

Meyton Elektronik

Ergebnis: **417.9** (399)
 Serien: 103.8 104.9 105.4 103.8
 Zähler: 39 1 0 0 0 0 0 0 0 0
 Innenzehner: 37
 weiteste: 251 (17), 233 (2), 224 (4)
 beste Teiler 27.0 (15.) 45.0 (27.) 49.4 (12.)
 Trefferlage 0.31 mm rechts, 0.30 mm hoch
 Streuwert 0.92, horizontal: 1.00, vertikal: 0.84

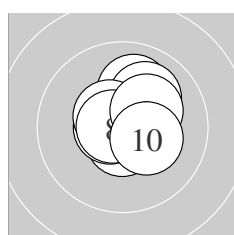
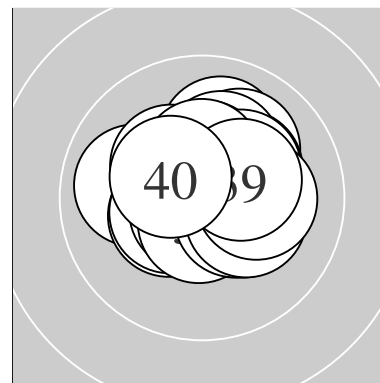

Serie 1:
 10.2 * 10.0 ↑ 10.6 * 10.1 ↗ 10.6 *
 10.6 * 10.5 * 10.7 * 10.2 * 10.3 *
 beste Teiler 61.1 (8.) 78.0 (5.) 78.0 (6.)
 Trefferlage 0.40 mm rechts, 0.57 mm hoch
 Streuwert 1.00, horizontal: 0.91, vertikal: 1.08

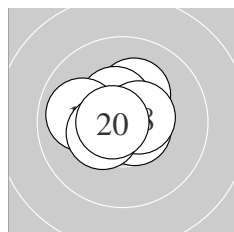

Serie 2:
 10.2 * 10.8 * 10.5 * 10.5 * 10.8 *
 10.6 * 9.9 ← 10.5 * 10.4 * 10.7 *
 beste Teiler 27.0 (15.) 49.4 (12.) 63.0 (20.)
 Trefferlage 0.19 mm links, 0.35 mm hoch
 Streuwert 0.91, horizontal: 1.07, vertikal: 0.73

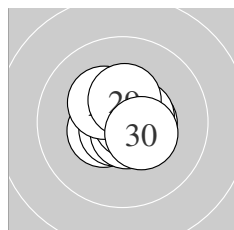

Serie 3:
 10.4 * 10.7 * 10.6 * 10.7 * 10.5 *
 10.6 * 10.8 * 10.3 * 10.4 * 10.4 *
 beste Teiler 45.0 (27.) 63.6 (22.) 66.8 (24.)
 Trefferlage 0.20 mm rechts, 0.01 mm hoch
 Streuwert 0.80, horizontal: 0.86, vertikal: 0.73

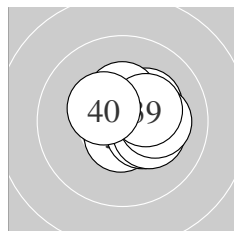

Serie 4:
 10.6 * 10.4 * 10.4 * 10.3 * 10.5 *
 10.4 * 10.3 * 10.2 * 10.3 * 10.4 *
 beste Teiler 89.8 (31.) 111.0 (35.) 127.5 (32.)
 Trefferlage 0.85 mm rechts, 0.25 mm hoch
 Streuwert 0.89, horizontal: 0.98, vertikal: 0.79

Unterschrift des Schützen

Meyton Elektronik

Ergebnis: **414.8** (398)
 Serien: 104.9 104.0 102.0 103.9
 Zähler: 38 2 0 0 0 0 0 0 0 0
 Innenzehner: 31
 weiteste: 462 (30), 252 (16), 237 (25)
 beste Teiler 26.0 (20.) 50.9 (8.) 68.0 (10.)
 Trefferlage 0.13 mm rechts, 0.21 mm tief
 Streuwert 1.16, horizontal: 1.25, vertikal: 1.06

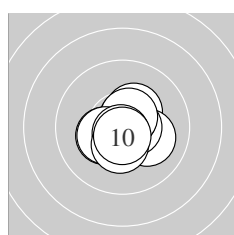
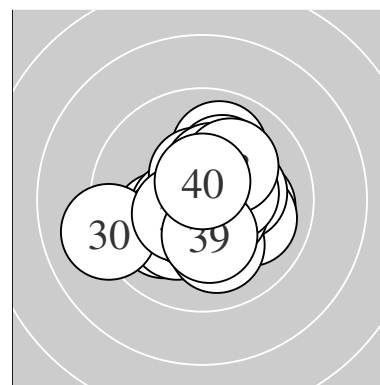

Serie 1:
 10.4 * 10.3 * 10.1 ↘ 10.6 * 10.6 *
 10.6 * 10.4 * 10.8 * 10.4 * 10.7 *
 beste Teiler 50.9 (8.) 68.0 (10.) 79.4 (5.)
 Trefferlage 0.13 mm rechts, 0.19 mm tief
 Streuwert 0.93, horizontal: 1.01, vertikal: 0.83

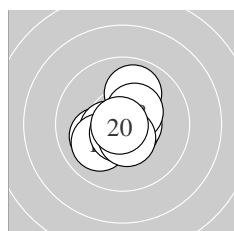

Serie 2:
 10.6 * 10.1 ↙ 10.5 * 10.0 ↙ 10.6 *
 9.9 ↑ 10.6 * 10.4 * 10.5 * 10.8 *
 beste Teiler 26.0 (20.) 76.2 (11.) 78.2 (15.)
 Trefferlage 0.19 mm links, 0.18 mm tief
 Streuwert 1.10, horizontal: 1.09, vertikal: 1.12

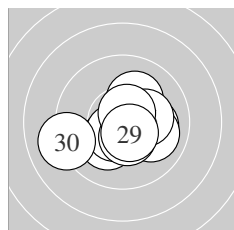

Serie 3:
 10.2 * 10.5 * 10.2 * 10.1 → 10.0 →
 10.2 * 10.5 * 10.6 * 10.6 * 9.1 ←
 beste Teiler 78.2 (28.) 100.4 (29.) 104.2 (22.)
 Trefferlage 0.21 mm rechts, 0.42 mm tief
 Streuwert 1.57, horizontal: 1.96, vertikal: 1.05

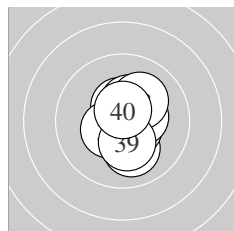

Serie 4:
 10.1 ↓ 10.5 * 10.4 * 10.5 * 10.5 *
 10.5 * 10.4 * 10.1 ↗ 10.3 * 10.6 *
 beste Teiler 87.0 (40.) 102.6 (36.) 111.0 (34.)
 Trefferlage 0.36 mm rechts, 0.07 mm tief
 Streuwert 1.07, horizontal: 0.75, vertikal: 1.32

Unterschrift des Schützen

Meyton Elektronik

Ergebnis: **418.0** (396)
 Serien: 104.4 103.2 105.6 104.8
 Zähler: 36 4 0 0 0 0 0 0 0 0
 Innenzehner: 35
 weiteste: 339 (18), 300 (1), 283 (19)
 beste Teiler 26.1 (2.) 27.2 (28.) 29.8 (3.)
 Trefferlage 0.13 mm links, 0.33 mm hoch
 Streuwert 1.03, horizontal: 1.05, vertikal: 1.02

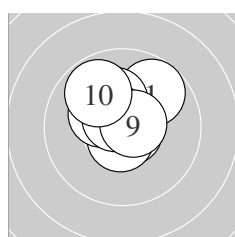
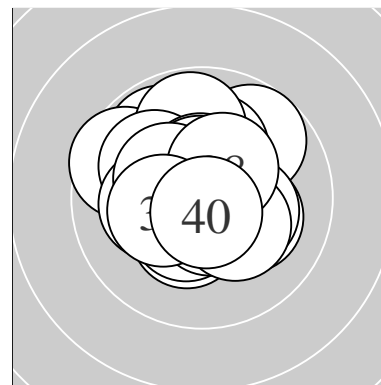

Serie 1:
 9.8 ↗ 10.8 * 10.8 * 10.7 * 10.7 *
 10.3 * 10.2 * 10.6 * 10.7 * 9.8 ↘
 beste Teiler 26.1 (2.) 29.8 (3.) 51.8 (4.)
 Trefferlage 0.10 mm links, 0.65 mm hoch
 Streuwert 1.08, horizontal: 1.03, vertikal: 1.12

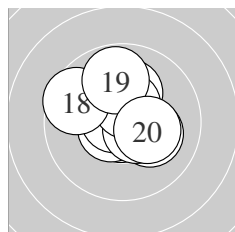

Serie 2:
 10.8 * 10.6 * 10.7 * 10.2 * 10.5 *
 10.2 * 10.5 * 9.6 ↙ 9.8 ↑ 10.3 *
 beste Teiler 46.8 (11.) 58.5 (13.) 87.2 (12.)
 Trefferlage 0.01 mm rechts, 0.48 mm hoch
 Streuwert 1.33, horizontal: 1.41, vertikal: 1.25

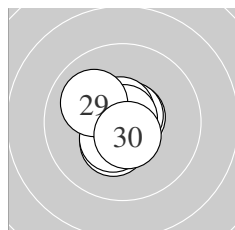

Serie 3:
 10.7 * 10.8 * 10.4 * 10.7 * 10.4 *
 10.6 * 10.6 * 10.8 * 10.0 ↖ 10.6 *
 beste Teiler 27.2 (28.) 36.1 (22.) 65.0 (24.)
 Trefferlage 0.20 mm links, 0.02 mm hoch
 Streuwert 0.82, horizontal: 0.75, vertikal: 0.89

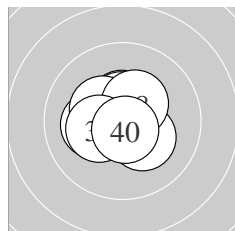

Serie 4:
 10.8 * 10.8 * 10.5 * 10.2 * 10.3 *
 10.5 * 10.3 * 10.4 * 10.3 * 10.7 *
 beste Teiler 30.1 (32.) 36.7 (31.) 60.4 (40.)
 Trefferlage 0.25 mm links, 0.20 mm hoch
 Streuwert 0.93, horizontal: 1.04, vertikal: 0.81

Unterschrift des Schützen

Meyton Elektronik

Ergebnis: **417.2** (398)
 Serien: 104.6 105.2 104.3 103.1
 Zähler: 38 2 0 0 0 0 0 0 0 0
 Innenzehner: 35
 weiteste: 288 (22), 255 (23), 236 (33)
 beste Teiler 34.2 (15.) 45.0 (27.) 48.4 (7.)
 Trefferlage 0.19 mm rechts, 0.40 mm hoch
 Streuwert 0.98, horizontal: 0.98, vertikal: 0.98

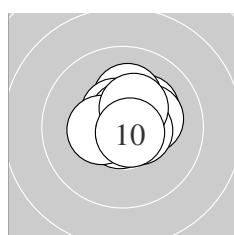
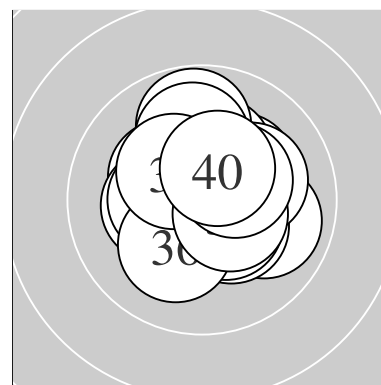

Serie 1:
 10.2 * 10.2 * 10.2 * 10.5 * 10.5 *
 10.7 * 10.8 * 10.4 * 10.4 * 10.7 *
 beste Teiler 48.4 (7.) 59.4 (10.) 71.7 (6.)
 Trefferlage 0.37 mm rechts, 0.52 mm hoch
 Streuwert 0.86, horizontal: 0.92, vertikal: 0.80

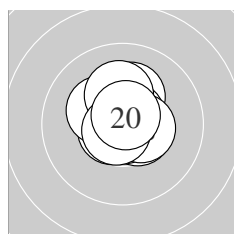

Serie 2:
 10.6 * 10.5 * 10.2 * 10.7 * 10.8 *
 10.3 * 10.2 * 10.5 * 10.7 * 10.7 *
 beste Teiler 34.2 (15.) 57.9 (19.) 61.3 (20.)
 Trefferlage 0.06 mm rechts, 0.38 mm hoch
 Streuwert 0.85, horizontal: 0.79, vertikal: 0.90

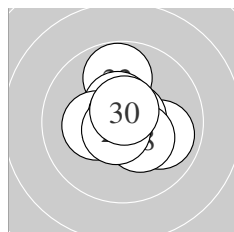

Serie 3:
 10.6 * 9.8 ↑ 9.9 ↘ 10.7 * 10.5 *
 10.3 * 10.8 * 10.3 * 10.7 * 10.7 *
 beste Teiler 45.0 (27.) 66.0 (29.) 66.2 (24.)
 Trefferlage 0.08 mm rechts, 0.32 mm hoch
 Streuwert 1.12, horizontal: 1.12, vertikal: 1.12

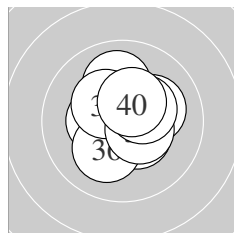

Serie 4:
 10.1 ↗ 10.4 * 10.0 ↑ 10.4 * 10.5 *
 10.1 ↘ 10.3 * 10.5 * 10.4 * 10.4 *
 beste Teiler 122.5 (38.) 124.4 (35.) 127.3 (34.)
 Trefferlage 0.27 mm rechts, 0.39 mm hoch
 Streuwert 1.17, horizontal: 1.16, vertikal: 1.18

Unterschrift des Schützen

Meyton Elektronik

Ergebnis: **414.9** (395)
 Serien: 103.9 103.8 104.1 103.1
 Zähler: 35 5 0 0 0 0 0 0 0 0
 Innenzehner: 33
 weiteste: 361 (40), 305 (8), 293 (21)
 beste Teiler 8.2 (6.) 12.2 (28.) 50.9 (10.)
 Trefferlage 0.11 mm rechts, 0.24 mm hoch
 Streuwert 1.15, horizontal: 1.28, vertikal: 1.00

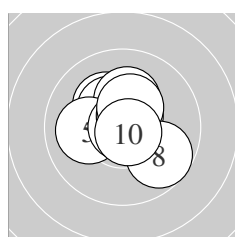
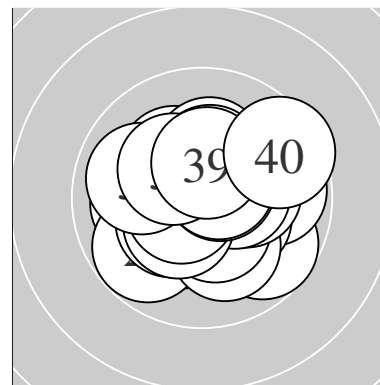

Serie 1:
 10.2 * 10.4 * 10.7 * 10.2 * 10.0 ←
 10.9 * 10.6 * 9.7 ↘ 10.4 * 10.8 *
 beste Teiler 8.2 (6.) 50.9 (10.) 61.7 (3.)
 Trefferlage 0.02 mm rechts, 0.46 mm hoch
 Streuwert 1.17, horizontal: 1.24, vertikal: 1.09

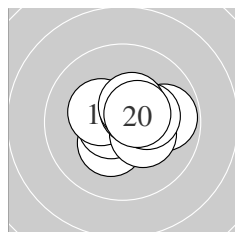

Serie 2:
 10.3 * 10.6 * 9.8 → 10.7 * 10.3 *
 10.3 * 10.5 * 10.3 * 10.5 * 10.5 *
 beste Teiler 62.0 (14.) 78.8 (12.) 106.8 (17.)
 Trefferlage 0.51 mm rechts, 0.20 mm hoch
 Streuwert 1.06, horizontal: 1.28, vertikal: 0.78

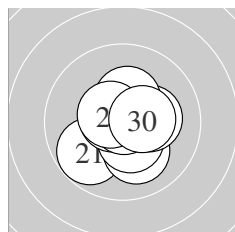

Serie 3:
 9.8 ↙ 10.1 ↘ 10.4 * 10.7 * 10.2 *
 10.3 * 10.7 * 10.9 * 10.6 * 10.4 *
 beste Teiler 12.2 (28.) 68.6 (24.) 70.2 (27.)
 Trefferlage 0.08 mm rechts, 0.18 mm tief
 Streuwert 1.14, horizontal: 1.16, vertikal: 1.13

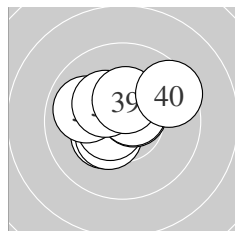

Serie 4:
 10.3 * 10.4 * 10.6 * 10.5 * 9.9 ↖
 10.6 * 10.6 * 10.3 * 10.4 * 9.5 →
 beste Teiler 89.0 (36.) 89.3 (37.) 92.1 (33.)
 Trefferlage 0.13 mm links, 0.48 mm hoch
 Streuwert 1.28, horizontal: 1.53, vertikal: 0.97

Unterschrift des Schützen

Meyton Elektronik

Ergebnis: **416.0** (397)
 Serien: 103.2 104.1 104.3 104.4
 Zähler: 37 3 0 0 0 0 0 0 0 0
 Innenzehner: 30
 weiteste: 286 (38), 273 (21), 263 (1)
 beste Teiler 34.0 (14.) 43.6 (31.) 47.0 (25.)
 Trefferlage 0.26 mm rechts, 0.31 mm hoch
 Streuwert 1.06, horizontal: 1.16, vertikal: 0.95

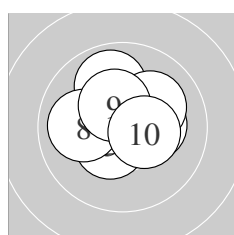
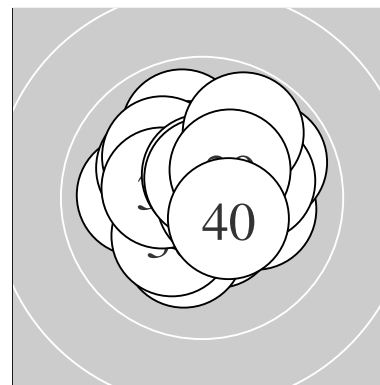

Serie 1:
 9.9 ↗ 10.5 * 10.5 * 10.6 * 10.3 *
 10.5 * 10.1 ↗ 10.0 ← 10.4 * 10.4 *
 beste Teiler 78.7 (4.) 103.7 (6.) 110.4 (2.)
 Trefferlage 0.04 mm links, 0.59 mm hoch
 Streuwert 1.18, horizontal: 1.36, vertikal: 0.98

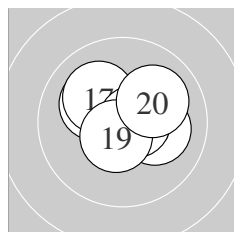

Serie 2:
 10.7 * 10.5 * 10.1 → 10.8 * 10.5 *
 10.1 ↖ 10.1 ↖ 10.7 * 10.6 * 10.0 ↗
 beste Teiler 34.0 (14.) 69.0 (11.) 74.0 (18.)
 Trefferlage 0.12 mm rechts, 0.38 mm hoch
 Streuwert 1.07, horizontal: 1.29, vertikal: 0.79

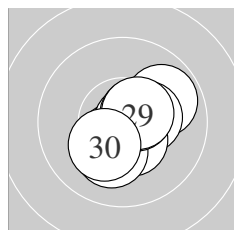

Serie 3:
 9.9 ↗ 10.4 * 10.5 * 10.7 * 10.8 *
 10.5 * 10.2 * 10.6 * 10.5 * 10.2 *
 beste Teiler 47.0 (25.) 51.6 (24.) 94.4 (28.)
 Trefferlage 0.45 mm rechts, 0.32 mm tief
 Streuwert 1.03, horizontal: 1.05, vertikal: 1.01

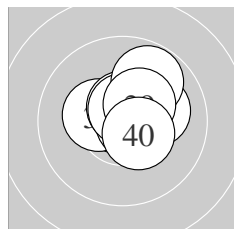

Serie 4:
 10.8 * 10.5 * 10.3 * 10.6 * 10.7 *
 10.7 * 10.1 → 9.8 ↗ 10.4 * 10.5 *
 beste Teiler 43.6 (31.) 58.0 (35.) 73.6 (36.)
 Trefferlage 0.51 mm rechts, 0.61 mm hoch
 Streuwert 0.91, horizontal: 0.99, vertikal: 0.83

Unterschrift des Schützen

Meyton Elektronik

Ergebnis: **396.9** (380)
 Serien: 97.7 99.9 101.1 98.2
 Zähler: 23 14 3 0 0 0 0 0 0 0
 Innenzehner: 18
 weiteste: 677 (36), 589 (5), 501 (16)
 beste Teiler 14.7 (22.) 66.0 (12.) 77.6 (38.)
 Trefferlage 0.24 mm rechts, 0.51 mm hoch
 Streuwert 2.06, horizontal: 2.70, vertikal: 1.10

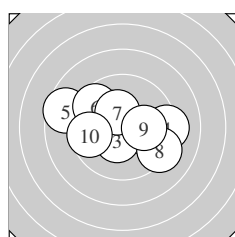
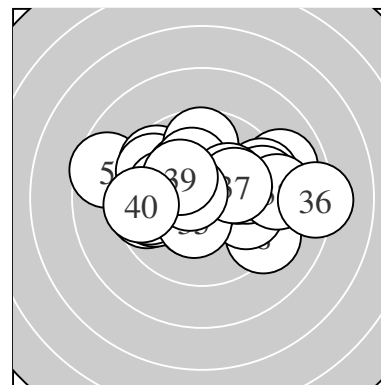

Serie 1:
 10.5 * 10.2 * 10.4 * 9.2 → 8.6 ←
 9.6 ↖ 10.3 * 9.2 ↘ 10.1 → 9.6 ←
 beste Teiler 122.8 (1.) 138.9 (3.) 155.5 (7.)
 Trefferlage 0.26 mm links, 0.18 mm hoch
 Streuwert 2.45, horizontal: 3.16, vertikal: 1.42

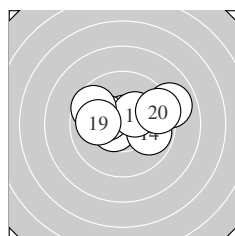

Serie 2:
 10.2 * 10.7 * 10.6 * 9.9 → 10.3 *
 8.9 → 10.3 * 9.6 ↖ 10.0 ← 9.4 →
 beste Teiler 66.0 (12.) 98.4 (13.) 155.8 (17.)
 Trefferlage 0.64 mm rechts, 0.57 mm hoch
 Streuwert 1.93, horizontal: 2.58, vertikal: 0.88

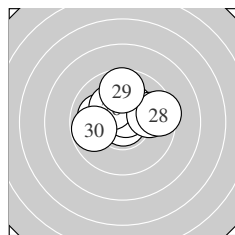

Serie 3:
 10.3 * 10.9 * 10.0 ← 10.2 * 10.6 *
 10.2 * 9.9 → 9.5 → 9.7 ↑ 9.8 ←
 beste Teiler 14.7 (22.) 78.7 (25.) 166.2 (21.)
 Trefferlage 0.12 mm rechts, 0.99 mm hoch
 Streuwert 1.58, horizontal: 1.97, vertikal: 1.06

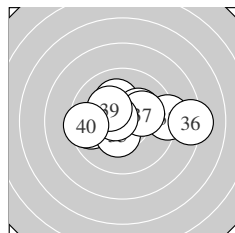

Serie 4:
 10.1 ↖ 9.7 ← 9.2 → 10.2 * 10.4 *
 8.2 → 10.1 → 10.6 * 10.2 * 9.5 ←
 beste Teiler 77.6 (38.) 141.0 (35.) 179.6 (39.)
 Trefferlage 0.48 mm rechts, 0.31 mm hoch
 Streuwert 2.40, horizontal: 3.25, vertikal: 0.96

Unterschrift des Schützen

Ergebnis: **406.0** (388)
 Serien: 100.6 101.3 103.1 101.0
 Zähler: 28 12 0 0 0 0 0 0 0 0
 Innenzehner: 20
 weiteste: 384 (39), 348 (8), 337 (13)
 beste Teiler 12.2 (27.) 35.0 (30.) 50.0 (10.)
 Trefferlage 0.29 mm links, 0.56 mm hoch
 Streuwert 1.51, horizontal: 1.65, vertikal: 1.35

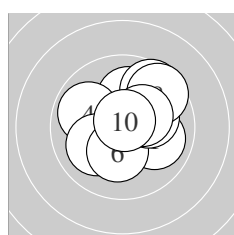
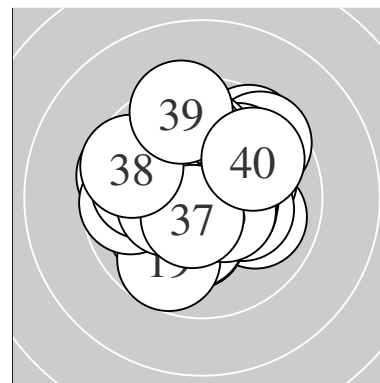

Serie 1:
 10.0 ↘ 10.1 ↑ 9.6 ↗ 9.9 ↖ 10.0 ↙
 10.2 * 10.1 → 9.6 ↗ 10.3 * 10.8 *
 beste Teiler 50.0 (10.) 164.9 (9.) 176.9 (6.)
 Trefferlage 0.60 mm rechts, 0.64 mm hoch
 Streuwert 1.65, horizontal: 1.76, vertikal: 1.53

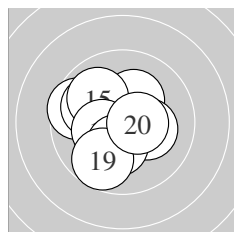

Serie 2:
 10.2 * 10.5 * 9.6 ↖ 10.0 ↖ 10.0 ↖
 10.3 * 10.2 * 10.3 * 9.7 ↙ 10.5 *
 beste Teiler 102.4 (12.) 109.2 (20.) 158.7 (16.)
 Trefferlage 0.79 mm links, 0.01 mm hoch
 Streuwert 1.51, horizontal: 1.59, vertikal: 1.43

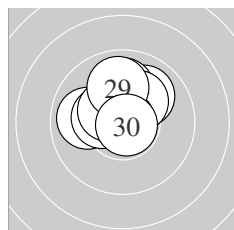

Serie 3:
 10.7 * 10.0 ↗ 10.0 ↑ 9.9 ← 10.3 *
 10.2 * 10.9 * 10.4 * 9.9 ↑ 10.8 *
 beste Teiler 12.2 (27.) 35.0 (30.) 58.2 (21.)
 Trefferlage 0.23 mm links, 1.02 mm hoch
 Streuwert 1.10, horizontal: 1.20, vertikal: 0.99

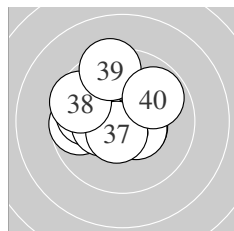

Serie 4:
 10.6 * 9.7 ← 9.9 ← 10.4 * 10.5 *
 10.5 * 10.6 * 9.6 ↖ 9.4 ↑ 9.8 ↗
 beste Teiler 80.0 (31.) 91.7 (37.) 111.0 (35.)
 Trefferlage 0.77 mm links, 0.56 mm hoch
 Streuwert 1.63, horizontal: 1.83, vertikal: 1.40

Unterschrift des Schützen

Meyton Elektronik

Ergebnis: **405.0** (387)
 Serien: 101.1 102.8 101.2 99.9
 Zähler: 28 11 1 0 0 0 0 0 0 0
 Innenzehner: 21
 weiteste: 638 (33), 390 (39), 341 (6)
 beste Teiler 60.6 (29.) 79.8 (16.) 101.7 (15.)
 Trefferlage 0.20 mm links, 0.49 mm tief
 Streuwert 1.63, horizontal: 1.80, vertikal: 1.44

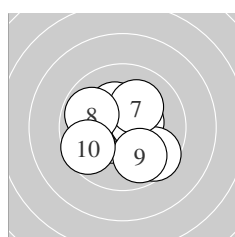
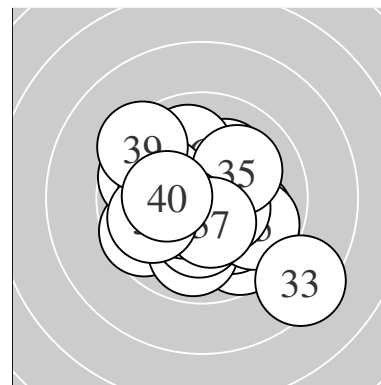

Serie 1:
 10.2 * 10.5 * 10.3 * 10.5 * 10.5 *
 9.6 ↘ 10.1 ↗ 9.9 ↖ 9.9 ↘ 9.6 ↖
 beste Teiler 109.7 (4.) 110.0 (2.) 124.9 (5.)
 Trefferlage 0.02 mm rechts, 0.27 mm tief
 Streuwert 1.69, horizontal: 1.80, vertikal: 1.57

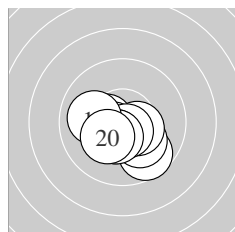

Serie 2:
 9.7 ↘ 10.1 ↘ 10.4 * 10.4 * 10.5 *
 10.6 * 10.4 * 10.4 * 10.0 ← 10.3 *
 beste Teiler 79.8 (16.) 101.7 (15.) 131.1 (13.)
 Trefferlage 0.21 mm links, 0.91 mm tief
 Streuwert 1.14, horizontal: 1.37, vertikal: 0.83

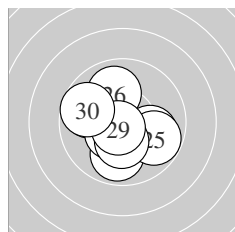

Serie 3:
 10.0 ↘ 10.5 * 9.9 ↓ 9.8 ↖ 9.8 ↘
 10.0 ↑ 10.5 * 10.3 * 10.7 * 9.7 ↖
 beste Teiler 60.6 (29.) 118.8 (22.) 125.8 (27.)
 Trefferlage 0.44 mm links, 0.32 mm tief
 Streuwert 1.64, horizontal: 1.79, vertikal: 1.47

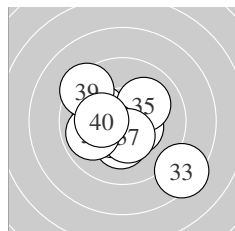

Serie 4:
 10.5 * 10.1 ↖ 8.4 ↘ 10.3 * 10.1 ↗
 10.5 * 10.4 * 9.9 ↖ 9.4 ↘ 10.3 *
 beste Teiler 115.4 (36.) 125.0 (31.) 129.6 (37.)
 Trefferlage 0.18 mm links, 0.45 mm tief
 Streuwert 2.11, horizontal: 2.37, vertikal: 1.83

Unterschrift des Schützen

Meyton Elektronik

Ergebnis: **402.9** (386)
 Serien: 97.3 101.1 103.3 101.2
 Zähler: 28 10 2 0 0 0 0 0 0 0
 Innenzehner: 21
 weiteste: 580 (4), 509 (7), 468 (8)
 beste Teiler 54.5 (13.) 54.5 (30.) 61.4 (32.)
 Trefferlage 0.52 mm rechts, 0.32 mm hoch
 Streuwert 1.73, horizontal: 2.08, vertikal: 1.29

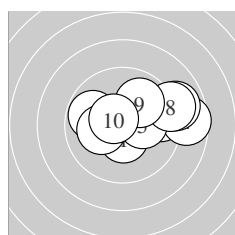
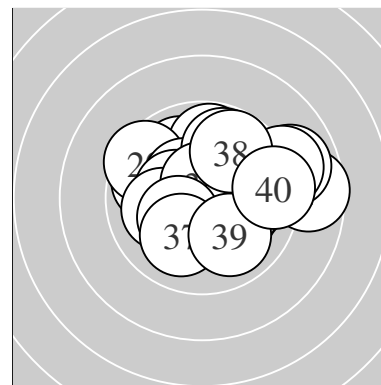

Serie 1:
 10.5 * 9.5 → 9.8 ↖ 8.6 → 10.2 *
 10.2 * 8.9 → 9.1 → 9.9 ↗ 10.6 *
 beste Teiler 99.6 (10.) 118.2 (1.) 183.3 (5.)
 Trefferlage 1.64 mm rechts, 0.66 mm hoch
 Streuwert 2.20, horizontal: 2.94, vertikal: 1.00

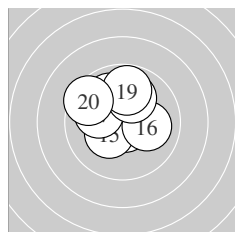

Serie 2:
 10.2 * 10.5 * 10.7 * 10.0 ↘ 10.3 *
 10.1 → 10.0 ↖ 10.0 ↑ 9.8 ↑ 9.5 ↖
 beste Teiler 54.5 (13.) 119.3 (12.) 158.9 (15.)
 Trefferlage 0.09 mm links, 0.78 mm hoch
 Streuwert 1.58, horizontal: 1.75, vertikal: 1.40

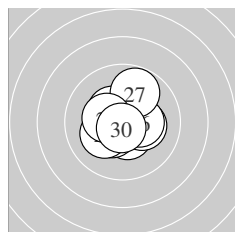

Serie 3:
 10.4 * 10.4 * 10.5 * 10.4 * 10.2 *
 10.3 * 9.8 ↑ 10.2 * 10.4 * 10.7 *
 beste Teiler 54.5 (30.) 124.4 (23.) 128.3 (21.)
 Trefferlage 0.10 mm rechts, 0.00 mm
 Streuwert 1.22, horizontal: 1.29, vertikal: 1.15

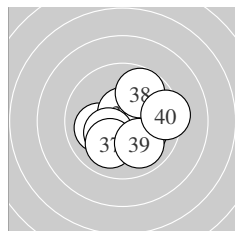

Serie 4:
 10.3 * 10.7 * 10.1 ← 10.6 * 10.1 ↘
 10.3 * 10.0 ↙ 9.8 ↑ 9.9 ↘ 9.4 →
 beste Teiler 61.4 (32.) 80.0 (34.) 163.9 (31.)
 Trefferlage 0.46 mm rechts, 0.17 mm tief
 Streuwert 1.66, horizontal: 1.82, vertikal: 1.47

Unterschrift des Schützen

Meyton Elektronik

Ergebnis: **406.2** (388)
 Serien: 99.8 100.7 101.6 104.1
 Zähler: 28 12 0 0 0 0 0 0 0 0
 Innenzehner: 24
 weiteste: 458 (4), 406 (9), 395 (28)
 beste Teiler 35.4 (34.) 59.4 (33.) 68.8 (10.)
 Trefferlage 0.49 mm rechts, 0.79 mm hoch
 Streuwert 1.50, horizontal: 1.56, vertikal: 1.44

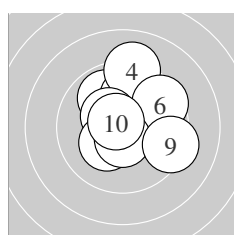
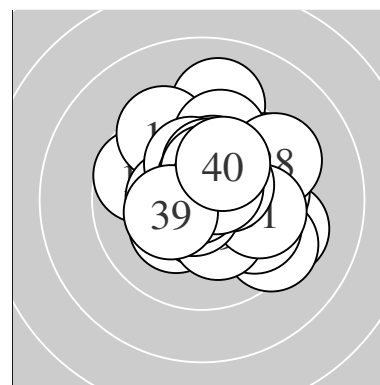

Serie 1:
 10.0 ↗ 9.9 ↘ 10.0 ↑ 9.1 ↑ 10.4 *
 9.5 ↗ 10.3 * 10.6 * 9.3 → 10.7 *
 beste Teiler 68.8 (10.) 95.0 (8.) 142.2 (5.)
 Trefferlage 0.58 mm rechts, 1.01 mm hoch
 Streuwert 1.86, horizontal: 1.83, vertikal: 1.88

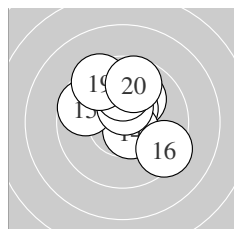

Serie 2:
 10.7 * 10.1 ↗ 10.5 * 10.6 * 9.7 ↖
 9.4 ↘ 10.5 * 10.0 ↑ 9.5 ↘ 9.7 ↑
 beste Teiler 75.4 (11.) 94.0 (14.) 121.7 (13.)
 Trefferlage 0.25 mm rechts, 1.16 mm hoch
 Streuwert 1.66, horizontal: 1.68, vertikal: 1.63

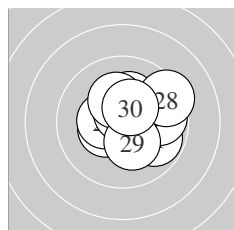

Serie 3:
 9.8 ↘ 10.4 * 10.4 * 9.8 → 10.7 *
 10.2 * 10.2 * 9.4 ↗ 10.3 * 10.4 *
 beste Teiler 70.2 (25.) 131.9 (30.) 140.5 (23.)
 Trefferlage 0.74 mm rechts, 0.43 mm hoch
 Streuwert 1.50, horizontal: 1.71, vertikal: 1.25

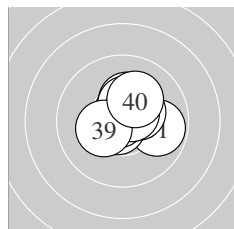

Serie 4:
 9.8 → 10.4 * 10.7 * 10.8 * 10.3 *
 10.6 * 10.4 * 10.6 * 10.3 * 10.2 *
 beste Teiler 35.4 (34.) 59.4 (33.) 91.3 (38.)
 Trefferlage 0.40 mm rechts, 0.55 mm hoch
 Streuwert 1.01, horizontal: 1.13, vertikal: 0.88

Unterschrift des Schützen

Ergebnis: **408.2** (390)
 Serien: 100.2 102.2 102.1 103.7
 Zähler: 30 10 0 0 0 0 0 0 0 0
 Innenzehner: 23
 weiteste: 423 (3), 395 (7), 321 (30)
 beste Teiler 48.1 (32.) 50.2 (13.) 52.3 (34.)
 Trefferlage 0.73 mm rechts, 0.41 mm tief
 Streuwert 1.37, horizontal: 1.29, vertikal: 1.44

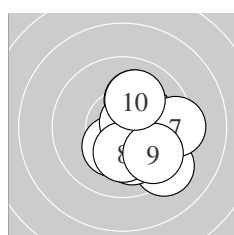
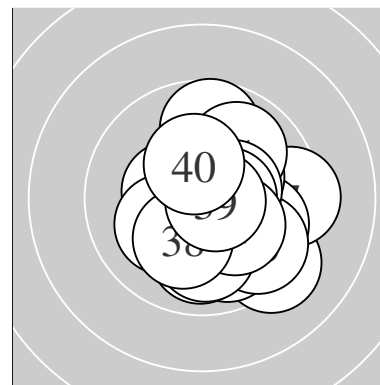

Serie 1:
 10.1 ↗ 10.3 * 9.3 ↘ 10.2 * 10.1 ↓
 10.7 * 9.4 → 10.2 * 9.8 ↘ 10.1 ↗
 beste Teiler 62.1 (6.) 162.8 (2.) 176.1 (4.)
 Trefferlage 1.31 mm rechts, 0.48 mm tief
 Streuwert 1.61, horizontal: 1.43, vertikal: 1.78

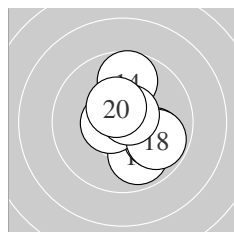

Serie 2:
 10.1 ↘ 10.2 * 10.8 * 9.7 ↑ 9.9 ↓
 9.9 ↘ 10.6 * 9.8 ↘ 10.7 * 10.5 *
 beste Teiler 50.2 (13.) 72.9 (19.) 90.3 (17.)
 Trefferlage 0.86 mm rechts, 0.19 mm tief
 Streuwert 1.37, horizontal: 1.15, vertikal: 1.57

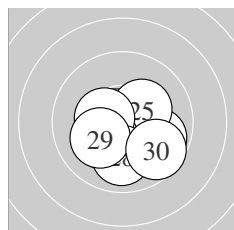

Serie 3:
 10.6 * 10.2 * 10.7 * 9.8 ↘ 10.3 *
 10.3 * 10.4 * 10.0 ↓ 10.1 ↙ 9.7 ↘
 beste Teiler 53.7 (23.) 88.7 (21.) 138.2 (27.)
 Trefferlage 0.15 mm rechts, 0.77 mm tief
 Streuwert 1.38, horizontal: 1.57, vertikal: 1.15

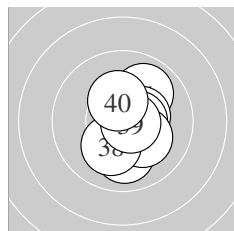

Serie 4:
 9.9 ↗ 10.8 * 10.4 * 10.7 * 10.5 *
 10.0 ↓ 10.2 * 10.2 * 10.7 * 10.3 *
 beste Teiler 48.1 (32.) 52.3 (34.) 61.6 (39.)
 Trefferlage 0.59 mm rechts, 0.19 mm tief
 Streuwert 1.12, horizontal: 0.79, vertikal: 1.36

Unterschrift des Schützen

Meyton Elektronik

Ergebnis: **412.6** (395)
 Serien: 104.6 101.9 103.0 103.1
 Zähler: 35 5 0 0 0 0 0 0 0 0
 Innenzehner: 29
 weiteste: 445 (20), 300 (26), 291 (32)
 beste Teiler 49.0 (27.) 51.9 (9.) 54.2 (8.)
 Trefferlage 0.02 mm links, 0.65 mm hoch
 Streuwert 1.22, horizontal: 1.45, vertikal: 0.92

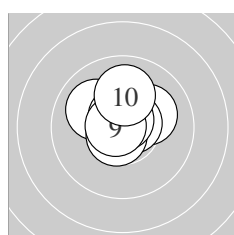
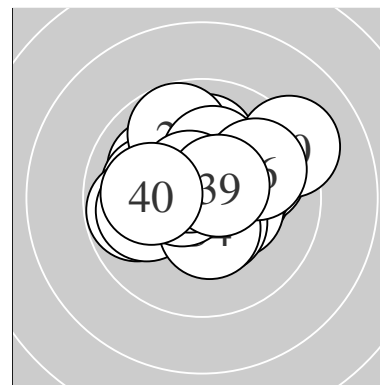

Serie 1:
 10.2 * 10.3 * 10.7 * 10.7 * 10.0 ↘
 10.6 * 10.7 * 10.7 * 10.7 * 10.0 ↑
 beste Teiler 51.9 (9.) 54.2 (8.) 60.9 (4.)
 Trefferlage 0.19 mm links, 0.74 mm hoch
 Streuwert 0.90, horizontal: 0.99, vertikal: 0.80

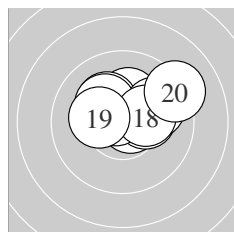

Serie 2:
 10.7 * 10.3 * 10.2 * 10.2 * 10.7 *
 9.9 ↗ 10.2 * 10.2 * 10.3 * 9.2 ↗
 beste Teiler 58.1 (11.) 70.7 (15.) 169.1 (12.)
 Trefferlage 0.59 mm rechts, 0.93 mm hoch
 Streuwert 1.38, horizontal: 1.80, vertikal: 0.74

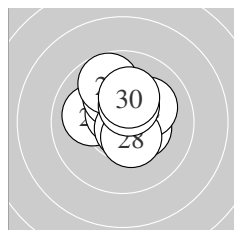

Serie 3:
 10.4 * 10.1 ↗ 10.0 ← 10.6 * 10.2 *
 9.8 ↘ 10.8 * 10.5 * 10.4 * 10.2 *
 beste Teiler 49.0 (27.) 81.0 (24.) 125.8 (28.)
 Trefferlage 0.04 mm rechts, 0.79 mm hoch
 Streuwert 1.20, horizontal: 1.18, vertikal: 1.22

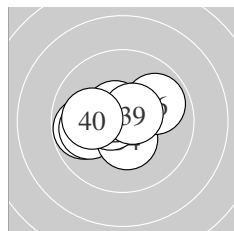

Serie 4:
 10.5 * 9.8 ← 10.0 ← 10.4 * 10.6 *
 9.9 ↗ 10.6 * 10.6 * 10.6 * 10.1 ←
 beste Teiler 88.6 (37.) 90.6 (38.) 90.8 (39.)
 Trefferlage 0.55 mm links, 0.12 mm hoch
 Streuwert 1.29, horizontal: 1.67, vertikal: 0.75

Unterschrift des Schützen

Meyton Elektronik

Ergebnis: **413.1** (397)
 Serien: 102.2 103.1 103.6 104.2
 Zähler: 37 3 0 0 0 0 0 0 0 0
 Innenzehner: 29
 weiteste: 287 (7), 273 (5), 264 (21)
 beste Teiler 34.2 (38.) 49.6 (26.) 59.6 (13.)
 Trefferlage 0.25 mm links, 0.12 mm hoch
 Streuwert 1.20, horizontal: 1.28, vertikal: 1.12

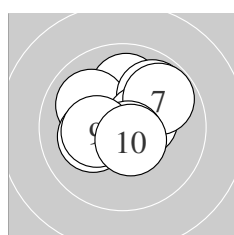
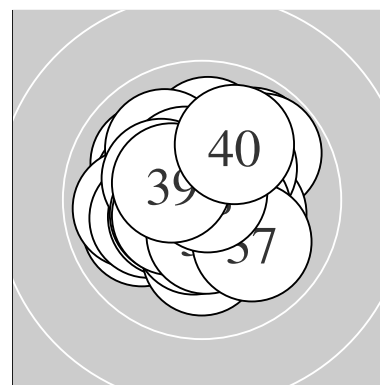

Serie 1:
 10.3 * 10.0 ↑ 10.0 ↘ 10.2 * 9.9 ↗
 10.4 * 9.8 ↗ 10.7 * 10.3 * 10.6 *
 beste Teiler 69.4 (8.) 95.7 (10.) 127.4 (6.)
 Trefferlage 0.20 mm rechts, 0.67 mm hoch
 Streuwert 1.37, horizontal: 1.53, vertikal: 1.20

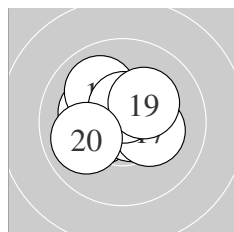

Serie 2:
 10.3 * 10.7 * 10.7 * 10.2 * 10.2 *
 10.0 ↘ 10.2 * 10.6 * 10.2 * 10.0 ←
 beste Teiler 59.6 (13.) 72.9 (12.) 93.3 (18.)
 Trefferlage 0.48 mm links, 0.43 mm hoch
 Streuwert 1.17, horizontal: 1.36, vertikal: 0.95

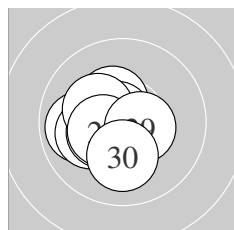

Serie 3:
 9.9 ← 10.7 * 10.4 * 10.1 ← 10.4 *
 10.8 * 10.3 * 10.4 * 10.5 * 10.1 ↓
 beste Teiler 49.6 (26.) 59.9 (22.) 115.1 (29.)
 Trefferlage 0.89 mm links, 0.17 mm tief
 Streuwert 1.02, horizontal: 1.07, vertikal: 0.95

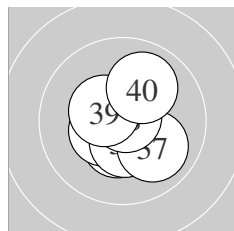

Serie 4:
 10.6 * 10.6 * 10.4 * 10.4 * 10.6 *
 10.4 * 10.0 ↘ 10.8 * 10.4 * 10.0 ↗
 beste Teiler 34.2 (38.) 83.9 (35.) 98.0 (32.)
 Trefferlage 0.15 mm rechts, 0.44 mm tief
 Streuwert 1.04, horizontal: 0.93, vertikal: 1.13

Unterschrift des Schützen

Meyton Elektronik

Ergebnis: **414.1** (397)
 Serien: 102.8 105.3 103.2 102.8
 Zähler: 37 3 0 0 0 0 0 0 0 0
 Innenzehner: 32
 weiteste: 376 (26), 306 (6), 300 (29)
 beste Teiler 28.6 (3.) 39.1 (12.) 66.0 (27.)
 Trefferlage 0.27 mm rechts, 0.21 mm hoch
 Streuwert 1.17, horizontal: 1.11, vertikal: 1.22

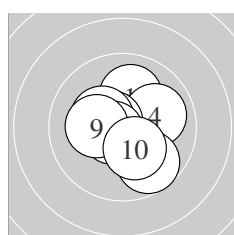
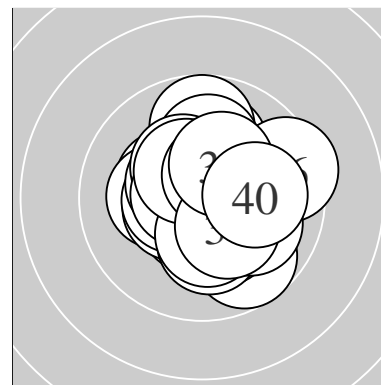

Serie 1:
 10.0 ↑ 10.3 * 10.8 * 10.0 → 10.6 *
 9.7 ↘ 10.3 * 10.6 * 10.2 * 10.3 *
 beste Teiler 28.6 (3.) 81.8 (8.) 87.3 (5.)
 Trefferlage 0.16 mm rechts, 0.10 mm tief
 Streuwert 1.35, horizontal: 1.39, vertikal: 1.32

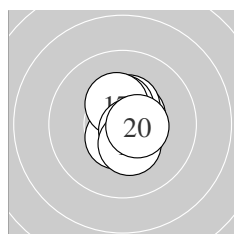

Serie 2:
 10.6 * 10.8 * 10.5 * 10.5 * 10.4 *
 10.5 * 10.4 * 10.7 * 10.4 * 10.5 *
 beste Teiler 39.1 (12.) 69.6 (18.) 96.4 (11.)
 Trefferlage 0.29 mm rechts, 0.27 mm hoch
 Streuwert 0.78, horizontal: 0.50, vertikal: 0.98

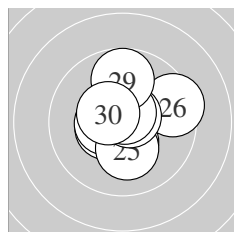

Serie 3:
 10.5 * 10.5 * 10.4 * 10.5 * 10.2 *
 9.4 → 10.7 * 10.7 * 9.8 ↑ 10.5 *
 beste Teiler 66.0 (27.) 68.6 (28.) 119.4 (24.)
 Trefferlage 0.14 mm rechts, 0.33 mm hoch
 Streuwert 1.38, horizontal: 1.37, vertikal: 1.40

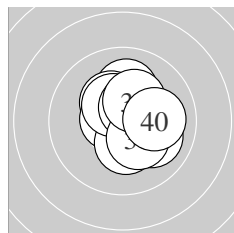

Serie 4:
 10.1 ↑ 10.3 * 10.6 * 10.3 * 10.0 ↘
 10.4 * 10.5 * 10.3 * 10.3 * 10.0 →
 beste Teiler 82.3 (33.) 111.4 (37.) 131.3 (36.)
 Trefferlage 0.49 mm rechts, 0.34 mm hoch
 Streuwert 1.19, horizontal: 1.10, vertikal: 1.27

Unterschrift des Schützen

Meyton Elektronik

Ergebnis: **411.0** (394)
 Serien: 101.7 101.8 104.3 103.2
 Zähler: 34 6 0 0 0 0 0 0 0 0
 Innenzehner: 29
 weiteste: 403 (33), 382 (3), 282 (5)
 beste Teiler 16.1 (31.) 52.3 (37.) 61.9 (32.)
 Trefferlage 0.08 mm rechts, 0.22 mm tief
 Streuwert 1.33, horizontal: 1.39, vertikal: 1.27

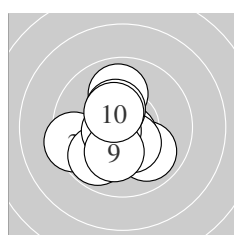
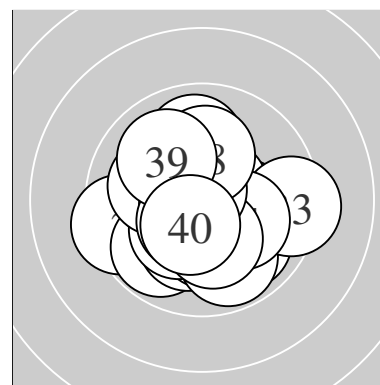

Serie 1:
 9.9 ↑ 9.9 ↘ 9.4 ← 10.7 * 9.8 ↙
 10.4 * 10.6 * 10.4 * 10.2 * 10.4 *
 beste Teiler 65.3 (4.) 89.4 (7.) 129.1 (10.)
 Trefferlage 0.57 mm links, 0.39 mm tief
 Streuwert 1.51, horizontal: 1.47, vertikal: 1.56

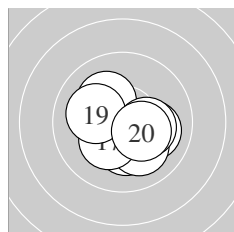

Serie 2:
 10.2 * 10.1 → 10.1 → 10.1 ↘ 10.2 *
 10.2 * 10.3 * 10.2 * 10.1 ← 10.3 *
 beste Teiler 156.5 (20.) 168.6 (17.) 177.7 (11.)
 Trefferlage 0.27 mm rechts, 0.43 mm tief
 Streuwert 1.41, horizontal: 1.67, vertikal: 1.09

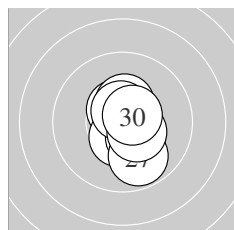

Serie 3:
 10.5 * 10.5 * 10.6 * 10.5 * 10.4 *
 10.4 * 9.8 ↘ 10.6 * 10.4 * 10.6 *
 beste Teiler 80.0 (23.) 85.9 (28.) 89.6 (30.)
 Trefferlage 0.36 mm rechts, 0.00 mm
 Streuwert 1.00, horizontal: 0.59, vertikal: 1.29

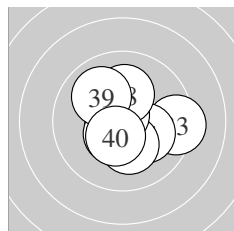

Serie 4:
 10.9 * 10.7 * 9.3 → 10.2 * 10.5 *
 10.2 * 10.7 * 10.2 * 10.0 ↘ 10.5 *
 beste Teiler 16.1 (31.) 52.3 (37.) 61.9 (32.)
 Trefferlage 0.26 mm rechts, 0.07 mm tief
 Streuwert 1.42, horizontal: 1.58, vertikal: 1.24

Unterschrift des Schützen

Meyton Elektronik

Ergebnis: **410.5** (395)
 Serien: 102.3 102.6 102.7 102.9
 Zähler: 35 5 0 0 0 0 0 0 0 0
 Innenzehner: 26
 weiteste: 390 (5), 361 (21), 293 (16)
 beste Teiler 36.6 (32.) 46.6 (10.) 63.2 (6.)
 Trefferlage 0.05 mm rechts, 0.36 mm hoch
 Streuwert 1.34, horizontal: 1.56, vertikal: 1.09

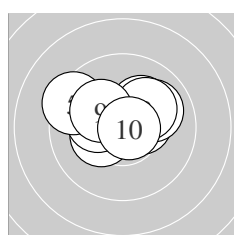
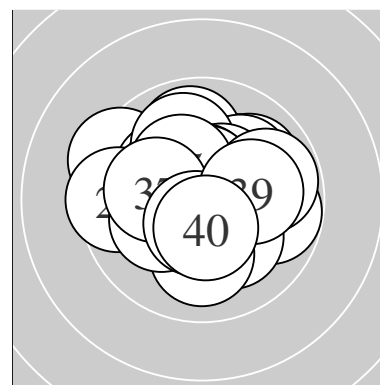

Serie 1:
 10.2 * 10.4 * 10.3 * 10.2 * 9.4 ↖
 10.7 * 10.0 ↗ 10.1 ↗ 10.2 * 10.8 *
 beste Teiler 46.6 (10.) 63.2 (6.) 132.2 (2.)
 Trefferlage 0.10 mm links, 0.72 mm hoch
 Streuwert 1.41, horizontal: 1.86, vertikal: 0.74

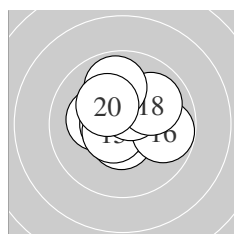

Serie 2:
 10.6 * 10.2 * 10.6 * 10.1 → 10.6 *
 9.8 → 10.5 * 10.0 ↗ 9.9 ↑ 10.3 *
 beste Teiler 82.0 (13.) 83.8 (15.) 100.3 (11.)
 Trefferlage 0.25 mm rechts, 0.48 mm hoch
 Streuwert 1.36, horizontal: 1.56, vertikal: 1.12

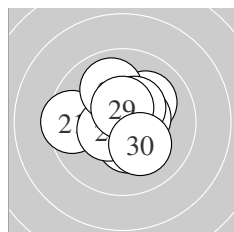

Serie 3:
 9.5 ← 10.4 * 10.1 ↗ 10.5 * 10.6 *
 10.5 * 10.0 ↖ 10.4 * 10.5 * 10.2 *
 beste Teiler 86.4 (25.) 103.0 (29.) 115.4 (24.)
 Trefferlage 0.03 mm rechts, 0.33 mm hoch
 Streuwert 1.40, horizontal: 1.55, vertikal: 1.24

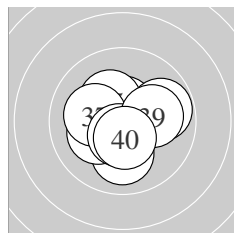

Serie 4:
 10.6 * 10.8 * 10.0 ↓ 10.2 * 10.3 *
 9.8 → 10.1 ← 10.5 * 10.1 → 10.5 *
 beste Teiler 36.6 (32.) 97.2 (31.) 104.5 (38.)
 Trefferlage 0.03 mm rechts, 0.10 mm tief
 Streuwert 1.33, horizontal: 1.48, vertikal: 1.17

Unterschrift des Schützen

Meyton Elektronik

Ergebnis: **416.9** (397)
 Serien: 102.8 104.0 105.5 104.6
 Zähler: 37 3 0 0 0 0 0 0 0 0
 Innenzehner: 31
 weiteste: 336 (27), 295 (5), 260 (14)
 beste Teiler 14.1 (22.) 22.2 (34.) 32.2 (28.)
 Trefferlage 0.15 mm links, 0.12 mm hoch
 Streuwert 1.10, horizontal: 1.28, vertikal: 0.89

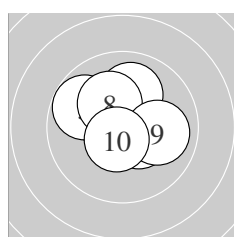
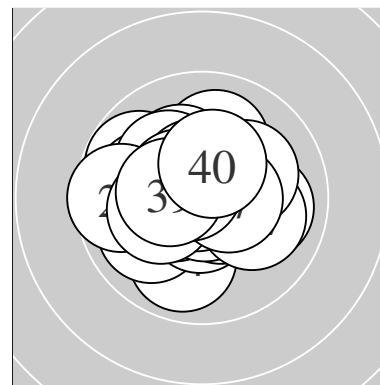

Serie 1:
 10.2 * 10.3 * 10.5 * 10.8 * 9.8 ↖
 10.0 ↑ 10.4 * 10.2 * 10.0 → 10.6 *
 beste Teiler 45.1 (4.) 94.3 (10.) 114.3 (3.)
 Trefferlage 0.04 mm rechts, 0.48 mm hoch
 Streuwert 1.31, horizontal: 1.51, vertikal: 1.08

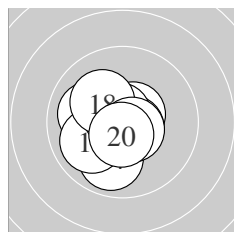

Serie 2:
 10.6 * 10.7 * 10.0 ↖ 9.9 ↓ 10.0 ↙
 10.7 * 10.7 * 10.2 * 10.6 * 10.6 *
 beste Teiler 57.3 (17.) 60.2 (16.) 72.7 (12.)
 Trefferlage 0.54 mm links, 0.21 mm tief
 Streuwert 1.11, horizontal: 1.10, vertikal: 1.13

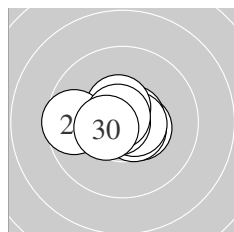

Serie 3:
 10.5 * 10.9 * 10.6 * 10.7 * 10.6 *
 10.5 * 9.6 ← 10.8 * 10.8 * 10.5 *
 beste Teiler 14.1 (22.) 32.2 (28.) 50.3 (29.)
 Trefferlage 0.19 mm links, 0.01 mm hoch
 Streuwert 0.99, horizontal: 1.32, vertikal: 0.46

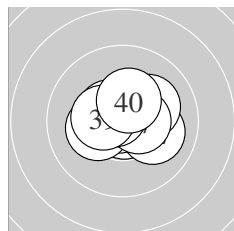

Serie 4:
 10.8 * 10.1 → 10.1 ↗ 10.9 * 10.5 *
 10.2 * 10.5 * 10.7 * 10.4 * 10.4 *
 beste Teiler 22.2 (34.) 40.8 (31.) 72.4 (38.)
 Trefferlage 0.07 mm rechts, 0.21 mm hoch
 Streuwert 1.02, horizontal: 1.28, vertikal: 0.68

Unterschrift des Schützen

Meyton Elektronik

Ergebnis: **408.4** (391)
 Serien: 103.0 100.6 103.1 101.7
 Zähler: 31 9 0 0 0 0 0 0 0 0
 Innenzehner: 23
 weiteste: 434 (19), 427 (18), 350 (29)
 beste Teiler 8.0 (3.) 11.4 (25.) 41.3 (17.)
 Trefferlage 0.00 mm , 0.43 mm hoch
 Streuwert 1.47, horizontal: 1.49, vertikal: 1.46

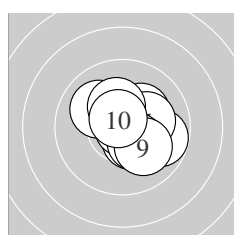
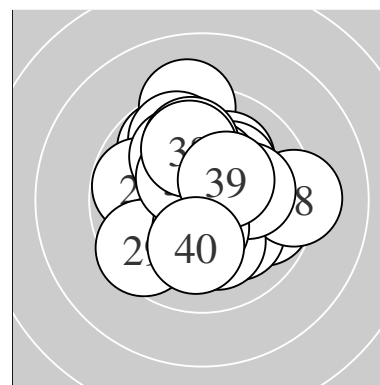

Serie 1:
 10.5 * 10.2 * 10.9 * 9.8 → 10.2 *
 10.0 ↖ 10.3 * 10.3 * 10.1 ↘ 10.7 *
 beste Teiler 8.0 (3.) 74.7 (10.) 121.7 (1.)
 Trefferlage 0.67 mm rechts, 0.07 mm hoch
 Streuwert 1.26, horizontal: 1.36, vertikal: 1.14

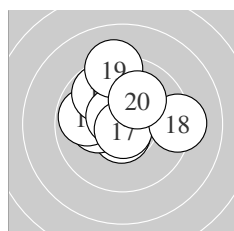

Serie 2:
 10.6 * 10.3 * 10.2 * 9.8 ← 9.8 ↖
 10.6 * 10.8 * 9.2 → 9.2 ↑ 10.1 ↗
 beste Teiler 41.3 (17.) 78.4 (11.) 85.5 (16.)
 Trefferlage 0.33 mm links, 0.98 mm hoch
 Streuwert 1.75, horizontal: 1.96, vertikal: 1.52

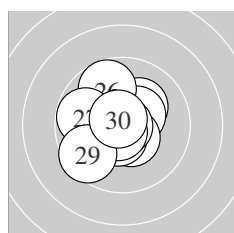

Serie 3:
 10.2 * 10.4 * 10.5 * 10.6 * 10.9 *
 9.7 ↖ 9.8 ← 10.7 * 9.6 ↙ 10.7 *
 beste Teiler 11.4 (25.) 58.0 (30.) 60.7 (28.)
 Trefferlage 0.46 mm links, 0.14 mm hoch
 Streuwert 1.42, horizontal: 1.43, vertikal: 1.41

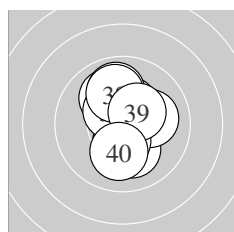

Serie 4:
 10.1 ↘ 10.3 * 10.0 ↖ 10.1 → 9.9 ↑
 10.4 * 10.4 * 10.0 ↑ 10.4 * 10.1 ↓
 beste Teiler 129.1 (36.) 132.2 (37.) 145.5 (39.)
 Trefferlage 0.09 mm rechts, 0.54 mm hoch
 Streuwert 1.42, horizontal: 1.00, vertikal: 1.74

Unterschrift des Schützen

Meyton Elektronik

Ergebnis: **398.3** (384)
 Serien: 101.7 99.0 98.5 99.1
 Zähler: 25 14 1 0 0 0 0 0 0 0
 Innenzehner: 14
 weiteste: 561 (26), 492 (11), 467 (30)
 beste Teiler 10.0 (36.) 38.9 (4.) 51.9 (20.)
 Trefferlage 0.00 mm , 0.16 mm tief
 Streuwert 2.00, horizontal: 2.16, vertikal: 1.83

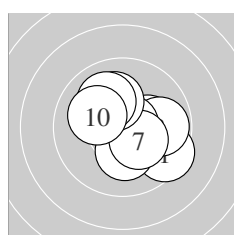
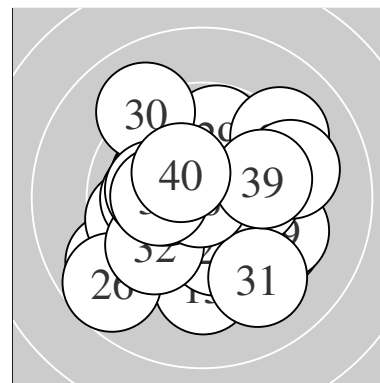

Serie 1:
 9.5 ↘ 10.2 * 9.8 → 10.8 * 10.7 *
 10.2 * 10.3 * 10.1 ↖ 10.0 ↖ 10.1 ↖
 beste Teiler 38.9 (4.) 52.0 (5.) 153.8 (7.)
 Trefferlage 0.56 mm rechts, 0.07 mm hoch
 Streuwert 1.53, horizontal: 1.70, vertikal: 1.34

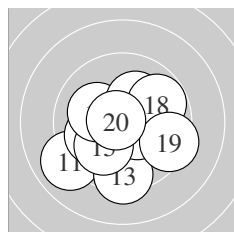

Serie 2:
 9.0 ↙ 10.0 ↙ 9.4 ↓ 10.4 * 10.0 ↗
 10.1 ↖ 10.2 * 9.8 ↗ 9.4 → 10.7 *
 beste Teiler 51.9 (20.) 127.0 (14.) 188.8 (17.)
 Trefferlage 0.17 mm links, 0.78 mm tief
 Streuwert 2.08, horizontal: 2.30, vertikal: 1.82

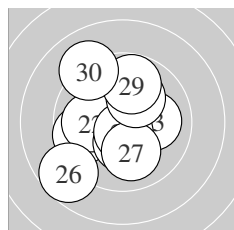

Serie 3:
 9.7 ↙ 10.0 ← 10.1 → 10.3 * 10.7 *
 8.7 ↙ 10.0 ↓ 10.1 ↑ 9.8 ↑ 9.1 ↖
 beste Teiler 74.2 (25.) 154.0 (24.) 208.5 (28.)
 Trefferlage 0.75 mm links, 0.06 mm tief
 Streuwert 2.24, horizontal: 2.10, vertikal: 2.36

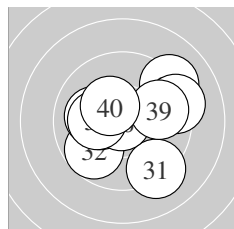

Serie 4:
 9.2 ↘ 9.7 ↙ 10.3 * 10.1 ← 9.2 ↗
 10.9 * 10.2 * 9.3 → 9.8 → 10.4 *
 beste Teiler 10.0 (36.) 149.8 (40.) 169.1 (33.)
 Trefferlage 0.38 mm rechts, 0.08 mm hoch
 Streuwert 2.20, horizontal: 2.54, vertikal: 1.80

Unterschrift des Schützen

Meyton Elektronik

Ergebnis: **405.0** (385)
 Serien: 103.6 96.9 102.5 102.0
 Zähler: 26 13 1 0 0 0 0 0 0 0
 Innenzehner: 23
 weiteste: 551 (15), 462 (29), 446 (14)
 beste Teiler 19.1 (7.) 26.4 (21.) 42.5 (16.)
 Trefferlage 0.08 mm links, 0.31 mm tief
 Streuwert 1.79, horizontal: 2.13, vertikal: 1.36

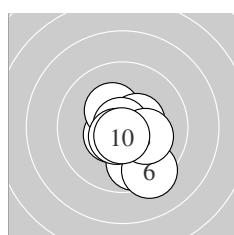
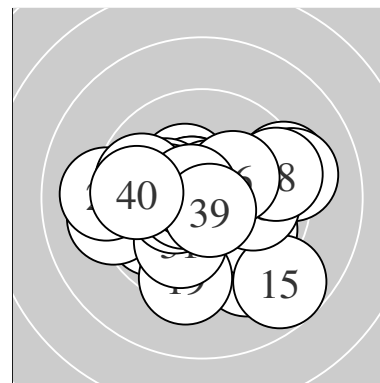

Serie 1:
 10.5 * 9.8 ↘ 10.3 * 10.5 * 10.8 *
 9.3 ↘ 10.9 * 10.2 * 10.6 * 10.7 *
 beste Teiler 19.1 (7.) 49.0 (5.) 69.3 (10.)
 Trefferlage 0.39 mm rechts, 0.75 mm tief
 Streuwert 1.27, horizontal: 1.08, vertikal: 1.43

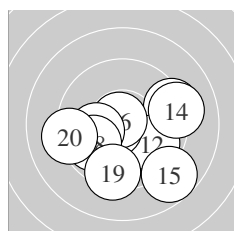

Serie 2:
 9.3 → 9.8 ↘ 10.6 * 9.2 → 8.7 ↘
 10.8 * 10.1 ← 9.8 ↙ 9.4 ↓ 9.2 ←
 beste Teiler 42.5 (16.) 77.5 (13.) 216.5 (17.)
 Trefferlage 0.38 mm rechts, 0.99 mm tief
 Streuwert 2.50, horizontal: 3.01, vertikal: 1.85

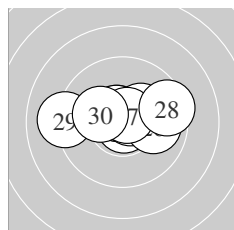

Serie 3:
 10.8 * 10.6 * 10.3 * 10.6 * 10.7 *
 10.0 → 10.7 * 9.5 → 9.1 ← 10.2 *
 beste Teiler 26.4 (21.) 64.3 (27.) 71.5 (25.)
 Trefferlage 0.12 mm rechts, 0.46 mm hoch
 Streuwert 1.64, horizontal: 2.27, vertikal: 0.46

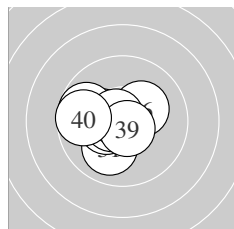

Serie 4:
 10.0 ↙ 10.4 * 9.7 ← 10.3 * 9.7 ←
 10.2 * 10.6 * 10.7 * 10.7 * 9.7 ←
 beste Teiler 63.2 (38.) 69.9 (39.) 87.5 (37.)
 Trefferlage 1.25 mm links, 0.01 mm hoch
 Streuwert 1.24, horizontal: 1.50, vertikal: 0.91

Unterschrift des Schützen

Meyton Elektronik

Ergebnis: **397.5** (381)
 Serien: 98.8 100.4 99.4 98.9
 Zähler: 23 15 2 0 0 0 0 0 0 0
 Innenzehner: 16
 weiteste: 544 (6), 541 (18), 489 (11)
 beste Teiler 62.2 (26.) 74.8 (24.) 79.0 (13.)
 Trefferlage 0.46 mm links, 0.47 mm tief
 Streuwert 2.02, horizontal: 2.41, vertikal: 1.53

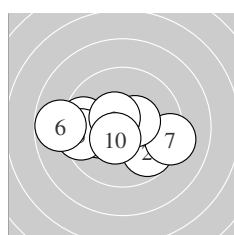
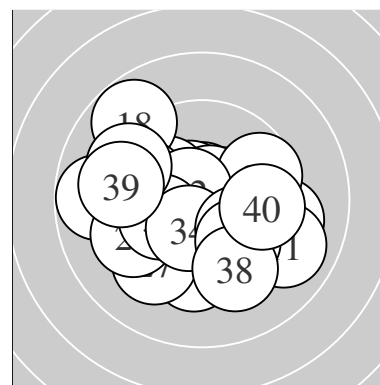

Serie 1:
 10.3 * 9.8 ↘ 10.1 ← 9.6 ← 9.5 ←
 8.8 ← 9.2 → 10.5 * 10.5 * 10.5 *
 beste Teiler 109.3 (9.) 117.5 (10.) 118.9 (8.)
 Trefferlage 0.72 mm links, 0.41 mm tief
 Streuwert 2.20, horizontal: 2.97, vertikal: 0.89

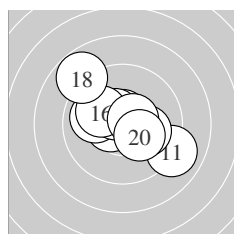

Serie 2:
 9.0 ↘ 10.5 * 10.6 * 10.0 ← 10.5 *
 10.1 ↖ 10.1 → 8.8 ↘ 10.6 * 10.2 *
 beste Teiler 79.0 (13.) 100.2 (19.) 105.5 (12.)
 Trefferlage 0.08 mm links, 0.37 mm hoch
 Streuwert 2.03, horizontal: 2.33, vertikal: 1.67

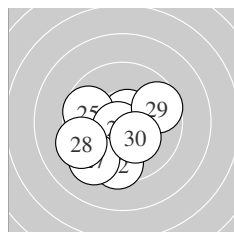

Serie 3:
 10.1 ↓ 9.5 ↓ 10.2 * 10.7 * 9.7 ↖
 10.7 * 9.3 ↙ 9.3 ← 9.6 → 10.3 *
 beste Teiler 62.2 (26.) 74.8 (24.) 174.6 (30.)
 Trefferlage 0.77 mm links, 1.05 mm tief
 Streuwert 1.84, horizontal: 2.00, vertikal: 1.67

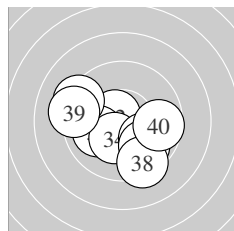

Serie 4:
 10.6 * 10.6 * 10.0 ← 10.3 * 10.0 ↘
 9.8 ↘ 9.3 ↖ 9.4 ↓ 9.2 ← 9.7 →
 beste Teiler 83.0 (32.) 93.9 (31.) 165.0 (34.)
 Trefferlage 0.28 mm links, 0.78 mm tief
 Streuwert 2.11, horizontal: 2.54, vertikal: 1.56

Unterschrift des Schützen

Meyton Elektronik

Ergebnis: **411.6** (394)
 Serien: 103.3 104.3 102.9 101.1
 Zähler: 34 6 0 0 0 0 0 0 0 0
 Innenzehner: 27
 weiteste: 459 (31), 316 (40), 269 (39)
 beste Teiler 35.5 (20.) 47.3 (38.) 52.0 (23.)
 Trefferlage 0.08 mm links, 0.17 mm hoch
 Streuwert 1.31, horizontal: 1.37, vertikal: 1.26

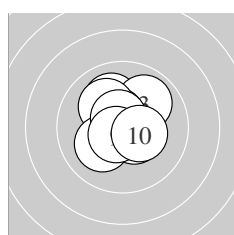
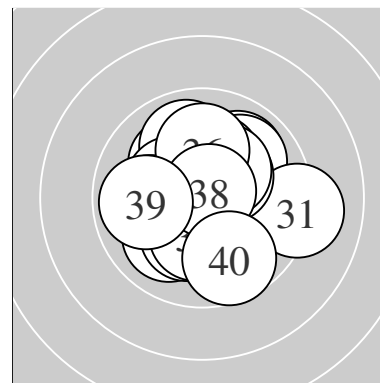

Serie 1:
 10.1 ↖ 10.5 * 9.9 ↗ 10.5 * 10.1 ↖
 10.1 ↙ 10.6 * 10.5 * 10.6 * 10.4 *
 beste Teiler 77.9 (9.) 79.7 (7.) 104.2 (4.)
 Trefferlage 0.08 mm links, 0.52 mm hoch
 Streuwert 1.17, horizontal: 1.12, vertikal: 1.21

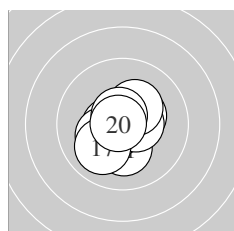

Serie 2:
 10.2 * 10.7 * 10.5 * 10.2 * 10.4 *
 10.5 * 10.0 ↙ 10.3 * 10.7 * 10.8 *
 beste Teiler 35.5 (20.) 52.8 (12.) 74.0 (19.)
 Trefferlage 0.17 mm links, 0.22 mm tief
 Streuwert 1.04, horizontal: 1.03, vertikal: 1.04

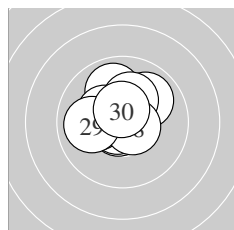

Serie 3:
 9.9 ↗ 10.7 * 10.7 * 9.9 ↗ 10.1 ←
 10.3 * 10.2 * 10.6 * 10.0 ← 10.5 *
 beste Teiler 52.0 (23.) 58.0 (22.) 86.8 (28.)
 Trefferlage 0.43 mm links, 0.62 mm hoch
 Streuwert 1.20, horizontal: 1.32, vertikal: 1.06

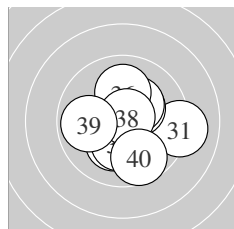

Serie 4:
 9.1 → 10.3 * 10.5 * 10.2 * 10.3 *
 10.0 ↑ 10.3 * 10.8 * 9.9 ← 9.7 ↓
 beste Teiler 47.3 (38.) 123.6 (33.) 155.8 (32.)
 Trefferlage 0.35 mm rechts, 0.23 mm tief
 Streuwert 1.76, horizontal: 1.92, vertikal: 1.57

Unterschrift des Schützen

Meyton Elektronik

Ergebnis: **400.1** (383)
 Serien: 92.8 104.1 101.7 101.5
 Zähler: 32 7 0 0 0 0 0 0 0 0
 Innenzehner: 23
 weiteste: 3437 (1), 375 (30), 340 (25)
 beste Teiler 7.2 (19.) 36.6 (3.) 39.1 (38.)
 Trefferlage 0.28 mm links, 1.17 mm hoch
 Streuwert 4.04, horizontal: 1.97, vertikal: 5.36

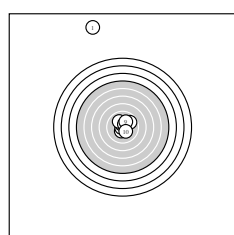
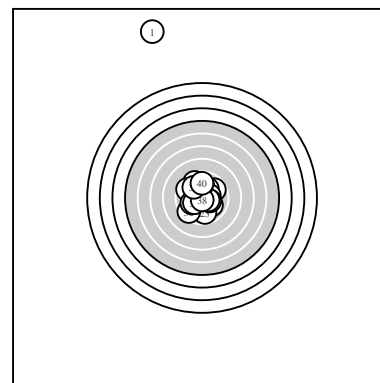

Serie 1:
 0.0 ↗ 10.4 * 10.8 * 10.3 * 10.5 *
 9.8 ↘ 10.1 ↘ 10.5 * 10.1 ↗ 10.3 *
 beste Teiler 36.6 (3.) 113.8 (8.) 118.1 (5.)
 Trefferlage 0.59 mm links, 3.87 mm hoch
 Streuwert 7.66, horizontal: 3.42, vertikal: 10.28

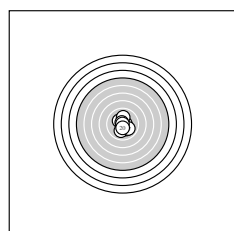

Serie 2:
 10.6 * 10.8 * 10.1 ↘ 10.1 ↓ 10.3 *
 10.1 ↑ 10.0 ↘ 10.7 * 10.9 * 10.5 *
 beste Teiler 7.2 (19.) 44.9 (12.) 60.3 (18.)
 Trefferlage 0.20 mm rechts, 0.18 mm tief
 Streuwert 1.16, horizontal: 0.89, vertikal: 1.38

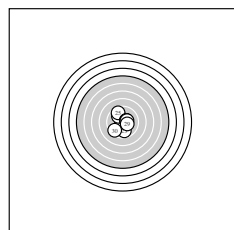

Serie 3:
 10.6 * 10.8 * 9.8 ↓ 10.0 ↘ 9.6 ↘
 10.4 * 10.4 * 10.3 * 10.3 * 9.5 ↙
 beste Teiler 40.4 (22.) 81.9 (21.) 135.0 (26.)
 Trefferlage 0.05 mm rechts, 0.11 mm hoch
 Streuwert 1.65, horizontal: 1.46, vertikal: 1.83

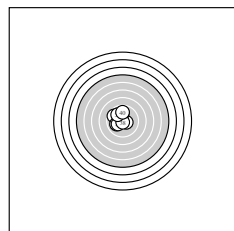

Serie 4:
 9.6 ↘ 10.5 * 10.1 ↙ 10.2 * 10.4 *
 10.0 ↑ 10.2 * 10.8 * 9.9 ↘ 9.8 ↑
 beste Teiler 39.1 (38.) 112.4 (32.) 127.1 (35.)
 Trefferlage 0.81 mm links, 0.89 mm hoch
 Streuwert 1.34, horizontal: 1.20, vertikal: 1.47

Unterschrift des Schützen

Meyton Elektronik

Ergebnis: **414.1** (399)
 Serien: 104.3 102.9 102.9 104.0
 Zähler: 39 1 0 0 0 0 0 0 0 0
 Innenzehner: 29
 weiteste: 266 (1), 247 (16), 238 (29)
 beste Teiler 35.0 (14.) 51.3 (2.) 62.0 (3.)
 Trefferlage 0.18 mm rechts, 0.21 mm hoch
 Streuwert 1.15, horizontal: 1.27, vertikal: 1.02

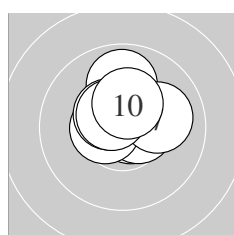
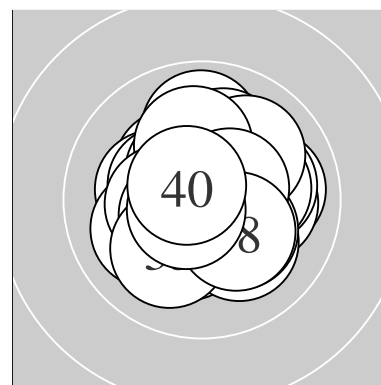

Serie 1:
 9.9 ↑ 10.7 * 10.7 * 10.6 * 10.6 *
 10.5 * 10.0 → 10.5 * 10.5 * 10.3 *
 beste Teiler 51.3 (2.) 62.0 (3.) 94.3 (4.)
 Trefferlage 0.02 mm links, 0.64 mm hoch
 Streuwert 0.96, horizontal: 1.04, vertikal: 0.87

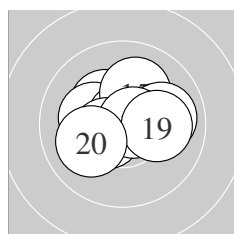

Serie 2:
 10.2 * 10.3 * 10.2 * 10.8 * 10.1 ↗
 10.0 → 10.5 * 10.7 * 10.1 → 10.0 ↖
 beste Teiler 35.0 (14.) 67.7 (18.) 116.4 (17.)
 Trefferlage 0.20 mm rechts, 0.32 mm hoch
 Streuwert 1.31, horizontal: 1.64, vertikal: 0.86

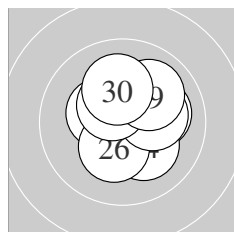

Serie 3:
 10.6 * 10.5 * 10.1 → 10.2 * 10.4 *
 10.3 * 10.2 * 10.5 * 10.0 ↗ 10.1 ↑
 beste Teiler 97.8 (21.) 115.0 (22.) 125.7 (28.)
 Trefferlage 0.43 mm rechts, 0.47 mm hoch
 Streuwert 1.22, horizontal: 1.28, vertikal: 1.17

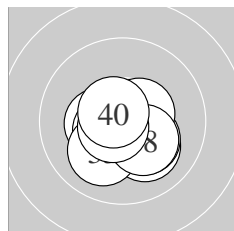

Serie 4:
 10.1 ↘ 10.2 * 10.4 * 10.5 * 10.1 ↖
 10.6 * 10.5 * 10.3 * 10.7 * 10.6 *
 beste Teiler 70.4 (39.) 79.9 (40.) 98.1 (36.)
 Trefferlage 0.13 mm rechts, 0.58 mm tief
 Streuwert 1.02, horizontal: 1.18, vertikal: 0.83

Unterschrift des Schützen

Meyton Elektronik

Ergebnis: **410.6** (396)
 Serien: 102.4 103.7 101.9 102.6
 Zähler: 36 4 0 0 0 0 0 0 0 0
 Innenzehner: 30
 weiteste: 388 (35), 371 (29), 312 (16)
 beste Teiler 25.2 (36.) 31.2 (19.) 49.1 (11.)
 Trefferlage 0.09 mm rechts, 0.19 mm hoch
 Streuwert 1.35, horizontal: 1.57, vertikal: 1.08

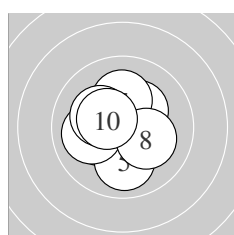
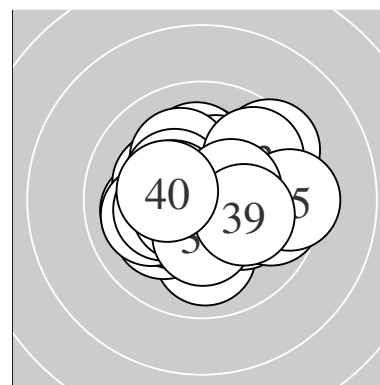

Serie 1:
 10.3 * 10.3 * 10.5 * 10.3 * 10.0 ↓
 10.0 ← 10.2 * 10.2 * 10.2 * 10.4 *
 beste Teiler 121.4 (3.) 131.0 (10.) 156.0 (1.)
 Trefferlage 0.42 mm links, 0.01 mm tief
 Streuwert 1.33, horizontal: 1.41, vertikal: 1.25

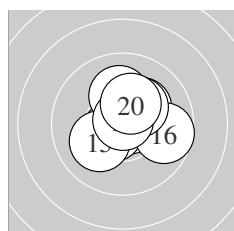

Serie 2:
 10.8 * 10.8 * 10.2 * 10.6 * 10.1 ↙
 9.7 → 10.1 ↑ 10.3 * 10.8 * 10.3 *
 beste Teiler 31.2 (19.) 49.1 (11.) 49.4 (12.)
 Trefferlage 0.38 mm rechts, 0.44 mm hoch
 Streuwert 1.19, horizontal: 1.29, vertikal: 1.07

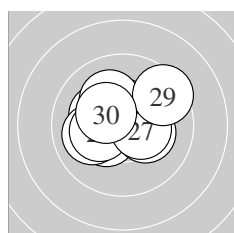

Serie 3:
 10.4 * 10.2 * 10.0 ← 10.2 * 10.3 *
 10.5 * 10.4 * 10.1 ↘ 9.5 ↗ 10.3 *
 beste Teiler 119.0 (26.) 138.8 (27.) 144.5 (21.)
 Trefferlage 0.29 mm links, 0.41 mm hoch
 Streuwert 1.46, horizontal: 1.74, vertikal: 1.11

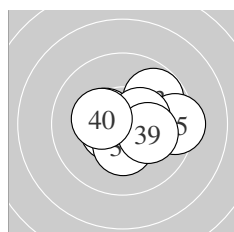

Serie 4:
 10.4 * 10.6 * 9.8 ↗ 10.3 * 9.4 →
 10.9 * 10.3 * 10.4 * 10.2 * 10.3 *
 beste Teiler 25.2 (36.) 98.4 (32.) 135.0 (31.)
 Trefferlage 0.72 mm rechts, 0.04 mm tief
 Streuwert 1.39, horizontal: 1.74, vertikal: 0.91

Unterschrift des Schützen

Meyton Elektronik

Ergebnis: **413.3** (397)
 Serien: 103.8 103.4 102.4 103.7
 Zähler: 37 3 0 0 0 0 0 0 0 0
 Innenzehner: 33
 weiteste: 310 (26), 289 (31), 273 (39)
 beste Teiler 37.1 (34.) 61.0 (4.) 69.5 (36.)
 Trefferlage 0.07 mm rechts, 0.23 mm hoch
 Streuwert 1.17, horizontal: 1.20, vertikal: 1.14

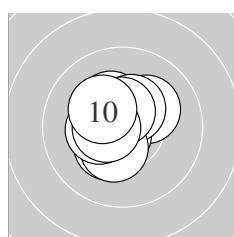
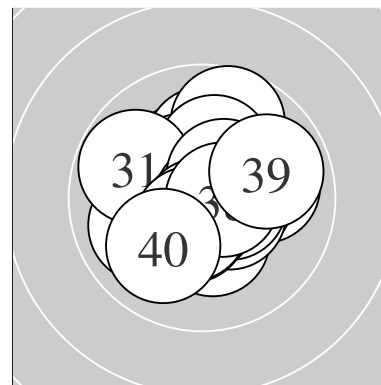

Serie 1:
 10.3 * 10.2 * 10.3 * 10.7 * 10.4 *
 10.4 * 10.5 * 10.3 * 10.5 * 10.2 *
 beste Teiler 61.0 (4.) 104.4 (7.) 106.1 (9.)
 Trefferlage 0.45 mm links, 0.27 mm hoch
 Streuwert 1.00, horizontal: 0.93, vertikal: 1.06

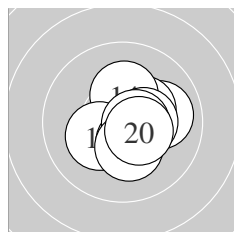

Serie 2:
 10.4 * 10.0 → 10.4 * 10.2 * 10.2 *
 10.4 * 10.4 * 10.6 * 10.3 * 10.5 *
 beste Teiler 86.8 (18.) 121.2 (20.) 138.0 (17.)
 Trefferlage 0.53 mm rechts, 0.23 mm tief
 Streuwert 1.10, horizontal: 1.16, vertikal: 1.04

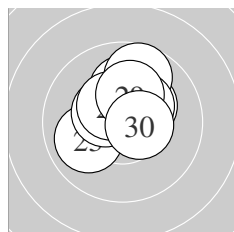

Serie 3:
 10.3 * 10.5 * 10.0 ↙ 10.4 * 10.1 ↑
 9.7 ↑ 10.4 * 10.3 * 10.2 * 10.5 *
 beste Teiler 109.4 (22.) 111.6 (30.) 128.0 (24.)
 Trefferlage 0.18 mm rechts, 1.01 mm hoch
 Streuwert 1.17, horizontal: 1.19, vertikal: 1.14

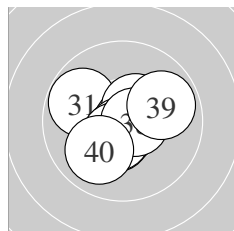

Serie 4:
 9.8 ↖ 10.4 * 10.5 * 10.8 * 10.5 *
 10.7 * 10.5 * 10.6 * 9.9 → 10.0 ↙
 beste Teiler 37.1 (34.) 69.5 (36.) 80.3 (38.)
 Trefferlage 0.04 mm rechts, 0.10 mm tief
 Streuwert 1.26, horizontal: 1.44, vertikal: 1.05

Unterschrift des Schützen

Meyton Elektronik

Ergebnis: **415.2** (397)
 Serien: 103.4 103.1 104.3 104.4
 Zähler: 37 3 0 0 0 0 0 0 0 0
 Innenzehner: 33
 weiteste: 337 (10), 279 (16), 276 (31)
 beste Teiler 14.4 (7.) 44.3 (39.) 46.0 (33.)
 Trefferlage 0.26 mm links, 0.05 mm tief
 Streuwert 1.14, horizontal: 1.19, vertikal: 1.09

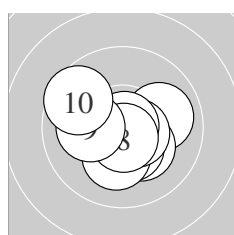
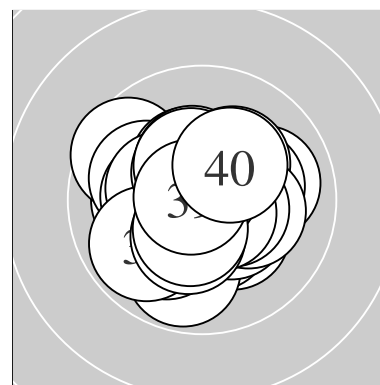

Serie 1:
 10.0 → 10.3 * 10.6 * 10.4 * 10.2 *
 10.6 * 10.9 * 10.7 * 10.1 ← 9.6 ↖
 beste Teiler 14.4 (7.) 69.3 (8.) 90.3 (6.)
 Trefferlage 0.07 mm links, 0.38 mm tief
 Streuwert 1.31, horizontal: 1.53, vertikal: 1.06

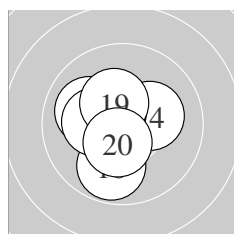

Serie 2:
 10.2 * 10.4 * 10.7 * 10.2 * 10.6 *
 9.8 ↓ 10.0 ↖ 10.3 * 10.4 * 10.5 *
 beste Teiler 61.8 (13.) 99.7 (15.) 123.4 (20.)
 Trefferlage 0.77 mm links, 0.09 mm hoch
 Streuwert 1.16, horizontal: 1.12, vertikal: 1.19

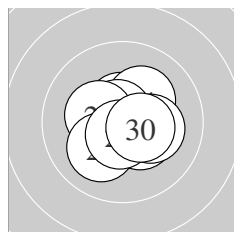

Serie 3:
 10.6 * 10.7 * 10.4 * 10.2 * 10.7 *
 10.3 * 10.1 ↗ 10.2 * 10.6 * 10.5 *
 beste Teiler 61.0 (25.) 62.4 (22.) 82.9 (29.)
 Trefferlage 0.12 mm rechts, 0.03 mm tief
 Streuwert 1.05, horizontal: 1.15, vertikal: 0.94

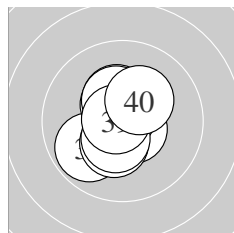

Serie 4:
 9.8 ↙ 10.6 * 10.8 * 10.4 * 10.5 *
 10.3 * 10.5 * 10.4 * 10.8 * 10.3 *
 beste Teiler 44.3 (39.) 46.0 (33.) 83.4 (32.)
 Trefferlage 0.32 mm links, 0.10 mm hoch
 Streuwert 1.06, horizontal: 0.86, vertikal: 1.22

Unterschrift des Schützen

Meyton Elektronik

Ergebnis: **409.5** (393)
 Serien: 101.9 102.8 102.2 102.6
 Zähler: 33 7 0 0 0 0 0 0 0 0
 Innenzehner: 25
 weiteste: 440 (26), 430 (23), 299 (18)
 beste Teiler 12.5 (11.) 41.1 (28.) 49.0 (27.)
 Trefferlage 0.17 mm links, 0.35 mm hoch
 Streuwert 1.41, horizontal: 1.49, vertikal: 1.32

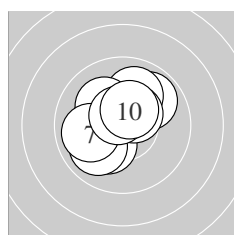
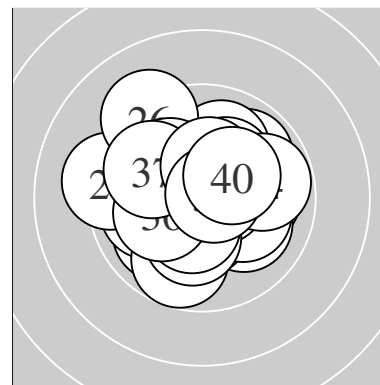

Serie 1:
 10.2 * 10.0 ↙ 9.9 ↗ 10.0 ↗ 10.3 *
 10.1 ↘ 9.9 ← 10.5 * 10.6 * 10.4 *
 beste Teiler 82.7 (9.) 123.0 (8.) 129.8 (10.)
 Trefferlage 0.46 mm links, 0.51 mm hoch
 Streuwert 1.40, horizontal: 1.46, vertikal: 1.35

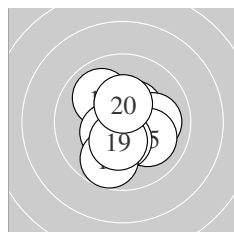

Serie 2:
 10.9 * 10.0 ↘ 10.4 * 10.0 → 10.1 ↘
 10.4 * 10.4 * 9.8 ↓ 10.4 * 10.4 *
 beste Teiler 12.5 (11.) 128.2 (13.) 130.2 (17.)
 Trefferlage 0.11 mm rechts, 0.34 mm tief
 Streuwert 1.37, horizontal: 1.27, vertikal: 1.46

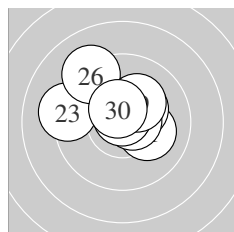

Serie 3:
 10.1 ↘ 10.3 * 9.2 ← 10.6 * 10.5 *
 9.2 ↘ 10.8 * 10.8 * 10.2 * 10.5 *
 beste Teiler 41.1 (28.) 49.0 (27.) 77.5 (24.)
 Trefferlage 0.21 mm links, 0.93 mm hoch
 Streuwert 1.53, horizontal: 1.84, vertikal: 1.14

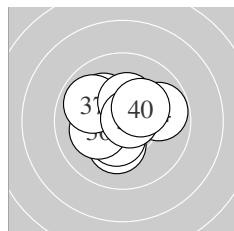

Serie 4:
 10.2 * 10.1 ↘ 10.4 * 9.8 → 10.7 *
 10.2 * 9.9 ↘ 10.3 * 10.7 * 10.3 *
 beste Teiler 57.8 (39.) 58.6 (35.) 131.3 (33.)
 Trefferlage 0.13 mm links, 0.30 mm hoch
 Streuwert 1.36, horizontal: 1.53, vertikal: 1.17

Unterschrift des Schützen

Meyton Elektronik

Ergebnis: **396.0** (378)
 Serien: 97.4 100.8 97.1 100.7
 Zähler: 21 17 1 1 0 0 0 0 0 0
 Innenzehner: 7
 weiteste: 763 (1), 607 (29), 476 (22)
 beste Teiler 68.3 (14.) 79.8 (19.) 83.5 (31.)
 Trefferlage 0.25 mm links, 0.03 mm tief
 Streuwert 2.10, horizontal: 2.51, vertikal: 1.58

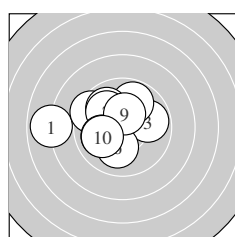
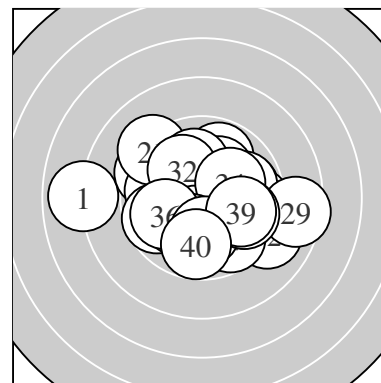

Serie 1:
 7.9 ← 9.5 ↖ 9.8 → 9.8 ↗ 9.9 ↘
 10.1 ↓ 10.0 ↘ 10.0 ← 10.4 * 10.0 ←
 beste Teiler 143.5 (9.) 219.0 (6.) 236.2 (7.)
 Trefferlage 1.53 mm links, 0.59 mm hoch
 Streuwert 2.25, horizontal: 2.79, vertikal: 1.54

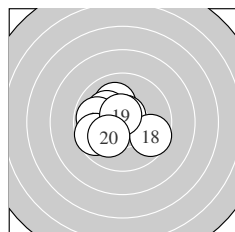

Serie 2:
 9.9 ← 10.1 ← 10.1 ↖ 10.7 * 10.1 ↘
 9.9 ← 9.7 ← 9.6 ↘ 10.6 * 10.1 ↙
 beste Teiler 68.3 (14.) 79.8 (19.) 204.1 (15.)
 Trefferlage 1.12 mm links, 0.09 mm hoch
 Streuwert 1.52, horizontal: 1.79, vertikal: 1.19

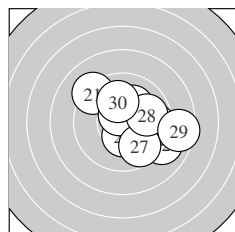

Serie 3:
 9.2 ↘ 9.0 ↘ 10.4 * 10.1 ↗ 10.6 *
 9.6 → 9.7 ↘ 9.9 → 8.5 → 10.1 ↑
 beste Teiler 86.8 (25.) 147.0 (23.) 201.1 (24.)
 Trefferlage 1.51 mm rechts, 0.10 mm hoch
 Streuwert 2.33, horizontal: 2.67, vertikal: 1.92

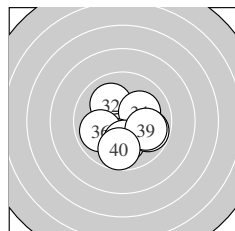

Serie 4:
 10.6 * 10.1 ↘ 10.3 * 10.1 ↗ 10.1 ↓
 9.9 ← 10.1 ↓ 9.8 ↘ 9.9 → 9.8 ↓
 beste Teiler 83.5 (31.) 152.4 (33.) 205.3 (34.)
 Trefferlage 0.14 mm rechts, 0.93 mm tief
 Streuwert 1.55, horizontal: 1.67, vertikal: 1.43

Unterschrift des Schützen

Meyton Elektronik

Ergebnis: **409.1** (392)
 Serien: 101.3 103.6 101.8 102.4
 Zähler: 32 8 0 0 0 0 0 0 0 0
 Innenzehner: 26
 weiteste: 450 (5), 430 (14), 374 (23)
 beste Teiler 30.0 (19.) 40.3 (17.) 50.0 (31.)
 Trefferlage 0.04 mm links, 0.41 mm hoch
 Streuwert 1.47, horizontal: 1.71, vertikal: 1.20

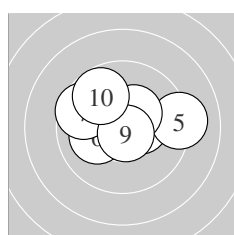
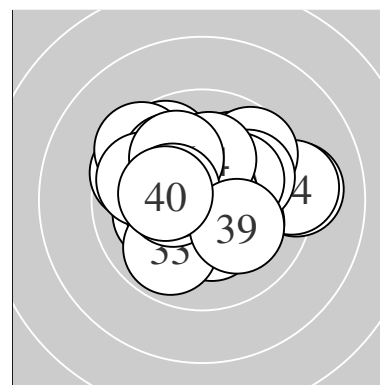

Serie 1:
 10.4 * 10.3 * 10.4 * 10.4 * 9.2 →
 10.1 ← 9.6 ↖ 10.4 * 10.7 * 9.8 ↘
 beste Teiler 55.0 (9.) 127.6 (3.) 136.5 (1.)
 Trefferlage 0.22 mm links, 0.79 mm hoch
 Streuwert 1.65, horizontal: 2.13, vertikal: 0.94

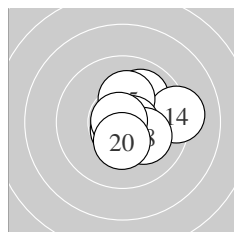

Serie 2:
 10.7 * 10.6 * 10.0 ↗ 9.2 → 10.2 *
 10.7 * 10.8 * 10.2 * 10.8 * 10.4 *
 beste Teiler 30.0 (19.) 40.3 (17.) 70.2 (11.)
 Trefferlage 0.84 mm rechts, 0.01 mm hoch
 Streuwert 1.27, horizontal: 1.38, vertikal: 1.14

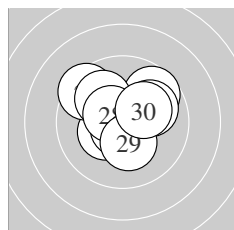

Serie 3:
 10.3 * 10.6 * 9.5 ↘ 9.7 ↗ 10.0 →
 10.0 ↘ 10.7 * 10.5 * 10.3 * 10.2 *
 beste Teiler 58.5 (27.) 93.6 (22.) 110.4 (28.)
 Trefferlage 0.00 mm, 0.70 mm hoch
 Streuwert 1.53, horizontal: 1.72, vertikal: 1.31

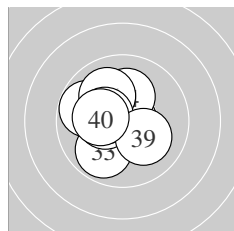

Serie 4:
 10.8 * 10.6 * 9.9 ↙ 10.2 * 9.8 ↖
 10.0 ↘ 10.4 * 10.4 * 10.1 ↘ 10.2 *
 beste Teiler 50.0 (31.) 89.0 (32.) 137.0 (37.)
 Trefferlage 0.79 mm links, 0.13 mm hoch
 Streuwert 1.32, horizontal: 1.30, vertikal: 1.33

Unterschrift des Schützen

Meyton Elektronik

Ergebnis: **396.6** (376)
 Serien: 99.2 97.4 102.3 97.7
 Zähler: 18 20 2 0 0 0 0 0 0 0
 Innenzehner: 14
 weiteste: 578 (4), 521 (15), 490 (36)
 beste Teiler 19.2 (10.) 26.5 (26.) 45.2 (21.)
 Trefferlage 0.09 mm rechts, 0.07 mm hoch
 Streuwert 2.12, horizontal: 2.53, vertikal: 1.61

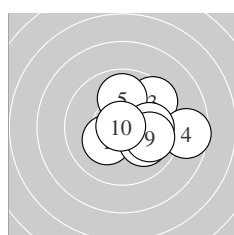
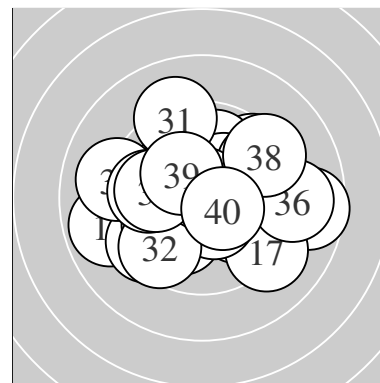

Serie 1:
 10.2 * 9.9 ↗ 9.5 ↗ 8.6 → 9.9 ↑
 10.3 * 10.0 → 10.0 ↘ 9.9 → 10.9 *
 beste Teiler 19.2 (10.) 164.7 (6.) 181.9 (1.)
 Trefferlage 1.76 mm rechts, 0.14 mm hoch
 Streuwert 1.71, horizontal: 1.98, vertikal: 1.39

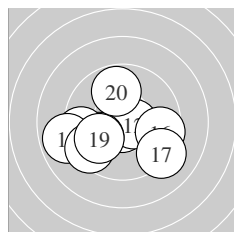

Serie 2:
 10.8 * 10.6 * 9.9 ↙ 9.4 ← 8.9 ←
 9.5 → 9.2 ↘ 9.4 ↙ 9.9 ↙ 9.8 ↑
 beste Teiler 50.1 (11.) 99.4 (12.) 252.7 (13.)
 Trefferlage 0.87 mm links, 0.91 mm tief
 Streuwert 2.30, horizontal: 2.88, vertikal: 1.53

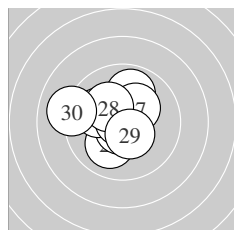

Serie 3:
 10.8 * 10.1 ↙ 10.7 * 9.9 ↑ 10.0 ↘
 10.8 * 10.3 * 10.2 * 10.4 * 9.1 ←
 beste Teiler 26.5 (26.) 45.2 (21.) 71.1 (23.)
 Trefferlage 0.72 mm links, 0.30 mm hoch
 Streuwert 1.54, horizontal: 1.70, vertikal: 1.35

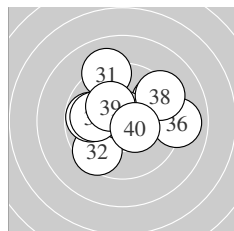

Serie 4:
 9.1 ↑ 9.6 ↙ 9.5 ↗ 10.8 * 9.8 ←
 9.0 → 9.9 ← 9.3 ↗ 10.3 * 10.4 *
 beste Teiler 50.1 (34.) 126.1 (40.) 172.5 (39.)
 Trefferlage 0.22 mm rechts, 0.76 mm hoch
 Streuwert 2.36, horizontal: 2.77, vertikal: 1.86

Unterschrift des Schützen

Meyton Elektronik

Ergebnis: **405.7** (389)
 Serien: 98.1 101.6 102.4 103.6
 Zähler: 30 9 1 0 0 0 0 0 0
 Innenzehner: 21
 weiteste: 631 (4), 445 (3), 416 (17)
 beste Teiler 14.0 (19.) 42.0 (32.) 56.8 (35.)
 Trefferlage 0.46 mm rechts, 0.34 mm tief
 Streuwert 1.65, horizontal: 1.88, vertikal: 1.38

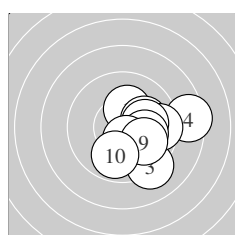
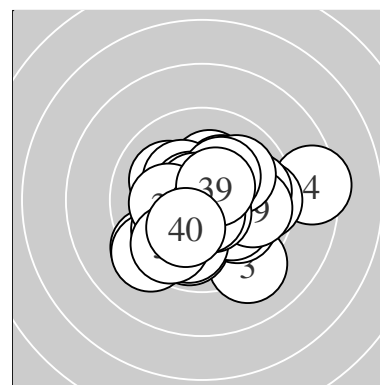

Serie 1:
 10.2 * 10.1 → 9.2 ↘ 8.4 → 9.6 →
 10.1 → 10.1 → 10.5 * 10.0 ↘ 9.9 ↓
 beste Teiler 118.9 (8.) 178.2 (1.) 215.3 (6.)
 Trefferlage 2.06 mm rechts, 0.56 mm tief
 Streuwert 1.79, horizontal: 1.92, vertikal: 1.65

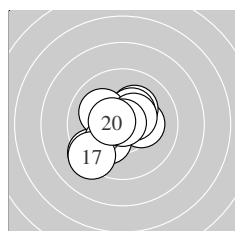

Serie 2:
 9.4 ↙ 10.2 * 10.2 * 10.4 * 10.1 ↘
 10.1 ↙ 9.3 ↙ 10.5 * 10.9 * 10.5 *
 beste Teiler 14.0 (19.) 104.0 (20.) 123.1 (18.)
 Trefferlage 0.54 mm links, 0.23 mm tief
 Streuwert 1.67, horizontal: 1.74, vertikal: 1.61

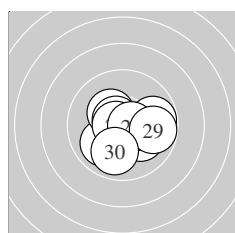

Serie 3:
 10.0 ↙ 10.3 * 10.6 * 10.1 ↘ 9.8 →
 10.6 * 10.7 * 10.6 * 9.8 → 9.9 ↓
 beste Teiler 64.0 (27.) 81.2 (23.) 82.0 (28.)
 Trefferlage 0.41 mm rechts, 0.39 mm tief
 Streuwert 1.41, horizontal: 1.66, vertikal: 1.10

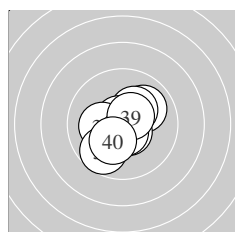

Serie 4:
 10.0 ↗ 10.8 * 10.3 * 10.6 * 10.7 *
 10.2 * 10.6 * 9.7 ↙ 10.5 * 10.2 *
 beste Teiler 42.0 (32.) 56.8 (35.) 80.7 (37.)
 Trefferlage 0.08 mm links, 0.16 mm tief
 Streuwert 1.25, horizontal: 1.25, vertikal: 1.26

Unterschrift des Schützen

Meyton Elektronik

Ergebnis: **414.5** (397)
 Serien: 104.0 103.7 103.4 103.4
 Zähler: 37 3 0 0 0 0 0 0 0 0
 Innenzehner: 30
 weiteste: 292 (2), 287 (19), 258 (26)
 beste Teiler 38.1 (7.) 66.9 (3.) 71.0 (9.)
 Trefferlage 0.03 mm rechts, 0.09 mm hoch
 Streuwert 1.15, horizontal: 1.23, vertikal: 1.07

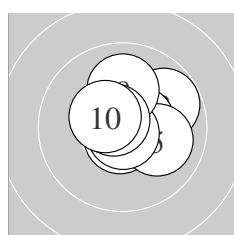
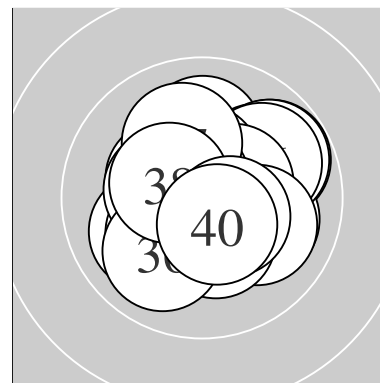

Serie 1:
 10.5 * 9.8 ↗ 10.7 * 10.5 * 10.0 ↘
 10.6 * 10.8 * 10.0 ↑ 10.7 * 10.4 *
 beste Teiler 38.1 (7.) 66.9 (3.) 71.0 (9.)
 Trefferlage 0.33 mm rechts, 0.50 mm hoch
 Streuwert 1.08, horizontal: 1.19, vertikal: 0.96

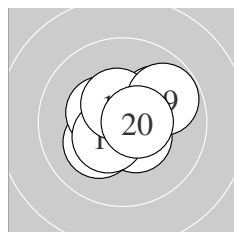

Serie 2:
 10.6 * 10.5 * 10.7 * 10.2 * 10.0 ↗
 10.4 * 10.4 * 10.5 * 9.8 ↗ 10.6 *
 beste Teiler 75.3 (13.) 82.9 (11.) 91.0 (20.)
 Trefferlage 0.08 mm rechts, 0.08 mm hoch
 Streuwert 1.21, horizontal: 1.40, vertikal: 0.98

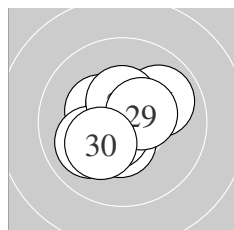

Serie 3:
 10.5 * 10.3 * 10.6 * 10.6 * 10.5 *
 9.9 ↗ 10.0 ↖ 10.4 * 10.4 * 10.2 *
 beste Teiler 83.0 (24.) 88.7 (23.) 108.0 (25.)
 Trefferlage 0.21 mm links, 0.12 mm hoch
 Streuwert 1.17, horizontal: 1.24, vertikal: 1.10

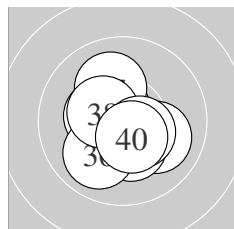

Serie 4:
 10.4 * 10.0 ↘ 10.6 * 10.3 * 10.6 *
 10.0 ↙ 10.1 ↑ 10.4 * 10.5 * 10.5 *
 beste Teiler 76.2 (33.) 94.1 (35.) 113.7 (40.)
 Trefferlage 0.05 mm links, 0.33 mm tief
 Streuwert 1.20, horizontal: 1.19, vertikal: 1.20

Unterschrift des Schützen

Meyton Elektronik

Ergebnis: **415.0** (394)
 Serien: 102.4 103.8 106.1 102.7
 Zähler: 34 6 0 0 0 0 0 0 0 0
 Innenzehner: 31
 weiteste: 440 (18), 419 (6), 344 (34)
 beste Teiler 21.2 (22.) 24.6 (21.) 33.6 (39.)
 Trefferlage 0.09 mm rechts, 0.24 mm hoch
 Streuwert 1.27, horizontal: 1.33, vertikal: 1.20

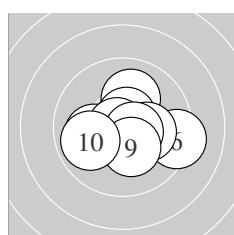
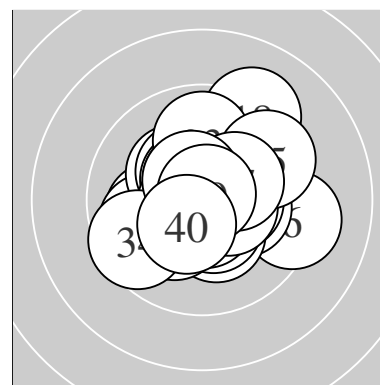

Serie 1:
 10.1 ↑ 10.1 ← 10.6 * 10.8 * 10.5 *
 9.3 → 10.2 * 10.6 * 10.3 * 9.9 ←
 beste Teiler 43.0 (4.) 83.5 (3.) 90.6 (8.)
 Trefferlage 0.35 mm rechts, 0.26 mm tief
 Streuwert 1.52, horizontal: 1.87, vertikal: 1.06

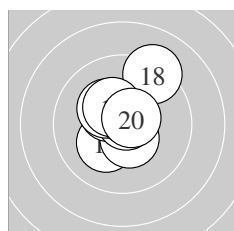

Serie 2:
 10.8 * 10.2 * 10.5 * 10.4 * 10.8 *
 10.3 * 10.6 * 9.2 ↑ 10.4 * 10.6 *
 beste Teiler 36.7 (11.) 38.8 (15.) 80.2 (17.)
 Trefferlage 0.04 mm links, 0.58 mm hoch
 Streuwert 1.28, horizontal: 1.09, vertikal: 1.45

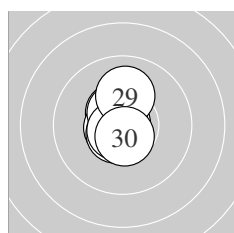

Serie 3:
 10.9 * 10.9 * 10.5 * 10.6 * 10.7 *
 10.5 * 10.6 * 10.7 * 10.1 ↑ 10.6 *
 beste Teiler 21.2 (22.) 24.6 (21.) 61.6 (28.)
 Trefferlage 0.30 mm links, 0.27 mm hoch
 Streuwert 0.70, horizontal: 0.31, vertikal: 0.94

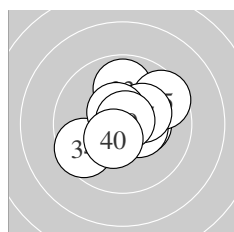

Serie 4:
 10.4 * 10.5 * 9.9 ↑ 9.6 ← 9.6 ↗
 10.7 * 10.3 * 10.5 * 10.8 * 10.4 *
 beste Teiler 33.6 (39.) 69.4 (36.) 101.5 (38.)
 Trefferlage 0.35 mm rechts, 0.38 mm hoch
 Streuwert 1.45, horizontal: 1.58, vertikal: 1.32

Unterschrift des Schützen

Meyton Elektronik

Ergebnis: **408.4** (391)
 Serien: 102.1 103.5 101.5 101.3
 Zähler: 31 9 0 0 0 0 0 0 0 0
 Innenzehner: 24
 weiteste: 447 (32), 350 (30), 345 (40)
 beste Teiler 25.0 (27.) 66.6 (37.) 68.0 (8.)
 Trefferlage 0.34 mm rechts, 0.24 mm tief
 Streuwert 1.45, horizontal: 1.53, vertikal: 1.37

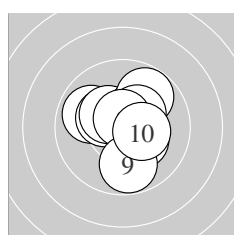
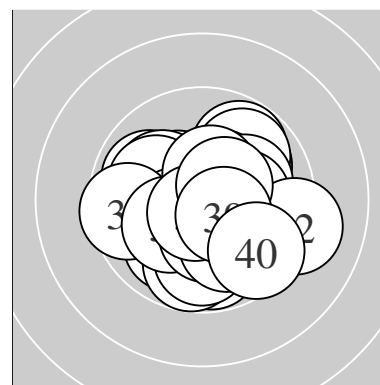

Serie 1:
 9.9 ↙ 10.3 * 10.4 * 10.3 * 9.8 ↗
 10.3 * 10.3 * 10.7 * 9.8 ↓ 10.3 *
 beste Teiler 68.0 (8.) 148.8 (3.) 151.6 (10.)
 Trefferlage 0.20 mm rechts, 0.38 mm hoch
 Streuwert 1.43, horizontal: 1.42, vertikal: 1.45

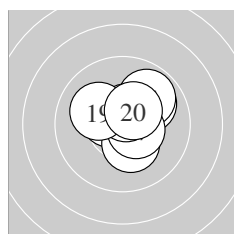

Serie 2:
 10.7 * 10.5 * 10.0 ↗ 9.9 ↗ 10.5 *
 10.3 * 10.5 * 10.6 * 10.1 ↙ 10.4 *
 beste Teiler 72.2 (11.) 92.0 (18.) 110.0 (12.)
 Trefferlage 0.50 mm rechts, 0.38 mm hoch
 Streuwert 1.15, horizontal: 1.17, vertikal: 1.13

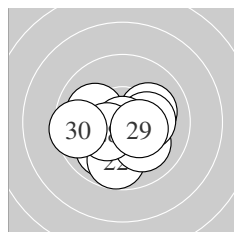

Serie 3:
 10.0 ↗ 9.8 ↓ 10.0 ↙ 10.1 ↘ 10.1 →
 10.2 * 10.9 * 10.4 * 10.4 * 9.6 ←
 beste Teiler 25.0 (27.) 138.7 (29.) 141.5 (28.)
 Trefferlage 0.20 mm links, 0.69 mm tief
 Streuwert 1.56, horizontal: 1.86, vertikal: 1.20

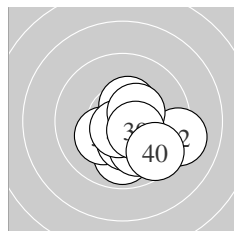

Serie 4:
 9.9 ↓ 9.2 → 10.2 * 10.4 * 10.3 *
 10.0 ↘ 10.7 * 10.5 * 10.5 * 9.6 ↘
 beste Teiler 66.6 (37.) 123.4 (39.) 124.2 (38.)
 Trefferlage 0.88 mm rechts, 1.04 mm tief
 Streuwert 1.44, horizontal: 1.60, vertikal: 1.25

Unterschrift des Schützen

Meyton Elektronik

Ergebnis: **414.4** (396)
 Serien: 103.8 103.3 105.2 102.1
 Zähler: 36 4 0 0 0 0 0 0 0 0
 Innenzehner: 32
 weiteste: 343 (33), 299 (14), 271 (34)
 beste Teiler 39.6 (25.) 40.7 (6.) 52.0 (9.)
 Trefferlage 0.06 mm rechts, 0.11 mm hoch
 Streuwert 1.17, horizontal: 1.28, vertikal: 1.03

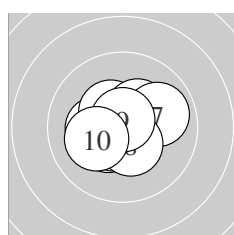
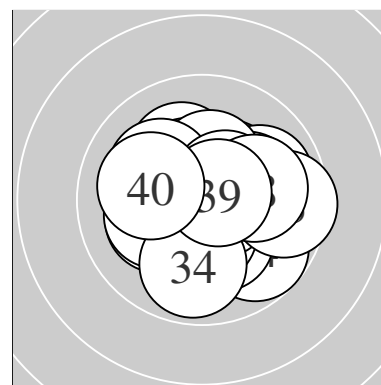

Serie 1:
 10.2 * 10.4 * 10.4 * 10.5 * 10.3 *
 10.8 * 9.9 → 10.4 * 10.7 * 10.2 *
 beste Teiler 40.7 (6.) 52.0 (9.) 103.8 (4.)
 Trefferlage 0.19 mm links, 0.02 mm hoch
 Streuwert 1.12, horizontal: 1.31, vertikal: 0.89

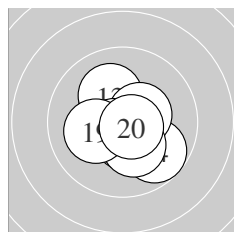

Serie 2:
 10.5 * 10.3 * 10.1 ↖ 9.8 ↘ 10.5 *
 10.4 * 10.6 * 10.2 * 10.2 * 10.7 *
 beste Teiler 69.3 (20.) 84.1 (17.) 114.4 (11.)
 Trefferlage 0.20 mm rechts, 0.20 mm tief
 Streuwert 1.25, horizontal: 1.22, vertikal: 1.27

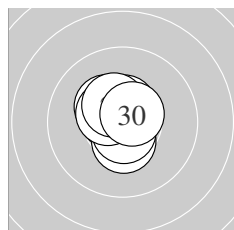

Serie 3:
 10.6 * 10.4 * 10.4 * 10.3 * 10.8 *
 10.5 * 10.7 * 10.5 * 10.4 * 10.6 *
 beste Teiler 39.6 (25.) 65.6 (27.) 87.2 (30.)
 Trefferlage 0.33 mm links, 0.42 mm hoch
 Streuwert 0.73, horizontal: 0.64, vertikal: 0.82

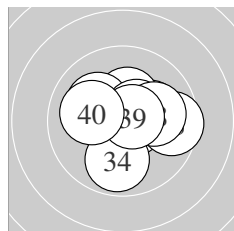

Serie 4:
 10.6 * 10.2 * 9.6 → 9.9 ↓ 10.3 *
 10.1 ↖ 10.5 * 10.1 → 10.7 * 10.1 ←
 beste Teiler 73.4 (39.) 76.9 (31.) 117.8 (37.)
 Trefferlage 0.59 mm rechts, 0.23 mm hoch
 Streuwert 1.46, horizontal: 1.71, vertikal: 1.15

Unterschrift des Schützen

Ergebnis: **411.3** (394)
 Serien: 102.8 102.1 103.9 102.5
 Zähler: 34 6 0 0 0 0 0 0 0 0
 Innenzehner: 30
 weiteste: 362 (31), 344 (17), 294 (37)
 beste Teiler 14.7 (22.) 38.0 (3.) 72.1 (21.)
 Trefferlage 0.10 mm links, 0.04 mm tief
 Streuwert 1.31, horizontal: 1.40, vertikal: 1.20

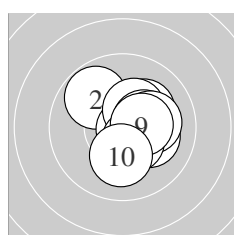
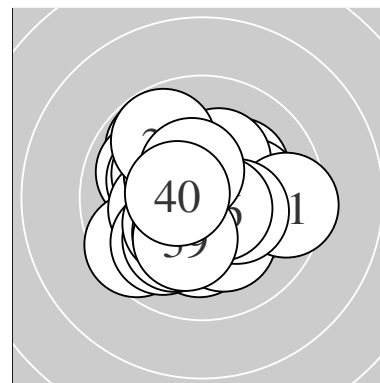

Serie 1:
 10.2 * 9.8 ↘ 10.8 * 10.2 * 10.4 *
 10.3 * 10.1 → 10.5 * 10.4 * 10.1 ↓
 beste Teiler 38.0 (3.) 123.4 (8.) 138.1 (9.)
 Trefferlage 0.81 mm rechts, 0.17 mm hoch
 Streuwert 1.18, horizontal: 1.17, vertikal: 1.20

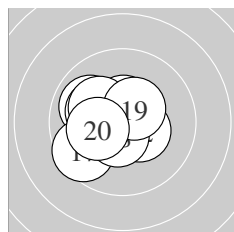

Serie 2:
 9.9 ↖ 10.4 * 10.3 * 10.1 ↖ 10.5 *
 10.2 * 9.6 ↙ 10.5 * 10.4 * 10.2 *
 beste Teiler 102.1 (18.) 111.1 (15.) 126.9 (19.)
 Trefferlage 1.02 mm links, 0.03 mm hoch
 Streuwert 1.24, horizontal: 1.37, vertikal: 1.10

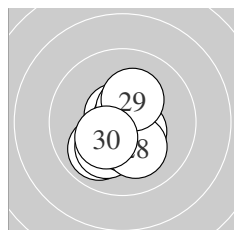

Serie 3:
 10.7 * 10.9 * 9.9 ↙ 10.1 ↙ 10.6 *
 10.4 * 10.5 * 10.2 * 10.3 * 10.3 *
 beste Teiler 14.7 (22.) 72.1 (21.) 93.6 (25.)
 Trefferlage 0.15 mm links, 0.53 mm tief
 Streuwert 1.10, horizontal: 0.94, vertikal: 1.25

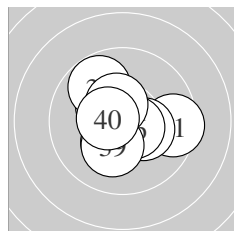

Serie 4:
 9.5 → 10.4 * 10.3 * 10.3 * 10.4 *
 10.6 * 9.8 ↘ 10.5 * 10.2 * 10.5 *
 beste Teiler 89.1 (36.) 107.6 (40.) 125.9 (38.)
 Trefferlage 0.06 mm links, 0.13 mm hoch
 Streuwert 1.45, horizontal: 1.59, vertikal: 1.30

Unterschrift des Schützen

Meyton Elektronik

Ergebnis: **414.8** (399)
 Serien: 104.3 103.5 103.0 104.0
 Zähler: 39 1 0 0 0 0 0 0 0 0
 Innenzehner: 34
 weiteste: 407 (39), 235 (12), 234 (8)
 beste Teiler 26.1 (4.) 27.3 (37.) 45.3 (40.)
 Trefferlage 0.17 mm links, 0.09 mm hoch
 Streuwert 1.15, horizontal: 1.27, vertikal: 1.02

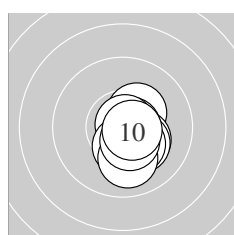
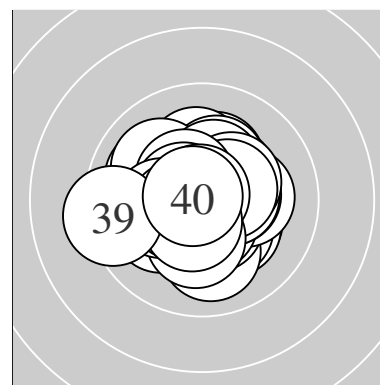

Serie 1:
 10.4 * 10.3 * 10.7 * 10.8 * 10.2 *
 10.4 * 10.3 * 10.0 ↓ 10.5 * 10.7 *
 beste Teiler 26.1 (4.) 61.0 (3.) 74.6 (10.)
 Trefferlage 0.71 mm rechts, 0.71 mm tief
 Streuwert 0.76, horizontal: 0.47, vertikal: 0.97

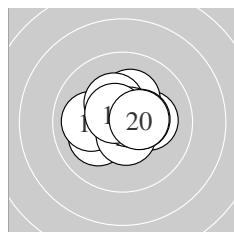

Serie 2:
 10.1 ↙ 10.0 ← 10.2 * 10.5 * 10.2 *
 10.3 * 10.4 * 10.7 * 10.6 * 10.5 *
 beste Teiler 65.2 (18.) 88.5 (19.) 102.3 (14.)
 Trefferlage 0.04 mm rechts, 0.27 mm hoch
 Streuwert 1.16, horizontal: 1.39, vertikal: 0.88

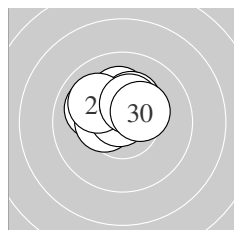

Serie 3:
 10.0 ↘ 10.2 * 10.4 * 10.3 * 10.2 *
 10.4 * 10.8 * 10.0 ↖ 10.4 * 10.3 *
 beste Teiler 47.5 (27.) 131.2 (23.) 135.0 (26.)
 Trefferlage 0.60 mm links, 1.00 mm hoch
 Streuwert 0.93, horizontal: 1.17, vertikal: 0.60

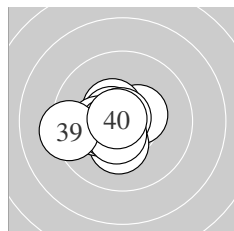

Serie 4:
 10.5 * 10.5 * 10.6 * 10.3 * 10.2 *
 10.5 * 10.8 * 10.5 * 9.3 ← 10.8 *
 beste Teiler 27.3 (37.) 45.3 (40.) 89.6 (33.)
 Trefferlage 0.86 mm links, 0.20 mm tief
 Streuwert 1.10, horizontal: 1.34, vertikal: 0.79

Unterschrift des Schützen

Meyton Elektronik

Ergebnis: **412.5** (393)
 Serien: 103.9 103.0 104.0 101.6
 Zähler: 33 7 0 0 0 0 0 0 0 0
 Innenzehner: 29
 weiteste: 324 (31), 320 (20), 317 (27)
 beste Teiler 43.0 (25.) 48.1 (4.) 68.1 (11.)
 Trefferlage 0.18 mm links, 0.30 mm hoch
 Streuwert 1.26, horizontal: 1.36, vertikal: 1.14

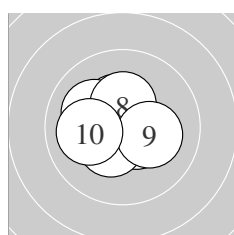
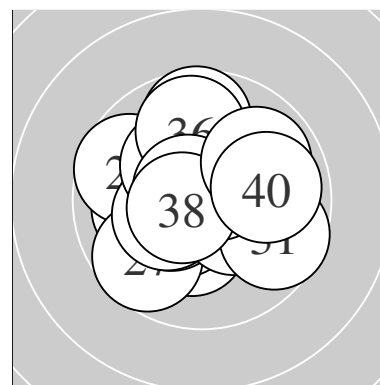

Serie 1:
 10.6 * 10.4 * 10.5 * 10.8 * 10.1 ↘
 10.5 * 10.4 * 10.4 * 10.2 * 10.0 ←
 beste Teiler 48.1 (4.) 94.8 (1.) 110.6 (6.)
 Trefferlage 0.49 mm links, 0.00 mm
 Streuwert 1.08, horizontal: 1.22, vertikal: 0.91

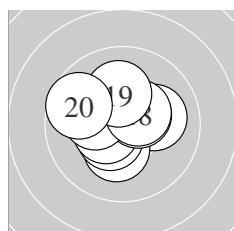

Serie 2:
 10.7 * 10.1 → 10.3 * 10.5 * 10.5 *
 10.5 * 10.2 * 10.4 * 10.1 ↑ 9.7 ↘
 beste Teiler 68.1 (11.) 119.9 (15.) 121.6 (14.)
 Trefferlage 0.32 mm links, 0.33 mm hoch
 Streuwert 1.29, horizontal: 1.49, vertikal: 1.07

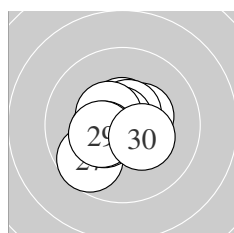

Serie 3:
 10.4 * 10.6 * 10.4 * 10.6 * 10.8 *
 10.5 * 9.7 ↙ 10.4 * 10.3 * 10.3 *
 beste Teiler 43.0 (25.) 90.8 (24.) 97.1 (22.)
 Trefferlage 0.44 mm links, 0.12 mm tief
 Streuwert 1.09, horizontal: 1.17, vertikal: 1.01

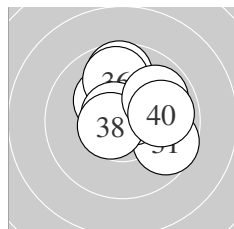

Serie 4:
 9.7 ↘ 10.6 * 9.7 ↑ 10.5 * 10.2 *
 9.8 ↑ 10.7 * 10.6 * 9.9 ↗ 9.9 →
 beste Teiler 69.6 (37.) 86.9 (32.) 87.0 (38.)
 Trefferlage 0.51 mm rechts, 0.99 mm hoch
 Streuwert 1.43, horizontal: 1.50, vertikal: 1.36

Unterschrift des Schützen

Meyton Elektronik