

Ergebnis: **413.2** (395)^{QF}
 Serien: 102.4 103.5 103.8 103.5
 Zaehler: 35 5 0 0 0 0 0 0 0 0
 Innenzehner: 32
 weiteste: 376 (36), 354 (30), 337 (6)
 beste Teiler 53.4 (35.) 57.0 (29.) 65.8 (7.)
 Trefferlage 0.16 mm links, 0.18 mm hoch
 Streuwert 1.22, horizontal: 1.48, vertikal: 0.90

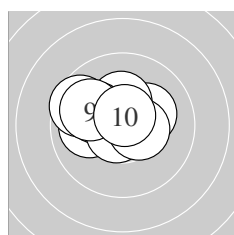

Serie 1:
 10.2 * 10.3 * 10.4 * 10.0 ← 10.1 ↖
 9.6 ↖ 10.7 * 10.5 * 9.9 ↖ 10.7 *
 beste Teiler 65.8 (7.) 71.5 (10.) 121.5 (8.)
 Trefferlage 0.84 mm links, 0.62 mm hoch
 Streuwert 1.24, horizontal: 1.60, vertikal: 0.72

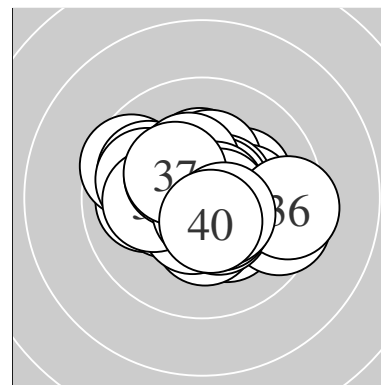
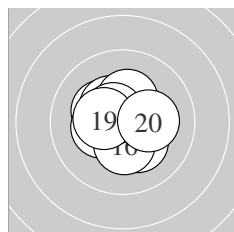

Serie 2:
 10.3 * 10.2 * 10.5 * 10.4 * 10.3 *
 10.3 * 10.3 * 10.6 * 10.4 * 10.2 *
 beste Teiler 92.0 (18.) 106.0 (13.) 138.4 (19.)
 Trefferlage 0.30 mm links, 0.20 mm hoch
 Streuwert 1.10, horizontal: 1.15, vertikal: 1.05

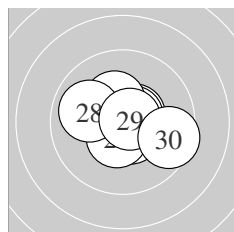

Serie 3:
 10.6 * 10.6 * 10.5 * 10.6 * 10.6 *
 10.3 * 10.5 * 9.9 ← 10.7 * 9.5 →
 beste Teiler 57.0 (29.) 81.4 (24.) 96.7 (22.)
 Trefferlage 0.17 mm rechts, 0.21 mm hoch
 Streuwert 1.22, horizontal: 1.47, vertikal: 0.90

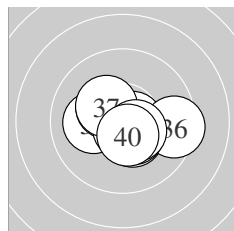

Serie 4:
 10.1 ← 10.4 * 10.4 * 10.7 * 10.7 *
 9.4 → 10.3 * 10.5 * 10.5 * 10.5 *
 beste Teiler 53.4 (35.) 71.5 (34.) 108.8 (40.)
 Trefferlage 0.29 mm rechts, 0.28 mm tief
 Streuwert 1.25, horizontal: 1.60, vertikal: 0.77

QF – Schütze hat sich fürs Finale qualifiziert

Unterschrift des Schuetzen

Meyton Elektronik

Ergebnis: **407.7** (391)
 Serien: 104.1 99.7 100.6 103.3
 Zaehler: 31 9 0 0 0 0 0 0 0 0
 Innenzehner: 24
 weiteste: 398 (22), 375 (11), 345 (30)
 beste Teiler 37.0 (3.) 55.9 (4.) 60.4 (35.)
 Trefferlage 0.08 mm links, 0.12 mm hoch
 Streuwert 1.50, horizontal: 1.44, vertikal: 1.56

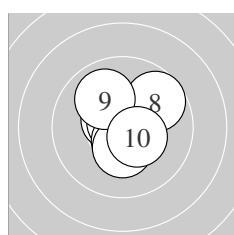
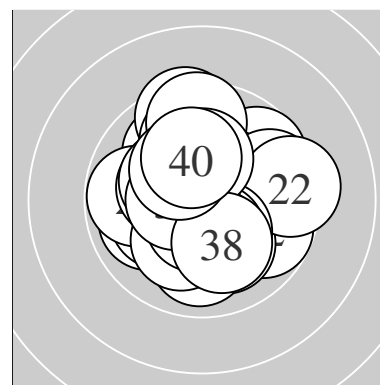

Serie 1:
 10.6 * 10.4 * 10.8 * 10.7 * 10.7 *
 10.5 * 10.3 * 9.7 ↗ 10.0 ↖ 10.4 *
 beste Teiler 37.0 (3.) 55.9 (4.) 68.6 (5.)
 Trefferlage 0.25 mm rechts, 0.15 mm hoch
 Streuwert 1.15, horizontal: 1.09, vertikal: 1.20

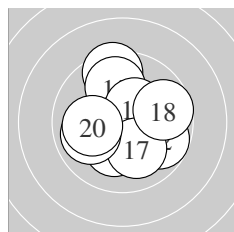

Serie 2:
 9.5 ↑ 9.8 ↘ 10.2 * 10.2 * 9.9 ↑
 10.4 * 10.1 ↓ 9.7 → 9.9 ← 10.0 ←
 beste Teiler 137.6 (16.) 188.4 (14.) 190.0 (13.)
 Trefferlage 0.08 mm rechts, 0.39 mm hoch
 Streuwert 1.89, horizontal: 1.84, vertikal: 1.93

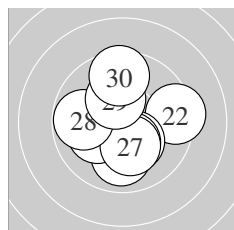

Serie 3:
 10.0 ↓ 9.4 → 10.3 * 10.7 * 10.1 ←
 10.3 * 10.2 * 9.8 ← 10.2 * 9.6 ↑
 beste Teiler 69.8 (24.) 160.8 (26.) 166.2 (23.)
 Trefferlage 0.02 mm links, 0.24 mm tief
 Streuwert 1.80, horizontal: 1.81, vertikal: 1.80

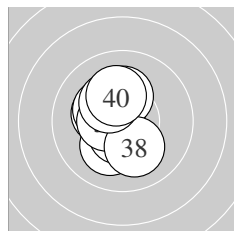

Serie 4:
 10.3 * 10.1 ↙ 10.3 * 10.6 * 10.7 *
 10.5 * 10.2 * 10.1 ↓ 10.3 * 10.2 *
 beste Teiler 60.4 (35.) 100.2 (34.) 117.0 (36.)
 Trefferlage 0.66 mm links, 0.20 mm hoch
 Streuwert 1.11, horizontal: 0.75, vertikal: 1.38

Unterschrift des Schuetzen

Meyton Elektronik

Ergebnis: **402.8** (387)
 Serien: 102.7 99.9 101.8 98.4
 Zaehler: 27 13 0 0 0 0 0 0 0 0
 Innenzehner: 20
 weiteste: 457 (18), 457 (40), 440 (36)
 beste Teiler 27.7 (21.) 31.0 (9.) 38.0 (5.)
 Trefferlage 0.11 mm rechts, 0.03 mm tief
 Streuwert 1.82, horizontal: 2.14, vertikal: 1.44

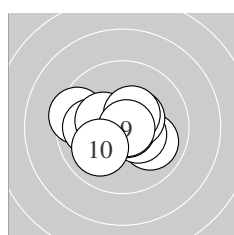
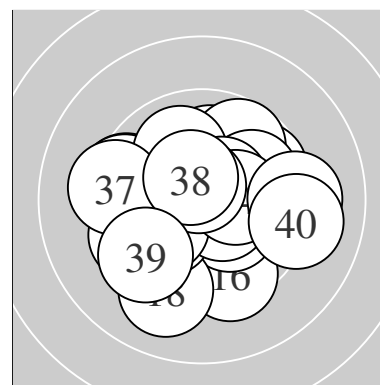

Serie 1:
 9.5 ← 10.0 → 10.0 ← 10.4 * 10.8 *
 10.3 * 10.4 * 10.5 * 10.8 * 10.0 ↙
 beste Teiler 31.0 (9.) 38.0 (5.) 124.0 (8.)
 Trefferlage 0.35 mm links, 0.04 mm tief
 Streuwert 1.46, horizontal: 1.87, vertikal: 0.87

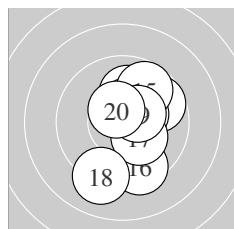

Serie 2:
 9.7 ↗ 10.0 ↑ 10.4 * 10.3 * 9.7 ↗
 9.5 ↓ 10.3 * 9.1 ↓ 10.4 * 10.5 *
 beste Teiler 110.4 (20.) 136.0 (19.) 143.5 (13.)
 Trefferlage 0.84 mm rechts, 0.09 mm hoch
 Streuwert 1.86, horizontal: 1.24, vertikal: 2.32

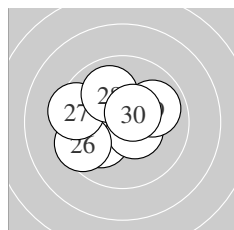

Serie 3:
 10.8 * 10.8 * 10.2 * 10.1 ↙ 10.5 *
 9.5 ↙ 9.5 ← 10.0 ↘ 9.9 ↗ 10.5 *
 beste Teiler 27.7 (21.) 40.3 (22.) 109.7 (30.)
 Trefferlage 0.64 mm links, 0.02 mm tief
 Streuwert 1.60, horizontal: 1.90, vertikal: 1.22

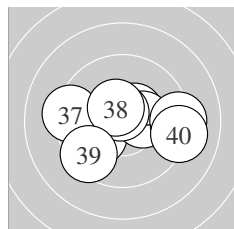

Serie 4:
 10.1 ↙ 10.5 * 9.2 → 10.3 * 10.7 *
 9.2 → 9.3 ← 10.5 * 9.5 ↙ 9.1 →
 beste Teiler 68.8 (35.) 118.9 (38.) 119.4 (32.)
 Trefferlage 0.62 mm rechts, 0.18 mm tief
 Streuwert 2.32, horizontal: 3.07, vertikal: 1.13

Unterschrift des Schuetzen

Meyton Elektronik

Ergebnis: **411.5** (391)
 Serien: 102.4 104.4 103.5 101.2
 Zaehler: 31 9 0 0 0 0 0 0 0 0
 Innenzehner: 31
 weiteste: 412 (29), 398 (37), 330 (40)
 beste Teiler 55.8 (35.) 59.8 (16.) 60.0 (11.)
 Trefferlage 0.36 mm links, 0.51 mm tief
 Streuwert 1.29, horizontal: 1.60, vertikal: 0.88

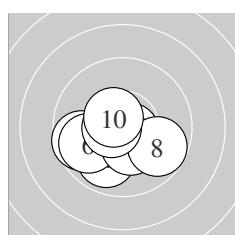
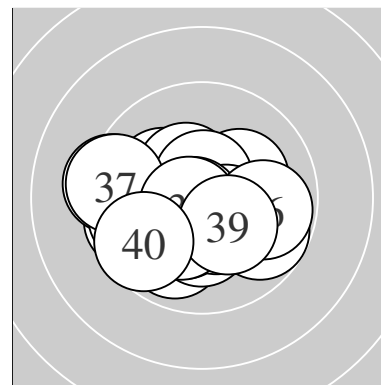

Serie 1:
 9.6 ← 10.5 * 10.6 * 9.9 ✓ 10.7 *
 9.8 ← 10.4 * 9.8 → 10.6 * 10.5 *
 beste Teiler 65.6 (5.) 83.1 (9.) 87.2 (3.)
 Trefferlage 0.45 mm links, 0.88 mm tief
 Streuwert 1.32, horizontal: 1.66, vertikal: 0.84

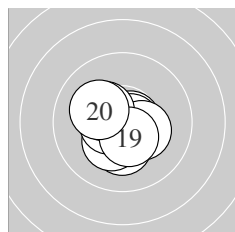

Serie 2:
 10.7 * 10.7 * 10.2 * 10.3 * 10.5 *
 10.7 * 10.3 * 10.3 * 10.5 * 10.2 *
 beste Teiler 59.8 (16.) 60.0 (11.) 60.8 (12.)
 Trefferlage 0.19 mm links, 0.39 mm tief
 Streuwert 0.96, horizontal: 1.01, vertikal: 0.90

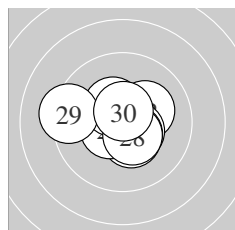

Serie 3:
 10.6 * 10.2 * 10.5 * 10.5 * 10.4 *
 10.5 * 10.4 * 10.5 * 9.3 ← 10.6 *
 beste Teiler 82.2 (30.) 92.6 (21.) 109.1 (26.)
 Trefferlage 0.02 mm links, 0.01 mm tief
 Streuwert 1.32, horizontal: 1.62, vertikal: 0.92

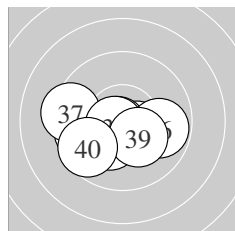

Serie 4:
 9.7 ← 10.3 * 10.4 * 10.3 * 10.7 *
 9.8 → 9.4 ← 10.7 * 10.3 * 9.6 ✓
 beste Teiler 55.8 (35.) 71.0 (38.) 130.9 (33.)
 Trefferlage 0.77 mm links, 0.77 mm tief
 Streuwert 1.54, horizontal: 2.06, vertikal: 0.71

Unterschrift des Schuetzen

Ergebnis:	409.2	(392)
Serien:	101.4	102.4 102.1 103.3
Zaehler:	32	8 0 0 0 0 0 0 0 0
Innenzehner:	25	
weiteste:	411	(2), 366 (13), 334 (6)
beste Teiler	36.0	(17.) 57.9 (20.) 59.9 (22.)
Trefferlage	0.30 mm	rechts, 0.73 mm hoch
Streuwert	1.32,	horizontal: 1.20, vertikal: 1.43

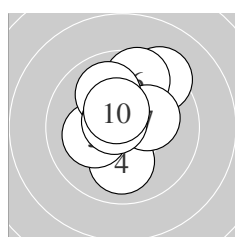
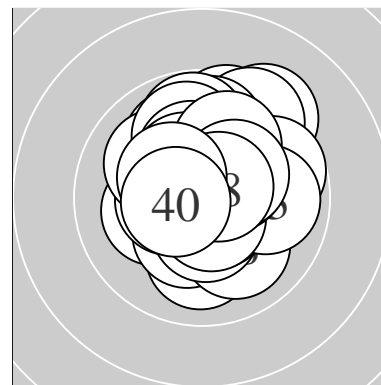

Serie 1:	10.7 *	9.3 ↗	10.2 *	10.0 ↓	10.2 *
	9.6 ↗	10.2 *	10.0 ↘	10.7 *	10.5 *
beste Teiler	61.0	(1.) 68.2 (9.)	119.6 (10.)		
Trefferlage	0.04 mm	rechts, 0.93 mm	hoch		
Streuwert	1.56,	horizontal: 1.31, vertikal: 1.77			

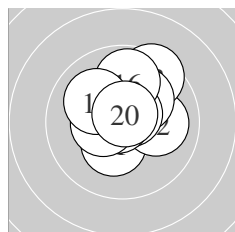

Serie 2:	10.3 *	10.0 →	9.5 ↗	10.2 *	10.7 *
	9.8 ↑	10.8 *	10.4 *	10.0 ↘	10.7 *
beste Teiler	36.0	(17.) 57.9 (20.)	73.7 (15.)		
Trefferlage	0.24 mm	rechts, 0.84 mm	hoch		
Streuwert	1.35,	horizontal: 1.33, vertikal: 1.38			

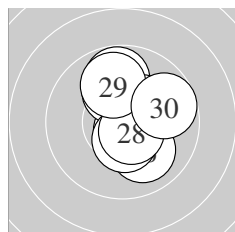

Serie 3:	10.5 *	10.7 *	10.1 ↑	9.8 ↑	10.3 *
	10.0 ↘	10.5 *	10.6 *	9.9 ↑	9.7 →
beste Teiler	59.9	(22.) 87.7 (28.)	102.9 (21.)		
Trefferlage	0.55 mm	rechts, 0.44 mm	hoch		
Streuwert	1.41,	horizontal: 1.07, vertikal: 1.69			

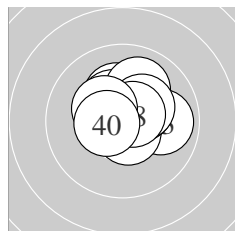

Serie 4:	10.2 *	10.4 *	9.9 →	10.6 *	10.0 ↗
	10.4 *	10.3 *	10.6 *	10.4 *	10.5 *
beste Teiler	82.0	(38.) 84.9 (34.)	109.1 (40.)		
Trefferlage	0.38 mm	rechts, 0.72 mm	hoch		
Streuwert	1.07,	horizontal: 1.23, vertikal: 0.88			

Unterschrift des Schuetzen

Meyton Elektronik

Ergebnis: **409.7** (390)
 Serien: 100.7 103.6 103.4 102.0
 Zaehler: 30 10 0 0 0 0 0 0 0 0
 Innenzehner: 25
 weiteste: 389 (32), 374 (3), 361 (8)
 beste Teiler 31.0 (9.) 49.2 (27.) 56.5 (28.)
 Trefferlage 0.30 mm rechts, 0.71 mm hoch
 Streuwert 1.33, horizontal: 1.31, vertikal: 1.36

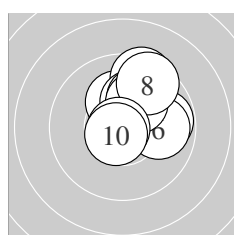
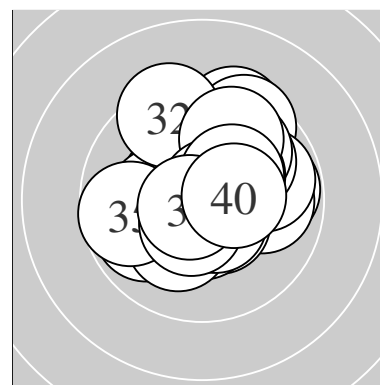

Serie 1:
 10.2 * 9.8 → 9.5 ↗ 10.2 * 10.0 ↗
 9.9 → 10.1 ↗ 9.5 ↗ 10.8 * 10.7 *
 beste Teiler 31.0 (9.) 68.6 (10.) 184.8 (1.)
 Trefferlage 1.01 mm rechts, 1.39 mm hoch
 Streuwert 1.29, horizontal: 1.18, vertikal: 1.38

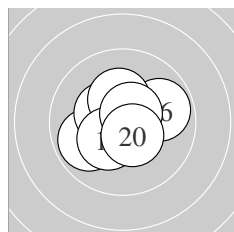

Serie 2:
 10.5 * 10.7 * 9.9 ↙ 10.4 * 10.6 *
 9.8 → 10.3 * 10.3 * 10.6 * 10.5 *
 beste Teiler 74.8 (12.) 80.5 (15.) 85.5 (19.)
 Trefferlage 0.04 mm links, 0.26 mm hoch
 Streuwert 1.21, horizontal: 1.36, vertikal: 1.03

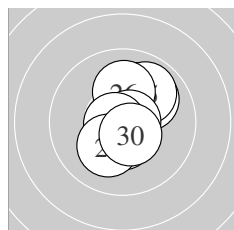

Serie 3:
 10.5 * 10.1 ↗ 10.6 * 10.0 ↗ 9.9 ↗
 10.1 ↑ 10.8 * 10.7 * 10.2 * 10.5 *
 beste Teiler 49.2 (27.) 56.5 (28.) 100.4 (23.)
 Trefferlage 0.41 mm rechts, 0.50 mm hoch
 Streuwert 1.20, horizontal: 0.87, vertikal: 1.46

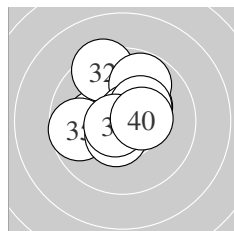

Serie 4:
 10.2 * 9.4 ↘ 10.3 * 9.8 ↗ 9.7 ←
 10.7 * 10.3 * 10.5 * 10.7 * 10.4 *
 beste Teiler 60.3 (36.) 61.9 (39.) 111.8 (38.)
 Trefferlage 0.15 mm links, 0.69 mm hoch
 Streuwert 1.51, horizontal: 1.56, vertikal: 1.45

Unterschrift des Schuetzen

Ergebnis: **410.0** (392)

Serien: 103.7 101.5 104.2 100.6

Zaehler: 32 8 0 0 0 0 0 0 0 0

Innenzehner: 27

weiteste: 408 (35), 334 (34), 304 (2)

beste Teiler 47.1 (3.) 62.6 (1.) 63.8 (28.)

Trefferlage 0.56 mm links, 0.60 mm hoch

Streuwert 1.25, horizontal: 1.25, vertikal: 1.26

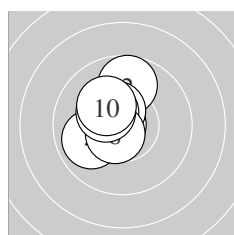
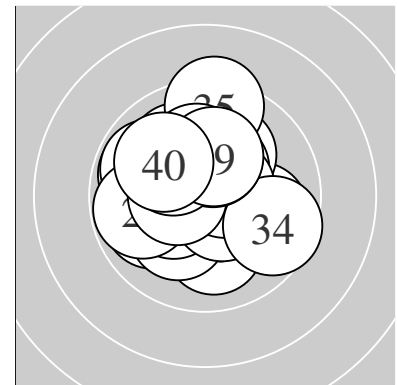

Serie 1:

10.7 *	9.7 ↑	10.8 *	9.9 ↙	10.6 *
10.5 *	10.4 *	10.6 *	10.3 *	10.2 *

beste Teiler 47.1 (3.) 62.6 (1.) 85.7 (8.)

Trefferlage 0.83 mm links, 0.64 mm hoch

Streuwert 0.96, horizontal: 0.71, vertikal: 1.16

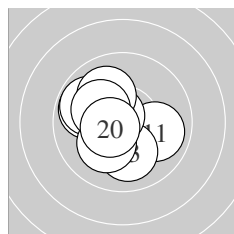

Serie 2:

9.9 ↘	9.8 ↖	10.1 ↓	9.8 ↖	10.2 *
10.7 *	10.3 *	10.0 ↘	10.2 *	10.5 *

beste Teiler 75.2 (16.) 103.0 (20.) 156.9 (17.)

Trefferlage 0.92 mm links, 0.14 mm hoch

Streuwert 1.40, horizontal: 1.47, vertikal: 1.33

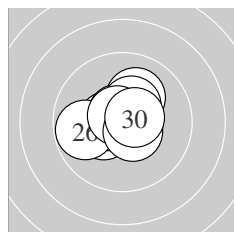

Serie 3:

10.3 *	10.6 *	10.1 ↗	10.5 *	10.7 *
9.8 ↖	10.4 *	10.7 *	10.5 *	10.6 *

beste Teiler 63.8 (28.) 71.8 (25.) 88.1 (22.)

Trefferlage 0.20 mm links, 0.23 mm hoch

Streuwert 1.08, horizontal: 1.27, vertikal: 0.86

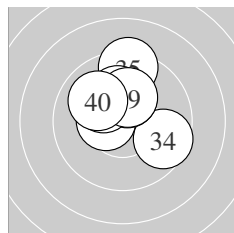

Serie 4:

10.3 *	10.1 ↘	10.5 *	9.6 ↘	9.3 ↑
10.2 *	10.2 *	10.2 *	10.2 *	10.0 ↘

beste Teiler 125.0 (33.) 156.4 (31.) 177.6 (36.)

Trefferlage 0.29 mm links, 1.38 mm hoch

Streuwert 1.41, horizontal: 1.45, vertikal: 1.38

Unterschrift des Schuetzen

Meyton Elektronik

Ergebnis: **386.0** (369)
 Serien: 95.2 94.8 98.7 97.3
 Zaehler: 15 19 6 0 0 0 0 0 0 0
 Innenzehner: 10
 weiteste: 663 (21), 598 (12), 595 (7)
 beste Teiler 89.6 (28.) 97.4 (2.) 107.3 (40.)
 Trefferlage 0.59 mm rechts, 0.42 mm hoch
 Streuwert 2.53, horizontal: 2.71, vertikal: 2.34

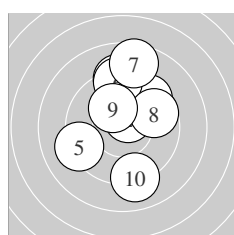
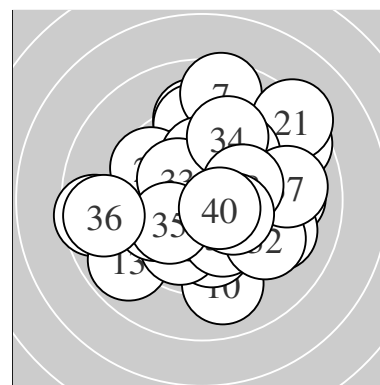

Serie 1:
 9.7 ↗ 10.6 * 9.6 ↗ 9.2 ↑ 9.2 ↖
 9.3 ↑ 8.6 ↑ 9.7 ↗ 10.2 * 9.1 ↓
 beste Teiler 97.4 (2.) 196.3 (9.) 313.0 (1.)
 Trefferlage 0.49 mm rechts, 1.59 mm hoch
 Streuwert 2.62, horizontal: 2.08, vertikal: 3.06

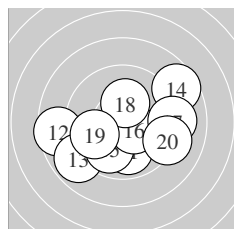

Serie 2:
 9.9 ↓ 8.6 ← 8.9 ↖ 8.6 ↗ 9.9 ↖
 10.5 * 9.1 → 10.3 * 9.8 ↖ 9.2 →
 beste Teiler 123.7 (16.) 175.6 (18.) 262.4 (11.)
 Trefferlage 0.16 mm rechts, 0.76 mm tief
 Streuwert 2.96, horizontal: 3.69, vertikal: 1.98

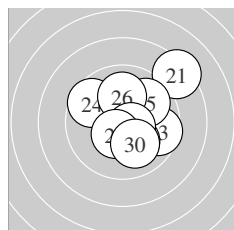

Serie 3:
 8.3 ↗ 10.3 * 9.6 → 9.6 ↖ 9.8 ↖
 10.0 ↑ 10.1 ↘ 10.6 * 10.4 * 10.0 ↓
 beste Teiler 89.6 (28.) 126.4 (29.) 159.6 (22.)
 Trefferlage 0.89 mm rechts, 0.54 mm hoch
 Streuwert 2.15, horizontal: 2.22, vertikal: 2.08

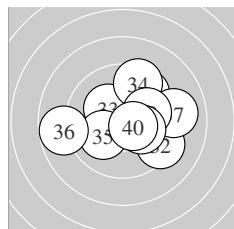

Serie 4:
 9.6 ↗ 9.3 ↘ 10.2 * 9.5 ↑ 10.1 ↖
 8.8 ← 9.1 → 10.0 → 10.2 * 10.5 *
 beste Teiler 107.3 (40.) 176.5 (33.) 188.4 (39.)
 Trefferlage 0.80 mm rechts, 0.31 mm hoch
 Streuwert 2.41, horizontal: 2.92, vertikal: 1.75

Unterschrift des Schuetzen

Meyton Elektronik

Ergebnis: **406.3** (387)
 Serien: 100.3 103.3 101.9 100.8
 Zaehler: 27 13 0 0 0 0 0 0 0 0
 Innenzehner: 20
 weiteste: 438 (1), 350 (32), 348 (12)
 beste Teiler 50.6 (16.) 68.6 (38.) 71.5 (20.)
 Trefferlage 0.18 mm links, 0.05 mm tief
 Streuwert 1.57, horizontal: 1.57, vertikal: 1.58

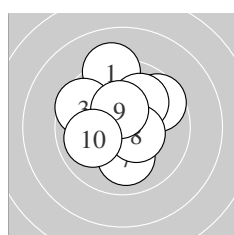
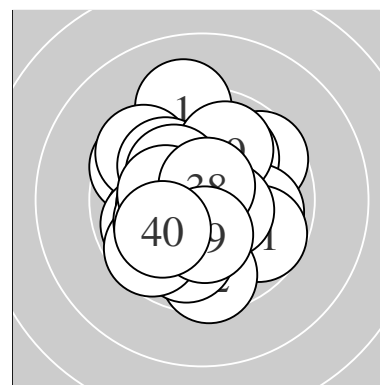

Serie 1:
 9.2 ↑ 10.4 * 9.6 ↘ 9.6 ↗ 10.0 ↗
 10.6 * 10.0 ↓ 10.5 * 10.4 * 10.0 ←
 beste Teiler 87.4 (6.) 116.7 (8.) 134.1 (2.)
 Trefferlage 0.14 mm links, 0.75 mm hoch
 Streuwert 1.80, horizontal: 1.73, vertikal: 1.86

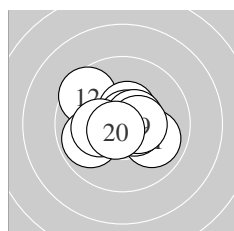

Serie 2:
 9.9 ↘ 9.6 ↘ 10.5 * 10.6 * 9.9 ←
 10.8 * 10.6 * 10.2 * 10.5 * 10.7 *
 beste Teiler 50.6 (16.) 71.5 (20.) 94.8 (14.)
 Trefferlage 0.15 mm links, 0.08 mm hoch
 Streuwert 1.38, horizontal: 1.67, vertikal: 1.00

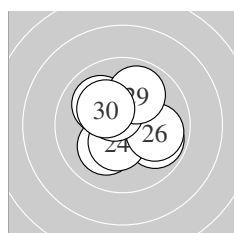

Serie 3:
 10.7 * 10.1 ↗ 9.9 ↘ 10.4 * 10.3 *
 9.9 → 10.5 * 10.0 ↘ 9.9 ↗ 10.2 *
 beste Teiler 72.8 (21.) 117.6 (27.) 136.9 (24.)
 Trefferlage 0.03 mm links, 0.28 mm hoch
 Streuwert 1.47, horizontal: 1.53, vertikal: 1.41

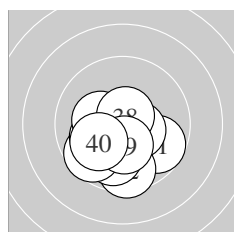

Serie 4:
 9.7 ↘ 9.6 ↓ 9.9 ↓ 10.5 * 9.7 ↗
 10.1 ← 10.3 * 10.7 * 10.3 * 10.0 ←
 beste Teiler 68.6 (38.) 120.5 (34.) 162.5 (39.)
 Trefferlage 0.40 mm links, 1.33 mm tief
 Streuwert 1.43, horizontal: 1.58, vertikal: 1.27

Unterschrift des Schuetzen

Meyton Elektronik

Ergebnis: **406.6** (390)
 Serien: 101.5 101.5 100.3 103.3
 Zaehler: 30 10 0 0 0 0 0 0 0 0
 Innenzehner: 26
 weiteste: 458 (12), 434 (21), 372 (10)
 beste Teiler 67.0 (26.) 74.4 (9.) 75.0 (4.)
 Trefferlage 0.01 mm links, 0.32 mm tief
 Streuwert 1.57, horizontal: 1.75, vertikal: 1.36

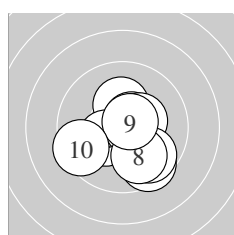
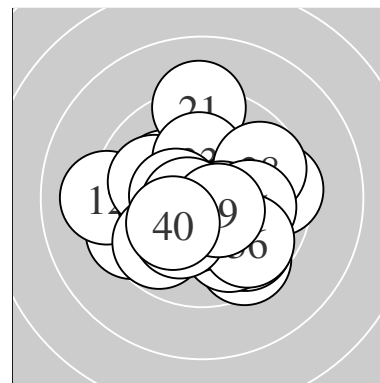

Serie 1:
 10.2 * 10.3 * 10.6 * 10.7 * 10.4 *
 9.5 ↘ 9.7 ↘ 9.9 ↘ 10.7 * 9.5 ←
 beste Teiler 74.4 (9.) 75.0 (4.) 92.4 (3.)
 Trefferlage 0.40 mm rechts, 0.66 mm tief
 Streuwert 1.60, horizontal: 1.66, vertikal: 1.55

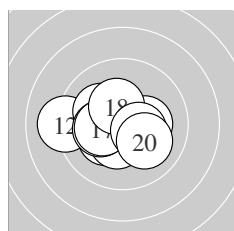

Serie 2:
 10.3 * 9.1 ← 10.4 * 10.1 ↖ 10.2 *
 10.2 * 10.3 * 10.4 * 10.4 * 10.1 ↘
 beste Teiler 137.4 (19.) 141.0 (13.) 149.8 (18.)
 Trefferlage 0.71 mm links, 0.24 mm tief
 Streuwert 1.53, horizontal: 1.96, vertikal: 0.92

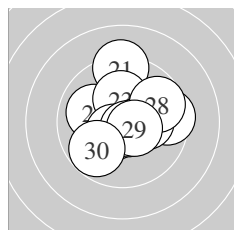

Serie 3:
 9.2 ↑ 10.0 ↖ 10.2 * 10.5 * 9.5 →
 10.7 * 10.2 * 9.7 ↗ 10.5 * 9.8 ↙
 beste Teiler 67.0 (26.) 106.0 (29.) 107.7 (24.)
 Trefferlage 0.42 mm rechts, 0.49 mm hoch
 Streuwert 1.85, horizontal: 1.92, vertikal: 1.78

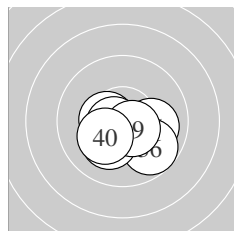

Serie 4:
 10.6 * 10.3 * 10.5 * 10.4 * 10.0 →
 9.8 ↘ 10.2 * 10.7 * 10.6 * 10.2 *
 beste Teiler 75.2 (38.) 92.7 (31.) 97.6 (39.)
 Trefferlage 0.15 mm links, 0.87 mm tief
 Streuwert 1.09, horizontal: 1.39, vertikal: 0.67

Unterschrift des Schuetzen

Meyton Elektronik

Ergebnis: **412.8** (394)^{QF}
 Serien: 103.2 101.9 104.1 103.6
 Zaehler: 34 6 0 0 0 0 0 0 0 0
 Innenzehner: 27
 weiteste: 388 (14), 336 (13), 278 (22)
 beste Teiler 17.0 (30.) 49.0 (33.) 54.4 (12.)
 Trefferlage 0.15 mm rechts, 0.46 mm hoch
 Streuwert 1.24, horizontal: 1.21, vertikal: 1.27

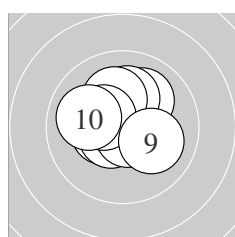
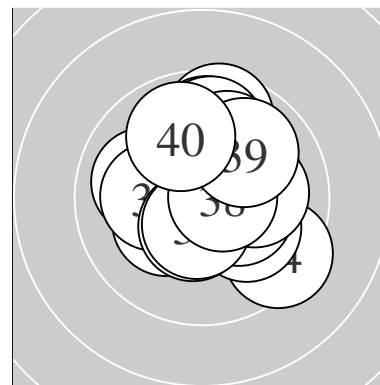

Serie 1:
 10.5 * 10.4 * 10.6 * 10.7 * 10.1 ↗
 10.2 * 10.2 * 10.4 * 10.1 ↘ 10.0 ↖
 beste Teiler 61.8 (4.) 97.4 (3.) 107.0 (1.)
 Trefferlage 0.30 mm links, 0.55 mm hoch
 Streuwert 1.20, horizontal: 1.29, vertikal: 1.11

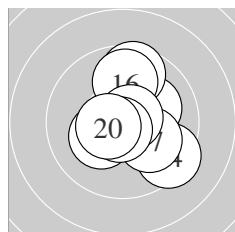

Serie 2:
 10.1 ↗ 10.7 * 9.6 ↑ 9.4 ↘ 10.3 *
 9.8 ↑ 10.1 ↘ 10.7 * 10.7 * 10.5 *
 beste Teiler 54.4 (12.) 54.7 (19.) 61.9 (18.)
 Trefferlage 0.60 mm rechts, 0.23 mm hoch
 Streuwert 1.57, horizontal: 1.38, vertikal: 1.73

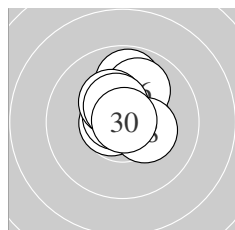

Serie 3:
 10.6 * 9.8 ↑ 10.7 * 10.5 * 10.5 *
 10.0 ↗ 10.3 * 10.3 * 10.5 * 10.9 *
 beste Teiler 17.0 (30.) 62.4 (23.) 76.3 (21.)
 Trefferlage 0.16 mm rechts, 0.83 mm hoch
 Streuwert 0.96, horizontal: 0.84, vertikal: 1.08

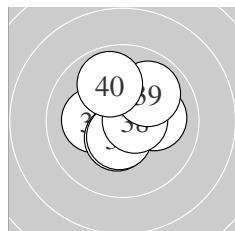

Serie 4:
 10.6 * 10.5 * 10.8 * 10.2 * 10.1 →
 10.5 * 10.5 * 10.6 * 9.9 ↗ 9.9 ↖
 beste Teiler 49.0 (33.) 85.0 (38.) 91.2 (31.)
 Trefferlage 0.14 mm rechts, 0.22 mm hoch
 Streuwert 1.23, horizontal: 1.28, vertikal: 1.17

QF – Schütze hat sich fürs Finale qualifiziert

Unterschrift des Schuetzen

Meyton Elektronik

Ergebnis: **407.0** (390)
 Serien: 101.9 101.4 102.1 101.6
 Zaehler: 30 10 0 0 0 0 0 0 0 0
 Innenzehner: 24
 weiteste: 374 (4), 333 (19), 316 (35)
 beste Teiler 14.2 (38.) 52.0 (39.) 67.4 (9.)
 Trefferlage 0.19 mm links, 0.22 mm hoch
 Streuwert 1.50, horizontal: 1.72, vertikal: 1.23

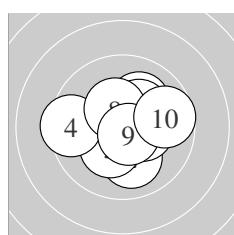
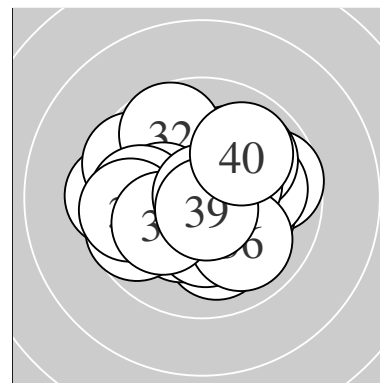

Serie 1:
 10.5 * 10.0 ↓ 10.3 * 9.5 ← 10.4 *
 10.1 ↗ 10.3 * 10.4 * 10.7 * 9.7 →
 beste Teiler 67.4 (9.) 101.6 (1.) 143.9 (8.)
 Trefferlage 0.23 mm rechts, 0.01 mm tief
 Streuwert 1.57, horizontal: 1.81, vertikal: 1.29

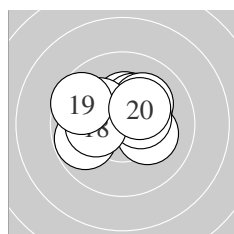

Serie 2:
 10.3 * 9.8 ← 10.3 * 10.1 ↗ 10.2 *
 10.2 * 10.4 * 10.2 * 9.6 ↘ 10.3 *
 beste Teiler 138.8 (17.) 156.6 (11.) 165.1 (13.)
 Trefferlage 0.25 mm links, 0.68 mm hoch
 Streuwert 1.49, horizontal: 1.86, vertikal: 0.98

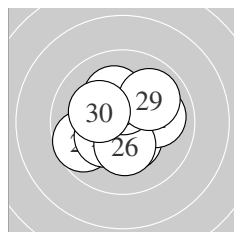

Serie 3:
 10.4 * 10.7 * 9.7 ← 10.0 → 10.3 *
 10.3 * 10.4 * 10.2 * 9.9 ↗ 10.2 *
 beste Teiler 69.6 (22.) 133.2 (27.) 140.8 (21.)
 Trefferlage 0.19 mm links, 0.04 mm hoch
 Streuwert 1.46, horizontal: 1.59, vertikal: 1.33

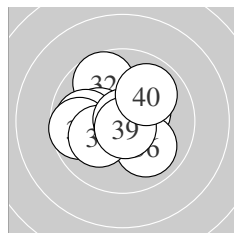

Serie 4:
 10.4 * 9.7 ↘ 10.3 * 9.9 ← 9.7 ←
 10.0 ↓ 10.1 ← 10.9 * 10.7 * 9.9 ↗
 beste Teiler 14.2 (38.) 52.0 (39.) 139.9 (31.)
 Trefferlage 0.56 mm links, 0.17 mm hoch
 Streuwert 1.59, horizontal: 1.79, vertikal: 1.36

Unterschrift des Schuetzen

Ergebnis: **402.8** (383)
 Serien: 101.7 102.1 97.6 101.4
 Zaehler: 24 15 1 0 0 0 0 0 0 0
 Innenzehner: 20
 weiteste: 599 (25), 470 (4), 389 (27)
 beste Teiler 32.6 (15.) 45.5 (2.) 69.1 (10.)
 Trefferlage 0.00 mm , 0.19 mm hoch
 Streuwert 1.79, horizontal: 2.19, vertikal: 1.28

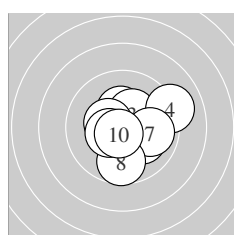
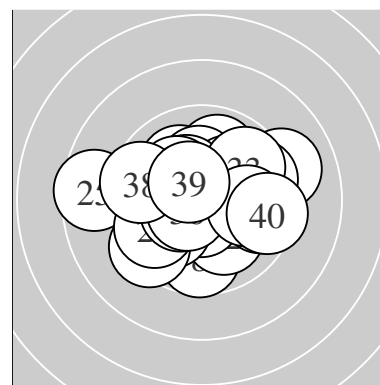

Serie 1:
 10.3 * 10.8 * 10.3 * 9.1 → 10.1 ↘
 10.4 * 9.9 → 9.7 ↓ 10.4 * 10.7 *
 beste Teiler 45.5 (2.) 69.1 (10.) 133.0 (9.)
 Trefferlage 0.64 mm rechts, 0.04 mm tief
 Streuwert 1.64, horizontal: 1.79, vertikal: 1.47

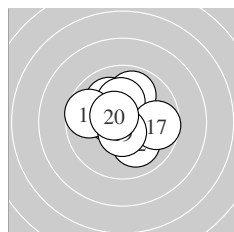

Serie 2:
 9.9 ↗ 10.1 ↘ 10.5 * 10.0 ↖ 10.8 *
 10.2 * 9.7 → 9.7 ← 10.6 * 10.6 *
 beste Teiler 32.6 (15.) 92.0 (19.) 98.4 (20.)
 Trefferlage 0.11 mm links, 0.52 mm hoch
 Streuwert 1.51, horizontal: 1.66, vertikal: 1.34

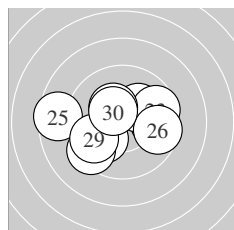

Serie 3:
 9.8 → 10.2 * 9.6 → 10.0 ↙ 8.6 ←
 9.6 → 9.4 ↙ 10.3 * 9.7 ↙ 10.4 *
 beste Teiler 134.7 (30.) 160.6 (28.) 196.0 (22.)
 Trefferlage 0.42 mm links, 0.10 mm tief
 Streuwert 2.38, horizontal: 3.06, vertikal: 1.41

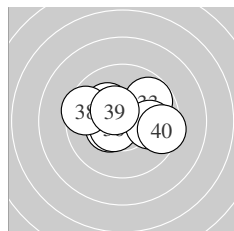

Serie 4:
 10.4 * 10.2 * 9.8 ↗ 10.4 * 10.6 *
 10.6 * 9.9 → 9.5 ← 10.5 * 9.5 →
 beste Teiler 87.0 (35.) 100.6 (36.) 123.0 (39.)
 Trefferlage 0.07 mm links, 0.41 mm hoch
 Streuwert 1.66, horizontal: 2.17, vertikal: 0.91

Unterschrift des Schuetzen

Ergebnis: **402.9** (386)
 Serien: 102.0 99.5 100.0 101.4
 Zaehler: 29 9 1 1 0 0 0 0 0 0
 Innenzehner: 21
 weiteste: 806 (24), 526 (17), 442 (33)
 beste Teiler 58.2 (28.) 74.2 (38.) 76.8 (10.)
 Trefferlage 0.24 mm rechts, 0.15 mm hoch
 Streuwert 1.85, horizontal: 2.06, vertikal: 1.61

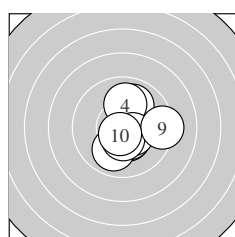
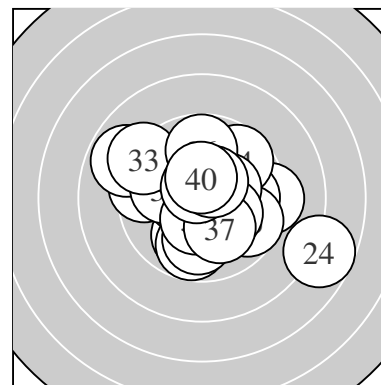

Serie 1:
 10.5 * 10.4 * 10.0 ↗ 10.0 ↑ 10.4 *
 10.4 * 10.0 ↘ 10.4 * 9.3 → 10.6 *
 beste Teiler 76.8 (10.) 101.0 (1.) 126.1 (8.)
 Trefferlage 0.76 mm rechts, 0.25 mm tief
 Streuwert 1.45, horizontal: 1.35, vertikal: 1.54

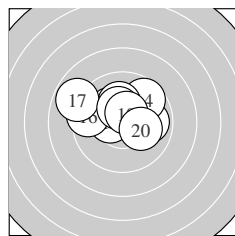

Serie 2:
 9.9 → 10.2 * 10.4 * 9.7 ↗ 10.1 ↑
 9.5 ← 8.8 ↖ 10.3 * 10.5 * 10.1 →
 beste Teiler 104.9 (19.) 129.1 (13.) 153.4 (18.)
 Trefferlage 0.45 mm links, 1.05 mm hoch
 Streuwert 1.86, horizontal: 2.42, vertikal: 1.03

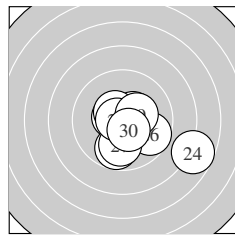

Serie 3:
 10.5 * 10.4 * 9.8 ↓ 7.7 ↘ 10.5 *
 9.7 ↘ 9.9 ↓ 10.7 * 10.3 * 10.5 *
 beste Teiler 58.2 (28.) 104.0 (21.) 114.5 (25.)
 Trefferlage 1.00 mm rechts, 0.87 mm tief
 Streuwert 2.13, horizontal: 2.54, vertikal: 1.61

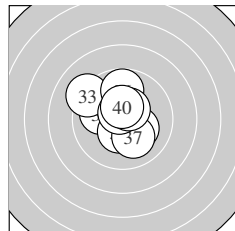

Serie 4:
 10.0 ↖ 10.1 ↑ 9.2 ↖ 10.2 * 10.4 *
 9.8 ↑ 10.1 ↘ 10.7 * 10.5 * 10.4 *
 beste Teiler 74.2 (38.) 120.4 (39.) 127.1 (40.)
 Trefferlage 0.34 mm links, 0.69 mm hoch
 Streuwert 1.59, horizontal: 1.55, vertikal: 1.62

Unterschrift des Schuetzen

Meyton Elektronik

Ergebnis:	408.9	(390)
Serien:	101.5	102.4 102.1 102.9
Zaehler:	31	8 1 0 0 0 0 0 0 0
Innenzehner:	21	
weiteste:	511	(40), 498 (30), 437 (15)
beste Teiler	10.0	(35.) 15.0 (33.) 17.4 (38.)
Trefferlage	0.09 mm rechts, 0.05 mm tief	
Streuwert	1.58, horizontal: 1.80, vertikal: 1.33	

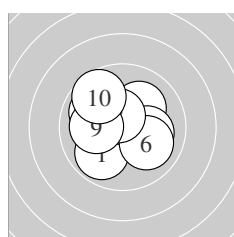
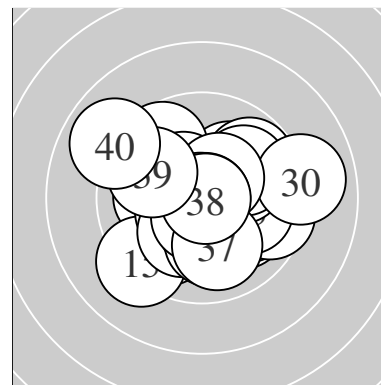

Serie 1:	9.9 ↙	10.6 *	10.6 *	10.1 ↗	10.1 →
	10.0 ↘	9.9 ↖	10.5 *	10.1 ←	9.7 ↖
beste Teiler	82.4 (3.) 97.0 (2.) 101.5 (8.)				
Trefferlage	0.31 mm links, 0.42 mm hoch				
Streuwert	1.54, horizontal: 1.68, vertikal: 1.39				

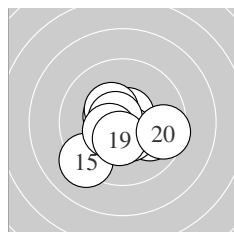

Serie 2:	10.0 ↘	10.7 *	10.5 *	10.5 *	9.2 ↙
	10.4 *	10.7 *	10.4 *	10.4 *	9.6 →
beste Teiler	66.6 (17.) 72.2 (12.) 114.9 (14.)				
Trefferlage	0.03 mm links, 0.55 mm tief				
Streuwert	1.55, horizontal: 1.81, vertikal: 1.23				

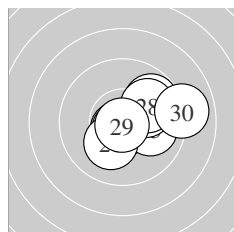

Serie 3:	9.8 ↗	10.7 *	10.7 *	10.7 *	10.0 →
	10.2 *	10.1 ↗	10.0 ↗	10.9 *	9.0 →
beste Teiler	25.4 (29.) 61.5 (22.) 63.9 (24.)				
Trefferlage	1.22 mm rechts, 0.09 mm hoch				
Streuwert	1.49, horizontal: 1.80, vertikal: 1.09				

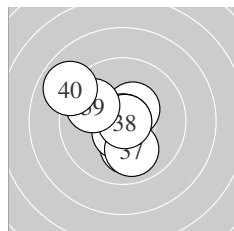

Serie 4:	10.4 *	10.4 *	10.9 *	10.1 ↓	10.9 *
	10.6 *	10.0 ↓	10.9 *	9.8 ↖	8.9 ↖
beste Teiler	10.0 (35.) 15.0 (33.) 17.4 (38.)				
Trefferlage	0.49 mm links, 0.18 mm tief				
Streuwert	1.61, horizontal: 1.64, vertikal: 1.58				

Unterschrift des Schuetzen

Meyton Elektronik

Ergebnis: **409.8** (391)
 Serien: 101.7 101.6 103.0 103.5
 Zaehler: 31 9 0 0 0 0 0 0 0 0
 Innenzehner: 24
 weiteste: 484 (22), 433 (35), 390 (20)
 beste Teiler 9.0 (21.) 22.6 (5.) 60.1 (16.)
 Trefferlage 0.18 mm links, 0.07 mm tief
 Streuwert 1.49, horizontal: 1.65, vertikal: 1.29

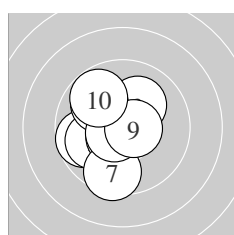
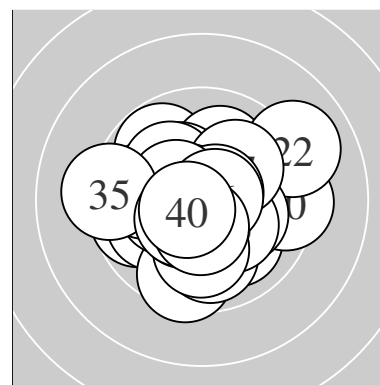

Serie 1:
 9.7 ← 10.0 ← 10.1 ↗ 10.6 * 10.9 *
 9.9 ↘ 9.5 ↓ 10.6 * 10.6 * 9.8 ↘
 beste Teiler 22.6 (5.) 78.2 (8.) 85.7 (9.)
 Trefferlage 0.90 mm links, 0.11 mm tief
 Streuwert 1.52, horizontal: 1.33, vertikal: 1.70

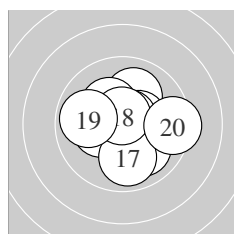

Serie 2:
 10.0 ↗ 10.0 ↘ 10.3 * 10.3 * 10.4 *
 10.7 * 9.9 ↓ 10.7 * 9.9 ← 9.4 →
 beste Teiler 60.1 (16.) 64.2 (18.) 127.4 (15.)
 Trefferlage 0.28 mm rechts, 0.05 mm hoch
 Streuwert 1.62, horizontal: 1.83, vertikal: 1.39

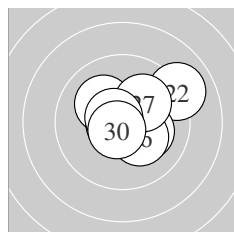

Serie 3:
 10.9 * 9.0 ↗ 10.2 * 10.5 * 10.1 ↘
 10.2 * 10.1 ↗ 10.7 * 10.6 * 10.7 *
 beste Teiler 9.0 (21.) 62.3 (28.) 75.0 (30.)
 Trefferlage 0.66 mm rechts, 0.23 mm hoch
 Streuwert 1.43, horizontal: 1.66, vertikal: 1.16

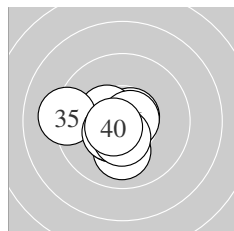

Serie 4:
 10.0 ↓ 10.7 * 10.6 * 10.4 * 9.2 ←
 10.7 * 10.5 * 10.4 * 10.4 * 10.6 *
 beste Teiler 61.3 (36.) 70.7 (32.) 83.7 (40.)
 Trefferlage 0.77 mm links, 0.49 mm tief
 Streuwert 1.18, horizontal: 1.40, vertikal: 0.89

Unterschrift des Schuetzen

Meyton Elektronik

Ergebnis: **419.5** (398)^{QF}
 Serien: 104.0 106.6 105.0 103.9
 Zaehler: 38 2 0 0 0 0 0 0 0 0
 Innenzehner: 36
 weiteste: 287 (5), 266 (34), 234 (23)
 beste Teiler 11.1 (25.) 25.0 (12.) 35.5 (13.)
 Trefferlage 0.15 mm links, 0.25 mm hoch
 Streuwert 0.95, horizontal: 1.06, vertikal: 0.82

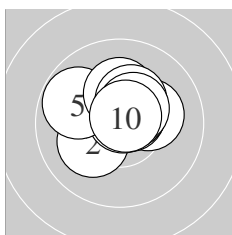
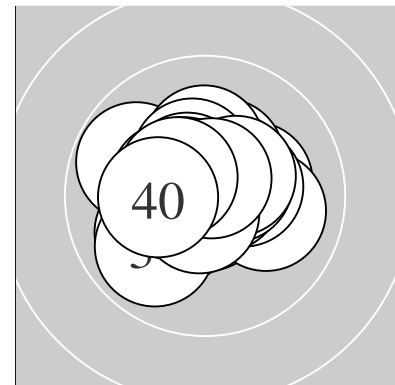

Serie 1:
 10.2 * 10.2 * 10.8 * 10.7 * 9.8 ↖
 10.2 * 10.3 * 10.6 * 10.5 * 10.7 *
 beste Teiler 44.2 (3.) 57.4 (10.) 75.4 (4.)
 Trefferlage 0.09 mm rechts, 0.68 mm hoch
 Streuwert 1.07, horizontal: 1.28, vertikal: 0.80

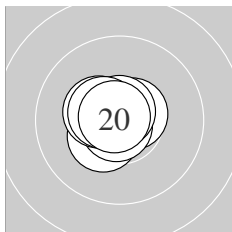

Serie 2:
 10.7 * 10.9 * 10.8 * 10.4 * 10.6 *
 10.8 * 10.4 * 10.7 * 10.5 * 10.8 *
 beste Teiler 25.0 (12.) 35.5 (13.) 39.1 (20.)
 Trefferlage 0.41 mm links, 0.06 mm hoch
 Streuwert 0.54, horizontal: 0.59, vertikal: 0.49

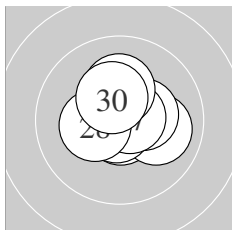

Serie 3:
 10.7 * 10.6 * 10.0 → 10.4 * 10.9 *
 10.8 * 10.7 * 10.3 * 10.2 * 10.4 *
 beste Teiler 11.1 (25.) 46.0 (26.) 56.4 (21.)
 Trefferlage 0.26 mm rechts, 0.26 mm hoch
 Streuwert 0.95, horizontal: 1.05, vertikal: 0.84

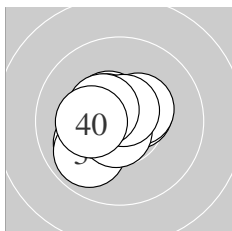

Serie 4:
 10.5 * 10.5 * 10.0 ↙ 9.9 ↙ 10.4 *
 10.5 * 10.7 * 10.7 * 10.5 * 10.2 *
 beste Teiler 68.6 (37.) 70.2 (38.) 105.5 (36.)
 Trefferlage 0.58 mm links, 0.02 mm hoch
 Streuwert 1.06, horizontal: 1.13, vertikal: 0.99

QF – Schütze hat sich fürs Finale qualifiziert

Unterschrift des Schuetzen

Meyton Elektronik

Ergebnis: **414.1** (398)^{QF}
 Serien: 103.0 103.3 104.2 103.6 0.0
 Zaehler: 38 2 0 0 0 0 0 0 0 0
 Innenzehner: 31
 weiteste: 422 (33), 257 (8), 233 (23)
 beste Teiler 34.7 (21.) 47.5 (31.) 71.3 (36.)
 Trefferlage 0.33 mm links, 0.18 mm hoch
 Streuwert 1.15, horizontal: 1.14, vertikal: 1.16

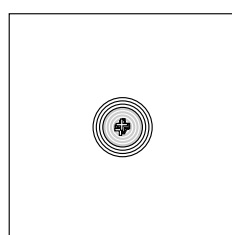
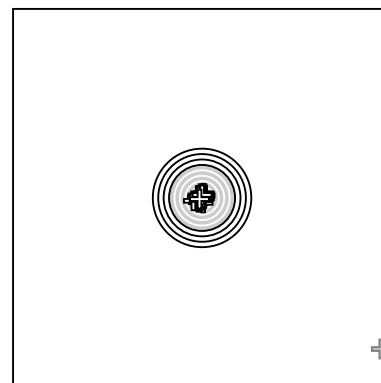

Serie 1:
 10.1 ↗ 10.1 ↗ 10.4 * 10.3 * 10.6 *
 10.5 * 10.5 * 9.9 ↘ 10.5 * 10.1 ↖
 beste Teiler 89.6 (5.) 108.2 (6.) 110.8 (9.)
 Trefferlage 0.04 mm links, 0.57 mm hoch
 Streuwert 1.20, horizontal: 1.09, vertikal: 1.31

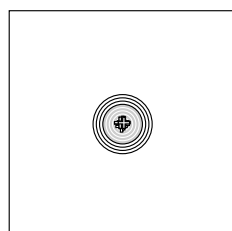

Serie 2:
 10.7 * 10.5 * 10.2 * 10.3 * 10.6 *
 10.2 * 10.1 ↖ 10.1 ↖ 10.2 * 10.4 *
 beste Teiler 72.4 (11.) 89.1 (15.) 107.8 (12.)
 Trefferlage 0.09 mm links, 0.50 mm hoch
 Streuwert 1.17, horizontal: 1.21, vertikal: 1.13

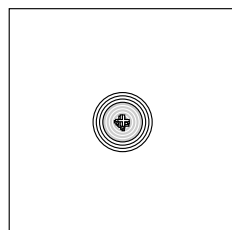

Serie 3:
 10.8 * 10.4 * 10.0 ↓ 10.6 * 10.5 *
 10.6 * 10.5 * 10.1 ← 10.3 * 10.4 *
 beste Teiler 34.7 (21.) 86.8 (26.) 96.3 (24.)
 Trefferlage 0.29 mm links, 0.44 mm tief
 Streuwert 0.98, horizontal: 0.86, vertikal: 1.09

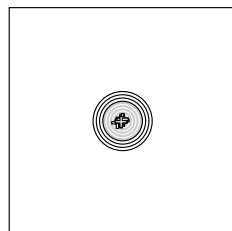

Serie 4:
 10.8 * 10.4 * 9.3 ↙ 10.4 * 10.4 *
 10.7 * 10.4 * 10.4 * 10.4 * 10.4 *
 beste Teiler 47.5 (31.) 71.3 (36.) 130.1 (40.)
 Trefferlage 0.92 mm links, 0.08 mm hoch
 Streuwert 1.14, horizontal: 1.31, vertikal: 0.95

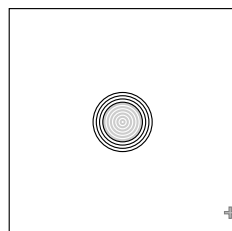

Serie 5:
 0.0+
 beste Teiler ^{AST.NSC}
 Trefferlage 0.00 mm , 0.00 mm
 Streuwert 0.00, horizontal: 0.00, vertikal: 0.00

AST – Treffer wurde nach Ende der Schießzeit abgegeben

Meyton Elektronik

ISSF AR Women – Wertung – Juniorinnen

StartNr: 20

StandNr: 120

21. Januar 2017 9:55

Kitzbichler, Jasmin #70804337

AUT

NSC – Treffer wurde vermessen, geht aber nicht in die Wertung ein
QF – Schütze hat sich fürs Finale qualifiziert

Unterschrift des Schuetzen

Meyton Elektronik

Ergebnis: **412.5** (395)
 Serien: 103.3 103.4 101.6 104.2
 Zaehler: 35 5 0 0 0 0 0 0 0 0
 Innenzehner: 30
 weiteste: 398 (5), 381 (24), 341 (13)
 beste Teiler 25.4 (6.) 26.0 (8.) 33.2 (11.)
 Trefferlage 0.07 mm rechts, 0.04 mm tief
 Streuwert 1.32, horizontal: 1.38, vertikal: 1.25

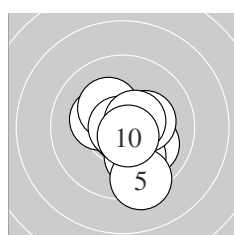
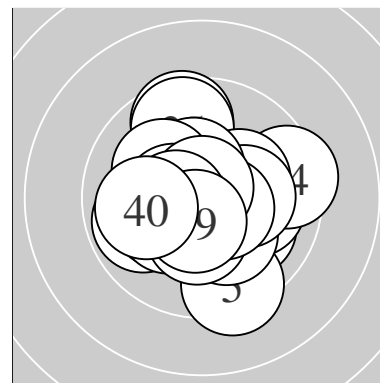

Serie 1:
 10.3 * 10.0 ↘ 10.0 ↓ 10.3 * 9.4 ↓
 10.9 * 10.3 * 10.8 * 10.6 * 10.7 *
 beste Teiler 25.4 (6.) 26.0 (8.) 75.4 (10.)
 Trefferlage 0.41 mm rechts, 0.52 mm tief
 Streuwert 1.34, horizontal: 1.15, vertikal: 1.51

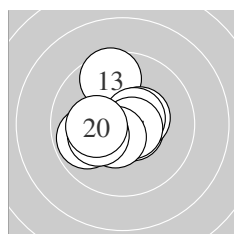

Serie 2:
 10.8 * 10.6 * 9.6 ↑ 10.4 * 9.8 ←
 10.6 * 10.7 * 10.5 * 10.2 * 10.2 *
 beste Teiler 33.2 (11.) 72.6 (17.) 84.2 (12.)
 Trefferlage 0.44 mm links, 0.06 mm hoch
 Streuwert 1.29, horizontal: 1.32, vertikal: 1.25

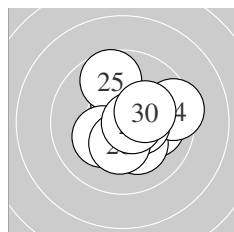

Serie 3:
 10.0 → 10.4 * 10.2 * 9.4 → 9.7 ↑
 10.2 * 10.5 * 10.3 * 10.7 * 10.2 *
 beste Teiler 70.1 (29.) 122.6 (27.) 126.1 (22.)
 Trefferlage 0.80 mm rechts, 0.12 mm hoch
 Streuwert 1.47, horizontal: 1.53, vertikal: 1.42

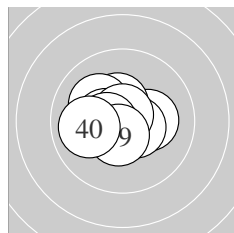

Serie 4:
 10.7 * 10.2 * 10.4 * 10.5 * 10.1 ↘
 10.5 * 10.8 * 10.5 * 10.5 * 10.0 ←
 beste Teiler 46.0 (37.) 64.3 (31.) 101.5 (34.)
 Trefferlage 0.47 mm links, 0.15 mm hoch
 Streuwert 1.02, horizontal: 1.24, vertikal: 0.73

Unterschrift des Schuetzen

Meyton Elektronik

Ergebnis: **417.6** (395)^{QF}
 Serien: 104.1 104.0 105.2 104.3
 Zaehler: 35 5 0 0 0 0 0 0 0 0
 Innenzehner: 33
 weiteste: 347 (8), 304 (32), 287 (30)
 beste Teiler 8.0 (20.) 13.9 (21.) 27.8 (23.)
 Trefferlage 0.03 mm links, 0.01 mm hoch
 Streuwert 1.10, horizontal: 1.26, vertikal: 0.91

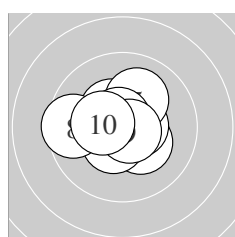
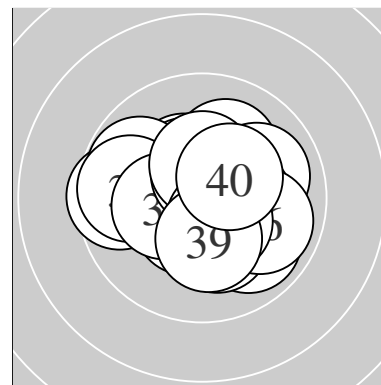

Serie 1:
 10.3 * 10.8 * 10.4 * 10.6 * 10.1 ↗
 10.7 * 10.5 * 9.6 ← 10.7 * 10.4 *
 beste Teiler 45.7 (2.) 55.5 (9.) 61.2 (6.)
 Trefferlage 0.30 mm links, 0.13 mm hoch
 Streuwert 1.19, horizontal: 1.41, vertikal: 0.92

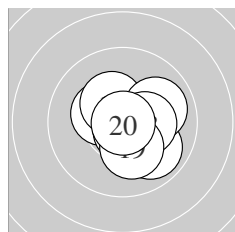

Serie 2:
 10.5 * 10.3 * 10.8 * 10.4 * 9.9 ↘
 10.0 → 10.7 * 10.3 * 10.2 * 10.9 *
 beste Teiler 8.0 (20.) 43.6 (13.) 66.4 (17.)
 Trefferlage 0.41 mm rechts, 0.08 mm tief
 Streuwert 1.15, horizontal: 1.21, vertikal: 1.09

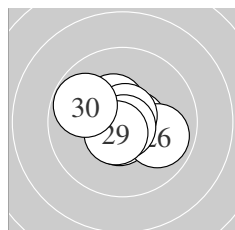

Serie 3:
 10.9 * 10.6 * 10.8 * 10.4 * 10.6 *
 9.9 → 10.8 * 10.8 * 10.6 * 9.8 ↖
 beste Teiler 13.9 (21.) 27.8 (23.) 33.9 (28.)
 Trefferlage 0.05 mm links, 0.05 mm tief
 Streuwert 1.04, horizontal: 1.26, vertikal: 0.76

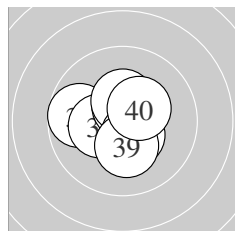

Serie 4:
 10.8 * 9.7 ← 10.7 * 10.3 * 10.7 *
 10.5 * 10.4 * 10.5 * 10.3 * 10.4 *
 beste Teiler 47.1 (31.) 61.6 (35.) 70.0 (33.)
 Trefferlage 0.19 mm links, 0.06 mm hoch
 Streuwert 1.11, horizontal: 1.23, vertikal: 0.97

QF – Schütze hat sich fürs Finale qualifiziert

Unterschrift des Schuetzen

Meyton Elektronik

Ergebnis: **415.5** (398)^{QF}
 Serien: 103.3 104.8 103.6 103.8
 Zaehler: 38 2 0 0 0 0 0 0 0 0
 Innenzehner: 30
 weiteste: 316 (27), 293 (4), 235 (38)
 beste Teiler 16.6 (8.) 18.6 (11.) 27.7 (21.)
 Trefferlage 0.07 mm links, 0.11 mm hoch
 Streuwert 1.14, horizontal: 1.29, vertikal: 0.97

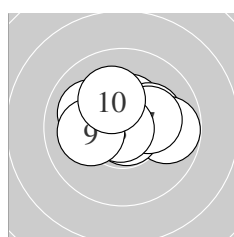
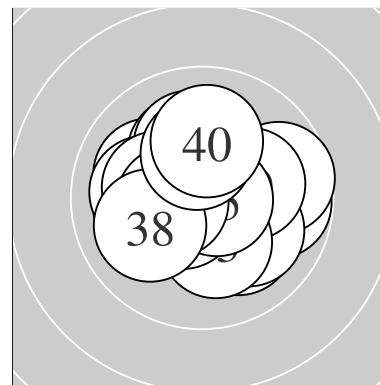

Serie 1:
 10.4 * 10.2 * 10.0 ↖ 9.8 → 10.7 *
 10.8 * 10.2 * 10.9 * 10.1 ← 10.2 *
 beste Teiler 16.6 (8.) 41.1 (6.) 56.0 (5.)
 Trefferlage 0.14 mm rechts, 0.43 mm hoch
 Streuwert 1.28, horizontal: 1.64, vertikal: 0.74

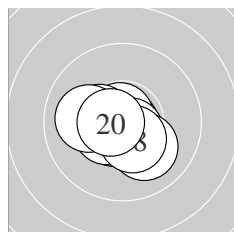

Serie 2:
 10.9 * 10.6 * 10.8 * 10.6 * 10.3 *
 10.1 ↘ 10.5 * 10.4 * 10.0 ← 10.6 *
 beste Teiler 18.6 (11.) 42.4 (13.) 77.8 (14.)
 Trefferlage 0.36 mm links, 0.39 mm tief
 Streuwert 0.91, horizontal: 1.10, vertikal: 0.66

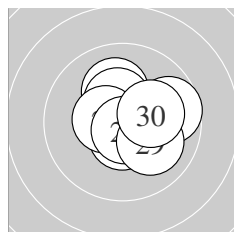

Serie 3:
 10.8 * 10.5 * 10.1 ↑ 10.4 * 10.6 *
 10.5 * 9.7 → 10.7 * 10.1 ↘ 10.2 *
 beste Teiler 27.7 (21.) 55.0 (28.) 95.0 (25.)
 Trefferlage 0.46 mm rechts, 0.30 mm hoch
 Streuwert 1.20, horizontal: 1.33, vertikal: 1.06

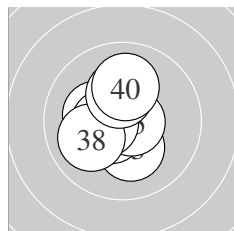

Serie 4:
 10.8 * 10.6 * 10.2 * 10.6 * 10.7 *
 10.2 * 10.5 * 10.0 ↙ 10.2 * 10.0 ↑
 beste Teiler 31.1 (31.) 59.5 (35.) 84.1 (32.)
 Trefferlage 0.53 mm links, 0.10 mm hoch
 Streuwert 1.08, horizontal: 0.93, vertikal: 1.22

QF – Schütze hat sich fürs Finale qualifiziert

Unterschrift des Schuetzen

Meyton Elektronik

Ergebnis: **408.0** (391)
 Serien: 101.9 101.5 102.0 102.6 0.0
 Zaehler: 31 9 0 0 0 0 0 0 0 0
 Innenzehner: 22
 weiteste: 394 (12), 379 (8), 359 (9)
 beste Teiler 34.7 (40.) 39.5 (22.) 53.7 (6.)
 Trefferlage 0.23 mm rechts, 0.16 mm hoch
 Streuwert 1.46, horizontal: 1.54, vertikal: 1.38

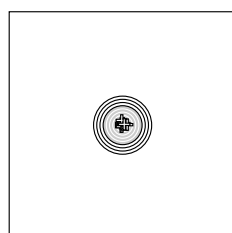
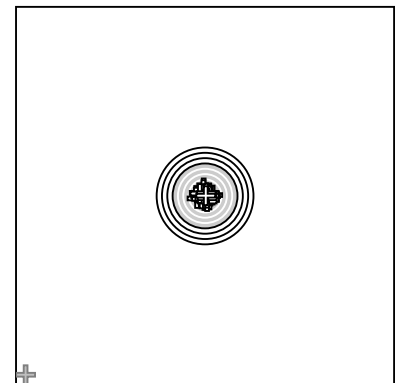

Serie 1:
 10.4 * 10.3 * 10.1 ↗ 10.3 * 10.5 *
 10.7 * 10.3 * 9.4 ↑ 9.5 → 10.4 *
 beste Teiler 53.7 (6.) 123.9 (5.) 143.4 (1.)
 Trefferlage 0.47 mm rechts, 0.73 mm hoch
 Streuwert 1.45, horizontal: 1.52, vertikal: 1.38

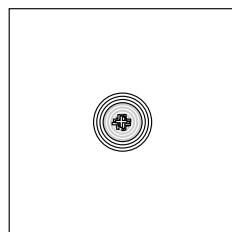

Serie 2:
 10.1 ↓ 9.4 ← 10.4 * 10.4 * 9.7 ↖
 10.0 ↗ 10.4 * 10.0 ↘ 10.6 * 10.5 *
 beste Teiler 89.4 (19.) 110.8 (20.) 127.1 (17.)
 Trefferlage 0.03 mm links, 0.16 mm tief
 Streuwert 1.64, horizontal: 1.91, vertikal: 1.30

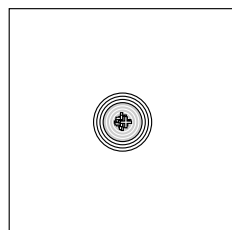

Serie 3:
 10.1 ← 10.8 * 10.1 ↓ 10.1 ↙ 10.4 *
 9.7 ↑ 10.5 * 10.0 ↗ 10.4 * 9.9 →
 beste Teiler 39.5 (22.) 124.9 (27.) 126.8 (29.)
 Trefferlage 0.07 mm links, 0.32 mm hoch
 Streuwert 1.47, horizontal: 1.53, vertikal: 1.41

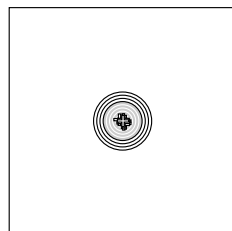

Serie 4:
 10.6 * 10.4 * 9.8 ↘ 10.1 → 9.8 ↓
 9.9 ↖ 10.4 * 10.4 * 10.4 * 10.8 *
 beste Teiler 34.7 (40.) 94.6 (31.) 131.1 (38.)
 Trefferlage 0.56 mm rechts, 0.26 mm tief
 Streuwert 1.34, horizontal: 1.27, vertikal: 1.40

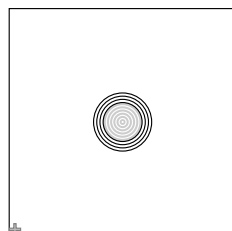

Serie 5:
 0.0+
AST,NSC
 beste Teiler
 Trefferlage 0.00 mm , 0.00 mm
 Streuwert 0.00, horizontal: 0.00, vertikal: 0.00

AST – Treffer wurde nach Ende der Schießzeit abgegeben

Meyton Elektronik

ISSF AR Women – Wertung – Juniorinnen

StandNr: 125

Meier, Sandra #70804590

StartNr: 25

21. Januar 2017 9:54

Switzerland East

NSC – Treffer wurde vermessen, geht aber nicht in die Wertung ein

Unterschrift des Schuetzen

Meyton Elektronik

Ergebnis: **411.9** (396)
 Serien: 104.7 101.4 103.4 102.4
 Zaehler: 36 4 0 0 0 0 0 0 0 0
 Innenzehner: 29
 weiteste: 353 (11), 328 (15), 299 (34)
 beste Teiler 28.0 (6.) 39.1 (2.) 57.4 (20.)
 Trefferlage 0.42 mm rechts, 0.12 mm hoch
 Streuwert 1.24, horizontal: 1.51, vertikal: 0.89

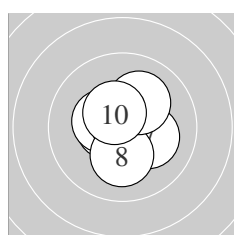
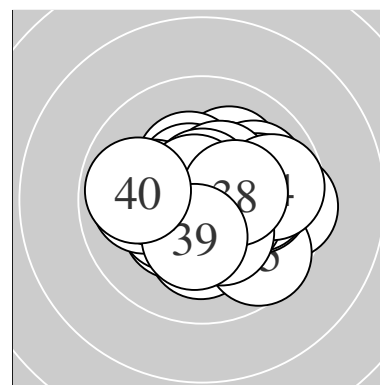

Serie 1:
 10.5 * 10.8 * 10.7 * 10.4 * 10.5 *
 10.8 * 10.2 * 10.2 * 10.1 ↗ 10.5 *
 beste Teiler 28.0 (6.) 39.1 (2.) 70.4 (3.)
 Trefferlage 0.13 mm rechts, 0.14 mm hoch
 Streuwert 0.99, horizontal: 0.98, vertikal: 1.01

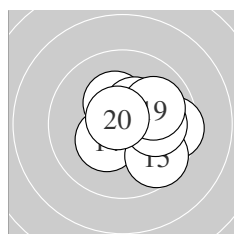

Serie 2:
 9.5 → 10.2 * 10.4 * 10.3 * 9.6 ↘
 10.3 * 10.4 * 10.0 → 10.0 ↗ 10.7 *
 beste Teiler 57.4 (20.) 138.2 (17.) 147.9 (13.)
 Trefferlage 1.21 mm rechts, 0.15 mm hoch
 Streuwert 1.34, horizontal: 1.50, vertikal: 1.15

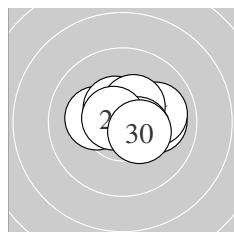

Serie 3:
 10.2 * 10.0 → 10.5 * 10.3 * 10.4 *
 10.0 → 10.4 * 10.5 * 10.7 * 10.4 *
 beste Teiler 70.7 (29.) 113.6 (23.) 116.4 (28.)
 Trefferlage 0.75 mm rechts, 0.26 mm hoch
 Streuwert 1.04, horizontal: 1.36, vertikal: 0.58

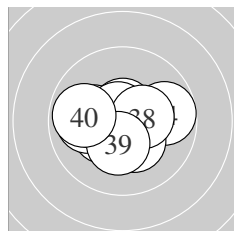

Serie 4:
 10.3 * 10.0 ← 10.6 * 9.8 → 10.1 ←
 10.7 * 10.3 * 10.4 * 10.3 * 9.9 ←
 beste Teiler 61.9 (36.) 78.0 (33.) 141.9 (38.)
 Trefferlage 0.39 mm links, 0.09 mm tief
 Streuwert 1.41, horizontal: 1.80, vertikal: 0.84

Unterschrift des Schuetzen

Ergebnis:	406.1	(389)
Serien:	100.8	102.6 100.7 102.0
Zaehler:	29	11 0 0 0 0 0 0 0 0
Innenzehner:	18	
weiteste:	408	(38), 376 (22), 344 (13)
beste Teiler	15.8	(17.) 57.3 (33.) 73.0 (31.)
Trefferlage	0.09 mm	links, 0.31 mm hoch
Streuwert	1.56,	horizontal: 1.87, vertikal: 1.19

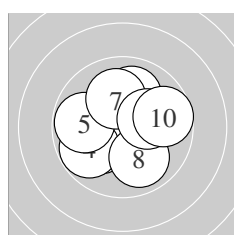
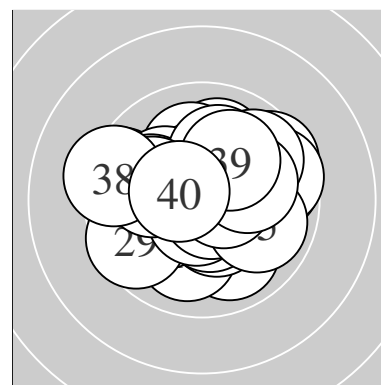

Serie 1:	10.6 *	10.6 *	10.1 ↙	9.8 ↙	9.8 ←
	10.0 ↑	10.1 ↑	9.9 ↘	10.2 *	9.7 →
beste Teiler	81.6	(1.) 97.6 (2.) 192.8 (9.)			
Trefferlage	0.04 mm	rechts, 0.24 mm hoch			
Streuwert	1.70,	horizontal: 1.89, vertikal: 1.49			

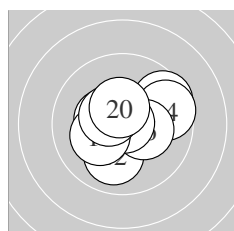

Serie 2:	10.6 *	10.0 ↓	9.6 ↗	9.6 →	10.4 *
	10.3 *	10.9 *	10.2 *	10.5 *	10.5 *
beste Teiler	15.8	(17.) 77.4 (11.) 118.8 (19.)			
Trefferlage	0.32 mm	rechts, 0.22 mm hoch			
Streuwert	1.47,	horizontal: 1.73, vertikal: 1.16			

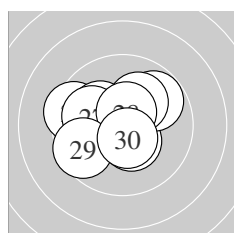

Serie 3:	10.1 ←	9.4 ←	10.2 *	10.4 *	9.8 ↗
	10.1 ↗	10.0 ←	10.6 *	9.6 ↙	10.5 *
beste Teiler	100.9	(28.) 103.4 (30.) 135.2 (24.)			
Trefferlage	0.78 mm	links, 0.33 mm hoch			
Streuwert	1.65,	horizontal: 1.97, vertikal: 1.23			

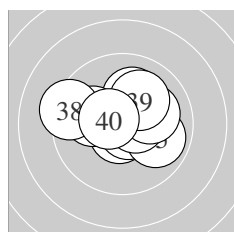

Serie 4:	10.7 *	10.1 ↑	10.7 *	10.0 ←	9.9 →
	10.6 *	10.1 →	9.3 ←	10.1 ↗	10.5 *
beste Teiler	57.3	(33.) 73.0 (31.) 97.4 (36.)			
Trefferlage	0.04 mm	rechts, 0.45 mm hoch			
Streuwert	1.56,	horizontal: 1.96, vertikal: 0.99			

Unterschrift des Schuetzen

Meyton Elektronik

Ergebnis:	401.2	(380)
Serien:	98.7	100.7 99.1 102.7
Zaehler:	24	12 4 0 0 0 0 0 0 0
Innenzehner:	22	
weiteste:	569 (8), 528 (20), 523 (4)	
beste Teiler	6.3 (23.)	20.3 (3.) 53.0 (14.)
Trefferlage	0.10 mm links, 0.66 mm hoch	
Streuwert	1.92, horizontal: 2.04, vertikal: 1.79	

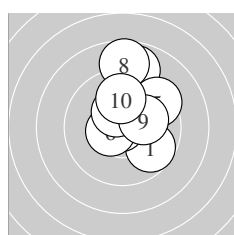
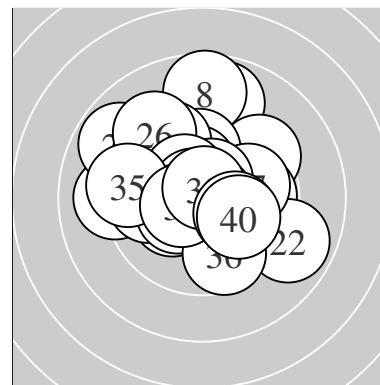

Serie 1:	9.7 ↘	10.1 ↗	10.9 *	8.9 ↑	9.4 ↗
	10.5 *	10.4 *	8.7 ↑	10.2 *	9.9 ↑
beste Teiler	20.3 (3.) 113.5 (6.) 148.3 (7.)				
Trefferlage	0.76 mm rechts, 1.73 mm hoch				
Streuwert	1.91, horizontal: 1.38, vertikal: 2.33				

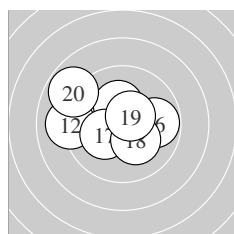

Serie 2:	10.5 *	9.1 ←	10.6 *	10.7 *	10.3 *
	9.8 →	10.2 *	10.2 *	10.5 *	8.8 ↘
beste Teiler	53.0 (14.) 85.0 (13.) 101.1 (19.)				
Trefferlage	0.78 mm links, 0.40 mm hoch				
Streuwert	1.87, horizontal: 2.34, vertikal: 1.24				

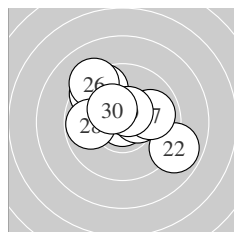

Serie 3:	9.5 ↘	8.9 ↘	10.9 *	9.6 ↘	10.4 *
	9.2 ↘	9.9 →	9.8 ←	10.5 *	10.4 *
beste Teiler	6.3 (23.) 107.3 (29.) 139.9 (25.)				
Trefferlage	0.16 mm links, 0.97 mm hoch				
Streuwert	2.12, horizontal: 2.46, vertikal: 1.71				

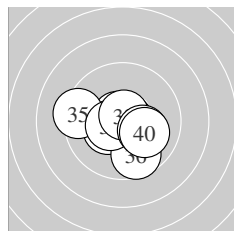

Serie 4:	10.3 *	10.7 *	10.7 *	10.5 *	9.3 ←
	9.7 ↓	10.5 *	10.7 *	10.2 *	10.1 ↘
beste Teiler	54.0 (32.) 55.1 (38.) 63.0 (33.)				
Trefferlage	0.23 mm links, 0.46 mm tief				
Streuwert	1.47, horizontal: 1.78, vertikal: 1.06				

Unterschrift des Schuetzen

Meyton Elektronik

Ergebnis: **407.1** (390)
 Serien: 99.1 104.0 101.7 102.3
 Zaehler: 30 10 0 0 0 0 0 0 0 0
 Innenzehner: 25
 weiteste: 497 (4), 464 (8), 448 (38)
 beste Teiler 26.0 (13.) 34.0 (10.) 36.6 (33.)
 Trefferlage 0.19 mm rechts, 0.12 mm hoch
 Streuwert 1.61, horizontal: 1.91, vertikal: 1.22

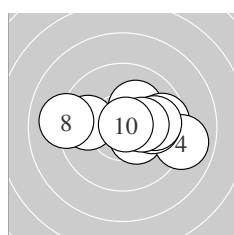
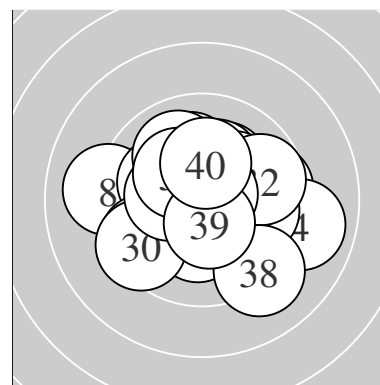

Serie 1:
 10.4 * 10.2 * 9.6 → 9.0 → 10.0 →
 9.8 ← 9.9 → 9.1 ← 10.3 * 10.8 *
 beste Teiler 34.0 (10.) 138.6 (1.) 158.3 (9.)
 Trefferlage 0.96 mm rechts, 0.18 mm hoch
 Streuwert 2.07, horizontal: 2.82, vertikal: 0.76

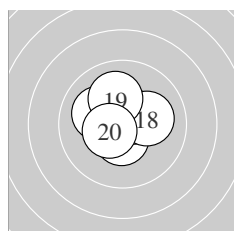

Serie 2:
 10.4 * 10.4 * 10.8 * 10.5 * 10.1 ↖
 10.5 * 10.6 * 10.1 → 10.1 ↑ 10.5 *
 beste Teiler 26.0 (13.) 79.3 (17.) 103.2 (16.)
 Trefferlage 0.38 mm links, 0.40 mm hoch
 Streuwert 1.01, horizontal: 1.14, vertikal: 0.87

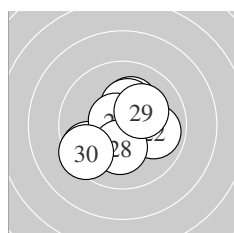

Serie 3:
 10.7 * 9.9 → 9.6 ↙ 10.2 * 10.4 *
 10.3 * 10.7 * 10.2 * 10.2 * 9.5 ↙
 beste Teiler 62.0 (21.) 68.5 (27.) 132.8 (25.)
 Trefferlage 0.13 mm links, 0.28 mm tief
 Streuwert 1.62, horizontal: 1.74, vertikal: 1.48

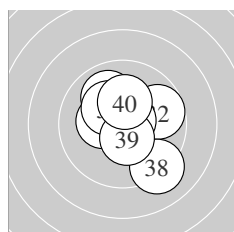

Serie 4:
 10.6 * 9.7 → 10.8 * 10.0 ↖ 10.7 *
 10.3 * 10.3 * 9.2 ↘ 10.5 * 10.2 *
 beste Teiler 36.6 (33.) 57.8 (35.) 89.1 (31.)
 Trefferlage 0.34 mm rechts, 0.21 mm hoch
 Streuwert 1.59, horizontal: 1.54, vertikal: 1.63

Unterschrift des Schuetzen

Meyton Elektronik

Ergebnis: **398.6** (383)
 Serien: 100.3 99.4 99.5 99.4
 Zaehler: 24 15 1 0 0 0 0 0 0 0
 Innenzehner: 18
 weiteste: 548 (8), 484 (24), 428 (18)
 beste Teiler 68.2 (26.) 112.0 (27.) 123.0 (9.)
 Trefferlage 0.00 mm , 0.41 mm hoch
 Streuwert 1.92, horizontal: 2.15, vertikal: 1.66

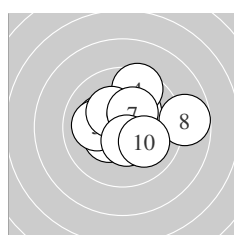
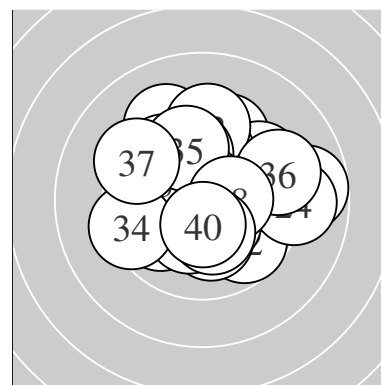

Serie 1:
 10.4 * 10.2 * 10.2 * 9.5 ↑ 10.1 ←
 10.3 * 10.3 * 8.8 → 10.5 * 10.0 ↘
 beste Teiler 123.0 (9.) 146.4 (1.) 154.7 (7.)
 Trefferlage 0.48 mm rechts, 0.54 mm hoch
 Streuwert 1.88, horizontal: 2.25, vertikal: 1.41

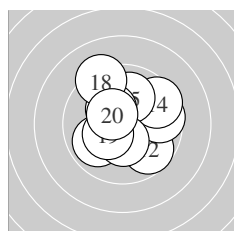

Serie 2:
 9.9 ↙ 9.7 ↘ 9.6 → 9.5 ↗ 10.0 ↑
 10.3 * 10.4 * 9.2 ↘ 10.3 * 10.5 *
 beste Teiler 125.9 (20.) 146.1 (17.) 155.0 (19.)
 Trefferlage 0.18 mm rechts, 0.49 mm hoch
 Streuwert 1.97, horizontal: 2.01, vertikal: 1.94

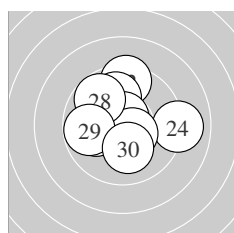

Serie 3:
 10.3 * 9.4 ↑ 10.0 ← 9.0 → 10.0 ↑
 10.7 * 10.5 * 9.7 ↘ 9.8 ← 10.1 ↓
 beste Teiler 68.2 (26.) 112.0 (27.) 151.1 (21.)
 Trefferlage 0.26 mm links, 0.61 mm hoch
 Streuwert 2.00, horizontal: 2.20, vertikal: 1.77

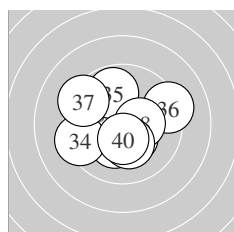

Serie 4:
 10.2 * 10.4 * 9.9 ↖ 9.4 ← 9.8 ↑
 9.3 → 9.4 ↖ 10.4 * 10.2 * 10.4 *
 beste Teiler 130.0 (40.) 146.4 (32.) 150.0 (38.)
 Trefferlage 0.41 mm links, 0.00 mm
 Streuwert 2.05, horizontal: 2.37, vertikal: 1.67

Unterschrift des Schuetzen

Meyton Elektronik

Ergebnis: **399.4** (378)
 Serien: 100.2 99.6 100.3 99.3 0.0
 Zaehler: 21 16 3 0 0 0 0 0 0 0
 Innenzehner: 17
 weiteste: 624 (39), 587 (27), 502 (19)
 beste Teiler 22.5 (23.) 52.3 (29.) 60.2 (32.)
 Trefferlage 0.52 mm rechts, 0.62 mm tief
 Streuwert 1.92, horizontal: 2.18, vertikal: 1.62

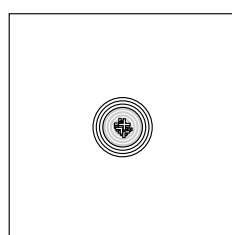
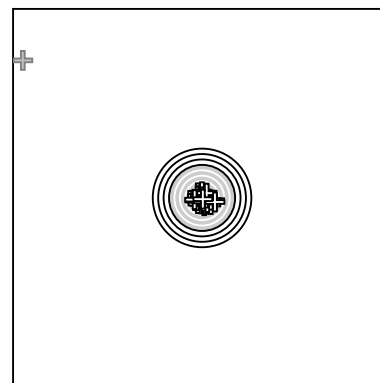

Serie 1:
 9.6 ↘ 9.7 ↖ 10.6 * 10.2 * 9.7 ↘
 10.1 ↓ 9.5 ↓ 10.4 * 10.4 * 10.0 ↗
 beste Teiler 82.4 (3.) 133.6 (8.) 138.1 (9.)
 Trefferlage 0.22 mm rechts, 0.46 mm tief
 Streuwert 1.83, horizontal: 1.66, vertikal: 1.97

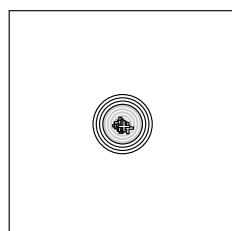

Serie 2:
 9.8 ↓ 10.7 * 9.6 ↗ 10.3 * 9.6 ←
 10.1 ↖ 9.9 ↙ 10.6 * 8.9 ↘ 10.1 ↓
 beste Teiler 75.2 (12.) 94.3 (18.) 165.8 (14.)
 Trefferlage 0.73 mm links, 1.23 mm tief
 Streuwert 1.76, horizontal: 2.06, vertikal: 1.39

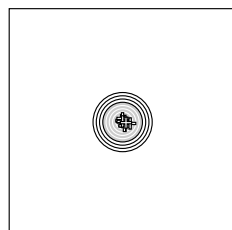

Serie 3:
 10.2 * 9.6 ↘ 10.9 * 10.6 * 10.3 *
 9.7 ↘ 8.6 → 9.8 ↑ 10.7 * 9.9 →
 beste Teiler 22.5 (23.) 52.3 (29.) 88.2 (24.)
 Trefferlage 1.20 mm rechts, 0.10 mm tief
 Streuwert 1.89, horizontal: 1.98, vertikal: 1.80

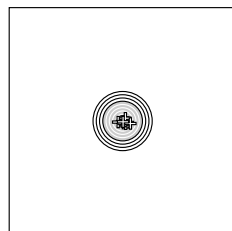

Serie 4:
 10.6 * 10.7 * 9.3 → 9.6 ← 9.7 ↘
 10.2 * 10.3 * 9.7 ↗ 8.5 → 10.7 *
 beste Teiler 60.2 (32.) 66.5 (40.) 88.8 (31.)
 Trefferlage 1.39 mm rechts, 0.68 mm tief
 Streuwert 2.00, horizontal: 2.55, vertikal: 1.22

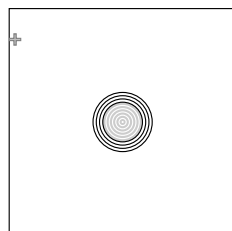

Serie 5:
 0.0+
AST.NSC
 beste Teiler
 Trefferlage 0.00 mm , 0.00 mm
 Streuwert 0.00, horizontal: 0.00, vertikal: 0.00

AST – Treffer wurde nach Ende der Schießzeit abgegeben

Meyton Elektronik

ISSF AR Women – Wertung – Juniorinnen

StandNr: 131

Kalberer, Michelle #70804592

StartNr: 31

21. Januar 2017 9:53

Switzerland East

NSC – Treffer wurde vermessen, geht aber nicht in die Wertung ein

Unterschrift des Schuetzen

Meyton Elektronik

Ergebnis: **412.3** (393)
 Serien: 103.8 103.1 102.3 103.1 0.0
 Zaehler: 33 7 0 0 0 0 0 0 0 0
 Innenzehner: 29
 weiteste: 351 (26), 321 (1), 282 (11)
 beste Teiler 28.6 (4.) 32.2 (25.) 39.0 (30.)
 Trefferlage 0.52 mm rechts, 0.21 mm hoch
 Streuwert 1.22, horizontal: 1.26, vertikal: 1.17

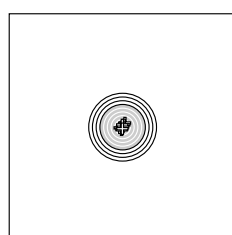
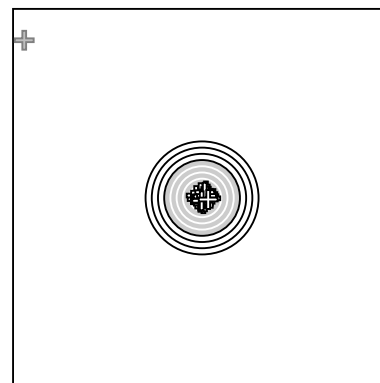

Serie 1:
 9.7 ↗ 10.1 ← 10.2 * 10.8 * 10.8 *
 10.4 * 10.8 * 10.3 * 10.2 * 10.5 *
 beste Teiler 28.6 (4.) 44.5 (5.) 48.9 (7.)
 Trefferlage 0.12 mm links, 0.21 mm hoch
 Streuwert 1.23, horizontal: 0.99, vertikal: 1.43

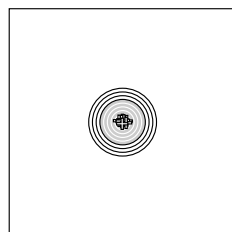

Serie 2:
 9.8 → 9.9 ↖ 10.3 * 10.4 * 10.7 *
 10.5 * 10.4 * 10.6 * 10.0 → 10.5 *
 beste Teiler 62.7 (15.) 98.3 (18.) 106.5 (16.)
 Trefferlage 0.29 mm rechts, 0.60 mm hoch
 Streuwert 1.20, horizontal: 1.49, vertikal: 0.81

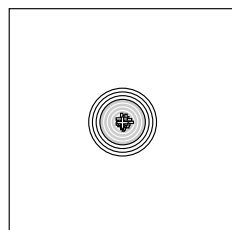

Serie 3:
 10.0 ↓ 10.4 * 10.2 * 10.3 * 10.8 *
 9.5 → 10.4 * 9.8 ↗ 10.1 ↑ 10.8 *
 beste Teiler 32.2 (25.) 39.0 (30.) 135.7 (27.)
 Trefferlage 0.86 mm rechts, 0.09 mm tief
 Streuwert 1.37, horizontal: 1.36, vertikal: 1.39

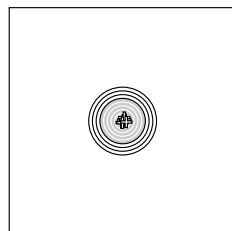

Serie 4:
 10.4 * 10.4 * 10.2 * 10.5 * 10.4 *
 10.7 * 10.2 * 9.9 ↗ 10.5 * 9.9 →
 beste Teiler 73.8 (36.) 112.8 (34.) 115.8 (39.)
 Trefferlage 1.07 mm rechts, 0.14 mm hoch
 Streuwert 0.98, horizontal: 0.94, vertikal: 1.02

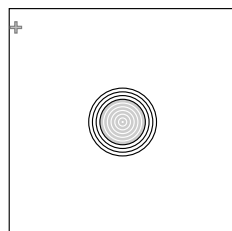

Serie 5:
 0.0+
 beste Teiler ^{AST.NSC}
 Trefferlage 0.00 mm , 0.00 mm
 Streuwert 0.00, horizontal: 0.00, vertikal: 0.00

AST – Treffer wurde nach Ende der Schießzeit abgegeben

Meyton Elektronik

ISSF AR Women – Wertung – Juniorinnen

StandNr: 132

Pribitzer, Marlene #108

StartNr: 32

21. Januar 2017 9:53

AUT

NSC – Treffer wurde vermessen, geht aber nicht in die Wertung ein

Unterschrift des Schuetzen

Meyton Elektronik

Ergebnis: **403.1** (385)
 Serien: 102.5 99.7 100.7 100.2
 Zaehler: 25 15 0 0 0 0 0 0 0 0
 Innenzehner: 17
 weiteste: 420 (3), 376 (29), 368 (12)
 beste Teiler 37.0 (23.) 47.4 (4.) 80.4 (9.)
 Trefferlage 0.35 mm rechts, 0.62 mm hoch
 Streuwert 1.63, horizontal: 1.88, vertikal: 1.34

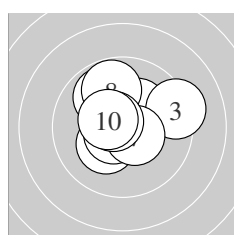
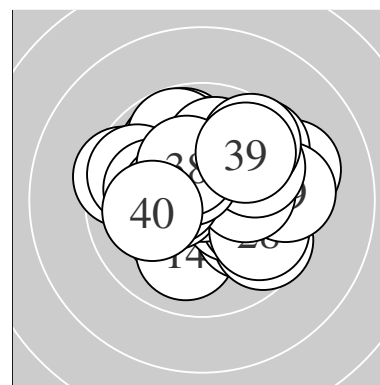

Serie 1:
 10.2 * 9.9 ↖ 9.3 → 10.8 * 10.3 *
 10.6 * 10.5 * 9.8 ↗ 10.6 * 10.5 *
 beste Teiler 47.4 (4.) 80.4 (9.) 83.6 (6.)
 Trefferlage 0.02 mm links, 0.60 mm hoch
 Streuwert 1.49, horizontal: 1.65, vertikal: 1.32

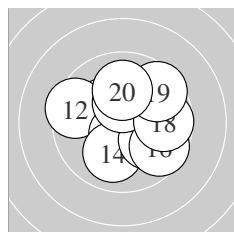

Serie 2:
 10.3 * 9.5 ← 10.6 * 10.0 ↓ 10.0 ↘
 9.6 ↘ 10.4 * 9.7 → 9.6 ↗ 10.0 ↑
 beste Teiler 91.3 (13.) 146.0 (17.) 171.6 (11.)
 Trefferlage 0.43 mm rechts, 0.20 mm hoch
 Streuwert 1.91, horizontal: 2.12, vertikal: 1.68

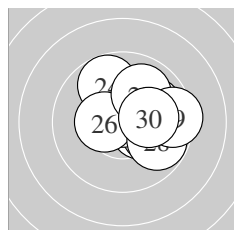

Serie 3:
 10.4 * 10.0 → 10.8 * 9.8 ↖ 10.0 →
 10.4 * 9.9 ↗ 9.8 ↘ 9.4 → 10.2 *
 beste Teiler 37.0 (23.) 135.0 (26.) 145.0 (21.)
 Trefferlage 1.29 mm rechts, 0.43 mm hoch
 Streuwert 1.46, horizontal: 1.64, vertikal: 1.27

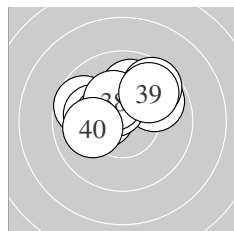

Serie 4:
 9.8 ↗ 10.0 ↑ 9.6 ↗ 9.7 ← 10.1 ←
 10.4 * 10.5 * 10.3 * 9.8 ↗ 10.0 ←
 beste Teiler 123.4 (37.) 140.6 (36.) 167.8 (38.)
 Trefferlage 0.28 mm links, 1.24 mm hoch
 Streuwert 1.55, horizontal: 1.96, vertikal: 0.96

Unterschrift des Schuetzen

Ergebnis: **407.9** (391)
 Serien: 101.3 102.6 102.4 101.6
 Zaehler: 31 9 0 0 0 0 0 0 0 0
 Innenzehner: 26
 weiteste: 445 (34), 434 (16), 359 (8)
 beste Teiler 9.4 (14.) 23.0 (11.) 23.0 (40.)
 Trefferlage 0.27 mm rechts, 0.19 mm hoch
 Streuwert 1.50, horizontal: 1.68, vertikal: 1.29

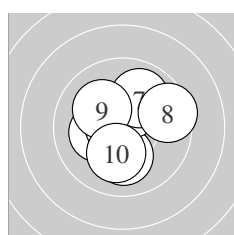
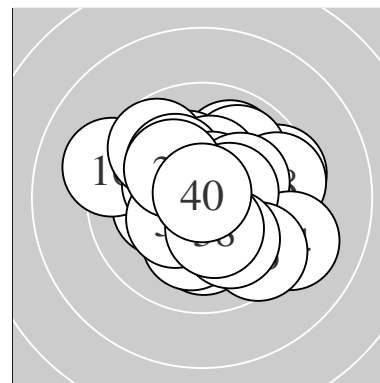

Serie 1:
 10.2 * 10.3 * 10.1 ↗ 10.7 * 10.1 ↓
 10.3 * 9.9 ↗ 9.5 → 10.1 ↖ 10.1 ↓
 beste Teiler 62.6 (4.) 151.1 (6.) 156.9 (2.)
 Trefferlage 0.15 mm rechts, 0.18 mm hoch
 Streuwert 1.58, horizontal: 1.54, vertikal: 1.62

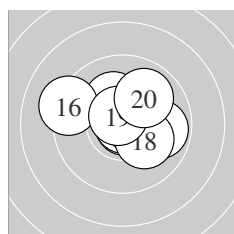

Serie 2:
 10.9 * 10.2 * 10.2 * 10.9 * 10.6 *
 9.2 ↖ 9.8 → 10.2 * 10.7 * 9.9 ↗
 beste Teiler 9.4 (14.) 23.0 (11.) 71.1 (19.)
 Trefferlage 0.37 mm rechts, 0.37 mm hoch
 Streuwert 1.53, horizontal: 1.91, vertikal: 1.03

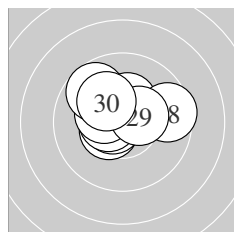

Serie 3:
 10.3 * 10.3 * 10.5 * 10.6 * 10.5 *
 10.3 * 9.7 ↖ 9.6 → 10.4 * 10.2 *
 beste Teiler 76.9 (24.) 107.0 (25.) 120.0 (23.)
 Trefferlage 0.36 mm links, 0.76 mm hoch
 Streuwert 1.31, horizontal: 1.62, vertikal: 0.89

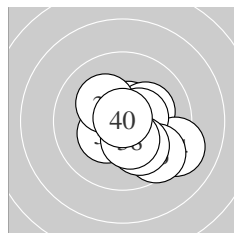

Serie 4:
 10.6 * 10.3 * 10.2 * 9.2 ↖ 10.4 *
 9.5 ↖ 10.0 ↖ 10.3 * 10.2 * 10.9 *
 beste Teiler 23.0 (40.) 88.1 (31.) 126.6 (35.)
 Trefferlage 0.93 mm rechts, 0.52 mm tief
 Streuwert 1.49, horizontal: 1.63, vertikal: 1.35

Unterschrift des Schuetzen

Meyton Elektronik

Ergebnis: **403.2** (383)
 Serien: 99.5 102.4 102.3 99.0
 Zaehler: 25 13 2 0 0 0 0 0 0 0
 Innenzehner: 22
 weiteste: 611 (7), 538 (32), 419 (8)
 beste Teiler 42.9 (17.) 49.8 (13.) 74.3 (40.)
 Trefferlage 0.37 mm rechts, 0.40 mm hoch
 Streuwert 1.77, horizontal: 2.03, vertikal: 1.47

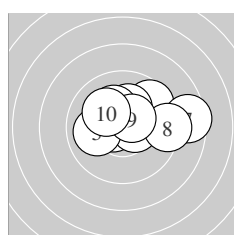
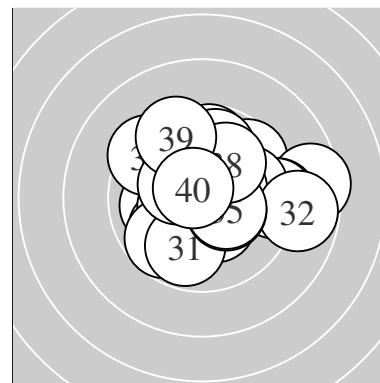

Serie 1:
 9.6 ↗ 10.6 * 10.2 * 10.5 * 10.0 ←
 10.2 * 8.5 → 9.3 → 10.5 * 10.1 ↘
 beste Teiler 87.2 (2.) 114.4 (4.) 119.5 (9.)
 Trefferlage 0.97 mm rechts, 0.80 mm hoch
 Streuwert 1.98, horizontal: 2.64, vertikal: 0.92

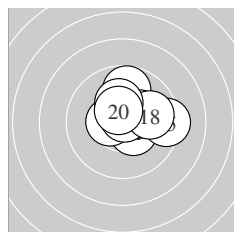

Serie 2:
 10.4 * 9.7 ↑ 10.8 * 10.5 * 9.3 →
 10.3 * 10.8 * 9.9 → 10.2 * 10.5 *
 beste Teiler 42.9 (17.) 49.8 (13.) 115.4 (20.)
 Trefferlage 0.77 mm rechts, 0.73 mm hoch
 Streuwert 1.34, horizontal: 1.57, vertikal: 1.06

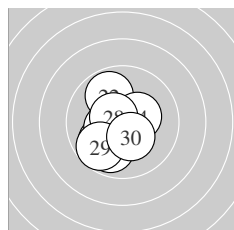

Serie 3:
 10.6 * 9.9 ↘ 10.6 * 10.4 * 9.9 ↙
 10.4 * 9.9 ↙ 10.6 * 9.7 ↙ 10.3 *
 beste Teiler 87.7 (23.) 93.4 (21.) 95.8 (28.)
 Trefferlage 0.51 mm links, 0.60 mm tief
 Streuwert 1.37, horizontal: 1.24, vertikal: 1.48

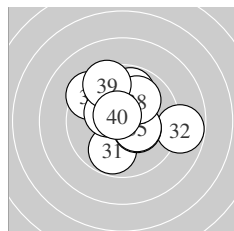

Serie 4:
 9.8 ↘ 8.8 → 10.3 * 9.4 ↘ 10.4 *
 10.3 * 9.8 ↑ 10.0 ↗ 9.5 ↘ 10.7 *
 beste Teiler 74.3 (40.) 147.7 (35.) 151.6 (33.)
 Trefferlage 0.28 mm rechts, 0.70 mm hoch
 Streuwert 2.12, horizontal: 2.31, vertikal: 1.91

Unterschrift des Schuetzen

Meyton Elektronik

Ergebnis: **399.1** (381)
 Serien: 96.6 100.3 98.1 104.1
 Zaehler: 24 13 3 0 0 0 0 0 0 0
 Innenzehner: 16
 weiteste: 593 (3), 572 (4), 520 (5)
 beste Teiler 13.4 (37.) 35.6 (34.) 40.8 (25.)
 Trefferlage 0.38 mm links, 0.15 mm hoch
 Streuwert 2.02, horizontal: 2.30, vertikal: 1.69

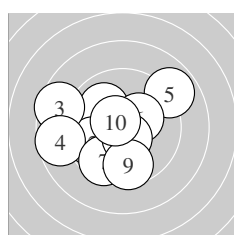
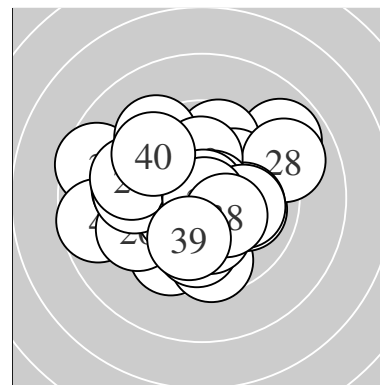

Serie 1:
 10.0 ↘ 9.8 ↙ 8.6 ↖ 8.7 ← 8.9 ↗
 10.3 * 9.6 ↘ 10.5 * 9.6 ↓ 10.6 *
 beste Teiler 86.4 (10.) 105.8 (8.) 165.7 (6.)
 Trefferlage 1.13 mm links, 0.18 mm tief
 Streuwert 2.62, horizontal: 3.04, vertikal: 2.13

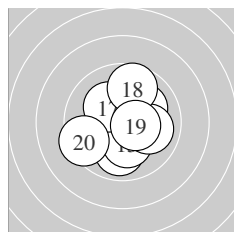

Serie 2:
 9.9 ↓ 9.8 ↑ 10.1 ↗ 10.5 * 10.2 *
 10.0 → 10.2 * 9.7 ↑ 10.5 * 9.4 ←
 beste Teiler 108.6 (14.) 119.8 (19.) 186.0 (17.)
 Trefferlage 0.14 mm rechts, 0.09 mm hoch
 Streuwert 1.81, horizontal: 1.70, vertikal: 1.91

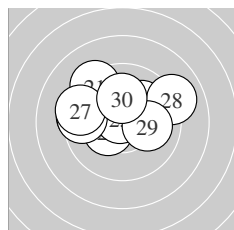

Serie 3:
 9.3 ↘ 9.5 ← 10.0 ↗ 10.4 * 10.8 *
 9.5 ← 9.4 ← 9.0 ↗ 10.1 → 10.1 ↑
 beste Teiler 40.8 (25.) 150.0 (24.) 213.1 (30.)
 Trefferlage 0.68 mm links, 1.00 mm hoch
 Streuwert 2.17, horizontal: 2.81, vertikal: 1.23

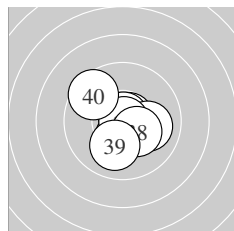

Serie 4:
 10.8 * 10.7 * 10.4 * 10.8 * 10.0 →
 10.7 * 10.9 * 10.3 * 10.0 ↓ 9.5 ↘
 beste Teiler 13.4 (37.) 35.6 (34.) 41.0 (31.)
 Trefferlage 0.14 mm rechts, 0.27 mm tief
 Streuwert 1.24, horizontal: 1.26, vertikal: 1.22

Unterschrift des Schuetzen

Meyton Elektronik

Ergebnis: **411.3** (394)
 Serien: 103.6 102.1 102.5 103.1
 Zaehler: 34 6 0 0 0 0 0 0 0 0
 Innenzehner: 28
 weiteste: 485 (29), 372 (16), 345 (1)
 beste Teiler 15.8 (30.) 63.9 (10.) 65.7 (4.)
 Trefferlage 0.30 mm links, 0.20 mm tief
 Streuwert 1.37, horizontal: 1.63, vertikal: 1.05

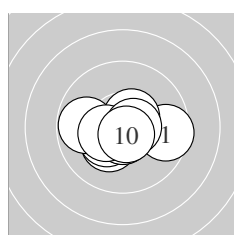
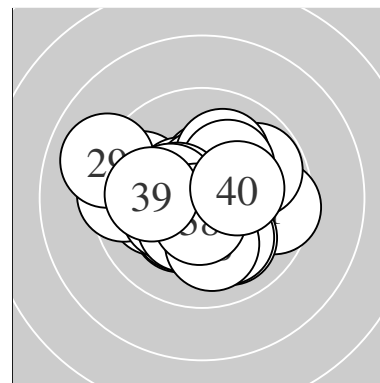

Serie 1:
 9.6 → 10.3 * 10.3 * 10.7 * 10.7 *
 9.8 ← 10.5 * 10.4 * 10.6 * 10.7 *
 beste Teiler 63.9 (10.) 65.7 (4.) 72.0 (5.)
 Trefferlage 0.13 mm links, 0.40 mm tief
 Streuwert 1.26, horizontal: 1.69, vertikal: 0.60

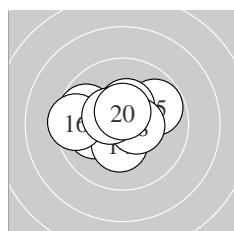

Serie 2:
 10.7 * 9.7 ← 10.1 ← 10.3 * 9.8 ↗
 9.5 ← 10.4 * 10.5 * 10.5 * 10.6 *
 beste Teiler 68.5 (11.) 100.0 (20.) 111.7 (18.)
 Trefferlage 0.55 mm links, 0.36 mm hoch
 Streuwert 1.50, horizontal: 1.92, vertikal: 0.91

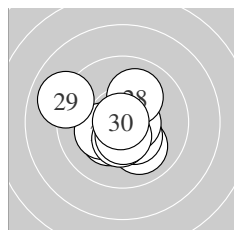

Serie 3:
 10.3 * 10.3 * 10.0 ↘ 10.4 * 10.6 *
 10.4 * 10.5 * 10.1 ↗ 9.0 ← 10.9 *
 beste Teiler 15.8 (30.) 81.3 (25.) 112.1 (27.)
 Trefferlage 0.34 mm links, 0.36 mm tief
 Streuwert 1.55, horizontal: 1.74, vertikal: 1.32

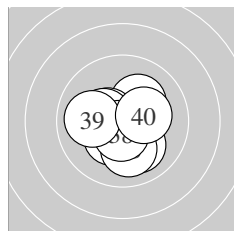

Serie 4:
 10.1 ↘ 10.2 * 10.5 * 10.3 * 10.3 *
 10.1 ↓ 10.7 * 10.6 * 10.0 ← 10.3 *
 beste Teiler 67.1 (37.) 95.7 (38.) 123.3 (33.)
 Trefferlage 0.17 mm links, 0.40 mm tief
 Streuwert 1.25, horizontal: 1.33, vertikal: 1.17

Unterschrift des Schuetzen

Meyton Elektronik

Ergebnis:	414.3	(398) ^{QF}
Serien:	104.2	104.0 103.3 102.8
Zaehler:	38	2 0 0 0 0 0 0 0 0
Innenzehner:	27	
weiteste:	333	(39), 278 (18), 245 (5)
beste Teiler	12.0	(35.) 30.0 (15.) 31.0 (2.)
Trefferlage	0.18 mm	rechts, 0.12 mm hoch
Streuwert	1.19,	horizontal: 1.38, vertikal: 0.96

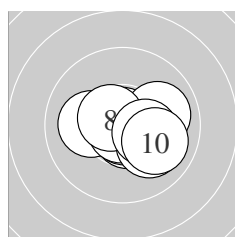
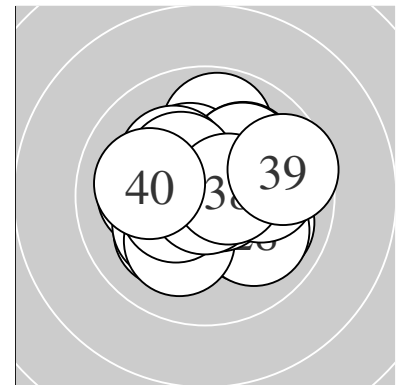

Serie 1:	10.7 *	10.8 *	10.8 *	10.1 ←	10.0 →
	10.8 *	10.1 ↘	10.6 *	10.3 *	10.0 ↘
beste Teiler	31.0	(2.) 31.9 (6.)	44.1 (3.)		
Trefferlage	0.52 mm	rechts, 0.27 mm	tief		
Streuwert	1.11,	horizontal: 1.43, vertikal: 0.66			

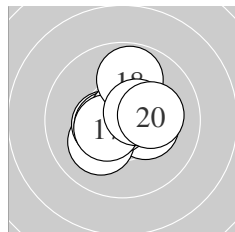

Serie 2:	10.3 *	10.1 ↗	10.5 *	10.5 *	10.8 *
	10.8 *	10.5 *	9.8 ↑	10.5 *	10.2 *
beste Teiler	30.0	(15.) 37.1 (16.)	106.9 (14.)		
Trefferlage	0.01 mm	links, 0.10 mm	hoch		
Streuwert	1.15,	horizontal: 1.20, vertikal: 1.09			

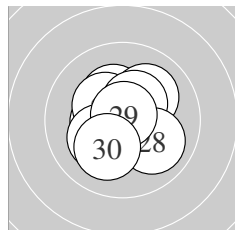

Serie 3:	10.3 *	10.1 ↗	10.4 *	10.3 *	10.7 *
	10.4 *	10.2 *	10.0 ↘	10.8 *	10.1 ↗
beste Teiler	36.8	(29.) 72.1 (25.)	131.4 (23.)		
Trefferlage	0.05 mm	links, 0.09 mm	hoch		
Streuwert	1.24,	horizontal: 1.26, vertikal: 1.23			

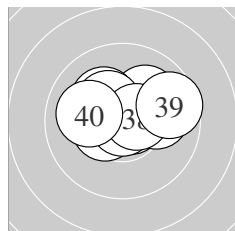

Serie 4:	10.1 ↗	10.4 *	10.7 *	10.2 *	10.9 *
	10.0 →	10.3 *	10.6 *	9.6 →	10.0 ←
beste Teiler	12.0	(35.) 52.0 (33.)	98.0 (38.)		
Trefferlage	0.27 mm	rechts, 0.57 mm	hoch		
Streuwert	1.31,	horizontal: 1.73, vertikal: 0.68			

QF – Schütze hat sich fürs Finale qualifiziert

Unterschrift des Schuetzen

Meyton Elektronik

Ergebnis: **411.2** (396)
 Serien: 102.9 102.6 103.7 102.0
 Zaehler: 36 4 0 0 0 0 0 0 0 0
 Innenzehner: 26
 weiteste: 404 (27), 305 (34), 275 (5)
 beste Teiler 26.9 (21.) 27.2 (20.) 28.2 (26.)
 Trefferlage 0.48 mm links, 0.09 mm tief
 Streuwert 1.29, horizontal: 1.41, vertikal: 1.16

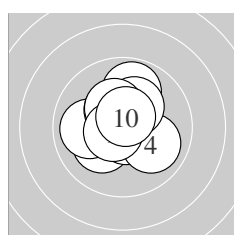
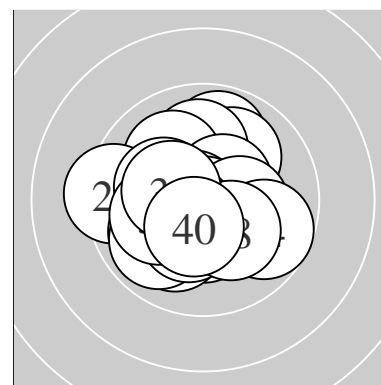

Serie 1:
 10.2 * 10.7 * 10.0 ← 10.0 → 9.9 ↑
 10.4 * 10.2 * 10.3 * 10.6 * 10.6 *
 beste Teiler 63.0 (2.) 77.3 (9.) 83.2 (10.)
 Trefferlage 0.18 mm links, 0.43 mm hoch
 Streuwert 1.31, horizontal: 1.31, vertikal: 1.31

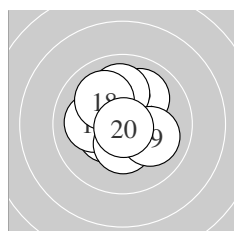

Serie 2:
 10.4 * 10.0 ↗ 10.4 * 10.4 * 10.1 ←
 10.4 * 10.0 ↑ 10.1 ↘ 10.0 → 10.8 *
 beste Teiler 27.2 (20.) 132.0 (14.) 143.9 (13.)
 Trefferlage 0.40 mm links, 0.36 mm hoch
 Streuwert 1.31, horizontal: 1.32, vertikal: 1.30

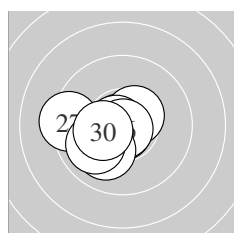

Serie 3:
 10.8 * 10.5 * 10.4 * 10.8 * 10.8 *
 10.8 * 9.3 ← 10.0 ↙ 10.0 ↘ 10.3 *
 beste Teiler 26.9 (21.) 28.2 (26.) 43.5 (25.)
 Trefferlage 0.98 mm links, 0.42 mm tief
 Streuwert 1.12, horizontal: 1.37, vertikal: 0.79

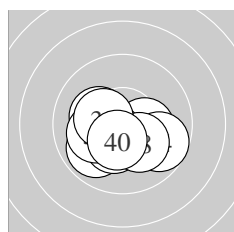

Serie 4:
 10.3 * 9.9 ↙ 10.3 * 9.7 → 10.2 *
 10.5 * 10.1 ← 10.2 * 10.4 * 10.4 *
 beste Teiler 103.2 (36.) 127.7 (40.) 150.0 (39.)
 Trefferlage 0.34 mm links, 0.77 mm tief
 Streuwert 1.31, horizontal: 1.67, vertikal: 0.81

Unterschrift des Schuetzen

Meyton Elektronik

Ergebnis: **412.7** (395)
 Serien: 103.0 104.1 103.6 102.0
 Zaehler: 35 5 0 0 0 0 0 0 0 0
 Innenzehner: 30
 weiteste: 319 (36), 304 (16), 290 (1)
 beste Teiler 56.3 (20.) 70.2 (14.) 73.5 (28.)
 Trefferlage 0.12 mm links, 0.01 mm hoch
 Streuwert 1.24, horizontal: 1.41, vertikal: 1.05

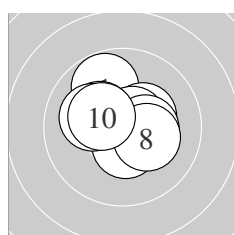
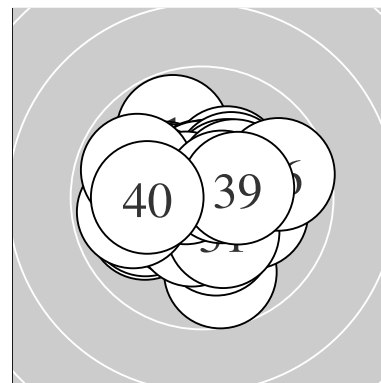

Serie 1:
 9.8 ↖ 10.3 * 10.6 * 10.5 * 10.3 *
 10.5 * 10.3 * 10.3 * 10.1 ↗ 10.3 *
 beste Teiler 80.2 (3.) 101.0 (4.) 118.6 (6.)
 Trefferlage 0.01 mm rechts, 0.37 mm hoch
 Streuwert 1.24, horizontal: 1.40, vertikal: 1.05

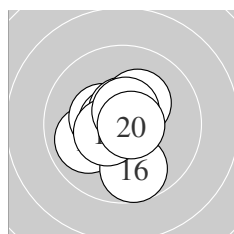

Serie 2:
 10.6 * 10.0 ↖ 10.4 * 10.7 * 10.6 *
 9.7 ↓ 10.5 * 10.3 * 10.6 * 10.7 *
 beste Teiler 56.3 (20.) 70.2 (14.) 88.0 (15.)
 Trefferlage 0.34 mm links, 0.15 mm tief
 Streuwert 1.15, horizontal: 1.03, vertikal: 1.25

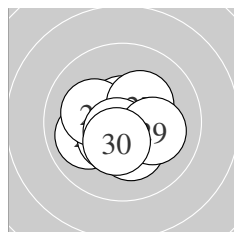

Serie 3:
 10.5 * 10.6 * 10.0 ↖ 10.3 * 10.5 *
 10.2 * 10.3 * 10.7 * 10.1 ↗ 10.4 *
 beste Teiler 73.5 (28.) 83.1 (22.) 125.0 (25.)
 Trefferlage 0.18 mm links, 0.46 mm tief
 Streuwert 1.14, horizontal: 1.28, vertikal: 0.99

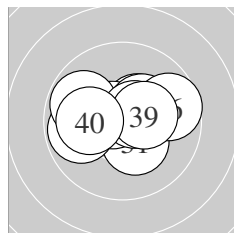

Serie 4:
 10.3 * 10.4 * 9.8 ↖ 10.6 * 10.3 *
 9.7 → 9.8 ↖ 10.6 * 10.4 * 10.1 ←
 beste Teiler 76.3 (34.) 90.4 (38.) 133.0 (32.)
 Trefferlage 0.01 mm rechts, 0.31 mm hoch
 Streuwert 1.49, horizontal: 1.97, vertikal: 0.77

Unterschrift des Schuetzen

Meyton Elektronik

Ergebnis: **411.6** (392)
 Serien: 102.5 102.0 103.1 104.0
 Zaehler: 32 8 0 0 0 0 0 0 0 0
 Innenzehner: 25
 weiteste: 318 (2), 313 (15), 310 (1)
 beste Teiler 8.0 (32.) 31.9 (26.) 35.7 (19.)
 Trefferlage 0.03 mm rechts, 0.01 mm tief
 Streuwert 1.32, horizontal: 1.59, vertikal: 0.99

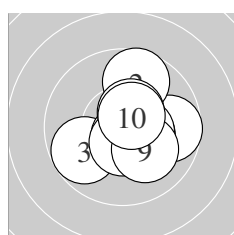
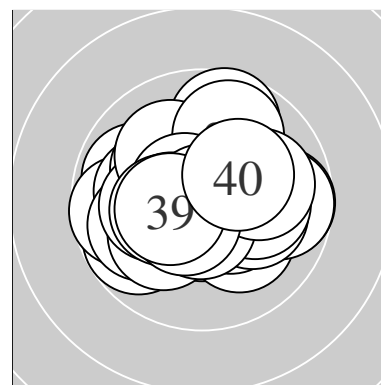

Serie 1:
 9.7 → 9.7 ↑ 9.8 ↙ 10.4 * 10.7 *
 10.5 * 10.5 * 10.5 * 10.1 ↘ 10.6 *
 beste Teiler 62.1 (5.) 96.8 (10.) 102.0 (8.)
 Trefferlage 0.67 mm rechts, 0.07 mm tief
 Streuwert 1.41, horizontal: 1.43, vertikal: 1.38

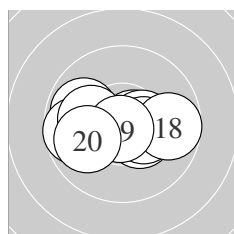

Serie 2:
 9.9 ↖ 10.7 * 10.4 * 10.4 * 9.7 ←
 10.1 ← 10.4 * 9.7 → 10.8 * 9.9 ←
 beste Teiler 35.7 (19.) 72.1 (12.) 129.0 (14.)
 Trefferlage 0.27 mm links, 0.17 mm tief
 Streuwert 1.55, horizontal: 2.12, vertikal: 0.53

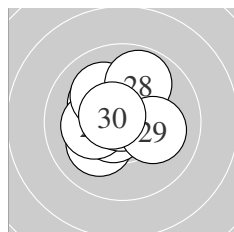

Serie 3:
 10.1 ↙ 10.6 * 10.2 * 10.2 * 10.6 *
 10.8 * 10.1 ↘ 9.8 ↑ 10.1 → 10.6 *
 beste Teiler 31.9 (26.) 77.8 (22.) 80.5 (25.)
 Trefferlage 0.38 mm links, 0.40 mm hoch
 Streuwert 1.23, horizontal: 1.29, vertikal: 1.17

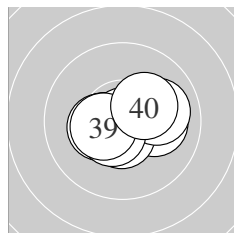

Serie 4:
 10.4 * 10.9 * 10.1 → 10.6 * 10.6 *
 10.3 * 10.0 → 10.5 * 10.4 * 10.2 *
 beste Teiler 8.0 (32.) 80.3 (34.) 94.1 (35.)
 Trefferlage 0.11 mm rechts, 0.21 mm tief
 Streuwert 1.08, horizontal: 1.40, vertikal: 0.63

Unterschrift des Schuetzen

ISSF AR Women – Wertung – Juniorinnen

StartNr: 42

StandNr: 142

21. Januar 2017 9:38

Stark, Franziska #70804597

Switzerland

Ergebnis: **400.4** (382)
 Serien: 99.4 102.4 98.8 99.8
 Zaehler: 25 12 3 0 0 0 0 0 0 0
 Innenzehner: 16
 weiteste: 599 (25), 520 (40), 508 (4)
 beste Teiler 40.0 (13.) 42.1 (10.) 77.8 (11.)
 Trefferlage 0.25 mm rechts, 0.06 mm hoch
 Streuwert 1.90, horizontal: 2.19, vertikal: 1.56

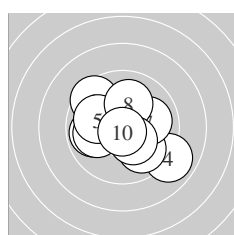
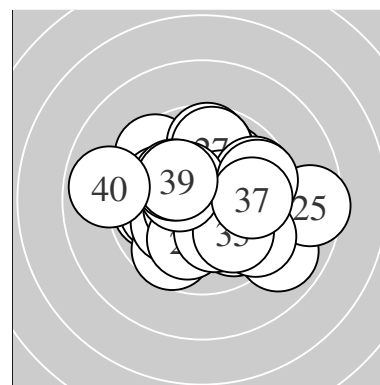

Serie 1:
 9.9 ← 10.0 ← 9.5 ↘ 8.9 ↘ 10.0 ↖
 9.9 ↘ 10.0 → 10.1 ↑ 10.3 * 10.8 *
 beste Teiler 42.1 (10.) 156.6 (9.) 222.8 (8.)
 Trefferlage 0.01 mm links, 0.15 mm tief
 Streuwert 2.08, horizontal: 2.41, vertikal: 1.69

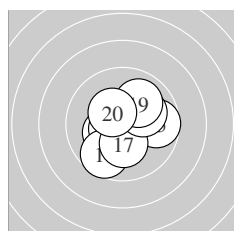

Serie 2:
 10.6 * 10.3 * 10.8 * 10.6 * 9.7 →
 9.7 ↙ 10.2 * 10.1 ↗ 10.0 ↗ 10.4 *
 beste Teiler 40.0 (13.) 77.8 (11.) 99.3 (14.)
 Trefferlage 0.08 mm rechts, 0.23 mm tief
 Streuwert 1.49, horizontal: 1.58, vertikal: 1.39

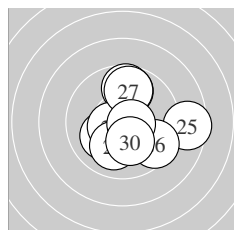

Serie 3:
 9.8 ↑ 10.1 ↙ 9.7 ↑ 10.5 * 8.6 →
 9.5 ↘ 9.8 ↑ 10.0 ↓ 10.6 * 10.2 *
 beste Teiler 81.0 (29.) 109.9 (24.) 189.0 (30.)
 Trefferlage 0.83 mm rechts, 0.08 mm hoch
 Streuwert 2.17, horizontal: 2.22, vertikal: 2.12

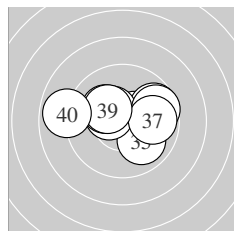

Serie 4:
 10.5 * 9.7 → 10.4 * 9.7 → 10.0 ↘
 10.4 * 9.8 → 10.2 * 10.2 * 8.9 ←
 beste Teiler 118.1 (31.) 134.6 (36.) 136.4 (33.)
 Trefferlage 0.11 mm rechts, 0.56 mm hoch
 Streuwert 1.97, horizontal: 2.64, vertikal: 0.90

Unterschrift des Schuetzen

Meyton Elektronik

Ergebnis: **412.7** (393)^{QF}
 Serien: 102.8 104.7 102.0 103.2
 Zaehler: 33 7 0 0 0 0 0 0 0 0
 Innenzehner: 29
 weiteste: 433 (26), 349 (7), 348 (37)
 beste Teiler 29.1 (6.) 40.3 (40.) 48.7 (34.)
 Trefferlage 0.20 mm rechts, 0.00 mm
 Streuwert 1.32, horizontal: 1.52, vertikal: 1.09

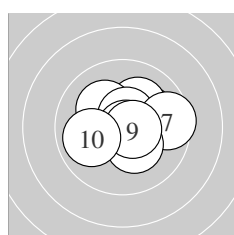
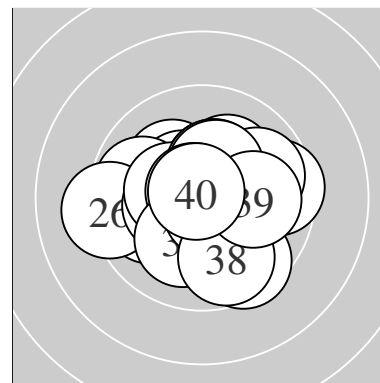

Serie 1:
 10.1 → 10.5 * 10.2 * 10.2 * 10.6 *
 10.8 * 9.6 → 10.3 * 10.6 * 9.9 ←
 beste Teiler 29.1 (6.) 79.8 (9.) 91.4 (5.)
 Trefferlage 0.57 mm rechts, 0.23 mm hoch
 Streuwert 1.34, horizontal: 1.60, vertikal: 1.00

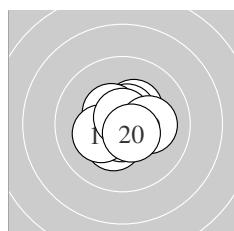

Serie 2:
 10.5 * 10.3 * 10.7 * 10.4 * 10.6 *
 10.5 * 10.2 * 10.7 * 10.2 * 10.6 *
 beste Teiler 53.0 (18.) 67.6 (13.) 93.4 (15.)
 Trefferlage 0.15 mm rechts, 0.04 mm hoch
 Streuwert 0.97, horizontal: 1.06, vertikal: 0.88

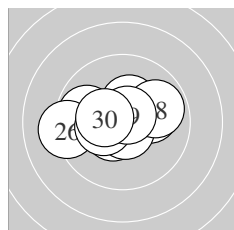

Serie 3:
 10.1 → 9.8 ← 10.4 * 10.5 * 10.7 *
 9.2 ← 10.3 * 9.9 → 10.7 * 10.4 *
 beste Teiler 64.8 (29.) 67.6 (25.) 106.7 (24.)
 Trefferlage 0.49 mm links, 0.22 mm hoch
 Streuwert 1.58, horizontal: 2.10, vertikal: 0.76

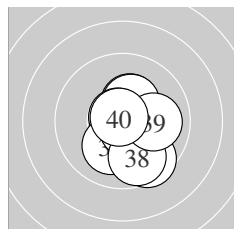

Serie 4:
 10.3 * 10.3 * 10.8 * 10.8 * 10.1 ↙
 10.7 * 9.6 ↘ 9.8 ↘ 10.0 → 10.8 *
 beste Teiler 40.3 (40.) 48.7 (34.) 49.8 (33.)
 Trefferlage 0.58 mm rechts, 0.51 mm tief
 Streuwert 1.31, horizontal: 1.01, vertikal: 1.55

QF – Schütze hat sich fürs Finale qualifiziert

Unterschrift des Schuetzen

Meyton Elektronik

Ergebnis: **390.4** (373)
 Serien: 99.6 97.8 96.4 96.6
 Zaehler: 19 16 4 1 0 0 0 0 0 0
 Innenzehner: 13
 weiteste: 855 (22), 654 (13), 596 (40)
 beste Teiler 40.6 (18.) 70.0 (17.) 88.2 (29.)
 Trefferlage 0.47 mm links, 0.68 mm tief
 Streuwert 2.39, horizontal: 2.94, vertikal: 1.67

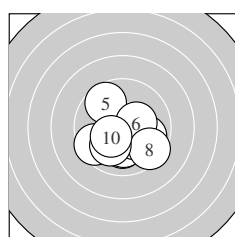
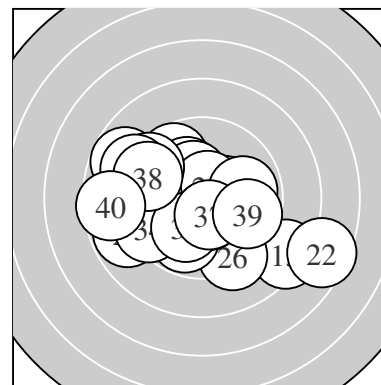

Serie 1:
 10.1 ↓ 9.9 → 10.1 ↓ 10.2 * 9.7 ↖
 10.3 * 9.5 ↙ 9.5 ↘ 10.0 ✓ 10.3 *
 beste Teiler 155.5 (6.) 160.0 (10.) 186.0 (4.)
 Trefferlage 0.09 mm rechts, 1.06 mm tief
 Streuwert 1.76, horizontal: 1.96, vertikal: 1.54

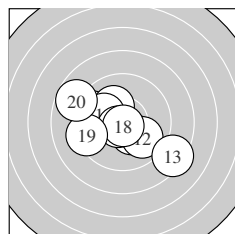

Serie 2:
 10.3 * 9.9 ↘ 8.3 ↘ 9.5 ↖ 10.2 *
 10.1 ↖ 10.7 * 10.8 * 9.3 ↙ 8.7 ↖
 beste Teiler 40.6 (18.) 70.0 (17.) 159.4 (11.)
 Trefferlage 0.71 mm links, 0.27 mm tief
 Streuwert 2.54, horizontal: 3.10, vertikal: 1.82

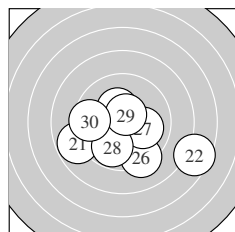

Serie 3:
 8.8 ↙ 7.5 → 10.3 * 10.3 * 10.3 *
 9.3 ↓ 10.0 → 9.8 ↓ 10.6 * 9.5 ←
 beste Teiler 88.2 (29.) 156.3 (24.) 166.8 (25.)
 Trefferlage 0.24 mm rechts, 1.19 mm tief
 Streuwert 2.79, horizontal: 3.51, vertikal: 1.79

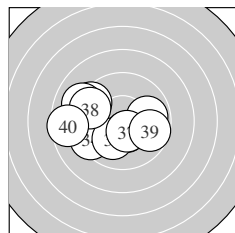

Serie 4:
 9.4 ↖ 9.9 → 9.1 ↖ 9.4 ↙ 10.5 *
 10.1 ✓ 10.5 * 9.4 ↖ 9.7 → 8.6 ←
 beste Teiler 119.2 (37.) 122.0 (35.) 218.4 (36.)
 Trefferlage 1.53 mm links, 0.19 mm tief
 Streuwert 2.41, horizontal: 3.06, vertikal: 1.51

Unterschrift des Schuetzen

Meyton Elektronik

Ergebnis: **407.1** (391)
 Serien: 100.0 102.3 101.7 103.1
 Zaehler: 32 7 1 0 0 0 0 0 0 0
 Innenzehner: 28
 weiteste: 600 (8), 462 (30), 382 (33)
 beste Teiler 26.0 (31.) 53.4 (36.) 72.8 (27.)
 Trefferlage 0.19 mm links, 0.55 mm hoch
 Streuwert 1.53, horizontal: 1.83, vertikal: 1.16

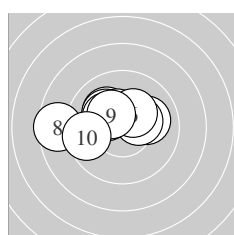
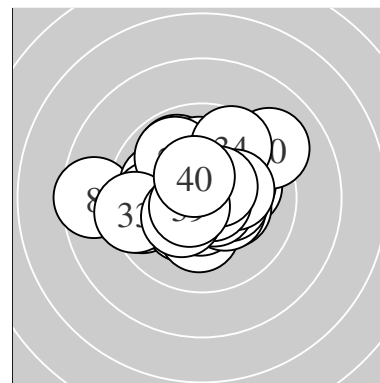

Serie 1:
 10.0 → 10.1 ↖ 10.4 * 10.3 * 10.2 *
 10.3 * 10.2 * 8.6 ← 10.3 * 9.6 ←
 beste Teiler 138.7 (3.) 158.5 (4.) 158.6 (9.)
 Trefferlage 1.07 mm links, 0.79 mm hoch
 Streuwert 1.77, horizontal: 2.40, vertikal: 0.72

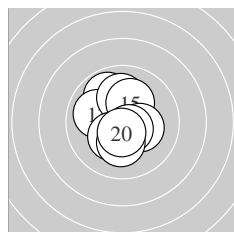

Serie 2:
 10.2 * 9.9 ↖ 10.0 ↖ 10.0 ↑ 10.2 *
 10.3 * 10.6 * 10.3 * 10.2 * 10.6 *
 beste Teiler 86.3 (17.) 96.5 (20.) 165.0 (18.)
 Trefferlage 0.26 mm links, 0.36 mm hoch
 Streuwert 1.38, horizontal: 1.12, vertikal: 1.61

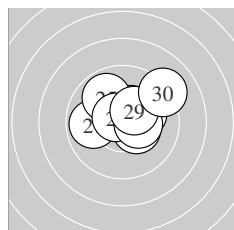

Serie 3:
 9.9 ← 10.4 * 10.4 * 10.2 * 9.9 ↖
 10.4 * 10.7 * 10.4 * 10.3 * 9.1 ↗
 beste Teiler 72.8 (27.) 137.0 (23.) 137.1 (22.)
 Trefferlage 0.63 mm rechts, 0.83 mm hoch
 Streuwert 1.49, horizontal: 1.81, vertikal: 1.07

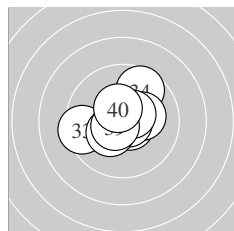

Serie 4:
 10.8 * 10.6 * 9.4 ← 9.6 ↗ 10.2 *
 10.7 * 10.5 * 10.3 * 10.6 * 10.4 *
 beste Teiler 26.0 (31.) 53.4 (36.) 79.8 (32.)
 Trefferlage 0.08 mm links, 0.23 mm hoch
 Streuwert 1.39, horizontal: 1.60, vertikal: 1.14

Unterschrift des Schuetzen

Ergebnis: **405.6** (387)
 Serien: 100.7 102.2 101.9 100.8
 Zaehler: 28 11 1 0 0 0 0 0 0 0
 Innenzehner: 22
 weiteste: 554 (17), 455 (5), 440 (32)
 beste Teiler 34.9 (27.) 49.0 (28.) 53.6 (20.)
 Trefferlage 0.15 mm links, 0.13 mm tief
 Streuwert 1.68, horizontal: 1.72, vertikal: 1.63

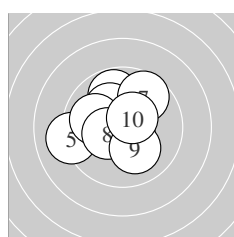
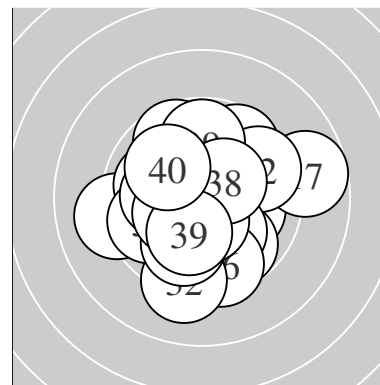

Serie 1:
 9.8 ↑ 10.2 * 10.2 * 10.7 * 9.1 ←
 10.0 ← 9.7 ↗ 10.4 * 10.1 ↘ 10.5 *
 beste Teiler 65.8 (4.) 116.6 (10.) 142.0 (8.)
 Trefferlage 0.71 mm links, 0.59 mm hoch
 Streuwert 1.70, horizontal: 1.87, vertikal: 1.52

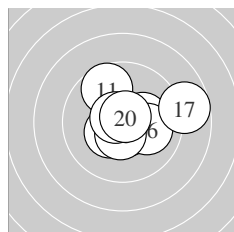

Serie 2:
 9.7 ↖ 10.2 * 10.4 * 10.6 * 10.6 *
 10.1 → 8.7 → 10.5 * 10.7 * 10.7 *
 beste Teiler 53.6 (20.) 72.9 (19.) 76.4 (14.)
 Trefferlage 0.68 mm rechts, 0.13 mm hoch
 Streuwert 1.66, horizontal: 2.00, vertikal: 1.23

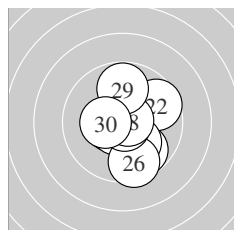

Serie 3:
 9.8 ↘ 9.6 ↗ 10.1 ↘ 10.5 * 10.6 *
 9.5 ↓ 10.8 * 10.8 * 9.8 ↑ 10.4 *
 beste Teiler 34.9 (27.) 49.0 (28.) 83.6 (25.)
 Trefferlage 0.43 mm rechts, 0.43 mm tief
 Streuwert 1.60, horizontal: 1.33, vertikal: 1.83

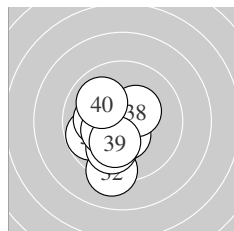

Serie 4:
 10.4 * 9.2 ↓ 9.8 ← 10.5 * 9.9 ↙
 10.1 ← 10.3 * 10.4 * 10.2 * 10.0 ↖
 beste Teiler 119.0 (34.) 131.8 (31.) 143.4 (38.)
 Trefferlage 1.02 mm links, 0.82 mm tief
 Streuwert 1.47, horizontal: 1.11, vertikal: 1.76

Unterschrift des Schuetzen

Meyton Elektronik

Ergebnis: **400.8** (380)
 Serien: 99.5 100.2 100.3 100.8
 Zaehler: 21 18 1 0 0 0 0 0 0 0
 Innenzehner: 20
 weiteste: 603 (10), 472 (16), 460 (14)
 beste Teiler 41.0 (37.) 53.4 (33.) 71.0 (2.)
 Trefferlage 0.27 mm rechts, 0.21 mm hoch
 Streuwert 1.89, horizontal: 2.06, vertikal: 1.69

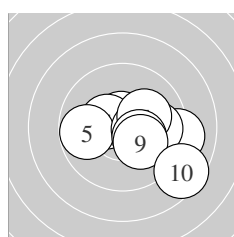
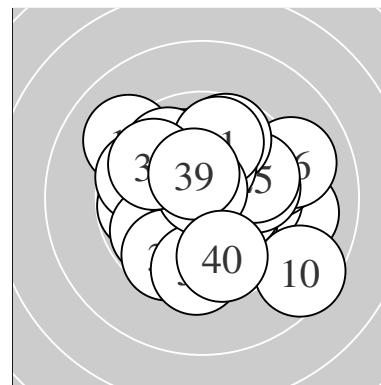

Serie 1:
 9.1 → 10.7 * 9.9 → 10.4 * 9.8 ←
 10.4 * 10.2 * 10.3 * 10.2 * 8.5 ↘
 beste Teiler 71.0 (2.) 131.9 (6.) 135.0 (4.)
 Trefferlage 1.36 mm rechts, 0.49 mm tief
 Streuwert 1.92, horizontal: 2.39, vertikal: 1.29

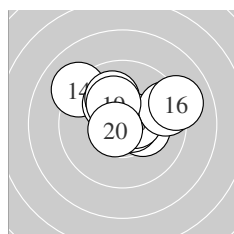

Serie 2:
 10.3 * 10.7 * 10.5 * 9.1 ↖ 9.4 →
 9.1 → 10.2 * 10.0 ↘ 10.2 * 10.7 *
 beste Teiler 71.3 (12.) 75.2 (20.) 104.0 (13.)
 Trefferlage 0.44 mm rechts, 1.06 mm hoch
 Streuwert 1.86, horizontal: 2.36, vertikal: 1.15

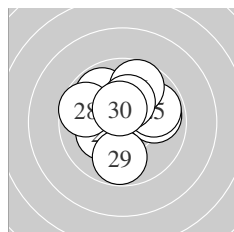

Serie 3:
 10.6 * 10.2 * 9.9 → 9.8 ↖ 9.8 →
 9.7 ↑ 10.3 * 9.7 ← 9.8 ↓ 10.5 *
 beste Teiler 89.0 (21.) 114.5 (30.) 170.7 (27.)
 Trefferlage 0.08 mm links, 0.64 mm hoch
 Streuwert 1.75, horizontal: 1.83, vertikal: 1.65

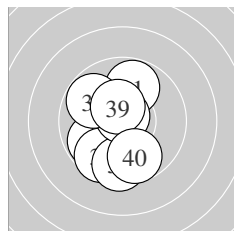

Serie 4:
 9.8 ↑ 9.8 ↙ 10.7 * 10.6 * 9.6 ↙
 9.5 ↓ 10.8 * 9.8 ↖ 10.5 * 9.7 ↓
 beste Teiler 41.0 (37.) 53.4 (33.) 98.3 (34.)
 Trefferlage 0.63 mm links, 0.36 mm tief
 Streuwert 1.75, horizontal: 1.17, vertikal: 2.17

Unterschrift des Schuetzen

Ergebnis: **404.2** (381)
 Serien: 100.2 103.3 100.3 100.4
 Zaehler: 22 17 1 0 0 0 0 0 0 0
 Innenzehner: 20
 weiteste: 676 (10), 476 (31), 400 (27)
 beste Teiler 42.4 (36.) 48.5 (26.) 58.0 (16.)
 Trefferlage 0.43 mm links, 0.48 mm hoch
 Streuwert 1.73, horizontal: 2.21, vertikal: 1.05

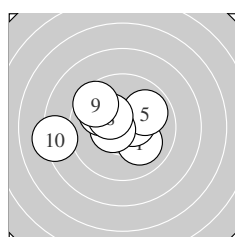
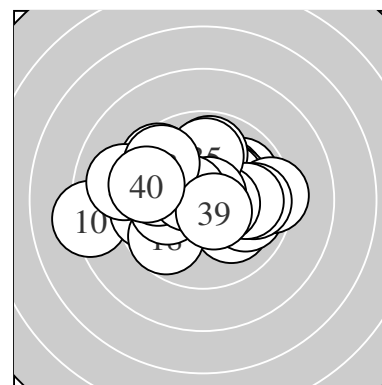

Serie 1:
 10.1 ↘ 10.5 * 10.5 * 10.6 * 9.9 ↗
 10.6 * 9.9 ↖ 10.3 * 9.6 ↖ 8.2 ←
 beste Teiler 92.1 (4.) 100.1 (6.) 105.0 (3.)
 Trefferlage 1.03 mm links, 0.50 mm hoch
 Streuwert 1.97, horizontal: 2.53, vertikal: 1.17

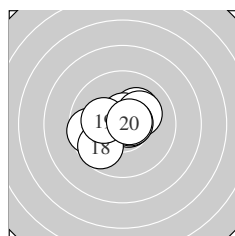

Serie 2:
 10.2 * 10.7 * 9.6 ← 10.6 * 10.2 *
 10.7 * 10.7 * 9.7 ↗ 10.2 * 10.7 *
 beste Teiler 58.0 (16.) 64.8 (12.) 69.8 (20.)
 Trefferlage 0.27 mm links, 0.13 mm hoch
 Streuwert 1.35, horizontal: 1.64, vertikal: 0.98

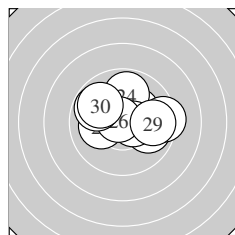

Serie 3:
 10.2 * 10.1 ← 9.9 → 9.9 ↑ 10.5 *
 10.8 * 9.4 → 9.8 ↖ 9.8 → 9.9 ↖
 beste Teiler 48.5 (26.) 105.5 (25.) 176.8 (21.)
 Trefferlage 0.50 mm rechts, 0.59 mm hoch
 Streuwert 1.80, horizontal: 2.30, vertikal: 1.09

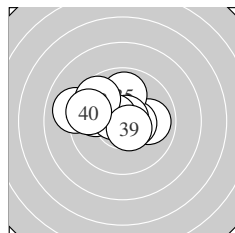

Serie 4:
 9.0 ← 9.9 ← 9.9 → 10.5 * 9.9 ↑
 10.8 * 10.6 * 9.6 ↖ 10.6 * 9.6 ←
 beste Teiler 42.4 (36.) 93.3 (39.) 96.1 (37.)
 Trefferlage 0.92 mm links, 0.71 mm hoch
 Streuwert 1.76, horizontal: 2.27, vertikal: 1.02

Unterschrift des Schuetzen

Ergebnis: **410.7** (393)
 Serien: 103.3 102.8 103.3 101.3
 Zaehler: 34 5 1 0 0 0 0 0 0 0
 Innenzehner: 25
 weiteste: 533 (32), 308 (21), 273 (12)
 beste Teiler 43.0 (40.) 48.6 (25.) 51.4 (29.)
 Trefferlage 0.26 mm links, 0.03 mm hoch
 Streuwert 1.37, horizontal: 1.43, vertikal: 1.31

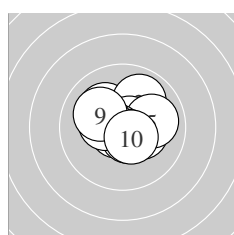
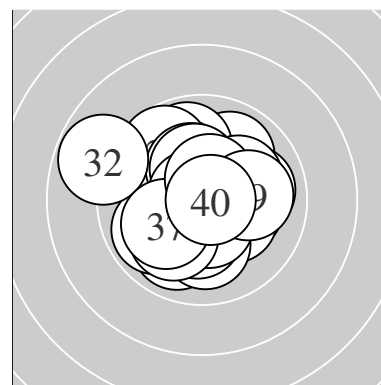

Serie 1:
 10.1 ↖ 9.9 ↗ 10.7 * 10.3 * 10.0 →
 10.7 * 10.6 * 10.4 * 10.1 ↖ 10.5 *
 beste Teiler 58.2 (6.) 66.3 (3.) 87.8 (7.)
 Trefferlage 0.18 mm rechts, 0.35 mm hoch
 Streuwert 1.23, horizontal: 1.44, vertikal: 0.99

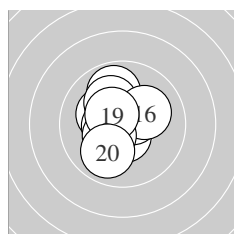

Serie 2:
 10.6 * 9.9 ↖ 10.6 * 10.2 * 10.1 ↖
 10.1 ↗ 10.5 * 10.4 * 10.5 * 9.9 ↙
 beste Teiler 96.1 (11.) 98.4 (13.) 118.7 (17.)
 Trefferlage 0.50 mm links, 0.33 mm hoch
 Streuwert 1.27, horizontal: 1.09, vertikal: 1.43

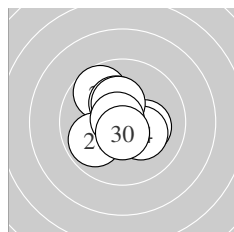

Serie 3:
 9.7 ↖ 10.2 * 10.6 * 10.2 * 10.8 *
 10.3 * 9.9 ↙ 10.3 * 10.7 * 10.6 *
 beste Teiler 48.6 (25.) 51.4 (29.) 84.3 (23.)
 Trefferlage 0.27 mm links, 0.12 mm hoch
 Streuwert 1.29, horizontal: 1.27, vertikal: 1.31

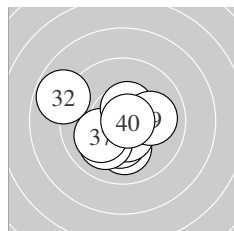

Serie 4:
 10.2 * 8.8 ↖ 10.1 ↓ 10.3 * 10.5 *
 10.0 ↙ 10.1 ↙ 10.5 * 10.0 → 10.8 *
 beste Teiler 43.0 (40.) 111.0 (38.) 119.9 (35.)
 Trefferlage 0.47 mm links, 0.65 mm tief
 Streuwert 1.68, horizontal: 1.92, vertikal: 1.40

Unterschrift des Schuetzen

Meyton Elektronik