

Ergebnis: **402.1** (383)
 Serien: 101.7 101.4 98.8 100.2
 Zaehler: 25 14 0 1 0 0 0 0 0 0
 Innenzehner: 22
 weiteste: 890 (30), 457 (19), 423 (6)
 beste Teiler 15.2 (28.) 37.7 (12.) 78.1 (37.)
 Trefferlage 0.03 mm rechts, 0.24 mm hoch
 Streuwert 1.95, horizontal: 2.38, vertikal: 1.40

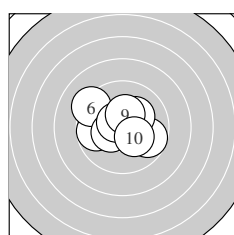

Serie 1:
 9.7 ↘ 10.5 * 10.6 * 9.7 ← 10.2 *
 9.3 ↙ 10.4 * 10.6 * 10.4 * 10.3 *
 beste Teiler 89.8 (8.) 95.1 (3.) 108.2 (2.)
 Trefferlage 0.11 mm links, 0.10 mm hoch
 Streuwert 1.66, horizontal: 2.02, vertikal: 1.20

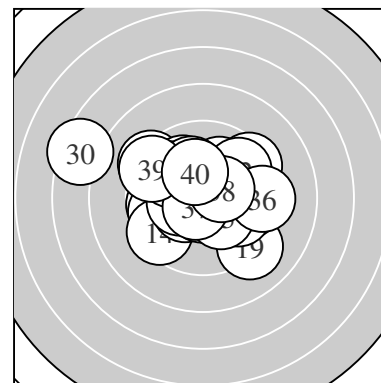
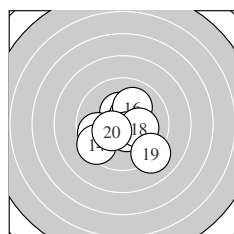

Serie 2:
 10.4 * 10.8 * 9.8 ← 9.5 ↗ 10.5 *
 10.1 ↗ 10.6 * 10.2 * 9.1 ↘ 10.4 *
 beste Teiler 37.7 (12.) 97.5 (17.) 125.6 (15.)
 Trefferlage 0.02 mm links, 0.46 mm tief
 Streuwert 1.78, horizontal: 1.94, vertikal: 1.60

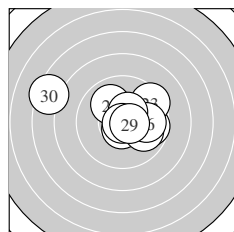

Serie 3:
 9.7 → 10.6 * 9.4 ↗ 10.0 ↘ 9.9 ↘
 9.9 → 10.4 * 10.9 * 10.6 * 7.4 ←
 beste Teiler 15.2 (28.) 78.9 (22.) 80.6 (29.)
 Trefferlage 0.27 mm rechts, 0.58 mm hoch
 Streuwert 2.61, horizontal: 3.40, vertikal: 1.43

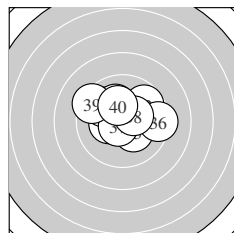

Serie 4:
 10.3 * 9.7 ↗ 9.9 ↘ 10.1 ↖ 10.3 *
 9.3 → 10.6 * 10.4 * 9.4 ↘ 10.2 *
 beste Teiler 78.1 (37.) 138.6 (38.) 161.0 (31.)
 Trefferlage 0.01 mm links, 0.75 mm hoch
 Streuwert 1.81, horizontal: 2.25, vertikal: 1.22

Unterschrift des Schuetzen

Meyton Elektronik

Ergebnis: **410.6** (395)
 Serien: 103.7 102.6 102.1 102.2
 Zaehler: 35 5 0 0 0 0 0 0 0 0
 Innenzehner: 27
 weiteste: 328 (35), 306 (13), 280 (29)
 beste Teiler 45.2 (5.) 64.3 (11.) 81.8 (10.)
 Trefferlage 0.30 mm links, 0.03 mm tief
 Streuwert 1.30, horizontal: 1.30, vertikal: 1.30

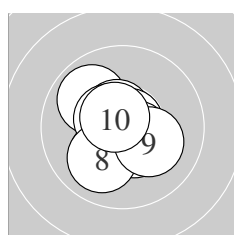
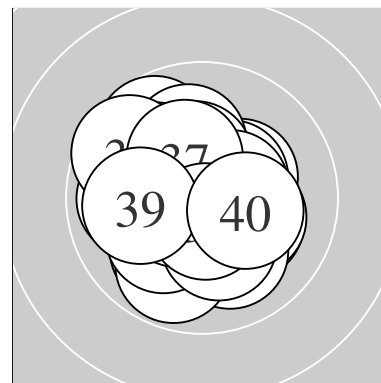

Serie 1:
 9.9 ↘ 10.6 * 10.1 ✓ 10.5 * 10.8 *
 10.5 * 10.5 * 10.0 ✓ 10.2 * 10.6 *
 beste Teiler 45.2 (5.) 81.8 (10.) 89.5 (2.)
 Trefferlage 0.25 mm links, 0.22 mm tief
 Streuwert 1.18, horizontal: 1.15, vertikal: 1.22

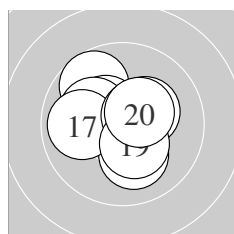

Serie 2:
 10.7 * 10.1 ↓ 9.7 ↘ 10.3 * 10.4 *
 10.2 * 9.9 ← 10.5 * 10.4 * 10.4 *
 beste Teiler 64.3 (11.) 102.6 (18.) 132.0 (20.)
 Trefferlage 0.20 mm links, 0.34 mm hoch
 Streuwert 1.35, horizontal: 1.48, vertikal: 1.22

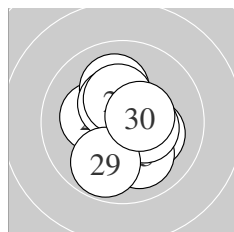

Serie 3:
 10.2 * 10.2 * 10.0 ↓ 10.4 * 10.2 *
 10.1 ↑ 10.4 * 10.3 * 9.8 ✓ 10.5 *
 beste Teiler 117.0 (30.) 135.5 (27.) 144.1 (24.)
 Trefferlage 0.06 mm rechts, 0.21 mm tief
 Streuwert 1.42, horizontal: 1.19, vertikal: 1.61

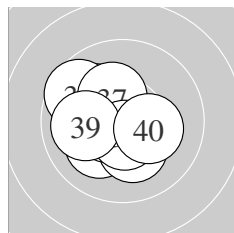

Serie 4:
 10.1 ✓ 10.2 * 10.5 * 10.0 ↘ 9.6 ↘
 10.6 * 10.3 * 10.6 * 10.0 ← 10.3 *
 beste Teiler 86.3 (36.) 92.0 (38.) 102.9 (33.)
 Trefferlage 0.84 mm links, 0.02 mm tief
 Streuwert 1.31, horizontal: 1.37, vertikal: 1.24

Unterschrift des Schuetzen

Meyton Elektronik

Ergebnis: **408.6** (390)
 Serien: 100.5 102.7 102.4 103.0
 Zaehler: 30 10 0 0 0 0 0 0 0 0
 Innenzehner: 24
 weiteste: 400 (5), 388 (18), 351 (14)
 beste Teiler 16.5 (16.) 22.4 (17.) 26.6 (23.)
 Trefferlage 0.05 mm links, 0.46 mm hoch
 Streuwert 1.47, horizontal: 1.62, vertikal: 1.30

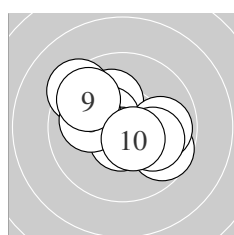
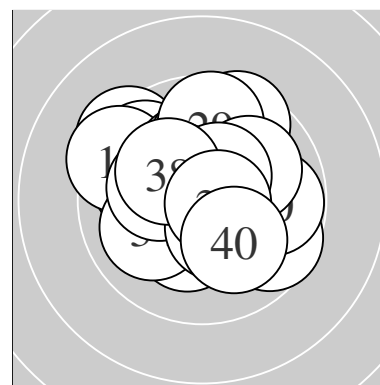

Serie 1:
 9.7 ↘ 10.2 * 10.5 * 9.9 → 9.4 ↖
 10.6 * 10.0 ↘ 10.0 ← 9.7 ↖ 10.5 *
 beste Teiler 84.8 (6.) 110.4 (10.) 122.1 (3.)
 Trefferlage 0.13 mm links, 0.33 mm hoch
 Streuwert 1.81, horizontal: 2.15, vertikal: 1.40

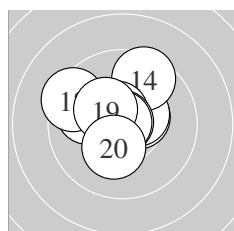

Serie 2:
 10.5 * 10.4 * 9.9 ↖ 9.5 ↗ 10.6 *
 10.9 * 10.9 * 9.4 ↖ 10.3 * 10.3 *
 beste Teiler 16.5 (16.) 22.4 (17.) 89.9 (15.)
 Trefferlage 0.47 mm links, 0.74 mm hoch
 Streuwert 1.41, horizontal: 1.57, vertikal: 1.22

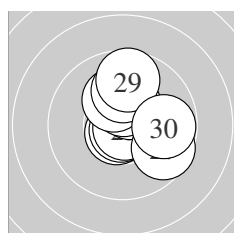

Serie 3:
 10.7 * 10.8 * 10.8 * 10.4 * 10.4 *
 10.2 * 9.6 ↘ 10.0 ↑ 9.7 ↑ 9.8 →
 beste Teiler 26.6 (23.) 37.6 (22.) 68.4 (21.)
 Trefferlage 0.58 mm rechts, 0.71 mm hoch
 Streuwert 1.39, horizontal: 1.26, vertikal: 1.51

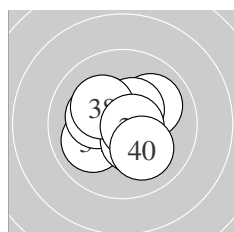

Serie 4:
 10.0 ↗ 10.3 * 10.6 * 10.0 ← 10.2 *
 10.4 * 10.5 * 10.2 * 10.7 * 10.1 ↘
 beste Teiler 68.6 (39.) 92.8 (33.) 123.1 (37.)
 Trefferlage 0.19 mm links, 0.06 mm hoch
 Streuwert 1.28, horizontal: 1.43, vertikal: 1.12

Unterschrift des Schuetzen

Meyton Elektronik

Ergebnis: **405.0** (384)
 Serien: 98.0 103.2 100.6 103.2
 Zaehler: 26 12 2 0 0 0 0 0 0 0
 Innenzehner: 22
 weiteste: 609 (28), 530 (3), 460 (6)
 beste Teiler 16.1 (15.) 31.1 (21.) 48.3 (12.)
 Trefferlage 0.84 mm links, 0.22 mm hoch
 Streuwert 1.67, horizontal: 1.89, vertikal: 1.41

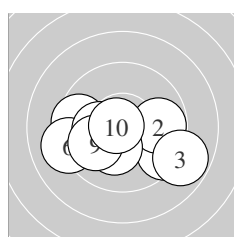
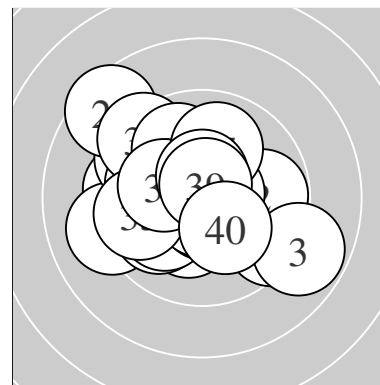

Serie 1:
 9.4 ↘ 9.8 → 8.8 ↘ 10.3 * 9.5 ←
 9.1 ← 10.3 * 10.2 * 9.9 ↙ 10.7 *
 beste Teiler 52.3 (10.) 154.0 (4.) 175.4 (7.)
 Trefferlage 0.30 mm links, 0.96 mm tief
 Streuwert 2.25, horizontal: 3.02, vertikal: 1.01

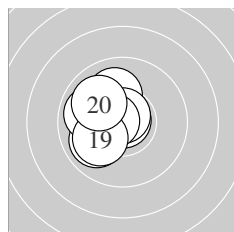

Serie 2:
 9.9 ↙ 10.8 * 10.1 ↑ 10.2 * 10.9 *
 10.7 * 9.9 ← 10.6 * 10.1 ↙ 10.0 ↘
 beste Teiler 16.1 (15.) 48.3 (12.) 53.0 (16.)
 Trefferlage 1.17 mm links, 0.36 mm hoch
 Streuwert 1.02, horizontal: 0.92, vertikal: 1.12

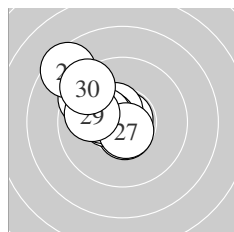

Serie 3:
 10.8 * 10.5 * 10.6 * 10.5 * 9.5 ↘
 10.3 * 10.7 * 8.5 ↘ 9.9 ← 9.3 ↘
 beste Teiler 31.1 (21.) 74.0 (27.) 81.0 (23.)
 Trefferlage 1.53 mm links, 1.00 mm hoch
 Streuwert 1.59, horizontal: 1.60, vertikal: 1.57

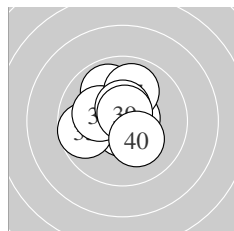

Serie 4:
 10.7 * 10.6 * 9.9 ↘ 10.7 * 9.7 ←
 10.2 * 10.0 ↑ 10.5 * 10.7 * 10.2 *
 beste Teiler 63.0 (34.) 64.8 (31.) 68.1 (39.)
 Trefferlage 0.34 mm links, 0.51 mm hoch
 Streuwert 1.28, horizontal: 1.30, vertikal: 1.26

Unterschrift des Schuetzen

Meyton Elektronik

Ergebnis: **409.7** (389)
 Serien: 101.2 101.6 103.2 103.7
 Zaehler: 29 11 0 0 0 0 0 0 0 0
 Innenzehner: 26
 weiteste: 360 (16), 356 (38), 349 (29)
 beste Teiler 40.1 (20.) 41.3 (26.) 46.0 (39.)
 Trefferlage 0.24 mm links, 0.20 mm hoch
 Streuwert 1.42, horizontal: 1.68, vertikal: 1.11

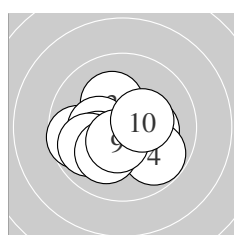
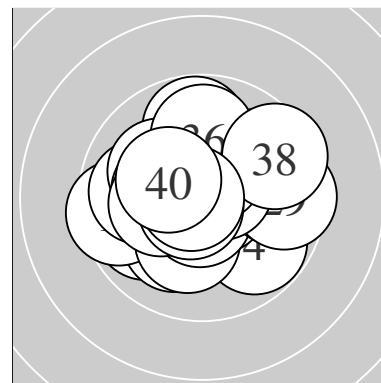

Serie 1:
 10.2 * 9.7 ← 10.2 * 9.8 ↘ 10.3 *
 10.1 ↙ 9.9 ↙ 10.1 ↗ 10.5 * 10.4 *
 beste Teiler 105.6 (9.) 147.0 (10.) 167.1 (5.)
 Trefferlage 0.58 mm links, 0.57 mm tief
 Streuwert 1.51, horizontal: 1.83, vertikal: 1.09

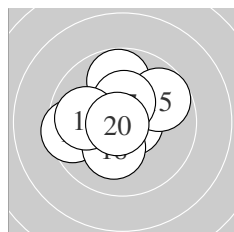

Serie 2:
 10.4 * 10.7 * 9.8 ↑ 10.2 * 9.7 ↗
 9.5 ← 10.4 * 10.2 * 9.9 ← 10.8 *
 beste Teiler 40.1 (20.) 63.3 (12.) 139.9 (11.)
 Trefferlage 0.70 mm links, 0.21 mm hoch
 Streuwert 1.56, horizontal: 1.71, vertikal: 1.38

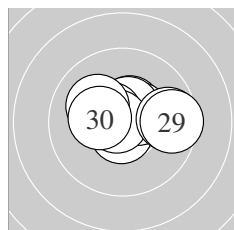

Serie 3:
 10.7 * 10.5 * 10.5 * 10.5 * 10.5 *
 10.8 * 9.7 → 10.1 ↖ 9.6 → 10.3 *
 beste Teiler 41.3 (26.) 70.5 (21.) 105.1 (24.)
 Trefferlage 0.39 mm rechts, 0.42 mm hoch
 Streuwert 1.34, horizontal: 1.80, vertikal: 0.56

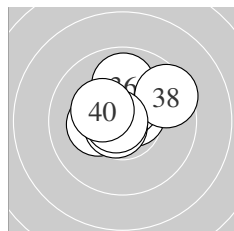

Serie 4:
 10.7 * 10.6 * 10.4 * 10.3 * 10.5 *
 9.9 ↑ 10.7 * 9.5 ↗ 10.8 * 10.3 *
 beste Teiler 46.0 (39.) 61.4 (37.) 68.4 (31.)
 Trefferlage 0.09 mm links, 0.77 mm hoch
 Streuwert 1.16, horizontal: 1.36, vertikal: 0.92

Unterschrift des Schuetzen

Meyton Elektronik

Ergebnis: **411.1** (394)
 Serien: 102.3 101.2 103.6 104.0
 Zaehler: 34 6 0 0 0 0 0 0 0 0
 Innenzehner: 26
 weiteste: 307 (7), 299 (2), 291 (16)
 beste Teiler 13.1 (35.) 40.1 (8.) 58.4 (22.)
 Trefferlage 0.23 mm rechts, 0.25 mm tief
 Streuwert 1.29, horizontal: 1.42, vertikal: 1.15

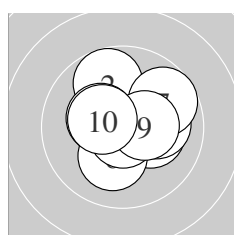
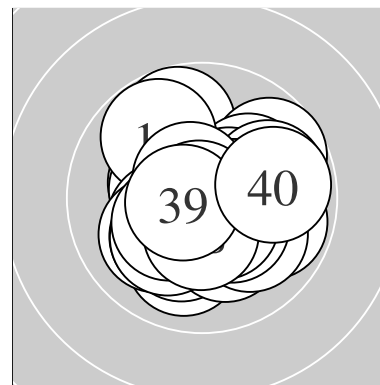

Serie 1:
 10.4 * 9.8 ↖ 10.2 * 10.3 * 10.1 →
 10.2 * 9.7 ↗ 10.8 * 10.4 * 10.4 *
 beste Teiler 40.1 (8.) 126.6 (1.) 140.2 (10.)
 Trefferlage 0.32 mm rechts, 0.43 mm hoch
 Streuwert 1.41, horizontal: 1.53, vertikal: 1.27

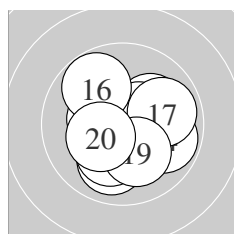

Serie 2:
 10.0 ↓ 10.1 ↗ 10.5 * 9.8 ↘ 10.4 *
 9.8 ↖ 9.9 → 10.2 * 10.2 * 10.3 *
 beste Teiler 114.9 (13.) 140.9 (15.) 163.9 (20.)
 Trefferlage 0.29 mm rechts, 0.26 mm tief
 Streuwert 1.59, horizontal: 1.68, vertikal: 1.50

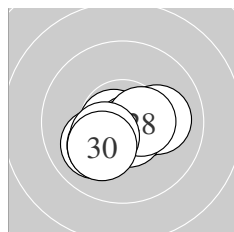

Serie 3:
 10.0 ↙ 10.7 * 10.1 ↘ 10.4 * 10.7 *
 10.1 → 10.6 * 10.5 * 10.4 * 10.1 ↙
 beste Teiler 58.4 (22.) 66.0 (25.) 77.0 (27.)
 Trefferlage 0.05 mm links, 0.64 mm tief
 Streuwert 1.09, horizontal: 1.38, vertikal: 0.67

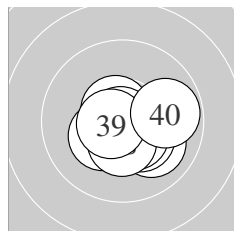

Serie 4:
 10.3 * 10.6 * 10.0 ↘ 10.6 * 10.9 *
 10.3 * 10.5 * 10.4 * 10.6 * 9.8 →
 beste Teiler 13.1 (35.) 76.1 (39.) 83.7 (32.)
 Trefferlage 0.39 mm rechts, 0.56 mm tief
 Streuwert 1.03, horizontal: 1.24, vertikal: 0.76

Unterschrift des Schuetzen

Ergebnis: **404.1** (388)
 Serien: 99.1 102.9 101.9 100.2
 Zaehler: 28 12 0 0 0 0 0 0 0 0
 Innenzehner: 21
 weiteste: 471 (7), 462 (8), 439 (18)
 beste Teiler 46.6 (19.) 47.0 (33.) 49.6 (11.)
 Trefferlage 0.18 mm rechts, 0.03 mm tief
 Streuwert 1.72, horizontal: 1.79, vertikal: 1.66

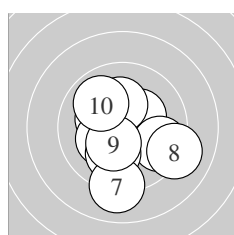
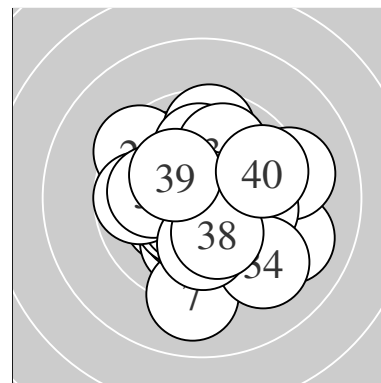

Serie 1:
 10.3 * 10.3 * 9.6 ↘ 10.2 * 10.2 *
 10.0 ↓ 9.1 ↓ 9.1 ↘ 10.4 * 9.9 ↘
 beste Teiler 149.5 (9.) 156.4 (2.) 174.3 (1.)
 Trefferlage 0.14 mm rechts, 0.70 mm tief
 Streuwert 2.05, horizontal: 2.05, vertikal: 2.05

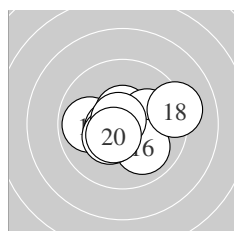

Serie 2:
 10.8 * 9.9 ← 10.6 * 10.6 * 10.1 →
 10.0 ↘ 10.4 * 9.2 → 10.8 * 10.5 *
 beste Teiler 46.6 (19.) 49.6 (11.) 90.0 (13.)
 Trefferlage 0.26 mm rechts, 0.12 mm tief
 Streuwert 1.51, horizontal: 1.93, vertikal: 0.93

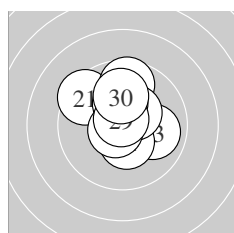

Serie 3:
 9.4 ↘ 9.6 ↑ 10.0 → 10.4 * 10.4 *
 10.4 * 10.7 * 10.2 * 10.8 * 10.0 ↑
 beste Teiler 50.4 (29.) 70.4 (27.) 133.4 (25.)
 Trefferlage 0.07 mm rechts, 0.99 mm hoch
 Streuwert 1.42, horizontal: 1.38, vertikal: 1.46

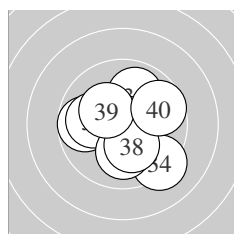

Serie 4:
 9.9 ↑ 10.3 * 10.8 * 9.2 ↘ 9.7 ←
 10.0 ← 10.1 ↓ 10.2 * 10.3 * 9.7 →
 beste Teiler 47.0 (33.) 151.4 (32.) 170.9 (39.)
 Trefferlage 0.25 mm rechts, 0.30 mm tief
 Streuwert 1.86, horizontal: 2.01, vertikal: 1.71

Unterschrift des Schuetzen

Ergebnis:	399.1	(384)
Serien:	100.5	99.3 98.7 100.6
Zaehler:	26	12 2 0 0 0 0 0 0 0
Innenzehner:	15	
weiteste:	705	(25), 547 (11), 470 (14)
beste Teiler	83.0	(17.) 88.8 (37.) 89.0 (24.)
Trefferlage	0.92 mm links, 0.02 mm tief	
Streuwert	1.85, horizontal: 2.00, vertikal: 1.69	

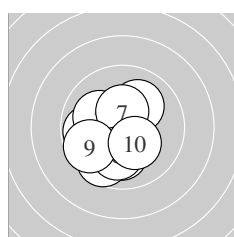
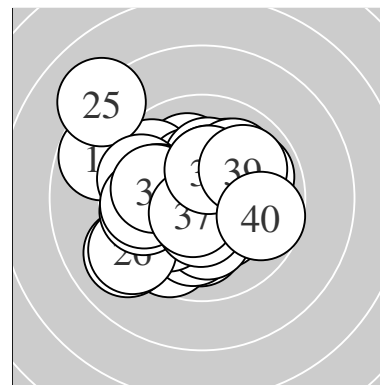

Serie 1:	9.8 ←	10.1 ↓	10.1 ↖	9.7 ✓	10.1 ↗
	10.3 *	10.4 *	10.0 ↓	9.7 ✓	10.3 *
beste Teiler	134.0 (7.) 157.8 (6.) 169.0 (10.)				
Trefferlage	0.72 mm links, 0.81 mm tief				
Streuwert	1.56, horizontal: 1.49, vertikal: 1.63				

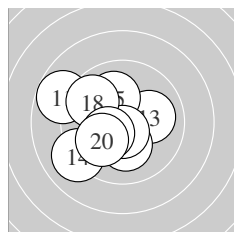

Serie 2:	8.8 ↖	10.5 *	10.0 →	9.1 ✓	10.1 ↗
	10.2 *	10.6 *	9.7 ↖	10.3 *	10.0 ✓
beste Teiler	83.0 (17.) 103.0 (12.) 154.8 (19.)				
Trefferlage	1.26 mm links, 0.26 mm tief				
Streuwert	1.95, horizontal: 2.13, vertikal: 1.75				

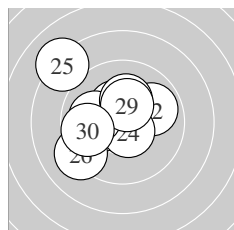

Serie 3:	10.2 *	9.9 →	10.4 *	10.6 *	8.1 ↖
	9.2 ✓	10.0 ←	10.2 *	10.4 *	9.7 ←
beste Teiler	89.0 (24.) 144.0 (23.) 148.9 (29.)				
Trefferlage	1.28 mm links, 0.66 mm hoch				
Streuwert	2.14, horizontal: 2.28, vertikal: 2.00				

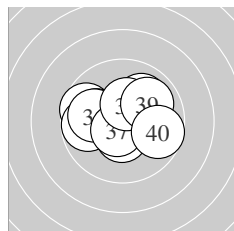

Serie 4:	9.7 ↖	10.4 *	10.1 ←	9.8 ←	10.0 ↗
	10.0 ←	10.6 *	10.4 *	9.9 →	9.7 →
beste Teiler	88.8 (37.) 126.1 (32.) 146.9 (38.)				
Trefferlage	0.41 mm links, 0.33 mm hoch				
Streuwert	1.73, horizontal: 2.19, vertikal: 1.09				

Unterschrift des Schuetzen

Ergebnis: **400.5** (382)
 Serien: 99.5 100.2 99.0 101.8
 Zaehler: 22 18 0 0 0 0 0 0 0 0
 Innenzehner: 14
 weiteste: 460 (38), 407 (25), 393 (2)
 beste Teiler 27.8 (5.) 41.0 (30.) 44.3 (39.)
 Trefferlage 0.37 mm links, 0.56 mm hoch
 Streuwert 1.77, horizontal: 1.95, vertikal: 1.58

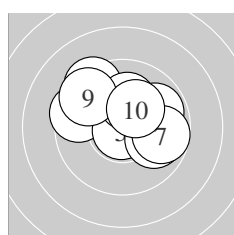
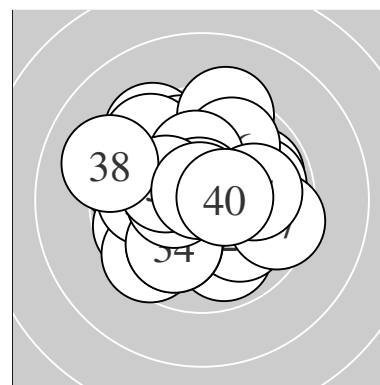

Serie 1:
 9.5 ↖ 9.4 ↗ 10.5 * 9.8 ↘ 10.8 *
 9.9 ↗ 9.7 ↘ 10.1 ↑ 9.5 ↖ 10.3 *
 beste Teiler 27.8 (5.) 110.2 (3.) 174.4 (10.)
 Trefferlage 0.08 mm rechts, 1.05 mm hoch
 Streuwert 1.85, horizontal: 2.26, vertikal: 1.32

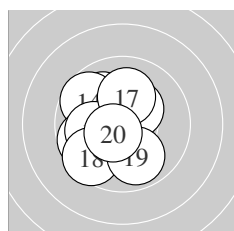

Serie 2:
 10.0 ↖ 10.4 * 10.2 * 9.7 ↖ 9.7 ↗
 10.0 ← 10.1 ↑ 9.6 ↗ 9.9 ↘ 10.6 *
 beste Teiler 100.4 (20.) 150.8 (12.) 184.7 (13.)
 Trefferlage 1.19 mm links, 0.07 mm tief
 Streuwert 1.61, horizontal: 1.48, vertikal: 1.73

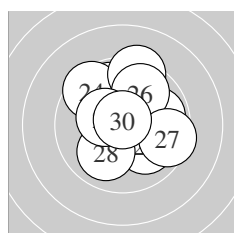

Serie 3:
 10.0 ↖ 9.9 → 9.8 ↖ 9.5 ↖ 9.3 ↑
 9.8 ↗ 9.5 → 10.0 ↗ 10.4 * 10.8 *
 beste Teiler 41.0 (30.) 148.6 (29.) 233.7 (21.)
 Trefferlage 0.42 mm rechts, 0.88 mm hoch
 Streuwert 1.97, horizontal: 1.93, vertikal: 2.01

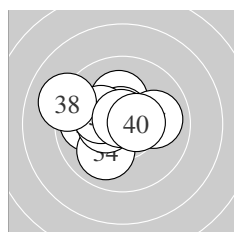

Serie 4:
 9.9 ← 10.2 * 10.7 * 10.0 ↗ 10.4 *
 10.2 * 10.0 → 9.1 ↖ 10.8 * 10.5 *
 beste Teiler 44.3 (39.) 66.4 (33.) 106.6 (40.)
 Trefferlage 0.82 mm links, 0.39 mm hoch
 Streuwert 1.53, horizontal: 1.88, vertikal: 1.08

Unterschrift des Schuetzen

Meyton Elektronik

Ergebnis: **408.4** (388)
 Serien: 102.9 99.7 104.7 101.1
 Zaehler: 28 12 0 0 0 0 0 0 0 0
 Innenzehner: 27
 weiteste: 471 (13), 461 (9), 382 (40)
 beste Teiler 24.2 (28.) 36.0 (32.) 59.0 (25.)
 Trefferlage 0.11 mm links, 0.18 mm hoch
 Streuwert 1.54, horizontal: 1.89, vertikal: 1.09

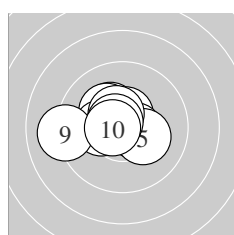
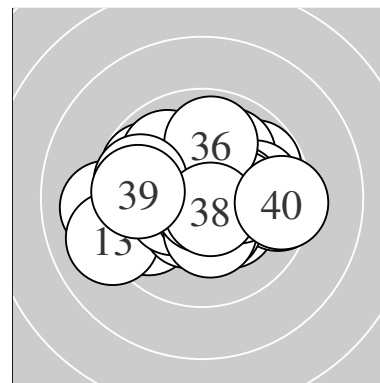

Serie 1:
 10.3 * 10.2 * 10.5 * 10.5 * 10.2 *
 10.3 * 10.5 * 10.7 * 9.1 ← 10.6 *
 beste Teiler 74.0 (8.) 81.1 (10.) 101.4 (3.)
 Trefferlage 0.76 mm links, 0.35 mm hoch
 Streuwert 1.31, horizontal: 1.69, vertikal: 0.78

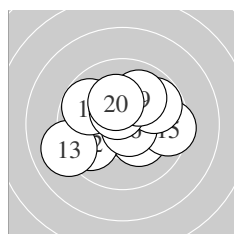

Serie 2:
 10.3 * 9.8 ↙ 9.1 ↙ 9.8 ↘ 9.5 →
 10.7 * 9.8 ↗ 10.5 * 10.0 ↗ 10.2 *
 beste Teiler 62.9 (16.) 110.3 (18.) 173.6 (11.)
 Trefferlage 0.11 mm links, 0.25 mm hoch
 Streuwert 2.04, horizontal: 2.49, vertikal: 1.47

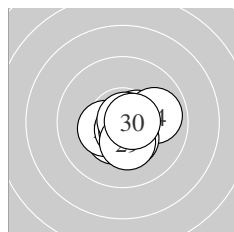

Serie 3:
 10.5 * 10.4 * 10.4 * 9.9 → 10.7 *
 10.6 * 10.4 * 10.9 * 10.3 * 10.6 *
 beste Teiler 24.2 (28.) 59.0 (25.) 76.9 (26.)
 Trefferlage 0.39 mm rechts, 0.47 mm tief
 Streuwert 0.90, horizontal: 1.04, vertikal: 0.72

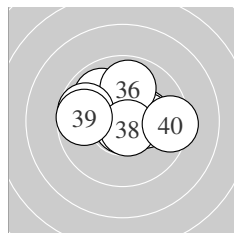

Serie 4:
 10.3 * 10.8 * 10.3 * 10.4 * 9.9 ↖
 9.9 ↑ 9.7 ← 10.7 * 9.7 ← 9.4 →
 beste Teiler 36.0 (32.) 68.6 (38.) 135.4 (34.)
 Trefferlage 0.01 mm rechts, 0.62 mm hoch
 Streuwert 1.70, horizontal: 2.15, vertikal: 1.05

Unterschrift des Schuetzen

Meyton Elektronik

Ergebnis: **398.9** (380)
 Serien: 97.5 101.8 99.6 100.0
 Zaehler: 22 16 2 0 0 0 0 0 0 0
 Innenzehner: 21
 weiteste: 652 (1), 521 (22), 477 (30)
 beste Teiler 55.5 (16.) 57.8 (33.) 76.9 (5.)
 Trefferlage 0.60 mm rechts, 0.35 mm tief
 Streuwert 1.96, horizontal: 2.20, vertikal: 1.69

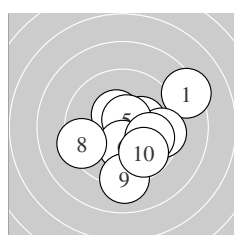
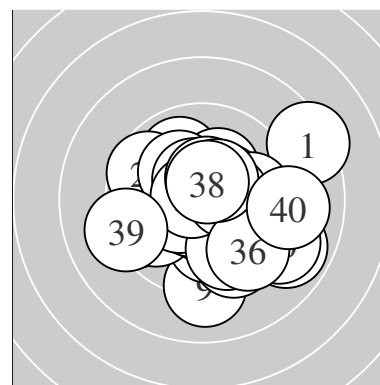

Serie 1:
 8.3 ↗ 10.2 * 9.5 → 10.4 * 10.6 *
 10.3 * 9.9 ↘ 9.4 ← 9.1 ↓ 9.8 ↘
 beste Teiler 76.9 (5.) 127.0 (4.) 163.0 (6.)
 Trefferlage 1.15 mm rechts, 0.60 mm tief
 Streuwert 2.35, horizontal: 2.56, vertikal: 2.12

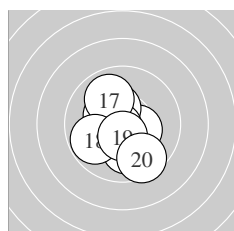

Serie 2:
 10.4 * 10.4 * 10.3 * 10.0 ↓ 10.3 *
 10.7 * 9.9 ↘ 9.8 ← 10.5 * 9.5 ↘
 beste Teiler 55.5 (16.) 108.0 (19.) 139.2 (12.)
 Trefferlage 0.35 mm links, 0.29 mm tief
 Streuwert 1.50, horizontal: 1.26, vertikal: 1.70

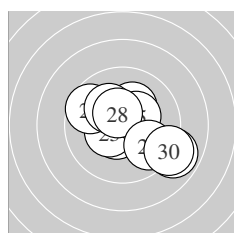

Serie 3:
 10.6 * 8.9 ↘ 10.4 * 10.2 * 10.4 *
 9.6 ↙ 10.2 * 10.5 * 9.8 ↘ 9.0 ↘
 beste Teiler 99.8 (21.) 119.2 (28.) 135.5 (23.)
 Trefferlage 0.68 mm rechts, 0.15 mm tief
 Streuwert 2.09, horizontal: 2.44, vertikal: 1.66

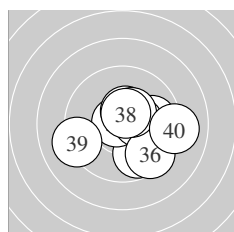

Serie 4:
 9.8 ↘ 9.9 → 10.7 * 10.4 * 10.5 *
 9.5 ↘ 10.4 * 10.5 * 9.2 ← 9.1 →
 beste Teiler 57.8 (33.) 101.2 (38.) 121.3 (35.)
 Trefferlage 0.92 mm rechts, 0.34 mm tief
 Streuwert 1.94, horizontal: 2.32, vertikal: 1.47

Unterschrift des Schuetzen

Meyton Elektronik

Ergebnis:	407.2	(388)
Serien:	98.7	103.6 102.0 102.9
Zaehler:	28	12 0 0 0 0 0 0 0 0
Innenzehner:	20	
weiteste:	473	(7), 390 (1), 366 (2)
beste Teiler	39.0	(40.) 39.6 (6.) 39.9 (15.)
Trefferlage	0.19 mm	links, 0.60 mm hoch
Streuwert	1.51,	horizontal: 1.79, vertikal: 1.16

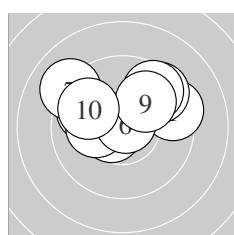
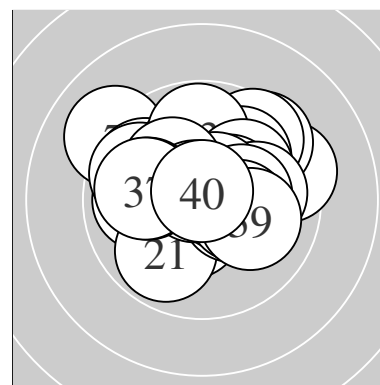

Serie 1:	9.4 →	9.5 ↗	9.8 ↖	10.6 *	10.2 *
	10.8 *	9.1 ↘	9.6 ↗	9.9 ↗	9.8 ↖
beste Teiler	39.6	(6.) 88.2	(4.) 194.0	(5.)	
Trefferlage	0.12 mm	links, 1.36 mm	hoch		
Streuwert	2.00,	horizontal: 2.60,	vertikal: 1.12		

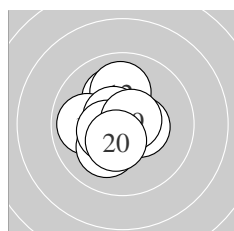

Serie 2:	10.1 ↖	10.0 ↑	9.9 ←	10.5 *	10.8 *
	10.6 *	10.1 ↙	10.5 *	10.7 *	10.4 *
beste Teiler	39.9	(15.) 70.2	(19.) 84.8	(16.)	
Trefferlage	0.54 mm	links, 0.16 mm	hoch		
Streuwert	1.14,	horizontal: 1.04,	vertikal: 1.23		

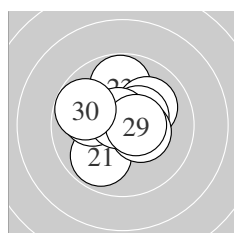

Serie 3:	9.9 ↙	10.3 *	9.8 ↑	10.1 ↗	10.4 *
	10.4 *	10.0 ←	10.7 *	10.6 *	9.8 ↖
beste Teiler	59.6	(28.) 98.0	(29.) 132.4	(25.)	
Trefferlage	0.29 mm	links, 0.57 mm	hoch		
Streuwert	1.47,	horizontal: 1.59,	vertikal: 1.33		

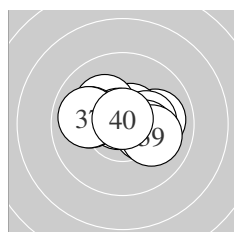

Serie 4:	10.0 →	10.6 *	10.3 *	10.2 *	10.8 *
	10.0 ←	9.9 ←	10.3 *	10.0 →	10.8 *
beste Teiler	39.0	(40.) 49.6	(35.) 93.4	(32.)	
Trefferlage	0.19 mm	rechts, 0.31 mm	hoch		
Streuwert	1.35,	horizontal: 1.81,	vertikal: 0.61		

Unterschrift des Schuetzen

Meyton Elektronik

Ergebnis: **410.4** (393)
 Serien: 102.6 103.9 100.7 103.2
 Zaehler: 33 7 0 0 0 0 0 0 0 0
 Innenzehner: 27
 weiteste: 431 (30), 309 (21), 283 (38)
 beste Teiler 36.2 (8.) 49.1 (16.) 52.7 (39.)
 Trefferlage 0.27 mm links, 0.04 mm hoch
 Streuwert 1.37, horizontal: 1.63, vertikal: 1.03

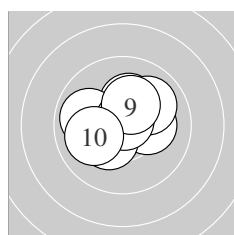
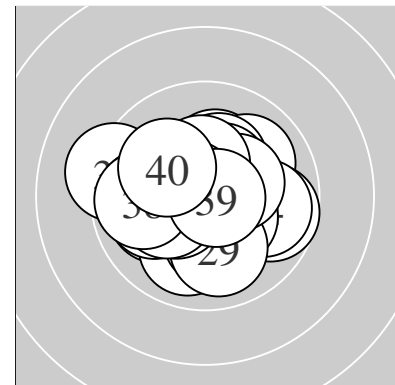

Serie 1:
 10.2 * 10.2 * 10.7 * 9.9 ← 10.2 *
 10.3 * 10.0 ↗ 10.8 * 10.3 * 10.0 ←
 beste Teiler 36.2 (8.) 65.2 (3.) 155.7 (6.)
 Trefferlage 0.14 mm rechts, 0.50 mm hoch
 Streuwert 1.33, horizontal: 1.60, vertikal: 0.98

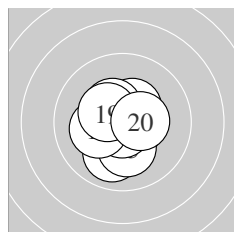

Serie 2:
 10.6 * 10.0 ↓ 10.4 * 10.5 * 10.2 *
 10.8 * 10.4 * 10.2 * 10.4 * 10.4 *
 beste Teiler 49.1 (16.) 93.1 (11.) 106.6 (14.)
 Trefferlage 0.23 mm links, 0.22 mm tief
 Streuwert 1.10, horizontal: 1.03, vertikal: 1.17

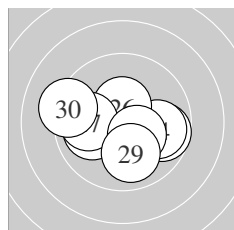

Serie 3:
 9.7 → 10.4 * 10.0 ← 9.9 → 10.7 *
 10.5 * 9.9 ← 10.4 * 10.0 ↓ 9.2 ←
 beste Teiler 65.3 (25.) 122.0 (26.) 126.1 (22.)
 Trefferlage 0.13 mm links, 0.34 mm tief
 Streuwert 1.80, horizontal: 2.29, vertikal: 1.11

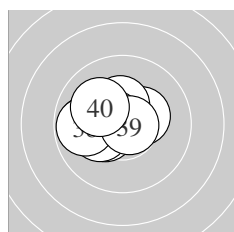

Serie 4:
 10.7 * 10.3 * 9.9 ← 10.4 * 10.4 *
 10.7 * 10.2 * 9.8 ← 10.7 * 10.1 ↘
 beste Teiler 52.7 (39.) 65.0 (31.) 74.3 (36.)
 Trefferlage 0.88 mm links, 0.25 mm hoch
 Streuwert 1.13, horizontal: 1.42, vertikal: 0.72

Unterschrift des Schuetzen

Ergebnis: **406.5** (391)
 Serien: 101.2 101.8 100.7 102.8
 Zaehler: 31 9 0 0 0 0 0 0 0 0
 Innenzehner: 21
 weiteste: 427 (20), 404 (32), 356 (26)
 beste Teiler 46.3 (19.) 46.4 (12.) 63.3 (2.)
 Trefferlage 0.03 mm rechts, 0.15 mm hoch
 Streuwert 1.57, horizontal: 1.61, vertikal: 1.54

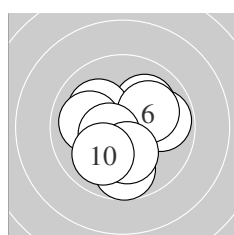
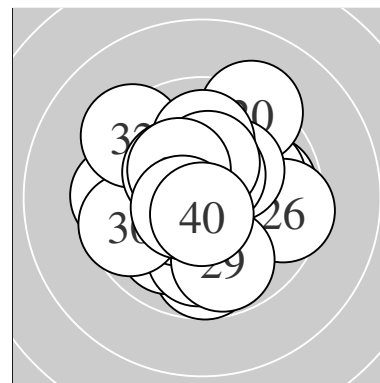

Serie 1:
 10.1 ↗ 10.7 * 10.1 ↘ 10.0 ← 9.8 →
 10.1 ↗ 10.5 * 9.7 ↓ 10.2 * 10.0 ↘
 beste Teiler 63.3 (2.) 109.1 (7.) 188.0 (9.)
 Trefferlage 0.07 mm rechts, 0.24 mm tief
 Streuwert 1.62, horizontal: 1.69, vertikal: 1.55

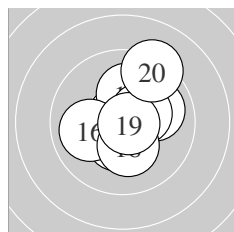

Serie 2:
 9.8 ↗ 10.8 * 10.4 * 10.0 → 10.1 ↑
 10.0 ← 10.4 * 10.3 * 10.8 * 9.2 ↗
 beste Teiler 46.3 (19.) 46.4 (12.) 135.0 (13.)
 Trefferlage 0.54 mm rechts, 0.64 mm hoch
 Streuwert 1.55, horizontal: 1.38, vertikal: 1.71

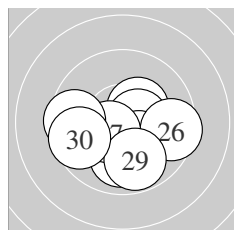

Serie 3:
 10.4 * 10.6 * 10.0 ↓ 10.5 * 10.2 *
 9.5 → 10.5 * 9.6 ← 9.8 ↓ 9.6 ←
 beste Teiler 89.0 (22.) 111.0 (24.) 117.8 (27.)
 Trefferlage 0.03 mm links, 0.85 mm tief
 Streuwert 1.70, horizontal: 2.11, vertikal: 1.15

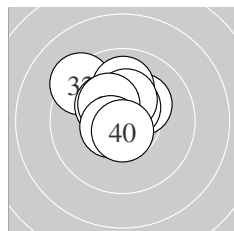

Serie 4:
 10.2 * 9.3 ↘ 10.3 * 10.6 * 10.5 *
 10.0 ↑ 10.3 * 10.3 * 10.6 * 10.7 *
 beste Teiler 71.0 (40.) 90.6 (34.) 94.3 (39.)
 Trefferlage 0.45 mm links, 1.07 mm hoch
 Streuwert 1.13, horizontal: 1.19, vertikal: 1.07

Unterschrift des Schuetzen

Meyton Elektronik

Ergebnis: **411.7** (394)
 Serien: 103.9 102.7 103.4 101.7
 Zaehler: 34 6 0 0 0 0 0 0 0 0
 Innenzehner: 31
 weiteste: 408 (32), 395 (12), 352 (21)
 beste Teiler 8.5 (30.) 21.0 (5.) 26.1 (22.)
 Trefferlage 0.03 mm links, 0.18 mm hoch
 Streuwert 1.35, horizontal: 1.38, vertikal: 1.32

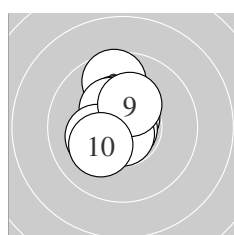
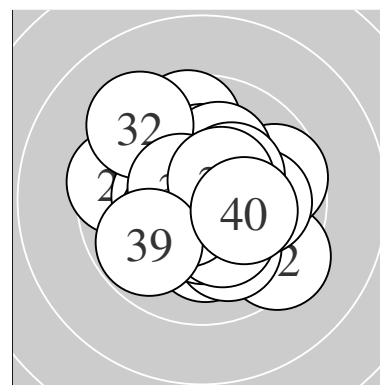

Serie 1:
 10.6 * 10.4 * 9.7 ↑ 10.4 * 10.9 *
 10.4 * 10.8 * 10.2 * 10.3 * 10.2 *
 beste Teiler 21.0 (5.) 48.0 (7.) 77.8 (1.)
 Trefferlage 0.39 mm links, 0.68 mm hoch
 Streuwert 1.09, horizontal: 0.79, vertikal: 1.32

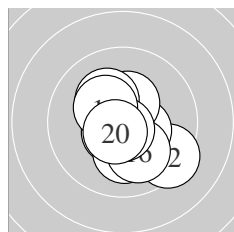

Serie 2:
 10.6 * 9.4 ↘ 10.4 * 10.1 ↓ 10.4 *
 10.0 ↘ 10.2 * 10.7 * 10.3 * 10.6 *
 beste Teiler 51.0 (18.) 85.6 (20.) 94.1 (11.)
 Trefferlage 0.24 mm rechts, 0.49 mm tief
 Streuwert 1.36, horizontal: 1.31, vertikal: 1.41

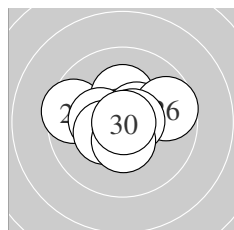

Serie 3:
 9.5 ← 10.8 * 10.2 * 10.3 * 10.5 *
 9.7 → 10.7 * 10.4 * 10.4 * 10.9 *
 beste Teiler 8.5 (30.) 26.1 (22.) 71.4 (27.)
 Trefferlage 0.11 mm links, 0.24 mm hoch
 Streuwert 1.35, horizontal: 1.71, vertikal: 0.86

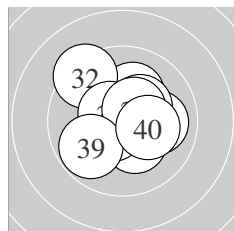

Serie 4:
 10.2 * 9.3 ↘ 10.0 → 10.3 * 10.3 *
 10.6 * 10.5 * 10.5 * 9.8 ↙ 10.2 *
 beste Teiler 90.2 (36.) 102.7 (37.) 114.5 (38.)
 Trefferlage 0.13 mm rechts, 0.30 mm hoch
 Streuwert 1.58, horizontal: 1.67, vertikal: 1.49

Unterschrift des Schuetzen

Meyton Elektronik

Ergebnis: **405.9** (387)
 Serien: 101.7 98.7 102.3 103.2
 Zaehler: 28 11 1 0 0 0 0 0 0 0
 Innenzehner: 24
 weiteste: 579 (13), 449 (12), 418 (33)
 beste Teiler 43.6 (38.) 50.2 (19.) 60.9 (25.)
 Trefferlage 0.08 mm rechts, 0.59 mm tief
 Streuwert 1.64, horizontal: 1.78, vertikal: 1.48

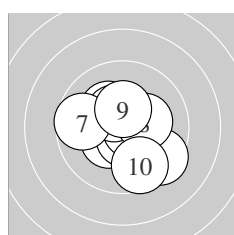
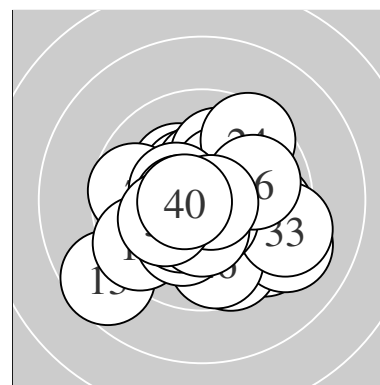

Serie 1:
 10.4 * 9.5 ↘ 10.2 * 10.6 * 10.7 *
 10.4 * 9.7 ← 10.2 * 10.4 * 9.6 ↓
 beste Teiler 69.6 (5.) 91.2 (4.) 127.9 (6.)
 Trefferlage 0.08 mm rechts, 0.26 mm tief
 Streuwert 1.63, horizontal: 1.72, vertikal: 1.54

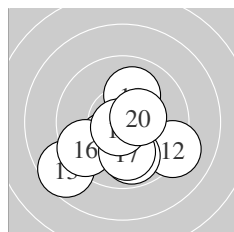

Serie 2:
 10.0 ↓ 9.2 ↘ 8.6 ↙ 9.9 ↓ 10.2 *
 9.5 ↙ 10.0 ↓ 10.1 ↑ 10.8 * 10.4 *
 beste Teiler 50.2 (19.) 129.0 (20.) 191.3 (15.)
 Trefferlage 0.13 mm links, 1.45 mm tief
 Streuwert 2.04, horizontal: 2.33, vertikal: 1.70

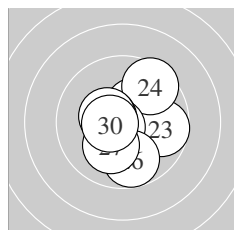

Serie 3:
 10.7 * 10.3 * 9.7 → 9.5 ↗ 10.7 *
 9.8 ↓ 10.1 ↙ 10.5 * 10.4 * 10.6 *
 beste Teiler 60.9 (25.) 61.8 (21.) 100.7 (30.)
 Trefferlage 0.16 mm rechts, 0.03 mm tief
 Streuwert 1.53, horizontal: 1.49, vertikal: 1.57

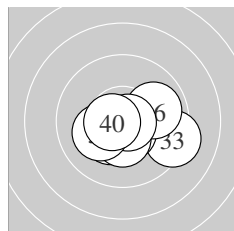

Serie 4:
 10.3 * 10.5 * 9.3 ↘ 10.6 * 10.6 *
 9.9 → 10.4 * 10.8 * 10.2 * 10.6 *
 beste Teiler 43.6 (38.) 83.4 (40.) 92.4 (35.)
 Trefferlage 0.23 mm rechts, 0.64 mm tief
 Streuwert 1.33, horizontal: 1.73, vertikal: 0.72

Unterschrift des Schuetzen

Ergebnis: **410.3** (393)
 Serien: 103.7 101.1 102.4 103.1
 Zaehler: 33 7 0 0 0 0 0 0 0 0
 Innenzehner: 26
 weiteste: 406 (17), 380 (38), 354 (11)
 beste Teiler 8.0 (30.) 37.3 (8.) 58.5 (31.)
 Trefferlage 0.02 mm links, 0.09 mm hoch
 Streuwert 1.42, horizontal: 1.54, vertikal: 1.29

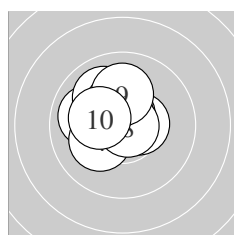
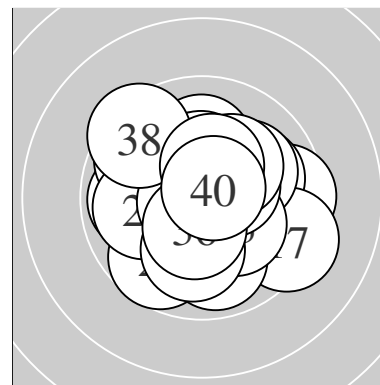

Serie 1:
 10.5 * 10.0 ← 10.0 ↘ 10.2 * 10.7 *
 10.7 * 10.4 * 10.8 * 10.1 ↑ 10.3 *
 beste Teiler 37.3 (8.) 69.0 (6.) 75.6 (5.)
 Trefferlage 0.59 mm links, 0.71 mm hoch
 Streuwert 1.04, horizontal: 1.11, vertikal: 0.97

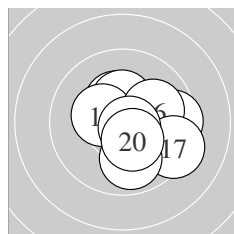

Serie 2:
 9.5 → 10.3 * 10.4 * 10.3 * 10.3 *
 10.0 → 9.3 ↘ 10.7 * 9.9 ↓ 10.4 *
 beste Teiler 62.0 (18.) 145.4 (20.) 150.0 (13.)
 Trefferlage 1.01 mm rechts, 0.30 mm tief
 Streuwert 1.54, horizontal: 1.66, vertikal: 1.41

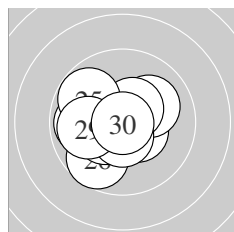

Serie 3:
 10.5 * 10.1 ↗ 9.9 ← 10.5 * 9.8 ↖
 9.7 ↙ 10.4 * 10.6 * 10.0 ← 10.9 *
 beste Teiler 8.0 (30.) 99.0 (28.) 118.8 (24.)
 Trefferlage 0.70 mm links, 0.17 mm tief
 Streuwert 1.44, horizontal: 1.64, vertikal: 1.22

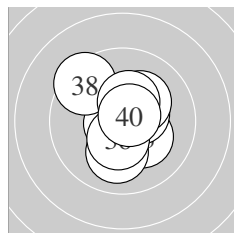

Serie 4:
 10.7 * 10.5 * 10.2 * 10.5 * 10.1 ↓
 10.4 * 10.2 * 9.4 ↘ 10.4 * 10.7 *
 beste Teiler 58.5 (31.) 64.5 (40.) 105.1 (32.)
 Trefferlage 0.17 mm rechts, 0.16 mm hoch
 Streuwert 1.35, horizontal: 1.24, vertikal: 1.45

Unterschrift des Schuetzen

Meyton Elektronik

Ergebnis: **421.4** (399)^{QF}
 Serien: 104.6 104.3 106.4 106.1
 Zaehler: 39 1 0 0 0 0 0 0 0 0
 Innenzehner: 35
 weiteste: 254 (18), 242 (1), 234 (4)
 beste Teiler 17.4 (29.) 29.0 (32.) 37.8 (37.)
 Trefferlage 0.14 mm rechts, 0.07 mm tief
 Streuwert 0.88, horizontal: 0.98, vertikal: 0.77

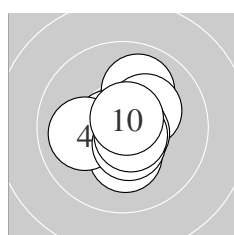
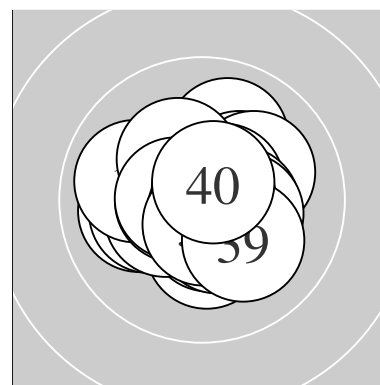

Serie 1:
 10.0 ↗ 10.3 * 10.6 * 10.0 ← 10.3 *
 10.8 * 10.7 * 10.5 * 10.7 * 10.7 *
 beste Teiler 43.2 (6.) 58.6 (10.) 70.0 (9.)
 Trefferlage 0.16 mm rechts, 0.01 mm tief
 Streuwert 1.07, horizontal: 1.03, vertikal: 1.10

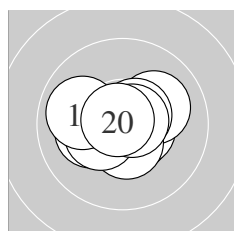

Serie 2:
 10.6 * 10.2 * 10.5 * 10.1 ↗ 10.5 *
 10.6 * 10.4 * 9.9 ← 10.7 * 10.8 *
 beste Teiler 40.4 (20.) 61.6 (19.) 91.5 (11.)
 Trefferlage 0.09 mm links, 0.04 mm tief
 Streuwert 1.10, horizontal: 1.39, vertikal: 0.69

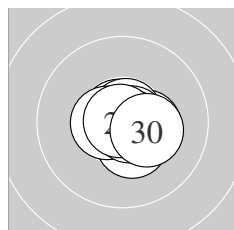

Serie 3:
 10.4 * 10.7 * 10.8 * 10.8 * 10.4 *
 10.7 * 10.6 * 10.8 * 10.9 * 10.3 *
 beste Teiler 17.4 (29.) 45.8 (23.) 46.5 (24.)
 Trefferlage 0.35 mm rechts, 0.18 mm tief
 Streuwert 0.61, horizontal: 0.73, vertikal: 0.47

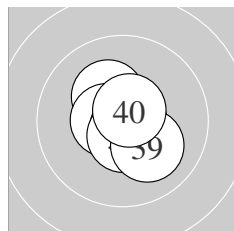

Serie 4:
 10.3 * 10.8 * 10.8 * 10.6 * 10.8 *
 10.7 * 10.8 * 10.6 * 10.1 ↘ 10.6 *
 beste Teiler 29.0 (32.) 37.8 (37.) 45.7 (35.)
 Trefferlage 0.13 mm rechts, 0.07 mm tief
 Streuwert 0.77, horizontal: 0.71, vertikal: 0.82

QF – Schütze hat sich fürs Finale qualifiziert

Unterschrift des Schuetzen

Meyton Elektronik

Ergebnis: **402.3** (382)
 Serien: 100.9 103.2 99.4 98.8
 Zaehler: 23 16 1 0 0 0 0 0 0 0
 Innenzehner: 17
 weiteste: 538 (31), 456 (22), 433 (21)
 beste Teiler 5.0 (17.) 26.0 (18.) 58.4 (5.)
 Trefferlage 0.03 mm links, 0.24 mm hoch
 Streuwert 1.83, horizontal: 1.95, vertikal: 1.71

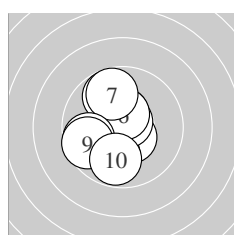
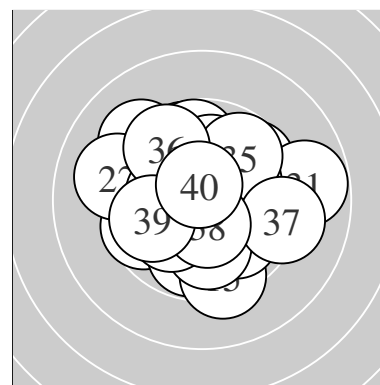

Serie 1:
 10.5 * 10.5 * 9.8 ↗ 10.0 ↓ 10.7 *
 10.5 * 9.8 ↗ 9.7 ← 9.6 ← 9.8 ↓
 beste Teiler 58.4 (5.) 112.9 (2.) 113.2 (6.)
 Trefferlage 0.82 mm links, 0.01 mm tief
 Streuwert 1.67, horizontal: 1.28, vertikal: 1.98

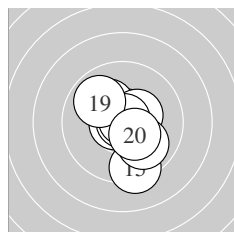

Serie 2:
 10.7 * 10.2 * 10.7 * 10.4 * 9.3 ↓
 9.9 ↘ 10.9 * 10.8 * 9.9 ↘ 10.4 *
 beste Teiler 5.0 (17.) 26.0 (18.) 67.6 (13.)
 Trefferlage 0.18 mm rechts, 0.22 mm tief
 Streuwert 1.46, horizontal: 1.19, vertikal: 1.69

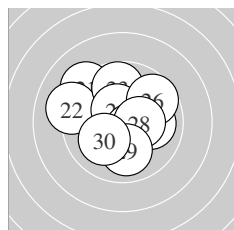

Serie 3:
 9.2 ↘ 9.1 ← 9.8 ↑ 10.5 * 10.0 →
 9.7 ↗ 10.6 * 10.4 * 10.0 ↓ 10.1 ↗
 beste Teiler 94.9 (27.) 116.7 (24.) 146.0 (28.)
 Trefferlage 0.26 mm links, 0.54 mm hoch
 Streuwert 2.05, horizontal: 2.28, vertikal: 1.80

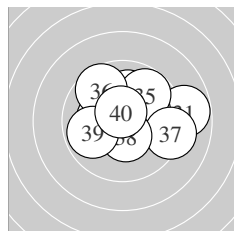

Serie 4:
 8.8 → 10.1 ↗ 10.3 * 10.1 ↑ 9.8 ↗
 9.6 ↘ 9.2 → 10.4 * 9.9 ← 10.6 *
 beste Teiler 80.4 (40.) 131.0 (38.) 174.9 (33.)
 Trefferlage 0.77 mm rechts, 0.67 mm hoch
 Streuwert 2.09, horizontal: 2.58, vertikal: 1.44

Unterschrift des Schuetzen

Meyton Elektronik

Ergebnis:	405.7	(384)							
Serien:	100.1	103.3	100.1	102.2					
Zaehler:	26	12	2	0	0	0	0	0	0
Innenzehner:	25								
weiteste:	554 (8),	501 (4),	474 (19)						
beste Teiler	29.1 (14.)	48.4 (34.)	50.2 (9.)						
Trefferlage	0.67 mm rechts, 0.02 mm tief								
Streuwert	1.67, horizontal: 2.12, vertikal: 1.04								

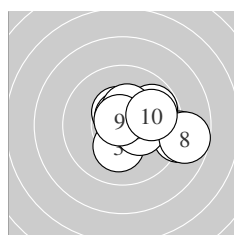
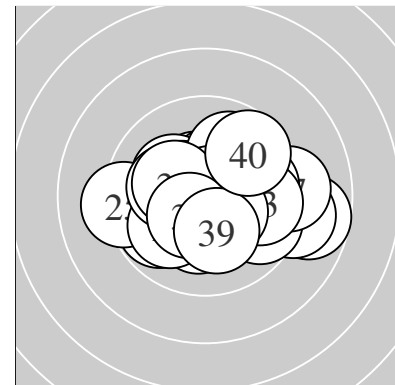

Serie 1:	10.5 *	10.6 *	10.2 *	8.9 →	10.3 *
	9.8 ↗	10.4 *	8.7 →	10.8 *	9.9 →
beste Teiler	50.2 (9.)	76.6 (2.)	123.3 (1.)		
Trefferlage	1.60 mm rechts, 0.15 mm hoch				
Streuwert	1.76, horizontal: 2.21, vertikal: 1.15				

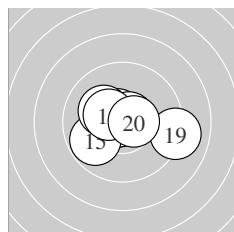

Serie 2:	10.4 *	10.7 *	10.6 *	10.8 *	9.8 ↖
	10.7 *	10.2 *	10.4 *	9.1 →	10.6 *
beste Teiler	29.1 (14.)	65.0 (12.)	67.8 (16.)		
Trefferlage	0.16 mm links, 0.09 mm hoch				
Streuwert	1.49, horizontal: 1.95, vertikal: 0.80				

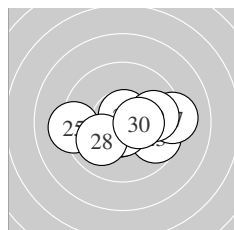

Serie 3:	10.6 *	9.8 →	9.7 →	10.6 *	9.2 ←
	10.7 *	9.2 →	10.0 ↖	9.9 →	10.4 *
beste Teiler	61.1 (26.)	76.0 (24.)	88.9 (21.)		
Trefferlage	0.77 mm rechts, 0.45 mm tief				
Streuwert	1.91, horizontal: 2.58, vertikal: 0.78				

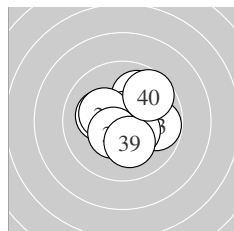

Serie 4:	9.9 ↗	10.2 *	9.8 →	10.8 *	10.5 *
	10.4 *	10.3 *	10.4 *	10.2 *	9.7 ↗
beste Teiler	48.4 (34.)	121.7 (35.)	131.0 (38.)		
Trefferlage	0.47 mm rechts, 0.08 mm hoch				
Streuwert	1.46, horizontal: 1.55, vertikal: 1.37				

Unterschrift des Schuetzen

Ergebnis: **400.3** (385)
 Serien: 101.7 99.5 101.4 97.7
 Zaehler: 25 15 0 0 0 0 0 0 0 0
 Innenzehner: 15
 weiteste: 436 (33), 406 (35), 397 (34)
 beste Teiler 97.8 (26.) 110.0 (14.) 119.5 (37.)
 Trefferlage 0.49 mm rechts, 0.14 mm tief
 Streuwert 1.79, horizontal: 1.77, vertikal: 1.80

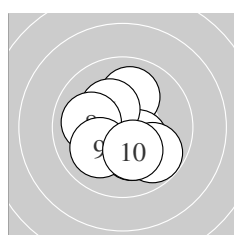
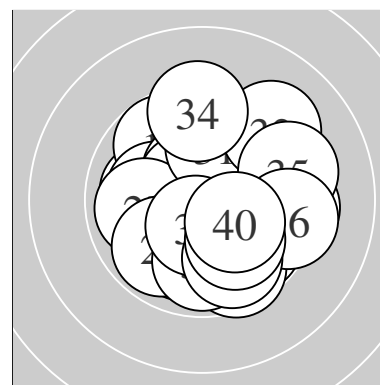

Serie 1:
 10.4 * 10.2 * 10.4 * 10.0 ↑ 10.4 *
 10.3 * 9.8 ↘ 10.0 ← 10.0 ✓ 10.2 *
 beste Teiler 129.7 (1.) 141.2 (3.) 146.2 (5.)
 Trefferlage 0.04 mm links, 0.46 mm tief
 Streuwert 1.46, horizontal: 1.45, vertikal: 1.46

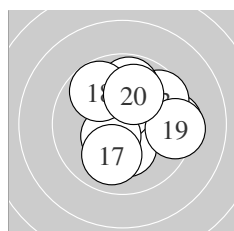

Serie 2:
 9.5 → 10.3 * 9.7 ↗ 10.5 * 9.8 ↑
 10.5 * 10.0 ↓ 9.8 ↘ 9.4 → 10.0 ↑
 beste Teiler 110.0 (14.) 125.8 (16.) 171.6 (12.)
 Trefferlage 0.84 mm rechts, 0.52 mm hoch
 Streuwert 1.88, horizontal: 1.96, vertikal: 1.80

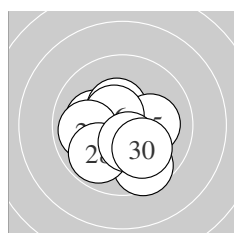

Serie 3:
 10.1 ← 10.3 * 9.6 ↘ 10.4 * 10.1 →
 10.6 * 9.9 ← 9.9 ✓ 10.4 * 10.1 ↘
 beste Teiler 97.8 (26.) 132.8 (29.) 133.4 (24.)
 Trefferlage 0.34 mm links, 0.68 mm tief
 Streuwert 1.50, horizontal: 1.64, vertikal: 1.35

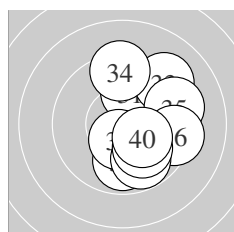

Serie 4:
 10.0 ↑ 9.9 ↓ 9.2 ↗ 9.4 ↑ 9.3 →
 9.4 → 10.5 * 9.8 ↘ 10.0 ↘ 10.2 *
 beste Teiler 119.5 (37.) 177.7 (40.) 231.4 (39.)
 Trefferlage 1.52 mm rechts, 0.06 mm hoch
 Streuwert 2.05, horizontal: 1.59, vertikal: 2.43

Unterschrift des Schuetzen

Ergebnis: **400.2** (382)
 Serien: 97.8 100.9 101.2 100.3
 Zaehler: 24 14 2 0 0 0 0 0 0 0
 Innenzehner: 17
 weiteste: 645 (13), 538 (9), 416 (38)
 beste Teiler 45.1 (16.) 49.5 (32.) 58.0 (36.)
 Trefferlage 0.76 mm rechts, 0.45 mm hoch
 Streuwert 1.85, horizontal: 2.00, vertikal: 1.68

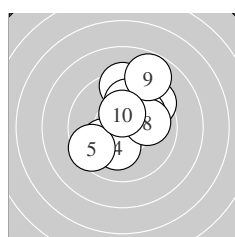
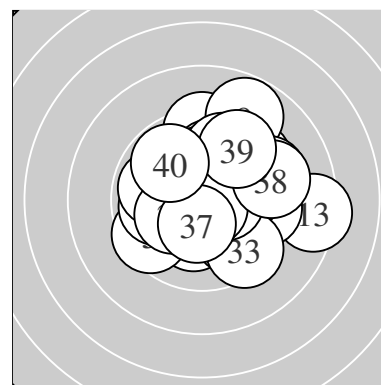

Serie 1:
 9.4 ↑ 10.0 ↙ 10.0 ↑ 10.2 * 9.5 ↙
 9.5 ↗ 10.0 ↗ 10.0 → 8.8 ↗ 10.4 *
 beste Teiler 131.0 (10.) 193.3 (4.) 229.9 (7.)
 Trefferlage 0.48 mm rechts, 1.13 mm hoch
 Streuwert 2.16, horizontal: 1.95, vertikal: 2.36

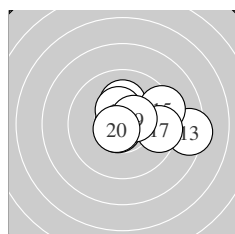

Serie 2:
 10.7 * 10.5 * 8.4 → 10.1 ↑ 9.3 →
 10.8 * 9.5 → 10.4 * 10.5 * 10.7 *
 beste Teiler 45.1 (16.) 67.2 (11.) 75.4 (20.)
 Trefferlage 1.28 mm rechts, 0.42 mm hoch
 Streuwert 1.86, horizontal: 2.44, vertikal: 1.00

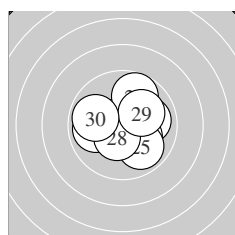

Serie 3:
 10.7 * 10.4 * 10.0 → 10.2 * 9.9 ↘
 9.9 ← 9.7 ↑ 10.4 * 10.1 ↗ 9.9 ←
 beste Teiler 66.2 (21.) 127.9 (28.) 132.2 (22.)
 Trefferlage 0.37 mm rechts, 0.08 mm hoch
 Streuwert 1.61, horizontal: 1.84, vertikal: 1.35

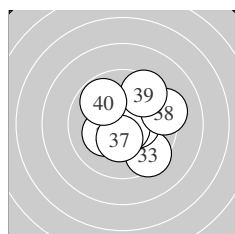

Serie 4:
 9.7 ↗ 10.8 * 9.5 ↘ 10.2 * 10.4 *
 10.7 * 10.4 * 9.3 → 9.5 ↗ 9.8 ↘
 beste Teiler 49.5 (32.) 58.0 (36.) 133.3 (35.)
 Trefferlage 0.93 mm rechts, 0.19 mm hoch
 Streuwert 1.83, horizontal: 1.90, vertikal: 1.76

Unterschrift des Schuetzen

Meyton Elektronik

Ergebnis: **412.7** (394)^{QF}
 Serien: 103.0 103.4 102.5 103.8
 Zaehler: 34 6 0 0 0 0 0 0 0 0
 Innenzehner: 31
 weiteste: 396 (25), 309 (40), 301 (4)
 beste Teiler 73.2 (2.) 74.2 (14.) 77.7 (34.)
 Trefferlage 0.19 mm links, 0.10 mm tief
 Streuwert 1.25, horizontal: 1.10, vertikal: 1.39

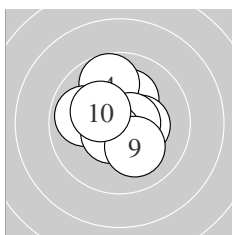
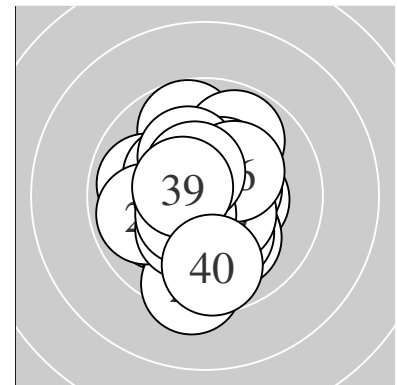

Serie 1:
 10.2 * 10.7 * 10.6 * 9.7 ↑ 10.3 *
 9.9 ← 10.6 * 10.6 * 10.1 ↓ 10.3 *
 beste Teiler 73.2 (2.) 80.0 (7.) 81.1 (3.)
 Trefferlage 0.24 mm links, 0.24 mm hoch
 Streuwert 1.30, horizontal: 1.27, vertikal: 1.34

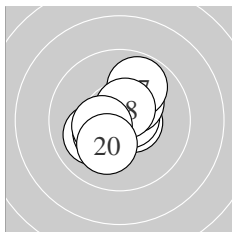

Serie 2:
 10.4 * 10.1 ↙ 10.6 * 10.7 * 10.3 *
 10.3 * 9.8 ↗ 10.6 * 10.4 * 10.2 *
 beste Teiler 74.2 (14.) 96.1 (18.) 96.3 (13.)
 Trefferlage 0.01 mm links, 0.15 mm hoch
 Streuwert 1.24, horizontal: 1.20, vertikal: 1.29

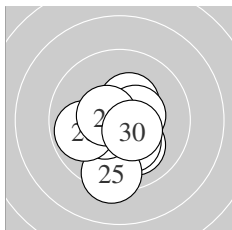

Serie 3:
 10.1 ↓ 10.2 * 10.4 * 10.6 * 9.4 ↓
 10.4 * 10.5 * 9.9 ← 10.5 * 10.5 *
 beste Teiler 81.8 (24.) 101.5 (29.) 120.7 (30.)
 Trefferlage 0.12 mm links, 0.75 mm tief
 Streuwert 1.37, horizontal: 1.27, vertikal: 1.46

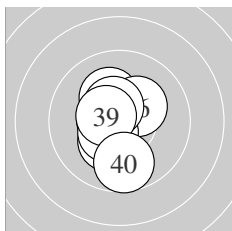

Serie 4:
 10.2 * 10.3 * 10.6 * 10.6 * 10.6 *
 10.3 * 10.5 * 10.5 * 10.5 * 9.7 ↓
 beste Teiler 77.7 (34.) 78.2 (33.) 94.0 (35.)
 Trefferlage 0.40 mm links, 0.06 mm tief
 Streuwert 1.14, horizontal: 0.73, vertikal: 1.44

QF – Schütze hat sich fürs Finale qualifiziert

Unterschrift des Schuetzen

Meyton Elektronik

Ergebnis: **410.1** (392)
 Serien: 102.7 99.9 104.5 103.0
 Zaehler: 32 8 0 0 0 0 0 0 0 0
 Innenzehner: 25
 weiteste: 413 (11), 350 (19), 345 (17)
 beste Teiler 32.8 (22.) 39.8 (14.) 51.6 (32.)
 Trefferlage 0.24 mm rechts, 0.16 mm hoch
 Streuwert 1.40, horizontal: 1.52, vertikal: 1.27

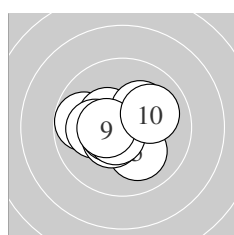
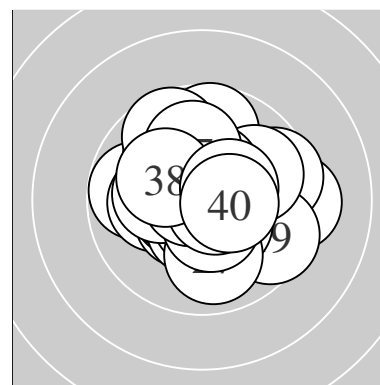

Serie 1:
 9.8 ← 10.4 * 10.2 * 10.1 ← 10.1 ↘
 10.5 * 10.5 * 10.6 * 10.5 * 10.0 →
 beste Teiler 80.1 (8.) 104.7 (7.) 119.5 (6.)
 Trefferlage 0.51 mm links, 0.03 mm tief
 Streuwert 1.30, horizontal: 1.58, vertikal: 0.94

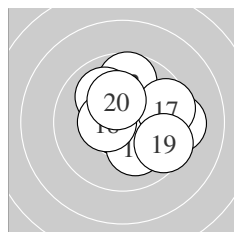

Serie 2:
 9.3 → 9.7 ↑ 10.0 ↖ 10.8 * 10.0 ↘
 10.1 ↘ 9.6 → 10.5 * 9.6 ↘ 10.3 *
 beste Teiler 39.8 (14.) 119.0 (18.) 173.2 (20.)
 Trefferlage 1.03 mm rechts, 0.24 mm hoch
 Streuwert 1.82, horizontal: 1.96, vertikal: 1.66

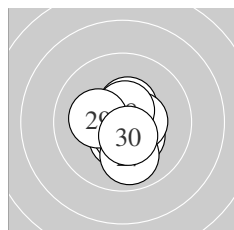

Serie 3:
 10.4 * 10.8 * 10.5 * 10.5 * 10.5 *
 10.6 * 9.9 ↓ 10.6 * 10.2 * 10.5 *
 beste Teiler 32.8 (22.) 86.0 (26.) 90.8 (28.)
 Trefferlage 0.16 mm rechts, 0.45 mm tief
 Streuwert 0.98, horizontal: 0.84, vertikal: 1.11

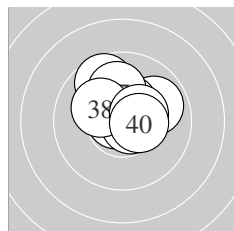

Serie 4:
 10.5 * 10.7 * 10.7 * 9.9 → 10.4 *
 9.7 ↖ 10.0 ↑ 10.2 * 10.4 * 10.5 *
 beste Teiler 51.6 (32.) 65.9 (33.) 109.8 (31.)
 Trefferlage 0.29 mm rechts, 0.91 mm hoch
 Streuwert 1.17, horizontal: 1.28, vertikal: 1.03

Unterschrift des Schuetzen

Ergebnis: **413.7** (395)^{QF}
 Serien: 103.2 102.9 104.5 103.1
 Zaehler: 35 5 0 0 0 0 0 0 0 0
 Innenzehner: 27
 weiteste: 411 (7), 397 (31), 339 (8)
 beste Teiler 25.1 (36.) 27.8 (3.) 29.2 (39.)
 Trefferlage 0.08 mm links, 0.71 mm hoch
 Streuwert 1.19, horizontal: 1.26, vertikal: 1.11

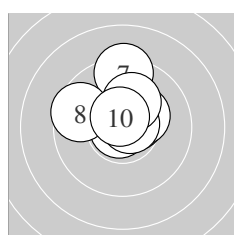
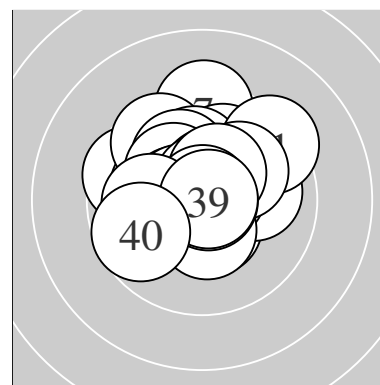

Serie 1:
 10.5 * 10.8 * 10.8 * 10.5 * 10.3 *
 10.7 * 9.3 ↑ 9.6 ↖ 10.1 ↗ 10.6 *
 beste Teiler 27.8 (3.) 49.2 (2.) 61.3 (6.)
 Trefferlage 0.04 mm rechts, 1.09 mm hoch
 Streuwert 1.22, horizontal: 1.25, vertikal: 1.19

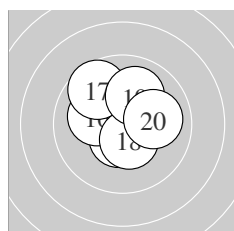

Serie 2:
 10.5 * 10.7 * 10.3 * 10.5 * 10.7 *
 10.1 ↖ 9.7 ↘ 10.4 * 10.0 ↗ 10.0 →
 beste Teiler 71.3 (15.) 74.4 (12.) 108.5 (11.)
 Trefferlage 0.03 mm rechts, 0.72 mm hoch
 Streuwert 1.25, horizontal: 1.30, vertikal: 1.19

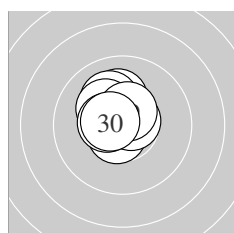

Serie 3:
 10.1 ↑ 10.5 * 10.7 * 10.6 * 10.7 *
 10.1 ↘ 10.2 * 10.5 * 10.5 * 10.6 *
 beste Teiler 60.1 (23.) 72.4 (25.) 80.4 (24.)
 Trefferlage 0.54 mm links, 0.74 mm hoch
 Streuwert 0.74, horizontal: 0.65, vertikal: 0.82

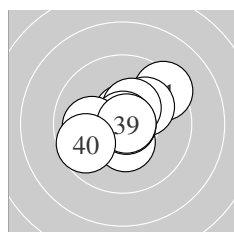

Serie 4:
 9.4 ↗ 10.1 ↗ 10.6 * 10.4 * 10.4 *
 10.9 * 10.8 * 10.0 ← 10.8 * 9.7 ↖
 beste Teiler 25.1 (36.) 29.2 (39.) 29.4 (37.)
 Trefferlage 0.12 mm rechts, 0.30 mm hoch
 Streuwert 1.48, horizontal: 1.70, vertikal: 1.22

QF – Schütze hat sich fürs Finale qualifiziert

Unterschrift des Schuetzen

Meyton Elektronik

Ergebnis: **411.5** (391)

Serien: 101.1 103.6 104.0 102.8

Zaehler: 31 9 0 0 0 0 0 0 0 0

Innenzehner: 28

weiteste: 470 (6), 317 (33), 304 (7)

beste Teiler 30.4 (29.) 32.8 (39.) 33.0 (13.)

Trefferlage 0.16 mm rechts, 0.31 mm hoch

Streuwert 1.37, horizontal: 1.19, vertikal: 1.52

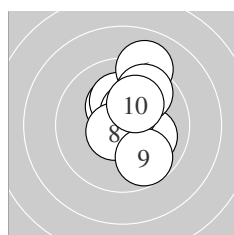
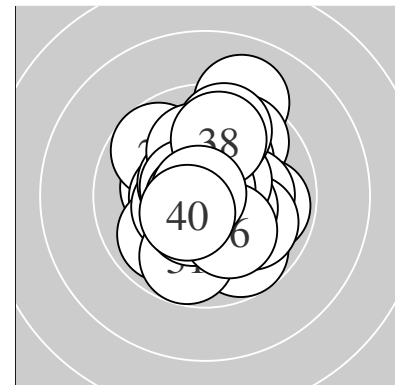

Serie 1:

10.6 *	10.3 *	10.2 *	10.1 ↘	10.5 *
9.1 ↗	9.7 ↗	10.6 *	9.8 ↘	10.2 *

beste Teiler 80.4 (8.) 98.0 (1.) 114.0 (5.)

Trefferlage 0.72 mm rechts, 0.99 mm hoch

Streuwert 1.54, horizontal: 1.04, vertikal: 1.92

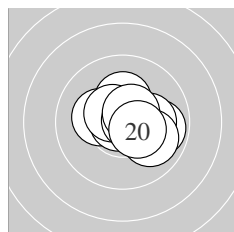

Serie 2:

10.2 *	9.9 →	10.8 *	10.2 *	10.3 *
10.5 *	10.0 ↘	10.7 *	10.6 *	10.4 *

beste Teiler 33.0 (13.) 60.6 (18.) 97.6 (19.)

Trefferlage 0.63 mm rechts, 0.14 mm hoch

Streuwert 1.14, horizontal: 1.40, vertikal: 0.81

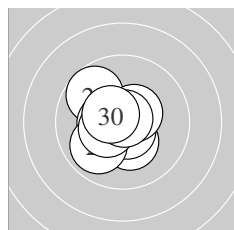

Serie 3:

10.8 *	9.7 ↖	10.4 *	10.3 *	10.7 *
9.9 ↙	10.4 *	10.5 *	10.8 *	10.5 *

beste Teiler 30.4 (29.) 49.0 (21.) 74.3 (25.)

Trefferlage 0.51 mm links, 0.07 mm tief

Streuwert 1.13, horizontal: 1.12, vertikal: 1.14

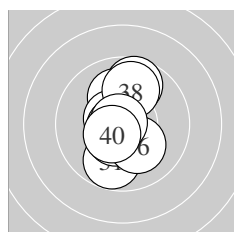

Serie 4:

9.8 ↓	10.5 *	9.7 ↑	10.1 ↑	10.6 *
10.2 *	10.7 *	9.9 ↑	10.8 *	10.5 *

beste Teiler 32.8 (39.) 62.0 (37.) 92.5 (35.)

Trefferlage 0.17 mm links, 0.18 mm hoch

Streuwert 1.46, horizontal: 0.76, vertikal: 1.91

Unterschrift des Schuetzen

Meyton Elektronik

Ergebnis: **399.5** (379)
 Serien: 102.3 99.6 97.1 100.5
 Zaehler: 20 19 1 0 0 0 0 0 0 0
 Innenzehner: 16
 weiteste: 543 (22), 421 (23), 420 (1)
 beste Teiler 72.8 (8.) 86.4 (36.) 89.1 (5.)
 Trefferlage 0.33 mm rechts, 0.21 mm hoch
 Streuwert 1.88, horizontal: 2.24, vertikal: 1.44

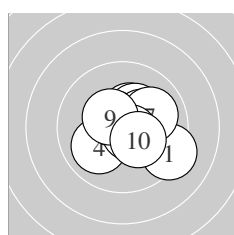
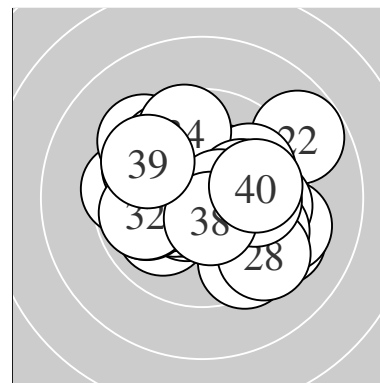

Serie 1:
 9.3 ↘ 10.4 * 10.3 * 10.0 ↙ 10.6 *
 10.3 * 10.0 → 10.7 * 10.4 * 10.3 *
 beste Teiler 72.8 (8.) 89.1 (5.) 128.5 (9.)
 Trefferlage 0.73 mm rechts, 0.09 mm hoch
 Streuwert 1.43, horizontal: 1.62, vertikal: 1.21

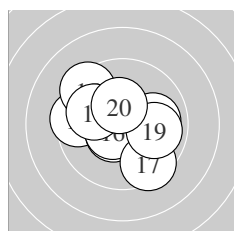

Serie 2:
 9.9 ↖ 9.5 ← 10.5 * 10.0 → 9.4 ↗
 10.6 * 9.5 ↘ 10.0 ↖ 9.9 → 10.3 *
 beste Teiler 98.0 (16.) 107.5 (13.) 151.4 (20.)
 Trefferlage 0.58 mm links, 0.18 mm hoch
 Streuwert 1.94, horizontal: 2.26, vertikal: 1.56

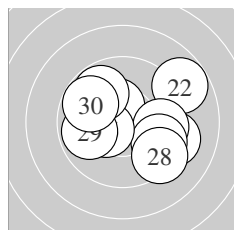

Serie 3:
 10.4 * 8.8 ↗ 9.3 ↘ 9.7 → 9.6 ↘
 10.4 * 9.8 ↖ 9.4 ↘ 9.9 ← 9.8 ↖
 beste Teiler 135.4 (21.) 144.1 (26.) 275.1 (29.)
 Trefferlage 0.87 mm rechts, 0.06 mm hoch
 Streuwert 2.41, horizontal: 2.88, vertikal: 1.83

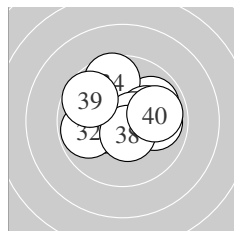

Serie 4:
 10.4 * 9.8 ← 9.9 ↗ 9.6 ↑ 10.2 *
 10.6 * 9.9 → 10.5 * 9.7 ↖ 9.9 →
 beste Teiler 86.4 (36.) 107.1 (38.) 141.4 (31.)
 Trefferlage 0.30 mm rechts, 0.54 mm hoch
 Streuwert 1.72, horizontal: 2.07, vertikal: 1.27

Unterschrift des Schuetzen

Ergebnis: **419.2** (399)^{QF}
 Serien: 102.9 105.6 105.0 105.7
 Zaehler: 39 1 0 0 0 0 0 0 0 0
 Innenzehner: 34
 weiteste: 264 (7), 240 (1), 218 (6)
 beste Teiler 3.1 (21.) 12.6 (20.) 33.2 (37.)
 Trefferlage 0.09 mm rechts, 0.40 mm hoch
 Streuwert 0.92, horizontal: 0.90, vertikal: 0.94

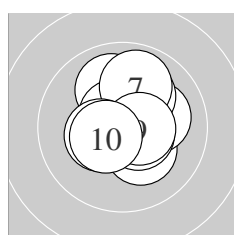
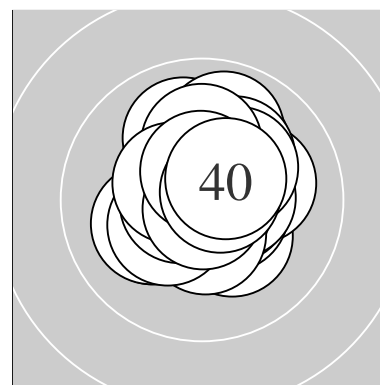

Serie 1:
 10.0 ↑ 10.6 * 10.3 * 10.1 → 10.5 *
 10.1 ↗ 9.9 ↑ 10.4 * 10.5 * 10.5 *
 beste Teiler 85.1 (2.) 104.4 (9.) 105.7 (5.)
 Trefferlage 0.33 mm rechts, 0.51 mm hoch
 Streuwert 1.24, horizontal: 1.13, vertikal: 1.34

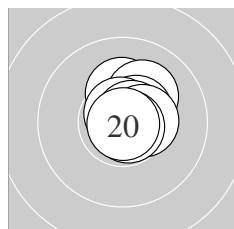

Serie 2:
 10.4 * 10.2 * 10.7 * 10.2 * 10.5 *
 10.7 * 10.7 * 10.5 * 10.8 * 10.9 *
 beste Teiler 12.6 (20.) 44.8 (19.) 56.0 (16.)
 Trefferlage 0.52 mm rechts, 0.61 mm hoch
 Streuwert 0.60, horizontal: 0.49, vertikal: 0.70

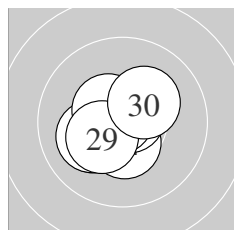

Serie 3:
 10.9 * 10.8 * 10.2 * 10.4 * 10.8 *
 10.1 ← 10.8 * 10.5 * 10.3 * 10.2 *
 beste Teiler 3.1 (21.) 41.2 (27.) 42.9 (22.)
 Trefferlage 0.47 mm links, 0.14 mm tief
 Streuwert 0.92, horizontal: 1.01, vertikal: 0.82

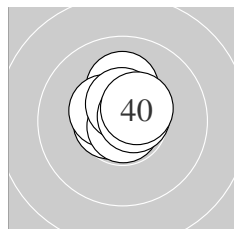

Serie 4:
 10.7 * 10.6 * 10.1 ↑ 10.6 * 10.7 *
 10.5 * 10.8 * 10.5 * 10.7 * 10.5 *
 beste Teiler 33.2 (37.) 67.6 (35.) 73.6 (31.)
 Trefferlage 0.00 mm , 0.64 mm hoch
 Streuwert 0.63, horizontal: 0.60, vertikal: 0.65

QF – Schütze hat sich fürs Finale qualifiziert

Unterschrift des Schuetzen

Meyton Elektronik

Ergebnis: **409.6** (391)
 Serien: 101.9 100.6 103.4 103.7
 Zaehler: 31 9 0 0 0 0 0 0 0 0
 Innenzehner: 26
 weiteste: 488 (35), 418 (22), 376 (13)
 beste Teiler 20.6 (30.) 55.2 (34.) 56.5 (27.)
 Trefferlage 0.24 mm links, 0.26 mm hoch
 Streuwert 1.49, horizontal: 1.93, vertikal: 0.86

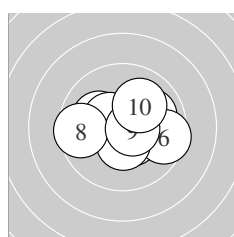
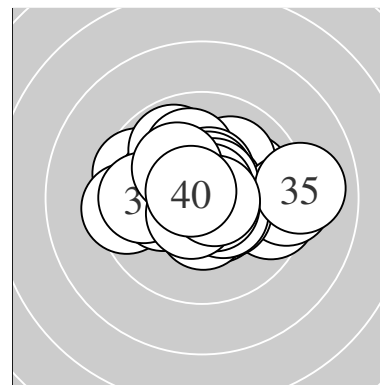

Serie 1:
 10.0 → 10.1 ↖ 10.6 * 10.5 * 10.5 *
 9.6 → 10.4 * 9.6 ← 10.6 * 10.0 ↗
 beste Teiler 83.0 (9.) 89.8 (3.) 122.4 (5.)
 Trefferlage 0.25 mm rechts, 0.02 mm tief
 Streuwert 1.58, horizontal: 2.00, vertikal: 1.00

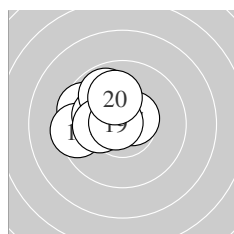

Serie 2:
 9.8 ↖ 9.6 ↖ 9.4 ← 10.1 ↖ 10.3 *
 9.9 ↘ 10.6 * 10.2 * 10.7 * 10.0 ↗
 beste Teiler 57.2 (19.) 92.7 (17.) 174.0 (15.)
 Trefferlage 1.69 mm links, 0.77 mm hoch
 Streuwert 1.17, horizontal: 1.34, vertikal: 0.98

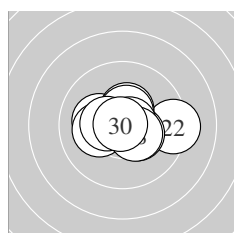

Serie 3:
 10.2 * 9.3 → 10.4 * 10.2 * 10.5 *
 10.4 * 10.7 * 10.4 * 10.4 * 10.9 *
 beste Teiler 20.6 (30.) 56.5 (27.) 108.2 (25.)
 Trefferlage 0.23 mm rechts, 0.09 mm hoch
 Streuwert 1.35, horizontal: 1.80, vertikal: 0.66

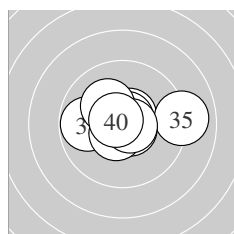

Serie 4:
 10.7 * 10.6 * 9.8 ← 10.7 * 9.0 →
 10.7 * 10.2 * 10.6 * 10.7 * 10.7 *
 beste Teiler 55.2 (34.) 60.8 (31.) 63.5 (39.)
 Trefferlage 0.23 mm rechts, 0.20 mm hoch
 Streuwert 1.47, horizontal: 1.97, vertikal: 0.63

Unterschrift des Schuetzen

ISSF AR Women – Wertung – Juniorinnen

StartNr: 62

StandNr: 134

22. Januar 2017 11:35

Kurz, Celina #70804578

T – SG Thierberg

Ergebnis: **405.0** (385)
 Serien: 102.6 99.8 102.5 100.1
 Zaehler: 25 15 0 0 0 0 0 0 0 0
 Innenzehner: 19
 weiteste: 412 (35), 374 (17), 357 (20)
 beste Teiler 46.0 (25.) 69.0 (6.) 80.6 (26.)
 Trefferlage 0.27 mm links, 0.16 mm hoch
 Streuwert 1.61, horizontal: 1.72, vertikal: 1.48

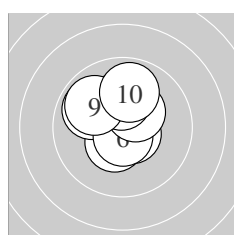
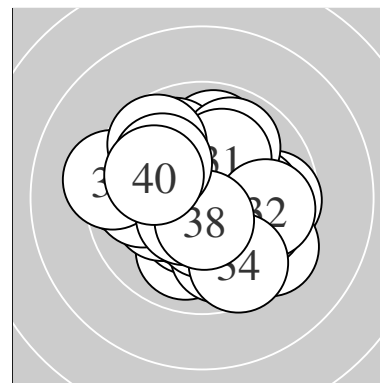

Serie 1:
 10.4 * 10.4 * 10.6 * 9.9 ↘ 10.3 *
 10.7 * 10.4 * 10.1 ↑ 9.9 ↘ 9.9 ↑
 beste Teiler 69.0 (6.) 83.4 (3.) 127.4 (2.)
 Trefferlage 0.20 mm links, 0.92 mm hoch
 Streuwert 1.21, horizontal: 1.15, vertikal: 1.26

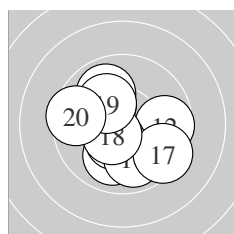

Serie 2:
 9.9 ↘ 9.7 → 10.0 ↓ 10.2 * 10.4 *
 9.9 ↓ 9.5 ↘ 10.5 * 10.2 * 9.5 ←
 beste Teiler 113.1 (18.) 133.7 (15.) 187.2 (14.)
 Trefferlage 0.23 mm links, 0.32 mm tief
 Streuwert 1.91, horizontal: 2.05, vertikal: 1.75

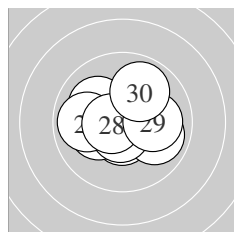

Serie 3:
 10.5 * 9.9 → 10.1 ↘ 10.2 * 10.8 *
 10.6 * 9.9 ← 10.6 * 10.0 → 9.9 ↑
 beste Teiler 46.0 (25.) 80.6 (26.) 82.8 (28.)
 Trefferlage 0.13 mm links, 0.04 mm tief
 Streuwert 1.43, horizontal: 1.73, vertikal: 1.04

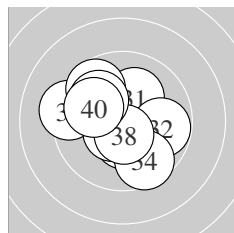

Serie 4:
 10.2 * 9.8 → 10.4 * 9.6 ↓ 9.3 ←
 10.5 * 9.7 ↘ 10.6 * 10.0 ↘ 10.0 ↘
 beste Teiler 100.4 (38.) 108.9 (36.) 137.2 (33.)
 Trefferlage 0.52 mm links, 0.10 mm hoch
 Streuwert 1.88, horizontal: 2.05, vertikal: 1.68

Unterschrift des Schuetzen

Meyton Elektronik

Ergebnis: **405.8** (388)
 Serien: 101.4 99.5 102.7 102.2
 Zaehler: 28 12 0 0 0 0 0 0 0 0
 Innenzehner: 20
 weiteste: 373 (18), 368 (24), 353 (8)
 beste Teiler 54.2 (21.) 74.0 (6.) 85.4 (28.)
 Trefferlage 0.16 mm rechts, 0.03 mm hoch
 Streuwert 1.58, horizontal: 1.71, vertikal: 1.45

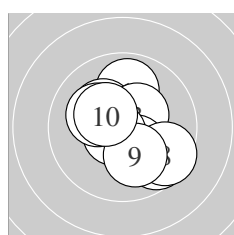
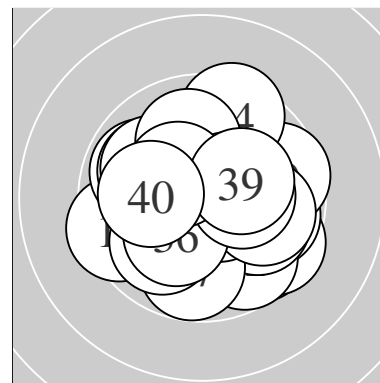

Serie 1:
 9.9 ↑ 10.2 * 10.4 * 10.3 * 9.7 ↘
 10.7 * 10.2 * 9.5 ↘ 10.1 ↓ 10.4 *
 beste Teiler 74.0 (6.) 134.0 (3.) 150.0 (10.)
 Trefferlage 0.35 mm rechts, 0.14 mm tief
 Streuwert 1.62, horizontal: 1.59, vertikal: 1.65

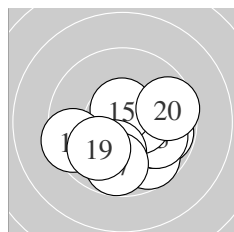

Serie 2:
 9.8 → 9.7 ↘ 9.9 ↘ 10.5 * 10.6 *
 10.1 ↓ 9.8 ↓ 9.5 ← 10.0 ✓ 9.6 →
 beste Teiler 87.1 (15.) 114.0 (14.) 216.3 (16.)
 Trefferlage 0.50 mm rechts, 1.06 mm tief
 Streuwert 1.79, horizontal: 2.14, vertikal: 1.35

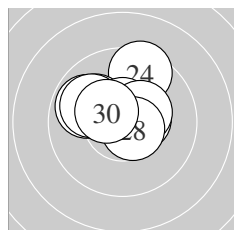

Serie 3:
 10.7 * 9.9 ↖ 10.5 * 9.5 ↑ 10.1 ↖
 10.6 * 10.4 * 10.6 * 10.0 ↖ 10.4 *
 beste Teiler 54.2 (21.) 85.4 (28.) 90.0 (26.)
 Trefferlage 0.28 mm links, 0.91 mm hoch
 Streuwert 1.30, horizontal: 1.51, vertikal: 1.03

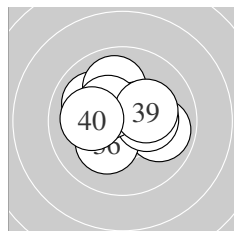

Serie 4:
 9.9 → 10.0 ↖ 10.6 * 10.0 ↑ 10.5 *
 10.2 * 10.3 * 10.4 * 10.2 * 10.1 ←
 beste Teiler 87.0 (33.) 124.7 (35.) 141.4 (38.)
 Trefferlage 0.09 mm rechts, 0.42 mm hoch
 Streuwert 1.41, horizontal: 1.69, vertikal: 1.05

Unterschrift des Schuetzen

Meyton Elektronik

Ergebnis: **412.3** (395)^{QF}
 Serien: 103.6 102.7 104.2 101.8
 Zaehler: 35 5 0 0 0 0 0 0 0 0
 Innenzehner: 31
 weiteste: 393 (34), 332 (15), 299 (36)
 beste Teiler 35.8 (30.) 36.7 (12.) 50.6 (14.)
 Trefferlage 0.11 mm rechts, 0.11 mm hoch
 Streuwert 1.28, horizontal: 1.32, vertikal: 1.25

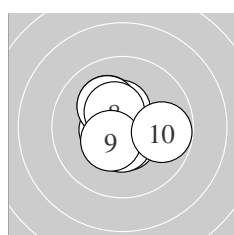
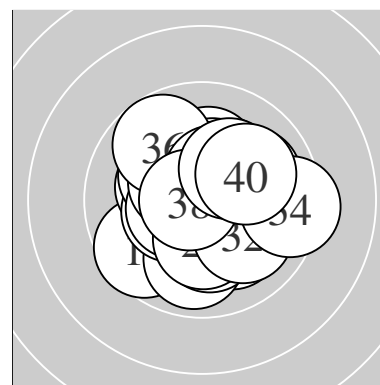

Serie 1:
 10.5 * 10.7 * 10.5 * 10.2 * 10.4 *
 10.5 * 10.2 * 10.4 * 10.4 * 9.8 →
 beste Teiler 71.7 (2.) 101.0 (3.) 102.4 (1.)
 Trefferlage 0.12 mm links, 0.14 mm hoch
 Streuwert 1.17, horizontal: 1.22, vertikal: 1.11

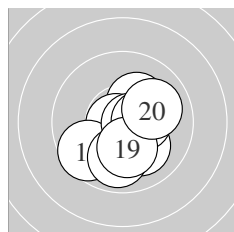

Serie 2:
 10.1 ↘ 10.8 * 10.2 * 10.8 * 9.6 ↗
 9.9 ↓ 10.7 * 10.4 * 10.2 * 10.0 →
 beste Teiler 36.7 (12.) 50.6 (14.) 66.4 (17.)
 Trefferlage 0.33 mm rechts, 0.63 mm tief
 Streuwert 1.35, horizontal: 1.33, vertikal: 1.37

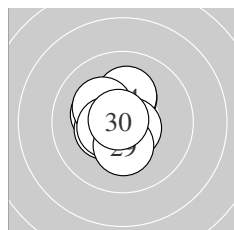

Serie 3:
 10.3 * 10.2 * 10.7 * 10.2 * 10.4 *
 10.2 * 10.6 * 10.5 * 10.3 * 10.8 *
 beste Teiler 35.8 (30.) 53.9 (23.) 77.6 (27.)
 Trefferlage 0.47 mm links, 0.19 mm hoch
 Streuwert 1.01, horizontal: 0.85, vertikal: 1.15

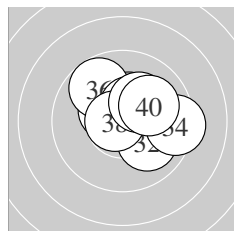

Serie 4:
 10.4 * 10.0 ↘ 10.4 * 9.4 → 10.4 *
 9.8 ↘ 10.5 * 10.7 * 10.2 * 10.0 →
 beste Teiler 56.0 (38.) 120.7 (37.) 131.6 (35.)
 Trefferlage 0.70 mm rechts, 0.77 mm hoch
 Streuwert 1.39, horizontal: 1.64, vertikal: 1.09

QF – Schütze hat sich fürs Finale qualifiziert

Unterschrift des Schuetzen

Meyton Elektronik

Ergebnis: **402.5** (384)
 Serien: 100.8 102.0 98.0 101.7
 Zaehler: 25 14 1 0 0 0 0 0 0 0
 Innenzehner: 19
 weiteste: 544 (29), 480 (2), 462 (26)
 beste Teiler 20.6 (31.) 68.2 (6.) 72.0 (34.)
 Trefferlage 0.40 mm links, 0.50 mm hoch
 Streuwert 1.78, horizontal: 2.03, vertikal: 1.49

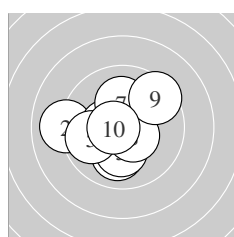
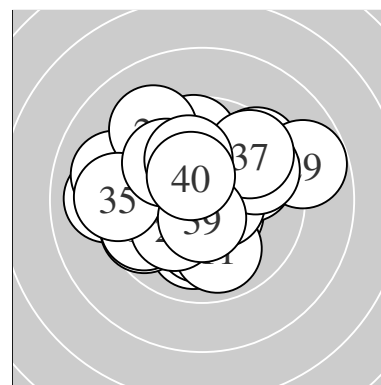

Serie 1:
 10.0 ↓ 9.0 ← 10.2 * 10.4 * 9.8 ←
 10.7 * 10.1 ↑ 10.5 * 9.5 ↗ 10.6 *
 beste Teiler 68.2 (6.) 78.1 (10.) 113.8 (8.)
 Trefferlage 0.61 mm links, 0.06 mm tief
 Streuwert 1.80, horizontal: 2.04, vertikal: 1.52

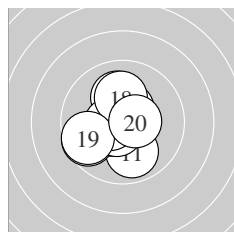

Serie 2:
 9.9 ↓ 10.5 * 10.1 ↑ 10.5 * 9.6 ←
 10.6 * 10.5 * 10.1 ↑ 9.7 ← 10.5 *
 beste Teiler 83.0 (16.) 105.2 (17.) 107.2 (20.)
 Trefferlage 0.66 mm links, 0.14 mm tief
 Streuwert 1.45, horizontal: 1.39, vertikal: 1.52

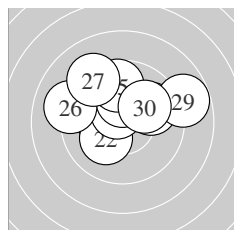

Serie 3:
 10.3 * 10.2 * 10.6 * 10.2 * 9.7 ↑
 9.1 ← 9.2 ↘ 9.9 ↗ 8.8 → 10.0 ↗
 beste Teiler 93.6 (23.) 164.1 (21.) 180.0 (24.)
 Trefferlage 0.14 mm links, 1.35 mm hoch
 Streuwert 2.16, horizontal: 2.72, vertikal: 1.41

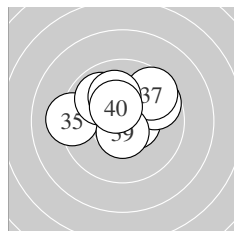

Serie 4:
 10.9 * 10.6 * 9.7 ↗ 10.7 * 9.2 ←
 9.9 ↘ 9.6 ↗ 10.1 ↓ 10.6 * 10.4 *
 beste Teiler 20.6 (31.) 72.0 (34.) 92.0 (39.)
 Trefferlage 0.17 mm links, 0.85 mm hoch
 Streuwert 1.63, horizontal: 2.02, vertikal: 1.11

Unterschrift des Schuetzen

Meyton Elektronik

Ergebnis: **411.7** (391)
 Serien: 100.2 104.1 104.6 102.8
 Zaehler: 32 7 1 0 0 0 0 0 0 0
 Innenzehner: 26
 weiteste: 609 (5), 337 (39), 284 (14)
 beste Teiler 41.1 (28.) 47.8 (33.) 53.4 (12.)
 Trefferlage 0.20 mm rechts, 0.13 mm hoch
 Streuwert 1.39, horizontal: 1.62, vertikal: 1.10

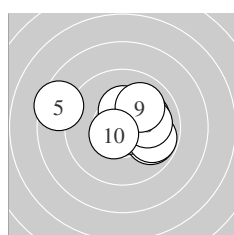
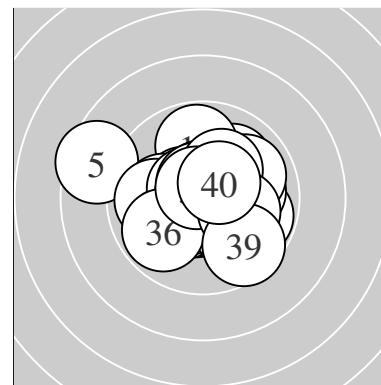

Serie 1:
 9.8 ↘ 10.7 * 10.1 → 10.3 * 8.5 ↖
 10.5 * 9.8 ↘ 10.0 → 10.0 ↗ 10.5 *
 beste Teiler 66.0 (2.) 101.2 (10.) 103.0 (6.)
 Trefferlage 0.61 mm rechts, 0.37 mm hoch
 Streuwert 1.95, horizontal: 2.51, vertikal: 1.13

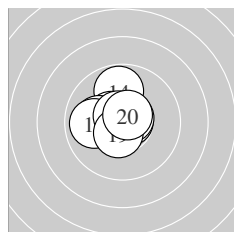

Serie 2:
 10.6 * 10.7 * 10.7 * 9.8 ↑ 10.5 *
 10.1 ← 9.9 ← 10.7 * 10.5 * 10.6 *
 beste Teiler 53.4 (12.) 69.6 (13.) 71.6 (18.)
 Trefferlage 0.62 mm links, 0.38 mm hoch
 Streuwert 1.03, horizontal: 1.08, vertikal: 0.99

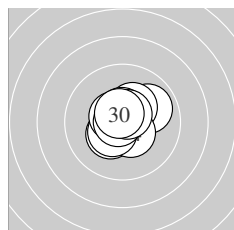

Serie 3:
 9.9 ↗ 10.3 * 10.3 * 10.5 * 10.4 *
 10.6 * 10.6 * 10.8 * 10.6 * 10.6 *
 beste Teiler 41.1 (28.) 81.6 (29.) 83.5 (30.)
 Trefferlage 0.07 mm rechts, 0.25 mm hoch
 Streuwert 0.98, horizontal: 1.03, vertikal: 0.92

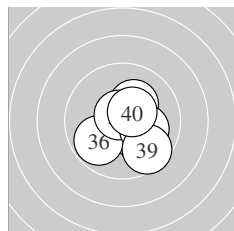

Serie 4:
 10.6 * 10.1 ↘ 10.8 * 10.2 * 10.4 *
 9.8 ↙ 10.7 * 10.1 ↘ 9.6 ↘ 10.5 *
 beste Teiler 47.8 (33.) 64.6 (37.) 78.3 (31.)
 Trefferlage 0.73 mm rechts, 0.49 mm tief
 Streuwert 1.25, horizontal: 1.26, vertikal: 1.24

Unterschrift des Schuetzen

Meyton Elektronik

Ergebnis: **402.5** (383)
 Serien: 98.4 101.8 100.5 101.8
 Zaehler: 23 17 0 0 0 0 0 0 0 0
 Innenzehner: 17
 weiteste: 473 (38), 448 (22), 425 (6)
 beste Teiler 14.0 (31.) 40.3 (33.) 54.7 (40.)
 Trefferlage 0.26 mm links, 0.16 mm hoch
 Streuwert 1.81, horizontal: 2.15, vertikal: 1.39

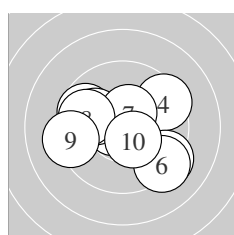
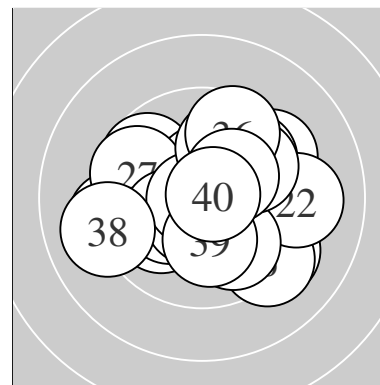

Serie 1:
 10.7 * 9.7 ↖ 10.0 ↖ 9.4 ↗ 9.3 ↘
 9.3 ↘ 10.5 * 9.8 ↖ 9.3 ↖ 10.4 *
 beste Teiler 69.0 (1.) 122.3 (7.) 128.4 (10.)
 Trefferlage 0.17 mm links, 0.14 mm tief
 Streuwert 2.30, horizontal: 2.81, vertikal: 1.64

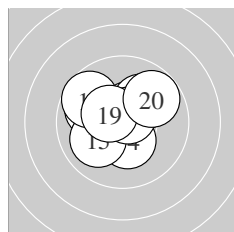

Serie 2:
 10.5 * 9.9 ↖ 10.2 * 10.4 * 10.0 ↗
 10.1 ↗ 10.7 * 9.7 ↖ 10.5 * 9.8 ↗
 beste Teiler 66.8 (17.) 115.4 (11.) 123.7 (19.)
 Trefferlage 0.45 mm links, 0.46 mm hoch
 Streuwert 1.50, horizontal: 1.70, vertikal: 1.27

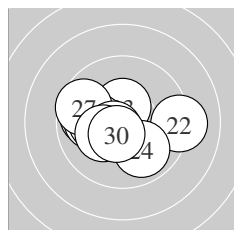

Serie 3:
 9.9 ↖ 9.2 → 10.5 * 9.9 ↘ 10.0 ←
 10.1 ← 9.6 ↖ 10.6 * 10.2 * 10.5 *
 beste Teiler 92.4 (28.) 105.5 (30.) 122.0 (23.)
 Trefferlage 0.69 mm links, 0.18 mm tief
 Streuwert 1.77, horizontal: 2.29, vertikal: 1.01

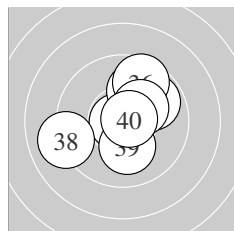

Serie 4:
 10.9 * 10.6 * 10.8 * 9.9 ↗ 9.8 ↗
 9.6 ↗ 10.3 * 9.1 ↖ 10.1 ↓ 10.7 *
 beste Teiler 14.0 (31.) 40.3 (33.) 54.7 (40.)
 Trefferlage 0.27 mm rechts, 0.52 mm hoch
 Streuwert 1.72, horizontal: 1.85, vertikal: 1.58

Unterschrift des Schuetzen

Meyton Elektronik

Ergebnis: **409.2** (391)
 Serien: 99.7 104.5 103.6 101.4
 Zaehler: 32 7 1 0 0 0 0 0 0 0
 Innenzehner: 27
 weiteste: 546 (10), 428 (2), 423 (38)
 beste Teiler 46.0 (16.) 47.8 (29.) 50.9 (18.)
 Trefferlage 0.10 mm rechts, 0.21 mm tief
 Streuwert 1.52, horizontal: 1.92, vertikal: 0.94

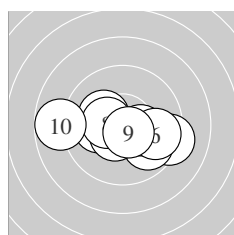
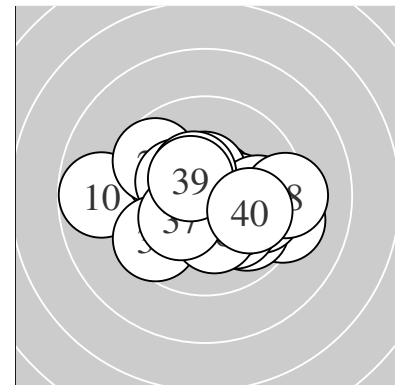

Serie 1:
 10.1 ← 9.2 → 9.8 ↘ 10.3 * 10.2 *
 9.8 → 10.5 * 10.4 * 10.6 * 8.8 ←
 beste Teiler 81.6 (9.) 111.6 (7.) 137.6 (8.)
 Trefferlage 0.00 mm , 0.48 mm tief
 Streuwert 2.06, horizontal: 2.82, vertikal: 0.74

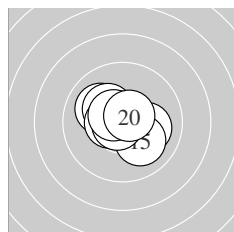

Serie 2:
 10.7 * 10.1 → 10.0 ↖ 10.3 * 10.1 ↘
 10.8 * 10.5 * 10.8 * 10.6 * 10.6 *
 beste Teiler 46.0 (16.) 50.9 (18.) 54.1 (11.)
 Trefferlage 0.08 mm links, 0.16 mm hoch
 Streuwert 1.08, horizontal: 1.28, vertikal: 0.83

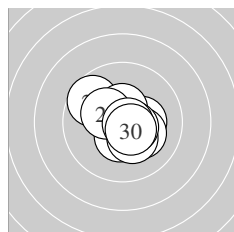

Serie 3:
 10.3 * 10.2 * 10.4 * 10.3 * 9.7 ↖
 10.5 * 10.3 * 10.5 * 10.8 * 10.6 *
 beste Teiler 47.8 (29.) 97.0 (30.) 101.0 (28.)
 Trefferlage 0.18 mm rechts, 0.10 mm tief
 Streuwert 1.21, horizontal: 1.34, vertikal: 1.07

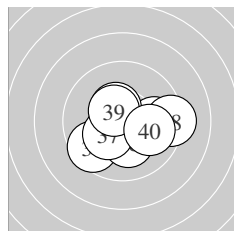

Serie 4:
 9.8 → 10.6 * 10.7 * 9.6 ↙ 10.4 *
 10.2 * 10.3 * 9.3 → 10.5 * 10.0 →
 beste Teiler 60.1 (33.) 80.3 (32.) 118.5 (39.)
 Trefferlage 0.32 mm rechts, 0.44 mm tief
 Streuwert 1.69, horizontal: 2.13, vertikal: 1.09

Unterschrift des Schuetzen

Meyton Elektronik

Ergebnis: **411.9** (397)^{QF}
 Serien: 103.3 103.6 102.9 102.1
 Zaehler: 37 3 0 0 0 0 0 0 0 0
 Innenzehner: 28
 weiteste: 289 (35), 281 (34), 255 (30)
 beste Teiler 51.8 (22.) 54.4 (3.) 65.7 (15.)
 Trefferlage 0.02 mm rechts, 0.23 mm hoch
 Streuwert 1.24, horizontal: 1.33, vertikal: 1.15

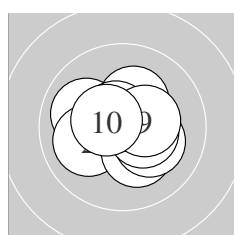
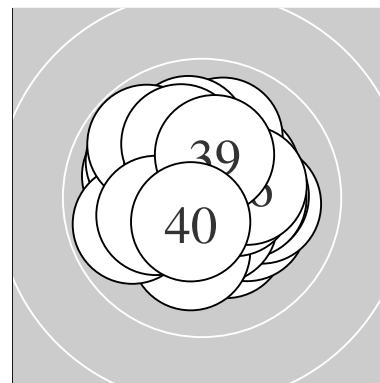

Serie 1:
 10.0 ↖ 10.0 ← 10.7 * 10.2 * 10.2 *
 10.3 * 10.4 * 10.6 * 10.4 * 10.5 *
 beste Teiler 54.4 (3.) 78.7 (8.) 110.1 (10.)
 Trefferlage 0.04 mm rechts, 0.00 mm
 Streuwert 1.22, horizontal: 1.45, vertikal: 0.95

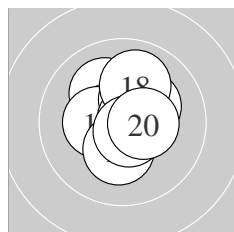

Serie 2:
 10.5 * 10.1 ↗ 10.3 * 10.3 * 10.7 *
 10.3 * 10.3 * 10.0 ↑ 10.7 * 10.4 *
 beste Teiler 65.7 (15.) 69.0 (19.) 119.1 (11.)
 Trefferlage 0.35 mm rechts, 0.43 mm hoch
 Streuwert 1.11, horizontal: 1.02, vertikal: 1.20

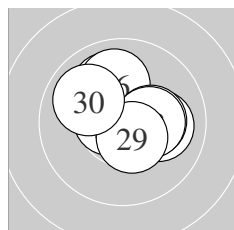

Serie 3:
 10.0 ↗ 10.7 * 10.6 * 10.1 → 10.6 *
 10.0 ↑ 10.2 * 10.3 * 10.5 * 9.9 ↖
 beste Teiler 51.8 (22.) 85.5 (23.) 93.2 (25.)
 Trefferlage 0.28 mm rechts, 0.39 mm hoch
 Streuwert 1.28, horizontal: 1.40, vertikal: 1.16

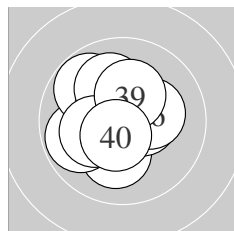

Serie 4:
 10.1 ↓ 10.5 * 10.5 * 9.8 ← 9.8 ↖
 10.2 * 10.1 ↗ 10.2 * 10.3 * 10.6 *
 beste Teiler 99.7 (40.) 117.3 (33.) 122.1 (32.)
 Trefferlage 0.58 mm links, 0.13 mm hoch
 Streuwert 1.39, horizontal: 1.40, vertikal: 1.38

QF – Schütze hat sich fürs Finale qualifiziert

Unterschrift des Schuetzen

Meyton Elektronik

Ergebnis: **407.9** (389)
 Serien: 103.6 100.3 100.3 103.7
 Zaehler: 30 9 1 0 0 0 0 0 0 0
 Innenzehner: 27
 weiteste: 575 (15), 446 (21), 415 (28)
 beste Teiler 20.2 (4.) 51.6 (3.) 65.4 (7.)
 Trefferlage 0.00 mm , 0.11 mm hoch
 Streuwert 1.57, horizontal: 2.01, vertikal: 0.95

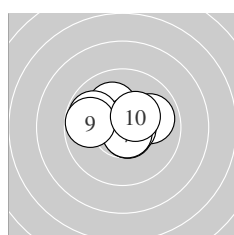
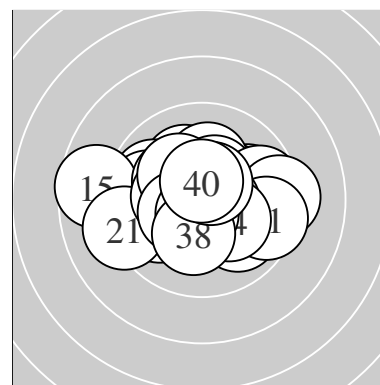

Serie 1:
 10.1 ↖ 9.9 → 10.7 * 10.9 * 10.7 *
 10.6 * 10.7 * 9.8 ↙ 9.8 ← 10.4 *
 beste Teiler 20.2 (4.) 51.6 (3.) 65.4 (7.)
 Trefferlage 0.07 mm links, 0.42 mm hoch
 Streuwert 1.28, horizontal: 1.65, vertikal: 0.74

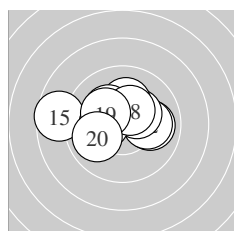

Serie 2:
 10.0 → 10.1 → 10.3 * 10.2 * 8.7 ←
 10.2 * 10.3 * 10.4 * 10.2 * 9.9 ↙
 beste Teiler 140.9 (18.) 159.6 (13.) 168.0 (17.)
 Trefferlage 0.55 mm links, 0.59 mm hoch
 Streuwert 1.86, horizontal: 2.47, vertikal: 0.90

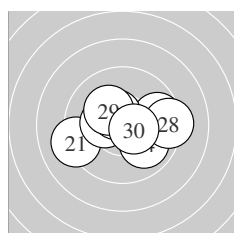

Serie 3:
 9.2 ↙ 10.4 * 10.3 * 9.9 ↘ 9.7 →
 10.3 * 10.5 * 9.3 → 10.2 * 10.5 *
 beste Teiler 106.8 (30.) 109.9 (27.) 140.0 (22.)
 Trefferlage 0.27 mm rechts, 0.03 mm tief
 Streuwert 1.91, horizontal: 2.51, vertikal: 1.00

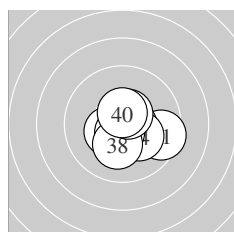

Serie 4:
 9.5 → 10.6 * 10.6 * 10.2 * 10.6 *
 10.4 * 10.6 * 10.2 * 10.5 * 10.5 *
 beste Teiler 76.6 (35.) 79.7 (37.) 90.8 (32.)
 Trefferlage 0.37 mm rechts, 0.51 mm tief
 Streuwert 1.12, horizontal: 1.32, vertikal: 0.88

Unterschrift des Schuetzen

Meyton Elektronik

Ergebnis: **407.4** (389)
 Serien: 99.3 102.7 103.3 102.1
 Zaehler: 29 11 0 0 0 0 0 0 0 0
 Innenzehner: 24
 weiteste: 458 (6), 383 (9), 355 (10)
 beste Teiler 61.6 (4.) 67.0 (26.) 68.6 (5.)
 Trefferlage 0.47 mm links, 0.27 mm hoch
 Streuwert 1.48, horizontal: 1.63, vertikal: 1.32

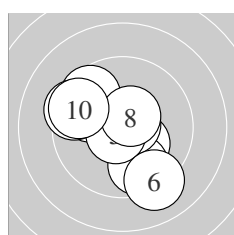
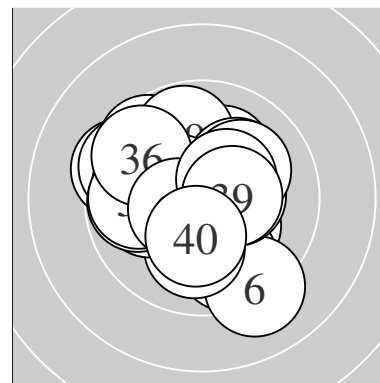

Serie 1:
 10.2 * 9.7 ↘ 9.9 ↖ 10.7 * 10.7 *
 9.1 ↘ 9.6 ↖ 10.5 * 9.4 ↖ 9.5 ↖
 beste Teiler 61.6 (4.) 68.6 (5.) 101.0 (8.)
 Trefferlage 0.62 mm links, 0.12 mm tief
 Streuwert 2.07, horizontal: 2.13, vertikal: 2.00

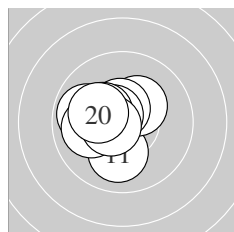

Serie 2:
 10.1 ↓ 10.2 * 10.3 * 10.5 * 9.9 ↖
 10.0 ← 10.6 * 10.3 * 10.6 * 10.2 *
 beste Teiler 88.6 (17.) 90.1 (19.) 102.7 (14.)
 Trefferlage 1.10 mm links, 0.23 mm hoch
 Streuwert 1.07, horizontal: 1.13, vertikal: 1.00

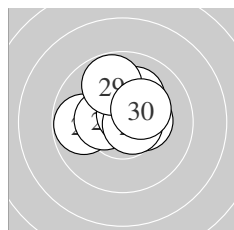

Serie 3:
 9.8 ← 10.6 * 10.5 * 10.4 * 10.4 *
 10.7 * 10.1 ↗ 10.7 * 9.8 ↑ 10.3 *
 beste Teiler 67.0 (26.) 75.3 (28.) 85.9 (22.)
 Trefferlage 0.14 mm rechts, 0.71 mm hoch
 Streuwert 1.19, horizontal: 1.40, vertikal: 0.94

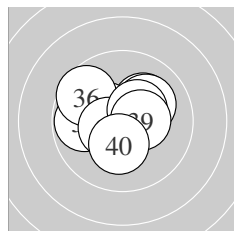

Serie 4:
 9.8 ← 10.1 ↗ 10.4 * 10.1 ↗ 10.5 *
 9.6 ↖ 10.5 * 10.4 * 10.4 * 10.3 *
 beste Teiler 103.2 (35.) 116.3 (37.) 134.1 (33.)
 Trefferlage 0.29 mm links, 0.29 mm hoch
 Streuwert 1.43, horizontal: 1.69, vertikal: 1.10

Unterschrift des Schuetzen

Meyton Elektronik

Ergebnis: **416.3** (397)^{QF}
 Serien: 102.4 104.3 104.7 104.9
 Zaehler: 37 3 0 0 0 0 0 0 0 0
 Innenzehner: 32
 weiteste: 419 (2), 387 (12), 284 (4)
 beste Teiler 31.4 (20.) 44.6 (27.) 59.0 (34.)
 Trefferlage 0.35 mm rechts, 0.07 mm tief
 Streuwert 1.13, horizontal: 1.29, vertikal: 0.93

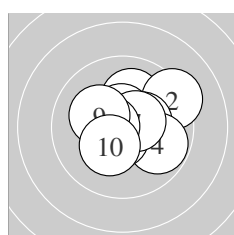
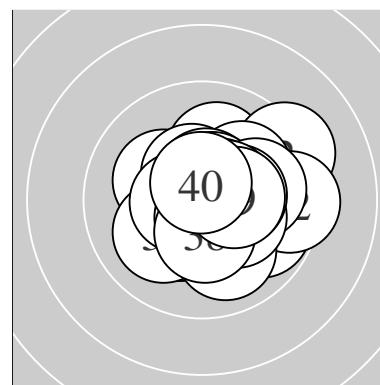

Serie 1:
 10.1 ↗ 9.3 ↘ 10.4 * 9.8 ↘ 10.6 *
 10.6 * 10.5 * 10.6 * 10.2 * 10.3 *
 beste Teiler 83.9 (5.) 96.4 (6.) 98.1 (8.)
 Trefferlage 0.51 mm rechts, 0.35 mm hoch
 Streuwert 1.47, horizontal: 1.68, vertikal: 1.21

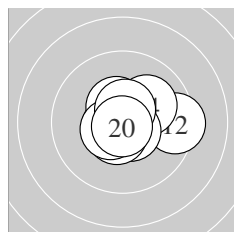

Serie 2:
 10.6 * 9.4 → 10.6 * 10.1 ↗ 10.6 *
 10.6 * 10.5 * 10.5 * 10.6 * 10.8 *
 beste Teiler 31.4 (20.) 82.1 (11.) 82.6 (13.)
 Trefferlage 0.43 mm rechts, 0.00 mm
 Streuwert 1.16, horizontal: 1.44, vertikal: 0.79

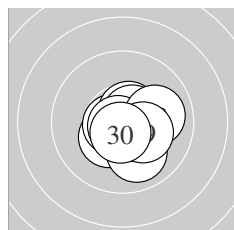

Serie 3:
 10.4 * 10.0 ↘ 10.7 * 10.7 * 10.6 *
 10.6 * 10.8 * 10.0 → 10.3 * 10.6 *
 beste Teiler 44.6 (27.) 66.4 (24.) 73.2 (23.)
 Trefferlage 0.43 mm rechts, 0.40 mm tief
 Streuwert 0.96, horizontal: 1.04, vertikal: 0.88

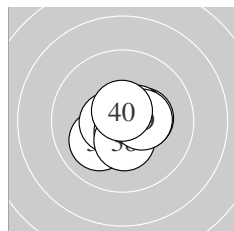

Serie 4:
 10.1 ↙ 10.7 * 10.3 * 10.7 * 10.6 *
 10.5 * 10.6 * 10.4 * 10.4 * 10.6 *
 beste Teiler 59.0 (34.) 60.4 (32.) 76.1 (40.)
 Trefferlage 0.03 mm rechts, 0.25 mm tief
 Streuwert 0.90, horizontal: 1.05, vertikal: 0.74

QF – Schütze hat sich fürs Finale qualifiziert

Unterschrift des Schuetzen

Meyton Elektronik

Ergebnis: **407.7** (390)
 Serien: 101.7 104.6 99.9 101.5
 Zaehler: 30 10 0 0 0 0 0 0 0 0
 Innenzehner: 25
 weiteste: 449 (22), 405 (30), 370 (26)
 beste Teiler 8.2 (19.) 41.6 (6.) 52.8 (20.)
 Trefferlage 0.43 mm rechts, 0.16 mm hoch
 Streuwert 1.52, horizontal: 1.82, vertikal: 1.15

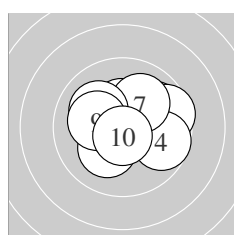
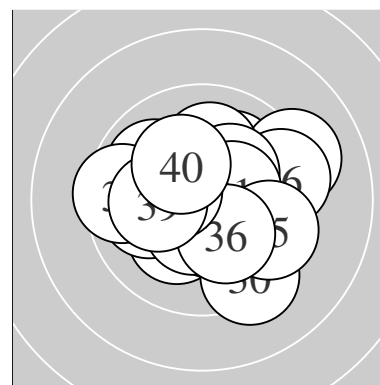

Serie 1:
 9.9 → 10.4 * 9.6 → 9.7 → 10.2 *
 10.8 * 10.1 ↗ 10.1 ↖ 10.2 * 10.7 *
 beste Teiler 41.6 (6.) 65.0 (10.) 143.4 (2.)
 Trefferlage 0.46 mm rechts, 0.36 mm hoch
 Streuwert 1.58, horizontal: 1.91, vertikal: 1.17

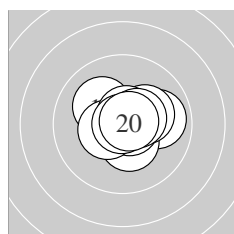

Serie 2:
 9.9 → 10.1 ↖ 10.4 * 10.2 * 10.7 *
 10.5 * 10.7 * 10.5 * 10.9 * 10.7 *
 beste Teiler 8.2 (19.) 52.8 (20.) 54.8 (15.)
 Trefferlage 0.43 mm rechts, 0.19 mm hoch
 Streuwert 1.00, horizontal: 1.21, vertikal: 0.73

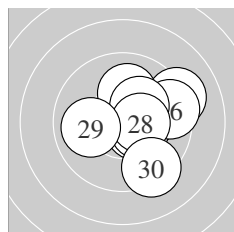

Serie 3:
 10.2 * 9.2 → 10.5 * 10.1 ↑ 10.4 *
 9.5 → 10.3 * 10.4 * 10.0 ← 9.3 ↘
 beste Teiler 114.5 (23.) 135.1 (28.) 140.2 (25.)
 Trefferlage 1.44 mm rechts, 0.13 mm hoch
 Streuwert 1.69, horizontal: 1.78, vertikal: 1.60

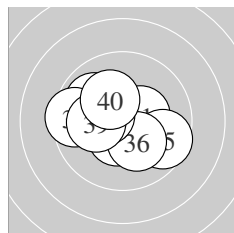

Serie 4:
 10.4 * 9.9 ↖ 10.6 * 10.5 * 9.6 →
 10.2 * 9.5 ← 10.4 * 10.2 * 10.2 *
 beste Teiler 91.5 (33.) 122.0 (34.) 139.7 (38.)
 Trefferlage 0.59 mm links, 0.01 mm tief
 Streuwert 1.58, horizontal: 1.95, vertikal: 1.09

Unterschrift des Schuetzen

Ergebnis:	400.1	(382)
Serien:	100.2	100.3 99.0 100.6
Zaehler:	25	12 3 0 0 0 0 0 0 0
Innenzehner:	18	
weiteste:	519 (3), 515 (22), 511 (10)	
beste Teiler	46.4 (31.)	53.1 (12.) 63.7 (4.)
Trefferlage	0.29 mm rechts,	0.44 mm hoch
Streuwert	1.91, horizontal:	2.09, vertikal: 1.70

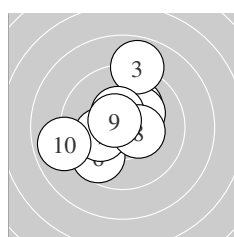
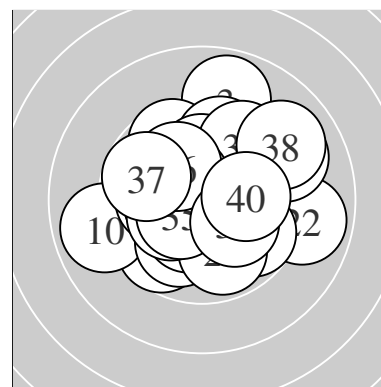

Serie 1:	10.1 ↗	10.2 *	8.9 ↑	10.7 *	10.5 *
	9.7 ↘	10.2 *	10.4 *	10.6 *	8.9 ←
beste Teiler	63.7 (4.)	87.3 (9.)	125.2 (5.)		
Trefferlage	0.53 mm links, 0.53 mm hoch				
Streuwert	2.02, horizontal: 2.01, vertikal: 2.04				

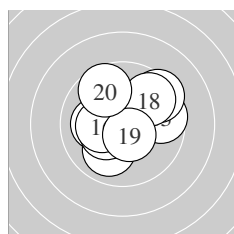

Serie 2:	10.0 ↘	10.7 *	9.6 →	10.1 ←	10.3 *
	10.3 *	9.4 ↗	9.7 ↗	10.5 *	9.7 ↘
beste Teiler	53.1 (12.)	106.0 (19.)	157.0 (15.)		
Trefferlage	0.09 mm rechts, 0.45 mm hoch				
Streuwert	1.82, horizontal: 2.03, vertikal: 1.59				

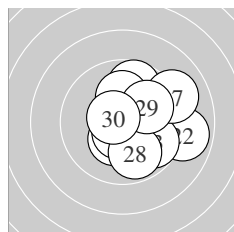

Serie 3:	10.3 *	8.9 →	9.8 ↘	9.7 ↑	10.1 ↑
	10.6 *	9.1 →	9.9 ↓	10.0 ↗	10.6 *
beste Teiler	87.2 (30.)	94.3 (26.)	157.4 (21.)		
Trefferlage	1.38 mm rechts, 0.13 mm hoch				
Streuwert	1.96, horizontal: 2.03, vertikal: 1.90				

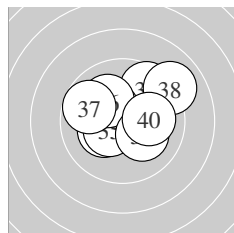

Serie 4:	10.8 *	9.6 ↗	10.4 *	10.3 *	10.4 *
	10.1 ↘	9.7 ↘	9.0 ↗	10.2 *	10.1 →
beste Teiler	46.4 (31.)	127.0 (33.)	130.9 (35.)		
Trefferlage	0.21 mm rechts, 0.64 mm hoch				
Streuwert	1.83, horizontal: 2.13, vertikal: 1.46				

Unterschrift des Schuetzen

Meyton Elektronik

Ergebnis: **409.6** (391)
 Serien: 101.9 102.9 100.8 104.0
 Zaehler: 31 9 0 0 0 0 0 0 0 0
 Innenzehner: 24
 weiteste: 454 (3), 392 (26), 320 (1)
 beste Teiler 13.8 (15.) 35.5 (12.) 58.0 (25.)
 Trefferlage 0.27 mm rechts, 0.02 mm tief
 Streuwert 1.43, horizontal: 1.74, vertikal: 1.04

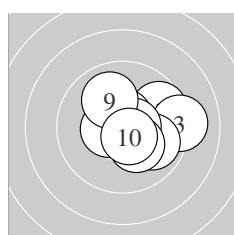
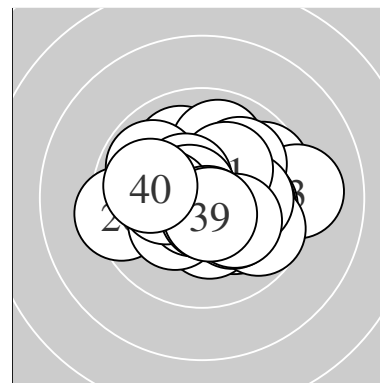

Serie 1:
 9.7 ↗ 10.6 * 9.1 → 10.6 * 10.5 *
 9.9 ↘ 10.6 * 10.3 * 10.0 ↖ 10.6 *
 beste Teiler 78.9 (4.) 81.4 (2.) 82.2 (7.)
 Trefferlage 1.08 mm rechts, 0.08 mm hoch
 Streuwert 1.46, horizontal: 1.75, vertikal: 1.11

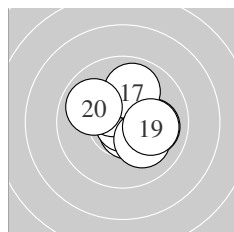

Serie 2:
 10.0 → 10.8 * 10.3 * 10.6 * 10.9 *
 10.4 * 9.9 ↑ 10.1 ↘ 10.0 → 9.9 ↖
 beste Teiler 13.8 (15.) 35.5 (12.) 77.4 (14.)
 Trefferlage 0.57 mm rechts, 0.10 mm hoch
 Streuwert 1.28, horizontal: 1.39, vertikal: 1.16

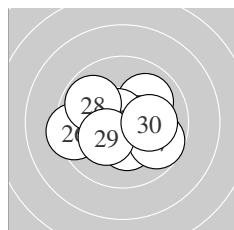

Serie 3:
 10.5 * 10.0 ↗ 10.0 ← 10.3 * 10.7 *
 9.4 ← 9.7 ↘ 9.8 ↖ 10.3 * 10.1 →
 beste Teiler 58.0 (25.) 104.0 (21.) 164.9 (24.)
 Trefferlage 0.43 mm links, 0.18 mm tief
 Streuwert 1.73, horizontal: 2.17, vertikal: 1.13

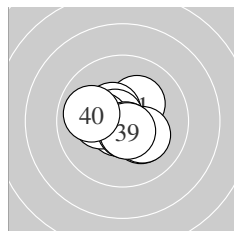

Serie 4:
 10.2 * 10.7 * 10.2 * 10.2 * 10.5 *
 10.7 * 10.3 * 10.7 * 10.6 * 9.9 ↖
 beste Teiler 66.6 (36.) 68.0 (32.) 75.5 (38.)
 Trefferlage 0.12 mm links, 0.11 mm tief
 Streuwert 1.13, horizontal: 1.34, vertikal: 0.87

Unterschrift des Schuetzen

Meyton Elektronik

Ergebnis:	412.3	(394) ^{QF}
Serien:	103.5	102.6 102.2 104.0
Zaehler:	34	6 0 0 0 0 0 0 0 0 0
Innenzehner:	30	
weiteste:	385	(23), 294 (6), 281 (37)
beste Teiler	6.0	(7.) 17.8 (38.) 18.0 (34.)
Trefferlage	0.11 mm	rechts, 0.11 mm hoch
Streuwert	1.29,	horizontal: 1.53, vertikal: 1.01

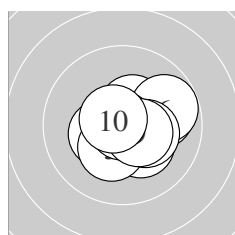
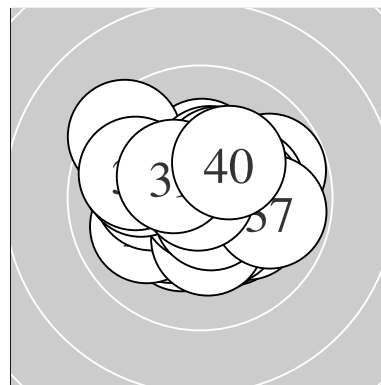

Serie 1:	10.4 *	9.9 →	10.4 *	10.3 *	10.3 *
	9.8 →	10.9 *	10.3 *	10.5 *	10.7 *
beste Teiler	6.0	(7.) 74.3	(10.) 117.6	(9.)	
Trefferlage	0.69 mm	rechts,	0.10 mm	tief	
Streuwert	1.16,	horizontal: 1.36,	vertikal: 0.91		

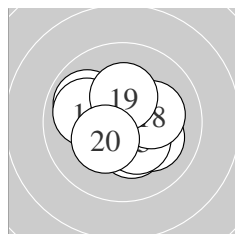

Serie 2:	10.3 *	10.1 ↘	9.9 ↖	10.7 *	10.3 *
	10.0 ↖	10.5 *	10.2 *	10.3 *	10.3 *
beste Teiler	60.4	(14.) 111.1	(17.) 151.6	(15.)	
Trefferlage	0.09 mm	rechts,	0.01 mm	tief	
Streuwert	1.35,	horizontal: 1.54,	vertikal: 1.12		

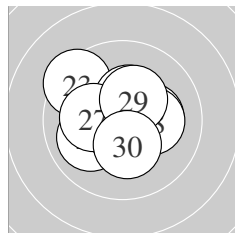

Serie 3:	10.0 ↙	10.5 *	9.4 ↘	10.4 *	10.7 *
	10.2 *	10.2 *	10.2 *	10.3 *	10.3 *
beste Teiler	72.1	(25.) 103.3	(22.) 144.1	(24.)	
Trefferlage	0.25 mm	links,	0.17 mm	hoch	
Streuwert	1.47,	horizontal: 1.65,	vertikal: 1.27		

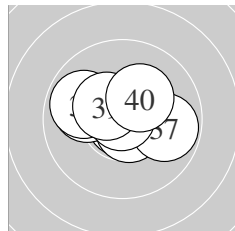

Serie 4:	10.9 *	10.0 ↖	10.3 *	10.9 *	10.7 *
	9.9 ↖	9.8 →	10.9 *	10.4 *	10.2 *
beste Teiler	17.8	(38.) 18.0	(34.) 23.7	(31.)	
Trefferlage	0.06 mm	links,	0.41 mm	hoch	
Streuwert	1.25,	horizontal: 1.61,	vertikal: 0.73		

QF – Schütze hat sich fürs Finale qualifiziert

Unterschrift des Schuetzen

Meyton Elektronik

Ergebnis:	406.5	(385)
Serien:	103.8	99.9 101.7 101.1
Zaehler:	25	15 0 0 0 0 0 0 0 0
Innenzehner:	22	
weiteste:	400	(38), 395 (22), 335 (28)
beste Teiler	15.2	(36.) 29.2 (27.) 67.6 (7.)
Trefferlage	0.40 mm	rechts, 0.25 mm hoch
Streuwert	1.54,	horizontal: 1.67, vertikal: 1.39

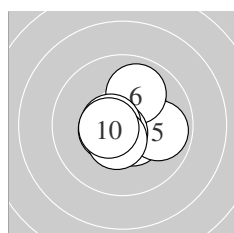
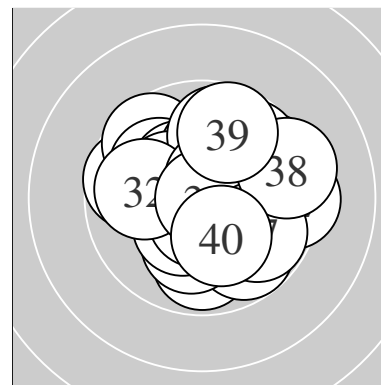

Serie 1:	10.5 *	10.3 *	10.4 *	10.5 *	9.9 →
	9.9 ↗	10.7 *	10.6 *	10.5 *	10.5 *
beste Teiler	67.6	(7.) 88.2 (8.)	105.1 (10.)		
Trefferlage	0.28 mm	rechts, 0.10 mm	hoch		
Streuwert	1.14,	horizontal: 1.22,	vertikal: 1.05		

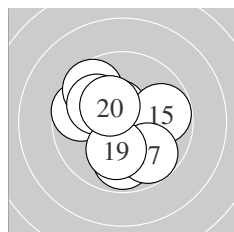

Serie 2:	9.8 ↓	10.2 *	9.7 ↖	10.6 *	9.8 →
	9.6 ↘	9.8 ↘	10.0 ↖	10.1 ↓	10.3 *
beste Teiler	98.2	(14.) 153.8 (20.)	182.4 (12.)		
Trefferlage	0.28 mm	links, 0.09 mm	tief		
Streuwert	1.85,	horizontal: 1.89,	vertikal: 1.81		

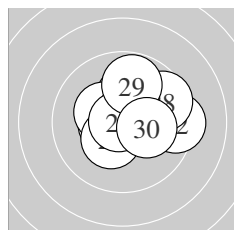

Serie 3:	10.5 *	9.4 →	10.1 ↑	10.3 *	10.6 *
	10.4 *	10.8 *	9.6 ↗	9.8 ↑	10.2 *
beste Teiler	29.2	(27.) 85.0 (25.)	108.5 (21.)		
Trefferlage	0.65 mm	rechts, 0.59 mm	hoch		
Streuwert	1.52,	horizontal: 1.76,	vertikal: 1.22		

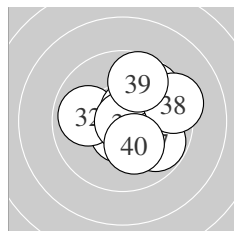

Serie 4:	10.6 *	9.9 ↖	10.3 *	9.7 ↗	10.6 *
	10.9 *	9.8 ↘	9.4 →	9.7 ↑	10.2 *
beste Teiler	15.2	(36.) 87.8 (31.)	97.4 (35.)		
Trefferlage	0.97 mm	rechts, 0.39 mm	hoch		
Streuwert	1.61,	horizontal: 1.71,	vertikal: 1.50		

Unterschrift des Schuetzen

Meyton Elektronik

Ergebnis:	397.3	(380)
Serien:	97.5	99.7 100.3 99.8
Zaehler:	22	16 2 0 0 0 0 0 0 0
Innenzehner:	12	
weiteste:	594	(7), 539 (33), 479 (10)
beste Teiler	38.6	(36.) 64.0 (9.) 107.3 (30.)
Trefferlage	0.10 mm	links, 0.44 mm hoch
Streuwert	1.98,	horizontal: 1.89, vertikal: 2.06

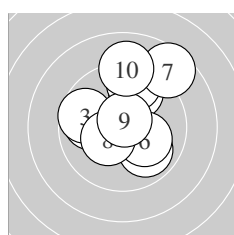
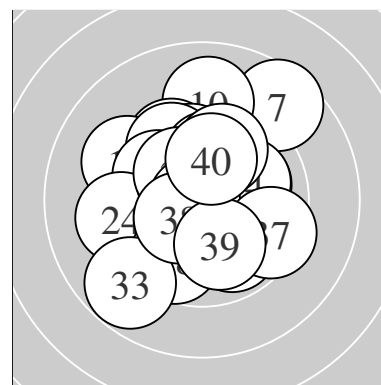

Serie 1:	9.9 ←	9.7 ↑	9.7 ↖	9.9 ↘	9.5 ↑
	10.1 ↘	8.6 ↗	10.4 *	10.7 *	9.0 ↑
beste Teiler	64.0	(9.) 149.2 (8.)	205.8 (6.)		
Trefferlage	0.30 mm	rechts, 1.40 mm hoch			
Streuwert	2.25,	horizontal: 2.09, vertikal: 2.41			

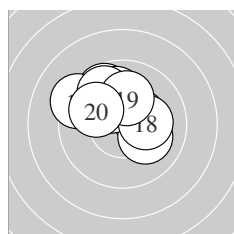

Serie 2:	9.7 ↘	10.4 *	9.9 ↑	9.3 ↖	10.1 ↘
	10.2 *	9.8 ↘	10.2 *	10.1 ↑	10.0 ↖
beste Teiler	145.4	(12.) 178.3 (16.)	189.5 (18.)		
Trefferlage	0.49 mm	links, 1.41 mm hoch			
Streuwert	1.55,	horizontal: 1.84, vertikal: 1.21			

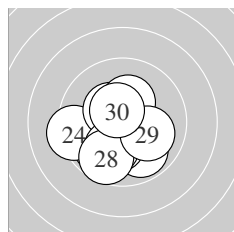

Serie 3:	9.9 ↘	9.9 ↙	10.2 *	9.3 ←	10.4 *
	10.0 ↓	10.3 *	9.7 ↓	10.1 ↘	10.5 *
beste Teiler	107.3	(30.) 141.4 (25.)	166.9 (27.)		
Trefferlage	0.59 mm	links, 0.92 mm tief			
Streuwert	1.64,	horizontal: 1.70, vertikal: 1.58			

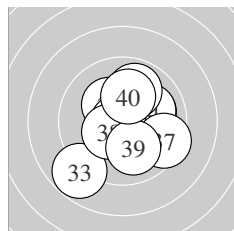

Serie 4:	10.0 →	10.3 *	8.8 ↙	10.0 →	9.9 ↑
	10.8 *	9.5 ↘	10.4 *	10.0 ↓	10.1 ↑
beste Teiler	38.6	(36.) 141.6 (38.)	173.8 (32.)		
Trefferlage	0.38 mm	rechts, 0.14 mm tief			
Streuwert	2.03,	horizontal: 2.00, vertikal: 2.05			

Unterschrift des Schuetzen

Meyton Elektronik