

Ergebnis: **618.1** (590)

Serien: 102.7 104.5 102.7 101.3 103.8 103.1

Zähler: 50 10 0 0 0 0 0 0 0

Innenzehner: 41

weiteste: 357 (52), 317 (26), 303 (49)

beste Teiler 26.4 (12.) 35.3 (3.) 44.1 (24.)

Trefferlage 0.13 mm rechts, 0.11 mm hoch

Streuwert 1.28, horizontal: 1.34, vertikal: 1.21

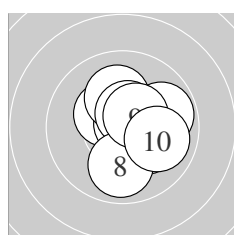
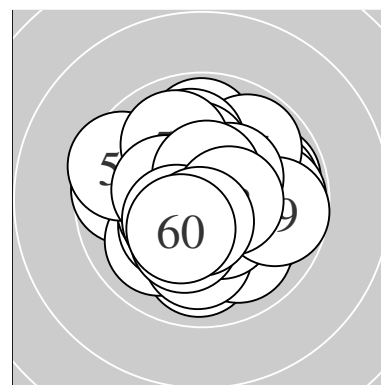

Serie 1:

10.4 *	10.2 *	10.8 *	9.8 →	10.5 *
10.1 ↑	10.5 *	9.9 ↓	10.5 *	10.0 →

beste Teiler 35.3 (3.) 101.2 (7.) 110.9 (5.)

Trefferlage 0.69 mm rechts, 0.23 mm hoch

Streuwert 1.26, horizontal: 1.20, vertikal: 1.33

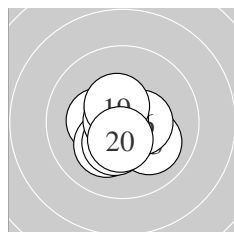

Serie 2:

10.3 *	10.8 *	10.0 ↘	10.2 *	10.6 *
10.5 *	10.3 *	10.8 *	10.5 *	10.5 *

beste Teiler 26.4 (12.) 47.8 (18.) 97.6 (15.)

Trefferlage 0.16 mm links, 0.30 mm tief

Streuwert 1.00, horizontal: 1.01, vertikal: 0.99

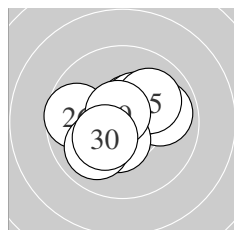

Serie 3:

10.5 *	9.9 →	10.4 *	10.8 *	10.0 ↗
9.7 ←	10.4 *	10.0 ↖	10.7 *	10.3 *

beste Teiler 44.1 (24.) 69.3 (29.) 113.5 (21.)

Trefferlage 0.13 mm links, 0.15 mm hoch

Streuwert 1.42, horizontal: 1.68, vertikal: 1.09

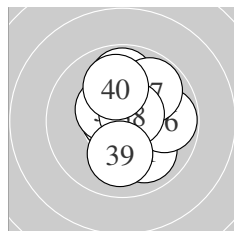

Serie 4:

10.0 ↘	10.7 *	9.8 ↑	10.4 *	10.1 →
9.8 →	9.8 ↗	10.6 *	10.1 ↓	10.0 ↑

beste Teiler 65.7 (32.) 78.4 (38.) 128.8 (34.)

Trefferlage 0.67 mm rechts, 0.47 mm hoch

Streuwert 1.52, horizontal: 1.34, vertikal: 1.67

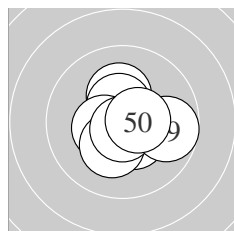

Serie 5:

10.2 *	10.5 *	10.5 *	10.5 *	10.4 *
10.4 *	10.3 *	10.8 *	9.7 →	10.5 *

beste Teiler 49.0 (48.) 101.3 (44.) 105.6 (50.)

Trefferlage 0.37 mm rechts, 0.27 mm tief

Streuwert 1.11, horizontal: 1.18, vertikal: 1.03

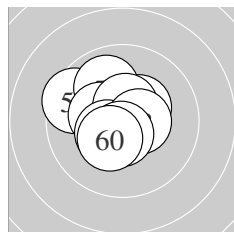

Serie 6:

10.4 *	9.5 ↖	10.6 *	9.9 ↑	10.3 *
10.5 *	10.4 *	10.5 *	10.6 *	10.4 *

beste Teiler 82.4 (53.) 89.6 (59.) 103.7 (56.)

Trefferlage 0.59 mm links, 0.37 mm hoch

Streuwert 1.21, horizontal: 1.30, vertikal: 1.11

Meyton Elektronik

ISSF AR Women Jun – Wertung – Juniorinnen

StartNr: 31

StandNr: 131

21. Januar 2018 9:33

Karasova, Sara #81

CZE

Unterschrift des Schützen

Meyton Elektronik

Ergebnis: **618.8** (596)
 Serien: 102.8 103.6 101.9 102.9 104.7 102.9
 Zähler: 56 4 0 0 0 0 0 0 0
 Innenzehner: 44
 weiteste: 457 (22), 303 (5), 286 (32)
 beste Teiler 34.9 (6.) 41.6 (45.) 58.5 (43.)
 Trefferlage 0.12 mm links, 0.12 mm tief
 Streuwert 1.25, horizontal: 1.42, vertikal: 1.05

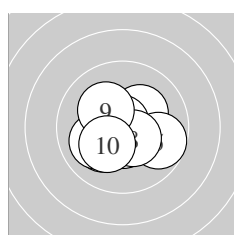
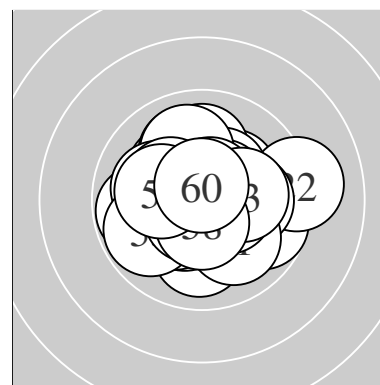

Serie 1:
 10.2 * 10.1 ↙ 10.5 * 10.6 * 9.7 →
 10.8 * 10.0 ↙ 10.5 * 10.2 * 10.2 *
 beste Teiler 34.9 (6.) 93.4 (4.) 103.1 (3.)
 Trefferlage 0.16 mm links, 0.47 mm tief
 Streuwert 1.28, horizontal: 1.50, vertikal: 1.02

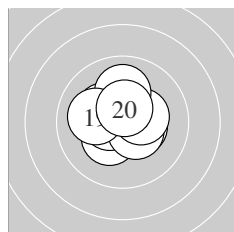

Serie 2:
 10.3 * 10.4 * 10.3 * 10.5 * 10.7 *
 10.5 * 10.3 * 10.0 ↑ 10.1 ← 10.5 *
 beste Teiler 68.0 (15.) 102.0 (14.) 111.0 (20.)
 Trefferlage 0.13 mm links, 0.34 mm hoch
 Streuwert 1.12, horizontal: 1.24, vertikal: 1.00

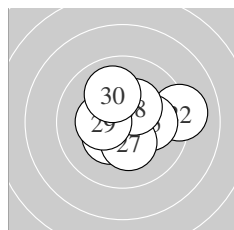

Serie 3:
 10.4 * 9.1 → 10.4 * 10.5 * 10.1 →
 10.4 * 10.3 * 10.4 * 10.3 * 10.0 ↕
 beste Teiler 107.0 (24.) 131.0 (23.) 137.0 (26.)
 Trefferlage 0.59 mm rechts, 0.44 mm hoch
 Streuwert 1.49, horizontal: 1.76, vertikal: 1.16

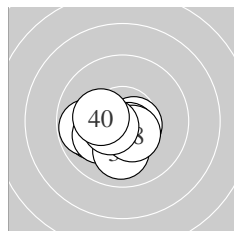

Serie 4:
 10.0 ↙ 9.8 ← 10.1 ↙ 10.6 * 10.5 *
 10.6 * 10.0 ↓ 10.5 * 10.5 * 10.3 *
 beste Teiler 89.6 (36.) 94.2 (34.) 105.1 (39.)
 Trefferlage 0.69 mm links, 0.80 mm tief
 Streuwert 1.10, horizontal: 1.39, vertikal: 0.69

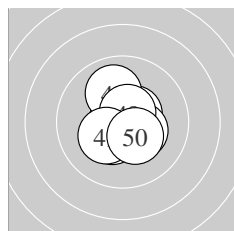

Serie 5:
 10.5 * 10.4 * 10.7 * 10.3 * 10.8 *
 10.7 * 10.0 ↕ 10.6 * 10.3 * 10.4 *
 beste Teiler 41.6 (45.) 58.5 (43.) 75.0 (46.)
 Trefferlage 0.04 mm rechts, 0.01 mm tief
 Streuwert 1.00, horizontal: 0.88, vertikal: 1.11

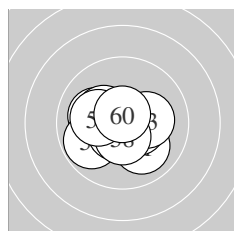

Serie 6:
 10.0 ↘ 10.5 * 10.2 * 10.1 ← 9.8 ↙
 10.3 * 10.6 * 10.5 * 10.2 * 10.7 *
 beste Teiler 69.0 (60.) 91.6 (57.) 108.0 (58.)
 Trefferlage 0.39 mm links, 0.27 mm tief
 Streuwert 1.30, horizontal: 1.58, vertikal: 0.94

Meyton Elektronik

ISSF AR Women Jun – Wertung – Juniorinnen

StandNr: 132

Rossiter, Victoria #86

StartNr: 32

21. Januar 2018 9:39

AUS

Unterschrift des Schützen

Meyton Elektronik

Ergebnis: **614.2** (587)

Serien: 103.2 101.6 101.3 104.1 102.7 101.3

Zähler: 47 13 0 0 0 0 0 0 0

Innenzehner: 39

weiteste: 422 (3), 344 (54), 325 (4)

beste Teiler 40.4 (8.) 42.0 (29.) 59.0 (39.)

Trefferlage 0.02 mm rechts, 0.29 mm hoch

Streuwert 1.39, horizontal: 1.55, vertikal: 1.21

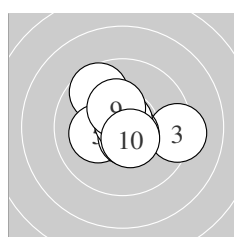
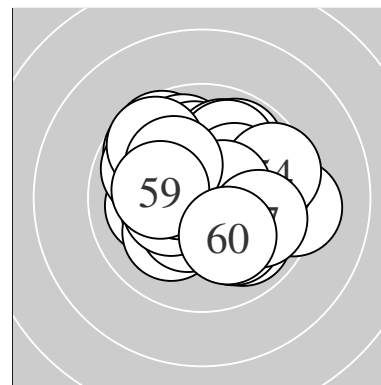

Serie 1:

10.7 *	10.5 *	9.3 →	9.7 ↖	10.2 *
10.6 *	10.6 *	10.8 *	10.3 *	10.5 *

beste Teiler 40.4 (8.) 67.9 (1.) 76.3 (6.)

Trefferlage 0.00 mm , 0.18 mm hoch

Streuwert 1.46, horizontal: 1.73, vertikal: 1.14

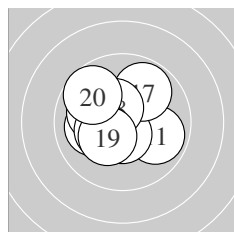

Serie 2:

9.9 ↘	10.1 ←	10.1 ↖	10.4 *	10.6 *
10.3 *	9.8 ↗	10.4 *	10.3 *	9.7 ↖

beste Teiler 93.0 (15.) 127.2 (18.) 129.2 (14.)

Trefferlage 0.69 mm links, 0.28 mm hoch

Streuwert 1.45, horizontal: 1.61, vertikal: 1.27

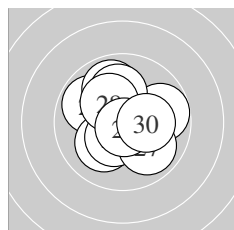

Serie 3:

9.9 ↖	9.9 ↖	9.8 →	10.1 ↑	10.1 ↗
10.4 *	9.9 ↘	10.2 *	10.8 *	10.2 *

beste Teiler 42.0 (29.) 133.4 (26.) 180.0 (28.)

Trefferlage 0.00 mm , 0.32 mm hoch

Streuwert 1.62, horizontal: 1.68, vertikal: 1.56

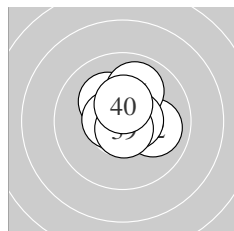

Serie 4:

10.5 *	10.0 →	10.5 *	10.2 *	10.0 ↗
10.6 *	10.6 *	10.6 *	10.7 *	10.4 *

beste Teiler 59.0 (39.) 79.0 (36.) 88.6 (38.)

Trefferlage 0.27 mm rechts, 0.57 mm hoch

Streuwert 1.00, horizontal: 1.06, vertikal: 0.95

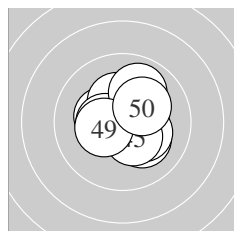

Serie 5:

10.2 *	10.4 *	10.3 *	10.2 *	10.4 *
10.3 *	10.4 *	9.9 ↗	10.4 *	10.2 *

beste Teiler 135.1 (47.) 135.4 (42.) 138.0 (45.)

Trefferlage 0.31 mm rechts, 0.16 mm hoch

Streuwert 1.26, horizontal: 1.34, vertikal: 1.18

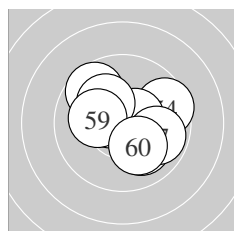

Serie 6:

9.7 ↖	10.5 *	10.0 ↘	9.6 →	10.7 *
10.5 *	9.8 ↘	10.2 *	10.2 *	10.1 ↘

beste Teiler 59.0 (55.) 103.4 (56.) 103.7 (52.)

Trefferlage 0.26 mm rechts, 0.22 mm hoch

Streuwert 1.64, horizontal: 1.88, vertikal: 1.36

ISSF AR Women Jun – Wertung – Juniorinnen

StandNr: 133

Kurz, Celina #200

StartNr: 33

21. Januar 2018 9:19

T – SG Thierberg

Unterschrift des Schützen

Meyton Elektronik

Ergebnis:	602.6	(577)					
Serien:	98.4	101.4	102.1	99.9	101.5	99.3	
Zähler:	40	19	0	0	1	0	0
Innenzehner:	27						
weiteste:	1083 (60), 466 (5), 406 (6)						
beste Teiler	44.4 (45.) 48.5 (38.) 54.9 (20.)						
Trefferlage	0.01 mm links, 0.08 mm hoch						
Streuwert	1.91, horizontal: 2.30, vertikal: 1.42						

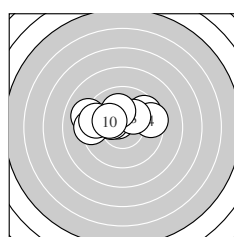
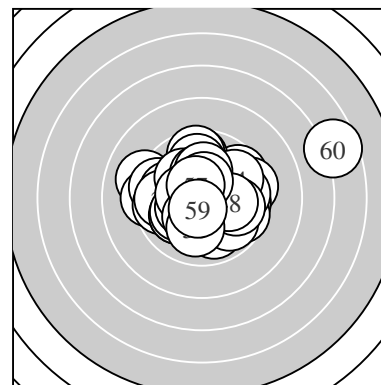

Serie 1:

10.6 *	9.6 ↗	10.3 *	9.5 →	9.1 ←
9.3 ←	9.5 ←	10.2 *	10.1 ↑	10.2 *

beste Teiler 97.0 (1.) 157.9 (3.) 187.8 (10.)
 Trefferlage 0.84 mm links, 1.06 mm hoch
 Streuwert 2.01, horizontal: 2.77, vertikal: 0.62

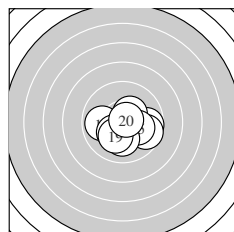

Serie 2:

10.3 *	9.7 →	9.7 ↘	10.4 *	10.1 →
9.9 ←	10.3 *	10.1 ↓	10.2 *	10.7 *

beste Teiler 54.9 (20.) 145.4 (14.) 167.0 (11.)
 Trefferlage 0.60 mm rechts, 0.71 mm tief
 Streuwert 1.47, horizontal: 1.84, vertikal: 0.98

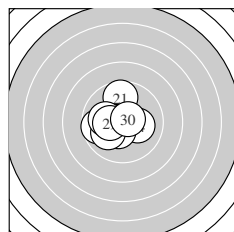

Serie 3:

9.7 ↑	10.5 *	10.6 *	10.2 *	10.4 *
9.7 ←	10.0 ↙	10.1 ←	10.3 *	10.6 *

beste Teiler 78.7 (30.) 84.0 (23.) 118.4 (22.)
 Trefferlage 0.87 mm links, 0.04 mm tief
 Streuwert 1.37, horizontal: 1.46, vertikal: 1.28

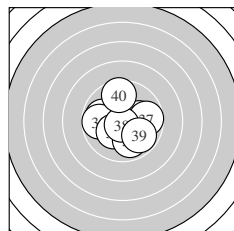

Serie 4:

9.9 ←	10.1 ↘	9.8 ←	10.1 →	10.2 *
9.9 ↓	9.7 →	10.8 *	9.8 ↘	9.6 ↑

beste Teiler 48.5 (38.) 177.8 (35.) 202.3 (32.)
 Trefferlage 0.22 mm rechts, 0.30 mm tief
 Streuwert 1.86, horizontal: 2.05, vertikal: 1.65

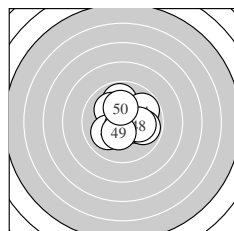

Serie 5:

9.9 ↑	10.1 ↘	10.0 ↙	9.8 ↗	10.8 *
10.3 *	9.9 →	10.1 →	10.4 *	10.2 *

beste Teiler 44.4 (45.) 143.3 (49.) 164.1 (46.)
 Trefferlage 0.42 mm rechts, 0.30 mm hoch
 Streuwert 1.55, horizontal: 1.64, vertikal: 1.45

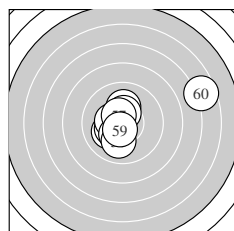

Serie 6:

10.1 ↙	10.3 *	10.4 *	10.1 ↑	10.4 *
10.3 *	10.5 *	10.0 ↓	10.6 *	6.6 →

beste Teiler 89.6 (59.) 110.9 (57.) 130.7 (55.)
 Trefferlage 0.36 mm rechts, 0.21 mm hoch
 Streuwert 2.80, horizontal: 3.50, vertikal: 1.85

Meyton Elektronik

ISSF AR Women Jun – Wertung – Juniorinnen

StandNr: 134

Merkl, Tatjana #98

StartNr: 34

21. Januar 2018 9:14

BY – Schwaben

Unterschrift des Schützen

Meyton Elektronik

Ergebnis:	624.7	(596)					
Serien:	104.6	104.9	103.6	102.4	104.2	105.0	
Zähler:	56	4	0	0	0	0	0
Innenzehner:	51						
weiteste:	329 (1), 288 (37), 281 (14)						
beste Teiler	8.6 (3.) 16.1 (8.) 28.8 (16.)						
Trefferlage	0.05 mm links, 0.13 mm hoch						
Streuwert	1.08, horizontal: 1.19, vertikal: 0.94						

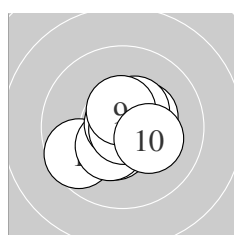
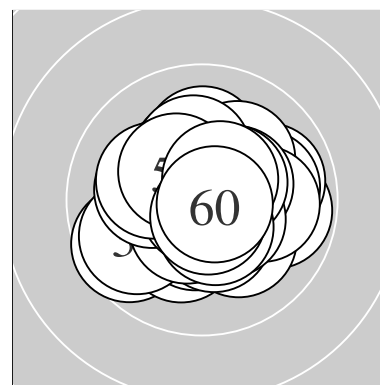

Serie 1:	9.6 ↙	10.5 *	10.9 *	10.4 *	10.8 *
	10.4 *	10.4 *	10.9 *	10.5 *	10.2 *
beste Teiler	8.6 (3.) 16.1 (8.) 32.5 (5.)				
Trefferlage	0.05 mm links, 0.18 mm tief				
Streuwert	1.13, horizontal: 1.25, vertikal: 0.98				

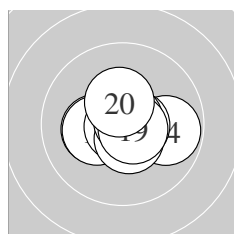

Serie 2:	10.8 *	10.2 *	10.3 *	9.8 →	10.6 *
	10.8 *	10.5 *	10.8 *	10.7 *	10.4 *
beste Teiler	28.8 (16.) 29.0 (11.) 43.8 (18.)				
Trefferlage	0.13 mm rechts, 0.07 mm tief				
Streuwert	1.01, horizontal: 1.28, vertikal: 0.63				

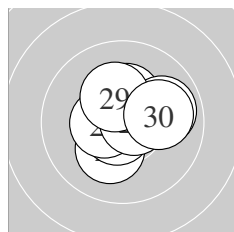

Serie 3:	10.2 *	10.7 *	10.5 *	10.5 *	10.3 *
	10.5 *	10.7 *	9.9 →	10.3 *	10.0 →
beste Teiler	63.5 (22.) 74.6 (27.) 101.8 (23.)				
Trefferlage	0.30 mm rechts, 0.39 mm hoch				
Streuwert	1.14, horizontal: 1.27, vertikal: 1.01				

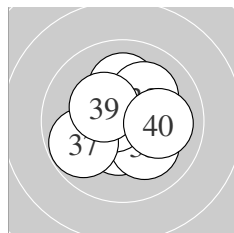

Serie 4:	10.4 *	10.1 ↑	10.4 *	10.4 *	10.1 ↘
	10.7 *	9.8 ↙	10.1 ↗	10.4 *	10.0 →
beste Teiler	64.6 (36.) 127.6 (33.) 131.3 (31.)				
Trefferlage	0.12 mm links, 0.13 mm hoch				
Streuwert	1.38, horizontal: 1.46, vertikal: 1.30				

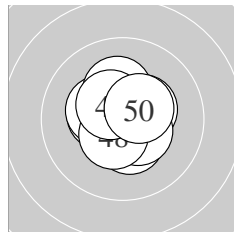

Serie 5:	10.4 *	10.4 *	10.4 *	10.3 *	10.5 *
	10.5 *	10.2 *	10.5 *	10.5 *	10.5 *
beste Teiler	101.6 (46.) 114.7 (48.) 119.9 (49.)				
Trefferlage	0.10 mm links, 0.27 mm hoch				
Streuwert	0.99, horizontal: 1.00, vertikal: 0.98				

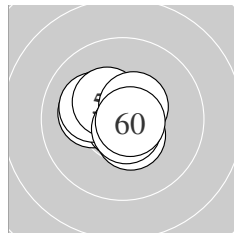

Serie 6:	10.5 *	10.2 *	10.3 *	10.8 *	10.7 *
	10.2 *	10.4 *	10.5 *	10.7 *	10.7 *
beste Teiler	30.8 (54.) 51.8 (60.) 63.0 (55.)				
Trefferlage	0.46 mm links, 0.23 mm hoch				
Streuwert	0.88, horizontal: 1.00, vertikal: 0.73				

Meyton Elektronik

ISSF AR Women Jun – Wertung – Juniorinnen

StandNr: 136

Bratchikova, Natalia #64

StartNr: 36

21. Januar 2018 9:45

RUS

Unterschrift des Schützen

Meyton Elektronik

Ergebnis: **607.5** (584)
 Serien: 102.0 100.6 103.0 101.2 100.8 99.9
 Zähler: 45 14 1 0 0 0 0 0 0
 Innenzehner: 26
 weiteste: 579 (41), 431 (25), 411 (34)
 beste Teiler 30.0 (27.) 37.1 (49.) 38.2 (42.)
 Trefferlage 0.01 mm rechts, 0.00 mm
 Streuwert 1.64, horizontal: 1.80, vertikal: 1.46

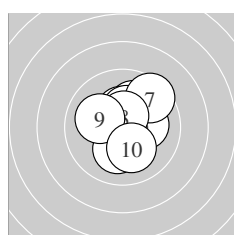
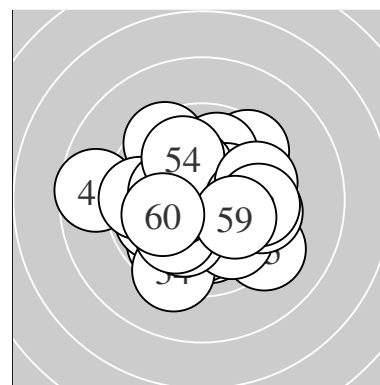

Serie 1:
 10.1 ↗ 10.4 * 10.3 * 10.7 * 10.2 *
 10.1 ↓ 9.5 ↗ 10.5 * 10.1 ↖ 10.1 ↓
 beste Teiler 55.0 (4.) 103.6 (8.) 145.6 (2.)
 Trefferlage 0.35 mm rechts, 0.60 mm hoch
 Streuwert 1.41, horizontal: 1.30, vertikal: 1.52

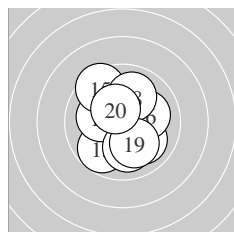

Serie 2:
 10.6 * 10.0 ↘ 9.8 ↙ 10.1 ↖ 9.5 ↖
 10.1 → 10.0 ↓ 10.0 ↑ 10.1 ↓ 10.4 *
 beste Teiler 97.0 (11.) 135.1 (20.) 201.7 (14.)
 Trefferlage 0.02 mm links, 0.05 mm hoch
 Streuwert 1.76, horizontal: 1.54, vertikal: 1.95

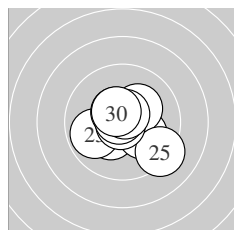

Serie 3:
 10.3 * 10.1 ↘ 9.9 ↖ 10.2 * 9.2 ↘
 10.5 * 10.8 * 10.8 * 10.7 * 10.5 *
 beste Teiler 30.0 (27.) 40.6 (28.) 75.0 (29.)
 Trefferlage 0.14 mm rechts, 0.21 mm tief
 Streuwert 1.47, horizontal: 1.66, vertikal: 1.25

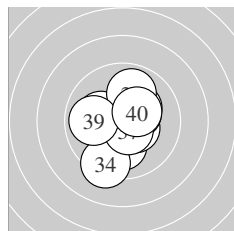

Serie 4:
 10.2 * 10.1 ↓ 10.4 * 9.3 ↓ 10.1 ↖
 10.4 * 10.6 * 9.9 ↑ 9.9 ← 10.3 *
 beste Teiler 95.9 (37.) 129.3 (33.) 144.5 (36.)
 Trefferlage 0.01 mm rechts, 0.17 mm tief
 Streuwert 1.66, horizontal: 1.50, vertikal: 1.80

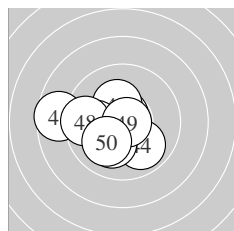

Serie 5:
 8.6 ← 10.8 * 10.7 * 9.9 ↘ 10.3 *
 10.1 ↓ 10.0 ← 9.6 ← 10.8 * 10.0 ↙
 beste Teiler 37.1 (49.) 38.2 (42.) 63.6 (43.)
 Trefferlage 1.27 mm links, 0.33 mm tief
 Streuwert 1.73, horizontal: 2.12, vertikal: 1.21

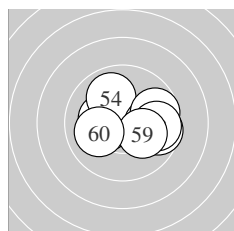

Serie 6:
 10.4 * 10.3 * 10.2 * 9.9 ↖ 9.6 →
 10.0 → 9.7 → 9.7 → 10.1 ↘ 10.0 ←
 beste Teiler 142.2 (51.) 173.4 (52.) 181.4 (53.)
 Trefferlage 0.87 mm rechts, 0.03 mm hoch
 Streuwert 1.70, horizontal: 2.19, vertikal: 0.97

Meyton Elektronik

ISSF AR Women Jun – Wertung – Juniorinnen

StandNr: 137

Haselsberger, Carmen #75

StartNr: 37

21. Januar 2018 9:29

AUT

Unterschrift des Schützen

Meyton Elektronik

Ergebnis: **623.9** (595)
 Serien: 104.6 104.5 103.6 104.1 103.9 103.2
 Zähler: 55 5 0 0 0 0 0 0 0
 Innenzehner: 51
 weiteste: 383 (56), 314 (26), 306 (38)
 beste Teiler 20.2 (57.) 32.7 (53.) 53.2 (1.)
 Trefferlage 0.00 mm , 0.00 mm
 Streuwert 1.11, horizontal: 1.19, vertikal: 1.02

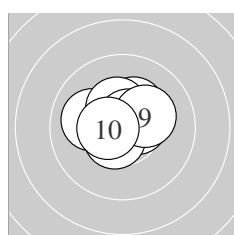
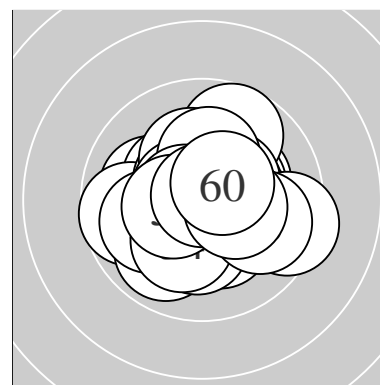

Serie 1:
 10.7 * 10.0 ← 10.7 * 10.5 * 10.3 *
 10.4 * 10.7 * 10.6 * 10.2 * 10.5 *
 beste Teiler 53.2 (1.) 55.3 (3.) 65.4 (7.)
 Trefferlage 0.14 mm links, 0.41 mm hoch
 Streuwert 0.92, horizontal: 1.12, vertikal: 0.66

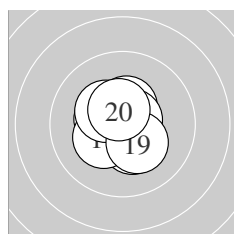

Serie 2:
 10.5 * 10.5 * 10.7 * 10.4 * 10.3 *
 10.7 * 10.3 * 10.3 * 10.3 * 10.5 *
 beste Teiler 63.0 (13.) 70.2 (16.) 107.4 (20.)
 Trefferlage 0.14 mm links, 0.07 mm hoch
 Streuwert 0.96, horizontal: 0.88, vertikal: 1.04

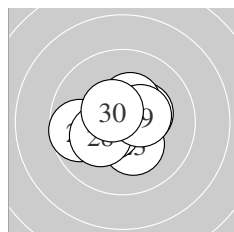

Serie 3:
 10.7 * 10.3 * 10.2 * 10.7 * 10.5 *
 9.7 ← 10.4 * 10.2 * 10.4 * 10.5 *
 beste Teiler 62.0 (24.) 70.6 (21.) 102.0 (25.)
 Trefferlage 0.16 mm links, 0.00 mm
 Streuwert 1.20, horizontal: 1.42, vertikal: 0.92

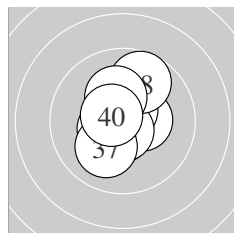

Serie 4:
 10.6 * 10.4 * 10.6 * 10.5 * 10.7 *
 10.7 * 10.1 ↙ 9.7 ↑ 10.2 * 10.6 *
 beste Teiler 53.8 (35.) 67.0 (36.) 79.6 (31.)
 Trefferlage 0.12 mm links, 0.17 mm hoch
 Streuwert 1.14, horizontal: 0.89, vertikal: 1.34

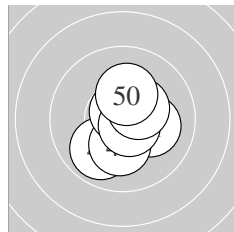

Serie 5:
 10.1 → 10.7 * 10.4 * 9.9 ↘ 10.6 *
 10.2 * 10.7 * 10.7 * 10.4 * 10.2 *
 beste Teiler 56.3 (47.) 67.2 (48.) 73.2 (42.)
 Trefferlage 0.24 mm rechts, 0.21 mm tief
 Streuwert 1.13, horizontal: 0.95, vertikal: 1.28

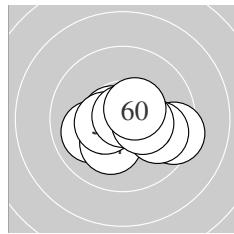

Serie 6:
 10.7 * 10.0 ← 10.8 * 10.2 * 10.4 *
 9.4 → 10.9 * 9.9 → 10.4 * 10.5 *
 beste Teiler 20.2 (57.) 32.7 (53.) 74.5 (51.)
 Trefferlage 0.37 mm rechts, 0.44 mm tief
 Streuwert 1.37, horizontal: 1.80, vertikal: 0.73

Meyton Elektronik

ISSF AR Women Jun – Wertung – Juniorinnen

StartNr: 38

StandNr: 138

21. Januar 2018 9:50

Ho, Xiu Yi #65

SGP

Unterschrift des Schützen

Meyton Elektronik

Ergebnis:	603.7	(579)
Serien:	100.3	100.6 101.2 99.5 102.8 99.3
Zähler:	40	19 1 0 0 0 0 0 0 0
Innenzehner:	29	
weiteste:	501	(59), 492 (11), 429 (56)
beste Teiler	44.5	(40.) 52.0 (6.) 69.2 (19.)
Trefferlage	0.10 mm	rechts, 0.10 mm hoch
Streuwert	1.75,	horizontal: 1.86, vertikal: 1.64

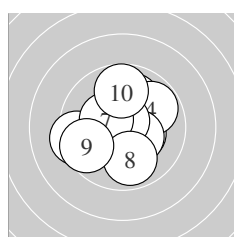
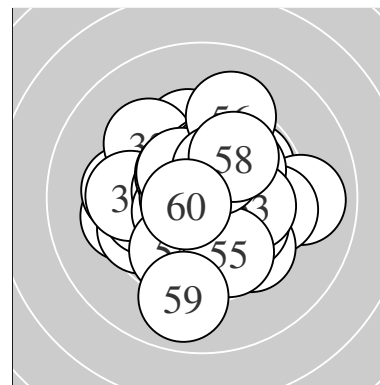

Serie 1:	9.4 ←	10.4 *	10.0 ↑	9.8 ↗	10.4 *
	10.7 *	10.4 *	9.9 ↓	9.6 ←	9.7 ↑
beste Teiler	52.0	(6.) 143.6	(5.) 146.8	(2.)	
Trefferlage	0.18 mm	links, 0.16 mm	hoch		
Streuwert	1.87,	horizontal: 1.97,	vertikal: 1.75		

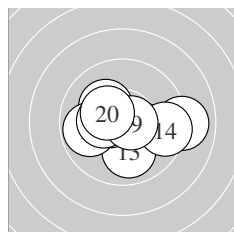

Serie 2:	9.0 →	10.2 *	10.0 ↓	9.5 →	10.2 *
	9.8 ←	10.5 *	10.3 *	10.7 *	10.4 *
beste Teiler	69.2	(19.) 102.7	(17.) 148.0	(20.)	
Trefferlage	0.34 mm	rechts, 0.21 mm	tief		
Streuwert	1.87,	horizontal: 2.45,	vertikal: 0.99		

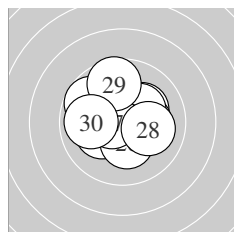

Serie 3:	9.7 ↖	10.2 *	10.2 *	10.3 *	10.2 *
	10.3 *	10.6 *	10.1 →	9.7 ↑	9.9 ←
beste Teiler	88.0	(27.) 167.6	(24.) 167.9	(26.)	
Trefferlage	0.12 mm	links, 0.38 mm	hoch		
Streuwert	1.61,	horizontal: 1.83,	vertikal: 1.36		

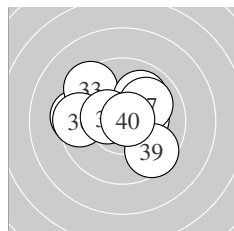

Serie 4:	9.4 ←	10.1 ↗	9.4 ↖	10.0 ↗	10.3 *
	9.5 ←	10.0 ↗	10.4 *	9.6 ↘	10.8 *
beste Teiler	44.5	(40.) 131.7	(38.) 162.7	(35.)	
Trefferlage	0.20 mm	links, 0.65 mm	hoch		
Streuwert	1.97,	horizontal: 2.40,	vertikal: 1.43		

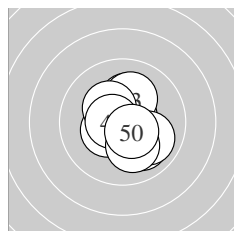

Serie 5:	10.2 *	10.6 *	10.1 ↑	10.4 *	10.3 *
	10.6 *	10.0 ↘	10.0 ↘	10.1 ↓	10.5 *
beste Teiler	76.3	(42.) 87.1	(46.) 108.2	(50.)	
Trefferlage	0.36 mm	rechts, 0.11 mm	tief		
Streuwert	1.28,	horizontal: 1.12,	vertikal: 1.42		

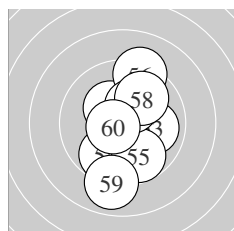

Serie 6:	10.3 *	10.6 *	10.0 →	9.8 ↓	9.7 ↓
	9.2 ↑	10.3 *	9.9 ↗	8.9 ↓	10.6 *
beste Teiler	86.1	(60.) 97.0	(52.) 157.4	(57.)	
Trefferlage	0.43 mm	rechts, 0.23 mm	tief		
Streuwert	2.09,	horizontal: 1.35,	vertikal: 2.63		

Meyton Elektronik

ISSF AR Women Jun – Wertung – Juniorinnen

StartNr: 39

StandNr: 139

21. Januar 2018 9:54

Züger, Muriel #117

SUI

Unterschrift des Schützen

Meyton Elektronik

Ergebnis:	584.7	(561)
Serien:	101.2 95.7 99.4 95.1 96.7 96.6	
Zähler:	27 27 6 0 0 0 0 0 0	
Innenzehner:	22	
weiteste:	631 (12), 629 (57), 567 (17)	
beste Teiler	78.4 (43.) 101.1 (4.) 105.4 (55.)	
Trefferlage	0.24 mm rechts, 0.31 mm hoch	
Streuwert	2.36, horizontal: 2.88, vertikal: 1.70	

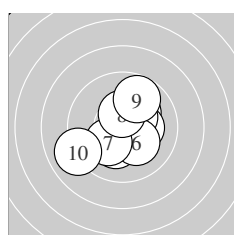
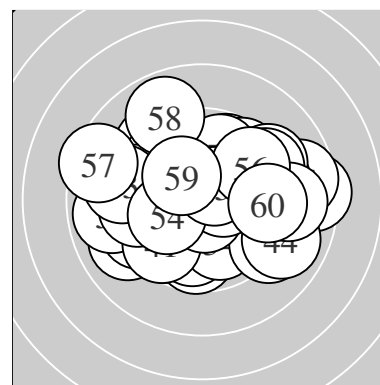

Serie 1:	10.2 *	10.3 *	10.2 *	10.5 *	10.4 *
	10.2 *	10.2 *	10.4 *	9.8 ↗	9.0 ↖
beste Teiler	101.1 (4.) 127.1 (8.) 145.3 (5.)				
Trefferlage	0.10 mm rechts, 0.15 mm tief				
Streuwert	1.74, horizontal: 1.83, vertikal: 1.65				

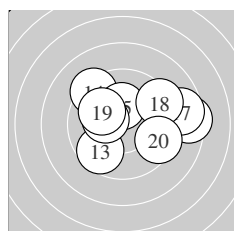

Serie 2:	10.3 *	8.4 →	9.6 ↙	9.3 ↘	10.3 *
	10.3 *	8.7 →	9.3 ↗	10.0 ↖	9.5 ↘
beste Teiler	169.0 (16.) 171.1 (15.) 175.4 (11.)				
Trefferlage	0.86 mm rechts, 0.70 mm hoch				
Streuwert	2.71, horizontal: 3.46, vertikal: 1.64				

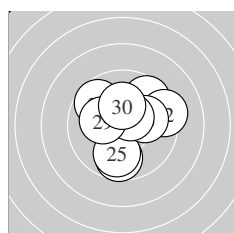

Serie 3:	9.6 ↗	9.3 →	10.2 *	9.7 ↓	9.9 ↓
	10.1 →	10.5 *	9.7 ↘	10.2 *	10.2 *
beste Teiler	106.0 (27.) 184.0 (30.) 193.2 (23.)				
Trefferlage	0.21 mm rechts, 0.44 mm hoch				
Streuwert	1.97, horizontal: 2.05, vertikal: 1.88				

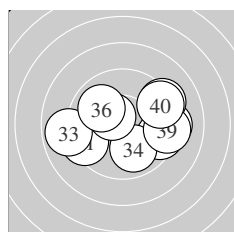

Serie 4:	9.4 ↖	9.5 →	8.9 ←	9.9 ↘	10.5 *
	10.0 ↖	9.2 →	9.2 ↗	9.2 →	9.3 ↗
beste Teiler	121.2 (35.) 250.8 (36.) 253.4 (34.)				
Trefferlage	0.88 mm rechts, 0.04 mm tief				
Streuwert	2.74, horizontal: 3.57, vertikal: 1.53				

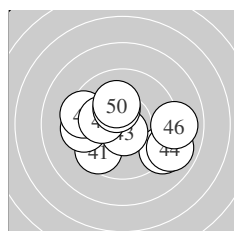

Serie 5:	9.6 ↙	9.1 ↘	10.6 *	8.9 ↘	9.5 ←
	9.0 →	9.4 ←	10.1 ←	10.3 *	10.2 *
beste Teiler	78.4 (43.) 155.2 (49.) 197.6 (50.)				
Trefferlage	0.05 mm rechts, 0.39 mm tief				
Streuwert	2.58, horizontal: 3.27, vertikal: 1.61				

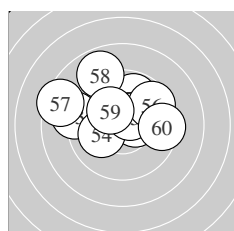

Serie 6:	9.8 ↗	10.5 *	9.1 ←	10.1 ←	10.5 *
	9.6 ↗	8.4 ←	8.9 ↘	10.2 *	9.5 →
beste Teiler	105.4 (55.) 121.8 (52.) 180.9 (59.)				
Trefferlage	0.63 mm links, 1.36 mm hoch				
Streuwert	2.47, horizontal: 3.10, vertikal: 1.62				

Meyton Elektronik

ISSF AR Women Jun – Wertung – Juniorinnen

StandNr: 140

Thum, Julia #201

StartNr: 40

21. Januar 2018 9:39

T – SG Fügenberg

Unterschrift des Schützen

Meyton Elektronik

Ergebnis:	612.6	(582)
Serien:	102.1	103.1 100.6 102.1 102.9 101.8
Zähler:	43	16 1 0 0 0 0 0 0 0
Innenzehner:	38	
weiteste:	601	(29), 460 (51), 388 (20)
beste Teiler	19.3	(59.) 35.8 (53.) 42.4 (48.)
Trefferlage	0.10 mm	rechts, 0.46 mm hoch
Streuwert	1.52,	horizontal: 1.80, vertikal: 1.17

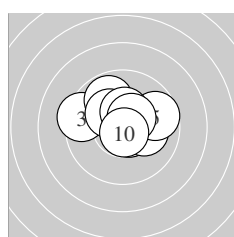
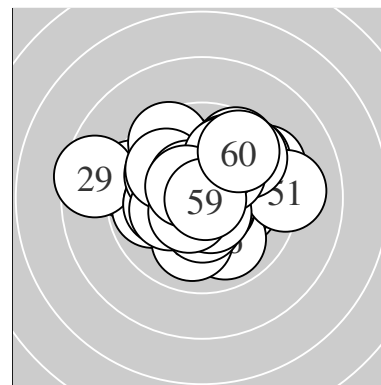

Serie 1:	10.4 *	10.6 *	9.4 ↖	10.2 *	9.7 ↗
	9.8 ↘	10.3 *	10.4 *	10.5 *	10.8 *
beste Teiler	50.0	(10.) 77.9 (2.) 117.4 (9.)			
Trefferlage	0.02 mm	rechts, 0.79 mm hoch			
Streuwert	1.48,	horizontal: 1.86, vertikal: 0.97			

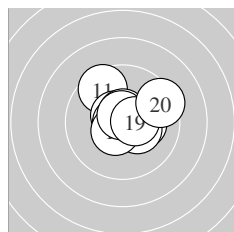

Serie 2:	9.5 ↘	10.6 *	10.2 *	10.7 *	10.6 *
	10.4 *	10.5 *	10.7 *	10.5 *	9.4 ↗
beste Teiler	51.0	(14.) 63.7 (18.) 80.0 (15.)			
Trefferlage	0.40 mm	rechts, 0.53 mm hoch			
Streuwert	1.36,	horizontal: 1.54, vertikal: 1.15			

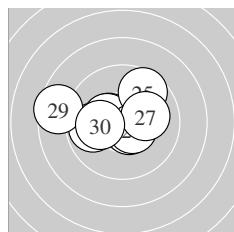

Serie 3:	10.6 *	10.4 *	10.6 *	10.4 *	9.6 ↗
	10.5 *	10.1 ↗	9.8 ↖	8.5 ↖	10.1 ↖
beste Teiler	93.8	(21.) 98.1 (23.) 109.0 (26.)			
Trefferlage	0.69 mm	links, 0.30 mm hoch			
Streuwert	1.90,	horizontal: 2.48, vertikal: 1.04			

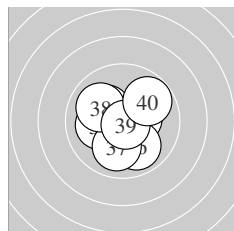

Serie 4:	10.3 *	10.4 *	10.2 *	10.6 *	10.1 ↖
	9.9 ↘	10.0 ↓	10.0 ↖	10.8 *	9.8 ↗
beste Teiler	42.6	(39.) 76.0 (34.) 138.4 (32.)			
Trefferlage	0.33 mm	links, 0.10 mm tief			
Streuwert	1.46,	horizontal: 1.56, vertikal: 1.36			

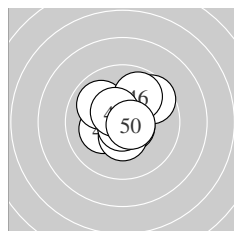

Serie 5:	10.2 *	10.4 *	9.9 ↖	10.6 *	9.6 ↗
	9.9 ↗	10.4 *	10.8 *	10.5 *	10.6 *
beste Teiler	42.4	(48.) 77.1 (50.) 82.6 (44.)			
Trefferlage	0.19 mm	rechts, 0.49 mm hoch			
Streuwert	1.34,	horizontal: 1.41, vertikal: 1.27			

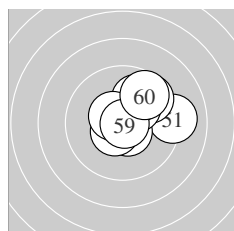

Serie 6:	9.1 ↗	9.6 ↗	10.8 *	10.6 *	10.2 *
	10.5 *	9.9 ↗	10.5 *	10.9 *	9.7 ↗
beste Teiler	19.3	(59.) 35.8 (53.) 91.9 (54.)			
Trefferlage	1.07 mm	rechts, 0.74 mm hoch			
Streuwert	1.47,	horizontal: 1.64, vertikal: 1.27			

Meyton Elektronik

ISSF AR Women Jun – Wertung – Juniorinnen

StartNr: 41

StandNr: 141

21. Januar 2018 9:43

Adams, Emma #59

AUS

Unterschrift des Schützen

Meyton Elektronik

Ergebnis: **624.6** (595)
 Serien: 105.4 104.0 105.2 104.5 102.4 103.1
 Zähler: 55 5 0 0 0 0 0 0 0 0
 Innenzehner: 52
 weiteste: 349 (56), 316 (59), 296 (42)
 beste Teiler 9.0 (30.) 24.1 (58.) 42.9 (13.)
 Trefferlage 0.19 mm links, 0.08 mm tief
 Streuwert 1.10, horizontal: 1.26, vertikal: 0.92

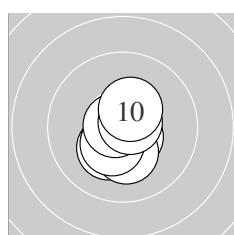
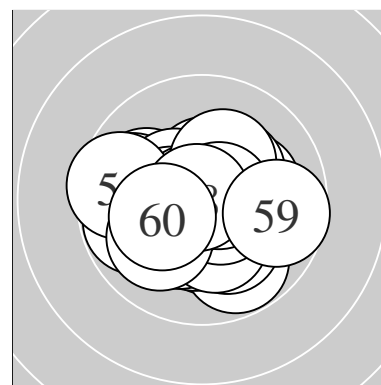

Serie 1:
 10.3 * 10.8 * 10.7 * 10.6 * 10.3 *
 10.5 * 10.4 * 10.7 * 10.7 * 10.4 *
 beste Teiler 43.6 (2.) 53.3 (8.) 61.5 (3.)
 Trefferlage 0.04 mm links, 0.34 mm tief
 Streuwert 0.82, horizontal: 0.62, vertikal: 0.99

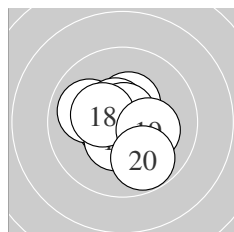

Serie 2:
 10.6 * 10.4 * 10.8 * 10.0 ↖ 10.6 *
 10.5 * 10.7 * 10.4 * 10.2 * 9.8 ↘
 beste Teiler 42.9 (13.) 52.6 (17.) 90.4 (11.)
 Trefferlage 0.19 mm links, 0.02 mm tief
 Streuwert 1.18, horizontal: 1.23, vertikal: 1.14

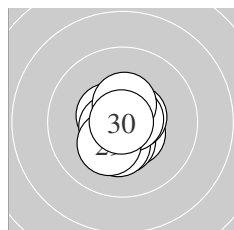

Serie 3:
 10.5 * 10.5 * 10.4 * 10.3 * 10.6 *
 10.6 * 10.7 * 10.5 * 10.2 * 10.9 *
 beste Teiler 9.0 (30.) 65.1 (27.) 88.0 (25.)
 Trefferlage 0.07 mm links, 0.32 mm tief
 Streuwert 0.83, horizontal: 0.69, vertikal: 0.95

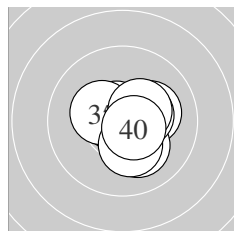

Serie 4:
 10.7 * 10.2 * 10.7 * 10.7 * 10.3 *
 10.2 * 10.3 * 10.4 * 10.4 * 10.6 *
 beste Teiler 53.4 (33.) 55.6 (34.) 69.2 (31.)
 Trefferlage 0.49 mm rechts, 0.06 mm tief
 Streuwert 0.96, horizontal: 1.01, vertikal: 0.91

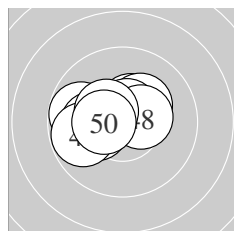

Serie 5:
 10.4 * 9.8 ↖ 10.3 * 10.2 * 10.1 ←
 10.6 * 9.8 ↖ 10.4 * 10.4 * 10.4 *
 beste Teiler 84.5 (46.) 127.4 (41.) 131.0 (50.)
 Trefferlage 0.86 mm links, 0.33 mm hoch
 Streuwert 1.23, horizontal: 1.60, vertikal: 0.68

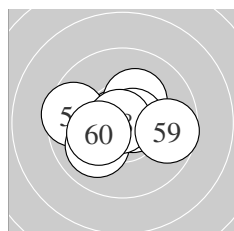

Serie 6:
 10.7 * 10.8 * 10.2 * 10.7 * 10.3 *
 9.6 ↖ 10.0 ↖ 10.9 * 9.7 → 10.2 *
 beste Teiler 24.1 (58.) 44.9 (52.) 55.3 (51.)
 Trefferlage 0.50 mm links, 0.08 mm tief
 Streuwert 1.41, horizontal: 1.81, vertikal: 0.84

Meyton Elektronik

ISSF AR Women Jun – Wertung – Juniorinnen

StartNr: 42

StandNr: 142

21. Januar 2018 9:39

Oberholzer, Julia #91

SUI

Unterschrift des Schützen

Meyton Elektronik

Ergebnis: **616.8** (588)

Serien: 101.5 102.5 103.7 102.2 102.4 104.5

Zähler: 48 12 0 0 0 0 0 0 0

Innenzehner: 39

weiteste: 377 (4), 341 (20), 337 (9)

beste Teiler 32.2 (52.) 36.0 (29.) 42.4 (57.)

Trefferlage 0.09 mm rechts, 0.44 mm hoch

Streuwert 1.32, horizontal: 1.35, vertikal: 1.29

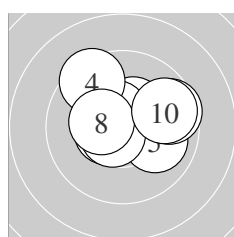
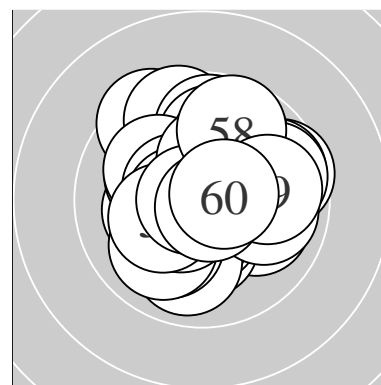

Serie 1:

10.4 *	10.4 *	10.5 *	9.4 ↘	10.0 ↘
10.5 *	10.6 *	10.4 *	9.6 →	9.7 →

beste Teiler 83.8 (7.) 107.3 (3.) 111.9 (6.)

Trefferlage 0.20 mm rechts, 0.67 mm hoch

Streuwert 1.58, horizontal: 1.92, vertikal: 1.14

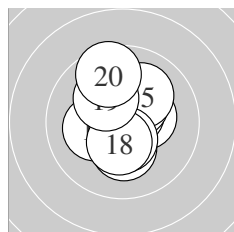

Serie 2:

10.4 *	10.6 *	10.2 *	10.3 *	10.1 ↗
10.2 *	10.5 *	10.4 *	10.2 *	9.6 ↖

beste Teiler 85.5 (12.) 119.9 (17.) 138.9 (18.)

Trefferlage 0.02 mm rechts, 0.41 mm hoch

Streuwert 1.38, horizontal: 1.09, vertikal: 1.62

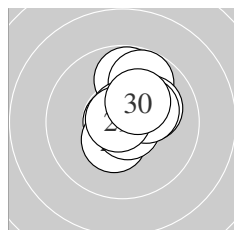

Serie 3:

10.8 *	9.8 ↑	9.8 ↗	10.4 *	10.8 *
10.7 *	10.1 →	10.2 *	10.8 *	10.3 *

beste Teiler 36.0 (29.) 47.0 (21.) 48.1 (25.)

Trefferlage 0.51 mm rechts, 0.79 mm hoch

Streuwert 1.10, horizontal: 0.89, vertikal: 1.28

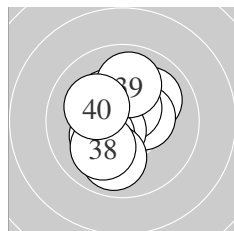

Serie 4:

10.0 ↗	10.4 *	10.6 *	10.3 *	10.6 *
10.3 *	9.9 ↓	10.1 ↖	9.9 ↑	10.1 ↘

beste Teiler 90.5 (35.) 99.2 (33.) 139.4 (32.)

Trefferlage 0.27 mm links, 0.14 mm hoch

Streuwert 1.41, horizontal: 1.23, vertikal: 1.58

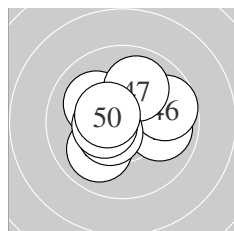

Serie 5:

10.0 ↖	10.7 *	10.5 *	10.1 ↘	9.9 →
9.7 →	10.0 ↑	10.5 *	10.5 *	10.5 *

beste Teiler 54.5 (42.) 103.4 (43.) 112.8 (48.)

Trefferlage 0.10 mm links, 0.19 mm hoch

Streuwert 1.45, horizontal: 1.69, vertikal: 1.16

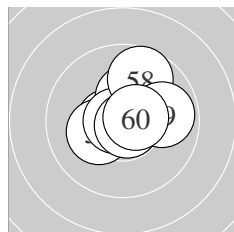

Serie 6:

10.8 *	10.8 *	10.6 *	10.3 *	10.2 *
10.8 *	10.8 *	9.7 ↑	9.9 →	10.6 *

beste Teiler 32.2 (52.) 42.4 (57.) 43.8 (51.)

Trefferlage 0.22 mm rechts, 0.45 mm hoch

Streuwert 1.13, horizontal: 1.20, vertikal: 1.04

Unterschrift des Schützen

Meyton Elektronik

Ergebnis: **617.4** (586)
 Serien: 102.3 103.2 102.7 102.1 102.9 104.2
 Zähler: 46 14 0 0 0 0 0 0 0
 Innenzehner: 41
 weiteste: 496 (36), 390 (51), 387 (19)
 beste Teiler 12.0 (15.) 13.9 (35.) 16.1 (58.)
 Trefferlage 0.16 mm links, 0.39 mm hoch
 Streuwert 1.36, horizontal: 1.52, vertikal: 1.17

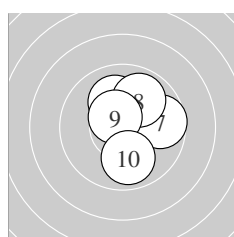
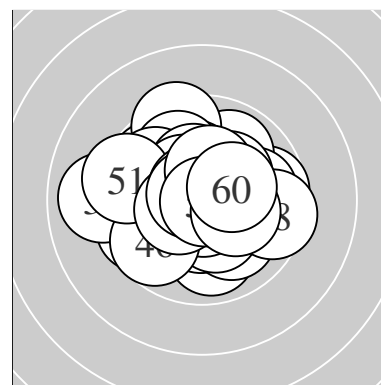

Serie 1:
 10.4 * 10.5 * 10.1 ↗ 10.6 * 10.1 ↗
 10.6 * 9.7 → 9.9 ↗ 10.5 * 9.9 ↓
 beste Teiler 80.3 (4.) 91.2 (6.) 104.2 (2.)
 Trefferlage 0.62 mm rechts, 0.85 mm hoch
 Streuwert 1.23, horizontal: 1.12, vertikal: 1.34

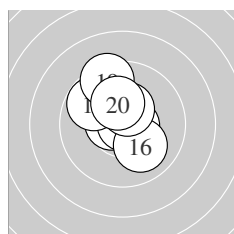

Serie 2:
 10.5 * 10.8 * 10.6 * 10.6 * 10.9 *
 10.0 ↘ 9.8 ↘ 10.4 * 9.4 ↗ 10.2 *
 beste Teiler 12.0 (15.) 47.8 (12.) 85.3 (13.)
 Trefferlage 0.25 mm links, 0.74 mm hoch
 Streuwert 1.31, horizontal: 1.15, vertikal: 1.46

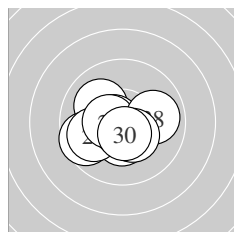

Serie 3:
 10.0 ↘ 9.6 ↖ 10.4 * 10.7 * 9.9 ↖
 10.7 * 10.5 * 9.9 → 10.4 * 10.6 *
 beste Teiler 64.5 (26.) 75.1 (24.) 97.3 (30.)
 Trefferlage 0.58 mm links, 0.46 mm tief
 Streuwert 1.32, horizontal: 1.63, vertikal: 0.90

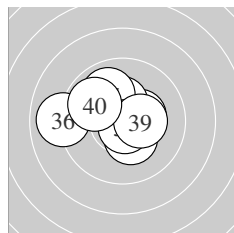

Serie 4:
 10.3 * 10.4 * 10.1 ↗ 10.4 * 10.9 *
 9.0 ← 9.9 ↘ 10.8 * 10.4 * 9.9 ↘
 beste Teiler 13.9 (35.) 50.6 (38.) 145.8 (32.)
 Trefferlage 0.56 mm links, 0.55 mm hoch
 Streuwert 1.59, horizontal: 1.94, vertikal: 1.14

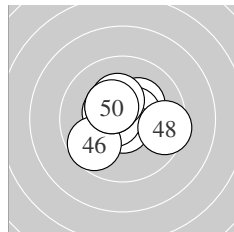

Serie 5:
 10.2 * 10.5 * 10.7 * 10.5 * 10.7 *
 9.7 ↗ 10.4 * 9.5 → 10.3 * 10.4 *
 beste Teiler 60.4 (43.) 69.1 (45.) 102.8 (42.)
 Trefferlage 0.05 mm links, 0.23 mm hoch
 Streuwert 1.40, horizontal: 1.63, vertikal: 1.10

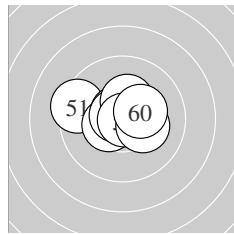

Serie 6:
 9.4 ↖ 10.5 * 10.4 * 10.7 * 10.8 *
 10.7 * 10.3 * 10.9 * 10.2 * 10.3 *
 beste Teiler 16.1 (58.) 45.3 (55.) 61.7 (56.)
 Trefferlage 0.13 mm links, 0.42 mm hoch
 Streuwert 1.20, horizontal: 1.56, vertikal: 0.66

Meyton Elektronik

ISSF AR Women Jun – Wertung – Juniorinnen

StartNr: 44

StandNr: 144

21. Januar 2018 9:31

Thurnwaldova, Sabina #105

CZE

Unterschrift des Schützen

Meyton Elektronik

Ergebnis: **618.9** (592)

Serien: 103.1 102.4 103.4 104.5 103.3 102.2

Zähler: 52 8 0 0 0 0 0 0 0 0

Innenzehner: 37

weiteste: 474 (2), 356 (41), 332 (56)

beste Teiler 3.1 (16.) 28.0 (40.) 34.4 (3.)

Trefferlage 0.18 mm links, 0.64 mm hoch

Streuwert 1.21, horizontal: 1.21, vertikal: 1.22

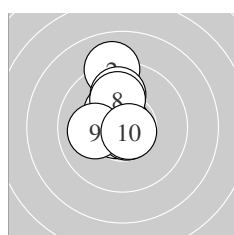
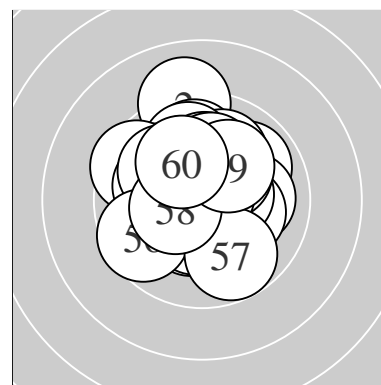

Serie 1:

10.8 *	9.1 ↑	10.8 *	9.9 ↑	10.3 *
10.7 *	10.7 *	10.0 ↑	10.1 ←	10.7 *

beste Teiler 34.4 (3.) 39.0 (1.) 53.2 (7.)

Trefferlage 0.47 mm links, 0.95 mm hoch

Streuwert 1.34, horizontal: 0.76, vertikal: 1.73

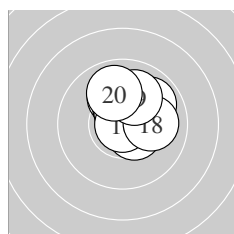

Serie 2:

10.1 ↗	10.1 ↑	10.4 *	10.6 *	10.5 *
10.9 *	9.9 ↗	10.0 →	10.0 ↑	9.9 ↑

beste Teiler 3.1 (16.) 89.2 (14.) 115.6 (15.)

Trefferlage 0.65 mm rechts, 1.10 mm hoch

Streuwert 1.08, horizontal: 1.12, vertikal: 1.05

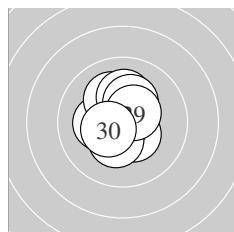

Serie 3:

10.2 *	10.1 ↘	10.7 *	10.4 *	10.3 *
10.4 *	10.1 ↑	10.3 *	10.5 *	10.4 *

beste Teiler 70.3 (23.) 114.8 (29.) 128.3 (30.)

Trefferlage 0.07 mm links, 0.47 mm hoch

Streuwert 1.10, horizontal: 0.95, vertikal: 1.24

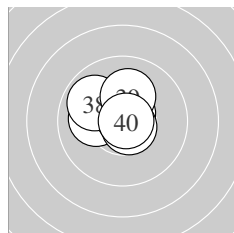

Serie 4:

10.7 *	10.1 ↖	10.1 ←	10.8 *	10.6 *
10.7 *	10.7 *	9.9 ↖	10.1 ↑	10.8 *

beste Teiler 28.0 (40.) 34.9 (34.) 57.0 (36.)

Trefferlage 0.48 mm links, 0.68 mm hoch

Streuwert 0.95, horizontal: 1.13, vertikal: 0.74

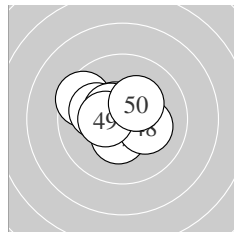

Serie 5:

9.5 ↖	10.6 *	10.6 *	10.1 ↖	10.7 *
10.5 *	10.4 *	10.2 *	10.4 *	10.3 *

beste Teiler 71.5 (45.) 82.1 (43.) 96.6 (42.)

Trefferlage 0.48 mm links, 0.43 mm hoch

Streuwert 1.23, horizontal: 1.50, vertikal: 0.88

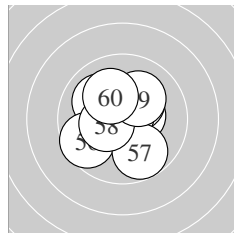

Serie 6:

10.4 *	10.3 *	10.8 *	10.0 ↖	10.7 *
9.6 ↖	9.8 ↘	10.4 *	10.1 ↑	10.1 ↖

beste Teiler 45.2 (53.) 64.8 (55.) 126.9 (51.)

Trefferlage 0.21 mm links, 0.23 mm hoch

Streuwert 1.49, horizontal: 1.51, vertikal: 1.47

Meyton Elektronik

ISSF AR Women Jun – Wertung – Juniorinnen

StandNr: 145

Holzer, Susanne #78

StartNr: 45

21. Januar 2018 9:44

ITA

Unterschrift des Schützen

Meyton Elektronik

Ergebnis:	595.8	(570)							
Serien:	99.1	97.5	101.7	99.8	100.6	97.1			
Zähler:	32	26	2	0	0	0	0	0	0
Innenzehner:	19								
weiteste:	656 (52), 616 (37), 498 (4)								
beste Teiler	44.2 (41.)	50.2 (32.)	50.6 (54.)						
Trefferlage	0.26 mm links, 0.21 mm tief								
Streuwert	2.04, horizontal: 2.26, vertikal: 1.79								

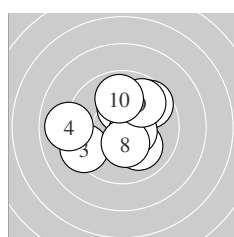
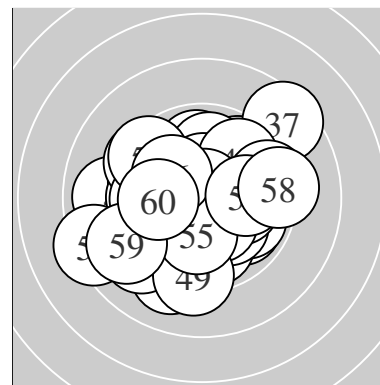

Serie 1:	10.2 *	10.0 ↘	9.3 ↙	9.0 ←	9.7 ↗
	10.3 *	10.5 *	10.4 *	9.8 ↗	9.9 ↑
beste Teiler	103.2 (7.)	150.2 (8.)	173.4 (6.)		
Trefferlage	0.10 mm links, 0.47 mm hoch				
Streuwert	2.10, horizontal: 2.38, vertikal: 1.79				

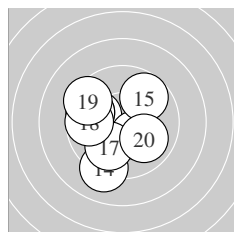

Serie 2:	10.0 ←	9.7 ←	10.3 *	9.1 ↓	9.7 ↗
	9.7 ←	9.9 ↓	9.7 ←	9.4 ↘	10.0 ↘
beste Teiler	164.1 (13.)	242.5 (11.)	248.4 (20.)		
Trefferlage	1.25 mm links, 0.23 mm tief				
Streuwert	2.09, horizontal: 2.14, vertikal: 2.03				

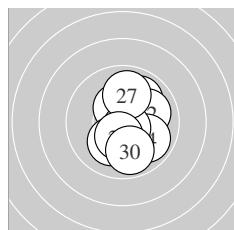

Serie 3:	9.9 ↗	10.0 →	10.5 *	9.9 ↘	10.4 *
	10.7 *	9.9 ↑	10.1 ↓	10.4 *	9.9 ↓
beste Teiler	65.7 (26.)	107.1 (23.)	133.6 (29.)		
Trefferlage	0.54 mm rechts, 0.20 mm tief				
Streuwert	1.48, horizontal: 1.12, vertikal: 1.76				

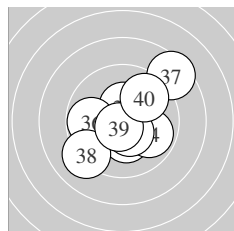

Serie 4:	10.3 *	10.8 *	10.4 *	9.9 ↘	10.5 *
	9.8 ←	8.5 ↗	9.1 ↙	10.7 *	9.8 ↗
beste Teiler	50.2 (32.)	65.0 (39.)	122.3 (35.)		
Trefferlage	0.38 mm rechts, 0.00 mm				
Streuwert	2.22, horizontal: 2.34, vertikal: 2.09				

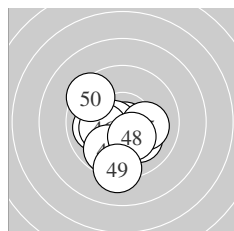

Serie 5:	10.8 *	10.0 ←	10.6 *	10.1 ↘	10.1 →
	10.2 *	9.8 ↓	10.3 *	9.2 ↓	9.5 ↖
beste Teiler	44.2 (41.)	91.2 (43.)	159.5 (48.)		
Trefferlage	0.53 mm links, 0.94 mm tief				
Streuwert	1.69, horizontal: 1.67, vertikal: 1.71				

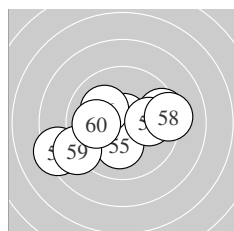

Serie 6:	10.1 ←	8.3 ↙	9.5 →	10.8 *	10.1 ↓
	10.1 ↘	10.0 →	9.2 →	9.0 ←	10.0 ←
beste Teiler	50.6 (54.)	201.9 (55.)	209.4 (56.)		
Trefferlage	0.63 mm links, 0.39 mm tief				
Streuwert	2.58, horizontal: 3.34, vertikal: 1.45				

Meyton Elektronik

ISSF AR Women Jun – Wertung – Juniorinnen

StandNr: 146

Rinner, Pia #101

StartNr: 46

21. Januar 2018 9:49

BY – Schwaben

Unterschrift des Schützen

Meyton Elektronik

Ergebnis:	618.8	(591)						
Serien:	102.0	102.5	104.1	103.1	103.4	103.7		
Zähler:	51	9	0	0	0	0	0	0
Innenzehner:	39							
weiteste:	313 (5), 306 (9), 300 (59)							
beste Teiler	42.0 (48.)	46.4 (20.)	48.9 (15.)					
Trefferlage	0.05 mm links, 0.16 mm tief							
Streuwert	1.25, horizontal: 1.36, vertikal: 1.14							

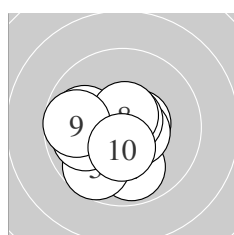
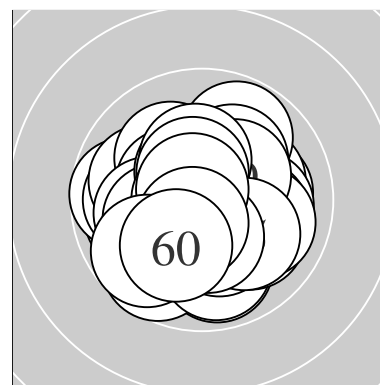

Serie 1:

10.6 *	9.9 ↓	10.6 *	10.7 *	9.7 ↙
9.9 ←	9.9 ←	10.6 *	9.7 ←	10.4 *

beste Teiler 63.7 (4.) 80.2 (8.) 98.0 (3.)
 Trefferlage 0.68 mm links, 0.53 mm tief
 Streuwert 1.44, horizontal: 1.59, vertikal: 1.27

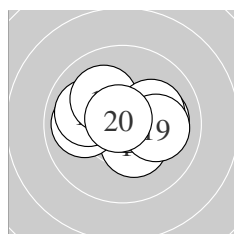

Serie 2:

10.4 *	10.2 *	9.9 ←	10.1 →	10.8 *
10.0 ↖	10.1 ↘	10.1 →	10.1 →	10.8 *

beste Teiler 46.4 (20.) 48.9 (15.) 150.5 (11.)
 Trefferlage 0.03 mm links, 0.38 mm hoch
 Streuwert 1.40, horizontal: 1.80, vertikal: 0.82

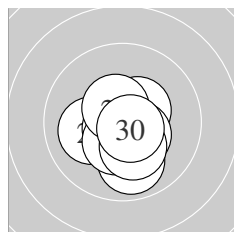

Serie 3:

10.7 *	9.9 ↓	10.4 *	10.1 ←	10.7 *
10.4 *	10.4 *	10.3 *	10.5 *	10.7 *

beste Teiler 61.5 (25.) 67.4 (30.) 70.2 (21.)
 Trefferlage 0.04 mm rechts, 0.66 mm tief
 Streuwert 0.99, horizontal: 0.94, vertikal: 1.04

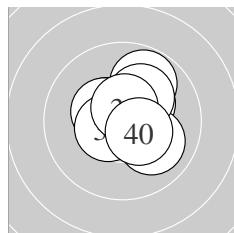

Serie 4:

10.5 *	9.8 ↗	10.4 *	10.4 *	10.3 *
10.0 ↘	10.2 *	10.5 *	10.6 *	10.4 *

beste Teiler 90.9 (39.) 106.0 (38.) 122.6 (31.)
 Trefferlage 0.45 mm rechts, 0.59 mm hoch
 Streuwert 1.14, horizontal: 1.15, vertikal: 1.14

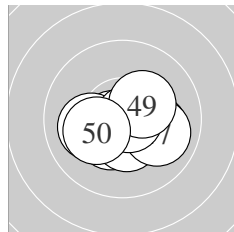

Serie 5:

10.4 *	10.7 *	10.1 ←	10.1 →	10.4 *
10.4 *	10.0 ↘	10.8 *	10.3 *	10.2 *

beste Teiler 42.0 (48.) 72.0 (42.) 129.0 (46.)
 Trefferlage 0.25 mm rechts, 0.45 mm tief
 Streuwert 1.18, horizontal: 1.53, vertikal: 0.66

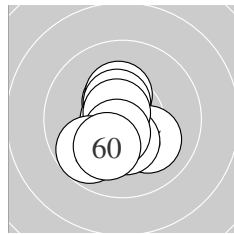

Serie 6:

10.5 *	10.3 *	10.5 *	10.7 *	10.1 ↘
10.4 *	10.7 *	10.6 *	9.8 ↙	10.1 ↙

beste Teiler 57.3 (57.) 58.0 (54.) 100.8 (58.)
 Trefferlage 0.38 mm links, 0.33 mm tief
 Streuwert 1.17, horizontal: 0.97, vertikal: 1.35

Meyton Elektronik

ISSF AR Women Jun – Wertung – Juniorinnen

StandNr: 147

Schachner, Christine #90

StartNr: 47

21. Januar 2018 9:44

AUT

Unterschrift des Schützen

Meyton Elektronik

Ergebnis: **600.6** (576)
 Serien: 101.9 96.6 102.3 100.5 98.8 100.5
 Zähler: 37 22 1 0 0 0 0 0 0
 Innenzehner: 23
 weiteste: 598 (18), 467 (20), 444 (16)
 beste Teiler 14.8 (51.) 40.3 (21.) 63.3 (1.)
 Trefferlage 0.34 mm links, 0.35 mm tief
 Streuwert 1.82, horizontal: 2.09, vertikal: 1.50

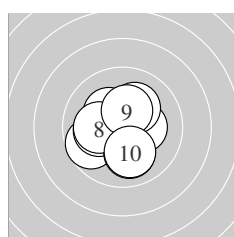
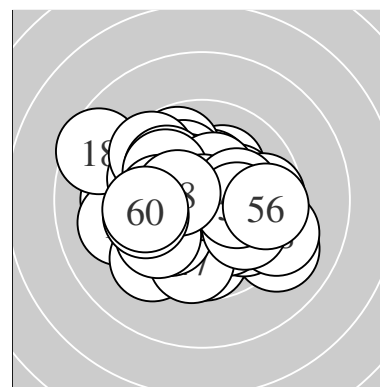

Serie 1:
 10.7 * 10.3 * 10.3 * 9.7 ↙ 10.2 *
 10.1 ← 10.0 ↓ 10.1 ← 10.4 * 10.1 ↓
 beste Teiler 63.3 (1.) 149.8 (9.) 166.0 (3.)
 Trefferlage 0.43 mm links, 0.17 mm tief
 Streuwert 1.46, horizontal: 1.52, vertikal: 1.41

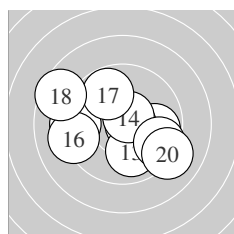

Serie 2:
 9.8 → 10.7 * 10.0 ↓ 10.6 * 9.3 ←
 9.2 ← 9.8 ↘ 8.6 ↖ 9.5 ↘ 9.1 ↘
 beste Teiler 71.1 (12.) 80.2 (14.) 246.0 (13.)
 Trefferlage 0.32 mm links, 0.24 mm tief
 Streuwert 2.68, horizontal: 3.33, vertikal: 1.81

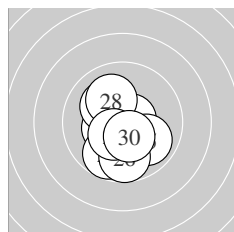

Serie 3:
 10.8 * 10.4 * 10.7 * 9.8 ↓ 9.9 ↘
 9.7 ↓ 10.1 ↘ 10.1 ↘ 10.4 * 10.4 *
 beste Teiler 40.3 (21.) 73.6 (23.) 133.2 (29.)
 Trefferlage 0.26 mm links, 0.64 mm tief
 Streuwert 1.40, horizontal: 1.14, vertikal: 1.62

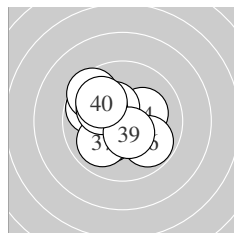

Serie 4:
 9.8 ↖ 10.2 * 9.5 ↖ 10.2 * 10.4 *
 9.8 ↘ 10.0 ↗ 10.1 ↖ 10.5 * 10.0 ↖
 beste Teiler 115.8 (39.) 142.8 (35.) 179.5 (32.)
 Trefferlage 0.82 mm links, 0.22 mm hoch
 Streuwert 1.65, horizontal: 1.75, vertikal: 1.54

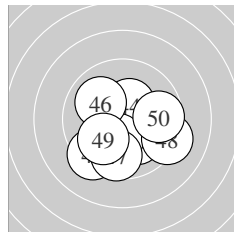

Serie 5:
 9.3 ↗ 10.2 * 10.1 ↘ 10.4 * 10.2 *
 10.0 ↖ 9.7 ↓ 9.2 ↘ 10.0 ↗ 9.7 →
 beste Teiler 141.8 (44.) 180.7 (45.) 181.3 (42.)
 Trefferlage 0.03 mm rechts, 0.91 mm tief
 Streuwert 1.99, horizontal: 2.18, vertikal: 1.77

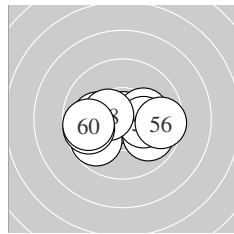

Serie 6:
 10.9 * 9.9 ↘ 10.2 * 10.1 ← 10.2 *
 9.6 → 9.8 ↗ 10.4 * 9.7 ← 9.7 ←
 beste Teiler 14.8 (51.) 132.9 (58.) 185.1 (55.)
 Trefferlage 0.24 mm links, 0.41 mm tief
 Streuwert 1.78, horizontal: 2.39, vertikal: 0.76

ISSF AR Women Jun – Wertung – Juniorinnen

StandNr: 101

Mair, Katrin #202

StartNr: 48

21. Januar 2018 11:20

BY – Schwaben

Unterschrift des Schützen

Meyton Elektronik

Ergebnis: **613.9** (587)
 Serien: 101.5 101.7 101.7 104.2 102.7 102.1
 Zähler: 47 13 0 0 0 0 0 0 0
 Innenzehner: 36
 weiteste: 444 (30), 402 (19), 350 (42)
 beste Teiler 39.6 (31.) 42.5 (48.) 43.1 (16.)
 Trefferlage 0.25 mm rechts, 0.07 mm hoch
 Streuwert 1.43, horizontal: 1.68, vertikal: 1.13

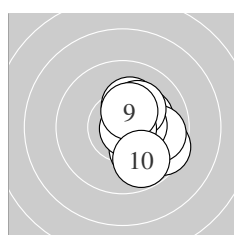
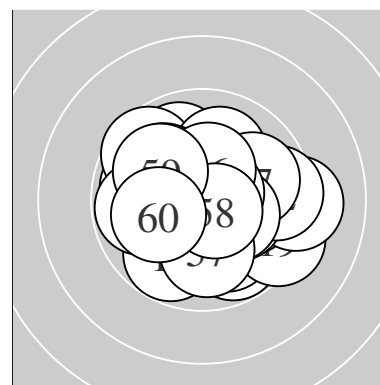

Serie 1:
 10.1 ↘ 9.6 ↗ 10.2 * 10.2 * 9.8 →
 10.4 * 10.2 * 10.8 * 10.4 * 9.8 ↘
 beste Teiler 43.4 (8.) 126.5 (6.) 136.6 (9.)
 Trefferlage 1.42 mm rechts, 0.11 mm tief
 Streuwert 1.21, horizontal: 0.91, vertikal: 1.46

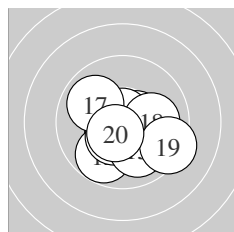

Serie 2:
 10.5 * 9.8 ↙ 10.4 * 10.5 * 10.0 ↘
 10.8 * 9.9 ↖ 10.0 → 9.3 ↗ 10.5 *
 beste Teiler 43.1 (16.) 104.5 (20.) 104.6 (11.)
 Trefferlage 0.24 mm rechts, 0.70 mm tief
 Streuwert 1.53, horizontal: 1.77, vertikal: 1.25

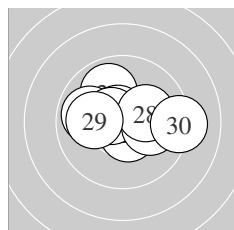

Serie 3:
 10.5 * 9.9 ↖ 10.6 * 9.9 ← 10.6 *
 10.6 * 10.1 → 10.2 * 10.1 ← 9.2 →
 beste Teiler 76.1 (23.) 98.8 (25.) 100.2 (26.)
 Trefferlage 0.27 mm rechts, 0.38 mm hoch
 Streuwert 1.64, horizontal: 2.16, vertikal: 0.86

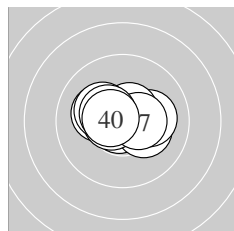

Serie 4:
 10.8 * 10.2 * 10.2 * 10.1 → 10.6 *
 10.6 * 10.5 * 10.2 * 10.4 * 10.6 *
 beste Teiler 39.6 (31.) 88.0 (36.) 94.8 (35.)
 Trefferlage 0.11 mm links, 0.22 mm hoch
 Streuwert 1.05, horizontal: 1.40, vertikal: 0.48

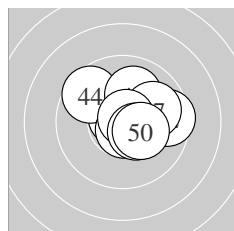

Serie 5:
 10.7 * 9.6 → 10.7 * 9.6 ↖ 10.0 ↗
 10.7 * 9.9 → 10.8 * 10.4 * 10.3 *
 beste Teiler 42.5 (48.) 59.0 (43.) 60.4 (41.)
 Trefferlage 0.70 mm rechts, 0.46 mm hoch
 Streuwert 1.37, horizontal: 1.62, vertikal: 1.05

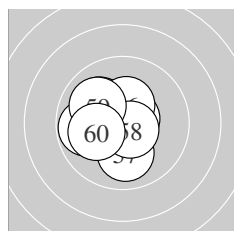

Serie 6:
 10.6 * 9.8 ← 10.2 * 10.4 * 10.0 ↘
 10.4 * 10.0 ↓ 10.6 * 10.0 ↖ 10.1 ←
 beste Teiler 76.9 (51.) 80.1 (58.) 143.9 (56.)
 Trefferlage 0.97 mm links, 0.21 mm hoch
 Streuwert 1.26, horizontal: 1.29, vertikal: 1.23

Meyton Elektronik

ISSF AR Women Jun – Wertung – Juniorinnen

StartNr: 49

StandNr: 102

21. Januar 2018 11:16

Oliver, Lorena Ayelen #85

ARG

Unterschrift des Schützen

Meyton Elektronik

Ergebnis: **615.4** (590)
 Serien: 103.3 102.6 104.0 100.4 102.0 103.1
 Zähler: 50 10 0 0 0 0 0 0 0
 Innenzehner: 42
 weiteste: 478 (39), 407 (32), 404 (19)
 beste Teiler 20.6 (9.) 49.4 (40.) 63.5 (13.)
 Trefferlage 0.57 mm links, 0.17 mm tief
 Streuwert 1.31, horizontal: 1.37, vertikal: 1.26

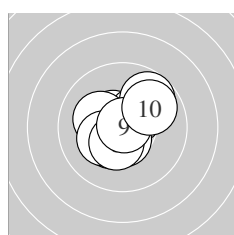
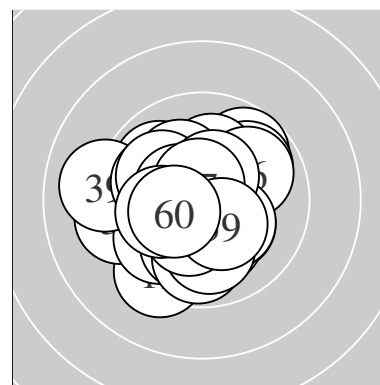

Serie 1:
 10.5 * 10.4 * 10.2 * 10.4 * 10.3 *
 9.7 ↗ 10.6 * 10.4 * 10.9 * 9.9 ↗
 beste Teiler 20.6 (9.) 98.5 (7.) 108.2 (1.)
 Trefferlage 0.00 mm , 0.21 mm hoch
 Streuwert 1.31, horizontal: 1.38, vertikal: 1.24

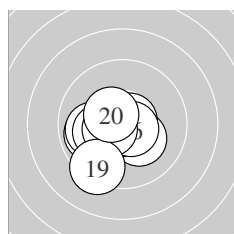

Serie 2:
 10.2 * 9.9 ← 10.7 * 10.7 * 10.0 ←
 10.6 * 10.2 * 10.5 * 9.3 ↓ 10.5 *
 beste Teiler 63.5 (13.) 70.7 (14.) 79.2 (16.)
 Trefferlage 0.87 mm links, 0.67 mm tief
 Streuwert 1.26, horizontal: 1.38, vertikal: 1.12

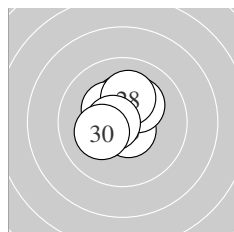

Serie 3:
 10.6 * 10.3 * 10.4 * 10.7 * 10.6 *
 10.2 * 10.3 * 10.1 ↑ 10.6 * 10.2 *
 beste Teiler 64.2 (24.) 79.8 (21.) 80.0 (25.)
 Trefferlage 0.40 mm links, 0.43 mm hoch
 Streuwert 0.96, horizontal: 0.91, vertikal: 1.01

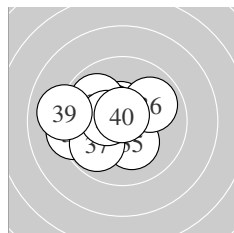

Serie 4:
 10.6 * 9.3 ← 10.5 * 9.9 ↘ 10.2 *
 9.9 ↗ 9.8 ↙ 10.4 * 9.0 ← 10.8 *
 beste Teiler 49.4 (40.) 98.3 (31.) 115.1 (33.)
 Trefferlage 1.22 mm links, 0.16 mm hoch
 Streuwert 1.72, horizontal: 2.10, vertikal: 1.22

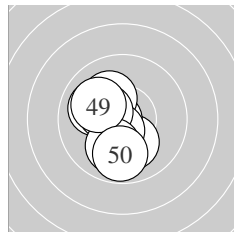

Serie 5:
 10.4 * 10.1 ↓ 10.7 * 10.2 * 10.5 *
 10.0 ↖ 10.3 * 10.0 ↓ 10.0 ↖ 9.8 ↓
 beste Teiler 65.4 (43.) 104.2 (45.) 142.2 (41.)
 Trefferlage 0.80 mm links, 0.50 mm tief
 Streuwert 1.27, horizontal: 0.89, vertikal: 1.55

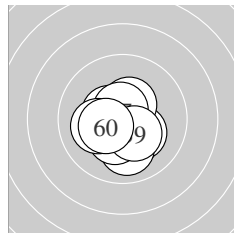

Serie 6:
 10.5 * 10.2 * 10.3 * 10.4 * 10.0 ↓
 10.3 * 10.6 * 10.1 ← 10.3 * 10.4 *
 beste Teiler 76.9 (57.) 119.1 (51.) 127.5 (54.)
 Trefferlage 0.13 mm links, 0.65 mm tief
 Streuwert 1.12, horizontal: 1.10, vertikal: 1.14

Meyton Elektronik

ISSF AR Women Jun – Wertung – Juniorinnen

StandNr: 103

Paravati, Paola #106

StartNr: 50

21. Januar 2018 11:14

ITA

Unterschrift des Schützen

Meyton Elektronik

Ergebnis: **616.3** (587)
 Serien: 102.1 104.6 102.7 102.1 103.2 101.6
 Zähler: 47 13 0 0 0 0 0 0 0
 Innenzehner: 41
 weiteste: 462 (1), 351 (54), 301 (22)
 beste Teiler 16.6 (28.) 48.5 (48.) 59.0 (3.)
 Trefferlage 0.24 mm rechts, 0.19 mm tief
 Streuwert 1.34, horizontal: 1.27, vertikal: 1.40

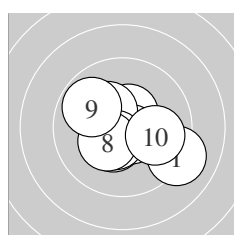
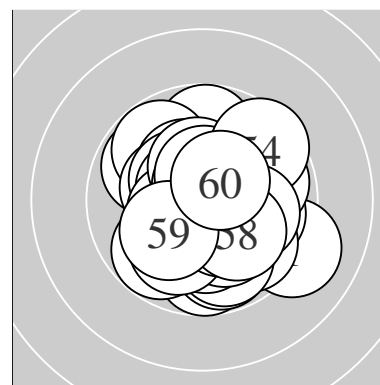

Serie 1:
 9.1 ↘ 10.4 * 10.7 * 10.5 * 10.6 *
 10.3 * 10.5 * 10.3 * 9.8 ↖ 9.9 →
 beste Teiler 59.0 (3.) 82.2 (5.) 110.9 (4.)
 Trefferlage 0.23 mm rechts, 0.27 mm tief
 Streuwert 1.58, horizontal: 1.88, vertikal: 1.19

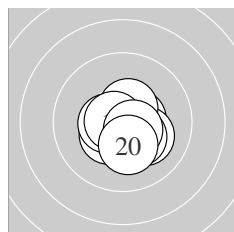

Serie 2:
 10.4 * 10.5 * 10.2 * 10.7 * 10.5 *
 10.3 * 10.5 * 10.7 * 10.6 * 10.2 *
 beste Teiler 66.4 (18.) 74.0 (14.) 97.4 (19.)
 Trefferlage 0.26 mm rechts, 0.48 mm tief
 Streuwert 0.88, horizontal: 0.96, vertikal: 0.80

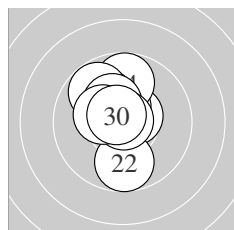

Serie 3:
 10.6 * 9.7 ↓ 10.5 * 9.8 ↑ 10.1 ↖
 9.8 ↘ 10.3 * 10.9 * 10.3 * 10.7 *
 beste Teiler 16.6 (28.) 70.9 (30.) 94.1 (21.)
 Trefferlage 0.48 mm links, 0.83 mm hoch
 Streuwert 1.30, horizontal: 0.86, vertikal: 1.62

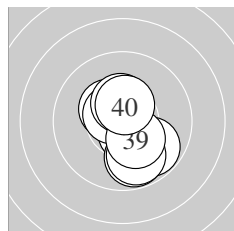

Serie 4:
 10.4 * 9.9 ↘ 10.6 * 9.8 ↘ 9.8 ↓
 10.6 * 9.8 ↓ 10.4 * 10.3 * 10.5 *
 beste Teiler 92.9 (36.) 98.0 (33.) 122.1 (40.)
 Trefferlage 0.50 mm rechts, 0.75 mm tief
 Streuwert 1.34, horizontal: 1.00, vertikal: 1.61

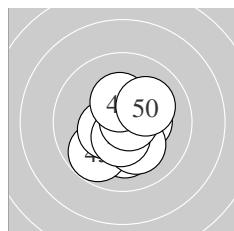

Serie 5:
 10.3 * 10.2 * 9.8 ↙ 10.6 * 10.2 *
 10.4 * 10.5 * 10.8 * 10.3 * 10.1 →
 beste Teiler 48.5 (48.) 90.6 (44.) 113.8 (47.)
 Trefferlage 0.13 mm rechts, 0.39 mm tief
 Streuwert 1.24, horizontal: 1.12, vertikal: 1.35

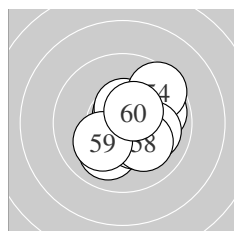

Serie 6:
 9.9 → 10.7 * 10.5 * 9.5 ↗ 10.0 ↙
 10.3 * 10.0 → 10.1 ↘ 10.1 ↙ 10.5 *
 beste Teiler 64.0 (52.) 112.3 (53.) 121.6 (60.)
 Trefferlage 0.82 mm rechts, 0.08 mm tief
 Streuwert 1.45, horizontal: 1.46, vertikal: 1.44

Meyton Elektronik

ISSF AR Women Jun – Wertung – Juniorinnen

StandNr: 104

Efimova, Olga #67

StartNr: 51

21. Januar 2018 11:36

RUS

Unterschrift des Schützen

Meyton Elektronik

Ergebnis: **607.2** (579)

Serien: 101.6 101.9 100.2 103.4 102.0 98.1

Zähler: 42 15 3 0 0 0 0 0 0

Innenzehner: 36

weiteste: 625 (56), 558 (9), 552 (13)

beste Teiler 39.6 (2.) 46.5 (12.) 48.3 (38.)

Trefferlage 0.09 mm links, 0.11 mm hoch

Streuwert 1.77, horizontal: 2.12, vertikal: 1.33

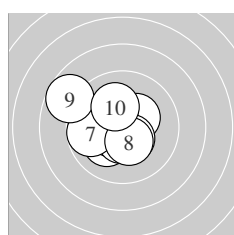
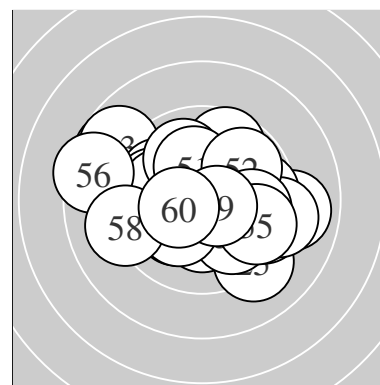

Serie 1:

10.1 ↙	10.8 *	10.5 *	10.3 *	10.5 *
10.4 *	9.8 ←	10.4 *	8.7 ↘	10.1 ↑

beste Teiler 39.6 (2.) 113.8 (5.) 123.0 (3.)

Trefferlage 0.90 mm links, 0.03 mm tief

Streuwert 1.65, horizontal: 1.86, vertikal: 1.42

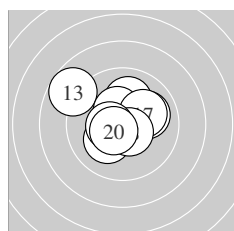

Serie 2:

10.0 →	10.8 *	8.7 ↘	10.1 ↑	10.2 *
10.4 *	10.1 →	10.6 *	10.5 *	10.5 *

beste Teiler 46.5 (12.) 95.0 (18.) 103.0 (20.)

Trefferlage 0.32 mm links, 0.58 mm hoch

Streuwert 1.68, horizontal: 1.94, vertikal: 1.37

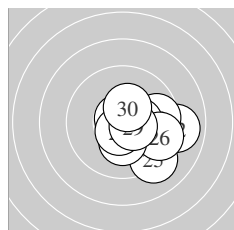

Serie 3:

10.7 *	9.0 →	9.7 →	10.4 *	9.2 ↘
9.5 ↘	10.2 *	10.6 *	10.5 *	10.4 *

beste Teiler 51.6 (21.) 90.8 (28.) 106.4 (29.)

Trefferlage 1.66 mm rechts, 0.62 mm tief

Streuwert 1.61, horizontal: 1.85, vertikal: 1.34

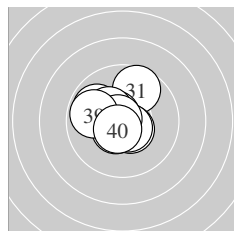

Serie 4:

9.7 ↑	9.9 ↘	10.6 *	10.5 *	10.5 *
10.3 *	10.6 *	10.8 *	9.9 ←	10.6 *

beste Teiler 48.3 (38.) 82.3 (37.) 88.5 (40.)

Trefferlage 0.60 mm links, 0.36 mm hoch

Streuwert 1.23, horizontal: 1.28, vertikal: 1.19

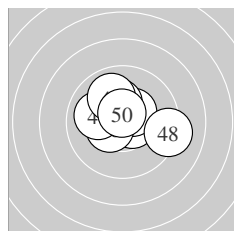

Serie 5:

10.6 *	10.2 *	10.5 *	10.4 *	10.2 *
10.4 *	10.0 ←	9.2 →	9.9 ↘	10.6 *

beste Teiler 83.2 (50.) 92.4 (41.) 124.8 (43.)

Trefferlage 0.12 mm links, 0.64 mm hoch

Streuwert 1.50, horizontal: 1.87, vertikal: 1.01

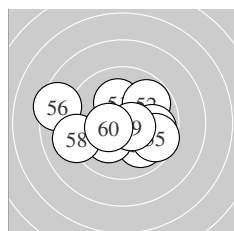

Serie 6:

10.2 *	9.8 ↗	9.9 ↘	9.8 →	9.6 →
8.5 ←	10.2 *	9.1 ←	10.6 *	10.4 *

beste Teiler 89.6 (59.) 136.6 (60.) 192.5 (51.)

Trefferlage 0.28 mm links, 0.22 mm tief

Streuwert 2.38, horizontal: 3.04, vertikal: 1.44

Meyton Elektronik

ISSF AR Women Jun – Wertung – Juniorinnen

StandNr: 105

Schneider, Antonia #92

StartNr: 52

21. Januar 2018 11:20

BY – Schwaben

Unterschrift des Schützen

Meyton Elektronik

Ergebnis: **611.9** (585)
 Serien: 102.5 103.8 98.7 102.0 103.5 101.4
 Zähler: 46 13 1 0 0 0 0 0 0
 Innenzehner: 39
 weiteste: 584 (25), 488 (52), 460 (23)
 beste Teiler 45.8 (48.) 55.4 (9.) 63.0 (43.)
 Trefferlage 0.21 mm links, 0.44 mm hoch
 Streuwert 1.49, horizontal: 1.81, vertikal: 1.09

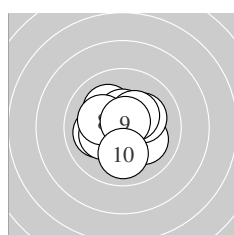
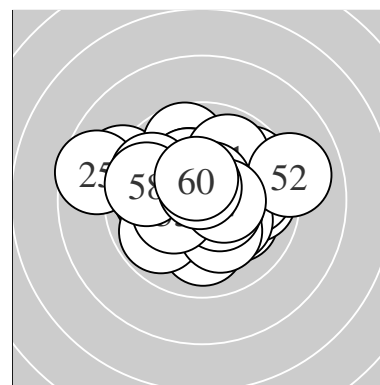

Serie 1:
 10.1 ↖ 10.1 ↘ 10.2 * 10.5 * 10.1 ←
 10.2 * 10.4 * 10.2 * 10.7 * 10.0 ↓
 beste Teiler 55.4 (9.) 116.0 (4.) 147.8 (7.)
 Trefferlage 0.20 mm links, 0.11 mm hoch
 Streuwert 1.36, horizontal: 1.48, vertikal: 1.23

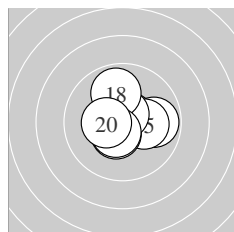

Serie 2:
 10.5 * 9.8 → 10.6 * 10.7 * 10.2 *
 10.5 * 10.7 * 9.9 ↑ 10.5 * 10.4 *
 beste Teiler 72.6 (14.) 72.9 (17.) 77.0 (13.)
 Trefferlage 0.04 mm rechts, 0.10 mm hoch
 Streuwert 1.20, horizontal: 1.35, vertikal: 1.03

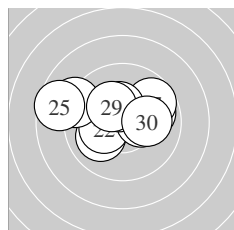

Serie 3:
 10.0 ↙ 10.3 * 9.1 ↖ 9.9 → 8.6 ←
 10.3 * 9.7 ↗ 10.4 * 10.3 * 10.1 →
 beste Teiler 141.4 (28.) 165.0 (26.) 170.0 (29.)
 Trefferlage 0.59 mm links, 0.68 mm hoch
 Streuwert 2.17, horizontal: 2.88, vertikal: 1.05

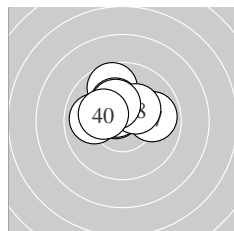

Serie 4:
 10.2 * 10.6 * 9.7 ↑ 10.6 * 10.3 *
 9.9 ← 9.9 → 10.3 * 10.3 * 10.2 *
 beste Teiler 91.2 (32.) 97.6 (34.) 159.9 (38.)
 Trefferlage 0.45 mm links, 1.16 mm hoch
 Streuwert 1.17, horizontal: 1.43, vertikal: 0.82

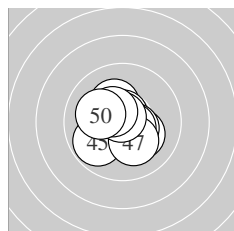

Serie 5:
 10.2 * 10.2 * 10.7 * 10.5 * 9.8 ←
 10.6 * 10.2 * 10.8 * 10.4 * 10.1 ←
 beste Teiler 45.8 (48.) 63.0 (43.) 89.8 (46.)
 Trefferlage 0.16 mm links, 0.11 mm tief
 Streuwert 1.21, horizontal: 1.28, vertikal: 1.14

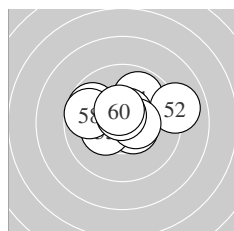

Serie 6:
 9.9 ↗ 9.0 → 10.6 * 10.5 * 10.3 *
 9.7 ↖ 10.5 * 9.7 ← 10.7 * 10.5 *
 beste Teiler 69.0 (59.) 97.0 (53.) 107.8 (54.)
 Trefferlage 0.10 mm rechts, 0.73 mm hoch
 Streuwert 1.71, horizontal: 2.23, vertikal: 0.92

ISSF AR Women Jun – Wertung – Juniorinnen

StandNr: 106

Holzmann, Nadine #203

StartNr: 53

21. Januar 2018 11:28

T – SG Matri

Unterschrift des Schützen

Meyton Elektronik

Ergebnis: **619.6** (589)

Serien: 102.9 102.7 104.5 103.1 102.2 104.2

Zähler: 49 11 0 0 0 0 0 0 0 0

Innenzehner: 40

weiteste: 402 (5), 307 (45), 288 (33)

beste Teiler 22.5 (57.) 23.8 (41.) 29.2 (52.)

Trefferlage 0.06 mm rechts, 0.14 mm tief

Streuwert 1.27, horizontal: 1.31, vertikal: 1.22

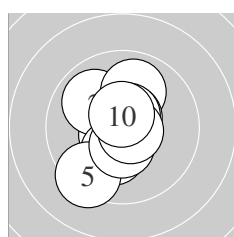
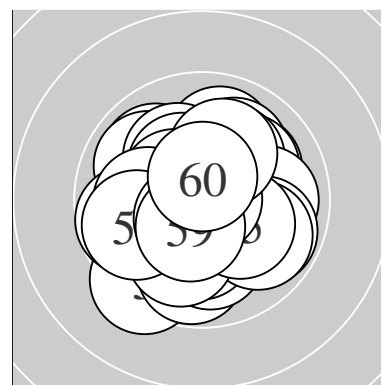

Serie 1:

10.6 *	9.9 ↘	9.9 ↑	10.2 *	9.3 ↙
10.6 *	10.5 *	10.6 *	10.7 *	10.6 *

beste Teiler 60.4 (9.) 80.4 (6.) 84.6 (8.)

Trefferlage 0.37 mm links, 0.05 mm tief

Streuwert 1.41, horizontal: 1.05, vertikal: 1.70

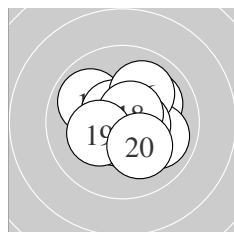

Serie 2:

9.9 ↘	10.6 *	10.1 ↗	10.6 *	9.9 ↘
10.0 ↗	10.5 *	10.6 *	10.3 *	10.2 *

beste Teiler 77.7 (18.) 82.4 (14.) 87.7 (12.)

Trefferlage 0.35 mm rechts, 0.15 mm hoch

Streuwert 1.34, horizontal: 1.49, vertikal: 1.18

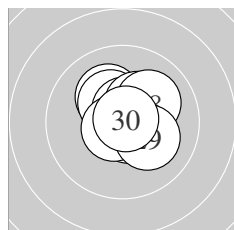

Serie 3:

10.2 *	10.3 *	10.6 *	10.7 *	10.7 *
10.6 *	10.3 *	10.1 ↗	10.2 *	10.8 *

beste Teiler 31.1 (30.) 66.5 (24.) 73.0 (25.)

Trefferlage 0.34 mm rechts, 0.49 mm hoch

Streuwert 0.95, horizontal: 0.97, vertikal: 0.94

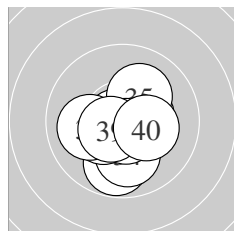

Serie 4:

10.4 *	10.8 *	9.8 ↓	10.0 ↓	10.1 ↗
10.4 *	10.0 ←	10.7 *	10.6 *	10.3 *

beste Teiler 38.2 (32.) 73.6 (38.) 98.4 (39.)

Trefferlage 0.05 mm links, 0.59 mm tief

Streuwert 1.24, horizontal: 1.22, vertikal: 1.26

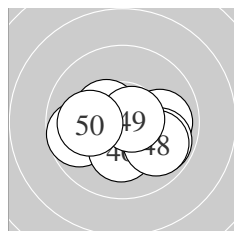

Serie 5:

10.9 *	9.9 →	10.6 *	9.8 ↘	9.7 ←
10.2 *	10.4 *	9.9 ↘	10.7 *	10.1 ←

beste Teiler 23.8 (41.) 65.8 (49.) 84.0 (43.)

Trefferlage 0.24 mm rechts, 0.52 mm tief

Streuwert 1.47, horizontal: 1.92, vertikal: 0.80

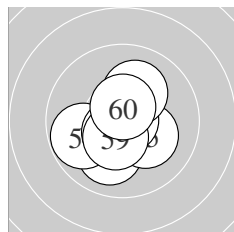

Serie 6:

10.7 *	10.8 *	10.0 ↓	9.8 ←	10.2 *
10.6 *	10.9 *	10.1 ↑	10.5 *	10.6 *

beste Teiler 22.5 (57.) 29.2 (52.) 73.8 (51.)

Trefferlage 0.14 mm links, 0.33 mm tief

Streuwert 1.15, horizontal: 1.14, vertikal: 1.17

ISSF AR Women Jun – Wertung – Juniorinnen

StandNr: 107

Kharkova, Tatiana #82

StartNr: 54

21. Januar 2018 11:29

RUS

Unterschrift des Schützen

Meyton Elektronik

Ergebnis: **618.6** (589)
 Serien: 103.7 103.4 105.8 102.2 101.7 101.8
 Zähler: 49 11 0 0 0 0 0 0 0
 Innenzehner: 43
 weiteste: 483 (45), 334 (8), 310 (60)
 beste Teiler 22.0 (27.) 40.1 (18.) 47.3 (29.)
 Trefferlage 0.13 mm rechts, 0.11 mm tief
 Streuwert 1.29, horizontal: 1.36, vertikal: 1.22

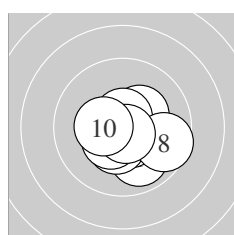
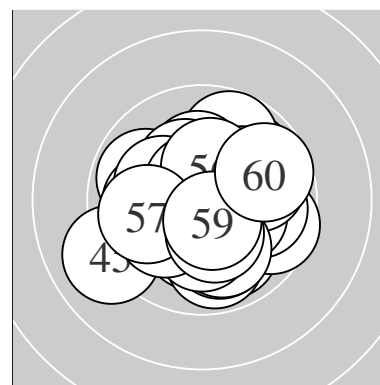

Serie 1:
 9.9 ↘ 10.7 * 10.6 * 10.4 * 10.3 *
 10.4 * 10.7 * 9.6 → 10.7 * 10.4 *
 beste Teiler 56.3 (9.) 69.8 (2.) 72.0 (7.)
 Trefferlage 0.39 mm rechts, 0.46 mm tief
 Streuwert 1.17, horizontal: 1.29, vertikal: 1.04

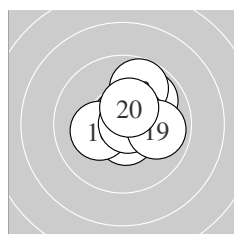

Serie 2:
 10.8 * 9.9 ↗ 9.8 ↗ 10.5 * 10.6 *
 10.2 * 10.5 * 10.8 * 9.9 → 10.4 *
 beste Teiler 40.1 (18.) 49.0 (11.) 92.4 (15.)
 Trefferlage 0.66 mm rechts, 0.58 mm hoch
 Streuwert 1.14, horizontal: 1.17, vertikal: 1.12

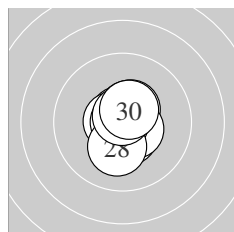

Serie 3:
 10.6 * 10.7 * 10.5 * 10.5 * 10.5 *
 10.6 * 10.9 * 10.2 * 10.8 * 10.5 *
 beste Teiler 22.0 (27.) 47.3 (29.) 53.6 (22.)
 Trefferlage 0.11 mm rechts, 0.04 mm hoch
 Streuwert 0.76, horizontal: 0.53, vertikal: 0.94

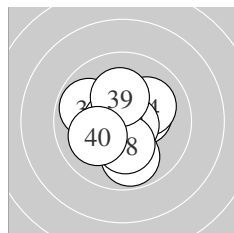

Serie 4:
 10.4 * 9.8 ↖ 10.3 * 10.1 ↗ 10.7 *
 10.6 * 9.8 ↓ 10.2 * 10.2 * 10.1 ↖
 beste Teiler 60.9 (35.) 78.1 (36.) 127.7 (31.)
 Trefferlage 0.18 mm links, 0.22 mm tief
 Streuwert 1.41, horizontal: 1.42, vertikal: 1.40

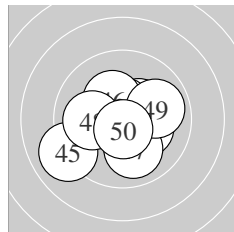

Serie 5:
 10.4 * 10.7 * 10.6 * 10.2 * 9.0 ↖
 10.3 * 10.0 ↓ 10.0 ← 9.9 → 10.6 *
 beste Teiler 60.5 (42.) 78.1 (50.) 91.0 (43.)
 Trefferlage 0.07 mm links, 0.17 mm tief
 Streuwert 1.68, horizontal: 1.95, vertikal: 1.36

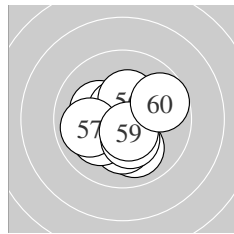

Serie 6:
 10.0 ↓ 10.2 * 10.2 * 10.6 * 10.1 ↖
 10.3 * 9.9 ← 10.3 * 10.5 * 9.7 →
 beste Teiler 81.4 (54.) 105.9 (59.) 154.4 (56.)
 Trefferlage 0.11 mm links, 0.44 mm tief
 Streuwert 1.47, horizontal: 1.56, vertikal: 1.37

Meyton Elektronik

ISSF AR Women Jun – Wertung – Juniorinnen

StandNr: 108

Kitzbichler, Jasmin #112

StartNr: 55

21. Januar 2018 11:38

AUT

Unterschrift des Schützen

Meyton Elektronik

Ergebnis: **623.6** (595)
 Serien: 103.5 103.5 105.4 103.2 104.5 103.5
 Zähler: 55 5 0 0 0 0 0 0 0 0
 Innenzehner: 47
 weiteste: 373 (8), 296 (19), 274 (28)
 beste Teiler 20.6 (26.) 41.8 (14.) 50.2 (25.)
 Trefferlage 0.05 mm rechts, 0.01 mm tief
 Streuwert 1.14, horizontal: 1.24, vertikal: 1.03

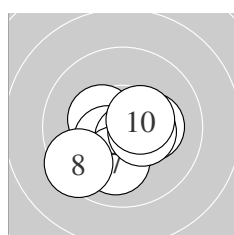
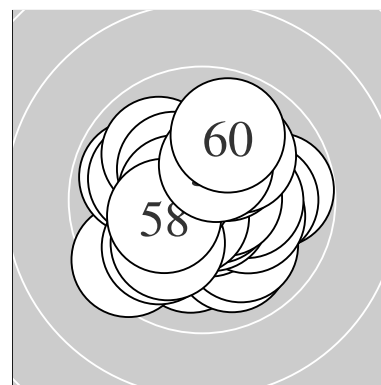

Serie 1:
 10.7 * 10.7 * 10.2 * 10.4 * 10.4 *
 10.6 * 10.1 ↓ 9.5 ↙ 10.4 * 10.5 *
 beste Teiler 70.0 (2.) 71.4 (1.) 84.5 (6.)
 Trefferlage 0.08 mm links, 0.59 mm tief
 Streuwert 1.23, horizontal: 1.43, vertikal: 1.00

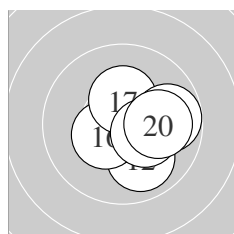

Serie 2:
 10.7 * 10.0 ↘ 10.5 * 10.8 * 10.7 *
 10.4 * 10.3 * 10.3 * 9.8 → 10.0 →
 beste Teiler 41.8 (14.) 61.4 (15.) 64.3 (11.)
 Trefferlage 0.75 mm rechts, 0.22 mm tief
 Streuwert 1.13, horizontal: 1.28, vertikal: 0.96

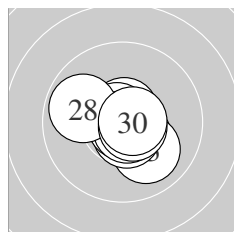

Serie 3:
 10.7 * 10.4 * 10.0 ↘ 10.6 * 10.8 *
 10.9 * 10.7 * 9.9 ↖ 10.7 * 10.7 *
 beste Teiler 20.6 (26.) 50.2 (25.) 53.2 (27.)
 Trefferlage 0.14 mm rechts, 0.25 mm tief
 Streuwert 0.97, horizontal: 1.10, vertikal: 0.80

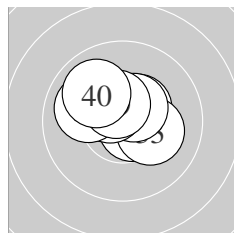

Serie 4:
 10.6 * 10.4 * 10.2 * 10.3 * 10.5 *
 10.2 * 10.5 * 10.0 ↖ 10.5 * 10.0 ↘
 beste Teiler 76.3 (31.) 114.3 (35.) 114.5 (37.)
 Trefferlage 0.40 mm links, 0.71 mm hoch
 Streuwert 1.10, horizontal: 1.38, vertikal: 0.71

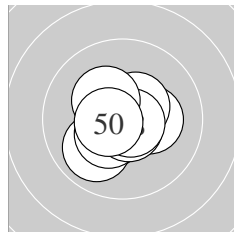

Serie 5:
 10.5 * 10.6 * 10.3 * 9.9 ↙ 10.5 *
 10.4 * 10.7 * 10.7 * 10.3 * 10.6 *
 beste Teiler 58.6 (48.) 67.4 (47.) 94.1 (50.)
 Trefferlage 0.09 mm links, 0.24 mm tief
 Streuwert 1.02, horizontal: 1.12, vertikal: 0.90

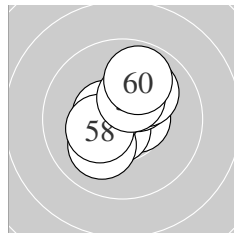

Serie 6:
 10.7 * 10.6 * 10.6 * 10.3 * 10.1 ↗
 10.1 ↙ 10.5 * 10.3 * 10.4 * 9.9 ↑
 beste Teiler 61.0 (51.) 79.7 (53.) 90.0 (52.)
 Trefferlage 0.02 mm rechts, 0.49 mm hoch
 Streuwert 1.19, horizontal: 1.08, vertikal: 1.29

Meyton Elektronik

ISSF AR Women Jun – Wertung – Juniorinnen

StandNr: 109

Henry, Angeline #76

StartNr: 56

21. Januar 2018 11:48

USA

Unterschrift des Schützen

Meyton Elektronik

Ergebnis: **619.4** (594)
 Serien: 102.9 102.2 103.3 102.4 105.3 103.3
 Zähler: 54 6 0 0 0 0 0 0 0
 Innenzehner: 46
 weiteste: 294 (28), 284 (35), 276 (9)
 beste Teiler 43.4 (49.) 50.5 (56.) 59.0 (44.)
 Trefferlage 0.21 mm links, 0.35 mm hoch
 Streuwert 1.17, horizontal: 1.12, vertikal: 1.23

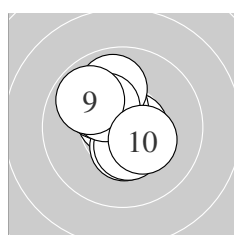
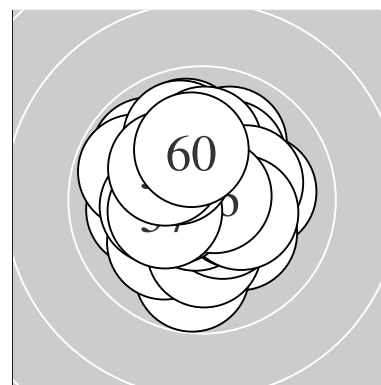

Serie 1:
 10.6 * 10.7 * 10.4 * 10.4 * 10.4 *
 10.1 ↘ 9.9 ↗ 10.3 * 9.8 ↘ 10.3 *
 beste Teiler 71.0 (2.) 85.7 (1.) 126.3 (3.)
 Trefferlage 0.41 mm links, 0.54 mm hoch
 Streuwert 1.19, horizontal: 1.05, vertikal: 1.32

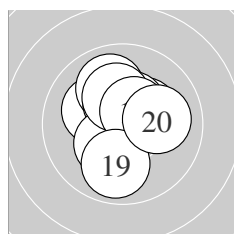

Serie 2:
 10.2 * 10.0 ↗ 10.4 * 10.3 * 10.3 *
 10.4 * 10.2 * 10.5 * 9.9 ↓ 10.0 →
 beste Teiler 114.1 (18.) 133.7 (16.) 141.4 (13.)
 Trefferlage 0.02 mm rechts, 0.57 mm hoch
 Streuwert 1.34, horizontal: 1.20, vertikal: 1.46

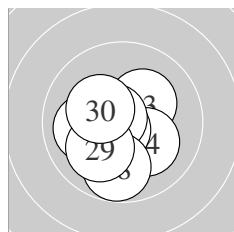

Serie 3:
 10.6 * 10.7 * 10.2 * 10.2 * 10.0 ←
 10.7 * 10.7 * 9.8 ↓ 10.1 ↗ 10.3 *
 beste Teiler 63.8 (26.) 64.6 (22.) 69.4 (27.)
 Trefferlage 0.52 mm links, 0.52 mm tief
 Streuwert 1.20, horizontal: 1.18, vertikal: 1.22

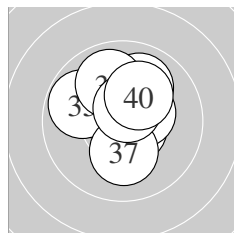

Serie 4:
 10.2 * 10.0 ↗ 10.6 * 10.5 * 9.8 ↘
 10.4 * 10.2 * 9.9 ↗ 10.6 * 10.2 *
 beste Teiler 81.6 (33.) 90.4 (39.) 115.4 (34.)
 Trefferlage 0.05 mm rechts, 0.79 mm hoch
 Streuwert 1.29, horizontal: 1.29, vertikal: 1.29

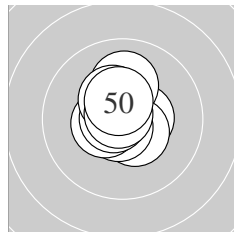

Serie 5:
 10.5 * 10.1 ↑ 10.5 * 10.7 * 10.6 *
 10.5 * 10.7 * 10.4 * 10.8 * 10.5 *
 beste Teiler 43.4 (49.) 59.0 (44.) 59.1 (47.)
 Trefferlage 0.18 mm links, 0.37 mm hoch
 Streuwert 0.82, horizontal: 0.70, vertikal: 0.93

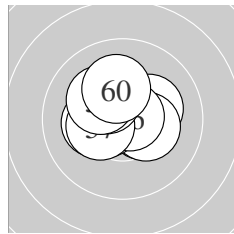

Serie 6:
 10.2 * 10.4 * 10.3 * 10.2 * 10.5 *
 10.8 * 10.3 * 10.3 * 10.2 * 10.1 ↑
 beste Teiler 50.5 (56.) 104.7 (55.) 136.6 (52.)
 Trefferlage 0.21 mm links, 0.34 mm hoch
 Streuwert 1.14, horizontal: 1.35, vertikal: 0.89

Meyton Elektronik

ISSF AR Women Jun – Wertung – Juniorinnen

StandNr: 111

Zaisberger, Verena #99

StartNr: 58

21. Januar 2018 11:45

AUT

Unterschrift des Schützen

Meyton Elektronik

Ergebnis: **616.6** (589)
 Serien: 102.9 102.5 104.1 101.9 101.7 103.5
 Zähler: 50 9 1 0 0 0 0 0 0
 Innenzehner: 39
 weiteste: 519 (44), 329 (34), 313 (1)
 beste Teiler 11.1 (53.) 13.0 (28.) 41.4 (57.)
 Trefferlage 0.06 mm links, 0.16 mm hoch
 Streuwert 1.36, horizontal: 1.34, vertikal: 1.37

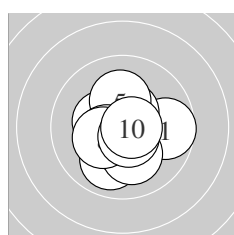
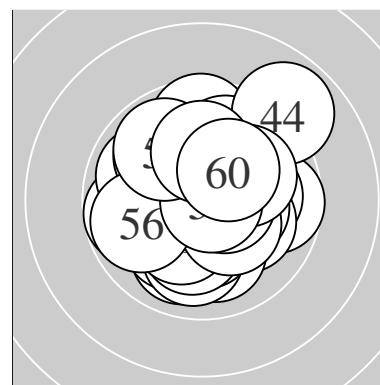

Serie 1:
 9.7 → 10.0 ↘ 10.4 * 10.5 * 10.2 *
 10.4 * 10.1 ↘ 10.3 * 10.6 * 10.7 *
 beste Teiler 65.0 (10.) 80.9 (9.) 115.5 (4.)
 Trefferlage 0.02 mm rechts, 0.30 mm tief
 Streuwert 1.34, horizontal: 1.39, vertikal: 1.28

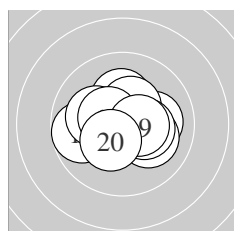

Serie 2:
 10.2 * 10.1 → 10.4 * 10.1 ↘ 9.8 ←
 10.2 * 10.5 * 10.3 * 10.5 * 10.4 *
 beste Teiler 114.0 (17.) 117.4 (19.) 138.2 (13.)
 Trefferlage 0.05 mm rechts, 0.11 mm hoch
 Streuwert 1.39, horizontal: 1.72, vertikal: 0.95

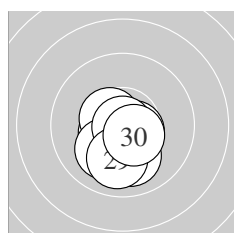

Serie 3:
 10.5 * 10.6 * 10.4 * 10.5 * 10.6 *
 10.0 ↘ 10.1 ↙ 10.9 * 10.0 ↘ 10.5 *
 beste Teiler 13.0 (28.) 85.4 (22.) 91.7 (25.)
 Trefferlage 0.21 mm links, 0.94 mm tief
 Streuwert 0.86, horizontal: 0.77, vertikal: 0.94

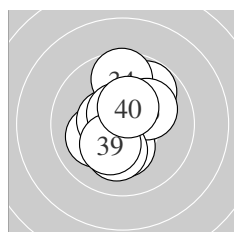

Serie 4:
 9.8 ↗ 10.1 ← 10.5 * 9.6 ↑ 10.3 *
 10.1 ↗ 10.2 * 10.6 * 10.3 * 10.4 *
 beste Teiler 86.3 (38.) 114.9 (33.) 130.2 (40.)
 Trefferlage 0.08 mm links, 0.31 mm hoch
 Streuwert 1.50, horizontal: 1.17, vertikal: 1.77

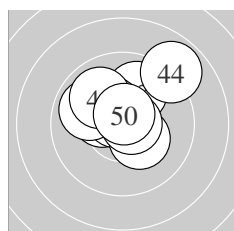

Serie 5:
 10.3 * 10.7 * 9.9 ↗ 8.9 ↗ 10.3 *
 10.7 * 10.4 * 9.9 ↘ 9.9 ↘ 10.7 *
 beste Teiler 64.0 (46.) 69.3 (42.) 72.8 (50.)
 Trefferlage 0.02 mm links, 1.10 mm hoch
 Streuwert 1.55, horizontal: 1.74, vertikal: 1.33

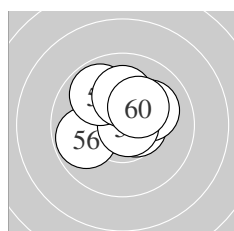

Serie 6:
 10.6 * 10.1 ↗ 10.9 * 10.5 * 10.5 *
 9.8 ← 10.8 * 9.9 ↘ 10.1 ↑ 10.3 *
 beste Teiler 11.1 (53.) 41.4 (57.) 98.4 (51.)
 Trefferlage 0.14 mm links, 0.70 mm hoch
 Streuwert 1.21, horizontal: 1.37, vertikal: 1.02

Meyton Elektronik

ISSF AR Women Jun – Wertung – Juniorinnen

StartNr: 59

StandNr: 112

21. Januar 2018 11:32

Suremann, Lisa #102

SUI

Unterschrift des Schützen

Meyton Elektronik

Ergebnis:	592.1	(566)						
Serien:	98.1	99.4	102.6	95.7	96.3	100.0		
Zähler:	32	22	6	0	0	0	0	0
Innenzehner:	21							
weiteste:	641 (31), 534 (37), 529 (42)							
beste Teiler	37.2 (25.) 63.6 (8.) 76.5 (29.)							
Trefferlage	0.28 mm links, 0.08 mm tief							
Streuwert	2.14, horizontal: 2.34, vertikal: 1.92							

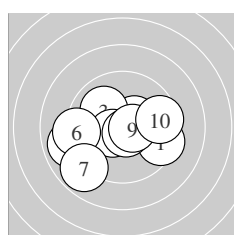
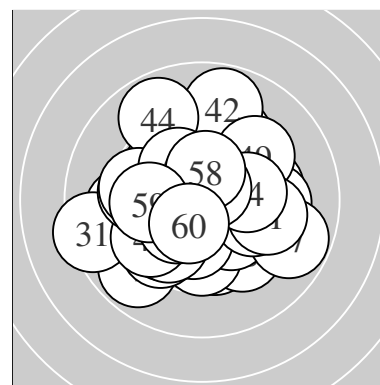

Serie 1:	9.4 →	10.4 *	10.0 ↖	8.9 ←	10.5 *
	9.2 ←	8.9 ↙	10.7 *	10.6 *	9.5 →
beste Teiler	63.6 (8.) 93.5 (9.) 109.9 (5.)				
Trefferlage	0.60 mm links, 0.53 mm tief				
Streuwert	2.39, horizontal: 3.03, vertikal: 1.50				

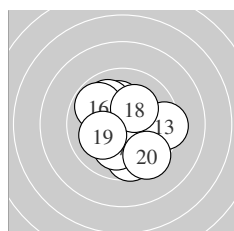

Serie 2:	10.2 *	10.4 *	9.4 →	9.7 ↓	10.0 ↖
	9.8 ↖	10.1 ↓	10.2 *	10.1 ←	9.5 ↘
beste Teiler	150.6 (12.) 184.2 (18.) 186.9 (11.)				
Trefferlage	0.28 mm rechts, 0.32 mm tief				
Streuwert	1.96, horizontal: 1.95, vertikal: 1.98				

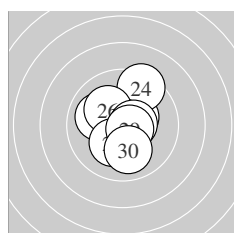

Serie 3:	10.5 *	10.0 ↖	10.4 *	9.4 ↑	10.8 *
	10.2 *	10.5 *	10.2 *	10.6 *	10.0 ↓
beste Teiler	37.2 (25.) 76.5 (29.) 101.4 (27.)				
Trefferlage	0.11 mm rechts, 0.34 mm hoch				
Streuwert	1.45, horizontal: 1.26, vertikal: 1.61				

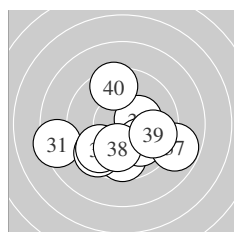

Serie 4:	8.4 ←	9.7 ↓	9.5 ↙	10.3 *	10.0 ↘
	9.7 ↙	8.8 ↘	10.0 ↓	9.8 →	9.5 ↑
beste Teiler	152.4 (34.) 226.3 (38.) 236.9 (35.)				
Trefferlage	0.11 mm links, 1.30 mm tief				
Streuwert	2.59, horizontal: 3.09, vertikal: 1.98				

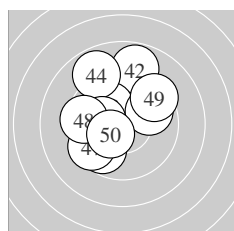

Serie 5:	9.7 ↙	8.8 ↑	10.1 ↖	8.9 ↖	10.2 *
	9.8 →	9.5 ↙	9.5 ←	9.4 →	10.4 *
beste Teiler	146.9 (50.) 195.8 (45.) 209.2 (43.)				
Trefferlage	0.85 mm links, 1.05 mm hoch				
Streuwert	2.42, horizontal: 2.28, vertikal: 2.56				

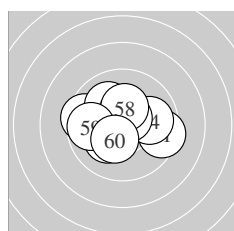

Serie 6:	9.4 →	10.0 ↖	9.5 ←	9.9 →	10.0 ↖
	10.6 *	10.2 *	10.3 *	9.8 ←	10.3 *
beste Teiler	83.8 (56.) 152.2 (60.) 165.0 (58.)				
Trefferlage	0.54 mm links, 0.22 mm hoch				
Streuwert	1.83, horizontal: 2.33, vertikal: 1.12				

Meyton Elektronik

ISSF AR Women Jun – Wertung – Juniorinnen

StandNr: 113

Ceric, Angelina #66

StartNr: 60

21. Januar 2018 11:31

VSBL NWLZ

Unterschrift des Schützen

Meyton Elektronik

Ergebnis: **623.8** (598)
 Serien: 104.3 104.7 103.0 103.7 104.5 103.6
 Zähler: 58 2 0 0 0 0 0 0 0
 Innenzehner: 52
 weiteste: 298 (29), 294 (24), 244 (27)
 beste Teiler 3.0 (20.) 6.4 (25.) 37.1 (37.)
 Trefferlage 0.05 mm links, 0.09 mm tief
 Streuwert 1.08, horizontal: 1.21, vertikal: 0.93

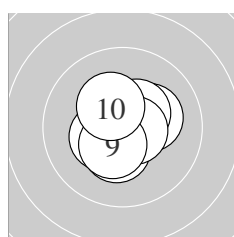
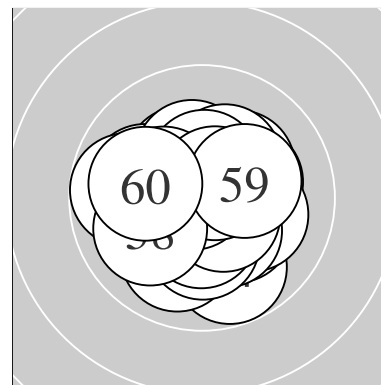

Serie 1:
 10.7 * 10.5 * 10.4 * 10.4 * 10.3 *
 10.2 * 10.4 * 10.7 * 10.4 * 10.3 *
 beste Teiler 65.2 (1.) 75.9 (8.) 118.8 (2.)
 Trefferlage 0.03 mm rechts, 0.02 mm tief
 Streuwert 1.01, horizontal: 1.07, vertikal: 0.95

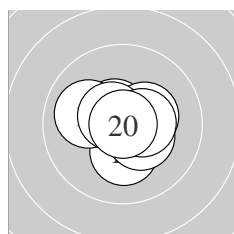

Serie 2:
 10.6 * 10.6 * 10.7 * 10.2 * 10.3 *
 10.0 ← 10.6 * 10.4 * 10.4 * 10.9 *
 beste Teiler 3.0 (20.) 55.2 (13.) 82.2 (11.)
 Trefferlage 0.02 mm rechts, 0.00 mm
 Streuwert 0.98, horizontal: 1.13, vertikal: 0.80

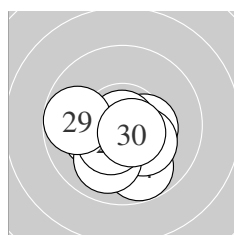

Serie 3:
 10.6 * 10.4 * 10.2 * 9.8 ↘ 10.9 *
 10.3 * 10.0 ↙ 10.4 * 9.8 ← 10.6 *
 beste Teiler 6.4 (25.) 76.0 (21.) 77.3 (30.)
 Trefferlage 0.26 mm links, 0.84 mm tief
 Streuwert 1.22, horizontal: 1.43, vertikal: 0.97

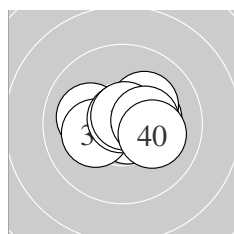

Serie 4:
 10.3 * 10.2 * 10.2 * 10.7 * 10.1 ←
 10.2 * 10.8 * 10.7 * 10.4 * 10.1 →
 beste Teiler 37.1 (37.) 51.6 (34.) 56.0 (38.)
 Trefferlage 0.12 mm rechts, 0.13 mm hoch
 Streuwert 1.17, horizontal: 1.55, vertikal: 0.59

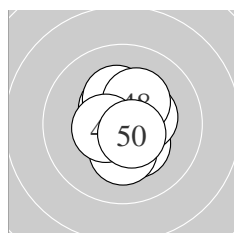

Serie 5:
 10.3 * 10.2 * 10.4 * 10.8 * 10.5 *
 10.6 * 10.3 * 10.3 * 10.5 * 10.6 *
 beste Teiler 44.1 (44.) 88.0 (46.) 88.4 (50.)
 Trefferlage 0.20 mm rechts, 0.16 mm hoch
 Streuwert 0.98, horizontal: 0.78, vertikal: 1.15

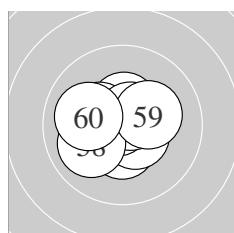

Serie 6:
 10.4 * 10.3 * 10.5 * 10.5 * 10.8 *
 10.3 * 10.6 * 10.0 ← 10.2 * 10.0 ←
 beste Teiler 42.0 (55.) 77.2 (57.) 107.4 (54.)
 Trefferlage 0.45 mm links, 0.00 mm
 Streuwert 1.12, horizontal: 1.31, vertikal: 0.88

Meyton Elektronik

ISSF AR Women Jun – Wertung – Juniorinnen

StandNr: 114

Waibel, Sheileen #104

StartNr: 61

21. Januar 2018 11:31

AUT

Unterschrift des Schützen

Meyton Elektronik

Ergebnis: **612.7** (588)

Serien: 102.4 103.4 100.1 102.1 102.5 102.2

Zähler: 48 12 0 0 0 0 0 0 0 0

Innenzehner: 39

weiteste: 497 (25), 459 (39), 420 (22)

beste Teiler 31.2 (24.) 45.0 (41.) 48.5 (10.)

Trefferlage 0.18 mm links, 0.40 mm hoch

Streuwert 1.48, horizontal: 1.35, vertikal: 1.59

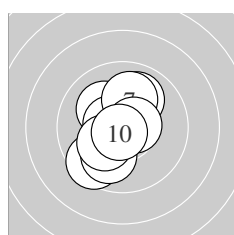
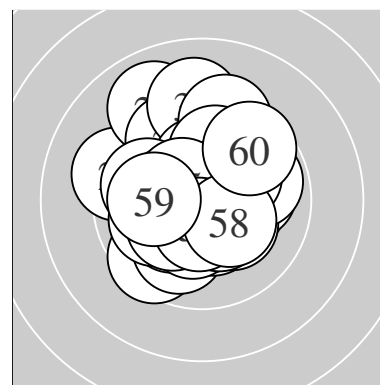

Serie 1:

9.5 ↙	10.0 ↗	10.1 ↘	9.9 ↙	10.6 *
10.7 *	10.0 ↑	10.6 *	10.2 *	10.8 *

beste Teiler 48.5 (10.) 56.3 (6.) 91.4 (8.)

Trefferlage 0.44 mm links, 0.00 mm

Streuwert 1.46, horizontal: 1.16, vertikal: 1.71

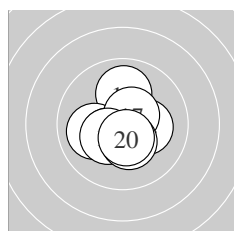

Serie 2:

10.5 *	10.0 ↑	10.6 *	10.2 *	10.0 ←
10.4 *	10.5 *	10.3 *	10.4 *	10.5 *

beste Teiler 97.6 (13.) 101.1 (17.) 106.1 (11.)

Trefferlage 0.19 mm links, 0.35 mm tief

Streuwert 1.15, horizontal: 1.17, vertikal: 1.14

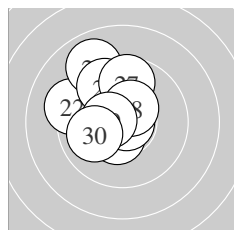

Serie 3:

10.2 *	9.3 ←	10.5 *	10.8 *	9.0 ↘
9.7 ↘	9.7 ↑	10.4 *	10.5 *	10.0 ←

beste Teiler 31.2 (24.) 111.0 (29.) 122.7 (23.)

Trefferlage 1.19 mm links, 1.01 mm hoch

Streuwert 1.70, horizontal: 1.46, vertikal: 1.91

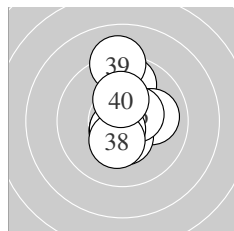

Serie 4:

9.8 ↑	10.0 →	10.5 *	10.4 *	10.6 *
10.5 *	10.6 *	10.3 *	9.1 ↑	10.3 *

beste Teiler 76.8 (37.) 89.5 (35.) 101.4 (33.)

Trefferlage 0.30 mm rechts, 0.65 mm hoch

Streuwert 1.51, horizontal: 0.89, vertikal: 1.94

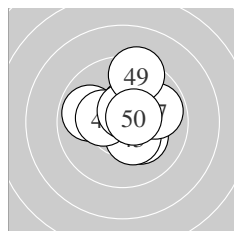

Serie 5:

10.8 *	10.2 *	10.4 *	10.4 *	9.9 ←
10.3 *	9.9 →	10.6 *	9.4 ↑	10.6 *

beste Teiler 45.0 (41.) 91.4 (48.) 97.5 (50.)

Trefferlage 0.34 mm rechts, 0.63 mm hoch

Streuwert 1.43, horizontal: 1.48, vertikal: 1.37

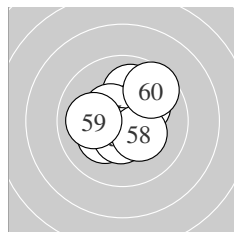

Serie 6:

10.4 *	10.0 ↑	10.2 *	10.5 *	10.5 *
10.2 *	10.5 *	10.3 *	10.0 ←	9.6 ↗

beste Teiler 106.9 (54.) 118.8 (57.) 120.6 (55.)

Trefferlage 0.09 mm rechts, 0.50 mm hoch

Streuwert 1.41, horizontal: 1.48, vertikal: 1.33

Meyton Elektronik

ISSF AR Women Jun – Wertung – Juniorinnen

StandNr: 115

Kaps, Jessie #80

StartNr: 62

21. Januar 2018 11:38

BEL

Unterschrift des Schützen

Meyton Elektronik

Ergebnis:	601.6	(576)
Serien:	98.7	100.0 99.3 103.1 98.8 101.7
Zähler:	37 22 1 0 0 0 0 0 0	
Innenzehner:	26	
weiteste:	595 (50), 455 (22), 437 (4)	
beste Teiler	23.1 (33.) 34.1 (6.) 37.6 (60.)	
Trefferlage	0.00 mm , 0.50 mm hoch	
Streuwert	1.84, horizontal: 2.17, vertikal: 1.44	

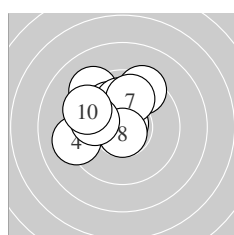
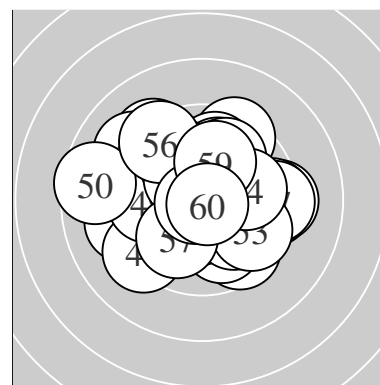

Serie 1:	9.3 ↘	9.4 ↗	10.0 ↘	9.2 ←	10.0 ↑
	10.8 *	9.9 ↑	10.7 *	9.9 ←	9.5 ↘
beste Teiler	34.1 (6.)	51.0 (8.)	229.8 (5.)		
Trefferlage	1.16 mm links, 1.42 mm hoch				
Streuwert	1.76, horizontal: 1.93, vertikal: 1.58				

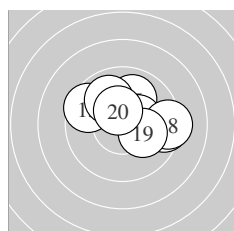

Serie 2:	10.4 *	10.4 *	9.6 ↘	9.4 →	10.0 ↑
	9.9 ↘	10.4 *	9.3 →	10.2 *	10.4 *
beste Teiler	131.8 (20.)	134.0 (12.)	144.2 (17.)		
Trefferlage	0.86 mm rechts, 0.89 mm hoch				
Streuwert	1.71, horizontal: 2.18, vertikal: 1.04				

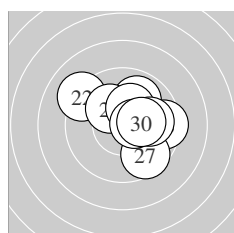

Serie 3:	9.9 ↗	9.1 ↘	10.2 *	10.3 *	10.0 →
	9.4 →	9.6 ↘	10.5 *	10.0 →	10.3 *
beste Teiler	107.6 (28.)	171.8 (24.)	173.4 (30.)		
Trefferlage	1.05 mm rechts, 0.57 mm hoch				
Streuwert	1.84, horizontal: 2.12, vertikal: 1.52				

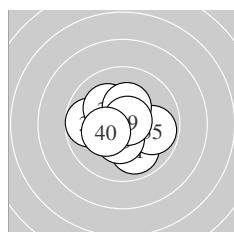

Serie 4:	9.9 ↘	10.7 *	10.9 *	9.8 ←	9.9 →
	10.4 *	10.2 *	10.3 *	10.7 *	10.3 *
beste Teiler	23.1 (33.)	54.0 (39.)	59.5 (32.)		
Trefferlage	0.07 mm links, 0.18 mm tief				
Streuwert	1.39, horizontal: 1.57, vertikal: 1.17				

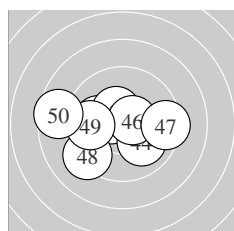

Serie 5:	10.1 ←	10.5 *	10.2 *	10.0 ↘	10.4 *
	10.6 *	9.4 →	9.2 ↗	9.8 ←	8.6 ←
beste Teiler	96.5 (46.)	110.6 (42.)	132.8 (45.)		
Trefferlage	0.75 mm links, 0.17 mm tief				
Streuwert	2.24, horizontal: 2.92, vertikal: 1.21				

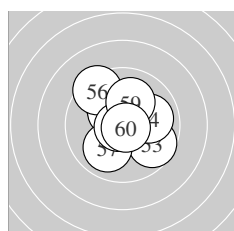

Serie 6:	10.1 ↘	10.5 *	9.7 ↘	10.0 →	10.3 *
	9.4 ↘	10.0 ↗	10.8 *	10.1 ↑	10.8 *
beste Teiler	37.6 (60.)	39.8 (58.)	103.5 (52.)		
Trefferlage	0.10 mm rechts, 0.50 mm hoch				
Streuwert	1.64, horizontal: 1.64, vertikal: 1.64				

Meyton Elektronik

ISSF AR Women Jun – Wertung – Juniorinnen

StandNr: 116

Grieser, Verena #61

StartNr: 63

21. Januar 2018 11:24

BY – Schwaben

Unterschrift des Schützen

Meyton Elektronik

Ergebnis: **623.8** (594)
 Serien: 104.3 105.6 101.7 104.7 102.7 104.8
 Zähler: 54 6 0 0 0 0 0 0 0
 Innenzehner: 50
 weiteste: 380 (10), 360 (28), 287 (46)
 beste Teiler 17.0 (20.) 42.4 (55.) 43.5 (5.)
 Trefferlage 0.04 mm links, 0.02 mm tief
 Streuwert 1.14, horizontal: 1.22, vertikal: 1.06

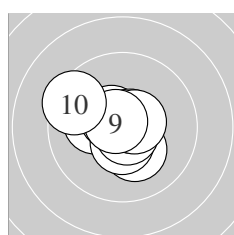
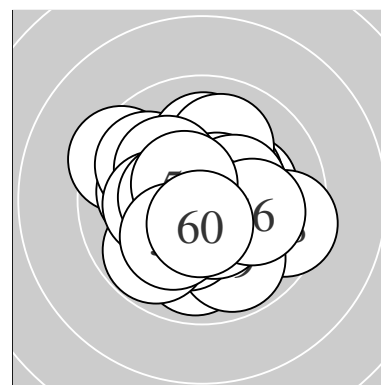

Serie 1:
 10.2 * 10.2 * 10.5 * 10.5 * 10.8 *
 10.7 * 10.7 * 10.6 * 10.7 * 9.4 ↖
 beste Teiler 43.5 (5.) 51.4 (6.) 63.2 (9.)
 Trefferlage 0.38 mm links, 0.12 mm hoch
 Streuwert 1.16, horizontal: 1.35, vertikal: 0.93

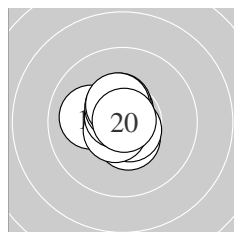

Serie 2:
 10.6 * 10.1 ← 10.5 * 10.5 * 10.7 *
 10.6 * 10.7 * 10.5 * 10.5 * 10.9 *
 beste Teiler 17.0 (20.) 60.8 (17.) 72.9 (15.)
 Trefferlage 0.32 mm links, 0.29 mm hoch
 Streuwert 0.78, horizontal: 0.75, vertikal: 0.82

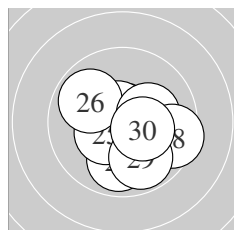

Serie 3:
 10.7 * 10.2 * 9.9 ↓ 10.7 * 10.4 *
 9.9 ↖ 10.2 * 9.5 → 9.8 ↘ 10.4 *
 beste Teiler 51.4 (21.) 73.3 (24.) 137.5 (25.)
 Trefferlage 0.55 mm rechts, 0.49 mm tief
 Streuwert 1.51, horizontal: 1.67, vertikal: 1.33

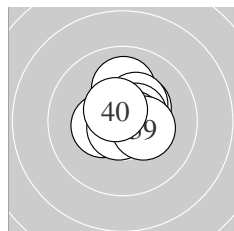

Serie 4:
 10.0 ↑ 10.4 * 10.4 * 10.6 * 10.4 *
 10.6 * 10.7 * 10.7 * 10.3 * 10.6 *
 beste Teiler 55.9 (38.) 65.7 (37.) 94.3 (40.)
 Trefferlage 0.38 mm rechts, 0.47 mm hoch
 Streuwert 0.88, horizontal: 0.88, vertikal: 0.88

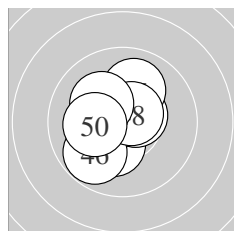

Serie 5:
 10.2 * 10.3 * 10.3 * 10.6 * 10.5 *
 9.8 ↙ 10.0 ↑ 10.6 * 10.2 * 10.2 *
 beste Teiler 85.5 (48.) 98.7 (44.) 103.3 (45.)
 Trefferlage 0.57 mm links, 0.08 mm tief
 Streuwert 1.30, horizontal: 1.24, vertikal: 1.37

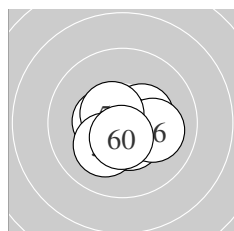

Serie 6:
 10.4 * 10.5 * 10.8 * 10.5 * 10.8 *
 10.1 → 10.4 * 10.6 * 10.2 * 10.5 *
 beste Teiler 42.4 (55.) 43.9 (53.) 99.9 (58.)
 Trefferlage 0.07 mm rechts, 0.44 mm tief
 Streuwert 0.92, horizontal: 1.08, vertikal: 0.73

Meyton Elektronik

ISSF AR Women Jun – Wertung – Juniorinnen

StandNr: 117

Ivanova, Maria #79

StartNr: 64

21. Januar 2018 11:37

RUS

Unterschrift des Schützen

Meyton Elektronik

Ergebnis: **611.5** (583)

Serien: 103.5 103.0 103.5 103.7 101.5 96.3

Zähler: 43 17 0 0 0 0 0 0 0 0

Innenzehner: 39

weiteste: 499 (45), 495 (53), 437 (58)

beste Teiler 28.6 (8.) 34.9 (44.) 38.2 (41.)

Trefferlage 0.18 mm links, 0.01 mm tief

Streuwert 1.57, horizontal: 1.76, vertikal: 1.35

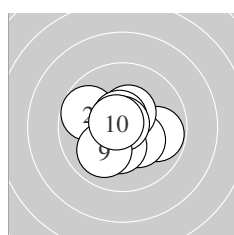
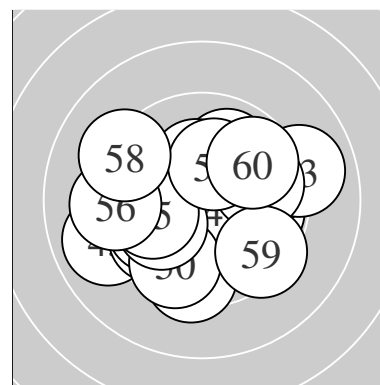

Serie 1:

9.8 →	9.8 ↖	10.3 *	10.4 *	10.8 *
10.3 *	10.6 *	10.8 *	10.0 ↙	10.7 *

beste Teiler 28.6 (8.) 49.7 (5.) 65.0 (10.)

Trefferlage 0.13 mm links, 0.15 mm tief

Streuwert 1.30, horizontal: 1.48, vertikal: 1.09

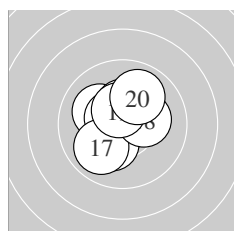

Serie 2:

10.7 *	10.6 *	10.1 ↖	10.2 *	10.4 *
10.5 *	9.9 ↙	10.2 *	10.5 *	9.9 ↗

beste Teiler 62.9 (11.) 99.4 (12.) 101.2 (16.)

Trefferlage 0.33 mm links, 0.38 mm hoch

Streuwert 1.23, horizontal: 1.14, vertikal: 1.30

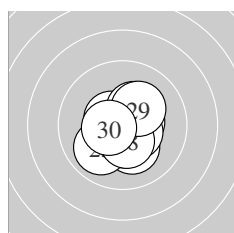

Serie 3:

10.2 *	10.5 *	10.5 *	10.5 *	9.9 ↙
10.3 *	10.5 *	10.4 *	10.2 *	10.5 *

beste Teiler 105.6 (24.) 113.1 (30.) 118.1 (27.)

Trefferlage 0.18 mm rechts, 0.34 mm tief

Streuwert 1.13, horizontal: 1.08, vertikal: 1.18

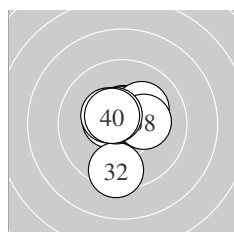

Serie 4:

10.5 *	9.4 ↓	10.4 *	10.6 *	10.6 *
10.6 *	10.2 *	10.3 *	10.6 *	10.5 *

beste Teiler 80.0 (36.) 82.9 (35.) 90.1 (34.)

Trefferlage 0.14 mm links, 0.24 mm hoch

Streuwert 1.24, horizontal: 1.02, vertikal: 1.43

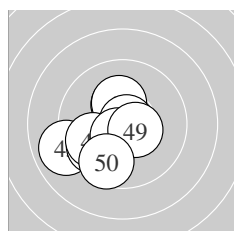

Serie 5:

10.8 *	10.3 *	10.3 *	10.8 *	9.0 ↙
9.8 ↙	9.9 ↙	10.5 *	10.5 *	9.6 ↙

beste Teiler 34.9 (44.) 38.2 (41.) 101.2 (48.)

Trefferlage 1.06 mm links, 0.63 mm tief

Streuwert 1.58, horizontal: 1.65, vertikal: 1.51

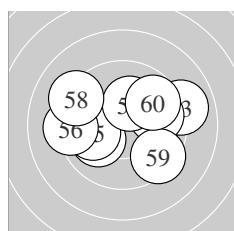

Serie 6:

10.0 ↙	9.7 →	9.0 →	9.8 →	10.0 ↙
9.3 ←	10.2 *	9.2 ↖	9.4 ↘	9.7 ↗

beste Teiler 183.4 (57.) 229.9 (51.) 249.0 (55.)

Trefferlage 0.40 mm rechts, 0.42 mm hoch

Streuwert 2.53, horizontal: 3.24, vertikal: 1.53

ISSF AR Women Jun – Wertung – Juniorinnen

StandNr: 119

Ng, Cecilia #109

StartNr: 66

21. Januar 2018 11:18

SGP

Unterschrift des Schützen

Meyton Elektronik

Ergebnis: **619.1** (590)
 Serien: 103.2 102.2 103.7 101.4 105.6 103.0
 Zähler: 51 8 1 0 0 0 0 0 0
 Innenzehner: 45
 weiteste: 548 (60), 460 (38), 427 (1)
 beste Teiler 33.5 (47.) 38.8 (26.) 45.0 (48.)
 Trefferlage 0.36 mm links, 0.11 mm hoch
 Streuwert 1.33, horizontal: 1.59, vertikal: 1.00

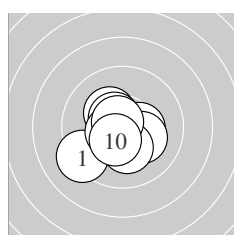
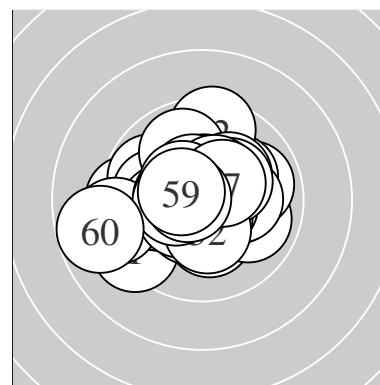

Serie 1:
 9.2 ↙ 10.4 * 10.2 * 10.3 * 10.5 *
 10.7 * 10.5 * 10.2 * 10.7 * 10.5 *
 beste Teiler 63.6 (9.) 72.8 (6.) 104.7 (5.)
 Trefferlage 0.43 mm links, 0.48 mm tief
 Streuwert 1.29, horizontal: 1.43, vertikal: 1.14

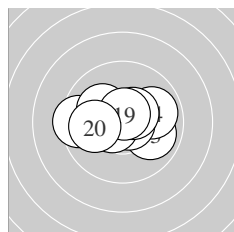

Serie 2:
 9.4 ← 10.4 * 9.9 ↘ 9.9 → 10.1 ↘
 10.7 * 10.6 * 10.5 * 10.7 * 10.0 ←
 beste Teiler 56.3 (16.) 71.3 (19.) 96.2 (17.)
 Trefferlage 0.09 mm links, 0.15 mm hoch
 Streuwert 1.54, horizontal: 2.08, vertikal: 0.65

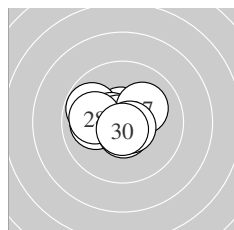

Serie 3:
 10.0 ← 10.6 * 10.6 * 9.8 ↖ 10.5 *
 10.8 * 10.1 ↗ 10.0 ← 10.6 * 10.7 *
 beste Teiler 38.8 (26.) 62.0 (30.) 76.0 (29.)
 Trefferlage 0.64 mm links, 0.18 mm hoch
 Streuwert 1.12, horizontal: 1.42, vertikal: 0.71

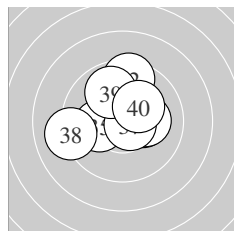

Serie 4:
 10.3 * 9.5 ↑ 10.7 * 10.7 * 10.1 ←
 10.2 * 10.7 * 9.1 ← 9.9 ↗ 10.2 *
 beste Teiler 63.5 (34.) 65.7 (33.) 71.1 (37.)
 Trefferlage 0.14 mm links, 0.64 mm hoch
 Streuwert 1.72, horizontal: 1.96, vertikal: 1.43

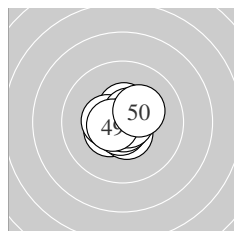

Serie 5:
 10.5 * 10.4 * 10.4 * 10.5 * 10.6 *
 10.7 * 10.8 * 10.8 * 10.6 * 10.3 *
 beste Teiler 33.5 (47.) 45.0 (48.) 64.5 (46.)
 Trefferlage 0.05 mm links, 0.00 mm
 Streuwert 0.78, horizontal: 0.84, vertikal: 0.73

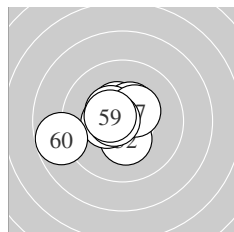

Serie 6:
 10.5 * 10.3 * 10.6 * 10.4 * 10.4 *
 10.4 * 10.4 * 10.7 * 10.5 * 8.8 ←
 beste Teiler 74.3 (58.) 78.2 (53.) 114.9 (59.)
 Trefferlage 0.84 mm links, 0.18 mm hoch
 Streuwert 1.42, horizontal: 1.74, vertikal: 0.99

Meyton Elektronik

ISSF AR Women Jun – Wertung – Juniorinnen

StandNr: 120

Hafner, Lisa #74

StartNr: 67

21. Januar 2018 11:41

T – SG Umhausen

Unterschrift des Schützen

Meyton Elektronik

Ergebnis:	619.3	(593)						
Serien:	102.4	102.9	104.4	102.6	103.9	103.1		
Zähler:	53	7	0	0	0	0	0	0
Innenzehner:	44							
weiteste:	452 (20), 295 (40), 281 (8)							
beste Teiler	42.9 (37.) 48.5 (21.) 59.4 (49.)							
Trefferlage	0.05 mm links, 0.25 mm hoch							
Streuwert	1.23, horizontal: 1.35, vertikal: 1.10							

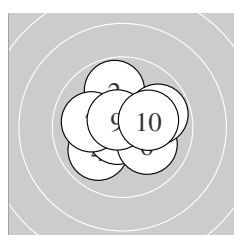
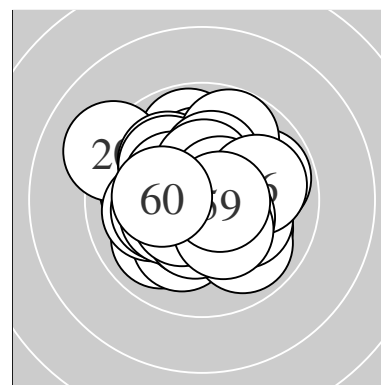

Serie 1:					
	10.5 *	9.8 ↑	10.7 *	9.9 ✓	10.7 *
	10.1 ↘	10.0 ←	9.8 →	10.7 *	10.2 *
beste Teiler	59.6 (3.) 65.8 (5.) 67.2 (9.)				
Trefferlage	0.09 mm rechts, 0.27 mm hoch				
Streuwert	1.46, horizontal: 1.64, vertikal: 1.26				

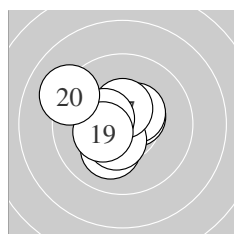

Serie 2:					
	10.6 *	10.6 *	10.5 *	10.1 ✓	10.4 *
	10.4 *	10.5 *	10.4 *	10.3 *	9.1 ↘
beste Teiler	87.1 (12.) 91.5 (11.) 112.5 (13.)				
Trefferlage	0.76 mm links, 0.09 mm hoch				
Streuwert	1.31, horizontal: 1.41, vertikal: 1.20				

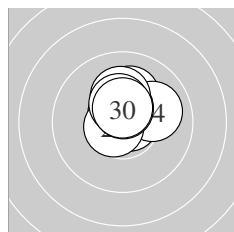

Serie 3:					
	10.8 *	10.6 *	10.1 ↑	10.0 →	10.5 *
	10.7 *	10.6 *	10.2 *	10.4 *	10.5 *
beste Teiler	48.5 (21.) 74.7 (26.) 77.8 (22.)				
Trefferlage	0.18 mm rechts, 0.96 mm hoch				
Streuwert	0.76, horizontal: 0.80, vertikal: 0.72				

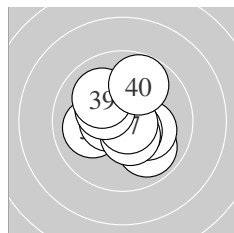

Serie 4:					
	9.9 ↘	10.2 *	10.5 *	10.0 ←	10.6 *
	10.5 *	10.8 *	10.3 *	10.0 ↘	9.8 ↑
beste Teiler	42.9 (37.) 100.0 (35.) 104.0 (33.)				
Trefferlage	0.04 mm rechts, 0.01 mm hoch				
Streuwert	1.42, horizontal: 1.45, vertikal: 1.38				

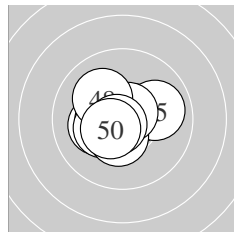

Serie 5:					
	10.6 *	10.2 *	10.4 *	10.3 *	10.0 →
	10.4 *	10.7 *	10.1 ↘	10.7 *	10.5 *
beste Teiler	59.4 (49.) 62.6 (47.) 96.7 (41.)				
Trefferlage	0.40 mm links, 0.04 mm tief				
Streuwert	1.10, horizontal: 1.32, vertikal: 0.82				

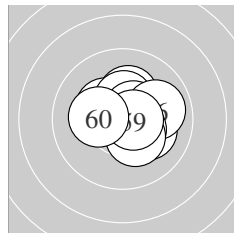

Serie 6:					
	10.2 *	10.3 *	10.4 *	10.2 *	10.6 *
	9.9 →	10.4 *	10.3 *	10.6 *	10.2 *
beste Teiler	80.3 (59.) 100.0 (55.) 129.0 (57.)				
Trefferlage	0.52 mm rechts, 0.23 mm hoch				
Streuwert	1.15, horizontal: 1.28, vertikal: 0.99				

Meyton Elektronik

ISSF AR Women Jun – Wertung – Juniorinnen

StandNr: 121

Leone, Chiara #115

StartNr: 68

21. Januar 2018 11:52

SUI

Unterschrift des Schützen

Meyton Elektronik

Ergebnis:	618.5	(593)							
Serien:	103.2	101.1	104.0	103.9	102.9	103.4			
Zähler:	53	7	0	0	0	0	0	0	0
Innenzehner:	46								
weiteste:	444 (20),	355 (50),	315 (14)						
beste Teiler	11.4 (29.)	39.0 (40.)	50.9 (47.)						
Trefferlage	0.15 mm rechts, 0.39 mm hoch								
Streuwert	1.25, horizontal: 1.43, vertikal: 1.03								

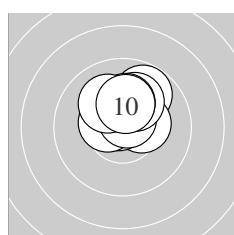
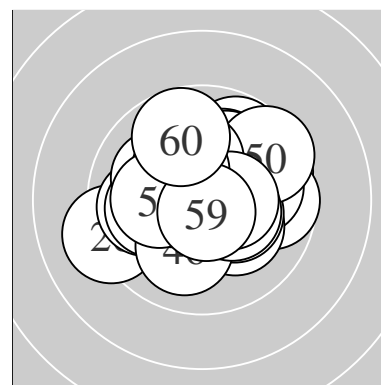

Serie 1:					
9.8 ↗	10.5 *	10.4 *	10.7 *	10.5 *	
10.7 *	10.1 ↗	10.2 *	10.1 ↘	10.2 *	
beste Teiler	53.5 (4.)	74.7 (6.)	110.5 (2.)		
Trefferlage	0.13 mm rechts, 1.23 mm hoch				
Streuwert	0.90, horizontal: 0.99, vertikal: 0.81				

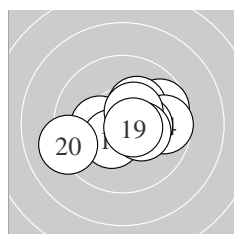

Serie 2:					
10.3 *	9.7 →	10.2 *	9.7 →	10.3 *	
10.4 *	10.4 *	10.3 *	10.6 *	9.2 ←	
beste Teiler	84.7 (19.)	127.5 (17.)	140.2 (16.)		
Trefferlage	0.50 mm rechts, 0.01 mm tief				
Streuwert	1.70, horizontal: 2.20, vertikal: 0.97				

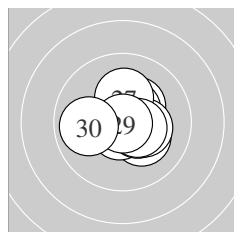

Serie 3:					
10.2 *	10.7 *	10.5 *	10.3 *	10.5 *	
10.3 *	10.2 *	10.5 *	10.9 *	9.9 ←	
beste Teiler	11.4 (29.)	68.3 (22.)	115.4 (25.)		
Trefferlage	0.43 mm rechts, 0.04 mm hoch				
Streuwert	1.10, horizontal: 1.23, vertikal: 0.96				

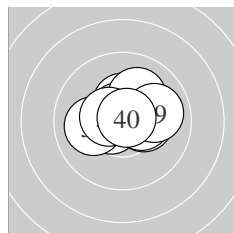

Serie 4:					
10.4 *	10.7 *	10.3 *	10.1 ↗	10.6 *	
10.1 ←	10.4 *	10.5 *	10.0 →	10.8 *	
beste Teiler	39.0 (40.)	75.6 (32.)	93.0 (35.)		
Trefferlage	0.23 mm rechts, 0.44 mm hoch				
Streuwert	1.12, horizontal: 1.42, vertikal: 0.72				

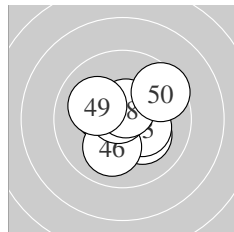

Serie 5:					
10.6 *	10.2 *	10.3 *	10.3 *	10.5 *	
10.0 ↓	10.8 *	10.6 *	10.1 ↘	9.5 ↗	
beste Teiler	50.9 (47.)	84.7 (48.)	90.7 (41.)		
Trefferlage	0.02 mm rechts, 0.07 mm hoch				
Streuwert	1.38, horizontal: 1.52, vertikal: 1.23				

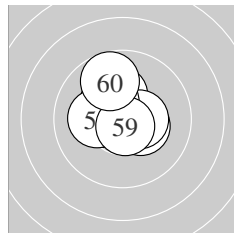

Serie 6:					
10.7 *	10.2 *	10.4 *	10.4 *	10.3 *	
10.4 *	10.4 *	10.2 *	10.7 *	9.7 ↘	
beste Teiler	58.5 (59.)	59.0 (51.)	126.0 (54.)		
Trefferlage	0.40 mm links, 0.62 mm hoch				
Streuwert	1.10, horizontal: 1.11, vertikal: 1.09				

Meyton Elektronik

ISSF AR Women Jun – Wertung – Juniorinnen

StandNr: 122

Wolf, Melissa #108

StartNr: 69

21. Januar 2018 11:47

VSBL NWLZ

Unterschrift des Schützen

Meyton Elektronik

Ergebnis:	616.1	(588)						
Serien:	103.1	101.6	103.1	103.4	102.3	102.6		
Zähler:	48	12	0	0	0	0	0	0
Innenzehner:	39							
weiteste:	466 (49), 399 (19), 375 (59)							
beste Teiler	34.0 (53.)	34.1 (8.)	36.1 (24.)					
Trefferlage	0.16 mm rechts, 0.66 mm hoch							
Streuwert	1.35, horizontal: 1.45, vertikal: 1.23							

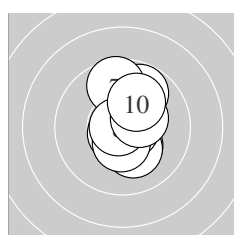
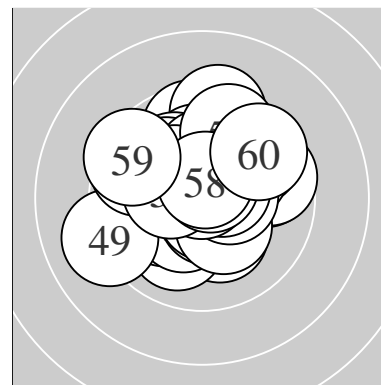

Serie 1:	9.8 ↗	10.7 *	10.3 *	10.2 *	10.7 *
	10.5 *	9.6 ↑	10.8 *	10.4 *	10.1 ↗
beste Teiler	34.1 (8.)	59.4 (5.)	67.8 (2.)		
Trefferlage	0.45 mm rechts, 0.35 mm hoch				
Streuwert	1.33, horizontal: 0.74, vertikal: 1.72				

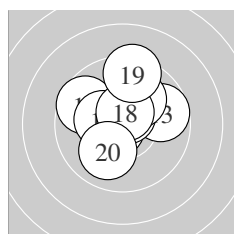

Serie 2:	10.5 *	10.7 *	9.7 →	9.7 ↖	10.6 *
	10.1 ↗	10.3 *	10.6 *	9.4 ↑	10.0 ↙
beste Teiler	62.2 (12.)	78.2 (15.)	94.9 (18.)		
Trefferlage	0.02 mm links, 0.87 mm hoch				
Streuwert	1.57, horizontal: 1.61, vertikal: 1.53				

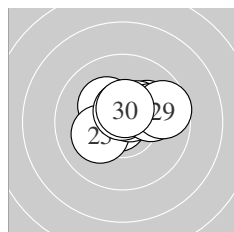

Serie 3:	10.2 *	10.1 ↗	10.4 *	10.8 *	10.2 *
	10.6 *	10.6 *	10.0 →	9.7 →	10.5 *
beste Teiler	36.1 (24.)	84.0 (27.)	91.8 (26.)		
Trefferlage	0.56 mm rechts, 0.65 mm hoch				
Streuwert	1.17, horizontal: 1.53, vertikal: 0.65				

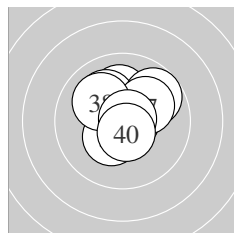

Serie 4:	10.1 ↑	10.4 *	10.1 ↖	10.7 *	10.7 *
	9.8 ↗	10.1 ↗	10.1 ↖	10.8 *	10.6 *
beste Teiler	41.6 (39.)	62.2 (35.)	69.7 (34.)		
Trefferlage	0.19 mm rechts, 0.68 mm hoch				
Streuwert	1.22, horizontal: 1.27, vertikal: 1.17				

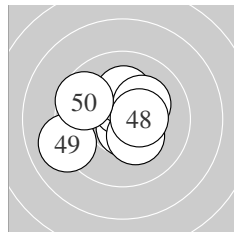

Serie 5:	10.5 *	10.7 *	10.7 *	10.6 *	10.2 *
	10.2 *	10.3 *	10.4 *	9.1 ↖	9.6 ↖
beste Teiler	55.9 (42.)	69.9 (43.)	97.2 (44.)		
Trefferlage	0.17 mm links, 0.26 mm hoch				
Streuwert	1.60, horizontal: 1.92, vertikal: 1.21				

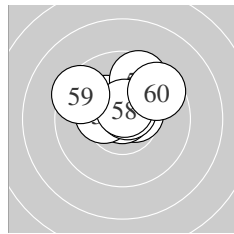

Serie 6:	10.6 *	10.5 *	10.8 *	10.3 *	10.4 *
	9.6 ↗	10.7 *	10.6 *	9.5 ↖	9.6 ↗
beste Teiler	34.0 (53.)	74.9 (57.)	84.3 (58.)		
Trefferlage	0.04 mm links, 1.17 mm hoch				
Streuwert	1.31, horizontal: 1.63, vertikal: 0.90				

Meyton Elektronik

ISSF AR Women Jun – Wertung – Juniorinnen

StandNr: 123

Pichler, Julia #110

StartNr: 70

21. Januar 2018 11:44

AUT

Unterschrift des Schützen

Meyton Elektronik

Ergebnis: **613.1** (589)

Serien: 101.4 101.2 102.9 103.7 101.8 102.1

Zähler: 49 11 0 0 0 0 0 0 0

Innenzehner: 36

weiteste: 432 (17), 349 (19), 313 (57)

beste Teiler 43.9 (52.) 49.5 (13.) 69.6 (32.)

Trefferlage 0.06 mm links, 0.08 mm hoch

Streuwert 1.42, horizontal: 1.49, vertikal: 1.35

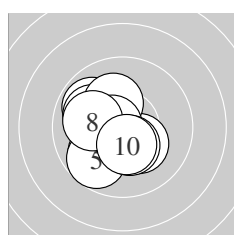
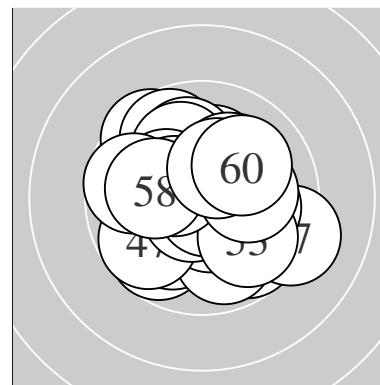

Serie 1:

10.3 *	9.9 ↖	10.0 ↖	9.9 ↙	9.7 ↙
10.2 *	10.6 *	10.0 ←	10.4 *	10.4 *

beste Teiler 80.4 (7.) 133.4 (10.) 146.3 (9.)

Trefferlage 0.99 mm links, 0.32 mm tief

Streuwert 1.39, horizontal: 1.30, vertikal: 1.47

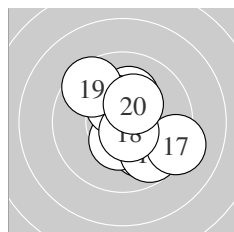

Serie 2:

10.2 *	10.0 ↘	10.8 *	10.4 *	10.4 *
9.7 ↘	9.2 ↘	10.6 *	9.6 ↖	10.3 *

beste Teiler 49.5 (13.) 85.1 (18.) 136.3 (15.)

Trefferlage 0.63 mm rechts, 0.10 mm tief

Streuwert 1.71, horizontal: 1.65, vertikal: 1.76

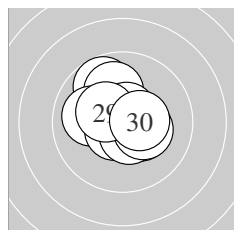

Serie 3:

9.7 ↖	10.0 ↗	10.0 ←	10.6 *	10.6 *
10.4 *	10.5 *	10.3 *	10.4 *	10.4 *

beste Teiler 78.5 (25.) 85.5 (24.) 102.8 (27.)

Trefferlage 0.13 mm links, 0.42 mm hoch

Streuwert 1.27, horizontal: 1.32, vertikal: 1.23

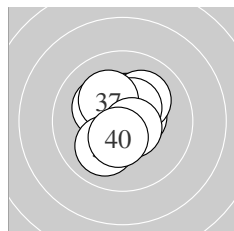

Serie 4:

10.4 *	10.7 *	10.5 *	10.2 *	10.1 ↗
10.5 *	10.2 *	10.0 ↙	10.6 *	10.5 *

beste Teiler 69.6 (32.) 85.2 (39.) 110.4 (33.)

Trefferlage 0.00 mm, 0.38 mm hoch

Streuwert 1.11, horizontal: 1.02, vertikal: 1.19

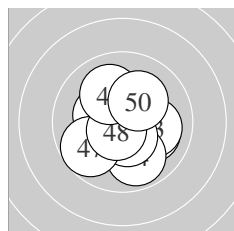

Serie 5:

10.4 *	10.1 →	10.1 →	9.9 ↘	10.5 *
10.3 *	9.7 ↙	10.6 *	10.0 ↖	10.2 *

beste Teiler 77.2 (48.) 115.1 (45.) 132.8 (41.)

Trefferlage 0.13 mm rechts, 0.18 mm tief

Streuwert 1.51, horizontal: 1.51, vertikal: 1.51

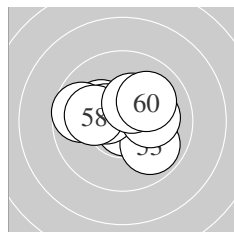

Serie 6:

10.5 *	10.8 *	9.9 ↘	10.2 *	10.4 *
10.1 →	9.7 ←	10.1 ←	10.4 *	10.0 ↗

beste Teiler 43.9 (52.) 102.7 (51.) 133.9 (55.)

Trefferlage 0.02 mm links, 0.30 mm hoch

Streuwert 1.47, horizontal: 1.86, vertikal: 0.94

ISSF AR Women Jun – Wertung – Juniorinnen

StandNr: 124

Stark, Franziska #107

StartNr: 71

21. Januar 2018 11:35

SUI

Unterschrift des Schützen

Meyton Elektronik

Ergebnis: **608.3** (582)
 Serien: 101.5 102.2 101.9 99.1 101.0 102.6
 Zähler: 43 16 1 0 0 0 0 0 0
 Innenzehner: 39
 weiteste: 601 (33), 479 (46), 399 (6)
 beste Teiler 19.9 (9.) 65.9 (40.) 66.9 (45.)
 Trefferlage 0.13 mm links, 0.33 mm hoch
 Streuwert 1.64, horizontal: 1.96, vertikal: 1.22

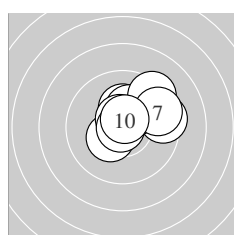
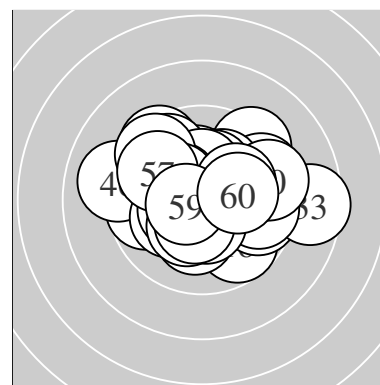

Serie 1:
 9.4 → 10.4 * 10.3 * 10.2 * 10.2 *
 9.4 ↗ 9.5 ↗ 10.6 * 10.9 * 10.6 *
 beste Teiler 19.9 (9.) 76.4 (10.) 82.8 (8.)
 Trefferlage 0.98 mm rechts, 1.03 mm hoch
 Streuwert 1.40, horizontal: 1.67, vertikal: 1.06

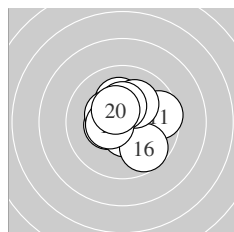

Serie 2:
 9.6 → 10.4 * 10.5 * 10.2 * 10.4 *
 9.7 ↘ 10.1 ↗ 10.4 * 10.5 * 10.4 *
 beste Teiler 102.8 (13.) 121.2 (19.) 130.3 (20.)
 Trefferlage 0.18 mm rechts, 0.37 mm hoch
 Streuwert 1.45, horizontal: 1.54, vertikal: 1.34

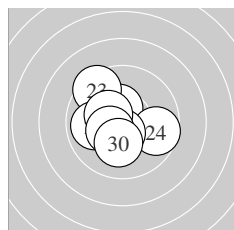

Serie 3:
 10.4 * 10.4 * 9.4 ↖ 9.7 → 10.5 *
 10.6 * 9.9 ← 10.4 * 10.4 * 10.2 *
 beste Teiler 100.9 (26.) 104.9 (25.) 129.7 (21.)
 Trefferlage 0.71 mm links, 0.08 mm tief
 Streuwert 1.49, horizontal: 1.57, vertikal: 1.40

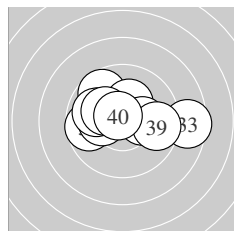

Serie 4:
 9.7 ← 9.7 ↖ 8.5 → 10.2 * 10.3 *
 10.2 * 9.9 ← 10.2 * 9.7 → 10.7 *
 beste Teiler 65.9 (40.) 174.2 (35.) 184.0 (36.)
 Trefferlage 0.02 mm rechts, 0.51 mm hoch
 Streuwert 2.16, horizontal: 2.89, vertikal: 0.99

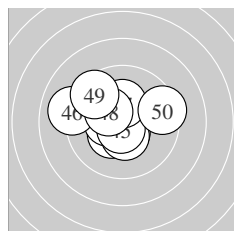

Serie 5:
 10.4 * 10.4 * 10.6 * 10.4 * 10.7 *
 9.0 ← 10.3 * 10.3 * 9.5 ↖ 9.4 →
 beste Teiler 66.9 (45.) 98.9 (43.) 131.8 (44.)
 Trefferlage 0.69 mm links, 0.33 mm hoch
 Streuwert 1.79, horizontal: 2.16, vertikal: 1.32

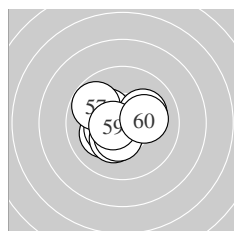

Serie 6:
 10.1 ← 10.4 * 10.3 * 10.5 * 10.1 →
 10.3 * 9.8 ↖ 10.4 * 10.6 * 10.1 →
 beste Teiler 92.1 (59.) 115.1 (54.) 135.3 (58.)
 Trefferlage 0.57 mm links, 0.17 mm tief
 Streuwert 1.27, horizontal: 1.46, vertikal: 1.06

Meyton Elektronik

ISSF AR Women Jun – Wertung – Juniorinnen

StandNr: 125

Burtscher, Jaqueline #73

StartNr: 72

21. Januar 2018 11:48

VSBL NWLZ

Unterschrift des Schützen

Meyton Elektronik

Ergebnis:	599.5	(574)
Serien:	99.1 98.5 98.9 102.0 100.1 100.9	
Zähler:	35 24 1 0 0 0 0 0 0	
Innenzehner:	22	
weiteste:	647 (17), 497 (42), 487 (40)	
beste Teiler	71.1 (48.) 92.1 (38.) 94.4 (47.)	
Trefferlage	0.07 mm rechts, 0.61 mm hoch	
Streuwert	1.85, horizontal: 2.10, vertikal: 1.56	

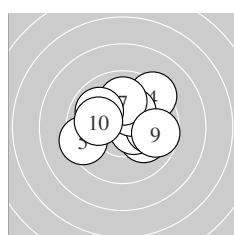
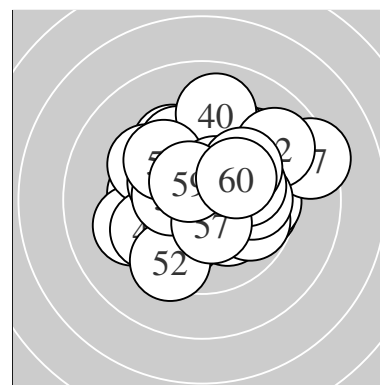

Serie 1:

10.1 ↘	10.5 *	9.9 →	9.3 ↗	9.4 ←
10.3 *	10.0 ↑	9.9 ↙	9.7 →	10.0 ←
beste Teiler	107.9 (2.)	165.3 (6.)	222.3 (1.)	
Trefferlage	0.42 mm rechts, 0.54 mm hoch			
Streuwert	1.96, horizontal: 2.37, vertikal: 1.44			

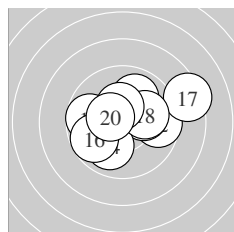

Serie 2:

10.0 ↗	9.6 →	10.1 →	10.0 ↘	9.7 ←
9.7 ←	8.4 →	10.1 →	10.4 *	10.5 *
beste Teiler	123.6 (20.)	146.3 (19.)	202.0 (13.)	
Trefferlage	0.62 mm rechts, 0.42 mm hoch			
Streuwert	2.24, horizontal: 2.83, vertikal: 1.44			

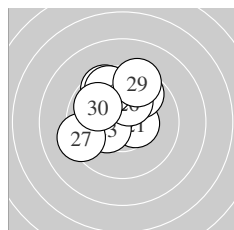

Serie 3:

10.5 *	10.4 *	10.3 *	9.7 ↗	9.6 ↘
10.2 *	9.3 ←	9.6 ↘	9.4 ↑	9.9 ↘
beste Teiler	119.7 (21.)	130.2 (22.)	157.3 (23.)	
Trefferlage	0.70 mm links, 1.40 mm hoch			
Streuwert	1.77, horizontal: 1.80, vertikal: 1.74			

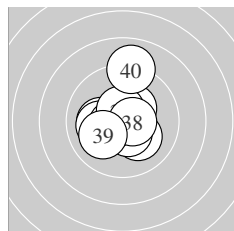

Serie 4:

10.1 ←	10.4 *	10.1 ↘	10.5 *	10.1 ←
10.6 *	10.5 *	10.6 *	10.1 ←	9.0 ↑
beste Teiler	92.1 (38.)	94.8 (36.)	101.7 (37.)	
Trefferlage	0.24 mm links, 0.24 mm hoch			
Streuwert	1.61, horizontal: 1.36, vertikal: 1.82			

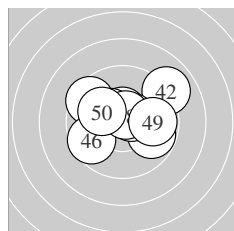

Serie 5:

9.8 ↘	9.0 ↗	9.5 ↙	10.6 *	10.4 *
9.6 ←	10.6 *	10.7 *	9.8 →	10.1 ←
beste Teiler	71.1 (48.)	94.4 (47.)	100.0 (44.)	
Trefferlage	0.16 mm rechts, 0.60 mm hoch			
Streuwert	1.98, horizontal: 2.46, vertikal: 1.33			

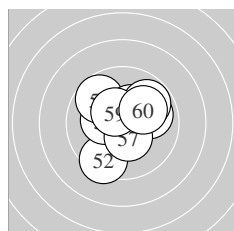

Serie 6:

9.9 →	9.4 ↘	10.5 *	10.3 *	9.7 ↘
10.4 *	10.4 *	9.8 ↗	10.5 *	10.0 ↗
beste Teiler	107.7 (53.)	124.2 (59.)	140.3 (57.)	
Trefferlage	0.20 mm rechts, 0.48 mm hoch			
Streuwert	1.69, horizontal: 1.71, vertikal: 1.66			

ISSF AR Women Jun – Wertung – Juniorinnen

StandNr: 126

Graf, Melissa #72

StartNr: 73

21. Januar 2018 11:16

BY – Schwaben

Unterschrift des Schützen

Meyton Elektronik

Ergebnis: **608.3** (580)
 Serien: 100.0 102.1 102.8 103.5 99.9 100.0
 Zähler: 41 18 1 0 0 0 0 0 0
 Innenzehner: 31
 weiteste: 544 (43), 409 (12), 399 (53)
 beste Teiler 39.1 (13.) 49.6 (33.) 51.6 (34.)
 Trefferlage 0.10 mm rechts, 0.08 mm hoch
 Streuwert 1.62, horizontal: 1.96, vertikal: 1.19

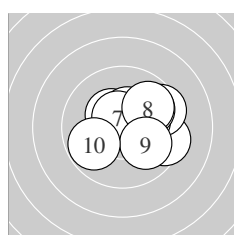
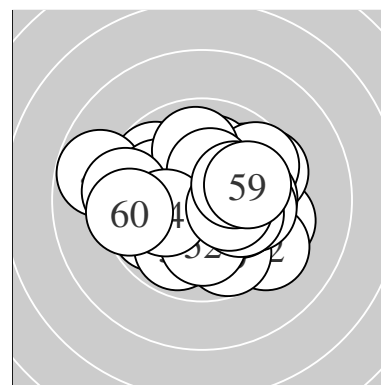

Serie 1:
 10.4 * 9.4 → 9.5 → 10.4 * 10.2 *
 9.9 ↗ 10.6 * 9.8 ↗ 10.0 ↘ 9.8 ↙
 beste Teiler 96.1 (7.) 129.0 (4.) 145.0 (1.)
 Trefferlage 1.17 mm rechts, 0.45 mm hoch
 Streuwert 1.65, horizontal: 1.96, vertikal: 1.25

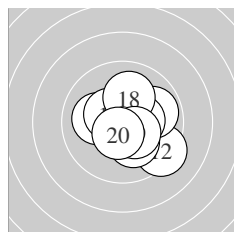

Serie 2:
 10.1 ← 9.3 ↘ 10.8 * 9.9 → 10.4 *
 10.2 * 10.4 * 10.1 ↑ 10.4 * 10.5 *
 beste Teiler 39.1 (13.) 103.6 (20.) 130.1 (15.)
 Trefferlage 0.61 mm rechts, 0.22 mm tief
 Streuwert 1.49, horizontal: 1.63, vertikal: 1.33

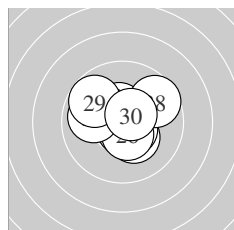

Serie 3:
 10.5 * 10.3 * 10.3 * 10.6 * 10.7 *
 10.5 * 9.9 ← 9.6 ↗ 9.8 ↘ 10.6 *
 beste Teiler 64.1 (25.) 97.0 (30.) 99.4 (24.)
 Trefferlage 0.08 mm links, 0.29 mm hoch
 Streuwert 1.40, horizontal: 1.62, vertikal: 1.14

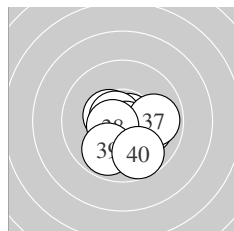

Serie 4:
 10.4 * 10.1 → 10.8 * 10.7 * 10.7 *
 10.7 * 9.9 → 10.6 * 9.9 ↙ 9.7 ↘
 beste Teiler 49.6 (33.) 51.6 (34.) 61.7 (36.)
 Trefferlage 0.24 mm rechts, 0.56 mm tief
 Streuwert 1.26, horizontal: 1.39, vertikal: 1.12

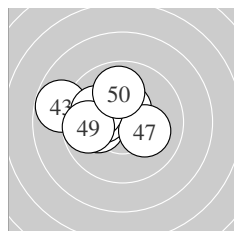

Serie 5:
 10.1 ← 10.2 * 8.8 ← 10.5 * 10.3 *
 10.2 * 10.1 → 10.0 ← 9.8 ← 9.9 ↑
 beste Teiler 110.8 (44.) 165.1 (45.) 178.0 (42.)
 Trefferlage 1.43 mm links, 0.72 mm hoch
 Streuwert 1.57, horizontal: 1.95, vertikal: 1.04

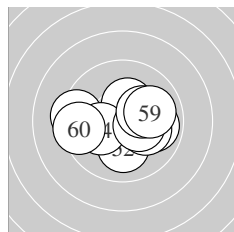

Serie 6:
 10.3 * 10.1 ↓ 9.4 ← 10.2 * 9.9 →
 10.1 → 10.4 * 10.2 * 10.0 → 9.4 ←
 beste Teiler 146.9 (57.) 151.9 (51.) 186.1 (58.)
 Trefferlage 0.09 mm rechts, 0.15 mm tief
 Streuwert 1.89, horizontal: 2.47, vertikal: 1.04

ISSF AR Women Jun – Wertung – Juniorinnen

StandNr: 127

Patka, Anna #119

StartNr: 74

21. Januar 2018 11:24

T – SG Thierberg

Unterschrift des Schützen

Meyton Elektronik

Ergebnis:	620.4	(590)						
Serien:	101.2	102.9	105.1	105.3	103.0	102.9		
Zähler:	50	10	0	0	0	0	0	0
Innenzehner:	45							
weiteste:	428 (5), 379 (3), 366 (52)							
beste Teiler	2.2 (2.)	29.0 (45.)	32.7 (31.)					
Trefferlage	0.05 mm links, 0.13 mm hoch							
Streuwert	1.28, horizontal: 1.30, vertikal: 1.26							

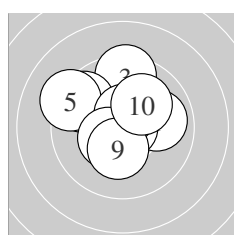
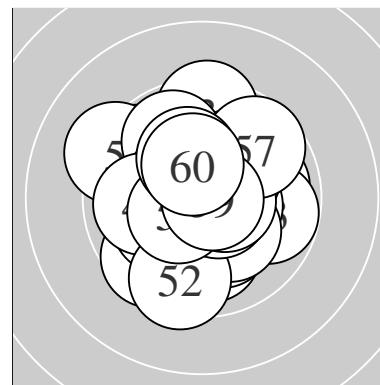

Serie 1:	9.9 →	10.9 *	9.4 ↑	9.6 ↘	9.2 ↖
	10.8 *	10.6 *	10.4 *	10.3 *	10.1 ↗
beste Teiler	2.2 (2.) 34.0 (6.) 92.0 (7.)				
Trefferlage	0.34 mm links, 0.83 mm hoch				
Streuwert	1.71, horizontal: 1.85, vertikal: 1.55				

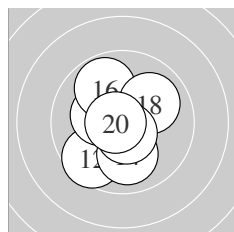

Serie 2:	10.6 *	9.6 ↙	10.3 *	10.0 ↓	10.6 *
	9.8 ↘	10.7 *	10.0 ↗	10.6 *	10.7 *
beste Teiler	52.0 (20.) 59.1 (17.) 86.9 (19.)				
Trefferlage	0.29 mm links, 0.18 mm tief				
Streuwert	1.40, horizontal: 1.19, vertikal: 1.59				

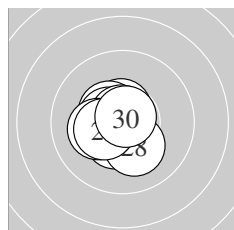

Serie 3:	10.6 *	10.5 *	10.4 *	10.7 *	10.5 *
	10.8 *	10.2 *	10.2 *	10.4 *	10.8 *
beste Teiler	45.6 (30.) 48.5 (26.) 66.3 (24.)				
Trefferlage	0.55 mm links, 0.11 mm tief				
Streuwert	0.82, horizontal: 0.78, vertikal: 0.86				

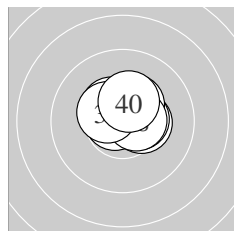

Serie 4:	10.8 *	10.7 *	10.4 *	10.7 *	10.5 *
	10.4 *	10.4 *	10.6 *	10.4 *	10.4 *
beste Teiler	32.7 (31.) 56.8 (34.) 64.8 (32.)				
Trefferlage	0.28 mm rechts, 0.49 mm hoch				
Streuwert	0.73, horizontal: 0.88, vertikal: 0.54				

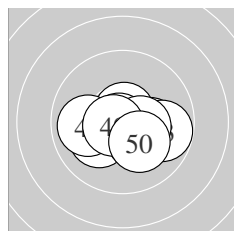

Serie 5:	10.1 ↙	10.1 →	9.8 →	10.7 *	10.8 *
	10.3 *	9.9 ←	10.4 *	10.7 *	10.2 *
beste Teiler	29.0 (45.) 66.9 (44.) 72.4 (49.)				
Trefferlage	0.33 mm rechts, 0.51 mm tief				
Streuwert	1.26, horizontal: 1.68, vertikal: 0.61				

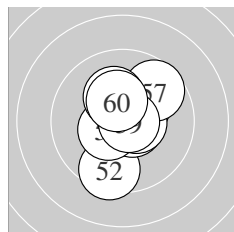

Serie 6:	10.3 *	9.5 ↓	10.6 *	10.6 *	10.4 *
	10.5 *	9.7 ↗	10.2 *	10.8 *	10.3 *
beste Teiler	46.3 (59.) 82.8 (53.) 100.8 (54.)				
Trefferlage	0.21 mm rechts, 0.28 mm hoch				
Streuwert	1.41, horizontal: 1.10, vertikal: 1.66				

Meyton Elektronik

ISSF AR Women Jun – Wertung – Juniorinnen

StandNr: 128

Brabcova, Karolina #63

StartNr: 75

21. Januar 2018 11:30

CZE

Unterschrift des Schützen

Meyton Elektronik

Ergebnis: **621.0** (591)
 Serien: 103.0 105.7 102.6 104.1 101.6 104.0
 Zähler: 52 7 1 0 0 0 0 0 0
 Innenzehner: 46
 weiteste: 543 (44), 396 (41), 328 (31)
 beste Teiler 29.6 (17.) 35.7 (40.) 37.8 (47.)
 Trefferlage 0.47 mm rechts, 0.20 mm hoch
 Streuwert 1.21, horizontal: 1.28, vertikal: 1.15

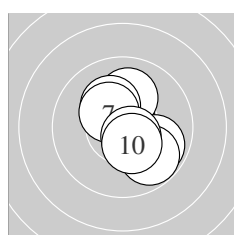
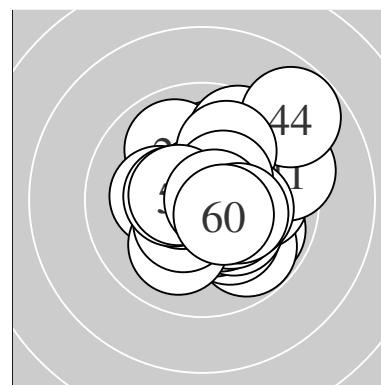

Serie 1:
 10.5 * 10.7 * 10.4 * 10.1 ↑ 10.2 *
 9.9 ↘ 10.4 * 9.8 ↘ 10.6 * 10.4 *
 beste Teiler 54.1 (2.) 92.7 (9.) 109.5 (1.)
 Trefferlage 0.40 mm rechts, 0.24 mm hoch
 Streuwert 1.30, horizontal: 1.12, vertikal: 1.46

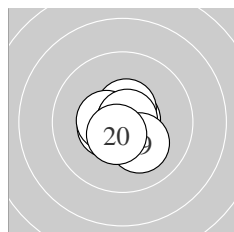

Serie 2:
 10.7 * 10.6 * 10.5 * 10.6 * 10.5 *
 10.5 * 10.8 * 10.8 * 10.2 * 10.5 *
 beste Teiler 29.6 (17.) 40.8 (18.) 60.7 (11.)
 Trefferlage 0.01 mm links, 0.26 mm tief
 Streuwert 0.75, horizontal: 0.78, vertikal: 0.72

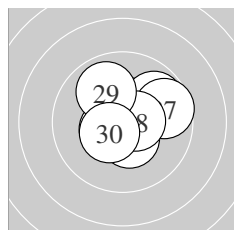

Serie 3:
 10.1 ↗ 10.5 * 10.4 * 10.5 * 10.7 *
 9.8 ↗ 9.6 → 10.6 * 9.9 ↘ 10.5 *
 beste Teiler 68.8 (25.) 96.3 (28.) 113.1 (24.)
 Trefferlage 0.61 mm rechts, 0.51 mm hoch
 Streuwert 1.31, horizontal: 1.50, vertikal: 1.10

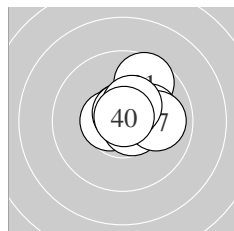

Serie 4:
 9.6 ↗ 10.1 → 10.7 * 10.6 * 10.6 *
 10.6 * 10.0 → 10.7 * 10.4 * 10.8 *
 beste Teiler 35.7 (40.) 54.7 (33.) 60.0 (38.)
 Trefferlage 0.68 mm rechts, 0.63 mm hoch
 Streuwert 0.97, horizontal: 1.05, vertikal: 0.89

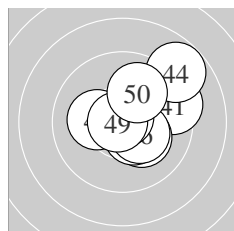

Serie 5:
 9.4 → 10.2 * 10.7 * 8.8 ↗ 10.4 *
 10.3 * 10.8 * 10.2 * 10.8 * 10.0 ↑
 beste Teiler 37.8 (47.) 38.0 (49.) 60.9 (43.)
 Trefferlage 1.05 mm rechts, 0.44 mm hoch
 Streuwert 1.66, horizontal: 1.77, vertikal: 1.55

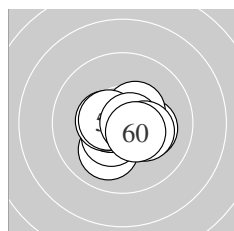

Serie 6:
 10.0 ↘ 10.2 * 10.4 * 10.6 * 10.4 *
 10.4 * 10.5 * 10.7 * 10.3 * 10.5 *
 beste Teiler 55.0 (58.) 88.1 (54.) 107.2 (57.)
 Trefferlage 0.08 mm rechts, 0.33 mm tief
 Streuwert 1.03, horizontal: 1.22, vertikal: 0.79

Meyton Elektronik

ISSF AR Women Jun – Wertung – Juniorinnen

StandNr: 129

Vogl, Jana #103

StartNr: 76

21. Januar 2018 11:14

T – SG Wattens

Unterschrift des Schützen

Meyton Elektronik

Ergebnis: **625.2** (597)
 Serien: 103.3 104.7 103.8 105.7 104.1 103.6
 Zähler: 57 3 0 0 0 0 0 0 0 0
 Innenzehner: 49
 weiteste: 302 (27), 279 (20), 261 (46)
 beste Teiler 20.0 (37.) 27.0 (6.) 38.9 (17.)
 Trefferlage 0.04 mm links, 0.41 mm hoch
 Streuwert 1.04, horizontal: 1.27, vertikal: 0.74

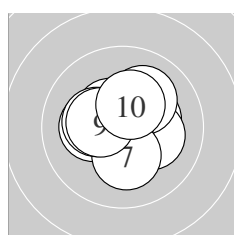
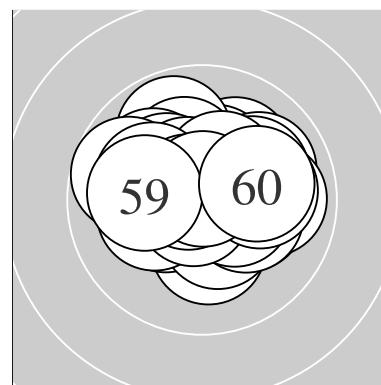

Serie 1:
 10.3 * 10.5 * 10.2 * 10.2 * 10.1 ↗
 10.8 * 10.2 * 10.3 * 10.4 * 10.3 *
 beste Teiler 27.0 (6.) 123.2 (2.) 146.3 (9.)
 Trefferlage 0.06 mm links, 0.29 mm hoch
 Streuwert 1.20, horizontal: 1.37, vertikal: 1.01

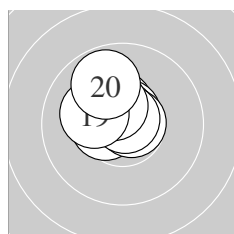

Serie 2:
 10.4 * 10.5 * 10.7 * 10.7 * 10.5 *
 10.7 * 10.8 * 10.4 * 10.2 * 9.8 ↘
 beste Teiler 38.9 (17.) 54.0 (14.) 58.5 (16.)
 Trefferlage 0.47 mm links, 0.81 mm hoch
 Streuwert 0.75, horizontal: 0.75, vertikal: 0.75

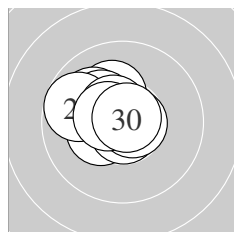

Serie 3:
 10.3 * 10.2 * 10.8 * 10.0 ↘ 10.7 *
 10.2 * 9.7 ↙ 10.6 * 10.5 * 10.8 *
 beste Teiler 38.9 (30.) 47.5 (23.) 65.3 (25.)
 Trefferlage 0.88 mm links, 0.55 mm hoch
 Streuwert 0.93, horizontal: 1.06, vertikal: 0.78

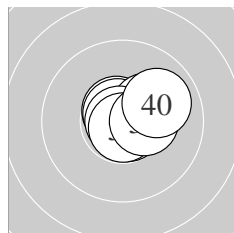

Serie 4:
 10.7 * 10.6 * 10.7 * 10.3 * 10.8 *
 10.5 * 10.9 * 10.8 * 10.4 * 10.0 →
 beste Teiler 20.0 (37.) 42.1 (38.) 50.3 (35.)
 Trefferlage 0.54 mm rechts, 0.30 mm hoch
 Streuwert 0.76, horizontal: 0.94, vertikal: 0.53

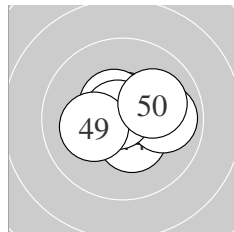

Serie 5:
 10.6 * 10.6 * 10.4 * 10.4 * 10.6 *
 9.9 → 10.5 * 10.8 * 10.2 * 10.1 →
 beste Teiler 43.2 (48.) 81.3 (42.) 91.2 (45.)
 Trefferlage 0.27 mm rechts, 0.23 mm hoch
 Streuwert 1.10, horizontal: 1.38, vertikal: 0.71

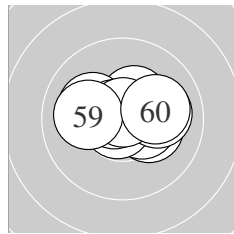

Serie 6:
 10.4 * 10.2 * 10.4 * 10.8 * 10.1 ↘
 10.0 → 10.7 * 10.8 * 10.1 ← 10.1 →
 beste Teiler 43.1 (58.) 46.6 (54.) 61.4 (57.)
 Trefferlage 0.31 mm rechts, 0.27 mm hoch
 Streuwert 1.19, horizontal: 1.60, vertikal: 0.55

Meyton Elektronik

ISSF AR Women Jun – Wertung – Juniorinnen

StandNr: 130

Tan, Qian Ni Fernel #89

StartNr: 77

21. Januar 2018 11:53

SGP

Unterschrift des Schützen

Meyton Elektronik

Ergebnis: **608.6** (581)
 Serien: 101.2 100.3 101.7 102.2 100.0 103.2
 Zähler: 41 19 0 0 0 0 0 0 0
 Innenzehner: 31
 weiteste: 426 (11), 416 (19), 380 (42)
 beste Teiler 20.6 (27.) 36.1 (20.) 43.8 (57.)
 Trefferlage 0.33 mm links, 0.20 mm hoch
 Streuwert 1.57, horizontal: 1.70, vertikal: 1.43

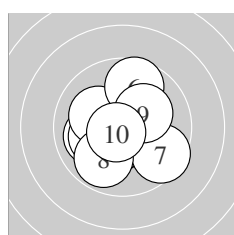
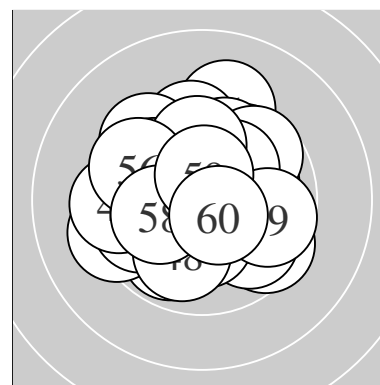

Serie 1:
 10.0 ← 10.4 * 10.2 * 10.1 ↖ 10.5 *
 9.7 ↑ 9.5 ↘ 9.9 ↙ 10.2 * 10.7 *
 beste Teiler 62.6 (10.) 117.3 (5.) 126.6 (2.)
 Trefferlage 0.34 mm links, 0.33 mm tief
 Streuwert 1.64, horizontal: 1.67, vertikal: 1.61

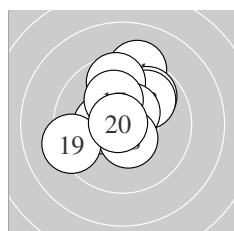

Serie 2:
 9.2 ↑ 9.8 ↗ 9.9 ↗ 9.7 ↑ 10.4 *
 10.5 * 10.2 * 10.5 * 9.3 ← 10.8 *
 beste Teiler 36.1 (20.) 107.3 (16.) 117.1 (18.)
 Trefferlage 0.11 mm links, 1.15 mm hoch
 Streuwert 1.76, horizontal: 1.72, vertikal: 1.81

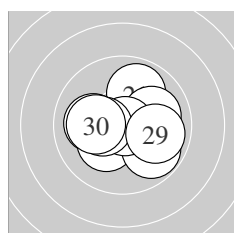

Serie 3:
 9.9 ↑ 10.0 → 10.4 * 10.1 ← 10.2 *
 9.8 ↘ 10.9 * 10.4 * 9.9 → 10.1 ←
 beste Teiler 20.6 (27.) 149.6 (23.) 150.3 (28.)
 Trefferlage 0.03 mm links, 0.08 mm tief
 Streuwert 1.56, horizontal: 1.88, vertikal: 1.14

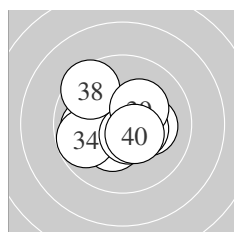

Serie 4:
 10.0 ← 10.6 * 10.3 * 9.8 ← 10.6 *
 10.2 * 10.4 * 9.5 ↘ 10.3 * 10.5 *
 beste Teiler 76.6 (32.) 91.4 (35.) 117.9 (40.)
 Trefferlage 0.23 mm links, 0.16 mm tief
 Streuwert 1.51, horizontal: 1.76, vertikal: 1.20

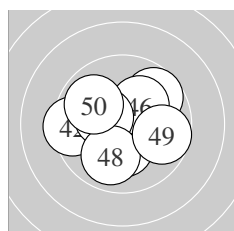

Serie 5:
 10.0 ↖ 9.4 ← 10.6 * 10.2 * 9.7 ↗
 10.2 * 10.4 * 9.9 ↓ 9.7 → 9.9 ↖
 beste Teiler 78.2 (43.) 150.8 (47.) 177.2 (44.)
 Trefferlage 0.33 mm links, 0.06 mm hoch
 Streuwert 1.85, horizontal: 2.17, vertikal: 1.47

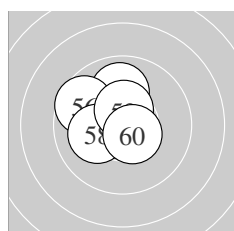

Serie 6:
 10.4 * 10.0 ↑ 10.7 * 10.6 * 10.0 ↖
 9.6 ↖ 10.8 * 10.1 ← 10.5 * 10.5 *
 beste Teiler 43.8 (57.) 65.8 (53.) 81.3 (54.)
 Trefferlage 0.92 mm links, 0.58 mm hoch
 Streuwert 1.08, horizontal: 1.15, vertikal: 1.00

ISSF AR Women Jun – Wertung – Juniorinnen

StandNr: 131

Surny, Kim #97

StartNr: 78

21. Januar 2018 11:46

SUI

Unterschrift des Schützen

Meyton Elektronik

Ergebnis: **615.4** (587)

Serien: 102.6 103.0 102.9 103.7 101.0 102.2

Zähler: 48 11 1 0 0 0 0 0 0

Innenzehner: 40

weiteste: 527 (28), 479 (3), 364 (53)

beste Teiler 14.3 (27.) 42.1 (7.) 51.6 (57.)

Trefferlage 0.24 mm links, 0.04 mm hoch

Streuwert 1.42, horizontal: 1.72, vertikal: 1.04

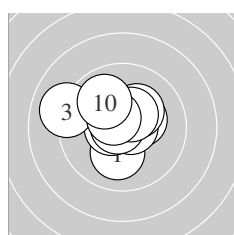
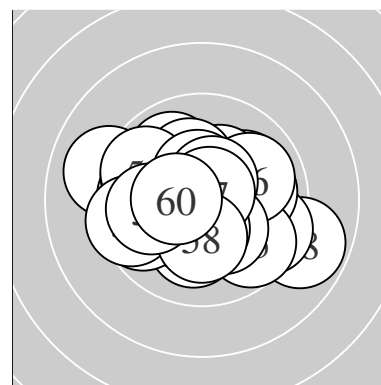

Serie 1:

10.1 ↓	10.6 *	9.0 ↖	10.3 *	10.7 *
10.2 *	10.8 *	10.5 *	10.5 *	9.9 ↘

beste Teiler 42.1 (7.) 67.0 (5.) 91.3 (2.)

Trefferlage 0.46 mm links, 0.51 mm hoch

Streuwert 1.47, horizontal: 1.74, vertikal: 1.15

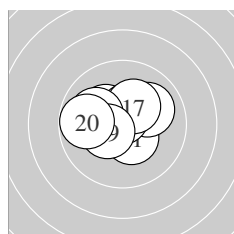

Serie 2:

10.4 *	10.6 *	10.3 *	10.5 *	10.0 ↗
10.7 *	10.3 *	10.0 ↖	10.4 *	9.8 ←

beste Teiler 56.7 (16.) 78.8 (12.) 121.8 (14.)

Trefferlage 0.44 mm links, 0.51 mm hoch

Streuwert 1.22, horizontal: 1.52, vertikal: 0.81

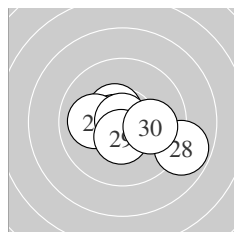

Serie 3:

10.6 *	10.3 *	10.6 *	10.5 *	10.7 *
10.0 ←	10.9 *	8.8 ↘	10.5 *	10.0 →

beste Teiler 14.3 (27.) 69.0 (25.) 80.0 (23.)

Trefferlage 0.01 mm rechts, 0.19 mm tief

Streuwert 1.58, horizontal: 2.07, vertikal: 0.87

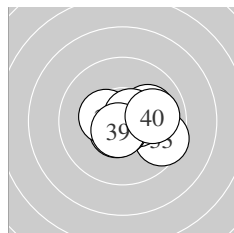

Serie 4:

10.7 *	10.1 ↗	9.5 ↘	10.5 *	10.7 *
10.6 *	10.4 *	10.6 *	10.6 *	10.0 →

beste Teiler 58.9 (35.) 71.5 (31.) 80.2 (38.)

Trefferlage 0.65 mm rechts, 0.17 mm tief

Streuwert 1.18, horizontal: 1.52, vertikal: 0.70

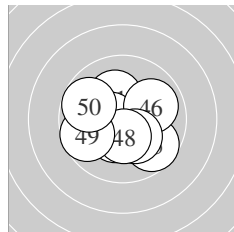

Serie 5:

10.2 *	10.4 *	10.1 ↘	10.5 *	9.7 ↘
9.9 ↗	10.3 *	10.4 *	9.7 ←	9.8 ←

beste Teiler 102.0 (44.) 142.4 (48.) 147.2 (42.)

Trefferlage 0.05 mm links, 0.48 mm tief

Streuwert 1.65, horizontal: 1.90, vertikal: 1.36

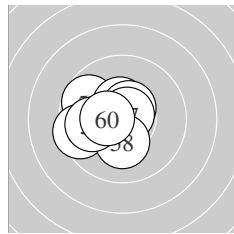

Serie 6:

10.4 *	9.7 ↖	9.5 ←	10.5 *	10.5 *
10.4 *	10.7 *	10.2 *	9.9 ←	10.4 *

beste Teiler 51.6 (57.) 102.9 (55.) 123.1 (54.)

Trefferlage 1.17 mm links, 0.10 mm hoch

Streuwert 1.22, horizontal: 1.38, vertikal: 1.03

Meyton Elektronik

ISSF AR Women Jun – Wertung –

Juniorinnen

StartNr: 79

StandNr: 132

21. Januar 2018 11:50

Nurul, Syafiqa Binte Nassaruddin #100

SGP

Unterschrift des Schützen

Meyton Elektronik

Ergebnis:	624.1	(595)					
Serien:	102.9	102.9	104.3	104.6	104.5	104.9	
Zähler:	55	5	0	0	0	0	0
Innenzehner:	50						
weiteste:	319	(16),	305	(6),	266	(4)	
beste Teiler	30.3	(41.)	35.4	(51.)	47.5	(27.)	
Trefferlage	0.05 mm links, 0.07 mm hoch						
Streuwert	1.08, horizontal: 1.10, vertikal: 1.06						

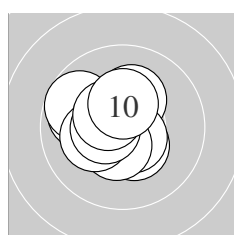
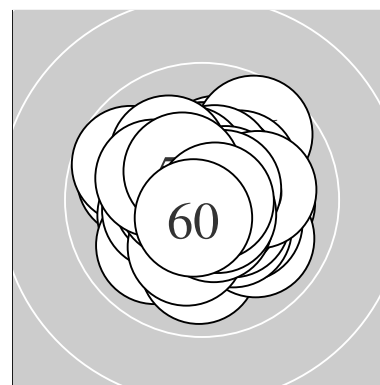

Serie 1:	10.4 *	10.2 *	10.6 *	9.9 ↖	10.5 *
	9.7 ↖	10.2 *	10.5 *	10.5 *	10.4 *
beste Teiler	89.9 (3.) 110.3 (8.) 120.1 (9.)				
Trefferlage	0.75 mm links, 0.25 mm hoch				
Streuwert	1.20, horizontal: 1.28, vertikal: 1.11				

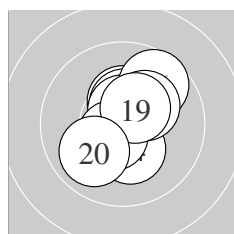

Serie 2:	10.4 *	10.4 *	10.4 *	10.3 *	10.6 *
	9.7 ↗	10.6 *	10.2 *	10.4 *	9.9 ↙
beste Teiler	90.0 (15.) 95.0 (17.) 128.5 (13.)				
Trefferlage	0.18 mm rechts, 0.29 mm hoch				
Streuwert	1.31, horizontal: 1.08, vertikal: 1.50				

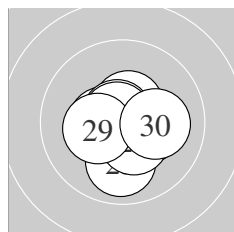

Serie 3:	10.4 *	10.5 *	10.5 *	10.6 *	10.0 ↓
	10.7 *	10.8 *	10.4 *	10.3 *	10.1 →
beste Teiler	47.5 (27.) 57.8 (26.) 79.9 (24.)				
Trefferlage	0.08 mm rechts, 0.35 mm tief				
Streuwert	1.05, horizontal: 1.11, vertikal: 0.98				

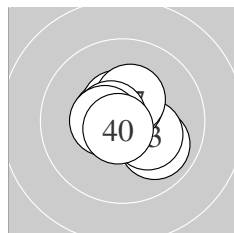

Serie 4:	10.7 *	9.9 ↘	10.2 *	10.6 *	10.5 *
	10.5 *	10.4 *	10.6 *	10.5 *	10.7 *
beste Teiler	52.0 (31.) 56.9 (40.) 81.5 (38.)				
Trefferlage	0.09 mm rechts, 0.17 mm hoch				
Streuwert	0.98, horizontal: 1.05, vertikal: 0.90				

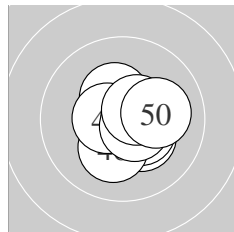

Serie 5:	10.8 *	10.3 *	10.4 *	10.4 *	10.6 *
	10.2 *	10.6 *	10.6 *	10.5 *	10.1 →
beste Teiler	30.3 (41.) 85.9 (45.) 89.6 (48.)				
Trefferlage	0.35 mm rechts, 0.20 mm tief				
Streuwert	0.97, horizontal: 1.01, vertikal: 0.92				

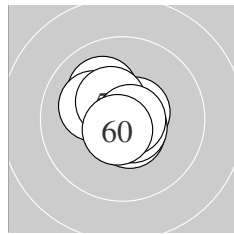

Serie 6:	10.8 *	10.3 *	10.1 ↖	10.6 *	10.6 *
	10.1 ↖	10.6 *	10.4 *	10.8 *	10.6 *
beste Teiler	35.4 (51.) 50.2 (59.) 76.4 (60.)				
Trefferlage	0.27 mm links, 0.29 mm hoch				
Streuwert	0.92, horizontal: 0.94, vertikal: 0.89				

Meyton Elektronik

ISSF AR Women Jun – Wertung – Juniorinnen

StandNr: 133

Bolotkova, Polina #62

StartNr: 80

21. Januar 2018 11:44

RUS

Unterschrift des Schützen

Meyton Elektronik

Ergebnis: **618.4** (591)
 Serien: 103.7 103.6 104.0 100.5 102.5 104.1
 Zähler: 51 9 0 0 0 0 0 0 0
 Innenzehner: 42
 weiteste: 372 (46), 357 (37), 347 (9)
 beste Teiler 35.0 (28.) 38.2 (5.) 42.7 (51.)
 Trefferlage 0.01 mm rechts, 0.00 mm
 Streuwert 1.28, horizontal: 1.36, vertikal: 1.20

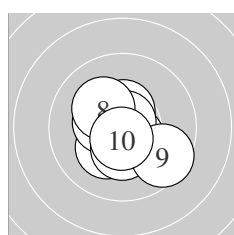
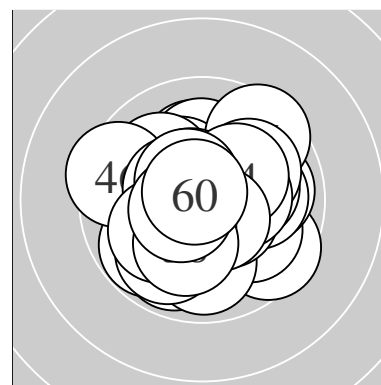

Serie 1:
 10.2 * 10.6 * 10.5 * 10.5 * 10.8 *
 10.4 * 10.3 * 10.2 * 9.6 ↘ 10.6 *
 beste Teiler 38.2 (5.) 82.3 (10.) 96.3 (2.)
 Trefferlage 0.10 mm links, 0.30 mm tief
 Streuwert 1.21, horizontal: 1.25, vertikal: 1.17

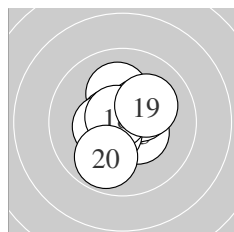

Serie 2:
 10.5 * 10.1 ↑ 10.4 * 10.6 * 10.4 *
 10.5 * 10.4 * 10.7 * 10.1 ↗ 9.9 ↙
 beste Teiler 57.4 (18.) 83.7 (14.) 114.6 (16.)
 Trefferlage 0.18 mm links, 0.06 mm tief
 Streuwert 1.18, horizontal: 1.09, vertikal: 1.27

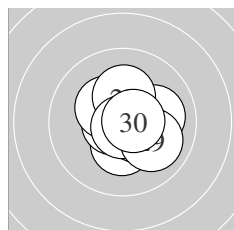

Serie 3:
 10.3 * 10.1 → 10.5 * 10.7 * 10.5 *
 10.3 * 10.2 * 10.8 * 10.0 ↘ 10.6 *
 beste Teiler 35.0 (28.) 68.5 (24.) 76.4 (30.)
 Trefferlage 0.36 mm rechts, 0.03 mm hoch
 Streuwert 1.09, horizontal: 1.13, vertikal: 1.05

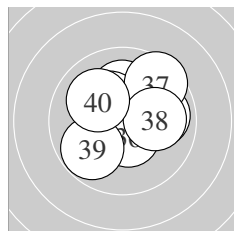

Serie 4:
 10.1 ↑ 10.5 * 9.9 ↗ 9.9 → 10.3 *
 10.5 * 9.5 ↗ 10.0 → 9.8 ↙ 10.0 ↘
 beste Teiler 110.8 (36.) 119.4 (32.) 160.0 (35.)
 Trefferlage 0.58 mm rechts, 0.72 mm hoch
 Streuwert 1.60, horizontal: 1.77, vertikal: 1.41

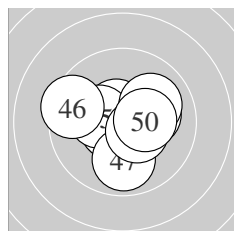

Serie 5:
 10.6 * 10.6 * 10.6 * 10.2 * 10.3 *
 9.5 ↖ 9.9 ↓ 10.5 * 10.0 → 10.3 *
 beste Teiler 84.8 (42.) 89.8 (43.) 92.6 (41.)
 Trefferlage 0.05 mm links, 0.00 mm
 Streuwert 1.48, horizontal: 1.76, vertikal: 1.14

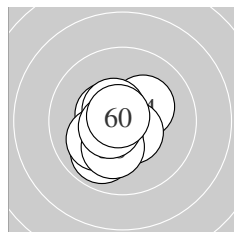

Serie 6:
 10.8 * 10.5 * 9.9 ↙ 10.2 * 10.5 *
 10.1 ↙ 10.5 * 10.2 * 10.6 * 10.8 *
 beste Teiler 42.7 (51.) 46.6 (60.) 98.8 (59.)
 Trefferlage 0.52 mm links, 0.38 mm tief
 Streuwert 1.05, horizontal: 0.96, vertikal: 1.12

Meyton Elektronik

ISSF AR Women Jun – Wertung – Juniorinnen

StandNr: 134

Caluori, Valentina #111

StartNr: 81

21. Januar 2018 11:46

SUI

Unterschrift des Schützen

Meyton Elektronik

Ergebnis: **601.0** (574)

Serien: 99.8 101.3 100.3 99.2 100.5 99.9

Zähler: 36 22 2 0 0 0 0 0 0 0

Innenzehner: 29

weiteste: 512 (47), 506 (9), 458 (5)

beste Teiler 5.3 (1.) 16.0 (6.) 40.0 (10.)

Trefferlage 0.05 mm links, 0.43 mm hoch

Streuwert 1.91, horizontal: 2.12, vertikal: 1.67

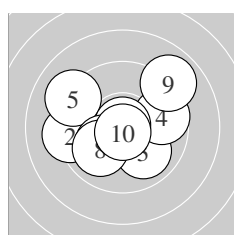
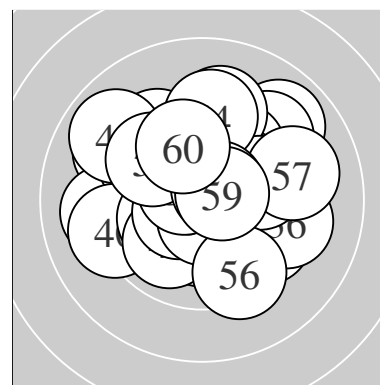

Serie 1:

10.9 *	9.3 ←	10.0 ↘	9.7 →	9.1 ↖
10.9 *	10.2 *	10.0 ↙	8.9 ↗	10.8 *

beste Teiler 5.3 (1.) 16.0 (6.) 40.0 (10.)

Trefferlage 0.30 mm links, 0.10 mm hoch

Streuwert 2.24, horizontal: 2.66, vertikal: 1.73

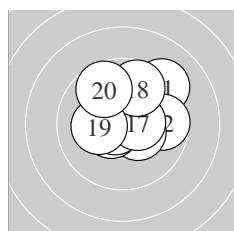

Serie 2:

9.2 ↗	9.7 →	10.7 *	10.4 *	10.5 *
10.7 *	10.5 *	9.7 ↑	10.2 *	9.7 ↘

beste Teiler 58.5 (13.) 62.2 (16.) 102.4 (15.)

Trefferlage 0.46 mm rechts, 0.79 mm hoch

Streuwert 1.63, horizontal: 1.78, vertikal: 1.47

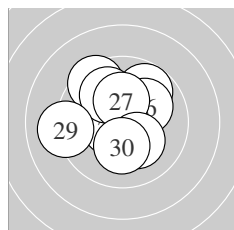

Serie 3:

10.6 *	9.8 ↗	10.5 *	9.5 ↘	10.0 ↘
10.1 ↗	10.3 *	10.2 *	9.1 ←	10.2 *

beste Teiler 87.1 (21.) 105.4 (23.) 173.2 (27.)

Trefferlage 0.35 mm links, 0.63 mm hoch

Streuwert 1.85, horizontal: 1.96, vertikal: 1.72

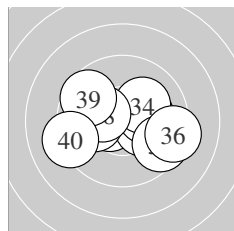

Serie 4:

10.5 *	10.3 *	10.2 *	10.1 ↗	9.6 ↘
9.3 →	10.1 ←	10.3 *	9.6 ↖	9.2 ←

beste Teiler 103.5 (31.) 170.1 (38.) 171.7 (32.)

Trefferlage 0.03 mm rechts, 0.11 mm tief

Streuwert 2.10, horizontal: 2.74, vertikal: 1.16

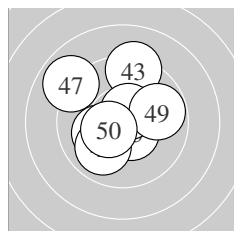

Serie 5:

10.2 *	10.1 ←	9.3 ↑	10.7 *	10.5 *
9.9 ↙	8.9 ↖	10.6 *	9.8 →	10.5 *

beste Teiler 59.3 (44.) 94.8 (48.) 107.1 (45.)

Trefferlage 0.53 mm links, 0.30 mm hoch

Streuwert 1.93, horizontal: 1.91, vertikal: 1.95

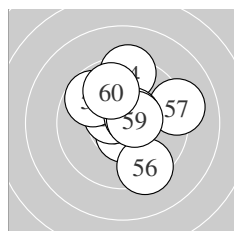

Serie 6:

10.6 *	10.2 *	10.5 *	9.3 ↑	9.7 ↘
9.4 ↘	9.1 →	10.6 *	10.6 *	9.9 ↘

beste Teiler 89.4 (51.) 95.6 (58.) 100.8 (59.)

Trefferlage 0.38 mm rechts, 0.86 mm hoch

Streuwert 1.92, horizontal: 1.81, vertikal: 2.03

Meyton Elektronik

ISSF AR Women Jun – Wertung – Juniorinnen

StandNr: 135

Vanoni, Larissa #118

StartNr: 82

21. Januar 2018 11:53

VLSV

Unterschrift des Schützen

Meyton Elektronik

Ergebnis: **627.2** (597)
 Serien: 102.7 104.8 104.9 105.1 105.1 104.6
 Zähler: 57 3 0 0 0 0 0 0 0
 Innenzehner: 54
 weiteste: 318 (1), 267 (30), 265 (3)
 beste Teiler 8.6 (56.) 22.4 (28.) 34.9 (29.)
 Trefferlage 0.09 mm rechts, 0.30 mm tief
 Streuwert 0.99, horizontal: 1.02, vertikal: 0.95

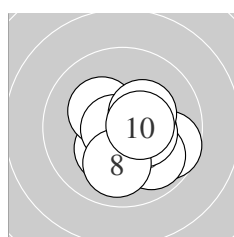
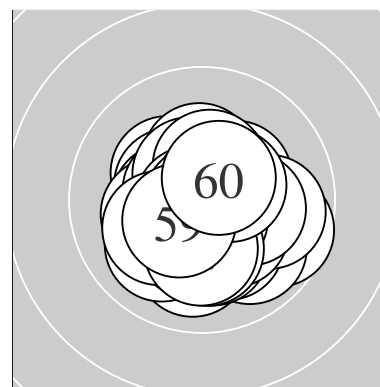

Serie 1:
 9.7 ↗ 10.3 * 9.9 ↘ 10.3 * 10.6 *
 10.4 * 10.7 * 10.0 ↓ 10.3 * 10.5 *
 beste Teiler 53.1 (7.) 82.3 (5.) 115.7 (10.)
 Trefferlage 0.61 mm rechts, 0.56 mm tief
 Streuwert 1.26, horizontal: 1.38, vertikal: 1.13

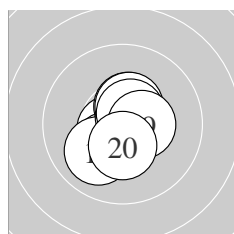

Serie 2:
 10.7 * 10.6 * 10.3 * 10.0 ✓ 10.5 *
 10.7 * 10.5 * 10.6 * 10.5 * 10.4 *
 beste Teiler 65.7 (11.) 65.7 (16.) 83.2 (12.)
 Trefferlage 0.09 mm links, 0.17 mm tief
 Streuwert 0.98, horizontal: 0.86, vertikal: 1.08

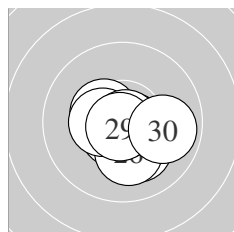

Serie 3:
 10.6 * 10.8 * 10.4 * 10.7 * 10.2 *
 10.2 * 10.4 * 10.9 * 10.8 * 9.9 →
 beste Teiler 22.4 (28.) 34.9 (29.) 46.5 (22.)
 Trefferlage 0.13 mm rechts, 0.53 mm tief
 Streuwert 0.97, horizontal: 1.14, vertikal: 0.76

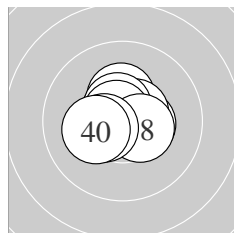

Serie 4:
 10.3 * 10.4 * 10.6 * 10.7 * 10.6 *
 10.7 * 10.7 * 10.5 * 10.4 * 10.2 *
 beste Teiler 59.2 (36.) 59.4 (37.) 71.6 (34.)
 Trefferlage 0.18 mm links, 0.22 mm hoch
 Streuwert 0.85, horizontal: 0.98, vertikal: 0.68

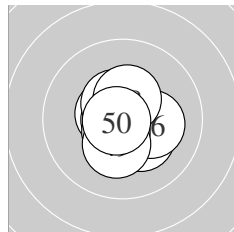

Serie 5:
 10.6 * 10.6 * 10.8 * 10.3 * 10.5 *
 10.2 * 10.6 * 10.4 * 10.3 * 10.8 *
 beste Teiler 41.7 (50.) 50.2 (43.) 77.8 (41.)
 Trefferlage 0.09 mm rechts, 0.18 mm tief
 Streuwert 0.91, horizontal: 0.89, vertikal: 0.92

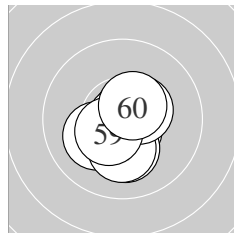

Serie 6:
 10.1 ↙ 10.6 * 10.7 * 10.4 * 10.2 *
 10.9 * 10.2 * 10.5 * 10.5 * 10.5 *
 beste Teiler 8.6 (56.) 54.4 (53.) 78.7 (52.)
 Trefferlage 0.00 mm , 0.61 mm tief
 Streuwert 0.91, horizontal: 0.79, vertikal: 1.02

Meyton Elektronik

ISSF AR Women Jun – Wertung – Juniorinnen

StartNr: 83

StandNr: 136

21. Januar 2018 11:34

Engler, Tal #68

ISR

Unterschrift des Schützen

Meyton Elektronik

Ergebnis: **619.7** (592)
 Serien: 102.0 102.9 104.3 102.0 104.9 103.6
 Zähler: 53 6 1 0 0 0 0 0 0
 Innenzehner: 49
 weiteste: 546 (32), 306 (5), 300 (7)
 beste Teiler 25.5 (35.) 32.3 (58.) 35.5 (6.)
 Trefferlage 0.12 mm rechts, 0.04 mm hoch
 Streuwert 1.28, horizontal: 1.35, vertikal: 1.20

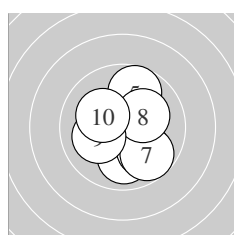
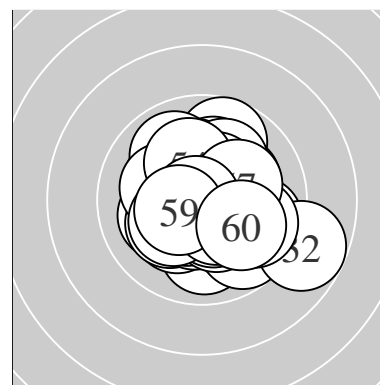

Serie 1:
 10.0 ↓ 10.8 * 9.9 ↘ 10.5 * 9.7 ↑
 10.8 * 9.8 ↘ 10.2 * 10.1 ← 10.2 *
 beste Teiler 35.5 (6.) 42.9 (2.) 104.5 (4.)
 Trefferlage 0.39 mm rechts, 0.21 mm tief
 Streuwert 1.54, horizontal: 1.39, vertikal: 1.67

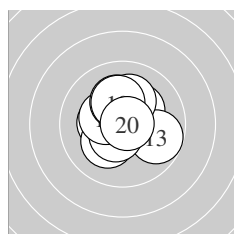

Serie 2:
 10.3 * 10.3 * 9.8 ↗ 10.2 * 10.5 *
 10.4 * 10.2 * 10.2 * 10.2 * 10.8 *
 beste Teiler 38.3 (20.) 106.5 (15.) 150.4 (16.)
 Trefferlage 0.06 mm links, 0.40 mm hoch
 Streuwert 1.31, horizontal: 1.35, vertikal: 1.26

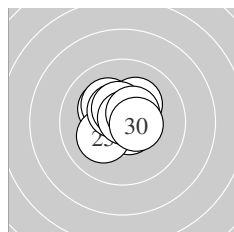

Serie 3:
 10.2 * 10.2 * 10.7 * 10.2 * 10.2 *
 10.5 * 10.5 * 10.8 * 10.5 * 10.5 *
 beste Teiler 39.0 (28.) 70.0 (23.) 112.6 (29.)
 Trefferlage 0.16 mm links, 0.54 mm hoch
 Streuwert 0.98, horizontal: 1.06, vertikal: 0.89

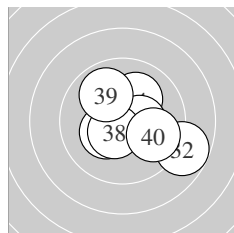

Serie 4:
 10.7 * 8.8 ↗ 10.6 * 10.1 ↑ 10.9 *
 10.3 * 10.4 * 10.5 * 9.9 ↘ 9.8 ↘
 beste Teiler 25.5 (35.) 66.7 (31.) 92.6 (33.)
 Trefferlage 0.57 mm rechts, 0.08 mm tief
 Streuwert 1.71, horizontal: 1.99, vertikal: 1.38

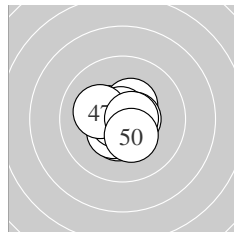

Serie 5:
 10.4 * 10.4 * 10.4 * 10.7 * 10.4 *
 10.8 * 10.2 * 10.6 * 10.7 * 10.3 *
 beste Teiler 47.4 (46.) 51.9 (44.) 74.1 (49.)
 Trefferlage 0.18 mm links, 0.09 mm tief
 Streuwert 0.91, horizontal: 0.96, vertikal: 0.86

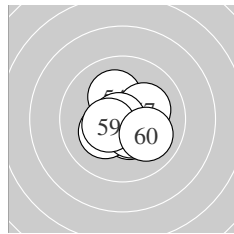

Serie 6:
 10.3 * 10.5 * 10.4 * 10.2 * 10.2 *
 10.5 * 10.2 * 10.8 * 10.5 * 10.0 ↘
 beste Teiler 32.3 (58.) 105.3 (52.) 123.2 (56.)
 Trefferlage 0.22 mm rechts, 0.27 mm tief
 Streuwert 1.14, horizontal: 1.25, vertikal: 1.02

Meyton Elektronik

ISSF AR Women Jun – Wertung – Juniorinnen

StandNr: 137

Kokoskova, Daniela #87

StartNr: 84

21. Januar 2018 11:50

CZE

Unterschrift des Schützen

Meyton Elektronik

Ergebnis: **619.0** (592)
 Serien: 101.1 104.8 104.2 103.0 102.8 103.1
 Zähler: 52 8 0 0 0 0 0 0 0
 Innenzehner: 46
 weiteste: 394 (6), 342 (14), 334 (4)
 beste Teiler 26.0 (15.) 35.0 (53.) 49.8 (59.)
 Trefferlage 0.04 mm rechts, 0.10 mm hoch
 Streuwert 1.26, horizontal: 1.58, vertikal: 0.84

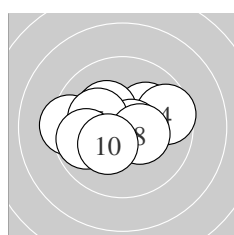
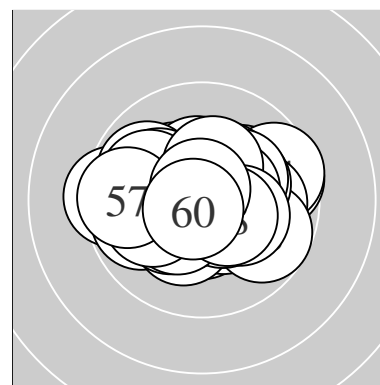

Serie 1:
 10.1 ↗ 10.3 * 10.3 * 9.6 → 10.7 *
 9.4 ← 10.2 * 10.4 * 9.8 ← 10.3 *
 beste Teiler 66.2 (5.) 137.7 (8.) 167.2 (10.)
 Trefferlage 0.53 mm links, 0.22 mm hoch
 Streuwert 1.67, horizontal: 2.19, vertikal: 0.89

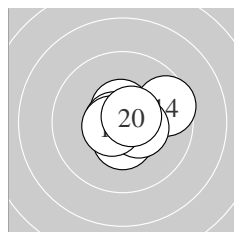

Serie 2:
 10.6 * 10.5 * 10.6 * 9.6 → 10.8 *
 10.7 * 10.4 * 10.4 * 10.6 * 10.6 *
 beste Teiler 26.0 (15.) 62.0 (16.) 77.9 (20.)
 Trefferlage 0.56 mm rechts, 0.00 mm
 Streuwert 0.96, horizontal: 1.15, vertikal: 0.73

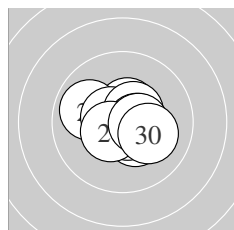

Serie 3:
 10.5 * 9.9 ↖ 10.6 * 10.5 * 10.4 *
 10.5 * 10.7 * 10.5 * 10.5 * 10.1 ↘
 beste Teiler 70.1 (27.) 95.8 (23.) 105.5 (26.)
 Trefferlage 0.23 mm rechts, 0.03 mm tief
 Streuwert 1.06, horizontal: 1.29, vertikal: 0.77

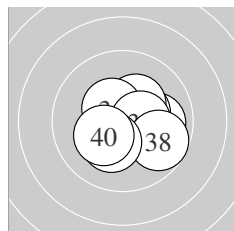

Serie 4:
 10.7 * 10.0 → 10.6 * 10.4 * 10.3 *
 10.5 * 10.4 * 9.7 ↘ 10.2 * 10.2 *
 beste Teiler 71.7 (31.) 90.1 (33.) 122.7 (36.)
 Trefferlage 0.57 mm rechts, 0.01 mm hoch
 Streuwert 1.23, horizontal: 1.40, vertikal: 1.04

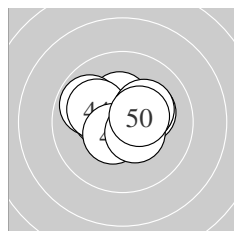

Serie 5:
 10.4 * 10.3 * 9.9 ↖ 10.1 ↖ 10.2 *
 10.3 * 10.5 * 10.5 * 10.2 * 10.4 *
 beste Teiler 113.7 (47.) 121.2 (48.) 131.2 (50.)
 Trefferlage 0.02 mm rechts, 0.53 mm hoch
 Streuwert 1.25, horizontal: 1.58, vertikal: 0.79

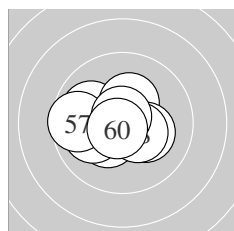

Serie 6:
 10.3 * 10.0 ← 10.8 * 10.0 ↖ 10.3 *
 10.2 * 9.6 ← 10.4 * 10.8 * 10.7 *
 beste Teiler 35.0 (53.) 49.8 (59.) 57.2 (60.)
 Trefferlage 0.61 mm links, 0.10 mm tief
 Streuwert 1.28, horizontal: 1.61, vertikal: 0.82

Meyton Elektronik

ISSF AR Women Jun – Wertung – Juniorinnen

StandNr: 138

Pavlova, Veronika #94

StartNr: 85

21. Januar 2018 11:51

RUS

Unterschrift des Schützen

Meyton Elektronik

Ergebnis:	599.7	(572)						
Serien:	101.7	99.5	98.9	101.1	101.1	97.4		
Zähler:	37	18	5	0	0	0	0	0
Innenzehner:	25							
weiteste:	518 (19), 518 (51), 516 (24)							
beste Teiler	28.6 (39.) 62.3 (41.) 81.4 (20.)							
Trefferlage	0.28 mm links, 0.24 mm tief							
Streuwert	1.90, horizontal: 1.88, vertikal: 1.91							

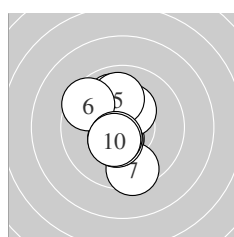
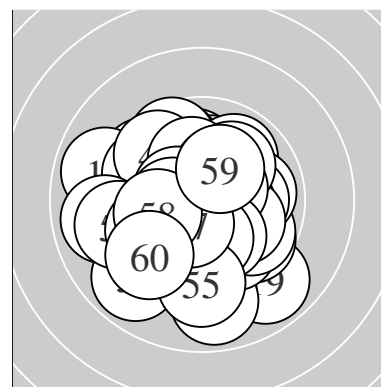

Serie 1:	10.0 ↗	10.5 *	10.5 *	10.3 *	10.0 ↗
	9.6 ↘	9.5 ↓	10.4 *	10.5 *	10.4 *
beste Teiler	105.7 (3.) 109.2 (9.) 120.8 (2.)				
Trefferlage	0.57 mm links, 0.06 mm tief				
Streuwert	1.56, horizontal: 1.01, vertikal: 1.96				

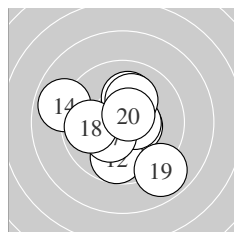

Serie 2:	10.5 *	9.7 ↓	10.5 *	8.9 ↘	10.1 ↑
	10.1 ↗	10.3 *	9.9 ←	8.9 ↘	10.6 *
beste Teiler	81.4 (20.) 103.2 (13.) 119.2 (11.)				
Trefferlage	0.21 mm links, 0.29 mm tief				
Streuwert	2.14, horizontal: 2.27, vertikal: 2.01				

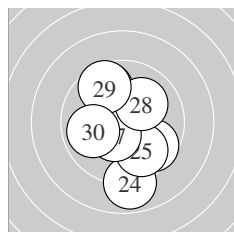

Serie 3:	10.3 *	10.5 *	9.7 ↘	8.9 ↓	9.8 ↘
	9.7 ↘	10.4 *	10.1 ↗	9.6 ↘	9.9 ←
beste Teiler	118.4 (22.) 128.7 (27.) 163.3 (21.)				
Trefferlage	0.09 mm rechts, 0.39 mm tief				
Streuwert	2.13, horizontal: 1.64, vertikal: 2.53				

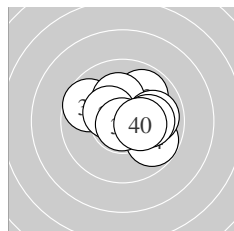

Serie 4:	9.7 ↘	10.0 →	9.9 ↗	9.8 ↘	10.2 *
	10.4 *	9.9 →	10.1 →	10.8 *	10.3 *
beste Teiler	28.6 (39.) 134.5 (36.) 152.2 (40.)				
Trefferlage	0.81 mm rechts, 0.35 mm hoch				
Streuwert	1.54, horizontal: 1.83, vertikal: 1.17				

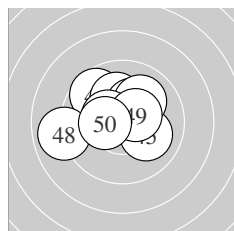

Serie 5:	10.7 *	9.7 ↘	10.1 ↗	10.3 *	10.1 ↘
	10.0 ↗	10.4 *	8.9 ←	10.5 *	10.4 *
beste Teiler	62.3 (41.) 124.8 (49.) 134.4 (47.)				
Trefferlage	0.46 mm links, 0.68 mm hoch				
Streuwert	1.71, horizontal: 2.11, vertikal: 1.18				

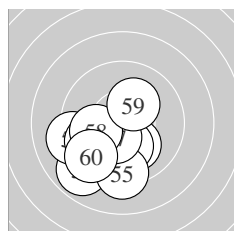

Serie 6:	8.9 ↗	9.2 ←	10.1 ↘	10.2 *	9.3 ↓
	9.7 ↗	10.4 *	10.0 ←	10.2 *	9.4 ↗
beste Teiler	135.0 (57.) 182.8 (59.) 198.4 (54.)				
Trefferlage	1.36 mm links, 1.78 mm tief				
Streuwert	1.79, horizontal: 1.91, vertikal: 1.66				

Meyton Elektronik

ISSF AR Women Jun – Wertung – Juniorinnen

StandNr: 139

Tschaudi, Angelina #93

StartNr: 86

21. Januar 2018 11:34

VSBL NWLZ

Unterschrift des Schützen

Meyton Elektronik

Ergebnis:	609.6	(582)							
Serien:	101.2	100.0	101.0	101.5	101.9	104.0			
Zähler:	44	14	2	0	0	0	0	0	0
Innenzehner:	35								
weiteste:	544 (36), 525 (23), 495 (41)								
beste Teiler	5.8 (44.)	17.0 (33.)	52.1 (39.)						
Trefferlage	0.02 mm rechts, 0.33 mm hoch								
Streuwert	1.64, horizontal: 1.73, vertikal: 1.53								

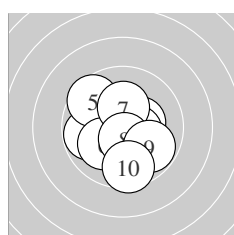
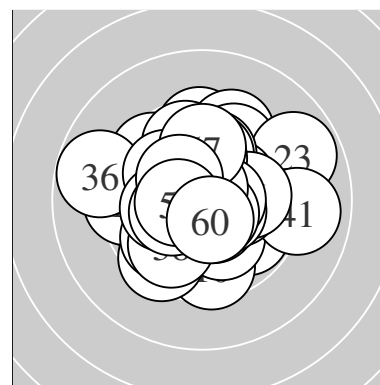

Serie 1:	9.8 ←	10.3 *	10.6 *	10.5 *	9.6 ↖
	10.1 ↙	10.3 *	10.6 *	9.8 ↘	9.6 ↓
beste Teiler	87.5 (3.)	100.2 (8.)	121.1 (4.)		
Trefferlage	0.11 mm links, 0.32 mm tief				
Streuwert	1.70, horizontal: 1.71, vertikal: 1.69				

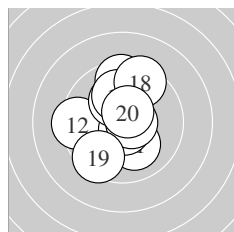

Serie 2:	10.1 ↘	9.4 ←	9.5 ↑	10.7 *	10.6 *
	10.2 *	10.0 ↑	9.4 ↑	9.5 ↙	10.6 *
beste Teiler	62.3 (14.)	78.1 (15.)	99.2 (20.)		
Trefferlage	0.33 mm links, 0.64 mm hoch				
Streuwert	1.92, horizontal: 1.61, vertikal: 2.19				

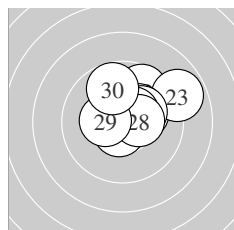

Serie 3:	10.2 *	9.7 ↗	8.9 ↘	10.3 *	10.2 *
	10.6 *	10.5 *	10.4 *	10.4 *	9.8 ↑
beste Teiler	79.8 (26.)	120.4 (27.)	137.6 (28.)		
Trefferlage	1.06 mm rechts, 1.09 mm hoch				
Streuwert	1.48, horizontal: 1.72, vertikal: 1.19				

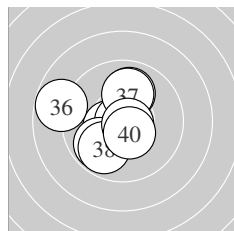

Serie 4:	10.4 *	10.0 ↑	10.9 *	10.6 *	9.8 ↙
	8.8 ←	10.0 ↑	9.8 ↙	10.7 *	10.5 *
beste Teiler	17.0 (33.)	52.1 (39.)	80.0 (34.)		
Trefferlage	0.79 mm links, 0.07 mm tief				
Streuwert	1.74, horizontal: 1.84, vertikal: 1.62				

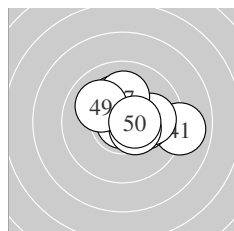

Serie 5:	9.0 →	10.5 *	10.2 *	10.9 *	10.2 *
	10.0 →	10.1 ↑	10.5 *	10.0 ↖	10.5 *
beste Teiler	5.8 (44.)	105.0 (50.)	113.1 (42.)		
Trefferlage	0.97 mm rechts, 0.46 mm hoch				
Streuwert	1.48, horizontal: 1.85, vertikal: 0.97				

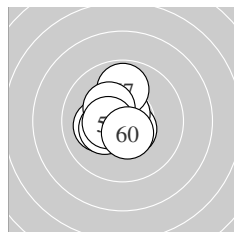

Serie 6:	10.6 *	10.7 *	10.1 ←	10.6 *	10.5 *
	10.3 *	9.9 ↑	10.3 *	10.5 *	10.5 *
beste Teiler	61.1 (52.)	98.9 (51.)	100.9 (54.)		
Trefferlage	0.63 mm links, 0.18 mm hoch				
Streuwert	1.03, horizontal: 0.90, vertikal: 1.15				

Meyton Elektronik

ISSF AR Women Jun – Wertung – Juniorinnen

StandNr: 140

Lepri, Virginia #113

StartNr: 87

21. Januar 2018 11:28

ITA

Unterschrift des Schützen

Meyton Elektronik

Ergebnis:	621.7	(596)					
Serien:	103.6	103.0	103.2	104.2	103.5	104.2	
Zähler:	56	4	0	0	0	0	0
Innenzehner:	45						
weiteste:	326 (15), 317 (24), 279 (29)						
beste Teiler	28.0 (47.) 29.9 (1.) 31.7 (51.)						
Trefferlage	0.07 mm links, 0.32 mm hoch						
Streuwert	1.15, horizontal: 1.23, vertikal: 1.06						

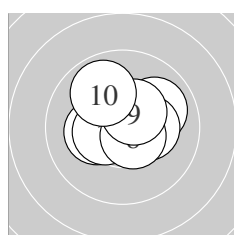
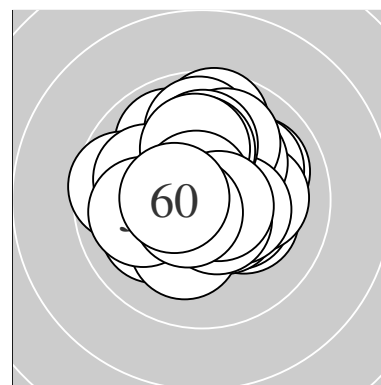

Serie 1:	10.8 *	10.4 *	10.0 ↗	10.5 *	10.3 *
	10.2 *	10.5 *	10.6 *	10.4 *	9.9 ↘
beste Teiler	29.9 (1.) 92.3 (8.) 103.8 (4.)				
Trefferlage	0.12 mm rechts, 0.41 mm hoch				
Streuwert	1.16, horizontal: 1.38, vertikal: 0.89				

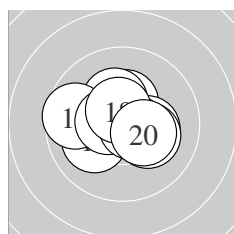

Serie 2:	10.4 *	10.3 *	10.3 *	10.1 ↙	9.6 ←
	10.5 *	10.7 *	10.6 *	10.2 *	10.3 *
beste Teiler	65.5 (17.) 98.0 (18.) 101.6 (16.)				
Trefferlage	0.13 mm links, 0.18 mm hoch				
Streuwert	1.31, horizontal: 1.61, vertikal: 0.92				

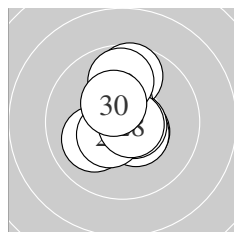

Serie 3:	10.5 *	10.1 ↙	10.5 *	9.7 ↑	10.6 *
	10.4 *	10.5 *	10.7 *	9.8 ↑	10.4 *
beste Teiler	60.4 (28.) 79.4 (25.) 115.9 (21.)				
Trefferlage	0.00 mm , 0.47 mm hoch				
Streuwert	1.29, horizontal: 0.93, vertikal: 1.57				

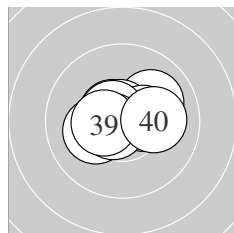

Serie 4:	10.5 *	10.0 ↗	10.6 *	10.7 *	10.4 *
	10.6 *	10.2 *	10.7 *	10.4 *	10.1 →
beste Teiler	60.7 (34.) 74.4 (38.) 85.0 (36.)				
Trefferlage	0.11 mm links, 0.18 mm hoch				
Streuwert	1.07, horizontal: 1.41, vertikal: 0.56				

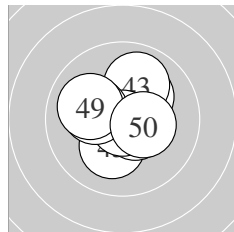

Serie 5:	10.6 *	10.2 *	10.0 ↑	10.6 *	10.2 *
	10.5 *	10.8 *	10.2 *	10.0 ↙	10.4 *
beste Teiler	28.0 (47.) 81.4 (44.) 95.5 (41.)				
Trefferlage	0.01 mm rechts, 0.20 mm hoch				
Streuwert	1.24, horizontal: 1.27, vertikal: 1.21				

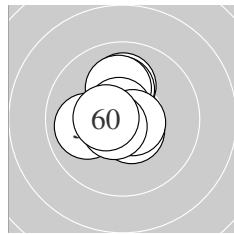

Serie 6:	10.8 *	10.6 *	10.1 ↑	10.0 ←	10.1 ↑
	10.1 ↑	10.7 *	10.7 *	10.6 *	10.5 *
beste Teiler	31.7 (51.) 62.7 (57.) 72.4 (58.)				
Trefferlage	0.34 mm links, 0.46 mm hoch				
Streuwert	1.06, horizontal: 0.89, vertikal: 1.20				

Meyton Elektronik

ISSF AR Women Jun – Wertung – Juniorinnen

StandNr: 141

Helesicova, Barbara #204

StartNr: 88

21. Januar 2018 11:42

CZE

Unterschrift des Schützen

Meyton Elektronik

Ergebnis: **618.7** (591)
 Serien: 102.4 105.3 103.7 101.8 103.8 101.7
 Zähler: 51 9 0 0 0 0 0 0 0
 Innenzehner: 44
 weiteste: 406 (60), 381 (40), 367 (58)
 beste Teiler 8.4 (53.) 14.8 (16.) 37.8 (46.)
 Trefferlage 0.09 mm links, 0.02 mm tief
 Streuwert 1.31, horizontal: 1.46, vertikal: 1.14

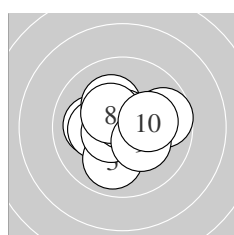
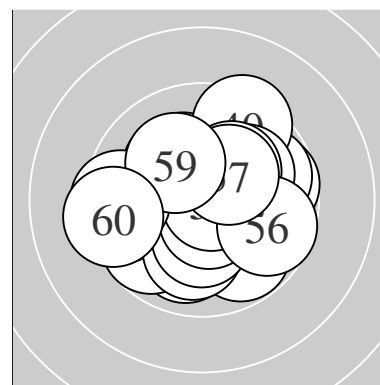

Serie 1:
 10.1 ← 10.2 * 10.0 ↓ 10.2 * 9.7 →
 10.6 * 10.7 * 10.4 * 10.3 * 10.2 *
 beste Teiler 57.5 (7.) 94.4 (6.) 136.8 (8.)
 Trefferlage 0.10 mm links, 0.05 mm hoch
 Streuwert 1.45, horizontal: 1.69, vertikal: 1.15

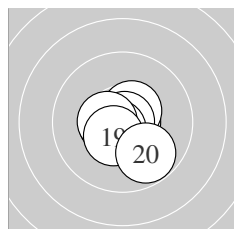

Serie 2:
 10.6 * 10.6 * 10.7 * 10.5 * 10.5 *
 10.9 * 10.7 * 10.5 * 10.5 * 9.8 ↘
 beste Teiler 14.8 (16.) 60.0 (13.) 72.9 (17.)
 Trefferlage 0.12 mm links, 0.44 mm tief
 Streuwert 0.87, horizontal: 0.90, vertikal: 0.84

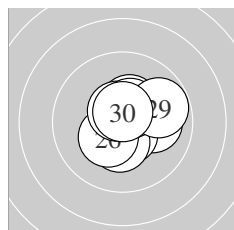

Serie 3:
 10.5 * 10.4 * 10.1 → 10.6 * 10.3 *
 10.3 * 10.6 * 10.5 * 9.8 → 10.6 *
 beste Teiler 78.0 (30.) 90.8 (27.) 99.0 (24.)
 Trefferlage 0.51 mm rechts, 0.25 mm hoch
 Streuwert 1.10, horizontal: 1.15, vertikal: 1.06

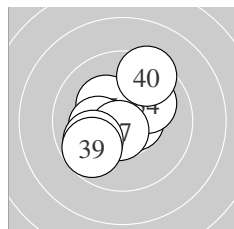

Serie 4:
 10.3 * 10.6 * 10.7 * 10.1 ↗ 10.3 *
 10.2 * 10.6 * 9.9 ↙ 9.7 ↙ 9.4 ↗
 beste Teiler 58.6 (33.) 76.3 (37.) 86.0 (32.)
 Trefferlage 0.29 mm links, 0.24 mm hoch
 Streuwert 1.58, horizontal: 1.57, vertikal: 1.59

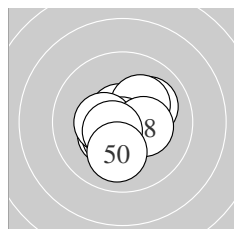

Serie 5:
 10.4 * 10.7 * 10.1 ↗ 10.4 * 10.2 *
 10.8 * 10.4 * 10.3 * 10.5 * 10.0 ↓
 beste Teiler 37.8 (46.) 66.3 (42.) 101.4 (49.)
 Trefferlage 0.00 mm, 0.26 mm tief
 Streuwert 1.13, horizontal: 1.18, vertikal: 1.08

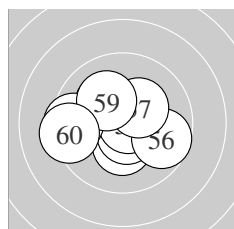

Serie 6:
 10.2 * 10.3 * 10.9 * 10.6 * 10.8 *
 9.7 → 10.3 * 9.5 ← 10.1 ↘ 9.3 ←
 beste Teiler 8.4 (53.) 42.1 (55.) 90.4 (54.)
 Trefferlage 0.54 mm links, 0.02 mm tief
 Streuwert 1.69, horizontal: 2.11, vertikal: 1.13

ISSF AR Women Jun – Wertung – Juniorinnen

StandNr: 142

Müller, Victoria #116

StartNr: 89

21. Januar 2018 11:39

AUT

Unterschrift des Schützen

Meyton Elektronik

Ergebnis: **600.7** (573)

Serien: 99.8 101.1 101.6 99.8 99.5 98.9

Zähler: 34 25 1 0 0 0 0 0 0

Innenzehner: 27

weiteste: 526 (19), 455 (27), 436 (31)

beste Teiler 10.8 (55.) 61.2 (26.) 61.6 (18.)

Trefferlage 0.34 mm links, 0.96 mm hoch

Streuwert 1.77, horizontal: 1.66, vertikal: 1.86

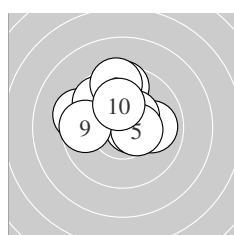
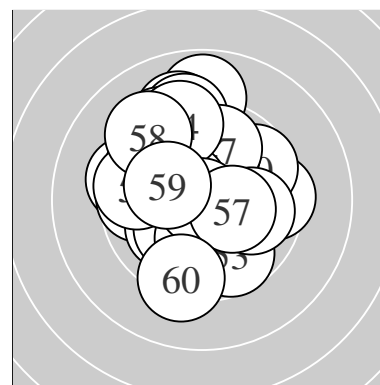

Serie 1:

10.0 →	10.7 *	9.6 ↑	10.4 *	10.5 *
9.4 ←	9.8 ↘	9.5 ↑	9.7 ←	10.2 *

beste Teiler 70.0 (2.) 123.7 (5.) 133.6 (4.)

Trefferlage 0.45 mm links, 1.32 mm hoch

Streuwert 1.75, horizontal: 2.01, vertikal: 1.45

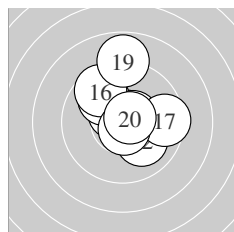

Serie 2:

10.5 *	10.1 ↘	10.7 *	9.9 ↘	10.6 *
9.6 ↘	9.5 →	10.7 *	8.8 ↑	10.7 *

beste Teiler 61.6 (18.) 63.4 (13.) 73.0 (20.)

Trefferlage 0.31 mm rechts, 1.00 mm hoch

Streuwert 1.76, horizontal: 1.60, vertikal: 1.91

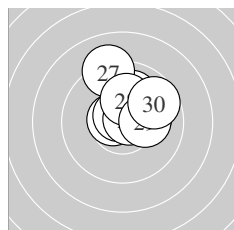

Serie 3:

10.2 *	10.6 *	10.0 ↑	10.2 *	10.7 *
10.7 *	9.1 ↑	10.2 *	10.2 *	9.7 ↗

beste Teiler 61.2 (26.) 64.8 (25.) 85.6 (22.)

Trefferlage 0.77 mm rechts, 1.23 mm hoch

Streuwert 1.34, horizontal: 1.32, vertikal: 1.35

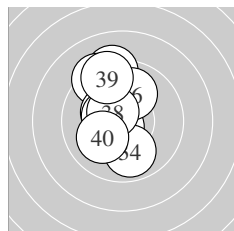

Serie 4:

9.2 ↑	10.7 *	9.3 ↘	9.9 ↓	10.3 *
10.0 ↑	10.4 *	10.5 *	9.4 ↗	10.1 ↖

beste Teiler 62.6 (32.) 116.0 (38.) 137.2 (37.)

Trefferlage 0.86 mm links, 1.14 mm hoch

Streuwert 1.76, horizontal: 0.95, vertikal: 2.30

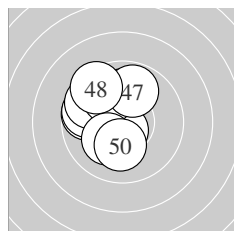

Serie 5:

9.7 ←	10.0 ↑	10.7 *	9.7 ←	9.7 ↘
10.0 ↘	9.8 ↑	9.5 ↘	10.2 *	10.2 *

beste Teiler 72.0 (43.) 194.8 (49.) 198.0 (50.)

Trefferlage 1.29 mm links, 0.91 mm hoch

Streuwert 1.59, horizontal: 1.41, vertikal: 1.76

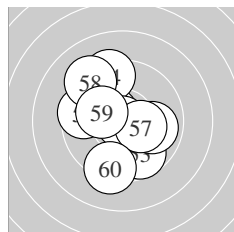

Serie 6:

9.6 ←	10.5 *	9.7 ↘	9.3 ↑	10.9 *
9.9 →	10.3 *	9.2 ↘	10.2 *	9.3 ↓

beste Teiler 10.8 (55.) 113.8 (52.) 163.2 (57.)

Trefferlage 0.55 mm links, 0.14 mm hoch

Streuwert 2.18, horizontal: 1.93, vertikal: 2.41

ISSF AR Women Jun – Wertung – Juniorinnen

StandNr: 143

Leopold, Magdalena #205

StartNr: 90

21. Januar 2018 11:12

T – SG Aschau

Unterschrift des Schützen

Meyton Elektronik

Ergebnis: **623.0** (593)
 Serien: 104.5 104.8 103.3 104.7 102.6 103.1
 Zähler: 53 7 0 0 0 0 0 0 0
 Innenzehner: 47
 weiteste: 305 (47), 296 (50), 277 (24)
 beste Teiler 12.0 (43.) 46.4 (14.) 46.6 (8.)
 Trefferlage 0.23 mm rechts, 0.21 mm hoch
 Streuwert 1.11, horizontal: 1.16, vertikal: 1.06

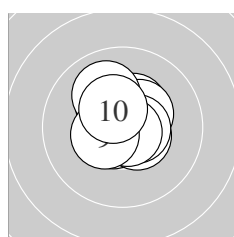
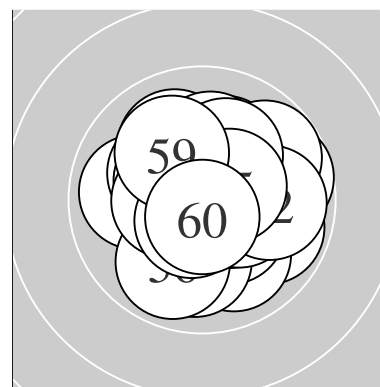

Serie 1:
 10.6 * 10.4 * 10.3 * 10.4 * 10.5 *
 10.0 ↘ 10.6 * 10.8 * 10.5 * 10.4 *
 beste Teiler 46.6 (8.) 77.6 (1.) 90.6 (7.)
 Trefferlage 0.03 mm links, 0.48 mm hoch
 Streuwert 0.95, horizontal: 0.91, vertikal: 0.98

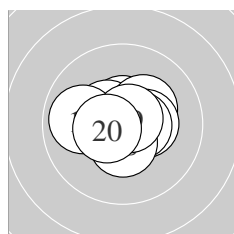

Serie 2:
 10.6 * 10.5 * 10.3 * 10.8 * 10.4 *
 10.6 * 9.9 ← 10.5 * 10.7 * 10.5 *
 beste Teiler 46.4 (14.) 54.4 (19.) 93.0 (11.)
 Trefferlage 0.07 mm links, 0.14 mm hoch
 Streuwert 0.99, horizontal: 1.24, vertikal: 0.66

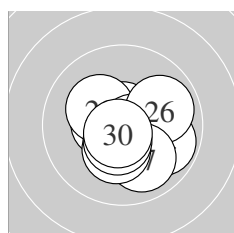

Serie 3:
 10.5 * 10.7 * 10.2 * 9.8 ↗ 10.7 *
 9.9 → 10.0 ↘ 10.3 * 10.5 * 10.7 *
 beste Teiler 59.0 (22.) 63.1 (30.) 75.0 (25.)
 Trefferlage 0.32 mm rechts, 0.37 mm tief
 Streuwert 1.25, horizontal: 1.39, vertikal: 1.09

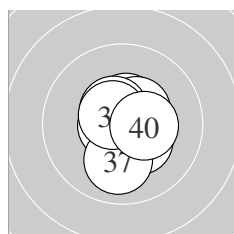

Serie 4:
 10.7 * 10.6 * 10.5 * 10.5 * 10.4 *
 10.5 * 10.0 ↓ 10.5 * 10.6 * 10.4 *
 beste Teiler 70.5 (31.) 87.7 (39.) 91.8 (32.)
 Trefferlage 0.32 mm rechts, 0.07 mm tief
 Streuwert 0.94, horizontal: 0.82, vertikal: 1.05

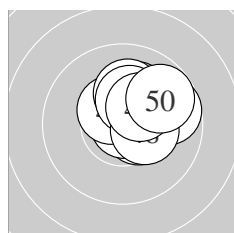

Serie 5:
 10.1 ↗ 10.5 * 10.9 * 10.5 * 10.1 ↑
 10.3 * 9.7 → 10.4 * 10.3 * 9.8 ↗
 beste Teiler 12.0 (43.) 112.5 (42.) 118.0 (44.)
 Trefferlage 1.00 mm rechts, 0.91 mm hoch
 Streuwert 1.00, horizontal: 1.09, vertikal: 0.91

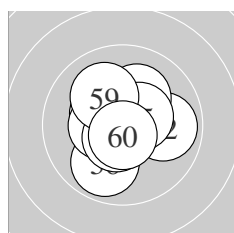

Serie 6:
 10.4 * 9.9 → 10.4 * 10.2 * 10.5 *
 9.9 ↘ 10.4 * 10.6 * 10.1 ↘ 10.7 *
 beste Teiler 67.0 (60.) 91.6 (58.) 121.1 (55.)
 Trefferlage 0.11 mm links, 0.19 mm hoch
 Streuwert 1.31, horizontal: 1.31, vertikal: 1.31

Meyton Elektronik

ISSF AR Women Jun – Wertung – Juniorinnen

StandNr: 144

Dereviagina, Anastasiia #77

StartNr: 91

21. Januar 2018 11:18

RUS

Unterschrift des Schützen

Meyton Elektronik

Ergebnis:	595.8	(567)							
Serien:	101.1	101.3	101.7	97.0	98.5	96.2			
Zähler:	32	24	3	1	0	0	0	0	0
Innenzehner:	25								
weiteste:	897 (51), 653 (58), 577 (49)								
beste Teiler	2.0 (18.) 24.0 (29.) 37.0 (22.)								
Trefferlage	0.23 mm rechts, 0.09 mm hoch								
Streuwert	2.16, horizontal: 2.62, vertikal: 1.58								

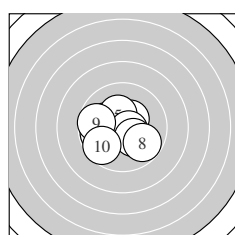
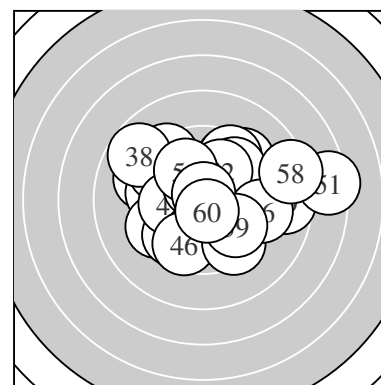

Serie 1:

9.8 ←	10.4 *	10.1 ↖	10.4 *	10.3 *
10.6 *	10.3 *	9.8 ↘	9.7 ←	9.7 ↙
beste Teiler	77.8 (6.) 129.3 (4.) 130.9 (2.)			
Trefferlage	0.69 mm links, 0.21 mm tief			
Streuwert	1.60, horizontal: 1.90, vertikal: 1.24			

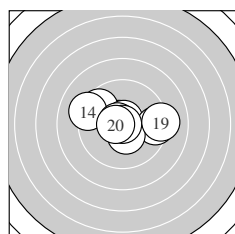

Serie 2:

10.7 *	9.6 ↖	10.7 *	9.2 ↖	10.7 *
9.4 →	10.4 *	10.9 *	9.1 →	10.6 *
beste Teiler	2.0 (18.) 57.7 (13.) 65.7 (15.)			
Trefferlage	0.01 mm rechts, 0.35 mm hoch			
Streuwert	1.95, horizontal: 2.61, vertikal: 0.89			

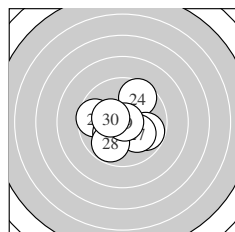

Serie 3:

9.6 ←	10.8 *	10.5 *	9.6 ↗	10.2 *
9.8 ↘	10.1 ↘	9.8 ↙	10.9 *	10.4 *
beste Teiler	24.0 (29.) 37.0 (22.) 113.4 (23.)			
Trefferlage	0.02 mm rechts, 0.29 mm tief			
Streuwert	1.66, horizontal: 1.84, vertikal: 1.45			

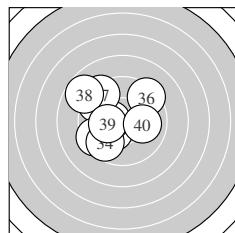

Serie 4:

9.5 ↖	10.3 *	9.5 ↙	9.7 ↙	10.4 *
9.4 ↗	9.3 ↖	8.7 ↖	10.2 *	10.0 →
beste Teiler	133.4 (35.) 165.5 (32.) 180.6 (39.)			
Trefferlage	1.44 mm links, 0.51 mm hoch			
Streuwert	2.25, horizontal: 2.35, vertikal: 2.15			

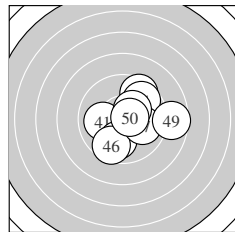

Serie 5:

10.0 ←	10.3 *	9.5 ↗	9.7 ↗	9.9 ↓
9.6 ↙	10.0 →	10.3 *	8.6 →	10.6 *
beste Teiler	87.3 (50.) 160.5 (48.) 167.8 (42.)			
Trefferlage	1.16 mm rechts, 0.00 mm			
Streuwert	2.08, horizontal: 2.26, vertikal: 1.88			

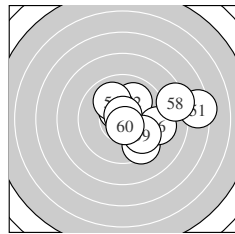

Serie 6:

7.4 →	10.0 ↗	10.5 *	10.0 ↖	9.5 ↘
9.3 →	10.8 *	8.3 →	9.8 ↘	10.6 *
beste Teiler	43.1 (57.) 82.8 (60.) 114.3 (53.)			
Trefferlage	2.34 mm rechts, 0.23 mm hoch			
Streuwert	2.60, horizontal: 3.22, vertikal: 1.78			

Meyton Elektronik

ISSF AR Women Jun – Wertung – Juniorinnen

StandNr: 145

Fölzer, Verona #69

StartNr: 92

21. Januar 2018 11:39

AUT

Unterschrift des Schützen

Meyton Elektronik

Ergebnis: **607.3** (580)

Serien: 100.4 101.6 102.5 101.5 102.9 98.4

Zähler: 42 16 2 0 0 0 0 0 0 0

Innenzehner: 35

weiteste: 614 (40), 537 (55), 491 (10)

beste Teiler 10.7 (16.) 11.4 (28.) 51.8 (43.)

Trefferlage 0.31 mm links, 0.55 mm hoch

Streuwert 1.69, horizontal: 1.95, vertikal: 1.38

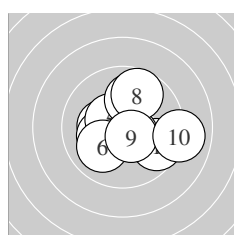
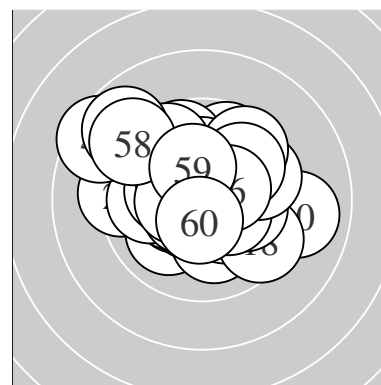

Serie 1:

9.6 ↘	10.3 *	10.6 *	10.2 *	10.5 *
10.0 ↙	10.0 ↑	9.7 ↑	10.5 *	9.0 →

beste Teiler 99.8 (3.) 108.2 (9.) 119.2 (5.)

Trefferlage 0.51 mm rechts, 0.00 mm

Streuwert 1.88, horizontal: 2.18, vertikal: 1.53

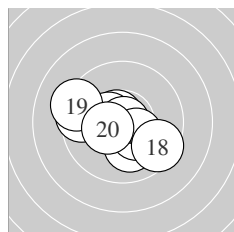

Serie 2:

9.5 ←	10.4 *	10.1 ↓	10.7 *	10.5 *
10.9 *	10.3 *	9.5 ↘	9.3 ↖	10.4 *

beste Teiler 10.7 (16.) 74.2 (14.) 123.7 (15.)

Trefferlage 0.50 mm links, 0.40 mm tief

Streuwert 1.71, horizontal: 2.12, vertikal: 1.18

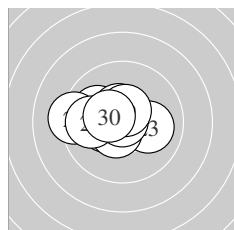

Serie 3:

10.3 *	10.0 ↖	10.1 →	9.3 ←	10.6 *
9.9 ←	10.5 *	10.9 *	10.5 *	10.4 *

beste Teiler 11.4 (28.) 100.9 (25.) 102.6 (29.)

Trefferlage 1.01 mm links, 0.23 mm hoch

Streuwert 1.33, horizontal: 1.76, vertikal: 0.65

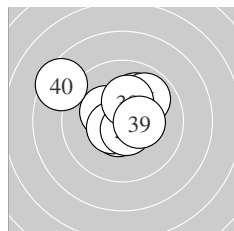

Serie 4:

10.6 *	10.4 *	10.3 *	10.1 ↗	10.5 *
9.9 ↗	10.6 *	10.2 *	10.4 *	8.5 ↖

beste Teiler 78.7 (37.) 89.5 (31.) 104.0 (35.)

Trefferlage 0.19 mm links, 0.84 mm hoch

Streuwert 1.75, horizontal: 2.07, vertikal: 1.35

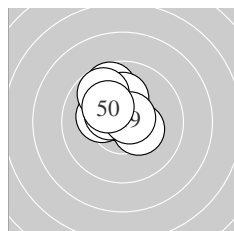

Serie 5:

9.7 ↖	10.7 *	10.7 *	10.2 *	10.4 *
10.1 ↑	9.8 ↖	10.4 *	10.7 *	10.2 *

beste Teiler 51.8 (43.) 69.9 (49.) 72.1 (42.)

Trefferlage 0.41 mm links, 1.06 mm hoch

Streuwert 1.09, horizontal: 1.09, vertikal: 1.09

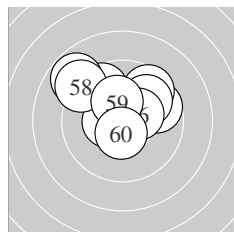

Serie 6:

9.7 ↗	9.6 ↖	9.6 ↗	9.9 ↗	8.8 ↖
10.4 *	10.5 *	9.1 ↖	10.3 *	10.5 *

beste Teiler 105.8 (60.) 125.1 (57.) 144.5 (56.)

Trefferlage 0.27 mm links, 1.61 mm hoch

Streuwert 1.99, horizontal: 2.41, vertikal: 1.47

Meyton Elektronik

ISSF AR Women Jun – Wertung – Juniorinnen

StandNr: 146

Schwarzenauer, Cornelia #206

StartNr: 93

21. Januar 2018 11:08

T – SG Fieberbrunn

Unterschrift des Schützen

Meyton Elektronik