

Ergebnis: **401.5** (385)
 Serien: 101.2 103.1 98.1 99.1
 Zähler: 25 15 0 0 0 0 0 0 0 0
 Innenzehner: 17
 weiteste: 486 (25), 484 (22), 479 (33)
 beste Teiler 52.4 (16.) 55.0 (26.) 63.0 (37.)
 Trefferlage 0.28 mm rechts, 0.32 mm hoch
 Streuwert 1.84, horizontal: 2.12, vertikal: 1.50

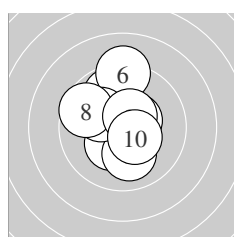

Serie 1:
 9.8 ↗ 10.5 * 10.7 * 10.3 * 10.1 ↓
 9.2 ↑ 10.1 ↘ 9.6 ↘ 10.5 * 10.4 *
 beste Teiler 71.1 (3.) 109.0 (9.) 116.7 (2.)
 Trefferlage 0.28 mm links, 0.63 mm hoch
 Streuwert 1.68, horizontal: 1.35, vertikal: 1.95

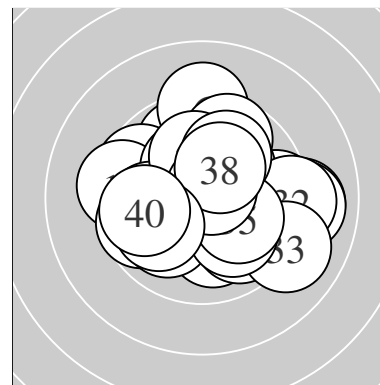
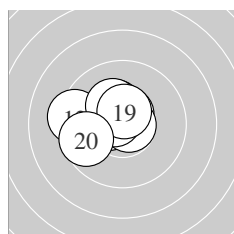

Serie 2:
 10.6 * 10.5 * 9.4 ← 10.5 * 10.3 *
 10.7 * 10.6 * 10.3 * 10.5 * 9.7 ←
 beste Teiler 52.4 (16.) 77.8 (17.) 86.9 (11.)
 Trefferlage 0.91 mm links, 0.56 mm hoch
 Streuwert 1.19, horizontal: 1.46, vertikal: 0.82

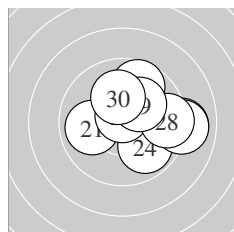

Serie 3:
 9.9 ← 9.0 → 10.1 ↗ 9.9 ↘ 9.0 →
 10.7 * 9.7 ↗ 9.5 → 10.2 * 10.1 ↑
 beste Teiler 55.0 (26.) 200.8 (29.) 203.4 (23.)
 Trefferlage 1.58 mm rechts, 0.58 mm hoch
 Streuwert 1.96, horizontal: 2.34, vertikal: 1.47

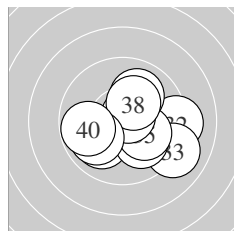

Serie 4:
 10.0 ↙ 9.2 → 9.0 ↘ 10.1 ↘ 10.1 ↘
 10.0 ↗ 10.7 * 10.3 * 9.9 ↙ 9.8 ←
 beste Teiler 63.0 (37.) 173.5 (38.) 205.4 (35.)
 Trefferlage 0.77 mm rechts, 0.49 mm tief
 Streuwert 2.01, horizontal: 2.45, vertikal: 1.45

Unterschrift des Schützen

Ergebnis: **361.7** (339)
 Serien: 95.6 91.3 88.7 86.1
 Zähler: 4 17 14 4 1 0 0 0 0 0
 Innenzehner: 4
 weiteste: 1224 (28), 893 (39), 862 (37)
 beste Teiler 17.0 (1.) 71.8 (15.) 81.1 (10.)
 Trefferlage 0.31 mm rechts, 0.45 mm hoch
 Streuwert 3.81, horizontal: 4.65, vertikal: 2.73

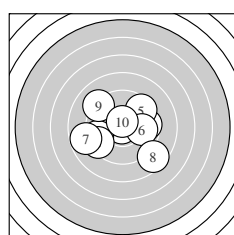
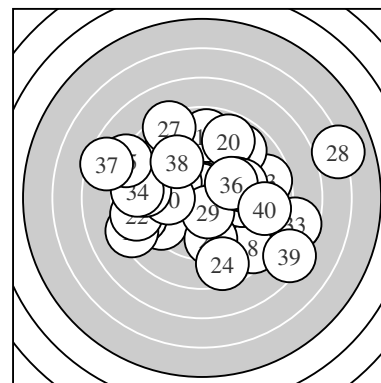

Serie 1:
 10.9 * 9.4 ← 9.3 ← 9.6 → 9.5 ↗
 9.9 → 8.8 ← 8.5 ↘ 9.1 ↖ 10.6 *
 beste Teiler 17.0 (1.) 81.1 (10.) 275.1 (6.)
 Trefferlage 0.27 mm links, 0.30 mm tief
 Streuwert 2.87, horizontal: 3.45, vertikal: 2.16

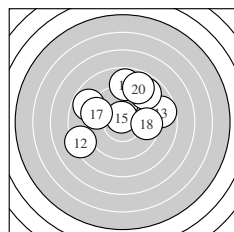

Serie 2:
 9.3 → 8.3 ← 8.7 → 8.8 ↖ 10.7 *
 8.9 ↗ 9.4 ← 9.6 → 8.8 ↑ 8.8 ↗
 beste Teiler 71.8 (15.) 342.7 (18.) 390.8 (17.)
 Trefferlage 0.41 mm rechts, 1.79 mm hoch
 Streuwert 3.33, horizontal: 4.01, vertikal: 2.47

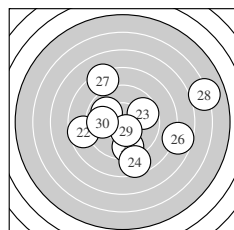

Serie 3:
 9.5 ↓ 8.7 ← 9.7 → 8.6 ↓ 9.9 ↖
 7.7 → 8.3 ↖ 6.1 → 10.4 * 9.8 ←
 beste Teiler 130.0 (29.) 262.9 (25.) 286.0 (30.)
 Trefferlage 1.18 mm rechts, 0.15 mm tief
 Streuwert 4.43, horizontal: 5.24, vertikal: 3.44

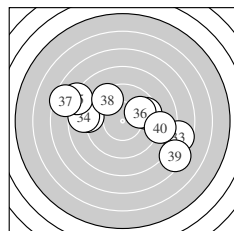

Serie 4:
 9.6 → 9.0 ← 7.7 → 8.7 ← 8.1 ↖
 9.8 → 7.5 ← 9.5 ↖ 7.4 ↘ 8.8 →
 beste Teiler 278.6 (36.) 350.6 (31.) 375.0 (38.)
 Trefferlage 0.06 mm links, 0.47 mm hoch
 Streuwert 4.66, horizontal: 6.06, vertikal: 2.57

Unterschrift des Schützen

Meyton Elektronik

Ergebnis: **401.8** (382)
 Serien: 98.3 102.7 100.1 100.7
 Zähler: 24 14 2 0 0 0 0 0 0 0
 Innenzehner: 17
 weiteste: 680 (1), 537 (31), 488 (28)
 beste Teiler 31.2 (20.) 36.2 (19.) 66.8 (5.)
 Trefferlage 0.31 mm links, 0.10 mm hoch
 Streuwert 1.85, horizontal: 2.09, vertikal: 1.57

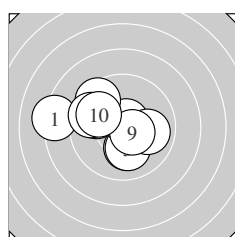
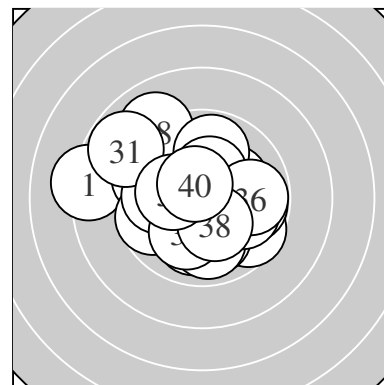

Serie 1:
 8.2 ← 10.1 ↓ 10.1 ↓ 9.8 ↖ 10.7 *
 9.5 ↘ 9.9 → 9.6 ↖ 10.5 * 9.9 ↖
 beste Teiler 66.8 (5.) 108.7 (9.) 206.3 (2.)
 Trefferlage 1.26 mm links, 0.26 mm hoch
 Streuwert 2.18, horizontal: 2.69, vertikal: 1.51

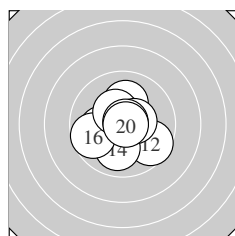

Serie 2:
 10.7 * 9.6 ↘ 10.1 ← 10.0 ↓ 10.1 ↑
 9.7 ← 10.4 * 10.5 * 10.8 * 10.8 *
 beste Teiler 31.2 (20.) 36.2 (19.) 72.2 (11.)
 Trefferlage 0.06 mm links, 0.22 mm tief
 Streuwert 1.47, horizontal: 1.60, vertikal: 1.33

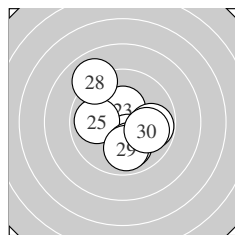

Serie 3:
 10.6 * 10.3 * 10.4 * 10.3 * 9.9 ←
 10.0 ↓ 9.8 → 9.0 ↘ 9.9 ↓ 9.9 →
 beste Teiler 90.3 (21.) 132.0 (23.) 156.2 (24.)
 Trefferlage 0.07 mm rechts, 0.17 mm tief
 Streuwert 1.90, horizontal: 1.88, vertikal: 1.92

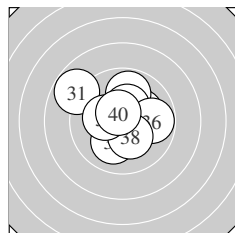

Serie 4:
 8.8 ↘ 10.4 * 10.2 * 9.9 ↑ 10.4 *
 9.8 → 10.1 ↓ 10.3 * 10.2 * 10.6 *
 beste Teiler 93.4 (40.) 126.4 (32.) 148.0 (35.)
 Trefferlage 0.00 mm, 0.54 mm hoch
 Streuwert 1.84, horizontal: 2.07, vertikal: 1.59

Unterschrift des Schützen

Meyton Elektronik

Ergebnis: **413.0** (395)^{QF}
 Serien: 102.9 102.9 104.5 102.7
 Zähler: 35 5 0 0 0 0 0 0 0 0
 Innenzehner: 31
 weiteste: 351 (32), 333 (18), 300 (11)
 beste Teiler 25.0 (14.) 31.3 (22.) 40.0 (15.)
 Trefferlage 0.21 mm rechts, 0.10 mm hoch
 Streuwert 1.24, horizontal: 1.31, vertikal: 1.17

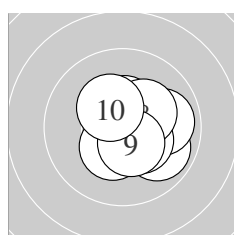
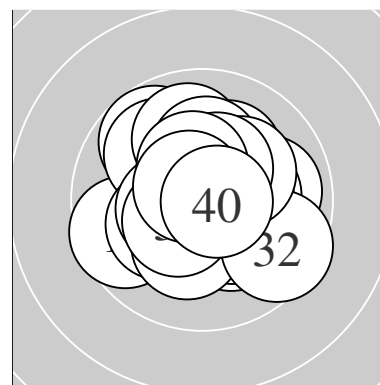

Serie 1:
 10.1 ↘ 10.4 * 10.5 * 9.9 ↘ 9.9 →
 10.6 * 10.4 * 10.3 * 10.5 * 10.3 *
 beste Teiler 93.6 (6.) 119.4 (9.) 120.5 (3.)
 Trefferlage 0.92 mm rechts, 0.13 mm tief
 Streuwert 1.12, horizontal: 1.15, vertikal: 1.08

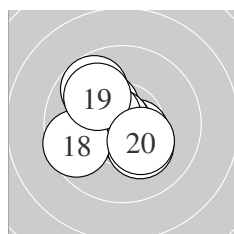

Serie 2:
 9.8 ↖ 10.3 * 10.5 * 10.9 * 10.8 *
 10.2 * 10.5 * 9.6 ← 10.0 ↖ 10.3 *
 beste Teiler 25.0 (14.) 40.0 (15.) 105.1 (13.)
 Trefferlage 0.62 mm links, 0.14 mm hoch
 Streuwert 1.37, horizontal: 1.42, vertikal: 1.31

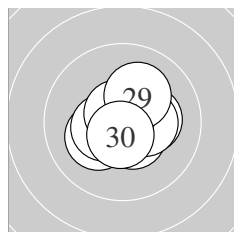

Serie 3:
 10.2 * 10.8 * 10.3 * 10.5 * 10.5 *
 10.4 * 10.4 * 10.7 * 10.1 ↗ 10.6 *
 beste Teiler 31.3 (22.) 67.2 (28.) 86.3 (30.)
 Trefferlage 0.25 mm rechts, 0.00 mm
 Streuwert 1.00, horizontal: 1.13, vertikal: 0.84

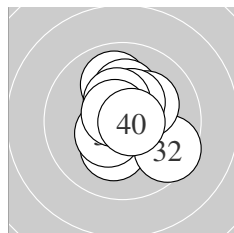

Serie 4:
 10.2 * 9.5 ↘ 10.4 * 10.0 ↑ 10.2 *
 10.2 * 10.4 * 10.4 * 10.7 * 10.7 *
 beste Teiler 59.4 (40.) 74.2 (39.) 126.9 (33.)
 Trefferlage 0.28 mm rechts, 0.40 mm hoch
 Streuwert 1.36, horizontal: 1.21, vertikal: 1.48

QF – Schütze hat sich fürs Finale qualifiziert

Unterschrift des Schützen

Meyton Elektronik

Ergebnis: **407.7** (390)
 Serien: 101.9 102.4 101.5 101.9
 Zähler: 30 10 0 0 0 0 0 0 0 0
 Innenzehner: 21
 weiteste: 412 (36), 301 (26), 295 (16)
 beste Teiler 10.1 (37.) 48.7 (32.) 51.1 (31.)
 Trefferlage 0.22 mm links, 0.25 mm hoch
 Streuwert 1.47, horizontal: 1.51, vertikal: 1.42

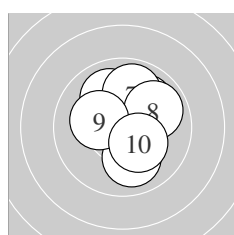
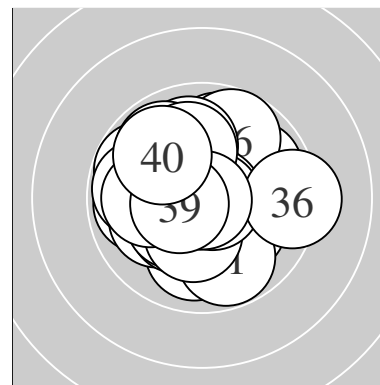

Serie 1:
 10.4 * 10.6 * 10.6 * 10.0 ↘ 10.0 ↓
 10.0 ↗ 9.9 ↑ 9.9 ↗ 10.2 * 10.3 *
 beste Teiler 83.7 (3.) 97.5 (2.) 138.4 (1.)
 Trefferlage 0.61 mm rechts, 0.68 mm hoch
 Streuwert 1.35, horizontal: 1.19, vertikal: 1.50

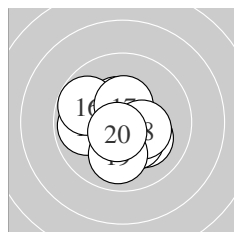

Serie 2:
 10.1 ↘ 10.4 * 10.3 * 10.6 * 9.9 ←
 9.8 ↖ 10.4 * 10.3 * 10.0 ↓ 10.6 *
 beste Teiler 80.0 (14.) 85.4 (20.) 128.2 (17.)
 Trefferlage 0.33 mm links, 0.30 mm tief
 Streuwert 1.38, horizontal: 1.49, vertikal: 1.25

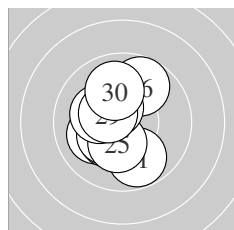

Serie 3:
 9.8 ↓ 10.1 ← 10.3 * 10.3 * 10.3 *
 9.7 ↗ 10.4 * 10.2 * 10.4 * 10.0 ↑
 beste Teiler 128.2 (27.) 129.6 (29.) 159.4 (24.)
 Trefferlage 0.64 mm links, 0.01 mm hoch
 Streuwert 1.47, horizontal: 1.10, vertikal: 1.76

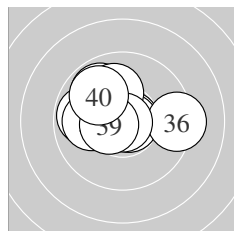

Serie 4:
 10.7 * 10.8 * 9.9 ↘ 9.8 ← 10.1 ↑
 9.3 → 10.9 * 10.0 ← 10.5 * 9.9 ↘
 beste Teiler 10.1 (37.) 48.7 (32.) 51.1 (31.)
 Trefferlage 0.52 mm links, 0.61 mm hoch
 Streuwert 1.58, horizontal: 1.99, vertikal: 1.03

Unterschrift des Schützen

Meyton Elektronik

Ergebnis:	398.2	(380)
Serien:	99.5	99.0 100.0 99.7
Zähler:	22	16 2 0 0 0 0 0 0 0
Innenzehner:	18	
weiteste:	553	(28), 543 (5), 465 (19)
beste Teiler	34.7	(23.) 91.7 (4.) 99.8 (14.)
Trefferlage	0.76	mm rechts, 0.06 mm hoch
Streuwert	1.94,	horizontal: 2.07, vertikal: 1.80

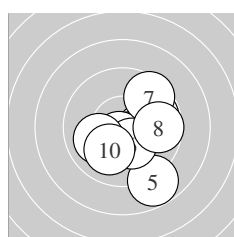
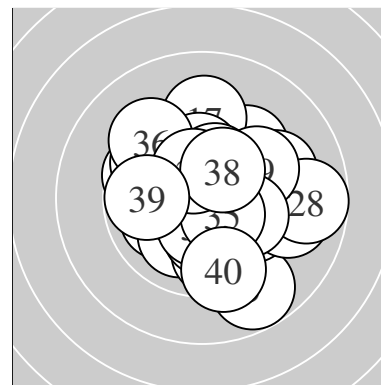

Serie 1:	10.3 *	10.5 *	9.8 ↗	10.6 *	8.8 ↓
	10.3 *	9.5 ↗	9.7 →	10.0 ↖	10.0 ↙
beste Teiler	91.7	(4.) 104.9	(2.) 165.6	(6.)	
Trefferlage	1.03	mm rechts,	0.74	mm tief	
Streuwert	1.87,	horizontal: 1.80,	vertikal: 1.93		

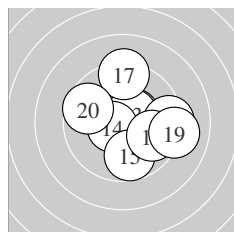

Serie 2:	10.5 *	10.5 *	10.5 *	10.6 *	9.8 ↓
	9.3 →	9.3 ↑	9.8 ↘	9.1 →	9.6 ↖
beste Teiler	99.8	(14.) 106.4	(13.) 116.2	(12.)	
Trefferlage	0.92	mm rechts,	0.25	mm hoch	
Streuwert	2.11,	horizontal: 2.31,	vertikal: 1.89		

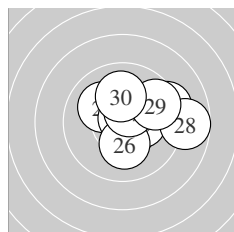

Serie 3:	10.1 ↘	10.5 *	10.8 *	9.3 →	10.3 *
	10.2 *	10.5 *	8.7 →	9.6 →	10.0 ↑
beste Teiler	34.7	(23.) 102.5	(22.) 111.3	(27.)	
Trefferlage	1.35	mm rechts,	0.49	mm hoch	
Streuwert	1.77,	horizontal: 2.16,	vertikal: 1.25		

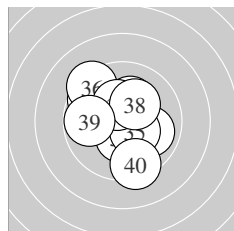

Serie 4:	9.7 ↘	10.2 *	9.9 ↘	10.4 *	10.4 *
	9.3 ↘	10.4 *	10.2 *	9.8 ←	9.4 ↓
beste Teiler	140.0	(35.) 142.0	(34.) 149.2	(37.)	
Trefferlage	0.25	mm links,	0.25	mm hoch	
Streuwert	1.96,	horizontal: 1.89,	vertikal: 2.04		

Unterschrift des Schützen

Meyton Elektronik

Ergebnis: **405.2** (386)
 Serien: 100.6 103.5 100.1 101.0
 Zähler: 26 14 0 0 0 0 0 0 0 0
 Innenzehner: 23
 weiteste: 482 (1), 474 (25), 394 (4)
 beste Teiler 17.0 (8.) 64.5 (9.) 67.4 (23.)
 Trefferlage 0.32 mm rechts, 0.15 mm tief
 Streuwert 1.68, horizontal: 1.96, vertikal: 1.33

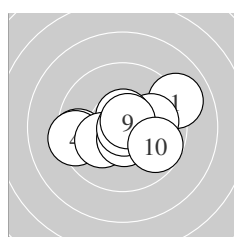
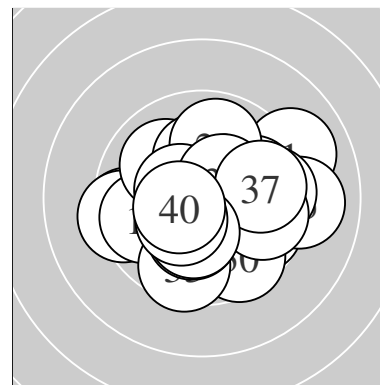

Serie 1:
 9.0 → 10.0 → 9.5 ← 9.4 ← 10.6 *
 10.2 * 10.6 * 10.9 * 10.7 * 9.7 ↘
 beste Teiler 17.0 (8.) 64.5 (9.) 86.1 (5.)
 Trefferlage 0.09 mm rechts, 0.12 mm tief
 Streuwert 2.02, horizontal: 2.62, vertikal: 1.11

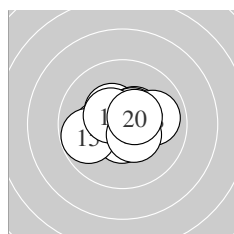

Serie 2:
 10.2 * 10.4 * 10.6 * 10.5 * 9.8 ←
 10.5 * 10.5 * 10.0 → 10.5 * 10.5 *
 beste Teiler 94.1 (13.) 109.1 (16.) 113.8 (20.)
 Trefferlage 0.03 mm links, 0.12 mm hoch
 Streuwert 1.25, horizontal: 1.57, vertikal: 0.81

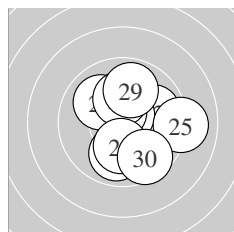

Serie 3:
 9.9 ↓ 9.9 → 10.7 * 10.6 * 9.1 →
 10.0 ↘ 10.2 * 10.2 * 9.9 ↑ 9.6 ↘
 beste Teiler 67.4 (23.) 85.7 (24.) 189.8 (27.)
 Trefferlage 0.71 mm rechts, 0.07 mm hoch
 Streuwert 1.88, horizontal: 1.85, vertikal: 1.91

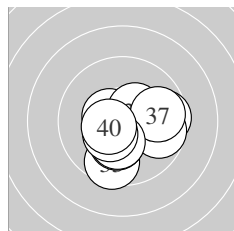

Serie 4:
 9.6 → 10.5 * 9.6 ↓ 10.4 * 10.2 *
 9.7 → 9.8 → 10.3 * 10.4 * 10.5 *
 beste Teiler 113.8 (32.) 121.0 (40.) 133.3 (34.)
 Trefferlage 0.52 mm rechts, 0.69 mm tief
 Streuwert 1.60, horizontal: 1.86, vertikal: 1.30

Unterschrift des Schützen

Ergebnis: **396.6** (378)
 Serien: 98.3 101.5 99.4 97.4
 Zähler: 21 17 1 1 0 0 0 0 0 0
 Innenzehner: 14
 weiteste: 752 (5), 632 (40), 409 (24)
 beste Teiler 45.0 (17.) 60.1 (18.) 85.4 (25.)
 Trefferlage 0.71 mm rechts, 0.02 mm tief
 Streuwert 2.02, horizontal: 2.47, vertikal: 1.43

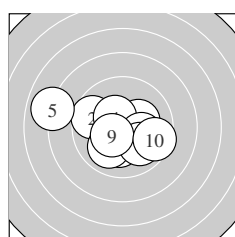
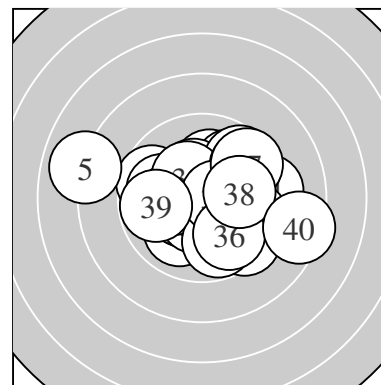

Serie 1:
 10.2 * 9.6 ← 10.2 * 10.4 * 7.9 ←
 10.0 ↗ 10.1 → 10.0 ↘ 10.4 * 9.5 →
 beste Teiler 132.2 (4.) 138.4 (9.) 176.0 (1.)
 Trefferlage 0.53 mm links, 0.38 mm tief
 Streuwert 2.39, horizontal: 3.07, vertikal: 1.43

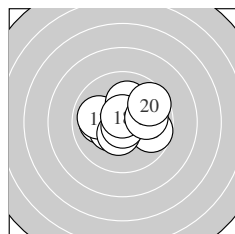

Serie 2:
 10.0 ← 10.4 * 9.9 ← 10.1 ↑ 9.7 →
 10.4 * 10.8 * 10.7 * 9.9 → 9.6 ↗
 beste Teiler 45.0 (17.) 60.1 (18.) 127.4 (16.)
 Trefferlage 0.21 mm rechts, 0.21 mm hoch
 Streuwert 1.61, horizontal: 1.99, vertikal: 1.10

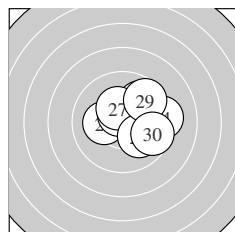

Serie 3:
 10.2 * 9.6 → 10.2 * 9.3 → 10.6 *
 9.9 ↗ 10.3 * 10.1 ↘ 9.6 ↗ 9.6 →
 beste Teiler 85.4 (25.) 153.1 (27.) 190.2 (23.)
 Trefferlage 1.54 mm rechts, 0.47 mm hoch
 Streuwert 1.61, horizontal: 1.90, vertikal: 1.25

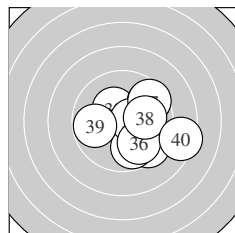

Serie 4:
 9.5 ↘ 10.3 * 9.6 ↗ 9.8 ↘ 10.6 *
 9.8 ↘ 9.6 ↗ 10.0 → 9.8 ← 8.4 →
 beste Teiler 92.5 (35.) 157.0 (32.) 235.9 (38.)
 Trefferlage 1.63 mm rechts, 0.40 mm tief
 Streuwert 2.14, horizontal: 2.38, vertikal: 1.86

Unterschrift des Schützen

Meyton Elektronik

Ergebnis: **408.1** (391)
 Serien: 99.3 103.1 103.0 102.7
 Zähler: 31 9 0 0 0 0 0 0 0 0
 Innenzehner: 23
 weiteste: 379 (3), 326 (10), 301 (7)
 beste Teiler 26.0 (21.) 69.5 (20.) 74.2 (39.)
 Trefferlage 0.17 mm rechts, 0.57 mm hoch
 Streuwert 1.39, horizontal: 1.60, vertikal: 1.14

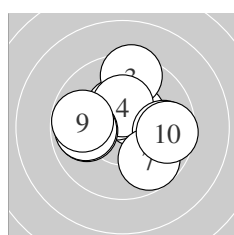
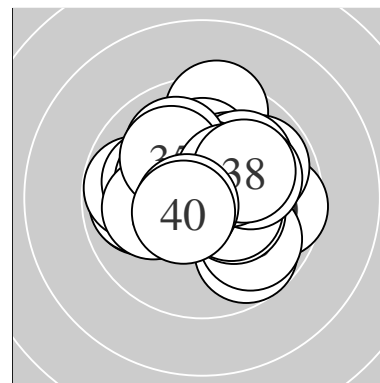

Serie 1:
 10.5 * 10.4 * 9.4 ↑ 10.3 * 9.8 →
 9.9 ← 9.7 ↘ 9.9 ← 9.8 ← 9.6 →
 beste Teiler 123.0 (1.) 138.8 (2.) 155.0 (4.)
 Trefferlage 0.10 mm rechts, 0.44 mm hoch
 Streuwert 1.96, horizontal: 2.28, vertikal: 1.59

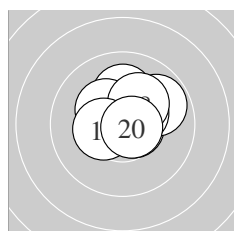

Serie 2:
 10.6 * 10.3 * 9.8 ↗ 10.3 * 10.1 ↑
 10.3 * 10.4 * 10.2 * 10.4 * 10.7 *
 beste Teiler 69.5 (20.) 80.7 (11.) 136.8 (17.)
 Trefferlage 0.44 mm rechts, 0.91 mm hoch
 Streuwert 1.02, horizontal: 1.13, vertikal: 0.89

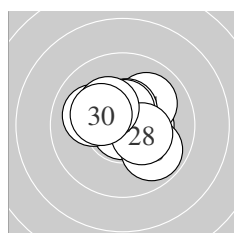

Serie 3:
 10.8 * 10.4 * 9.8 ↘ 10.0 ↗ 10.1 ↖
 10.5 * 10.5 * 10.3 * 10.3 * 10.3 *
 beste Teiler 26.0 (21.) 106.4 (27.) 115.2 (26.)
 Trefferlage 0.23 mm rechts, 0.37 mm hoch
 Streuwert 1.27, horizontal: 1.46, vertikal: 1.04

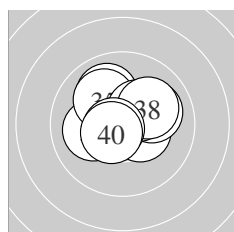

Serie 4:
 10.4 * 10.4 * 10.0 ↘ 10.1 ← 10.1 ↖
 10.0 → 10.4 * 10.1 ↗ 10.7 * 10.5 *
 beste Teiler 74.2 (39.) 102.0 (40.) 129.7 (31.)
 Trefferlage 0.08 mm links, 0.56 mm hoch
 Streuwert 1.28, horizontal: 1.51, vertikal: 1.00

Unterschrift des Schützen

Ergebnis:	410.3	(392)
Serien:	103.5	102.0 101.7 103.1
Zähler:	32	8 0 0 0 0 0 0 0 0
Innenzehner:	29	
weiteste:	395	(32), 386 (24), 322 (29)
beste Teiler	51.2	(5.) 56.3 (31.) 59.1 (26.)
Trefferlage	0.21	mm links, 0.37 mm hoch
Streuwert	1.35,	horizontal: 1.57, vertikal: 1.09

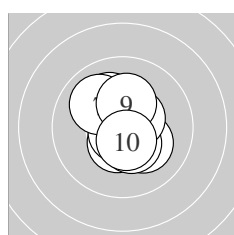
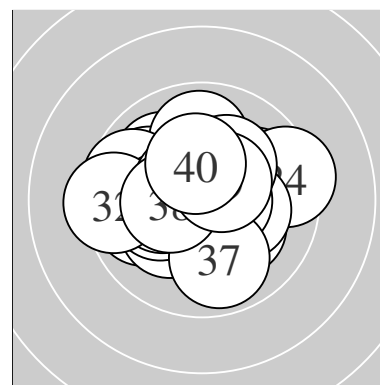

Serie 1:	10.1 ↖	10.2 *	10.5 *	10.4 *	10.7 *
	10.4 *	10.0 ↘	10.5 *	10.2 *	10.5 *
beste Teiler	51.2	(5.) 101.9	(10.) 114.0	(8.)	
Trefferlage	0.04	mm rechts,	0.23	mm hoch	
Streuwert	1.16,	horizontal: 0.94,	vertikal: 1.34		

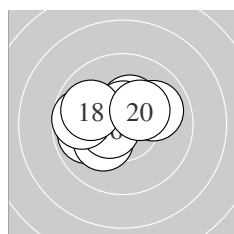

Serie 2:	9.9 ←	10.4 *	10.2 *	10.4 *	10.6 *
	10.6 *	9.7 ←	9.9 ↘	10.0 →	10.3 *
beste Teiler	97.1	(15.) 100.5	(16.) 136.6	(12.)	
Trefferlage	0.54	mm links,	0.46	mm hoch	
Streuwert	1.43,	horizontal: 1.81,	vertikal: 0.90		

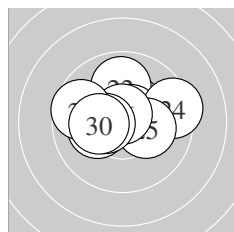

Serie 3:	10.4 *	9.9 ↑	10.6 *	9.4 →	10.2 *
	10.7 *	10.2 *	10.4 *	9.7 ←	10.2 *
beste Teiler	59.1	(26.) 80.6	(23.) 131.3	(28.)	
Trefferlage	0.15	mm links,	0.59	mm hoch	
Streuwert	1.55,	horizontal: 1.98,	vertikal: 0.95		

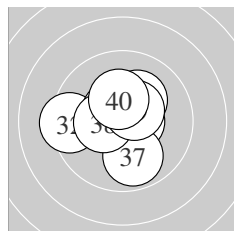

Serie 4:	10.7 *	9.4 ←	10.6 *	10.5 *	10.2 *
	10.6 *	9.9 ↓	10.4 *	10.5 *	10.3 *
beste Teiler	56.3	(31.) 81.5	(33.) 89.0	(36.)	
Trefferlage	0.21	mm links,	0.19	mm hoch	
Streuwert	1.39,	horizontal: 1.55,	vertikal: 1.21		

Unterschrift des Schützen

Meyton Elektronik

Ergebnis: **415.3** (399)^{QF}
 Serien: 104.0 103.4 104.1 103.8
 Zähler: 39 1 0 0 0 0 0 0 0 0
 Innenzehner: 30
 weiteste: 307 (16), 242 (2), 239 (18)
 beste Teiler 31.0 (1.) 39.0 (28.) 40.0 (30.)
 Trefferlage 0.19 mm links, 0.45 mm hoch
 Streuwert 1.08, horizontal: 1.09, vertikal: 1.07

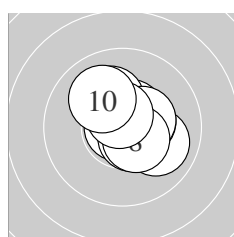
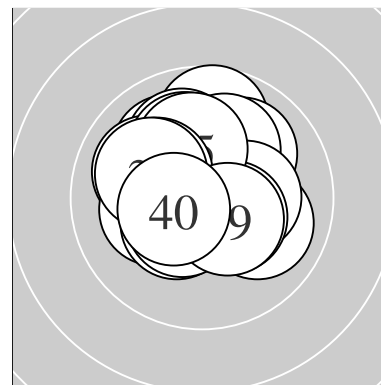

Serie 1:
 10.8 * 10.0 ↘ 10.5 * 10.6 * 10.4 *
 10.2 * 10.4 * 10.5 * 10.6 * 10.0 ↖
 beste Teiler 31.0 (1.) 85.6 (9.) 92.1 (4.)
 Trefferlage 0.41 mm rechts, 0.38 mm hoch
 Streuwert 1.05, horizontal: 1.08, vertikal: 1.02

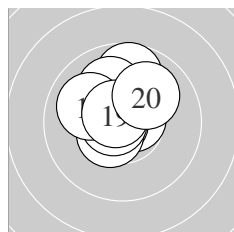

Serie 2:
 10.7 * 10.7 * 10.5 * 10.7 * 10.4 *
 9.7 ↑ 10.0 ↖ 10.0 ↘ 10.7 * 10.0 ↗
 beste Teiler 52.2 (12.) 60.0 (14.) 70.9 (11.)
 Trefferlage 0.36 mm links, 0.90 mm hoch
 Streuwert 1.09, horizontal: 1.02, vertikal: 1.15

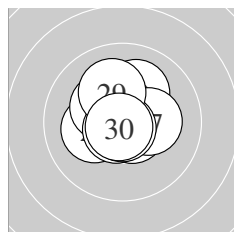

Serie 3:
 10.2 * 10.6 * 10.1 ↗ 10.2 * 10.3 *
 10.7 * 10.3 * 10.8 * 10.1 ↖ 10.8 *
 beste Teiler 39.0 (28.) 40.0 (30.) 64.5 (26.)
 Trefferlage 0.19 mm links, 0.45 mm hoch
 Streuwert 1.07, horizontal: 1.06, vertikal: 1.09

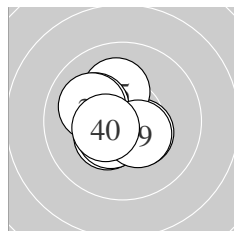

Serie 4:
 10.4 * 10.4 * 10.8 * 10.4 * 10.2 *
 10.5 * 10.1 ↖ 10.1 ↖ 10.4 * 10.5 *
 beste Teiler 50.5 (33.) 120.5 (36.) 121.6 (40.)
 Trefferlage 0.65 mm links, 0.09 mm hoch
 Streuwert 1.04, horizontal: 1.05, vertikal: 1.04

QF – Schütze hat sich fürs Finale qualifiziert

Unterschrift des Schützen

Meyton Elektronik

Ergebnis: **403.5** (384)
 Serien: 102.3 100.5 101.4 99.3
 Zähler: 24 16 0 0 0 0 0 0 0 0
 Innenzehner: 18
 weiteste: 405 (39), 376 (13), 369 (40)
 beste Teiler 35.7 (31.) 43.4 (27.) 72.2 (30.)
 Trefferlage 0.30 mm rechts, 0.50 mm hoch
 Streuwert 1.68, horizontal: 1.93, vertikal: 1.37

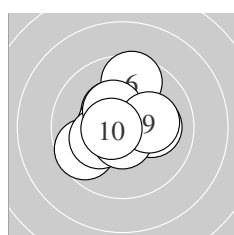
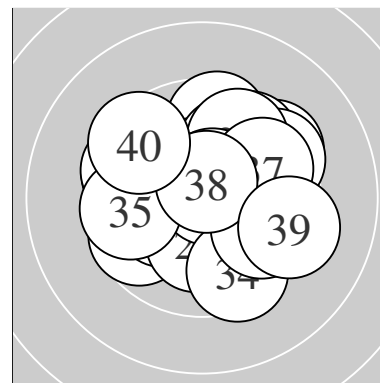

Serie 1:
 10.4 * 10.5 * 9.7 ↙ 10.1 → 10.2 *
 9.6 ↑ 10.6 * 10.4 * 10.2 * 10.6 *
 beste Teiler 82.0 (7.) 82.8 (10.) 108.1 (2.)
 Trefferlage 0.31 mm links, 0.29 mm hoch
 Streuwert 1.46, horizontal: 1.53, vertikal: 1.38

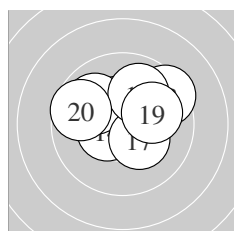

Serie 2:
 10.4 * 9.8 ↗ 9.4 ↗ 10.5 * 10.5 *
 9.9 ↘ 10.3 * 10.0 ↑ 10.0 → 9.7 ↖
 beste Teiler 114.5 (15.) 122.0 (14.) 132.7 (11.)
 Trefferlage 0.39 mm rechts, 1.01 mm hoch
 Streuwert 1.59, horizontal: 1.98, vertikal: 1.08

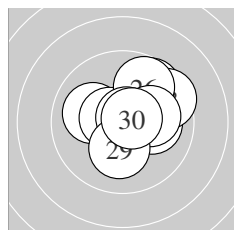

Serie 3:
 10.1 → 9.7 ↗ 9.5 ↗ 10.0 ↖ 10.6 *
 9.7 ↗ 10.8 * 10.1 → 10.2 * 10.7 *
 beste Teiler 43.4 (27.) 72.2 (30.) 99.9 (25.)
 Trefferlage 0.85 mm rechts, 0.67 mm hoch
 Streuwert 1.49, horizontal: 1.65, vertikal: 1.32

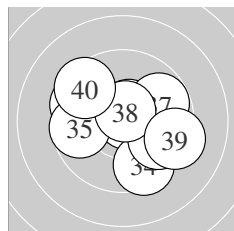

Serie 4:
 10.8 * 10.6 * 9.6 ↖ 9.5 ↘ 9.7 ←
 9.8 ↘ 9.8 ↗ 10.7 * 9.3 → 9.5 ↖
 beste Teiler 35.7 (31.) 73.4 (38.) 94.0 (32.)
 Trefferlage 0.26 mm rechts, 0.03 mm hoch
 Streuwert 2.14, horizontal: 2.54, vertikal: 1.64

Unterschrift des Schützen

Meyton Elektronik

Ergebnis: **411.9** (393)
 Serien: 101.8 103.3 104.9 101.9
 Zähler: 34 5 1 0 0 0 0 0 0 0
 Innenzehner: 31
 weiteste: 700 (3), 393 (14), 380 (38)
 beste Teiler 8.0 (28.) 12.3 (17.) 20.8 (13.)
 Trefferlage 0.14 mm rechts, 0.45 mm tief
 Streuwert 1.43, horizontal: 1.73, vertikal: 1.05

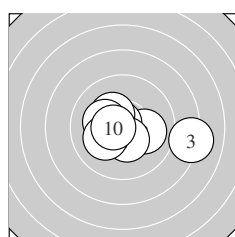
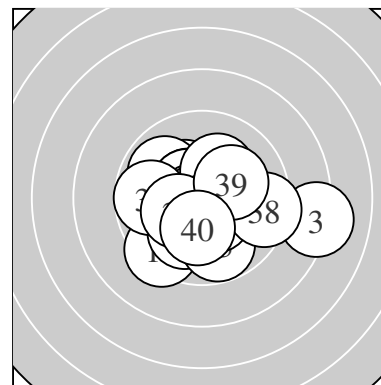

Serie 1:
 10.7 * 10.1 → 8.2 → 10.7 * 10.5 *
 10.3 * 10.4 * 10.2 * 10.1 ↙ 10.6 *
 beste Teiler 52.0 (4.) 67.0 (1.) 93.0 (10.)
 Trefferlage 0.31 mm rechts, 0.28 mm tief
 Streuwert 1.93, horizontal: 2.59, vertikal: 0.83

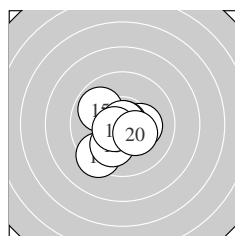

Serie 2:
 10.5 * 10.2 * 10.9 * 9.4 ↘ 9.9 ↖
 10.6 * 10.9 * 10.0 ↘ 10.6 * 10.3 *
 beste Teiler 12.3 (17.) 20.8 (13.) 91.7 (16.)
 Trefferlage 0.26 mm links, 0.66 mm tief
 Streuwert 1.32, horizontal: 1.39, vertikal: 1.24

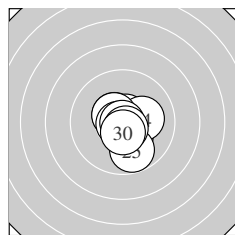

Serie 3:
 10.5 * 10.7 * 10.3 * 10.2 * 9.8 ↓
 10.5 * 10.8 * 10.9 * 10.7 * 10.5 *
 beste Teiler 8.0 (28.) 45.8 (27.) 64.4 (22.)
 Trefferlage 0.21 mm rechts, 0.39 mm tief
 Streuwert 1.00, horizontal: 0.86, vertikal: 1.13

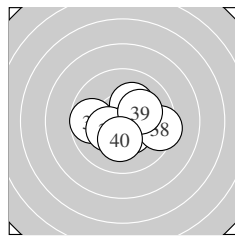

Serie 4:
 10.6 * 10.2 * 9.7 ← 10.6 * 10.3 *
 10.4 * 10.3 * 9.4 → 10.2 * 10.2 *
 beste Teiler 86.6 (34.) 98.8 (31.) 130.2 (36.)
 Trefferlage 0.29 mm rechts, 0.47 mm tief
 Streuwert 1.49, horizontal: 1.82, vertikal: 1.06

Unterschrift des Schützen

Meyton Elektronik

Ergebnis: **408.3** (389)
 Serien: 101.7 103.5 100.7 102.4
 Zähler: 29 11 0 0 0 0 0 0 0 0
 Innenzehner: 25
 weiteste: 467 (25), 461 (24), 418 (3)
 beste Teiler 18.2 (8.) 37.3 (7.) 54.9 (11.)
 Trefferlage 0.21 mm links, 0.12 mm hoch
 Streuwert 1.54, horizontal: 1.74, vertikal: 1.31

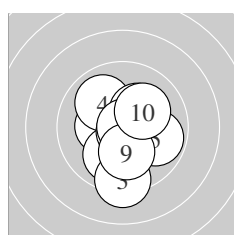
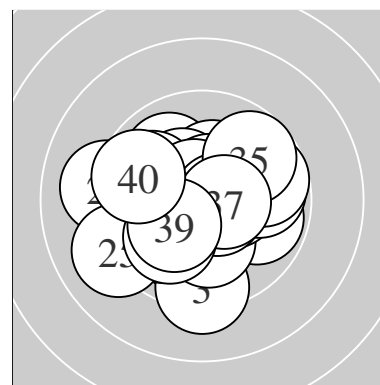

Serie 1:
 10.3 * 10.0 ↙ 9.3 ↓ 10.0 ↘ 9.8 →
 10.3 * 10.8 * 10.9 * 10.2 * 10.1 ↗
 beste Teiler 18.2 (8.) 37.3 (7.) 158.2 (1.)
 Trefferlage 0.19 mm rechts, 0.49 mm tief
 Streuwert 1.63, horizontal: 1.35, vertikal: 1.87

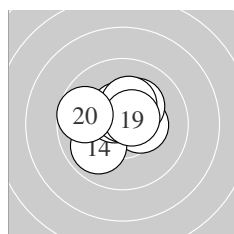

Serie 2:
 10.7 * 10.4 * 10.2 * 9.9 ↙ 10.6 *
 10.5 * 10.6 * 10.3 * 10.6 * 9.7 ←
 beste Teiler 54.9 (11.) 79.0 (17.) 88.4 (19.)
 Trefferlage 0.16 mm links, 0.54 mm hoch
 Streuwert 1.18, horizontal: 1.39, vertikal: 0.94

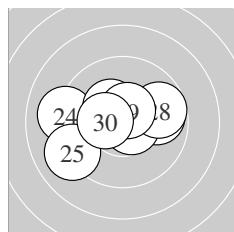

Serie 3:
 10.5 * 9.8 → 10.6 * 9.1 ← 9.1 ↙
 10.3 * 10.6 * 9.7 → 10.6 * 10.4 *
 beste Teiler 79.6 (27.) 90.1 (23.) 99.5 (29.)
 Trefferlage 0.57 mm links, 0.24 mm hoch
 Streuwert 1.89, horizontal: 2.46, vertikal: 1.04

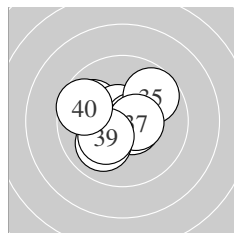

Serie 4:
 9.9 ↙ 10.6 * 10.6 * 10.6 * 9.7 ↗
 10.6 * 10.5 * 10.0 ↙ 10.2 * 9.7 ←
 beste Teiler 77.0 (33.) 84.0 (34.) 86.0 (36.)
 Trefferlage 0.29 mm links, 0.18 mm hoch
 Streuwert 1.46, horizontal: 1.73, vertikal: 1.13

Unterschrift des Schützen

Meyton Elektronik

Ergebnis: **397.8** (378)
 Serien: 98.7 99.2 98.5 101.4
 Zähler: 19 20 1 0 0 0 0 0 0 0
 Innenzehner: 15
 weiteste: 557 (4), 483 (29), 467 (18)
 beste Teiler 28.0 (40.) 46.3 (32.) 54.4 (27.)
 Trefferlage 0.39 mm links, 0.76 mm hoch
 Streuwert 1.92, horizontal: 2.25, vertikal: 1.53

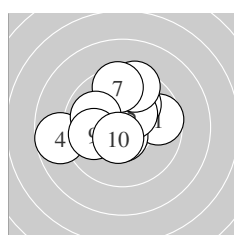
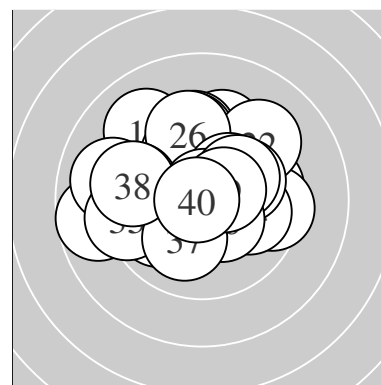

Serie 1:
 9.7 → 10.0 ↗ 10.6 * 8.7 ← 10.4 *
 9.5 ↑ 9.5 ↑ 9.9 ↖ 9.9 ← 10.5 *
 beste Teiler 80.0 (3.) 101.7 (10.) 145.9 (5.)
 Trefferlage 0.50 mm links, 0.85 mm hoch
 Streuwert 2.11, horizontal: 2.42, vertikal: 1.74

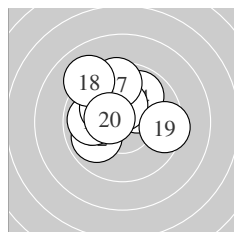

Serie 2:
 10.2 * 9.9 ↖ 9.9 ← 9.9 ↗ 10.4 *
 10.2 * 9.6 ↑ 9.1 ↘ 9.5 → 10.5 *
 beste Teiler 119.9 (20.) 147.0 (15.) 182.4 (11.)
 Trefferlage 0.47 mm links, 1.21 mm hoch
 Streuwert 1.87, horizontal: 2.11, vertikal: 1.59

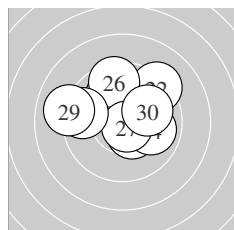

Serie 3:
 10.4 * 9.2 ↗ 10.4 * 9.9 → 9.9 ↖
 9.5 ↑ 10.7 * 9.5 ← 9.0 ← 10.0 →
 beste Teiler 54.4 (27.) 126.0 (21.) 129.9 (23.)
 Trefferlage 0.01 mm rechts, 0.99 mm hoch
 Streuwert 2.11, horizontal: 2.55, vertikal: 1.56

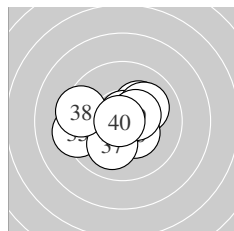

Serie 4:
 10.2 * 10.8 * 10.1 ↗ 9.7 ← 9.3 ←
 10.4 * 10.1 ↘ 9.5 ← 10.5 * 10.8 *
 beste Teiler 28.0 (40.) 46.3 (32.) 125.7 (39.)
 Trefferlage 0.62 mm links, 0.00 mm
 Streuwert 1.72, horizontal: 2.19, vertikal: 1.07

Unterschrift des Schützen

Meyton Elektronik

Ergebnis: **407.5** (387)

Serien: 102.3 101.3 100.2 103.7

Zähler: 27 13 0 0 0 0 0 0 0 0

Innenzehner: 24

weiteste: 425 (29), 395 (28), 381 (34)

beste Teiler 9.2 (33.) 25.0 (6.) 48.1 (31.)

Trefferlage 0.09 mm rechts, 0.44 mm hoch

Streuwert 1.53, horizontal: 1.42, vertikal: 1.64

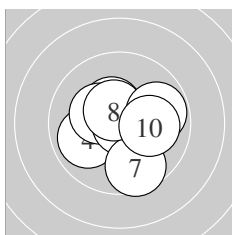
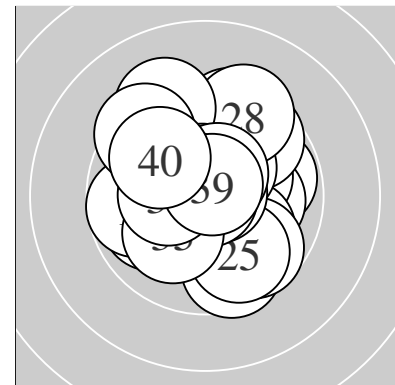

Serie 1:

10.6 *	10.2 *	10.4 *	9.9 ↙	10.3 *
10.9 *	9.6 ↓	10.5 *	9.8 →	10.1 →

beste Teiler 25.0 (6.) 84.1 (1.) 103.3 (8.)

Trefferlage 0.19 mm rechts, 0.30 mm tief

Streuwert 1.47, horizontal: 1.59, vertikal: 1.34

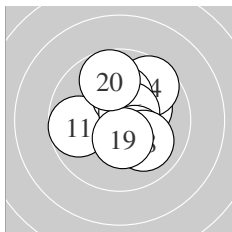

Serie 2:

9.7 ←	10.6 *	10.2 *	9.6 ↗	10.2 *
10.6 *	10.3 *	10.0 ↘	10.4 *	9.7 ↑

beste Teiler 86.0 (12.) 92.3 (16.) 134.9 (19.)

Trefferlage 0.48 mm rechts, 0.41 mm hoch

Streuwert 1.55, horizontal: 1.50, vertikal: 1.60

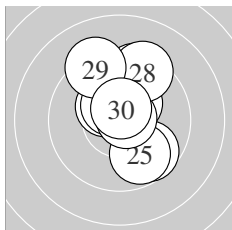

Serie 3:

9.5 ↑	9.7 ↘	10.4 *	10.5 *	9.8 ↓
10.3 *	10.7 *	9.4 ↑	9.3 ↖	10.6 *

beste Teiler 52.2 (27.) 86.7 (30.) 125.8 (24.)

Trefferlage 0.45 mm rechts, 1.04 mm hoch

Streuwert 1.81, horizontal: 1.27, vertikal: 2.22

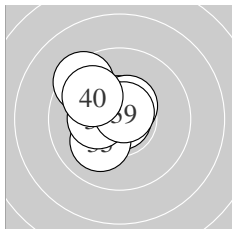

Serie 4:

10.8 *	10.6 *	10.9 *	9.4 ↘	10.1 ↙
10.5 *	10.5 *	10.3 *	10.7 *	9.9 ↖

beste Teiler 9.2 (33.) 48.1 (31.) 58.8 (39.)

Trefferlage 0.75 mm links, 0.63 mm hoch

Streuwert 1.13, horizontal: 1.11, vertikal: 1.14

Unterschrift des Schützen

Meyton Elektronik

Ergebnis: **387.9** (368)
 Serien: 93.6 100.3 96.5 97.5
 Zähler: 15 19 5 1 0 0 0 0 0 0
 Innenzehner: 10
 weiteste: 834 (25), 591 (9), 555 (5)
 beste Teiler 17.0 (19.) 69.8 (21.) 85.5 (18.)
 Trefferlage 0.76 mm links, 0.63 mm hoch
 Streuwert 2.44, horizontal: 3.01, vertikal: 1.68

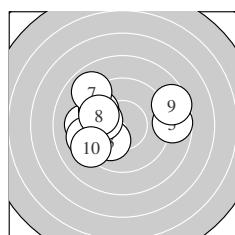
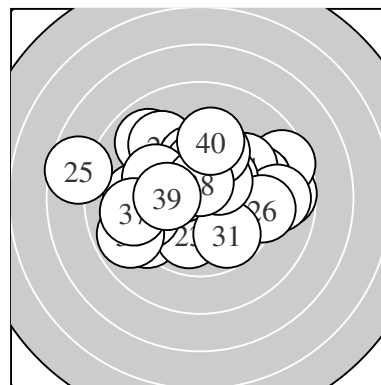

Serie 1:
 9.3 ← 9.7 ↘ 10.1 ↙ 10.0 ← 8.7 →
 9.3 ← 8.9 ↘ 9.8 ← 8.6 → 9.2 ↙
 beste Teiler 216.4 (3.) 229.9 (4.) 286.0 (8.)
 Trefferlage 1.31 mm links, 0.41 mm hoch
 Streuwert 2.93, horizontal: 3.69, vertikal: 1.89

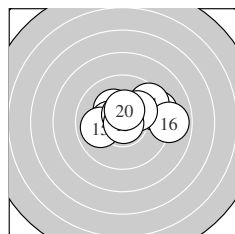

Serie 2:
 10.3 * 10.4 * 9.3 → 9.5 ↗ 9.9 ←
 8.9 → 10.1 ↗ 10.6 * 10.9 * 10.4 *
 beste Teiler 17.0 (19.) 85.5 (18.) 134.6 (20.)
 Trefferlage 0.89 mm rechts, 0.75 mm hoch
 Streuwert 1.84, horizontal: 2.45, vertikal: 0.86

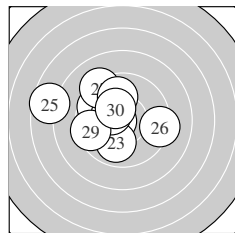

Serie 3:
 10.7 * 9.7 ↘ 9.9 ↓ 10.4 * 7.6 ←
 9.3 → 9.2 ↘ 9.9 ↑ 9.5 ← 10.3 *
 beste Teiler 69.8 (21.) 139.5 (24.) 152.1 (30.)
 Trefferlage 1.69 mm links, 0.69 mm hoch
 Streuwert 2.53, horizontal: 3.08, vertikal: 1.83

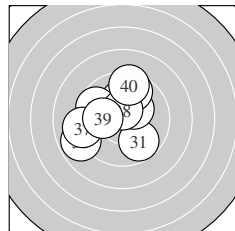

Serie 4:
 9.7 ↘ 10.1 ↑ 9.7 ↘ 10.3 * 9.7 ↑
 8.9 ← 9.1 ← 10.5 * 10.1 ← 9.4 ↑
 beste Teiler 103.0 (38.) 168.5 (34.) 211.4 (32.)
 Trefferlage 0.95 mm links, 0.67 mm hoch
 Streuwert 2.27, horizontal: 2.41, vertikal: 2.12

Unterschrift des Schützen

Meyton Elektronik

Ergebnis: **393.3** (373)
 Serien: 99.1 100.8 96.6 96.8
 Zähler: 18 18 3 1 0 0 0 0 0 0
 Innenzehner: 16
 weiteste: 852 (28), 581 (14), 515 (30)
 beste Teiler 75.1 (21.) 84.8 (35.) 100.9 (10.)
 Trefferlage 0.48 mm links, 0.44 mm hoch
 Streuwert 2.24, horizontal: 2.51, vertikal: 1.93

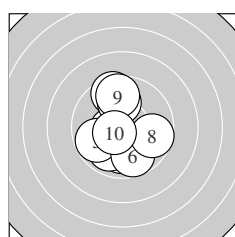
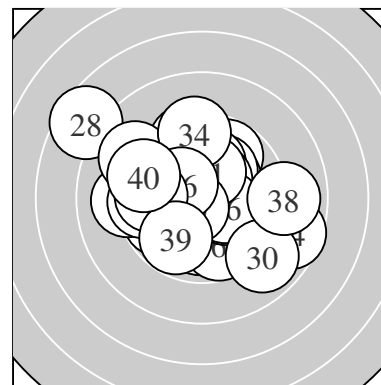

Serie 1:
 9.9 ↓ 9.9 ↙ 10.5 * 9.5 ↑ 9.8 ↙
 9.7 ↓ 9.9 ↑ 9.7 → 9.6 ↑ 10.6 *
 beste Teiler 100.9 (10.) 111.9 (3.) 251.4 (1.)
 Trefferlage 0.38 mm links, 0.14 mm tief
 Streuwert 2.00, horizontal: 1.52, vertikal: 2.38

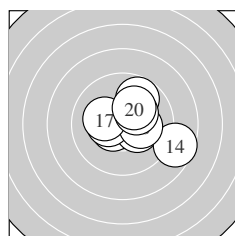

Serie 2:
 10.5 * 10.5 * 10.3 * 8.6 → 10.4 *
 10.2 * 10.2 * 9.8 ↗ 10.2 * 10.1 ↗
 beste Teiler 111.4 (11.) 111.8 (12.) 145.1 (15.)
 Trefferlage 0.75 mm rechts, 0.25 mm hoch
 Streuwert 1.80, horizontal: 2.18, vertikal: 1.33

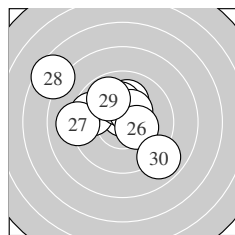

Serie 3:
 10.7 * 9.6 ← 10.1 ↑ 10.2 * 10.4 *
 10.3 * 9.1 ← 7.5 ↖ 9.8 ↘ 8.9 ↘
 beste Teiler 75.1 (21.) 139.0 (25.) 154.7 (26.)
 Trefferlage 1.01 mm links, 0.94 mm hoch
 Streuwert 2.72, horizontal: 3.18, vertikal: 2.16

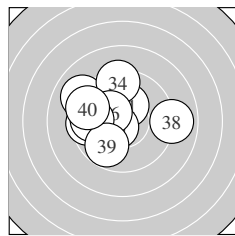

Serie 4:
 10.3 * 9.0 ↖ 9.5 ← 9.3 ↑ 10.6 *
 10.3 * 9.7 ← 8.9 → 9.8 ↙ 9.4 ↖
 beste Teiler 84.8 (35.) 153.9 (36.) 167.4 (31.)
 Trefferlage 1.29 mm links, 0.71 mm hoch
 Streuwert 2.30, horizontal: 2.72, vertikal: 1.79

Unterschrift des Schützen

Meyton Elektronik

Ergebnis: **404.3** (387)
 Serien: 101.1 98.3 102.3 102.6
 Zähler: 27 13 0 0 0 0 0 0 0 0
 Innenzehner: 18
 weiteste: 422 (15), 401 (30), 355 (7)
 beste Teiler 4.1 (33.) 66.2 (6.) 80.2 (4.)
 Trefferlage 0.11 mm rechts, 0.52 mm hoch
 Streuwert 1.60, horizontal: 1.79, vertikal: 1.39

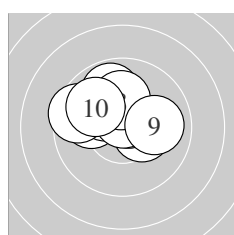
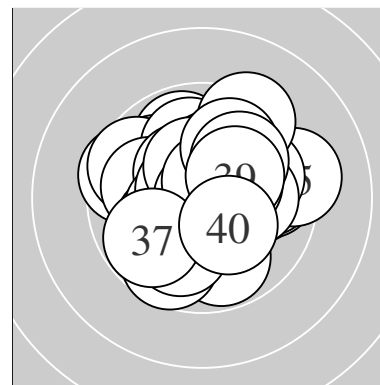

Serie 1:
 10.0 ↖ 10.2 * 10.3 * 10.6 * 9.8 ↗
 10.7 * 9.5 ↖ 10.1 ↑ 10.0 → 9.9 ↖
 beste Teiler 66.2 (6.) 80.2 (4.) 152.0 (3.)
 Trefferlage 0.57 mm links, 1.01 mm hoch
 Streuwert 1.41, horizontal: 1.79, vertikal: 0.89

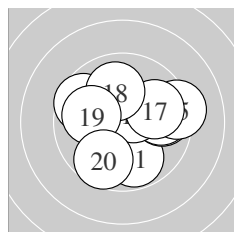

Serie 2:
 9.8 ↓ 9.7 → 9.6 ↖ 9.8 → 9.3 →
 10.5 * 9.9 → 10.0 ↑ 10.0 ↖ 9.7 ↓
 beste Teiler 106.5 (16.) 239.6 (18.) 242.8 (19.)
 Trefferlage 0.68 mm rechts, 0.23 mm hoch
 Streuwert 2.10, horizontal: 2.45, vertikal: 1.68

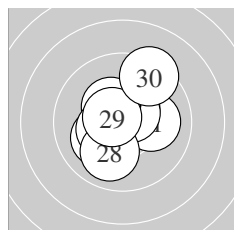

Serie 3:
 10.1 → 10.3 * 10.1 ↙ 10.5 * 10.6 *
 10.4 * 10.4 * 10.0 ↓ 10.6 * 9.3 ↗
 beste Teiler 88.5 (29.) 92.8 (25.) 119.0 (24.)
 Trefferlage 0.17 mm links, 0.18 mm hoch
 Streuwert 1.50, horizontal: 1.42, vertikal: 1.58

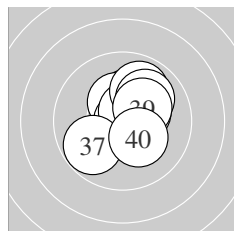

Serie 4:
 10.2 * 10.4 * 10.9 * 10.3 * 10.6 *
 9.9 ↗ 9.8 ↙ 10.0 ↗ 10.2 * 10.3 *
 beste Teiler 4.1 (33.) 86.3 (35.) 150.2 (32.)
 Trefferlage 0.52 mm rechts, 0.65 mm hoch
 Streuwert 1.27, horizontal: 1.21, vertikal: 1.33

Unterschrift des Schützen

Ergebnis: **396.4** (378)
 Serien: 99.1 103.8 97.2 96.3
 Zähler: 24 13 1 1 1 0 0 0 0 0
 Innenzehner: 20
 weiteste: 1119 (37), 843 (26), 555 (6)
 beste Teiler 42.7 (12.) 73.6 (17.) 83.0 (21.)
 Trefferlage 0.10 mm links, 0.87 mm hoch
 Streuwert 2.28, horizontal: 2.15, vertikal: 2.40

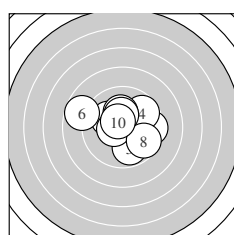
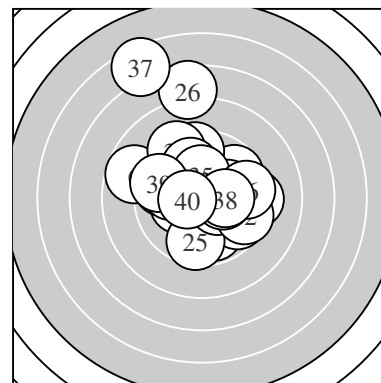

Serie 1:
 10.1 ↘ 9.5 → 9.8 ↓ 9.7 ↗ 10.2 *
 8.7 ↙ 10.5 * 9.7 ↘ 10.3 * 10.6 *
 beste Teiler 96.6 (10.) 113.5 (7.) 161.0 (9.)
 Trefferlage 0.04 mm rechts, 0.43 mm hoch
 Streuwert 2.15, horizontal: 2.58, vertikal: 1.59

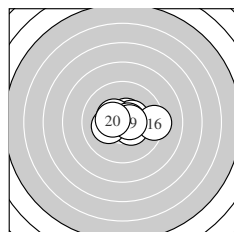

Serie 2:
 10.6 * 10.8 * 10.4 * 10.4 * 10.4 *
 9.3 → 10.7 * 10.2 * 10.6 * 10.4 *
 beste Teiler 42.7 (12.) 73.6 (17.) 89.0 (19.)
 Trefferlage 0.45 mm rechts, 0.11 mm hoch
 Streuwert 1.23, horizontal: 1.66, vertikal: 0.52

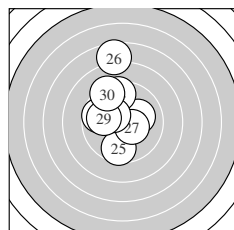

Serie 3:
 10.6 * 10.1 → 9.7 ← 9.5 ↑ 9.6 ↓
 7.6 ↑ 10.4 * 10.4 * 10.0 ← 9.3 ↘
 beste Teiler 83.0 (21.) 135.0 (27.) 150.2 (28.)
 Trefferlage 0.76 mm links, 1.38 mm hoch
 Streuwert 2.51, horizontal: 1.55, vertikal: 3.19

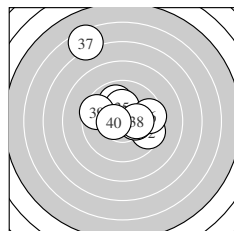

Serie 4:
 10.1 ↘ 9.5 → 9.9 ↗ 10.3 * 10.2 *
 9.6 → 6.5 ↘ 10.2 * 9.5 ↙ 10.5 *
 beste Teiler 115.6 (40.) 163.2 (34.) 180.0 (38.)
 Trefferlage 0.17 mm links, 1.56 mm hoch
 Streuwert 2.97, horizontal: 2.72, vertikal: 3.20

Unterschrift des Schützen

Meyton Elektronik

Ergebnis: **398.8** (380)

Serien: 99.6 96.1 102.2 100.9

Zähler: 21 18 1 0 0 0 0 0 0 0

Innenzehner: 19

weiteste: 546 (3), 486 (16), 480 (12)

beste Teiler 50.8 (1.) 51.4 (25.) 51.7 (26.)

Trefferlage 0.33 mm rechts, 0.06 mm tief

Streuwert 1.99, horizontal: 2.02, vertikal: 1.96

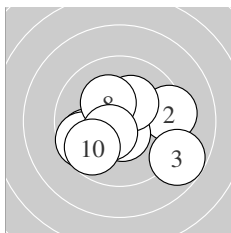
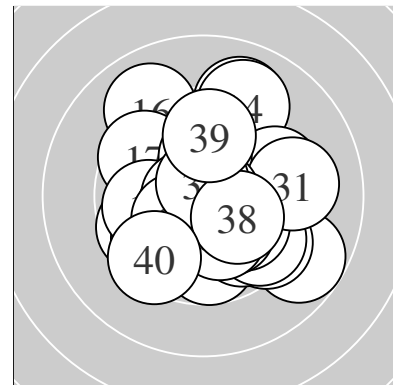

Serie 1:

10.8 *	9.3 →	8.8 ↘	9.8 ↙	10.5 *
9.6 ↙	10.3 *	10.3 *	10.5 *	9.7 ↙

beste Teiler 50.8 (1.) 101.8 (5.) 121.9 (9.)

Trefferlage 0.06 mm rechts, 0.56 mm tief

Streuwert 2.11, horizontal: 2.58, vertikal: 1.49

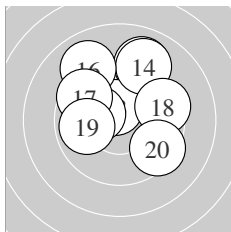

Serie 2:

9.9 ↗	9.0 ↗	10.5 *	9.1 ↗	10.2 *
9.0 ↘	9.6 ↘	9.5 →	9.9 ↙	9.4 ↘

beste Teiler 107.5 (13.) 182.9 (15.) 266.6 (11.)

Trefferlage 0.12 mm rechts, 1.71 mm hoch

Streuwert 2.33, horizontal: 2.45, vertikal: 2.20

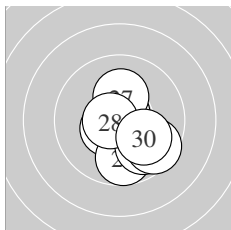

Serie 3:

10.3 *	10.5 *	9.7 ↓	9.8 ↘	10.7 *
10.7 *	10.2 *	10.7 *	9.6 ↘	10.0 ↘

beste Teiler 51.4 (25.) 51.7 (26.) 75.2 (28.)

Trefferlage 0.49 mm rechts, 0.84 mm tief

Streuwert 1.37, horizontal: 1.26, vertikal: 1.47

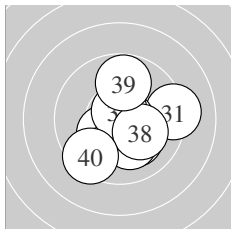

Serie 4:

9.2 →	10.3 *	10.7 *	10.3 *	10.1 ↘
10.2 *	10.7 *	10.2 *	9.8 ↑	9.4 ↙

beste Teiler 52.0 (33.) 64.0 (37.) 159.1 (34.)

Trefferlage 0.64 mm rechts, 0.55 mm tief

Streuwert 1.71, horizontal: 1.77, vertikal: 1.65

Unterschrift des Schützen

Meyton Elektronik

Ergebnis: **390.6** (377)
 Serien: 98.1 96.8 98.1 97.6
 Zähler: 22 14 3 1 0 0 0 0 0 0
 Innenzehner: 14
 weiteste: 867 (37), 731 (22), 670 (38)
 beste Teiler 74.0 (18.) 103.0 (27.) 110.9 (39.)
 Trefferlage 1.17 mm links, 0.45 mm tief
 Streuwert 2.31, horizontal: 2.61, vertikal: 1.97

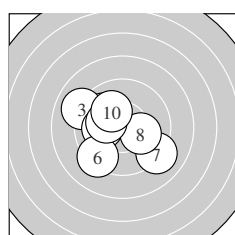
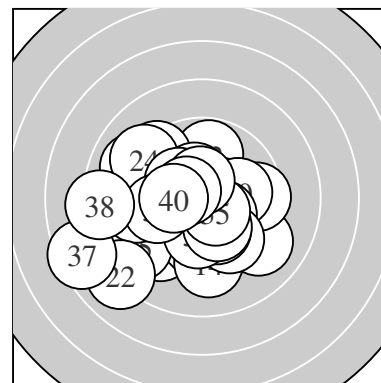

Serie 1:
 9.9 ↘ 10.0 ↘ 9.0 ↘ 10.3 * 10.1 ←
 9.3 ↙ 9.1 ↘ 10.1 → 10.2 * 10.1 ↘
 beste Teiler 162.5 (4.) 184.4 (9.) 207.7 (8.)
 Trefferlage 1.24 mm links, 0.04 mm hoch
 Streuwert 2.10, horizontal: 2.35, vertikal: 1.80

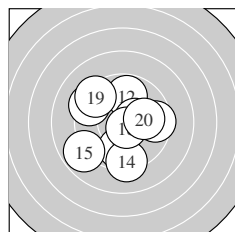

Serie 2:
 9.5 → 9.8 ↑ 9.8 ↓ 9.2 ↓ 8.8 ↙
 9.3 ↘ 10.4 * 10.7 * 9.3 ↘ 10.0 →
 beste Teiler 74.0 (18.) 139.4 (17.) 236.7 (20.)
 Trefferlage 0.26 mm links, 0.26 mm tief
 Streuwert 2.52, horizontal: 2.57, vertikal: 2.48

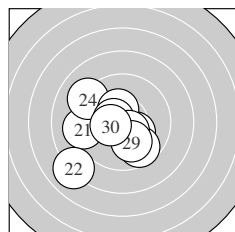

Serie 3:
 9.2 ← 8.0 ↙ 10.3 * 9.1 ↘ 9.7 ↘
 10.4 * 10.5 * 10.5 * 10.0 ↓ 10.4 *
 beste Teiler 103.0 (27.) 117.8 (28.) 134.3 (30.)
 Trefferlage 1.13 mm links, 0.86 mm tief
 Streuwert 2.33, horizontal: 2.52, vertikal: 2.12

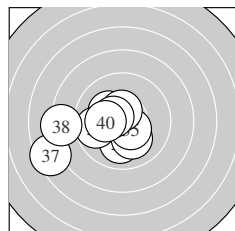

Serie 4:
 10.0 ↓ 10.1 ↘ 10.2 * 9.8 ← 10.5 *
 10.5 * 7.5 ← 8.3 ← 10.5 * 10.2 *
 beste Teiler 110.9 (39.) 112.6 (36.) 124.4 (35.)
 Trefferlage 2.03 mm links, 0.73 mm tief
 Streuwert 2.40, horizontal: 3.02, vertikal: 1.54

Unterschrift des Schützen

Meyton Elektronik

Ergebnis:	418.1	(398) ^{QF}
Serien:	103.8	105.1 103.8 105.4
Zähler:	38	2 0 0 0 0 0 0 0 0
Innenzehner:	37	
weiteste:	286	(26), 271 (8), 219 (25)
beste Teiler	37.2	(33.) 41.1 (16.) 43.0 (5.)
Trefferlage	0.15 mm	rechts, 0.18 mm hoch
Streuwert	0.97,	horizontal: 0.90, vertikal: 1.04

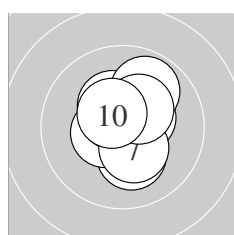
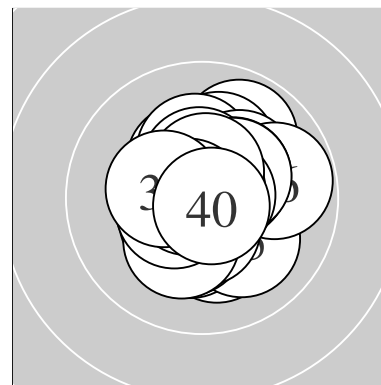

Serie 1:	10.2 *	10.5 *	10.3 *	10.6 *	10.8 *
	10.4 *	10.3 *	9.9 ↗	10.3 *	10.5 *
beste Teiler	43.0	(5.) 89.0	(4.) 112.0	(10.)	
Trefferlage	0.23 mm	rechts, 0.38 mm	hoch		
Streuwert	1.09,	horizontal: 0.90,	vertikal: 1.25		

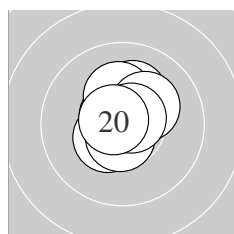

Serie 2:	10.4 *	10.6 *	10.6 *	10.2 *	10.7 *
	10.8 *	10.2 *	10.2 *	10.7 *	10.7 *
beste Teiler	41.1	(16.) 64.4	(20.) 68.2	(19.)	
Trefferlage	0.02 mm	links, 0.53 mm	hoch		
Streuwert	0.82,	horizontal: 0.71,	vertikal: 0.91		

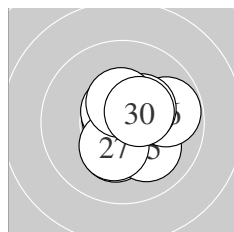

Serie 3:	10.6 *	10.8 *	10.6 *	10.3 *	10.1 ↘
	9.8 →	10.3 *	10.4 *	10.5 *	10.4 *
beste Teiler	46.6	(22.) 81.5	(23.) 88.8	(21.)	
Trefferlage	0.54 mm	rechts, 0.07 mm	tief		
Streuwert	1.12,	horizontal: 1.12,	vertikal: 1.12		

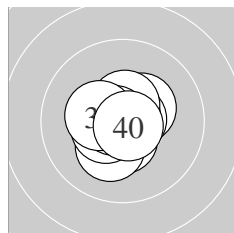

Serie 4:	10.4 *	10.7 *	10.8 *	10.5 *	10.2 *
	10.5 *	10.5 *	10.7 *	10.3 *	10.8 *
beste Teiler	37.2	(33.) 47.5	(40.) 53.1	(38.)	
Trefferlage	0.13 mm	links, 0.08 mm	tief		
Streuwert	0.82,	horizontal: 0.82,	vertikal: 0.83		

QF – Schütze hat sich fürs Finale qualifiziert

Unterschrift des Schützen

Meyton Elektronik

Ergebnis: **412.7** (394)
 Serien: 103.5 103.8 102.6 102.8
 Zähler: 34 6 0 0 0 0 0 0 0 0
 Innenzehner: 30
 weiteste: 353 (35), 280 (10), 277 (29)
 beste Teiler 27.8 (17.) 51.3 (5.) 54.1 (26.)
 Trefferlage 0.13 mm links, 0.21 mm hoch
 Streuwert 1.24, horizontal: 1.20, vertikal: 1.28

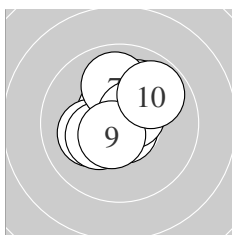
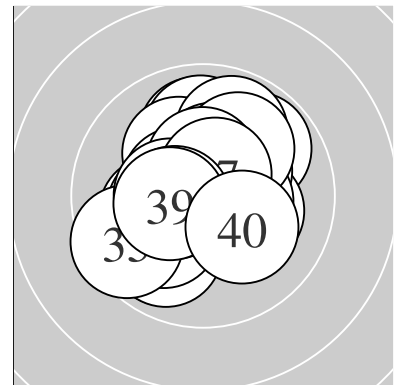

Serie 1:
 10.7 * 10.6 * 10.2 * 10.0 ↗ 10.7 *
 10.3 * 10.0 ↑ 10.6 * 10.6 * 9.8 ↗
 beste Teiler 51.3 (5.) 73.1 (1.) 92.9 (9.)
 Trefferlage 0.03 mm links, 0.57 mm hoch
 Streuwert 1.20, horizontal: 1.18, vertikal: 1.23

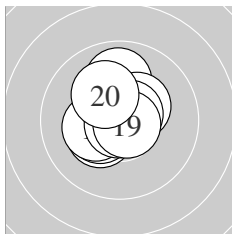

Serie 2:
 10.2 * 10.3 * 10.4 * 9.9 ↑ 10.4 *
 10.3 * 10.8 * 10.6 * 10.7 * 10.2 *
 beste Teiler 27.8 (17.) 55.0 (19.) 76.0 (18.)
 Trefferlage 0.30 mm links, 0.48 mm hoch
 Streuwert 1.07, horizontal: 0.93, vertikal: 1.20

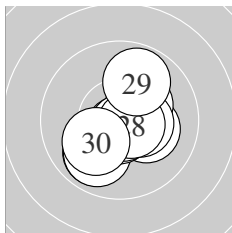

Serie 3:
 9.9 ↘ 10.2 * 9.9 ↘ 10.3 * 10.7 *
 10.7 * 10.4 * 10.6 * 9.8 ↗ 10.1 ↘
 beste Teiler 54.1 (26.) 66.1 (25.) 82.2 (28.)
 Trefferlage 0.19 mm rechts, 0.44 mm tief
 Streuwert 1.36, horizontal: 1.30, vertikal: 1.41

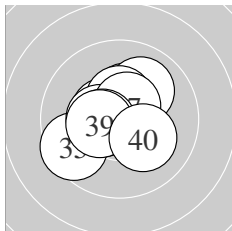

Serie 4:
 10.3 * 10.0 ↗ 10.5 * 10.4 * 9.5 ↘
 10.4 * 10.6 * 10.5 * 10.4 * 10.2 *
 beste Teiler 99.3 (37.) 109.5 (33.) 115.9 (38.)
 Trefferlage 0.39 mm links, 0.24 mm hoch
 Streuwert 1.31, horizontal: 1.42, vertikal: 1.19

Unterschrift des Schützen

Meyton Elektronik

Ergebnis: **409.1** (391)

Serien: 103.7 101.8 102.1 101.5

Zähler: 31 9 0 0 0 0 0 0 0 0

Innenzehner: 26

weiteste: 385 (13), 341 (23), 328 (33)

beste Teiler 15.8 (4.) 28.6 (11.) 78.2 (27.)

Trefferlage 0.20 mm links, 0.08 mm hoch

Streuwert 1.42, horizontal: 1.63, vertikal: 1.18

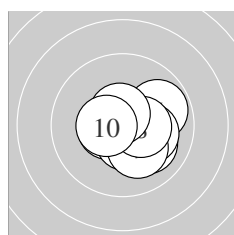
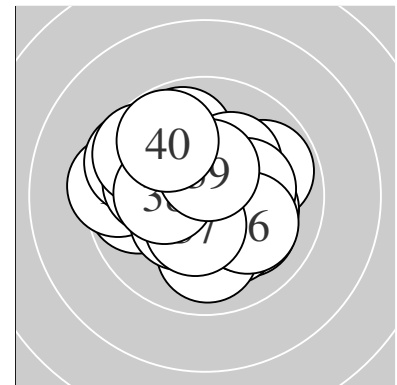

Serie 1:

10.5 *	10.1 ↘	10.5 *	10.9 *	9.8 ↗
10.2 *	10.2 *	10.4 *	10.6 *	10.5 *

beste Teiler 15.8 (4.) 86.8 (9.) 108.4 (1.)

Trefferlage 0.63 mm rechts, 0.30 mm tief

Streuwert 1.11, horizontal: 1.29, vertikal: 0.89

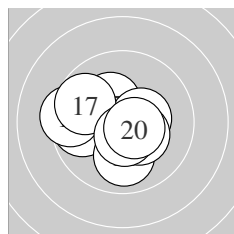

Serie 2:

10.8 *	9.8 ←	9.4 ←	10.0 ↓	10.3 *
10.4 *	9.7 ↖	10.3 *	10.5 *	10.6 *

beste Teiler 28.6 (11.) 96.6 (20.) 101.1 (19.)

Trefferlage 0.64 mm links, 0.17 mm tief

Streuwert 1.55, horizontal: 1.87, vertikal: 1.15

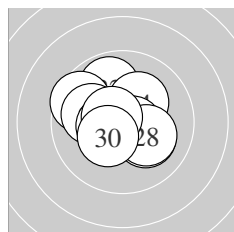

Serie 3:

10.1 ↘	9.9 ↗	9.6 ↖	10.2 *	10.0 ↖
10.5 *	10.6 *	10.2 *	10.6 *	10.4 *

beste Teiler 78.2 (27.) 87.2 (29.) 121.0 (26.)

Trefferlage 0.41 mm links, 0.27 mm hoch

Streuwert 1.47, horizontal: 1.66, vertikal: 1.24

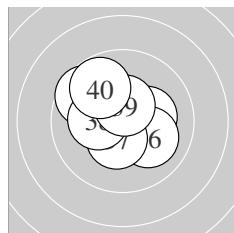

Serie 4:

10.4 *	9.9 ↗	9.6 ↖	10.4 *	10.2 *
10.1 ↘	10.4 *	10.2 *	10.5 *	9.8 ↘

beste Teiler 114.8 (39.) 135.0 (37.) 136.4 (34.)

Trefferlage 0.41 mm links, 0.56 mm hoch

Streuwert 1.48, horizontal: 1.58, vertikal: 1.36

Unterschrift des Schützen

Meyton Elektronik

Ergebnis: **411.0** (395)
 Serien: 102.7 104.0 101.3 103.0
 Zähler: 35 5 0 0 0 0 0 0 0 0
 Innenzehner: 29
 weiteste: 416 (4), 309 (9), 281 (34)
 beste Teiler 19.9 (11.) 50.4 (38.) 58.6 (2.)
 Trefferlage 0.06 mm rechts, 0.12 mm hoch
 Streuwert 1.33, horizontal: 1.45, vertikal: 1.19

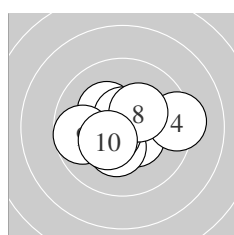
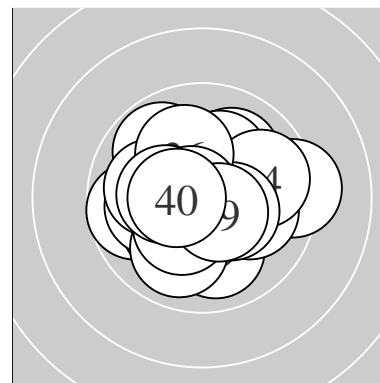

Serie 1:
 10.3 * 10.7 * 10.5 * 9.3 → 10.3 *
 10.6 * 10.6 * 10.3 * 9.7 ← 10.4 *
 beste Teiler 58.6 (2.) 82.0 (7.) 95.0 (6.)
 Trefferlage 0.00 mm , 0.02 mm tief
 Streuwert 1.51, horizontal: 1.90, vertikal: 0.96

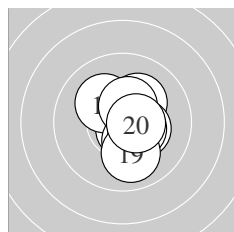

Serie 2:
 10.9 * 10.7 * 10.2 * 10.3 * 10.2 *
 10.3 * 10.4 * 10.5 * 10.0 ↓ 10.5 *
 beste Teiler 19.9 (11.) 59.4 (12.) 102.3 (20.)
 Trefferlage 0.54 mm rechts, 0.13 mm tief
 Streuwert 1.04, horizontal: 0.80, vertikal: 1.24

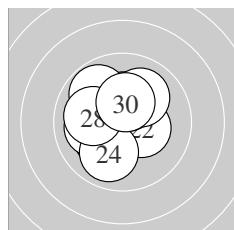

Serie 3:
 10.2 * 10.4 * 10.1 ← 9.9 ↙ 10.3 *
 10.3 * 9.8 ↘ 10.0 ← 10.0 ↗ 10.3 *
 beste Teiler 150.8 (22.) 152.5 (30.) 158.1 (25.)
 Trefferlage 0.53 mm links, 0.47 mm hoch
 Streuwert 1.45, horizontal: 1.40, vertikal: 1.50

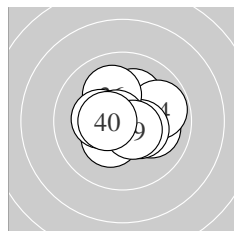

Serie 4:
 10.2 * 10.1 → 10.3 * 9.8 → 10.4 *
 10.1 ↘ 10.3 * 10.8 * 10.5 * 10.5 *
 beste Teiler 50.4 (38.) 101.4 (39.) 116.0 (40.)
 Trefferlage 0.26 mm rechts, 0.17 mm hoch
 Streuwert 1.30, horizontal: 1.49, vertikal: 1.07

Unterschrift des Schützen

Meyton Elektronik

Ergebnis:	413.2	(396) ^{QF}
Serien:	102.3	104.4 104.6 101.9
Zähler:	36	4 0 0 0 0 0 0 0 0
Innenzehner:	30	
weiteste:	485	(2), 385 (1), 310 (12)
beste Teiler	13.3	(27.) 13.8 (8.) 27.2 (15.)
Trefferlage	0.08	mm rechts, 0.04 mm tief
Streuwert	1.31,	horizontal: 1.60, vertikal: 0.95

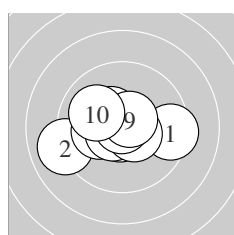
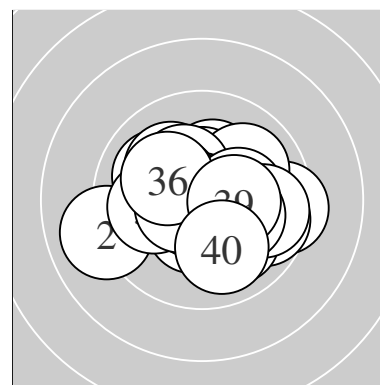

Serie 1:	9.4 →	9.0 ←	10.7 *	10.2 *	10.4 *
	10.6 *	10.5 *	10.9 *	10.6 *	10.0 ↖
beste Teiler	13.8	(8.) 57.2	(3.) 84.2	(9.)	
Trefferlage	0.51 mm links, 0.09 mm tief				
Streuwert	1.66, horizontal: 2.20, vertikal: 0.83				

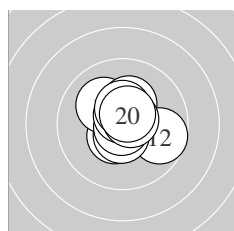

Serie 2:	10.5 *	9.7 →	10.6 *	10.1 ↖	10.8 *
	10.7 *	10.3 *	10.7 *	10.4 *	10.6 *
beste Teiler	27.2	(15.) 72.6	(16.) 74.7	(18.)	
Trefferlage	0.20 mm rechts, 0.32 mm hoch				
Streuwert	1.08, horizontal: 1.15, vertikal: 1.02				

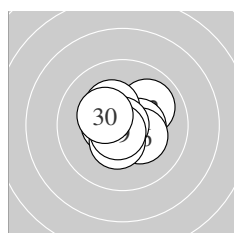

Serie 3:	10.7 *	10.0 ↗	10.5 *	10.5 *	10.3 *
	10.3 *	10.9 *	10.4 *	10.7 *	10.3 *
beste Teiler	13.3	(27.) 53.2	(21.) 65.2	(29.)	
Trefferlage	0.06 mm rechts, 0.12 mm hoch				
Streuwert	1.02, horizontal: 1.13, vertikal: 0.90				

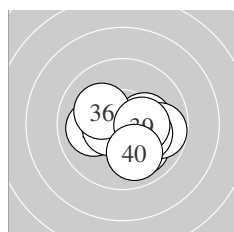

Serie 4:	10.6 *	10.0 ↘	10.0 ←	10.3 *	10.5 *
	10.2 *	9.8 →	10.2 *	10.3 *	10.0 ↘
beste Teiler	88.1	(31.) 104.1	(35.) 154.2	(39.)	
Trefferlage	0.58 mm rechts, 0.55 mm tief				
Streuwert	1.38, horizontal: 1.70, vertikal: 0.95				

QF – Schütze hat sich fürs Finale qualifiziert

Unterschrift des Schützen

Meyton Elektronik

Ergebnis: **413.6** (396)^{QF}
 Serien: 103.1 103.4 103.6 103.5
 Zähler: 36 4 0 0 0 0 0 0 0 0
 Innenzehner: 30
 weiteste: 294 (38), 287 (20), 265 (5)
 beste Teiler 40.4 (10.) 55.4 (7.) 57.7 (21.)
 Trefferlage 0.01 mm rechts, 0.00 mm
 Streuwert 1.20, horizontal: 1.37, vertikal: 1.00

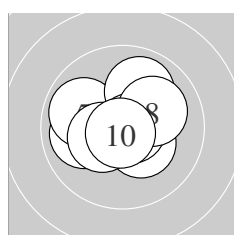
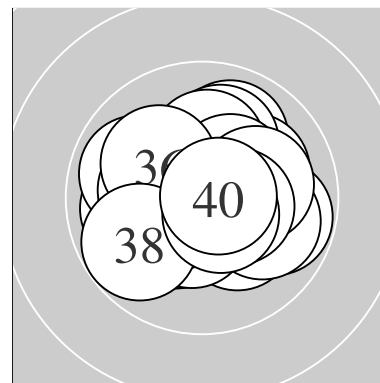

Serie 1:
 10.3 * 10.0 ← 10.7 * 10.3 * 9.9 ↖
 9.9 ↗ 10.7 * 10.1 ↘ 10.4 * 10.8 *
 beste Teiler 40.4 (10.) 55.4 (7.) 75.1 (3.)
 Trefferlage 0.07 mm links, 0.32 mm hoch
 Streuwert 1.31, horizontal: 1.57, vertikal: 1.00

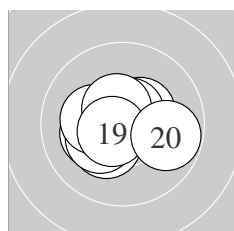

Serie 2:
 10.3 * 10.2 * 10.5 * 10.4 * 10.6 *
 10.3 * 10.2 * 10.5 * 10.6 * 9.8 →
 beste Teiler 81.8 (19.) 83.8 (15.) 106.0 (18.)
 Trefferlage 0.39 mm links, 0.12 mm tief
 Streuwert 1.17, horizontal: 1.46, vertikal: 0.78

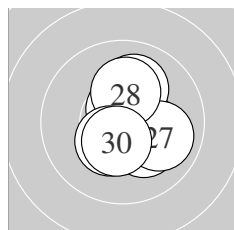

Serie 3:
 10.7 * 10.5 * 10.1 ↑ 10.5 * 10.6 *
 10.2 * 10.0 → 10.2 * 10.4 * 10.4 *
 beste Teiler 57.7 (21.) 83.7 (25.) 108.3 (24.)
 Trefferlage 0.46 mm rechts, 0.16 mm tief
 Streuwert 1.14, horizontal: 0.94, vertikal: 1.31

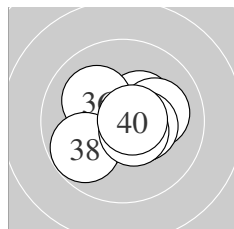

Serie 4:
 10.5 * 10.5 * 10.4 * 10.4 * 10.1 →
 10.1 ↖ 10.4 * 9.8 ↙ 10.6 * 10.7 *
 beste Teiler 63.3 (40.) 96.3 (39.) 113.8 (31.)
 Trefferlage 0.04 mm rechts, 0.00 mm
 Streuwert 1.24, horizontal: 1.51, vertikal: 0.91

QF – Schütze hat sich fürs Finale qualifiziert

Unterschrift des Schützen

Meyton Elektronik

Ergebnis: **410.3** (393)
 Serien: 102.6 102.8 103.2 101.7
 Zähler: 33 7 0 0 0 0 0 0 0 0
 Innenzehner: 25
 weiteste: 346 (4), 331 (30), 311 (18)
 beste Teiler 30.4 (27.) 64.6 (23.) 73.0 (12.)
 Trefferlage 0.00 mm , 0.10 mm hoch
 Streuwert 1.37, horizontal: 1.51, vertikal: 1.22

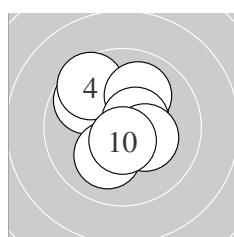
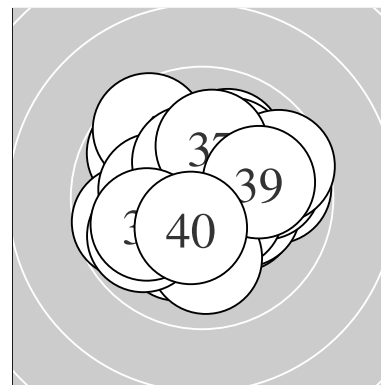

Serie 1:
 9.8 ↘ 10.1 ↙ 10.4 * 9.6 ↘ 10.6 *
 10.6 * 10.0 ↗ 10.6 * 10.3 * 10.6 *
 beste Teiler 81.3 (6.) 89.0 (10.) 90.8 (5.)
 Trefferlage 0.01 mm rechts, 0.42 mm hoch
 Streuwert 1.42, horizontal: 1.37, vertikal: 1.48

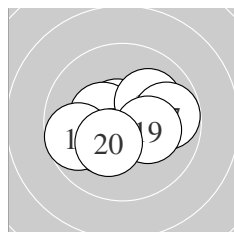

Serie 2:
 10.6 * 10.7 * 10.6 * 10.3 * 10.4 *
 10.1 ↗ 9.8 → 9.7 ← 10.3 * 10.3 *
 beste Teiler 73.0 (12.) 97.6 (11.) 98.6 (13.)
 Trefferlage 0.19 mm links, 0.24 mm tief
 Streuwert 1.40, horizontal: 1.76, vertikal: 0.89

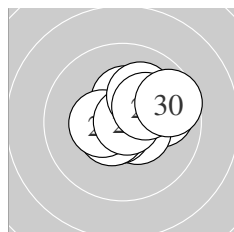

Serie 3:
 9.9 → 10.5 * 10.7 * 10.6 * 10.4 *
 10.4 * 10.8 * 10.1 ↗ 10.2 * 9.6 →
 beste Teiler 30.4 (27.) 64.6 (23.) 96.9 (24.)
 Trefferlage 0.73 mm rechts, 0.43 mm hoch
 Streuwert 1.18, horizontal: 1.40, vertikal: 0.92

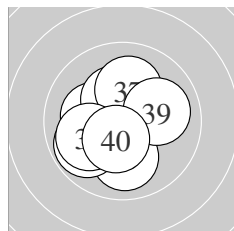

Serie 4:
 10.2 * 10.6 * 10.3 * 10.3 * 10.0 ↓
 9.8 ↙ 10.1 ↑ 10.0 ← 10.0 → 10.4 *
 beste Teiler 87.2 (32.) 128.1 (40.) 154.1 (33.)
 Trefferlage 0.56 mm links, 0.20 mm tief
 Streuwert 1.44, horizontal: 1.40, vertikal: 1.47

Unterschrift des Schützen

Meyton Elektronik

Ergebnis: **412.8** (393)
 Serien: 102.8 103.0 103.9 103.1
 Zähler: 33 7 0 0 0 0 0 0 0 0
 Innenzehner: 29
 weiteste: 433 (23), 354 (10), 291 (2)
 beste Teiler 16.5 (29.) 37.3 (32.) 38.1 (22.)
 Trefferlage 0.05 mm rechts, 0.14 mm hoch
 Streuwert 1.31, horizontal: 1.19, vertikal: 1.42

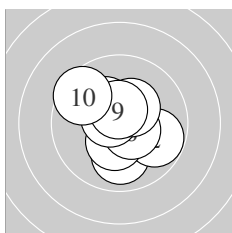
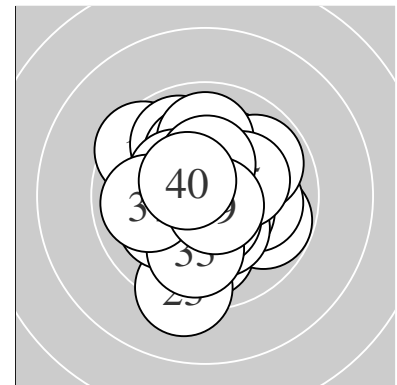

Serie 1:
 10.0 ↓ 9.8 ↘ 10.8 * 10.4 * 10.3 *
 10.5 * 10.6 * 10.4 * 10.5 * 9.5 ↖
 beste Teiler 45.6 (3.) 84.5 (7.) 104.4 (9.)
 Trefferlage 0.01 mm links, 0.04 mm hoch
 Streuwert 1.44, horizontal: 1.45, vertikal: 1.43

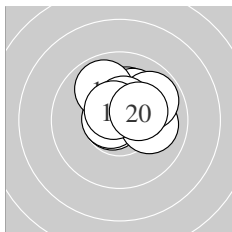

Serie 2:
 10.7 * 10.7 * 10.0 → 10.2 * 10.2 *
 9.9 ↗ 9.9 ↘ 10.5 * 10.6 * 10.3 *
 beste Teiler 54.2 (11.) 67.4 (12.) 90.2 (19.)
 Trefferlage 0.49 mm rechts, 0.97 mm hoch
 Streuwert 1.09, horizontal: 1.24, vertikal: 0.90

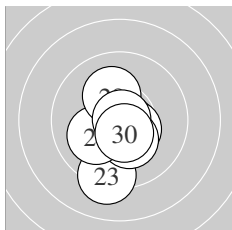

Serie 3:
 10.7 * 10.8 * 9.2 ↓ 10.7 * 10.5 *
 10.3 * 10.1 ↙ 10.2 * 10.9 * 10.5 *
 beste Teiler 16.5 (29.) 38.1 (22.) 53.8 (24.)
 Trefferlage 0.09 mm links, 0.79 mm tief
 Streuwert 1.23, horizontal: 0.84, vertikal: 1.52

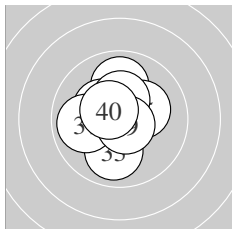

Serie 4:
 9.9 ↑ 10.8 * 10.0 ↓ 10.4 * 10.2 *
 10.3 * 9.9 ← 10.4 * 10.7 * 10.5 *
 beste Teiler 37.3 (32.) 64.3 (39.) 107.0 (40.)
 Trefferlage 0.17 mm links, 0.34 mm hoch
 Streuwert 1.28, horizontal: 1.21, vertikal: 1.34

Unterschrift des Schützen

Meyton Elektronik

Ergebnis: **391.2** (372)

Serien: 99.7 97.8 94.8 98.9

Zähler: 14 24 2 0 0 0 0 0 0 0

Innenzehner: 11

weiteste: 652 (20), 601 (26), 498 (25)

beste Teiler 26.1 (16.) 38.0 (5.) 44.6 (14.)

Trefferlage 0.62 mm links, 0.58 mm hoch

Streuwert 2.23, horizontal: 2.18, vertikal: 2.29

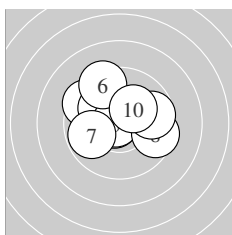
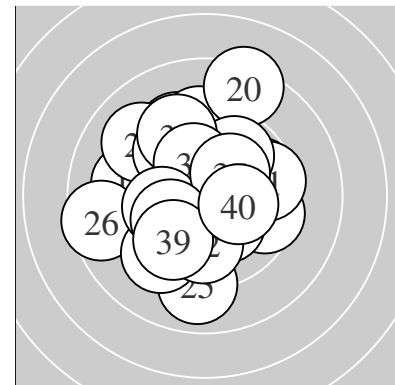

Serie 1:

10.8 *	9.9 ↖	9.5 ↘	10.1 ↘	10.8 *
9.4 ↗	9.8 ↙	9.5 →	9.7 →	10.2 *

beste Teiler 38.0 (5.) 50.0 (1.) 186.0 (10.)

Trefferlage 0.46 mm links, 0.78 mm hoch

Streuwert 1.91, horizontal: 2.31, vertikal: 1.40

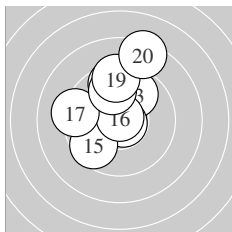

Serie 2:

10.4 *	9.6 ↑	9.8 ↗	10.8 *	9.6 ↙
10.8 *	9.3 ←	9.8 ↑	9.4 ↑	8.3 ↑

beste Teiler 26.1 (16.) 44.6 (14.) 138.8 (11.)

Trefferlage 0.39 mm links, 1.83 mm hoch

Streuwert 2.14, horizontal: 1.82, vertikal: 2.41

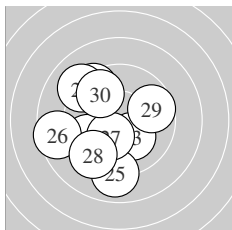

Serie 3:

9.4 ↘	9.1 ↖	10.2 *	9.6 ↙	9.0 ↓
8.5 ←	10.3 *	9.3 ↘	9.7 →	9.7 ↘

beste Teiler 174.6 (27.) 191.4 (23.) 307.6 (30.)

Trefferlage 1.63 mm links, 0.47 mm tief

Streuwert 2.63, horizontal: 2.50, vertikal: 2.75

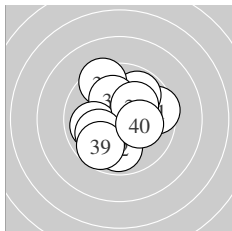

Serie 4:

9.5 →	9.9 ↓	9.8 ↗	9.4 ↗	10.2 *
10.0 ←	10.2 *	10.0 ↙	9.7 ↘	10.2 *

beste Teiler 189.7 (37.) 193.7 (40.) 196.0 (35.)

Trefferlage 0.01 mm links, 0.21 mm hoch

Streuwert 2.03, horizontal: 2.00, vertikal: 2.06

Unterschrift des Schützen

Meyton Elektronik

Ergebnis: **409.6** (392)
 Serien: 103.1 101.4 103.0 102.1
 Zähler: 32 8 0 0 0 0 0 0 0 0
 Innenzehner: 25
 weiteste: 372 (18), 342 (40), 336 (13)
 beste Teiler 65.0 (28.) 72.3 (11.) 79.1 (3.)
 Trefferlage 0.19 mm rechts, 0.42 mm hoch
 Streuwert 1.38, horizontal: 1.53, vertikal: 1.19

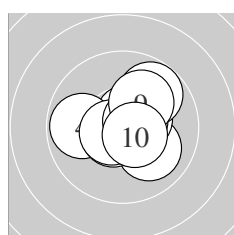
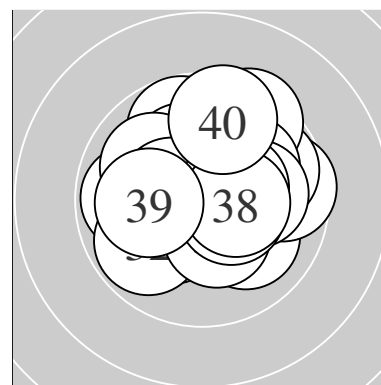

Serie 1:
 10.0 ↘ 10.4 * 10.6 * 9.8 ← 10.6 *
 10.6 * 9.8 ↗ 10.6 * 10.1 ↗ 10.6 *
 beste Teiler 79.1 (3.) 80.4 (5.) 82.2 (6.)
 Trefferlage 0.41 mm rechts, 0.28 mm hoch
 Streuwert 1.28, horizontal: 1.44, vertikal: 1.10

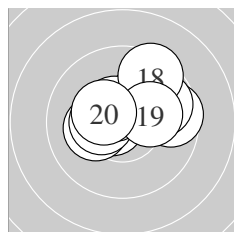

Serie 2:
 10.7 * 10.2 * 9.6 → 10.1 ↗ 10.4 *
 9.8 ↗ 10.5 * 9.5 ↗ 10.2 * 10.4 *
 beste Teiler 72.3 (11.) 107.7 (17.) 145.0 (15.)
 Trefferlage 0.51 mm rechts, 0.82 mm hoch
 Streuwert 1.52, horizontal: 1.89, vertikal: 1.04

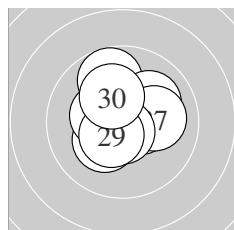

Serie 3:
 10.4 * 9.8 ↖ 10.3 * 10.4 * 10.1 ↗
 10.5 * 10.1 → 10.7 * 10.5 * 10.2 *
 beste Teiler 65.0 (28.) 116.9 (29.) 122.0 (26.)
 Trefferlage 0.13 mm rechts, 0.47 mm hoch
 Streuwert 1.30, horizontal: 1.33, vertikal: 1.27

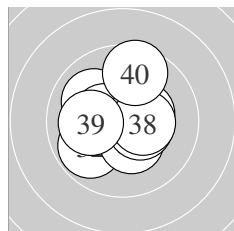

Serie 4:
 10.6 * 9.8 ↖ 10.0 ↘ 10.4 * 10.4 *
 10.4 * 10.4 * 10.4 * 10.1 ← 9.6 ↗
 beste Teiler 85.0 (31.) 128.3 (34.) 128.7 (37.)
 Trefferlage 0.29 mm links, 0.14 mm hoch
 Streuwert 1.48, horizontal: 1.54, vertikal: 1.42

Unterschrift des Schützen

Meyton Elektronik

Ergebnis: **403.8** (388)
 Serien: 99.4 102.2 101.9 100.3
 Zähler: 28 12 0 0 0 0 0 0 0 0
 Innenzehner: 20
 weiteste: 475 (40), 468 (22), 465 (37)
 beste Teiler 35.2 (31.) 55.0 (34.) 59.0 (12.)
 Trefferlage 0.34 mm rechts, 0.75 mm hoch
 Streuwert 1.67, horizontal: 1.97, vertikal: 1.30

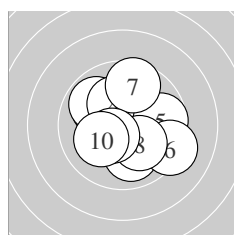
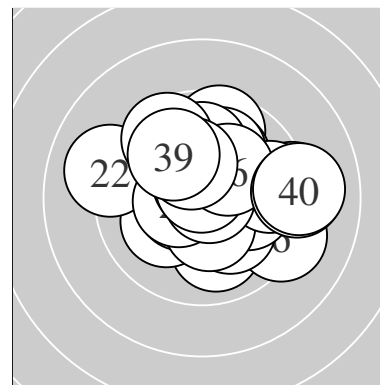

Serie 1:
 10.0 ↘ 9.9 ↘ 10.0 ↓ 10.2 * 9.7 →
 9.2 ↘ 9.6 ↑ 10.2 * 10.5 * 10.1 ↙
 beste Teiler 121.6 (9.) 186.0 (4.) 200.8 (8.)
 Trefferlage 0.25 mm rechts, 0.08 mm hoch
 Streuwert 1.98, horizontal: 2.09, vertikal: 1.87

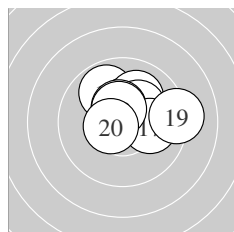

Serie 2:
 9.9 ↘ 10.7 * 10.4 * 10.1 ↗ 10.3 *
 10.5 * 10.1 → 10.5 * 9.2 → 10.5 *
 beste Teiler 59.0 (12.) 101.5 (20.) 111.1 (18.)
 Trefferlage 0.59 mm rechts, 0.94 mm hoch
 Streuwert 1.37, horizontal: 1.72, vertikal: 0.90

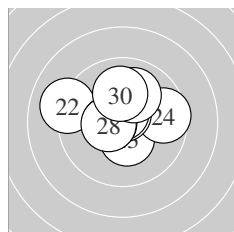

Serie 3:
 10.5 * 9.1 ↖ 10.4 * 9.6 → 10.7 *
 10.6 * 10.5 * 10.5 * 10.0 ↑ 10.0 ↑
 beste Teiler 65.6 (25.) 76.5 (26.) 109.4 (27.)
 Trefferlage 0.19 mm links, 0.72 mm hoch
 Streuwert 1.59, horizontal: 1.96, vertikal: 1.10

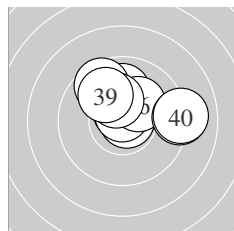

Serie 4:
 10.8 * 10.0 ↑ 10.6 * 10.7 * 9.6 ↘
 10.2 * 9.1 → 10.3 * 9.9 ↘ 9.1 →
 beste Teiler 35.2 (31.) 55.0 (34.) 77.8 (33.)
 Trefferlage 0.71 mm rechts, 1.26 mm hoch
 Streuwert 1.74, horizontal: 2.25, vertikal: 0.99

Unterschrift des Schützen

Meyton Elektronik

Ergebnis: **394.1** (374)
 Serien: 98.1 95.8 101.1 99.1
 Zähler: 17 20 3 0 0 0 0 0 0 0
 Innenzehner: 14
 weiteste: 637 (19), 563 (7), 543 (34)
 beste Teiler 34.0 (32.) 38.0 (21.) 51.0 (30.)
 Trefferlage 0.07 mm rechts, 0.43 mm tief
 Streuwert 2.23, horizontal: 2.47, vertikal: 1.97

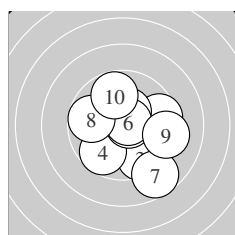
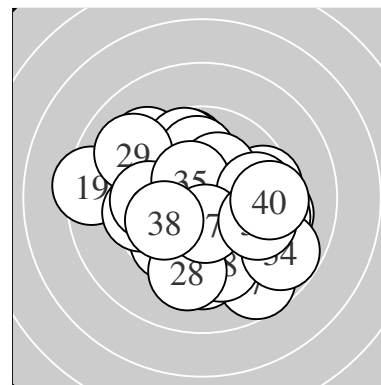

Serie 1:
 9.5 → 10.4 * 9.6 ↘ 9.7 ✓ 10.7 *
 10.7 * 8.7 ↘ 9.7 ← 9.3 → 9.8 ↑
 beste Teiler 60.2 (5.) 62.2 (6.) 141.1 (2.)
 Trefferlage 0.84 mm rechts, 0.52 mm tief
 Streuwert 2.30, horizontal: 2.33, vertikal: 2.27

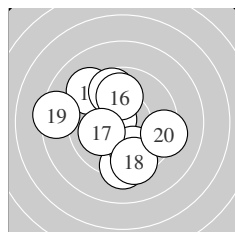

Serie 2:
 10.6 * 9.3 ↓ 9.2 ↖ 9.7 ↑ 9.8 ↓
 10.0 ↑ 10.1 ← 9.4 ↓ 8.4 ← 9.3 →
 beste Teiler 93.6 (11.) 221.8 (17.) 246.7 (16.)
 Trefferlage 0.76 mm links, 0.32 mm tief
 Streuwert 2.70, horizontal: 2.75, vertikal: 2.64

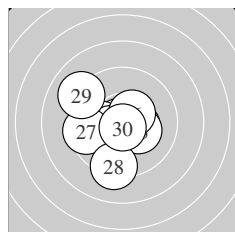

Serie 3:
 10.8 * 10.4 * 10.3 * 10.1 ← 10.5 *
 10.5 * 9.5 ← 9.2 ↓ 9.1 ↖ 10.7 *
 beste Teiler 38.0 (21.) 51.0 (30.) 121.0 (26.)
 Trefferlage 0.80 mm links, 0.41 mm tief
 Streuwert 1.79, horizontal: 1.89, vertikal: 1.68

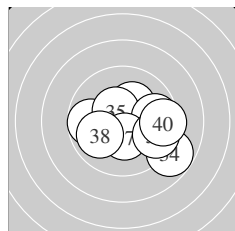

Serie 4:
 10.3 * 10.8 * 9.7 ← 8.8 ↘ 10.5 *
 9.7 → 10.4 * 9.9 ← 9.6 → 9.4 →
 beste Teiler 34.0 (32.) 120.6 (35.) 149.2 (37.)
 Trefferlage 1.01 mm rechts, 0.46 mm tief
 Streuwert 2.05, horizontal: 2.58, vertikal: 1.34

Unterschrift des Schützen

Ergebnis:	408.3	(392)
Serien:	102.8	102.5 101.5 101.5
Zähler:	32	8 0 0 0 0 0 0 0 0
Innenzehner:	24	
weiteste:	421	(7), 397 (23), 345 (34)
beste Teiler	24.4	(39.) 31.2 (12.) 53.4 (21.)
Trefferlage	0.05 mm rechts, 0.69 mm hoch	
Streuwert	1.41, horizontal: 1.24, vertikal: 1.55	

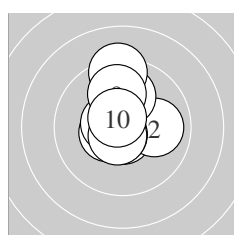
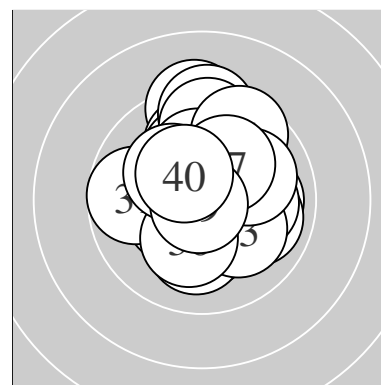

Serie 1:	10.7 *	10.0 →	10.5 *	10.5 *	10.7 *
	10.0 ↑	9.3 ↑	10.6 *	9.9 ↑	10.6 *
beste Teiler	60.1 (1.) 66.0 (5.) 76.3 (8.)				
Trefferlage	0.12 mm links, 0.78 mm hoch				
Streuwert	1.38, horizontal: 0.99, vertikal: 1.68				

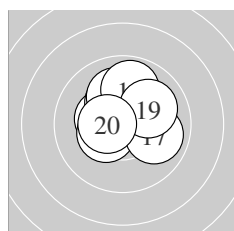

Serie 2:	10.4 *	10.8 *	10.3 *	10.2 *	10.1 ↑
	10.4 *	9.9 ↘	9.9 ↑	10.0 ↗	10.5 *
beste Teiler	31.2 (12.) 118.0 (20.) 144.5 (16.)				
Trefferlage	0.15 mm rechts, 0.72 mm hoch				
Streuwert	1.30, horizontal: 1.43, vertikal: 1.15				

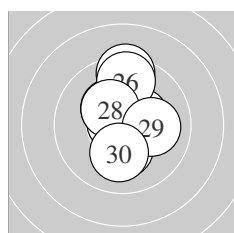

Serie 3:	10.7 *	10.3 *	9.4 ↑	10.4 *	10.4 *
	9.6 ↑	10.2 *	10.3 *	10.1 →	10.1 ↓
beste Teiler	53.4 (21.) 126.4 (25.) 140.4 (24.)				
Trefferlage	0.16 mm rechts, 0.54 mm hoch				
Streuwert	1.59, horizontal: 0.98, vertikal: 2.02				

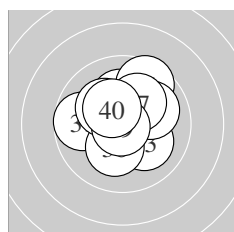

Serie 4:	9.7 ←	10.2 *	10.1 ↘	9.6 ↗	10.0 ↗
	10.2 *	10.2 *	10.2 *	10.9 *	10.4 *
beste Teiler	24.4 (39.) 146.1 (40.) 185.9 (36.)				
Trefferlage	0.04 mm rechts, 0.70 mm hoch				
Streuwert	1.55, horizontal: 1.63, vertikal: 1.48				

Unterschrift des Schützen

Ergebnis: **411.0** (390)
 Serien: 103.2 102.7 102.7 102.4
 Zähler: 30 10 0 0 0 0 0 0 0 0
 Innenzehner: 23
 weiteste: 362 (32), 360 (12), 349 (22)
 beste Teiler 10.8 (4.) 27.0 (16.) 31.3 (37.)
 Trefferlage 0.16 mm rechts, 0.37 mm hoch
 Streuwert 1.37, horizontal: 1.41, vertikal: 1.32

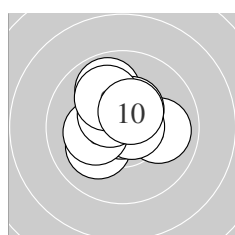
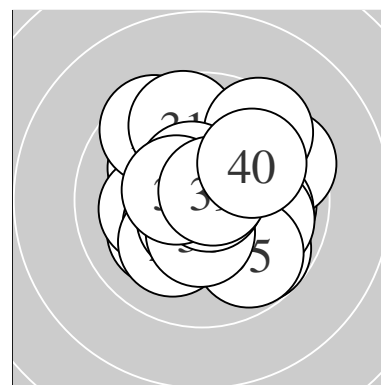

Serie 1:
 9.9 ↖ 10.1 ↙ 10.0 → 10.9 * 10.7 *
 10.2 * 10.5 * 10.4 * 10.0 ↖ 10.5 *
 beste Teiler 10.8 (4.) 63.1 (5.) 120.7 (10.)
 Trefferlage 0.23 mm links, 0.59 mm hoch
 Streuwert 1.24, horizontal: 1.32, vertikal: 1.16

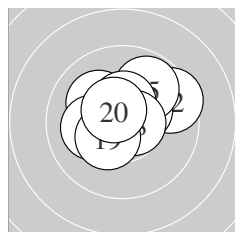

Serie 2:
 10.1 ↖ 9.5 ↗ 10.1 ← 10.4 * 9.8 ↗
 10.8 * 10.4 * 10.7 * 10.4 * 10.5 *
 beste Teiler 27.0 (16.) 72.1 (18.) 102.4 (20.)
 Trefferlage 0.16 mm rechts, 0.68 mm hoch
 Streuwert 1.33, horizontal: 1.61, vertikal: 0.98

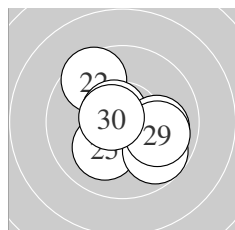

Serie 3:
 10.7 * 9.6 ↖ 10.7 * 10.7 * 10.1 ↙
 10.6 * 10.0 → 9.8 ↘ 9.9 → 10.6 *
 beste Teiler 52.8 (21.) 64.0 (23.) 74.0 (24.)
 Trefferlage 0.30 mm rechts, 0.25 mm tief
 Streuwert 1.47, horizontal: 1.56, vertikal: 1.36

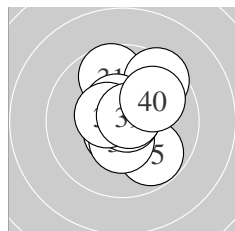

Serie 4:
 9.7 ↖ 9.5 ↗ 10.6 * 10.5 * 9.8 ↘
 10.4 * 10.8 * 10.5 * 10.7 * 9.9 ↗
 beste Teiler 31.3 (37.) 58.2 (39.) 88.3 (33.)
 Trefferlage 0.42 mm rechts, 0.49 mm hoch
 Streuwert 1.48, horizontal: 1.24, vertikal: 1.68

Unterschrift des Schützen

Ergebnis: **410.6** (391)
 Serien: 104.0 102.0 101.5 103.1
 Zähler: 31 9 0 0 0 0 0 0 0 0
 Innenzehner: 26
 weiteste: 412 (30), 367 (11), 315 (22)
 beste Teiler 10.7 (31.) 45.6 (16.) 58.0 (27.)
 Trefferlage 0.04 mm links, 0.06 mm tief
 Streuwert 1.41, horizontal: 1.60, vertikal: 1.20

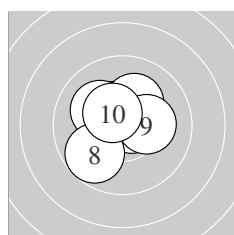
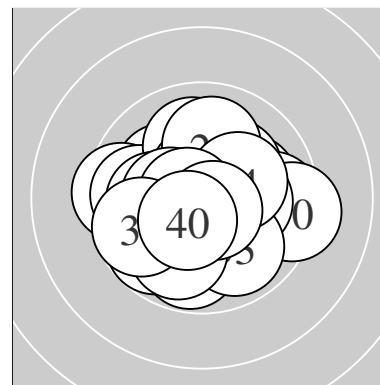

Serie 1:
 10.7 * 10.7 * 10.5 * 10.6 * 10.7 *
 10.2 * 10.1 ↖ 9.8 ↙ 10.2 * 10.5 *
 beste Teiler 63.6 (1.) 69.0 (5.) 73.3 (2.)
 Trefferlage 0.28 mm links, 0.39 mm hoch
 Streuwert 1.13, horizontal: 1.22, vertikal: 1.03

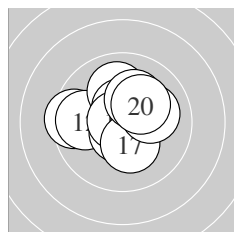

Serie 2:
 9.5 ← 9.8 ← 10.0 ↑ 10.6 * 10.5 *
 10.8 * 10.3 * 10.1 → 10.2 * 10.2 *
 beste Teiler 45.6 (16.) 86.0 (14.) 106.4 (15.)
 Trefferlage 0.28 mm links, 0.52 mm hoch
 Streuwert 1.50, horizontal: 1.78, vertikal: 1.17

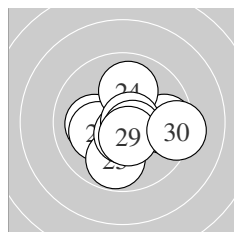

Serie 3:
 10.1 ← 9.7 → 10.2 * 10.0 ↑ 9.8 ↓
 10.6 * 10.7 * 10.6 * 10.5 * 9.3 →
 beste Teiler 58.0 (27.) 90.2 (26.) 96.0 (28.)
 Trefferlage 0.50 mm rechts, 0.46 mm tief
 Streuwert 1.63, horizontal: 1.93, vertikal: 1.27

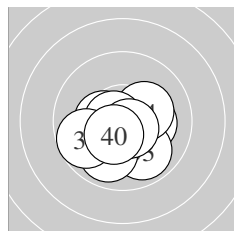

Serie 4:
 10.9 * 10.2 * 9.9 ↘ 10.2 * 10.4 *
 10.7 * 9.9 ↙ 9.7 ← 10.7 * 10.5 *
 beste Teiler 10.7 (31.) 67.0 (36.) 75.1 (39.)
 Trefferlage 0.11 mm links, 0.69 mm tief
 Streuwert 1.28, horizontal: 1.49, vertikal: 1.02

Unterschrift des Schützen

Meyton Elektronik

Ergebnis: **416.3** (397)^{QF}
 Serien: 103.5 103.9 104.2 104.7
 Zähler: 37 3 0 0 0 0 0 0 0 0
 Innenzehner: 33
 weiteste: 306 (9), 271 (24), 266 (32)
 beste Teiler 9.0 (28.) 10.0 (34.) 45.3 (13.)
 Trefferlage 0.21 mm links, 0.19 mm hoch
 Streuwert 1.09, horizontal: 1.13, vertikal: 1.05

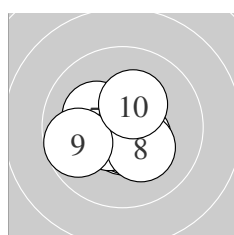
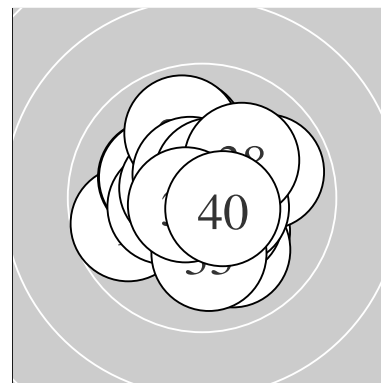

Serie 1:
 10.2 * 10.5 * 10.6 * 10.6 * 10.7 *
 10.5 * 10.2 * 10.2 * 9.7 ← 10.3 *
 beste Teiler 55.1 (5.) 83.5 (4.) 86.0 (3.)
 Trefferlage 0.46 mm links, 0.24 mm tief
 Streuwert 1.13, horizontal: 1.33, vertikal: 0.90

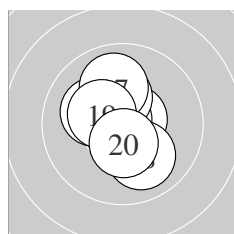

Serie 2:
 10.7 * 10.7 * 10.8 * 10.4 * 10.2 *
 10.2 * 10.0 ↑ 10.0 ↓ 10.4 * 10.5 *
 beste Teiler 45.3 (13.) 65.7 (11.) 72.9 (12.)
 Trefferlage 0.42 mm links, 0.41 mm hoch
 Streuwert 1.11, horizontal: 0.92, vertikal: 1.28

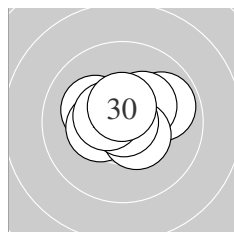

Serie 3:
 10.5 * 10.4 * 10.2 * 9.9 → 10.4 *
 10.3 * 10.5 * 10.9 * 10.5 * 10.6 *
 beste Teiler 9.0 (28.) 99.1 (30.) 106.4 (29.)
 Trefferlage 0.20 mm links, 0.29 mm hoch
 Streuwert 1.10, horizontal: 1.42, vertikal: 0.66

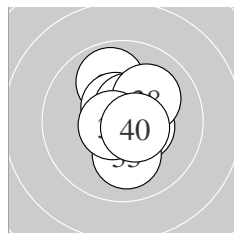

Serie 4:
 10.5 * 9.9 ↑ 10.1 ↓ 10.9 * 10.5 *
 10.8 * 10.6 * 10.1 ↗ 10.7 * 10.6 *
 beste Teiler 10.0 (34.) 48.7 (36.) 70.3 (39.)
 Trefferlage 0.24 mm rechts, 0.29 mm hoch
 Streuwert 1.05, horizontal: 0.77, vertikal: 1.28

QF – Schütze hat sich fürs Finale qualifiziert

Unterschrift des Schützen

Meyton Elektronik

Ergebnis: **386.6** (367)
 Serien: 94.6 98.2 100.0 93.8
 Zähler: 17 14 8 1 0 0 0 0 0 0
 Innenzehner: 14
 weiteste: 836 (8), 680 (3), 638 (16)
 beste Teiler 30.3 (36.) 66.3 (21.) 92.6 (19.)
 Trefferlage 0.28 mm rechts, 0.86 mm hoch
 Streuwert 2.60, horizontal: 2.99, vertikal: 2.14

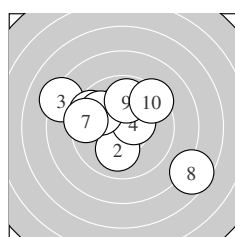
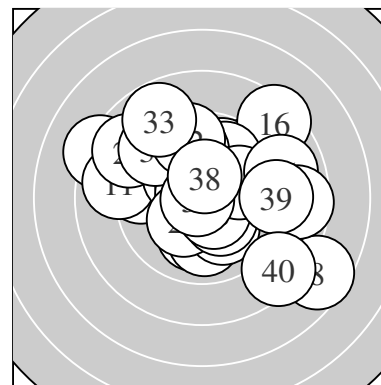

Serie 1:
 10.2 * 10.0 ↓ 8.2 ↖ 10.5 * 9.5 ↖
 9.9 ↖ 9.4 ← 7.6 ↘ 9.9 ↑ 9.4 ↗
 beste Teiler 121.4 (4.) 194.0 (1.) 226.8 (2.)
 Trefferlage 0.47 mm links, 0.73 mm hoch
 Streuwert 3.13, horizontal: 3.73, vertikal: 2.38

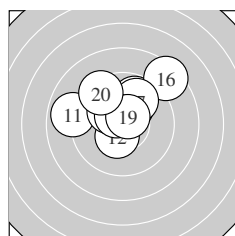

Serie 2:
 8.9 ↖ 10.4 * 9.8 ↑ 10.2 * 10.2 *
 8.4 ↗ 9.8 ↑ 10.5 * 10.6 * 9.4 ↖
 beste Teiler 92.6 (19.) 104.6 (18.) 134.2 (12.)
 Trefferlage 0.13 mm links, 1.71 mm hoch
 Streuwert 2.10, horizontal: 2.51, vertikal: 1.60

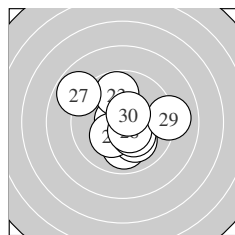

Serie 3:
 10.7 * 9.9 ↓ 9.8 ↑ 10.1 ↘ 10.3 *
 10.3 * 8.8 ↖ 10.5 * 9.1 → 10.5 *
 beste Teiler 66.3 (21.) 101.2 (30.) 112.1 (28.)
 Trefferlage 0.17 mm rechts, 0.05 mm tief
 Streuwert 2.09, horizontal: 2.29, vertikal: 1.87

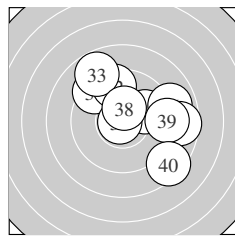

Serie 4:
 9.3 ↖ 9.5 ↑ 8.8 ↖ 10.0 → 8.9 →
 10.8 * 8.6 → 10.4 * 9.1 → 8.4 ↘
 beste Teiler 30.3 (36.) 131.9 (38.) 245.6 (34.)
 Trefferlage 1.56 mm rechts, 1.05 mm hoch
 Streuwert 2.91, horizontal: 3.25, vertikal: 2.52

Unterschrift des Schützen

Meyton Elektronik

Ergebnis: **410.8** (394)
 Serien: 103.9 101.9 103.7 101.3
 Zähler: 34 6 0 0 0 0 0 0 0 0
 Innenzehner: 25
 weiteste: 410 (12), 335 (37), 330 (39)
 beste Teiler 37.6 (40.) 53.2 (2.) 70.0 (26.)
 Trefferlage 0.28 mm rechts, 0.10 mm tief
 Streuwert 1.35, horizontal: 1.42, vertikal: 1.27

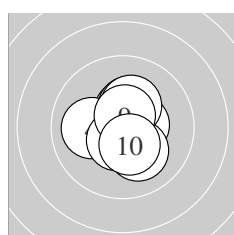
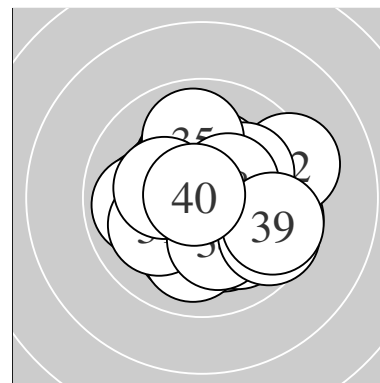

Serie 1:
 10.5 * 10.7 * 10.5 * 10.0 ← 10.5 *
 10.3 * 10.1 ↘ 10.3 * 10.6 * 10.4 *
 beste Teiler 53.2 (2.) 87.4 (9.) 103.4 (5.)
 Trefferlage 0.12 mm rechts, 0.08 mm hoch
 Streuwert 1.09, horizontal: 0.99, vertikal: 1.17

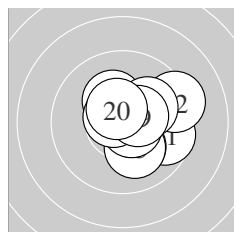

Serie 2:
 9.7 → 9.3 → 10.3 * 10.1 ↘ 10.1 ↘
 10.1 → 10.7 * 10.6 * 10.5 * 10.5 *
 beste Teiler 75.1 (17.) 76.6 (18.) 106.1 (20.)
 Trefferlage 1.05 mm rechts, 0.10 mm hoch
 Streuwert 1.41, horizontal: 1.53, vertikal: 1.28

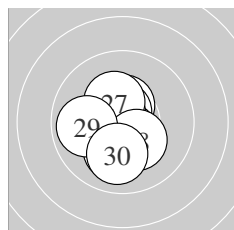

Serie 3:
 10.5 * 10.7 * 10.6 * 10.6 * 10.1 ↓
 10.7 * 10.3 * 10.3 * 9.9 ← 10.0 ↓
 beste Teiler 70.0 (26.) 75.8 (22.) 89.6 (23.)
 Trefferlage 0.43 mm links, 0.29 mm tief
 Streuwert 1.15, horizontal: 0.95, vertikal: 1.32

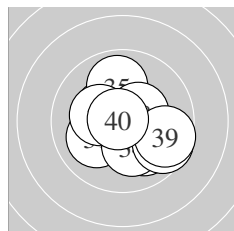

Serie 4:
 10.1 ↙ 10.4 * 10.0 ↘ 10.2 * 9.9 ↑
 10.3 * 9.6 ↘ 10.4 * 9.6 → 10.8 *
 beste Teiler 37.6 (40.) 129.7 (38.) 150.9 (32.)
 Trefferlage 0.38 mm rechts, 0.29 mm tief
 Streuwert 1.63, horizontal: 1.81, vertikal: 1.43

Unterschrift des Schützen

Meyton Elektronik

Ergebnis: **414.1** (394)^{QF}
 Serien: 102.7 103.9 105.4 102.1
 Zähler: 34 6 0 0 0 0 0 0 0 0
 Innenzehner: 28
 weiteste: 393 (1), 291 (35), 282 (36)
 beste Teiler 8.0 (4.) 47.6 (34.) 51.7 (17.)
 Trefferlage 0.34 mm links, 0.00 mm
 Streuwert 1.21, horizontal: 1.42, vertikal: 0.94

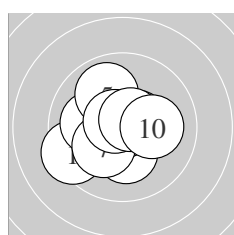
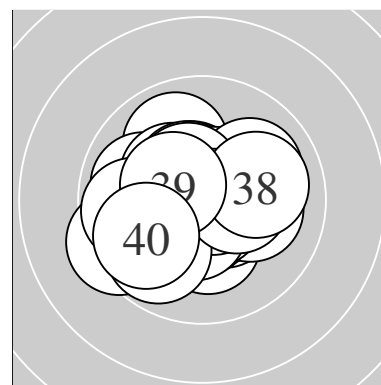

Serie 1:
 9.4 ← 10.1 ← 10.3 * 10.9 * 9.9 ↗
 10.5 * 10.2 * 10.7 * 10.6 * 10.1 →
 beste Teiler 8.0 (4.) 67.8 (8.) 77.1 (9.)
 Trefferlage 0.47 mm links, 0.08 mm tief
 Streuwert 1.44, horizontal: 1.62, vertikal: 1.24

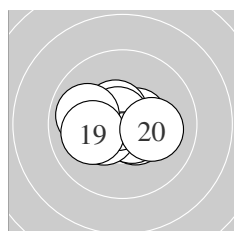

Serie 2:
 10.6 * 10.5 * 10.6 * 10.4 * 10.4 *
 10.6 * 10.7 * 9.9 ← 10.1 ← 10.1 →
 beste Teiler 51.7 (17.) 84.8 (13.) 99.9 (11.)
 Trefferlage 0.34 mm links, 0.05 mm tief
 Streuwert 1.12, horizontal: 1.48, vertikal: 0.57

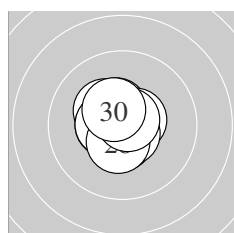

Serie 3:
 10.5 * 10.6 * 10.3 * 10.5 * 10.6 *
 10.5 * 10.7 * 10.5 * 10.7 * 10.5 *
 beste Teiler 53.0 (29.) 71.2 (27.) 94.5 (22.)
 Trefferlage 0.32 mm links, 0.12 mm hoch
 Streuwert 0.78, horizontal: 0.72, vertikal: 0.83

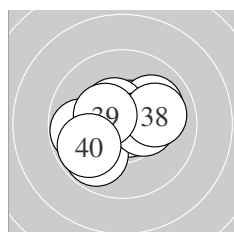

Serie 4:
 10.6 * 10.0 ↗ 10.5 * 10.8 * 9.8 ←
 9.8 ↘ 10.4 * 10.0 → 10.4 * 9.8 ←
 beste Teiler 47.6 (34.) 99.1 (31.) 117.8 (33.)
 Trefferlage 0.21 mm links, 0.01 mm hoch
 Streuwert 1.52, horizontal: 1.85, vertikal: 1.11

QF – Schütze hat sich fürs Finale qualifiziert

Unterschrift des Schützen

Meyton Elektronik

Ergebnis: **408.8** (390)
 Serien: 102.0 101.8 101.5 103.5
 Zähler: 30 10 0 0 0 0 0 0 0 0
 Innenzehner: 23
 weiteste: 434 (5), 371 (15), 365 (17)
 beste Teiler 36.6 (33.) 48.0 (31.) 63.6 (12.)
 Trefferlage 0.83 mm links, 0.51 mm hoch
 Streuwert 1.32, horizontal: 1.42, vertikal: 1.21

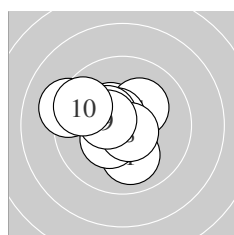
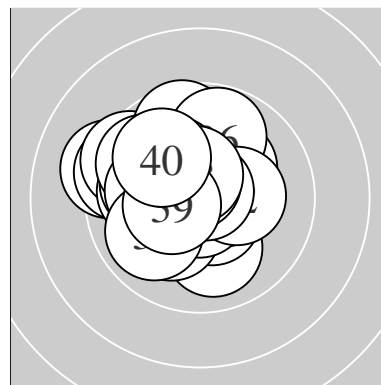

Serie 1:
 10.0 ↓ 10.4 * 10.4 * 10.2 * 9.2 ↖
 10.6 * 10.4 * 10.7 * 10.5 * 9.6 ↖
 beste Teiler 71.4 (8.) 79.5 (6.) 124.6 (9.)
 Trefferlage 0.95 mm links, 0.30 mm hoch
 Streuwert 1.44, horizontal: 1.64, vertikal: 1.22

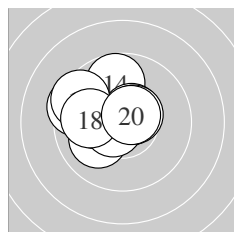

Serie 2:
 10.1 ↙ 10.7 * 10.6 * 9.7 ↑ 9.5 ↖
 10.6 * 9.5 ↘ 10.0 ← 10.5 * 10.6 *
 beste Teiler 63.6 (12.) 83.2 (13.) 83.7 (20.)
 Trefferlage 0.97 mm links, 0.67 mm hoch
 Streuwert 1.44, horizontal: 1.68, vertikal: 1.14

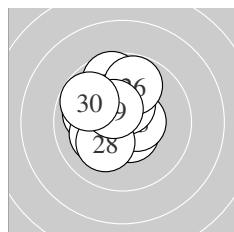

Serie 3:
 10.6 * 9.7 ↑ 10.5 * 10.4 * 10.0 ↖
 9.8 ↑ 10.1 ↙ 10.1 ↙ 10.5 * 9.8 ↖
 beste Teiler 99.0 (21.) 107.0 (23.) 120.9 (29.)
 Trefferlage 0.68 mm links, 0.72 mm hoch
 Streuwert 1.44, horizontal: 1.31, vertikal: 1.56

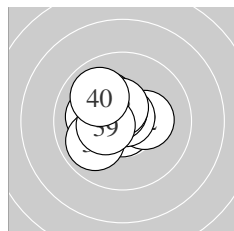

Serie 4:
 10.8 * 10.3 * 10.8 * 10.1 ← 9.9 ↖
 10.2 * 10.6 * 10.5 * 10.4 * 9.9 ↘
 beste Teiler 36.6 (33.) 48.0 (31.) 85.0 (37.)
 Trefferlage 0.72 mm links, 0.35 mm hoch
 Streuwert 1.10, horizontal: 1.19, vertikal: 0.99

Unterschrift des Schützen

Meyton Elektronik

Ergebnis: **406.0** (389)
 Serien: 100.1 103.1 101.6 101.2
 Zähler: 29 11 0 0 0 0 0 0 0 0
 Innenzehner: 25
 weiteste: 494 (30), 422 (10), 406 (2)
 beste Teiler 36.0 (12.) 63.8 (24.) 79.0 (9.)
 Trefferlage 0.23 mm links, 0.42 mm hoch
 Streuwert 1.55, horizontal: 1.76, vertikal: 1.30

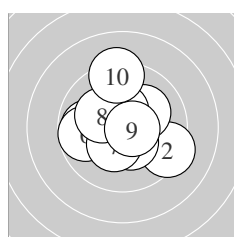
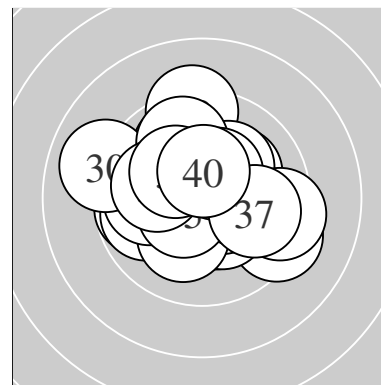

Serie 1:
 9.8 ← 9.3 → 10.4 * 10.1 ↗ 10.4 *
 9.7 ← 10.3 * 10.2 * 10.6 * 9.3 ↑
 beste Teiler 79.0 (9.) 130.5 (5.) 139.5 (3.)
 Trefferlage 0.19 mm links, 0.26 mm hoch
 Streuwert 1.89, horizontal: 2.02, vertikal: 1.76

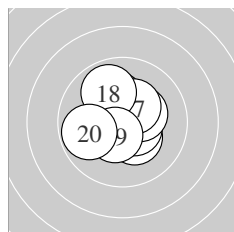

Serie 2:
 10.3 * 10.8 * 10.2 * 10.5 * 10.5 *
 10.3 * 10.3 * 9.9 ↘ 10.5 * 9.8 ←
 beste Teiler 36.0 (12.) 107.3 (15.) 117.2 (14.)
 Trefferlage 0.03 mm rechts, 0.27 mm hoch
 Streuwert 1.27, horizontal: 1.29, vertikal: 1.26

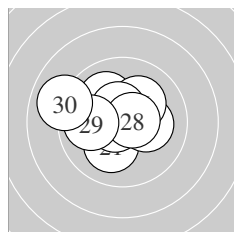

Serie 3:
 10.1 ↘ 10.4 * 10.0 ↖ 10.7 * 10.2 *
 10.2 * 10.5 * 10.6 * 9.9 ← 9.0 ←
 beste Teiler 63.8 (24.) 80.4 (28.) 108.1 (27.)
 Trefferlage 0.72 mm links, 0.49 mm hoch
 Streuwert 1.57, horizontal: 1.91, vertikal: 1.13

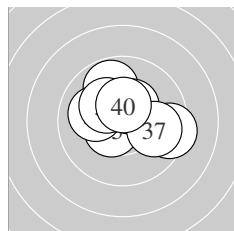

Serie 4:
 10.3 * 10.3 * 9.8 ↖ 9.4 → 10.5 *
 10.4 * 9.9 → 10.0 ← 10.2 * 10.4 *
 beste Teiler 111.6 (35.) 130.1 (40.) 137.9 (36.)
 Trefferlage 0.05 mm links, 0.67 mm hoch
 Streuwert 1.56, horizontal: 1.90, vertikal: 1.12

Unterschrift des Schützen

Meyton Elektronik

Ergebnis: **406.6** (386)
 Serien: 101.7 101.7 102.3 100.9
 Zähler: 26 14 0 0 0 0 0 0 0 0
 Innenzehner: 24
 weiteste: 433 (12), 370 (35), 367 (24)
 beste Teiler 21.9 (29.) 39.8 (34.) 56.3 (19.)
 Trefferlage 0.45 mm links, 0.74 mm hoch
 Streuwert 1.44, horizontal: 1.43, vertikal: 1.45

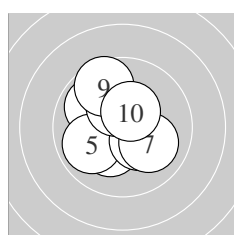
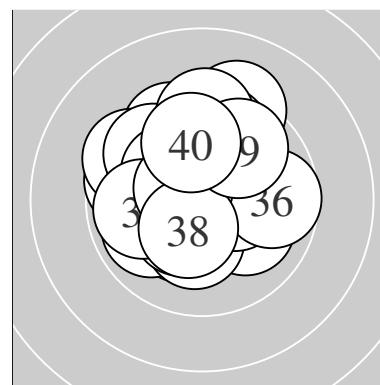

Serie 1:
 10.5 * 10.3 * 10.5 * 9.9 ↘ 9.9 ↙
 10.3 * 10.0 ↘ 10.3 * 9.6 ↗ 10.4 *
 beste Teiler 103.2 (3.) 111.8 (1.) 133.2 (10.)
 Trefferlage 0.49 mm links, 0.26 mm hoch
 Streuwert 1.48, horizontal: 1.39, vertikal: 1.57

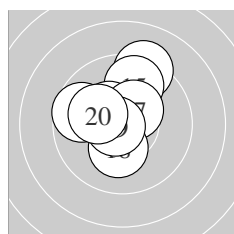

Serie 2:
 9.7 ↖ 9.2 ↗ 10.5 * 10.7 * 9.7 ↗
 10.4 * 10.4 * 10.2 * 10.7 * 10.2 *
 beste Teiler 56.3 (19.) 59.3 (14.) 108.1 (13.)
 Trefferlage 0.42 mm links, 0.97 mm hoch
 Streuwert 1.49, horizontal: 1.37, vertikal: 1.60

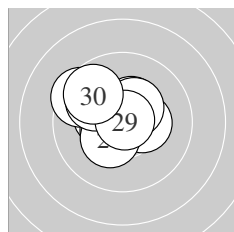

Serie 3:
 10.4 * 10.3 * 10.5 * 9.5 ↘ 10.4 *
 10.3 * 9.9 ↘ 10.4 * 10.9 * 9.7 ↘
 beste Teiler 21.9 (29.) 114.2 (23.) 135.5 (21.)
 Trefferlage 0.76 mm links, 0.65 mm hoch
 Streuwert 1.32, horizontal: 1.51, vertikal: 1.09

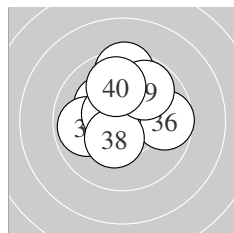

Serie 4:
 10.2 * 10.1 ↑ 9.9 ← 10.8 * 9.5 ↑
 9.7 → 10.6 * 10.4 * 9.8 ↗ 9.9 ↑
 beste Teiler 39.8 (34.) 100.7 (37.) 142.2 (38.)
 Trefferlage 0.15 mm links, 1.09 mm hoch
 Streuwert 1.58, horizontal: 1.60, vertikal: 1.56

Unterschrift des Schützen

Meyton Elektronik

Ergebnis: **414.1** (395)^{QF}
 Serien: 103.7 103.7 103.8 102.9
 Zähler: 35 5 0 0 0 0 0 0 0 0
 Innenzehner: 31
 weiteste: 316 (32), 312 (14), 306 (27)
 beste Teiler 13.3 (15.) 15.8 (30.) 34.0 (18.)
 Trefferlage 0.36 mm links, 0.08 mm hoch
 Streuwert 1.20, horizontal: 1.42, vertikal: 0.93

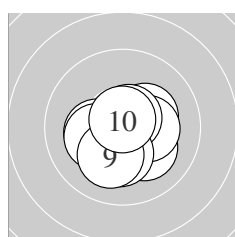
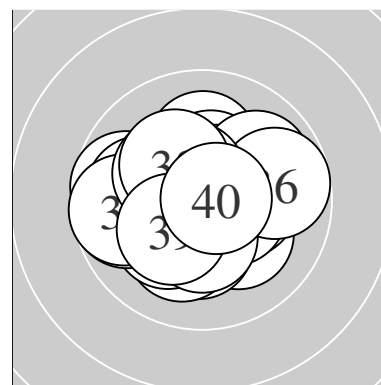

Serie 1:
 10.2 * 10.3 * 10.7 * 10.3 * 10.7 *
 10.2 * 10.3 * 10.2 * 10.1 ↙ 10.7 *
 beste Teiler 52.0 (10.) 63.6 (3.) 74.6 (5.)
 Trefferlage 0.02 mm rechts, 0.47 mm tief
 Streuwert 1.11, horizontal: 1.24, vertikal: 0.95

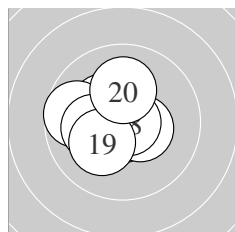

Serie 2:
 10.7 * 10.4 * 10.3 * 9.7 ← 10.9 *
 10.4 * 10.2 * 10.8 * 10.2 * 10.1 ↑
 beste Teiler 13.3 (15.) 34.0 (18.) 51.6 (11.)
 Trefferlage 0.72 mm links, 0.21 mm hoch
 Streuwert 1.13, horizontal: 1.24, vertikal: 1.01

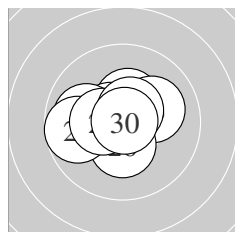

Serie 3:
 10.4 * 10.6 * 10.1 ↗ 10.7 * 10.0 ←
 10.4 * 9.7 ← 10.4 * 10.6 * 10.9 *
 beste Teiler 15.8 (30.) 52.7 (24.) 91.7 (22.)
 Trefferlage 0.51 mm links, 0.18 mm hoch
 Streuwert 1.18, horizontal: 1.47, vertikal: 0.80

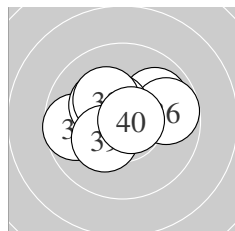

Serie 4:
 10.7 * 9.7 ← 10.8 * 10.3 * 9.9 ↗
 9.8 → 10.5 * 10.2 * 10.3 * 10.7 *
 beste Teiler 35.0 (33.) 57.3 (40.) 59.6 (31.)
 Trefferlage 0.24 mm links, 0.42 mm hoch
 Streuwert 1.38, horizontal: 1.76, vertikal: 0.83

QF – Schütze hat sich fürs Finale qualifiziert

Unterschrift des Schützen

Meyton Elektronik

Ergebnis: **400.5** (382)
 Serien: 101.5 99.0 100.4 99.6
 Zähler: 23 16 1 0 0 0 0 0 0 0
 Innenzehner: 17
 weiteste: 521 (13), 495 (40), 409 (14)
 beste Teiler 30.8 (8.) 46.8 (32.) 86.3 (9.)
 Trefferlage 0.11 mm links, 0.17 mm hoch
 Streuwert 1.86, horizontal: 2.00, vertikal: 1.70

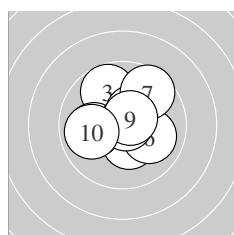
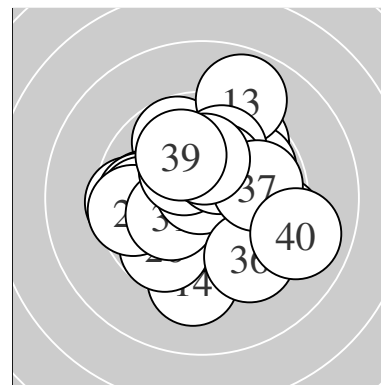

Serie 1:
 10.4 * 10.1 ↗ 9.7 ↘ 10.4 * 10.0 ←
 10.0 → 9.6 ↗ 10.8 * 10.6 * 9.9 ←
 beste Teiler 30.8 (8.) 86.3 (9.) 136.6 (4.)
 Trefferlage 0.15 mm rechts, 0.57 mm hoch
 Streuwert 1.57, horizontal: 1.67, vertikal: 1.46

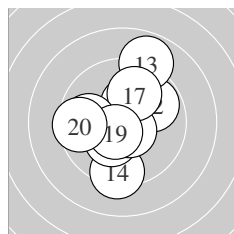

Serie 2:
 10.3 * 9.8 ↗ 8.9 ↑ 9.3 ↓ 10.3 *
 10.6 * 9.9 ↑ 9.8 ← 10.6 * 9.5 ←
 beste Teiler 88.0 (16.) 100.8 (19.) 151.9 (11.)
 Trefferlage 0.19 mm links, 0.29 mm hoch
 Streuwert 2.16, horizontal: 1.89, vertikal: 2.40

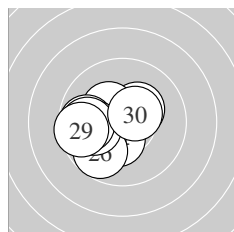

Serie 3:
 10.3 * 10.3 * 10.0 ← 10.4 * 9.8 ←
 9.7 ↙ 10.0 ← 9.8 ← 9.6 ← 10.5 *
 beste Teiler 123.7 (30.) 147.2 (24.) 157.0 (22.)
 Trefferlage 1.48 mm links, 0.32 mm tief
 Streuwert 1.39, horizontal: 1.63, vertikal: 1.10

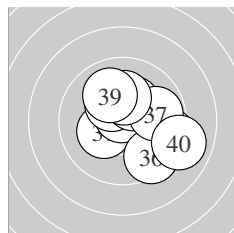

Serie 4:
 10.3 * 10.8 * 10.3 * 9.4 → 10.3 *
 9.5 ↘ 9.8 → 10.2 * 10.0 ↗ 9.0 →
 beste Teiler 46.8 (32.) 164.5 (33.) 168.0 (35.)
 Trefferlage 1.08 mm rechts, 0.12 mm hoch
 Streuwert 1.94, horizontal: 2.14, vertikal: 1.71

Unterschrift des Schützen

Meyton Elektronik

Ergebnis: **412.0** (395)
 Serien: 103.8 102.9 102.4 102.9
 Zähler: 35 5 0 0 0 0 0 0 0 0
 Innenzehner: 30
 weiteste: 378 (16), 354 (38), 352 (25)
 beste Teiler 11.3 (8.) 59.4 (14.) 62.0 (19.)
 Trefferlage 0.10 mm links, 0.54 mm hoch
 Streuwert 1.25, horizontal: 1.25, vertikal: 1.24

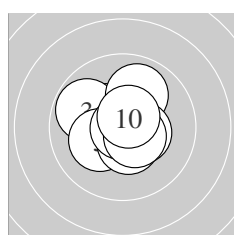
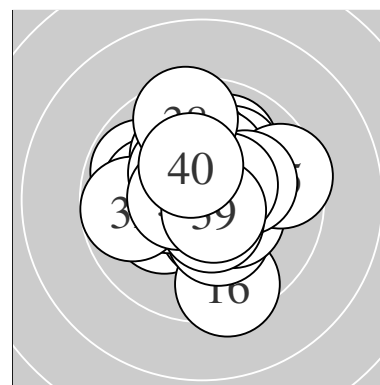

Serie 1:
 10.5 * 10.4 * 9.8 ↖ 10.0 ↗ 10.2 *
 10.5 * 10.4 * 10.9 * 10.5 * 10.6 *
 beste Teiler 11.3 (8.) 85.9 (10.) 108.6 (1.)
 Trefferlage 0.23 mm links, 0.26 mm hoch
 Streuwert 1.18, horizontal: 1.27, vertikal: 1.08

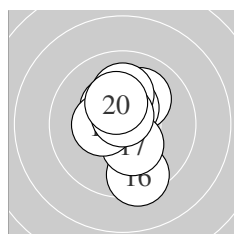

Serie 2:
 10.4 * 10.1 ↗ 10.5 * 10.7 * 10.1 ↑
 9.4 ↓ 10.3 * 10.4 * 10.7 * 10.3 *
 beste Teiler 59.4 (14.) 62.0 (19.) 121.4 (13.)
 Trefferlage 0.01 mm rechts, 0.34 mm hoch
 Streuwert 1.37, horizontal: 0.85, vertikal: 1.74

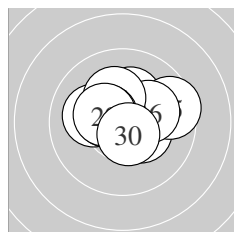

Serie 3:
 10.1 ↖ 10.3 * 10.4 * 10.2 * 9.5 →
 10.2 * 10.2 * 10.5 * 10.4 * 10.6 *
 beste Teiler 96.1 (30.) 124.4 (28.) 139.4 (29.)
 Trefferlage 0.34 mm rechts, 0.61 mm hoch
 Streuwert 1.32, horizontal: 1.65, vertikal: 0.86

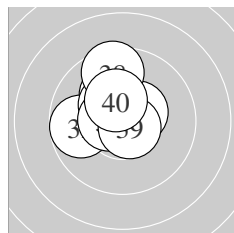

Serie 4:
 10.1 ↖ 9.8 ← 10.6 * 10.4 * 10.5 *
 10.4 * 10.6 * 9.5 ↑ 10.7 * 10.3 *
 beste Teiler 67.2 (39.) 79.0 (33.) 97.5 (37.)
 Trefferlage 0.52 mm links, 0.95 mm hoch
 Streuwert 1.15, horizontal: 1.12, vertikal: 1.18

Unterschrift des Schützen

Meyton Elektronik

Ergebnis: **409.1** (393)
 Serien: 102.8 103.1 102.1 101.1
 Zähler: 33 7 0 0 0 0 0 0 0 0
 Innenzehner: 25
 weiteste: 394 (32), 341 (24), 307 (31)
 beste Teiler 48.6 (10.) 55.1 (39.) 63.0 (11.)
 Trefferlage 0.22 mm rechts, 0.23 mm hoch
 Streuwert 1.41, horizontal: 1.63, vertikal: 1.14

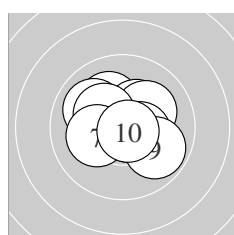
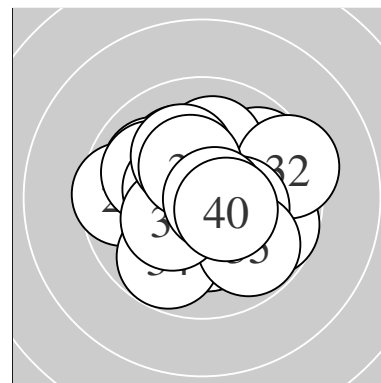

Serie 1:
 10.1 ↘ 10.7 * 10.0 ↖ 10.3 * 10.1 ↗
 10.3 * 10.2 * 10.4 * 9.9 ↘ 10.8 *
 beste Teiler 48.6 (10.) 63.6 (2.) 130.2 (8.)
 Trefferlage 0.09 mm rechts, 0.31 mm hoch
 Streuwert 1.33, horizontal: 1.55, vertikal: 1.07

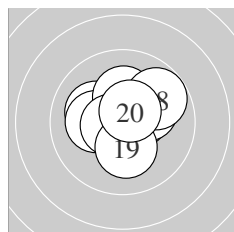

Serie 2:
 10.7 * 10.1 ↖ 10.2 * 10.2 * 10.5 *
 10.6 * 10.2 * 9.8 ↗ 10.2 * 10.6 *
 beste Teiler 63.0 (11.) 84.8 (16.) 96.5 (20.)
 Trefferlage 0.21 mm rechts, 0.43 mm hoch
 Streuwert 1.25, horizontal: 1.44, vertikal: 1.04

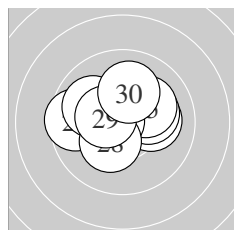

Serie 3:
 10.6 * 10.1 → 10.2 * 9.6 ← 10.1 ↗
 10.7 * 10.0 ↖ 10.3 * 10.4 * 10.1 ↑
 beste Teiler 66.6 (26.) 88.4 (21.) 126.8 (29.)
 Trefferlage 0.16 mm links, 0.50 mm hoch
 Streuwert 1.44, horizontal: 1.82, vertikal: 0.92

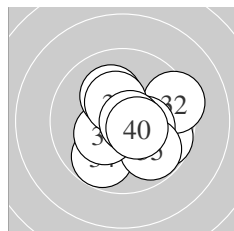

Serie 4:
 9.7 ↘ 9.4 → 10.3 * 9.8 ✓ 9.8 ↘
 10.3 * 10.2 * 10.4 * 10.7 * 10.5 *
 beste Teiler 55.1 (39.) 115.3 (40.) 145.2 (38.)
 Trefferlage 0.76 mm rechts, 0.30 mm tief
 Streuwert 1.63, horizontal: 1.79, vertikal: 1.46

Unterschrift des Schützen

Meyton Elektronik

Ergebnis: **410.1** (393)
 Serien: 103.2 101.5 103.2 102.2
 Zähler: 33 7 0 0 0 0 0 0 0 0
 Innenzehner: 24
 weiteste: 404 (14), 339 (37), 313 (26)
 beste Teiler 13.0 (32.) 47.8 (20.) 56.8 (10.)
 Trefferlage 0.05 mm rechts, 0.06 mm hoch
 Streuwert 1.39, horizontal: 1.56, vertikal: 1.19

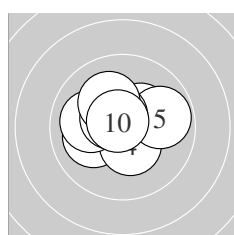
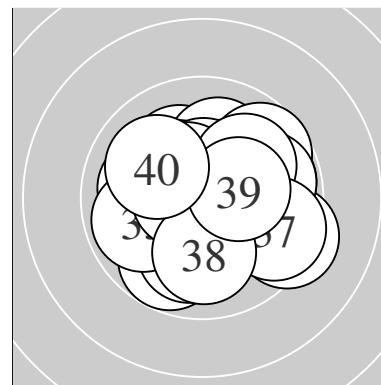

Serie 1:
 10.7 * 10.3 * 10.1 ← 10.4 * 9.8 →
 10.6 * 10.0 ← 10.5 * 10.1 ↖ 10.7 *
 beste Teiler 56.8 (10.) 66.5 (1.) 94.8 (6.)
 Trefferlage 0.28 mm links, 0.32 mm hoch
 Streuwert 1.23, horizontal: 1.50, vertikal: 0.90

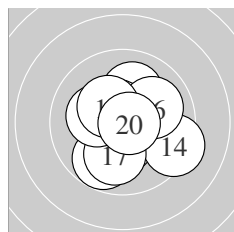

Serie 2:
 10.1 ↗ 10.6 * 10.4 * 9.3 ↘ 9.8 ↙
 10.0 ↘ 10.0 ↓ 10.2 * 10.3 * 10.8 *
 beste Teiler 47.8 (20.) 93.0 (12.) 150.0 (13.)
 Trefferlage 0.17 mm rechts, 0.26 mm tief
 Streuwert 1.66, horizontal: 1.68, vertikal: 1.64

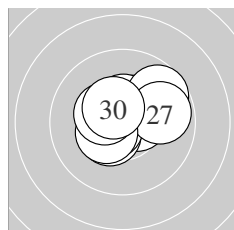

Serie 3:
 10.5 * 10.4 * 10.5 * 10.4 * 10.6 *
 9.7 ↗ 9.8 → 10.4 * 10.4 * 10.5 *
 beste Teiler 84.9 (25.) 104.9 (21.) 121.1 (23.)
 Trefferlage 0.23 mm rechts, 0.46 mm hoch
 Streuwert 1.23, horizontal: 1.48, vertikal: 0.91

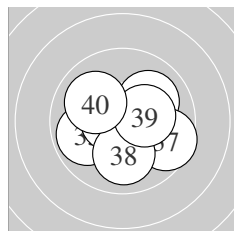

Serie 4:
 10.4 * 10.9 * 9.9 ← 10.0 ↗ 10.6 *
 10.5 * 9.6 ↘ 10.0 ↓ 10.3 * 10.0 ↖
 beste Teiler 13.0 (32.) 80.1 (35.) 102.8 (36.)
 Trefferlage 0.11 mm rechts, 0.27 mm tief
 Streuwert 1.50, horizontal: 1.77, vertikal: 1.17

Unterschrift des Schützen