

Ergebnis:	589.0	(565)
Serien:	100.4 96.2 98.9 98.9 97.7 96.9	
Zähler:	31 23 6 0 0 0 0 0 0 0	
Innenzehner:	20	
weiteste:	716 (51), 660 (19), 570 (17)	
beste Teiler	45.6 (42.) 59.9 (33.) 86.7 (56.)	
Trefferlage	0.71 mm links, 0.15 mm hoch	
Streuwert	2.23, horizontal: 2.74, vertikal: 1.56	

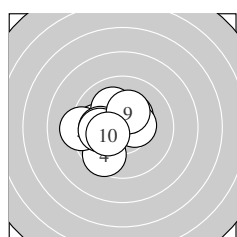

Serie 1:	9.9 ←	10.4 *	10.1 ↖	9.6 ↙	9.3 ←
	10.5 *	10.0 ←	10.0 ←	10.3 *	10.3 *
beste Teiler	125.2 (6.)	146.0 (2.)	166.0 (9.)		
Trefferlage	1.32 mm links, 0.07 mm hoch				
Streuwert	1.56, horizontal: 1.76, vertikal: 1.33				

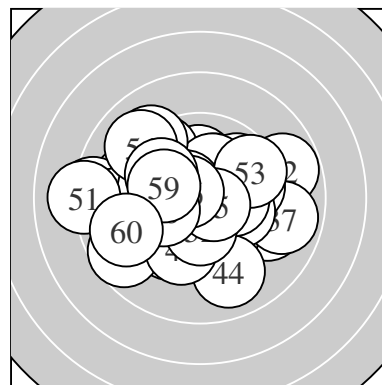
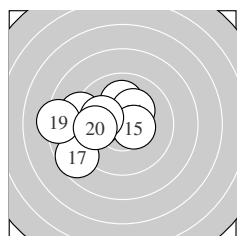

Serie 2:	10.1 ↑	9.3 ←	10.0 ←	10.2 *	10.5 *
	9.2 ←	8.7 ↙	10.1 ←	8.3 ←	9.8 ←
beste Teiler	118.1 (15.)	176.8 (14.)	225.2 (11.)		
Trefferlage	2.50 mm links, 0.22 mm hoch				
Streuwert	2.09, horizontal: 2.57, vertikal: 1.46				

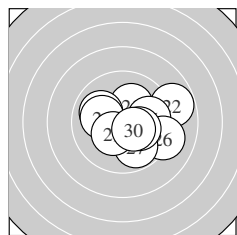

Serie 3:	10.2 *	8.8 →	10.0 ↖	10.1 ←	9.9 →
	9.2 →	9.8 ↘	10.2 *	10.3 *	10.4 *
beste Teiler	134.5 (30.)	153.3 (29.)	183.0 (28.)		
Trefferlage	1.17 mm rechts, 0.13 mm tief				
Streuwert	2.00, horizontal: 2.45, vertikal: 1.42				

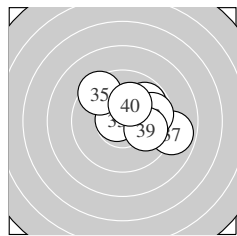

Serie 4:	10.2 *	10.2 *	10.7 *	9.8 →	9.5 ↖
	9.8 ↗	8.9 →	9.7 →	9.9 →	10.2 *
beste Teiler	59.9 (33.)	187.0 (32.)	188.9 (40.)		
Trefferlage	1.57 mm rechts, 0.84 mm hoch				
Streuwert	1.69, horizontal: 2.05, vertikal: 1.25				

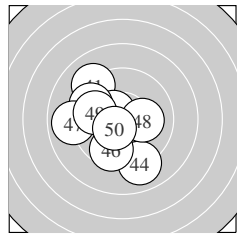

Serie 5:	9.1 ↖	10.8 *	10.5 *	9.0 ↘	9.5 ↖
	9.6 ↙	8.9 ←	10.1 →	9.8 ←	10.4 *
beste Teiler	45.6 (42.)	116.4 (43.)	126.8 (50.)		
Trefferlage	1.29 mm links, 0.31 mm tief				
Streuwert	2.26, horizontal: 2.28, vertikal: 2.24				

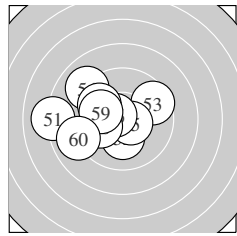

Serie 6:	8.1 ←	10.2 *	9.6 ↗	9.0 ↖	10.6 *
	10.6 *	9.8 ↖	10.0 ←	10.0 ←	9.0 ←
beste Teiler	86.7 (56.)	94.8 (55.)	192.0 (52.)		
Trefferlage	1.90 mm links, 0.23 mm hoch				
Streuwert	2.35, horizontal: 2.90, vertikal: 1.61				

Meyton Elektronik

ISSF AR Women Jun – Wertung – Juniorinnen

StandNr: 101

Feuchtmayr, Leonie #70811223

StartNr: 1

19. Januar 2019 9:51

Schützenbezirk Schwaben

Unterschrift des Schützen

Meyton Elektronik

Ergebnis: **622.0** (594)
 Serien: 106.4 100.8 103.8 102.8 103.5 104.7
 Zähler: 54 6 0 0 0 0 0 0 0 0
 Innenzehner: 45
 weiteste: 394 (19), 388 (33), 303 (17)
 beste Teiler 19.2 (25.) 39.9 (1.) 42.1 (55.)
 Trefferlage 0.07 mm links, 0.13 mm hoch
 Streuwert 1.19, horizontal: 1.34, vertikal: 1.02

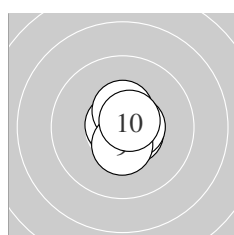
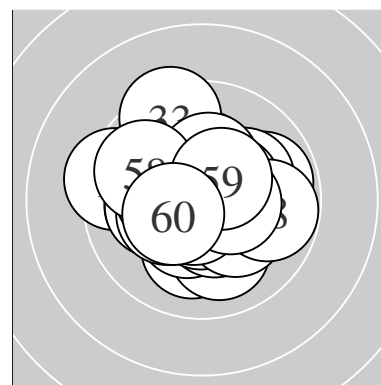

Serie 1:
 10.8 * 10.7 * 10.7 * 10.6 * 10.7 *
 10.6 * 10.7 * 10.5 * 10.4 * 10.7 *
 beste Teiler 39.9 (1.) 54.4 (7.) 61.0 (5.)
 Trefferlage 0.16 mm rechts, 0.01 mm tief
 Streuwert 0.61, horizontal: 0.47, vertikal: 0.72

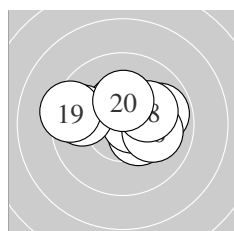

Serie 2:
 10.0 → 10.4 * 10.4 * 9.8 → 10.7 *
 10.0 → 9.7 ← 10.1 ↗ 9.4 ← 10.3 *
 beste Teiler 72.0 (15.) 133.2 (13.) 141.7 (12.)
 Trefferlage 0.38 mm rechts, 0.55 mm hoch
 Streuwert 1.68, horizontal: 2.24, vertikal: 0.78

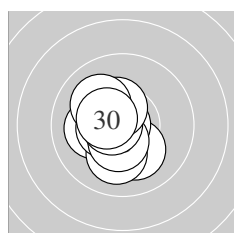

Serie 3:
 10.1 ↘ 10.1 ← 10.1 ↓ 10.5 * 10.9 *
 10.5 * 10.6 * 10.4 * 10.1 ↖ 10.5 *
 beste Teiler 19.2 (25.) 78.1 (27.) 121.0 (26.)
 Trefferlage 0.72 mm links, 0.22 mm tief
 Streuwert 1.03, horizontal: 0.84, vertikal: 1.19

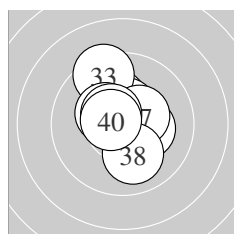

Serie 4:
 10.2 * 10.5 * 9.4 ↗ 10.4 * 10.5 *
 10.3 * 10.4 * 10.0 ↓ 10.5 * 10.6 *
 beste Teiler 91.0 (40.) 106.8 (35.) 109.9 (39.)
 Trefferlage 0.00 mm , 0.62 mm hoch
 Streuwert 1.32, horizontal: 1.11, vertikal: 1.50

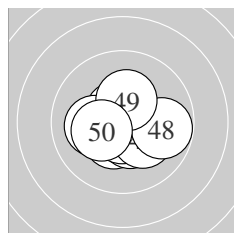

Serie 5:
 10.4 * 10.6 * 10.4 * 10.1 ← 10.6 *
 10.8 * 10.2 * 9.8 → 10.3 * 10.3 *
 beste Teiler 50.3 (46.) 82.1 (45.) 87.9 (42.)
 Trefferlage 0.08 mm rechts, 0.37 mm tief
 Streuwert 1.19, horizontal: 1.42, vertikal: 0.90

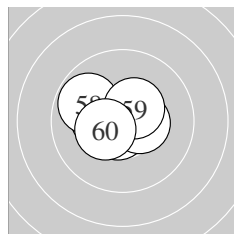

Serie 6:
 10.8 * 10.7 * 10.3 * 10.7 * 10.8 *
 10.4 * 10.3 * 9.8 ↖ 10.5 * 10.4 *
 beste Teiler 42.1 (55.) 43.6 (51.) 71.1 (52.)
 Trefferlage 0.37 mm links, 0.21 mm hoch
 Streuwert 1.00, horizontal: 1.29, vertikal: 0.60

Meyton Elektronik

ISSF AR Women Jun – Wertung – Juniorinnen

StandNr: 102

Mary, Tucker #70811224

StartNr: 2

19. Januar 2019 9:45

USA

Unterschrift des Schützen

Meyton Elektronik

Ergebnis: **607.6** (583)

Serien: 100.7 101.8 101.1 100.7 100.0 103.3

Zähler: 44 15 1 0 0 0 0 0 0

Innenzehner: 31

weiteste: 530 (8), 446 (30), 431 (45)

beste Teiler 44.7 (36.) 46.6 (52.) 51.9 (58.)

Trefferlage 0.28 mm links, 0.36 mm hoch

Streuwert 1.61, horizontal: 1.87, vertikal: 1.31

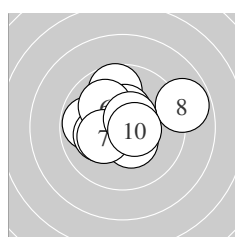
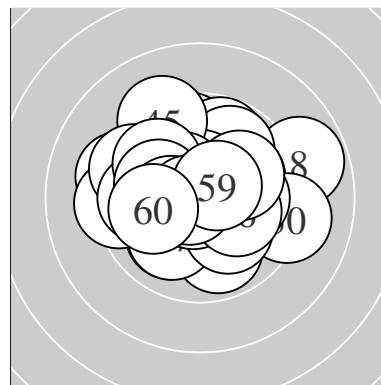

Serie 1:

10.4 *	9.7 ↑	10.4 *	9.8 ←	10.2 *
10.0 ↘	10.3 *	8.8 →	10.6 *	10.5 *

beste Teiler 95.5 (9.) 101.7 (10.) 134.0 (3.)

Trefferlage 0.08 mm links, 0.62 mm hoch

Streuwert 1.82, horizontal: 2.19, vertikal: 1.36

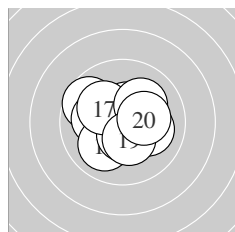

Serie 2:

10.1 →	9.7 ↘	10.1 ←	10.0 ↗	10.5 *
10.5 *	10.2 *	10.1 ↗	10.4 *	10.2 *

beste Teiler 106.2 (16.) 115.5 (15.) 147.2 (19.)

Trefferlage 0.16 mm links, 0.10 mm hoch

Streuwert 1.50, horizontal: 1.72, vertikal: 1.24

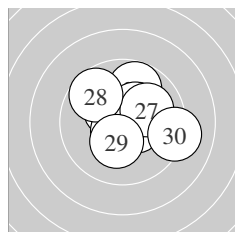

Serie 3:

10.3 *	10.4 *	9.8 ↑	10.3 *	10.5 *
10.6 *	10.0 →	9.7 ↘	10.3 *	9.2 →

beste Teiler 82.1 (26.) 117.0 (25.) 142.8 (22.)

Trefferlage 0.52 mm rechts, 0.62 mm hoch

Streuwert 1.66, horizontal: 1.83, vertikal: 1.47

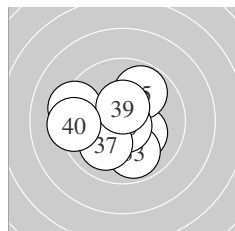

Serie 4:

10.2 *	10.4 *	9.9 ↓	10.5 *	9.8 ↗
10.8 *	10.0 ↗	9.3 ←	10.5 *	9.3 ←

beste Teiler 44.7 (36.) 103.3 (34.) 117.0 (39.)

Trefferlage 0.64 mm links, 0.10 mm tief

Streuwert 1.79, horizontal: 2.03, vertikal: 1.51

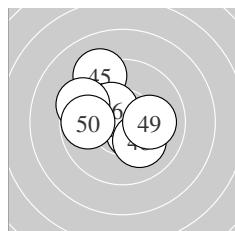

Serie 5:

10.4 *	9.9 ↘	10.1 ↘	10.5 *	9.2 ↗
10.4 *	9.5 ↘	10.1 ↓	10.1 →	9.8 ←

beste Teiler 120.2 (44.) 131.4 (41.) 141.7 (46.)

Trefferlage 0.96 mm links, 0.72 mm hoch

Streuwert 1.70, horizontal: 1.88, vertikal: 1.48

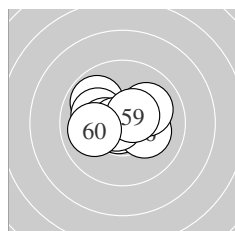

Serie 6:

10.7 *	10.8 *	9.9 ↘	10.1 ←	10.4 *
10.2 *	10.0 →	10.7 *	10.5 *	10.0 ←

beste Teiler 46.6 (52.) 51.9 (58.) 55.3 (51.)

Trefferlage 0.36 mm links, 0.23 mm hoch

Streuwert 1.28, horizontal: 1.63, vertikal: 0.78

Meyton Elektronik

ISSF AR Women Jun – Wertung – Juniorinnen

StandNr: 103

Krainz, Anja #197

StartNr: 3

19. Januar 2019 9:29

Theuerwang

Unterschrift des Schützen

Meyton Elektronik

Ergebnis: **596.2** (570)

Serien: 100.0 102.2 101.1 97.5 96.3 99.1

Zähler: 32 26 2 0 0 0 0 0 0 0

Innenzehner: 24

weiteste: 576 (33), 544 (41), 494 (44)

beste Teiler 7.0 (3.) 31.6 (16.) 53.8 (24.)

Trefferlage 0.45 mm links, 0.52 mm hoch

Streuwert 1.98, horizontal: 2.03, vertikal: 1.94

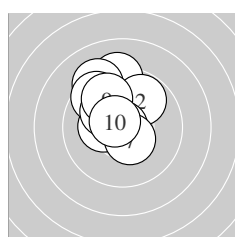
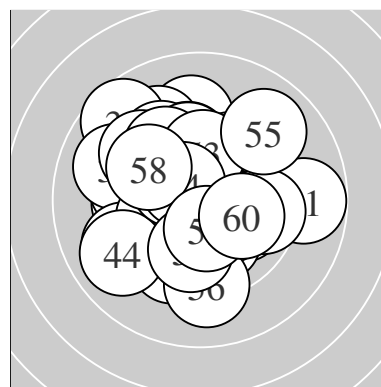

Serie 1:

9.2 ↑	9.8 ↗	10.9 *	10.3 *	9.2 ↘
9.6 ↘	10.5 *	10.1 ↘	9.8 ↘	10.6 *

beste Teiler 7.0 (3.) 85.0 (10.) 122.1 (7.)

Trefferlage 0.79 mm links, 1.65 mm hoch

Streuwert 1.52, horizontal: 1.26, vertikal: 1.74

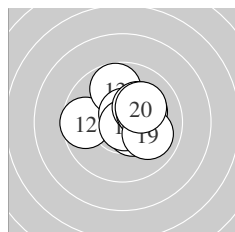

Serie 2:

10.5 *	9.7 ←	9.8 ↑	10.7 *	10.2 *
10.8 *	10.2 *	10.2 *	10.0 →	10.1 ↗

beste Teiler 31.6 (16.) 75.5 (14.) 114.9 (11.)

Trefferlage 0.56 mm rechts, 0.61 mm hoch

Streuwert 1.39, horizontal: 1.59, vertikal: 1.17

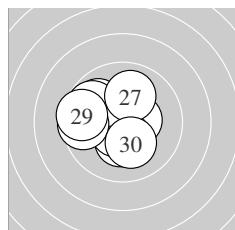

Serie 3:

9.9 ↘	10.3 *	9.8 ↘	10.7 *	10.5 *
10.6 *	10.0 ↑	9.6 ←	9.5 ←	10.2 *

beste Teiler 53.8 (24.) 99.0 (26.) 123.3 (25.)

Trefferlage 0.96 mm links, 0.20 mm hoch

Streuwert 1.60, horizontal: 1.82, vertikal: 1.35

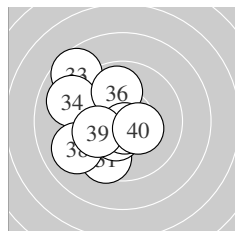

Serie 4:

9.5 ↓	9.9 ↘	8.6 ↘	9.0 ↘	10.4 *
9.9 ↑	10.7 *	9.1 ↖	10.0 ←	10.4 *

beste Teiler 66.7 (37.) 136.4 (35.) 150.7 (40.)

Trefferlage 1.73 mm links, 0.15 mm hoch

Streuwert 2.16, horizontal: 1.95, vertikal: 2.36

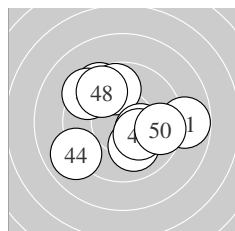

Serie 5:

8.8 →	10.0 ↓	9.5 ↘	9.0 ↖	9.8 ↑
10.3 *	9.4 ↘	9.7 ↘	10.2 *	9.6 →

beste Teiler 169.5 (46.) 178.4 (49.) 228.6 (42.)

Trefferlage 0.10 mm rechts, 0.37 mm hoch

Streuwert 2.61, horizontal: 2.98, vertikal: 2.18

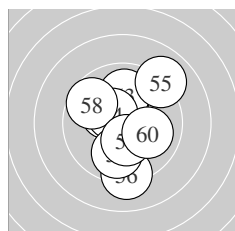

Serie 6:

10.2 *	10.3 *	10.0 ↑	10.5 *	9.0 ↗
9.2 ↓	9.9 ↓	9.7 ↘	10.3 *	10.0 →

beste Teiler 121.1 (54.) 154.7 (59.) 164.1 (52.)

Trefferlage 0.09 mm rechts, 0.18 mm hoch

Streuwert 2.14, horizontal: 1.72, vertikal: 2.49

ISSF AR Women Jun – Wertung – Juniorinnen

StandNr: 104

Scalet, Janina #139

StartNr: 4

19. Januar 2019 9:24

VSB

Unterschrift des Schützen

Meyton Elektronik

Ergebnis:	580.5	(558)
Serien:	97.7 98.5 100.1 92.6 94.5 97.1	
Zähler:	27 26 5 2 0 0 0 0 0 0	
Innenzehner:	15	
weiteste:	855 (34), 794 (40), 660 (44)	
beste Teiler	30.0 (32.) 73.2 (46.) 81.4 (59.)	
Trefferlage	0.73 mm rechts, 0.12 mm tief	
Streuwert	2.51, horizontal: 2.93, vertikal: 2.02	

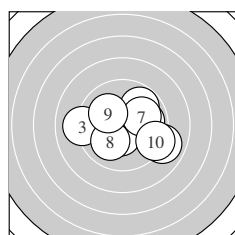
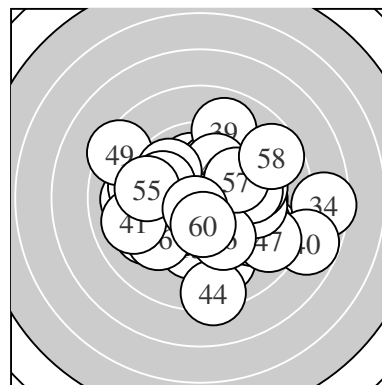

Serie 1:	8.9 ↘	10.2 *	9.1 ←	9.9 →	10.4 *
	9.8 ↗	10.0 ↗	10.0 ↙	10.1 ↖	9.3 ↘
beste Teiler	130.5 (5.)	184.5 (2.)	216.0 (9.)		
Trefferlage	0.57 mm rechts, 0.34 mm tief				
Streuwert	2.31, horizontal: 2.89, vertikal: 1.52				

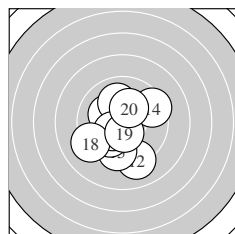

Serie 2:	10.2 *	9.1 ↓	10.0 ↑	9.4 ↗	9.6 ↓
	10.0 ↙	10.3 *	9.2 ↙	10.5 *	10.2 *
beste Teiler	123.6 (19.)	152.8 (17.)	177.6 (20.)		
Trefferlage	0.33 mm links, 0.75 mm tief				
Streuwert	2.12, horizontal: 1.95, vertikal: 2.27				

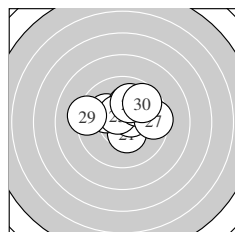

Serie 3:	10.4 *	10.1 ↖	10.1 ↑	10.5 *	10.5 *
	10.0 ↗	9.5 →	10.0 ↑	9.3 ←	9.7 ↗
beste Teiler	103.1 (25.)	109.2 (24.)	137.4 (21.)		
Trefferlage	0.38 mm rechts, 1.02 mm hoch				
Streuwert	1.70, horizontal: 2.16, vertikal: 1.07				

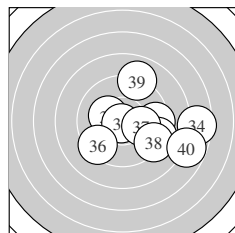

Serie 4:	10.2 *	10.8 *	9.4 →	7.5 →	9.2 ↘
	9.4 ↙	10.1 →	9.2 ↘	9.0 ↑	7.8 ↘
beste Teiler	30.0 (32.)	179.7 (31.)	221.4 (37.)		
Trefferlage	2.63 mm rechts, 0.61 mm tief				
Streuwert	3.02, horizontal: 3.64, vertikal: 2.23				

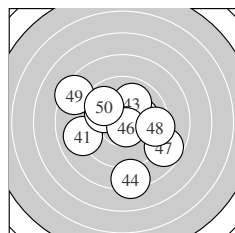

Serie 5:	9.0 ←	10.2 *	10.0 ↑	8.3 ↓	10.0 ↖
	10.7 *	8.7 ↘	9.4 →	8.4 ↖	9.8 ↖
beste Teiler	73.2 (46.)	199.7 (42.)	237.4 (45.)		
Trefferlage	0.15 mm links, 0.34 mm tief				
Streuwert	3.12, horizontal: 3.38, vertikal: 2.83				

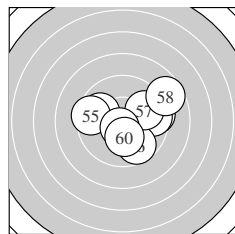

Serie 6:	9.9 ↖	9.4 →	9.7 ↗	9.6 →	9.5 ←
	9.7 ↘	9.8 ↗	8.7 ↗	10.6 *	10.2 *
beste Teiler	81.4 (59.)	184.2 (60.)	275.9 (51.)		
Trefferlage	1.29 mm rechts, 0.28 mm hoch				
Streuwert	2.31, horizontal: 2.83, vertikal: 1.62				

Meyton Elektronik

ISSF AR Women Jun – Wertung – Juniorinnen

StandNr: 105

Messner, Helena #115

StartNr: 5

19. Januar 2019 9:36

T – SG Absam

Unterschrift des Schützen

Meyton Elektronik

Ergebnis: **598.7** (571)
 Serien: 98.5 98.0 102.2 100.9 101.4 97.7
 Zähler: 33 25 2 0 0 0 0 0 0
 Innenzehner: 27
 weiteste: 700 (16), 596 (54), 495 (6)
 beste Teiler 16.2 (49.) 43.6 (34.) 48.7 (25.)
 Trefferlage 0.03 mm rechts, 0.58 mm hoch
 Streuwert 1.99, horizontal: 2.14, vertikal: 1.84

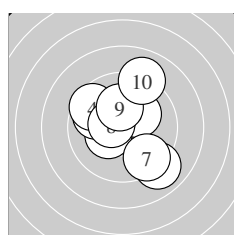
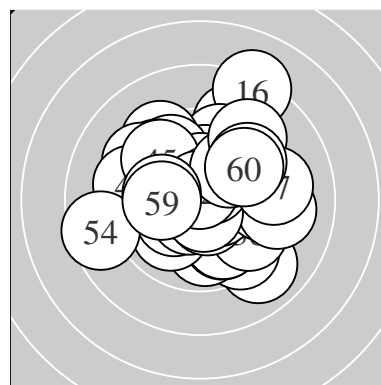

Serie 1:
 10.3 * 9.9 ↖ 10.3 * 9.6 ↖ 10.2 *
 9.0 ↘ 9.5 ↘ 10.5 * 10.2 * 9.0 ↗
 beste Teiler 111.1 (8.) 155.7 (1.) 174.7 (3.)
 Trefferlage 0.18 mm rechts, 0.50 mm hoch
 Streuwert 2.26, horizontal: 2.11, vertikal: 2.40

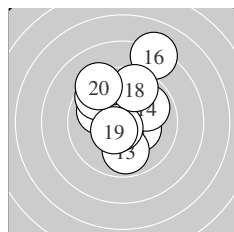

Serie 2:
 10.3 * 10.0 ↖ 9.9 ↓ 9.9 ↗ 9.6 ↖
 8.2 ↗ 10.7 * 9.6 ↑ 10.5 * 9.3 ↖
 beste Teiler 60.9 (17.) 112.4 (19.) 158.2 (11.)
 Trefferlage 0.02 mm rechts, 1.33 mm hoch
 Streuwert 2.31, horizontal: 1.93, vertikal: 2.63

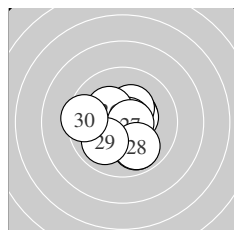

Serie 3:
 10.4 * 10.4 * 9.9 ↘ 10.3 * 10.8 *
 10.3 * 10.7 * 9.9 ↘ 10.0 ↗ 9.5 ←
 beste Teiler 48.7 (25.) 74.8 (27.) 126.6 (22.)
 Trefferlage 0.02 mm rechts, 0.23 mm tief
 Streuwert 1.54, horizontal: 1.67, vertikal: 1.39

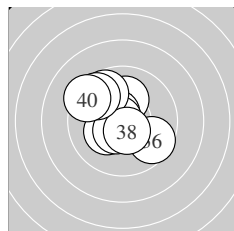

Serie 4:
 10.1 ↑ 10.6 * 10.2 * 10.8 * 10.5 *
 9.6 ↘ 9.7 ↖ 10.5 * 9.6 ↖ 9.3 ↖
 beste Teiler 43.6 (34.) 96.8 (32.) 101.6 (38.)
 Trefferlage 0.71 mm links, 0.55 mm hoch
 Streuwert 1.69, horizontal: 1.71, vertikal: 1.67

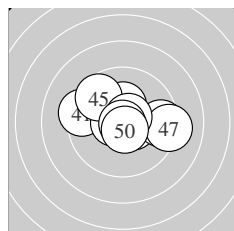

Serie 5:
 9.4 ↖ 10.3 * 10.5 * 10.6 * 9.6 ↖
 9.5 → 9.2 → 10.7 * 10.9 * 10.7 *
 beste Teiler 16.2 (49.) 74.4 (48.) 75.9 (50.)
 Trefferlage 0.28 mm rechts, 0.32 mm hoch
 Streuwert 1.88, horizontal: 2.46, vertikal: 1.01

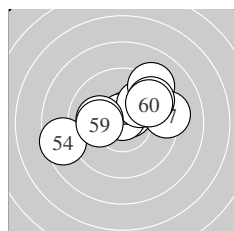

Serie 6:
 10.5 * 10.7 * 10.0 ↗ 8.6 ← 9.2 ↗
 10.1 ← 9.2 → 9.6 ↗ 10.1 ← 9.7 ↗
 beste Teiler 58.0 (52.) 104.8 (51.) 220.0 (59.)
 Trefferlage 0.43 mm rechts, 1.02 mm hoch
 Streuwert 2.37, horizontal: 3.03, vertikal: 1.44

ISSF AR Women Jun – Wertung – Juniorinnen

StandNr: 106

Ceric, Angelina #141

StartNr: 6

19. Januar 2019 9:59

VSB

Unterschrift des Schützen

Meyton Elektronik

Ergebnis: **601.0** (573)

Serien: 101.8 99.4 98.5 102.2 101.2 97.9

Zähler: 36 22 1 1 0 0 0 0 0 0

Innenzehner: 26

weiteste: 771 (26), 575 (1), 473 (41)

beste Teiler 33.3 (4.) 39.0 (28.) 48.7 (6.)

Trefferlage 0.31 mm rechts, 0.43 mm hoch

Streuwert 1.91, horizontal: 2.35, vertikal: 1.32

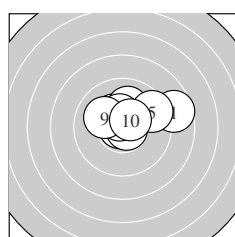
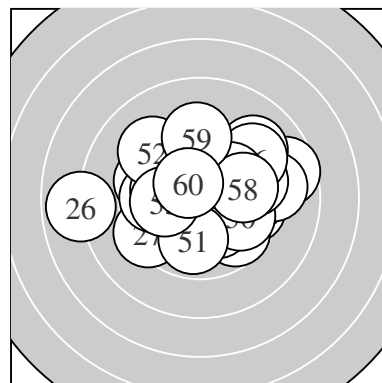

Serie 1:

8.7 →	10.3 *	10.1 ↑	10.8 *	9.5 ↗
10.8 *	10.6 *	10.4 *	10.1 ↖	10.5 *

beste Teiler 33.3 (4.) 48.7 (6.) 82.4 (7.)

Trefferlage 0.66 mm rechts, 1.05 mm hoch

Streuwert 1.62, horizontal: 2.16, vertikal: 0.76

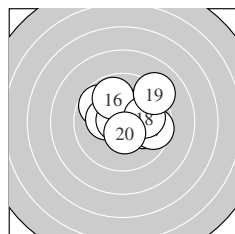

Serie 2:

9.7 ↖	10.2 *	10.0 →	10.7 *	9.8 ↗
9.8 ↘	9.6 →	10.0 →	9.1 ↗	10.5 *

beste Teiler 65.7 (14.) 118.2 (20.) 177.1 (12.)

Trefferlage 0.80 mm rechts, 0.76 mm hoch

Streuwert 1.84, horizontal: 2.18, vertikal: 1.43

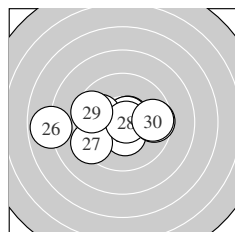

Serie 3:

10.6 *	10.7 *	10.4 *	9.9 ↖	9.6 →
7.9 ←	9.3 ↙	10.8 *	9.6 ↖	9.7 →

beste Teiler 39.0 (28.) 70.7 (22.) 79.9 (21.)

Trefferlage 0.84 mm links, 0.09 mm tief

Streuwert 2.50, horizontal: 3.38, vertikal: 1.02

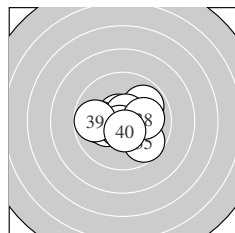

Serie 4:

9.9 ↗	10.6 *	10.0 ←	10.3 *	9.7 ↘
10.7 *	10.7 *	10.0 →	9.8 ←	10.5 *

beste Teiler 63.5 (37.) 73.7 (36.) 79.0 (32.)

Trefferlage 0.05 mm links, 0.11 mm tief

Streuwert 1.54, horizontal: 1.92, vertikal: 1.04

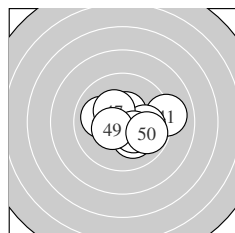

Serie 5:

9.1 →	10.0 ↖	10.5 *	10.0 →	10.6 *
10.2 *	10.3 *	10.3 *	10.4 *	9.8 ↘

beste Teiler 79.0 (45.) 106.2 (43.) 130.3 (49.)

Trefferlage 0.81 mm rechts, 0.22 mm tief

Streuwert 1.61, horizontal: 2.04, vertikal: 1.01

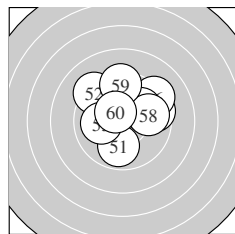

Serie 6:

9.9 ↓	9.2 ↖	10.0 ←	10.3 *	9.5 →
9.3 ↗	10.0 ↗	9.8 →	9.4 ↑	10.5 *

beste Teiler 122.4 (60.) 170.0 (54.) 229.2 (53.)

Trefferlage 0.51 mm rechts, 1.22 mm hoch

Streuwert 2.07, horizontal: 2.30, vertikal: 1.83

Meyton Elektronik

ISSF AR Women Jun – Wertung – Juniorinnen

StandNr: 107

Biechl, Julia #118

StartNr: 7

19. Januar 2019 9:27

T – SG Absam

Unterschrift des Schützen

Meyton Elektronik

Ergebnis: **617.1** (592)
 Serien: 104.2 101.7 103.1 100.5 103.1 104.5
 Zähler: 52 8 0 0 0 0 0 0 0
 Innenzehner: 41
 weiteste: 341 (32), 332 (13), 290 (38)
 beste Teiler 37.0 (1.) 49.2 (2.) 58.1 (24.)
 Trefferlage 0.24 mm links, 0.37 mm hoch
 Streuwert 1.25, horizontal: 1.49, vertikal: 0.95

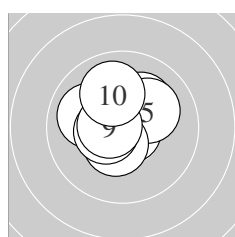
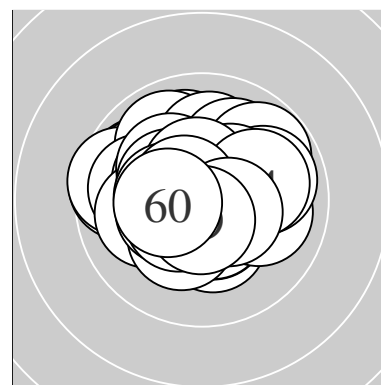

Serie 1:
 10.8 * 10.8 * 10.7 * 10.2 * 10.1 ↗
 10.5 * 10.0 ↖ 10.5 * 10.6 * 10.0 ↗
 beste Teiler 37.0 (1.) 49.2 (2.) 67.0 (3.)
 Trefferlage 0.31 mm links, 0.42 mm hoch
 Streuwert 1.10, horizontal: 1.17, vertikal: 1.02

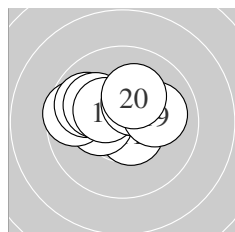

Serie 2:
 10.6 * 10.3 * 9.6 ↖ 10.3 * 9.9 ↖
 10.1 ↖ 10.4 * 10.3 * 10.0 → 10.2 *
 beste Teiler 93.2 (11.) 144.2 (17.) 151.4 (18.)
 Trefferlage 0.49 mm links, 0.78 mm hoch
 Streuwert 1.37, horizontal: 1.80, vertikal: 0.74

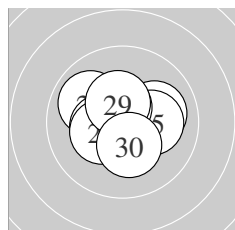

Serie 3:
 10.4 * 9.9 ↖ 10.0 → 10.7 * 10.2 *
 10.4 * 10.5 * 10.3 * 10.4 * 10.3 *
 beste Teiler 58.1 (24.) 104.3 (27.) 135.0 (29.)
 Trefferlage 0.01 mm links, 0.11 mm hoch
 Streuwert 1.24, horizontal: 1.49, vertikal: 0.94

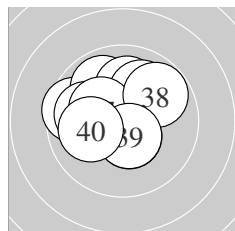

Serie 4:
 10.5 * 9.6 ↖ 9.9 ↖ 9.9 ↖ 10.0 ↑
 10.0 ↗ 10.3 * 9.8 ↗ 10.5 * 10.0 ←
 beste Teiler 112.4 (39.) 114.6 (31.) 169.1 (37.)
 Trefferlage 0.61 mm links, 0.77 mm hoch
 Streuwert 1.58, horizontal: 1.82, vertikal: 1.31

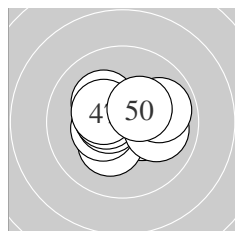

Serie 5:
 10.4 * 10.3 * 10.4 * 10.6 * 10.2 *
 10.5 * 10.4 * 10.0 → 9.9 → 10.4 *
 beste Teiler 94.4 (44.) 118.2 (46.) 141.0 (41.)
 Trefferlage 0.05 mm rechts, 0.14 mm hoch
 Streuwert 1.28, horizontal: 1.60, vertikal: 0.85

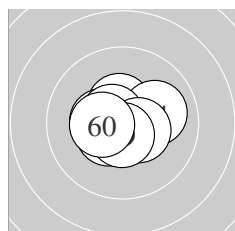

Serie 6:
 10.4 * 10.5 * 10.4 * 10.0 → 10.6 *
 10.5 * 10.6 * 10.5 * 10.6 * 10.4 *
 beste Teiler 83.1 (59.) 85.0 (57.) 89.5 (55.)
 Trefferlage 0.10 mm links, 0.03 mm hoch
 Streuwert 0.99, horizontal: 1.25, vertikal: 0.64

Meyton Elektronik

ISSF AR Women Jun – Wertung – Juniorinnen

StandNr: 108

Shcherbakova, Olga #70811225

StartNr: 8

19. Januar 2019 9:30

RUS

Unterschrift des Schützen

Meyton Elektronik

Ergebnis: **616.1** (585)

Serien: 101.0 102.5 104.5 103.6 102.0 102.5

Zähler: 45 15 0 0 0 0 0 0 0

Innenzehner: 38

weiteste: 436 (27), 379 (51), 375 (60)

beste Teiler 21.4 (32.) 35.0 (30.) 37.5 (2.)

Trefferlage 0.31 mm rechts, 0.20 mm hoch

Streuwert 1.39, horizontal: 1.39, vertikal: 1.39

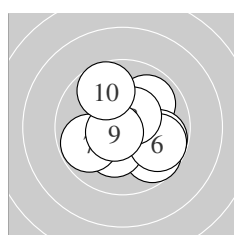
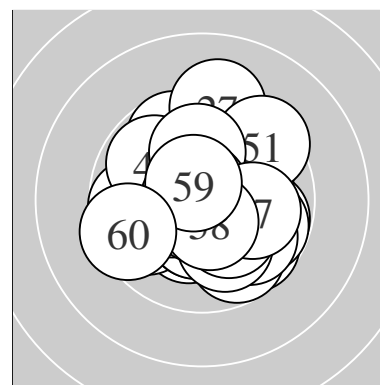

Serie 1:

9.7 ↘	10.8 *	9.9 ↗	9.8 →	10.3 *
9.8 →	9.8 ←	10.5 *	10.7 *	9.7 ↖

beste Teiler 37.5 (2.) 74.0 (9.) 116.1 (8.)

Trefferlage 0.56 mm rechts, 0.20 mm tief

Streuwert 1.71, horizontal: 1.84, vertikal: 1.58

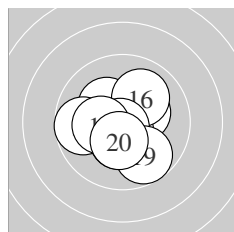

Serie 2:

10.3 *	10.4 *	10.3 *	10.6 *	9.7 ←
10.0 ↗	10.8 *	10.3 *	9.7 ↘	10.4 *

beste Teiler 43.8 (17.) 86.1 (14.) 144.3 (12.)

Trefferlage 0.20 mm links, 0.32 mm tief

Streuwert 1.42, horizontal: 1.50, vertikal: 1.33

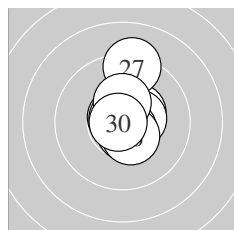

Serie 3:

10.4 *	10.5 *	10.6 *	10.7 *	10.7 *
10.5 *	9.2 ↑	10.8 *	10.3 *	10.8 *

beste Teiler 35.0 (30.) 47.0 (28.) 62.6 (25.)

Trefferlage 0.30 mm rechts, 0.51 mm hoch

Streuwert 1.16, horizontal: 0.61, vertikal: 1.53

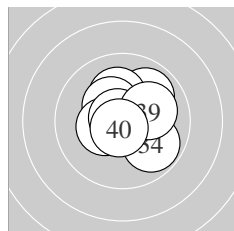

Serie 4:

10.4 *	10.9 *	9.9 ↗	9.8 ↘	10.2 *
10.4 *	10.4 *	10.8 *	10.1 →	10.7 *

beste Teiler 21.4 (32.) 47.7 (38.) 59.4 (40.)

Trefferlage 0.31 mm rechts, 0.46 mm hoch

Streuwert 1.21, horizontal: 1.28, vertikal: 1.15

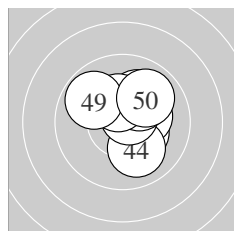

Serie 5:

10.3 *	10.5 *	10.3 *	10.0 ↘	10.1 ↗
10.7 *	10.1 ↗	10.3 *	9.8 ↖	9.9 ↗

beste Teiler 69.3 (46.) 118.1 (42.) 152.8 (48.)

Trefferlage 0.71 mm rechts, 0.71 mm hoch

Streuwert 1.24, horizontal: 1.20, vertikal: 1.28

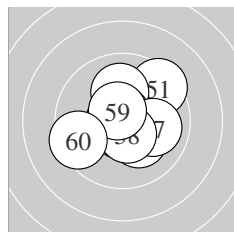

Serie 6:

9.4 ↗	10.1 ↑	10.2 *	10.7 *	10.7 *
10.8 *	10.0 →	10.5 *	10.6 *	9.5 ←

beste Teiler 45.8 (56.) 62.0 (55.) 71.8 (54.)

Trefferlage 0.18 mm rechts, 0.09 mm hoch

Streuwert 1.59, horizontal: 1.74, vertikal: 1.43

ISSF AR Women Jun – Wertung – Juniorinnen

StandNr: 110

Kowplos, Katarina #70811180

StartNr: 10

19. Januar 2019 9:47

AUS

Unterschrift des Schützen

Meyton Elektronik

Ergebnis: **628.2** (596)^{QF}
 Serien: 104.5 105.6 105.6 103.0 104.6 104.9
 Zähler: 56 4 0 0 0 0 0 0 0
 Innenzehner: 53
 weiteste: 314 (39), 295 (3), 263 (1)
 beste Teiler 15.1 (26.) 18.2 (23.) 34.5 (5.)
 Trefferlage 0.22 mm rechts, 0.00 mm
 Streuwert 0.97, horizontal: 1.12, vertikal: 0.79

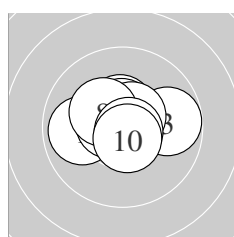
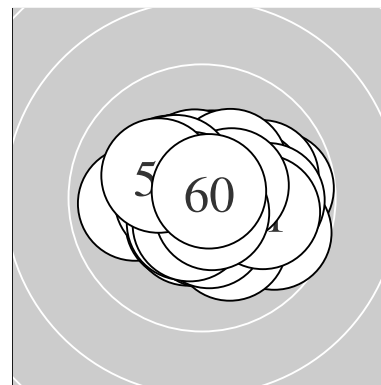

Serie 1:
 9.9 ← 10.5 * 9.8 → 10.6 * 10.8 *
 10.6 * 10.6 * 10.3 * 10.8 * 10.6 *
 beste Teiler 34.5 (5.) 49.2 (9.) 79.3 (10.)
 Trefferlage 0.06 mm links, 0.28 mm hoch
 Streuwert 1.11, horizontal: 1.43, vertikal: 0.66

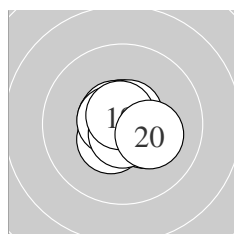

Serie 2:
 10.6 * 10.7 * 10.3 * 10.5 * 10.6 *
 10.7 * 10.6 * 10.7 * 10.7 * 10.2 *
 beste Teiler 60.1 (19.) 63.0 (18.) 66.6 (12.)
 Trefferlage 0.05 mm rechts, 0.01 mm hoch
 Streuwert 0.79, horizontal: 0.90, vertikal: 0.67

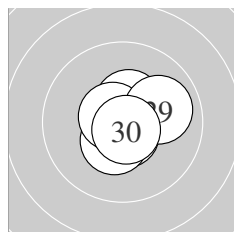

Serie 3:
 10.3 * 10.6 * 10.9 * 10.5 * 10.6 *
 10.9 * 10.4 * 10.7 * 10.0 → 10.7 *
 beste Teiler 15.1 (26.) 18.2 (23.) 55.0 (30.)
 Trefferlage 0.35 mm rechts, 0.02 mm tief
 Streuwert 0.84, horizontal: 0.90, vertikal: 0.78

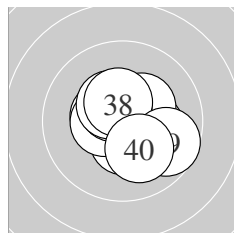

Serie 4:
 10.4 * 10.2 * 10.5 * 10.3 * 10.5 *
 10.5 * 10.4 * 10.4 * 9.7 ↘ 10.1 ↘
 beste Teiler 108.7 (36.) 119.2 (35.) 124.1 (33.)
 Trefferlage 0.29 mm rechts, 0.05 mm tief
 Streuwert 1.25, horizontal: 1.38, vertikal: 1.12

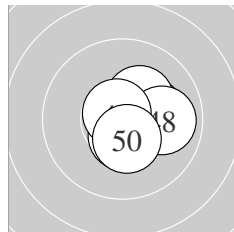

Serie 5:
 10.6 * 10.8 * 10.7 * 10.5 * 10.5 *
 10.2 * 10.3 * 9.9 → 10.7 * 10.4 *
 beste Teiler 49.9 (42.) 53.7 (49.) 67.2 (43.)
 Trefferlage 0.74 mm rechts, 0.13 mm tief
 Streuwert 0.85, horizontal: 0.90, vertikal: 0.81

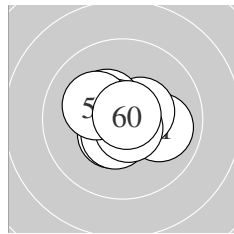

Serie 6:
 10.0 → 10.6 * 10.5 * 10.5 * 10.4 *
 10.7 * 10.5 * 10.7 * 10.2 * 10.8 *
 beste Teiler 37.4 (60.) 57.8 (56.) 70.7 (58.)
 Trefferlage 0.03 mm links, 0.09 mm tief
 Streuwert 0.99, horizontal: 1.17, vertikal: 0.77

Meyton Elektronik

ISSF AR Women Jun – Wertung – Juniorinnen

StartNr: 11

StandNr: 111

19. Januar 2019 9:45

Boldinova, Daria #70811171

RUS

QF – Schütze hat sich fürs Finale qualifiziert

Unterschrift des Schützen

Meyton Elektronik

Ergebnis:	587.6	(560)
Serien:	100.5 97.4 99.0 98.7 98.0 94.0	
Zähler:	24 32 4 0 0 0 0 0 0 0	
Innenzehner:	12	
weiteste:	597 (49), 548 (46), 534 (57)	
beste Teiler	99.1 (39.) 120.8 (43.) 123.7 (7.)	
Trefferlage	0.07 mm rechts, 0.06 mm hoch	
Streuwert	2.23, horizontal: 2.70, vertikal: 1.61	

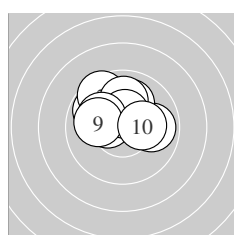
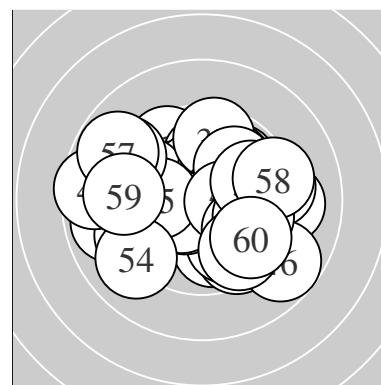

Serie 1:	9.8 ↖	9.6 ↘	9.9 →	10.0 ↑	10.4 *
	10.0 ↑	10.5 *	10.1 ↖	10.0 ←	10.2 *
beste Teiler	123.7 (7.) 140.9 (5.) 180.7 (10.)				
Trefferlage	0.43 mm links, 1.21 mm hoch				
Streuwert	1.46, horizontal: 1.79, vertikal: 1.03				

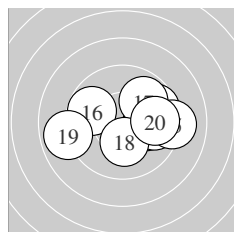

Serie 2:	10.1 →	10.1 →	9.7 ↗	9.8 →	9.1 →
	9.8 ↖	9.9 ↗	10.2 *	8.9 ←	9.8 →
beste Teiler	182.7 (18.) 221.2 (12.) 221.3 (11.)				
Trefferlage	1.20 mm rechts, 0.02 mm hoch				
Streuwert	2.24, horizontal: 2.96, vertikal: 1.13				

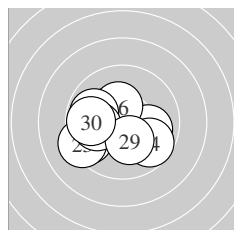

Serie 3:	9.5 ↙	10.0 →	9.3 ↙	9.7 ↘	10.3 *
	10.3 *	9.9 ←	10.0 ←	10.2 *	9.8 ←
beste Teiler	151.3 (26.) 153.8 (25.) 177.9 (29.)				
Trefferlage	1.08 mm links, 0.48 mm tief				
Streuwert	1.84, horizontal: 2.27, vertikal: 1.27				

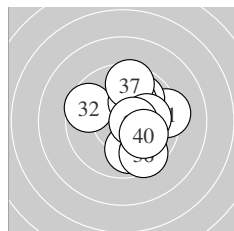

Serie 4:	9.3 →	9.6 ↖	9.9 ↗	9.9 ↓	10.2 *
	9.5 ↘	9.6 ↑	10.1 →	10.6 *	10.0 ↘
beste Teiler	99.1 (39.) 199.0 (35.) 224.6 (38.)				
Trefferlage	1.17 mm rechts, 0.26 mm hoch				
Streuwert	1.92, horizontal: 1.82, vertikal: 2.02				

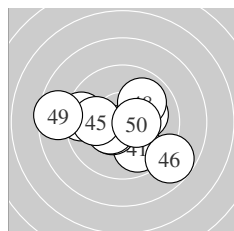

Serie 5:	9.9 ↘	9.4 ←	10.5 *	10.4 *	10.0 ←
	8.8 ↘	10.1 →	9.9 ↗	8.6 ←	10.4 *
beste Teiler	120.8 (43.) 127.2 (50.) 131.5 (44.)				
Trefferlage	0.35 mm links, 0.35 mm tief				
Streuwert	2.44, horizontal: 3.09, vertikal: 1.53				

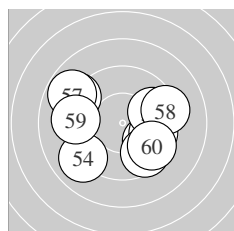

Serie 6:	9.0 ↖	9.9 ↘	9.8 →	9.0 ↙	9.6 ↓
	9.8 →	8.8 ↖	9.3 →	9.2 ←	9.6 ↘
beste Teiler	275.6 (52.) 289.9 (56.) 297.2 (53.)				
Trefferlage	0.03 mm links, 0.29 mm tief				
Streuwert	2.97, horizontal: 3.63, vertikal: 2.10				

ISSF AR Women Jun – Wertung – Juniorinnen

StandNr: 112

Demski, Sophia #70811226

StartNr: 12

19. Januar 2019 9:42

Schützenbezirk Schwaben

Unterschrift des Schützen

Meyton Elektronik

Ergebnis: **620.9** (592)
 Serien: 102.8 102.7 102.2 104.6 103.7 104.9
 Zähler: 52 8 0 0 0 0 0 0 0 0
 Innenzehner: 47
 weiteste: 453 (1), 389 (18), 353 (21)
 beste Teiler 14.8 (42.) 17.2 (3.) 23.7 (10.)
 Trefferlage 0.50 mm rechts, 0.15 mm hoch
 Streuwert 1.21, horizontal: 1.46, vertikal: 0.89

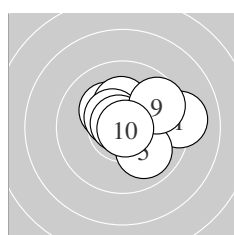
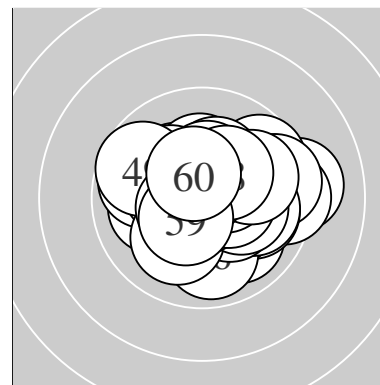

Serie 1:
 9.1 → 10.2 * 10.9 * 10.5 * 10.0 ↘
 10.2 * 10.5 * 10.8 * 9.7 ↗ 10.9 *
 beste Teiler 17.2 (3.) 23.7 (10.) 43.8 (8.)
 Trefferlage 0.79 mm rechts, 0.46 mm hoch
 Streuwert 1.45, horizontal: 1.75, vertikal: 1.06

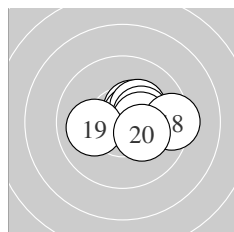

Serie 2:
 10.6 * 10.4 * 10.6 * 10.3 * 10.4 *
 10.3 * 10.4 * 9.4 → 10.0 ← 10.3 *
 beste Teiler 89.5 (11.) 90.7 (13.) 126.8 (15.)
 Trefferlage 1.07 mm rechts, 0.22 mm hoch
 Streuwert 1.14, horizontal: 1.48, vertikal: 0.65

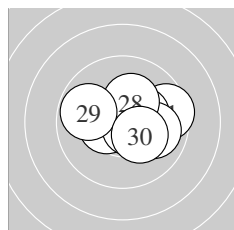

Serie 3:
 9.5 → 10.3 * 10.6 * 10.3 * 10.4 *
 10.7 * 10.0 → 10.3 * 9.8 ← 10.3 *
 beste Teiler 74.6 (26.) 84.2 (23.) 128.6 (25.)
 Trefferlage 0.68 mm rechts, 0.10 mm hoch
 Streuwert 1.41, horizontal: 1.83, vertikal: 0.81

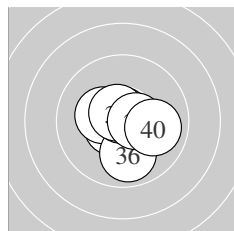

Serie 4:
 10.7 * 10.8 * 10.6 * 10.3 * 10.4 *
 9.9 ↓ 10.8 * 10.6 * 10.5 * 10.0 →
 beste Teiler 45.2 (32.) 48.8 (37.) 71.6 (31.)
 Trefferlage 0.21 mm rechts, 0.36 mm tief
 Streuwert 1.03, horizontal: 1.11, vertikal: 0.94

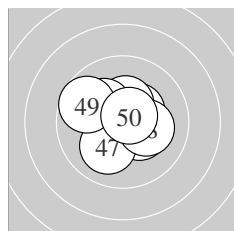

Serie 5:
 10.4 * 10.9 * 10.4 * 10.2 * 10.3 *
 10.8 * 10.1 ↙ 10.2 * 9.7 ↖ 10.7 *
 beste Teiler 14.8 (42.) 43.1 (46.) 72.1 (50.)
 Trefferlage 0.07 mm links, 0.24 mm hoch
 Streuwert 1.26, horizontal: 1.43, vertikal: 1.06

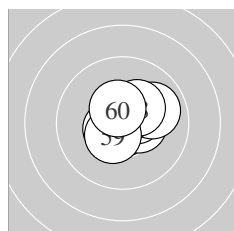

Serie 6:
 10.7 * 10.8 * 10.4 * 10.5 * 10.5 *
 9.9 → 10.8 * 10.3 * 10.5 * 10.5 *
 beste Teiler 41.1 (57.) 45.0 (52.) 59.5 (51.)
 Trefferlage 0.32 mm rechts, 0.28 mm hoch
 Streuwert 0.92, horizontal: 1.06, vertikal: 0.75

ISSF AR Women Jun – Wertung – Juniorinnen

StartNr: 13

StandNr: 113

19. Januar 2019 9:43

Karasova, Sara #187

CZE

Unterschrift des Schützen

Meyton Elektronik

Ergebnis:	612.2	(584)
Serien:	101.4	102.0 101.5 103.6 104.0 99.7
Zähler:	45	14 1 0 0 0 0 0 0 0
Innenzehner:	36	
weiteste:	534	(56), 439 (4), 400 (28)
beste Teiler	26.9	(26.) 33.2 (55.) 36.0 (48.)
Trefferlage	0.22 mm	rechts, 0.66 mm hoch
Streuwert	1.46,	horizontal: 1.65, vertikal: 1.24

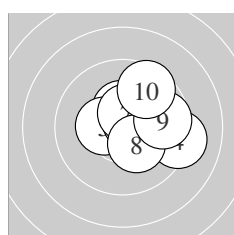
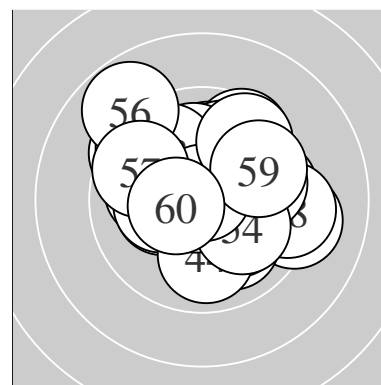

Serie 1:	10.0 ↗	10.4 *	10.7 *	9.2 →	10.4 *
	10.6 *	10.5 *	10.3 *	9.7 →	9.6 ↗
beste Teiler	63.5	(3.) 80.7 (6.)	114.0 (7.)		
Trefferlage	1.22 mm	rechts, 0.54 mm hoch			
Streuwert	1.46,	horizontal: 1.64, vertikal: 1.26			

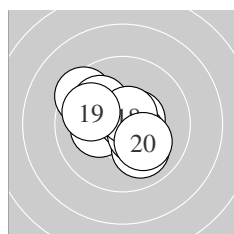

Serie 2:	10.2 *	10.5 *	10.8 *	10.0 ↘	9.5 ↘
	10.0 ↖	10.4 *	10.6 *	9.9 ↖	10.1 ↘
beste Teiler	48.7	(13.) 80.9 (18.)	111.3 (12.)		
Trefferlage	0.31 mm	links, 0.16 mm hoch			
Streuwert	1.53,	horizontal: 1.75, vertikal: 1.28			

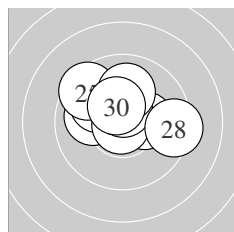

Serie 3:	10.6 *	10.0 ←	10.3 *	10.0 ↖	9.5 ↖
	10.8 *	10.5 *	9.4 →	10.0 ↑	10.4 *
beste Teiler	26.9	(26.) 86.2 (21.)	107.1 (27.)		
Trefferlage	0.19 mm	links, 0.90 mm hoch			
Streuwert	1.56,	horizontal: 1.97, vertikal: 0.98			

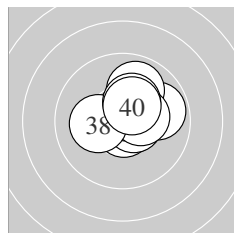

Serie 4:	10.7 *	10.7 *	9.8 →	10.6 *	10.6 *
	9.9 ↗	10.4 *	10.2 *	10.3 *	10.4 *
beste Teiler	56.8	(32.) 71.5 (31.)	76.3 (35.)		
Trefferlage	0.65 mm	rechts, 0.56 mm hoch			
Streuwert	1.03,	horizontal: 1.13, vertikal: 0.92			

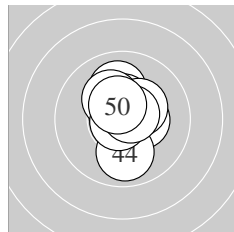

Serie 5:	10.4 *	10.0 ↑	10.4 *	9.9 ↓	10.3 *
	10.8 *	10.2 *	10.8 *	10.7 *	10.5 *
beste Teiler	36.0	(48.) 38.0 (46.)	73.2 (49.)		
Trefferlage	0.11 mm	rechts, 0.48 mm hoch			
Streuwert	1.07,	horizontal: 0.76, vertikal: 1.31			

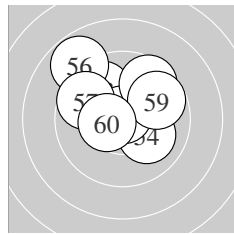

Serie 6:	10.2 *	10.3 *	9.9 ↖	10.1 ↘	10.8 *
	8.8 ↖	9.7 ↖	9.6 ↗	9.8 →	10.5 *
beste Teiler	33.2	(55.) 124.1 (60.)	162.1 (52.)		
Trefferlage	0.12 mm	links, 1.34 mm hoch			
Streuwert	1.84,	horizontal: 2.10, vertikal: 1.53			

Meyton Elektronik

ISSF AR Women Jun – Wertung – Juniorinnen

StandNr: 114

Grieser, Verena #70811167

StartNr: 14

19. Januar 2019 9:37

Schützenbezirk Schwaben

Unterschrift des Schützen

Meyton Elektronik

Ergebnis: **626.0** (593)^{QF}
 Serien: 103.7 104.3 104.1 104.6 104.2 105.1
 Zähler: 53 7 0 0 0 0 0 0 0
 Innenzehner: 50
 weiteste: 294 (24), 283 (8), 270 (40)
 beste Teiler 13.1 (39.) 17.1 (9.) 18.3 (30.)
 Trefferlage 0.30 mm rechts, 0.15 mm hoch
 Streuwert 1.04, horizontal: 1.13, vertikal: 0.94

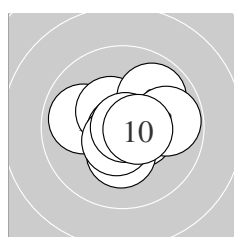
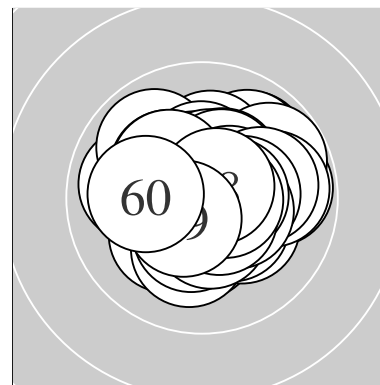

Serie 1:
 9.9 ← 10.4 * 9.9 ↗ 10.5 * 10.3 *
 10.8 * 10.6 * 9.8 → 10.9 * 10.6 *
 beste Teiler 17.1 (9.) 29.1 (6.) 96.2 (7.)
 Trefferlage 0.30 mm rechts, 0.04 mm hoch
 Streuwert 1.26, horizontal: 1.48, vertikal: 0.99

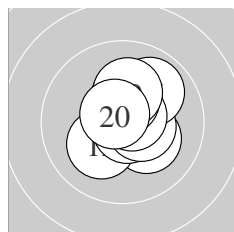

Serie 2:
 10.2 * 10.2 * 10.8 * 10.5 * 9.9 ↗
 10.7 * 10.7 * 10.4 * 10.2 * 10.7 *
 beste Teiler 50.8 (13.) 62.2 (16.) 72.4 (17.)
 Trefferlage 0.43 mm rechts, 0.35 mm hoch
 Streuwert 1.05, horizontal: 0.93, vertikal: 1.16

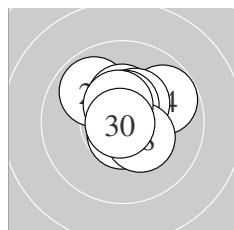

Serie 3:
 9.9 ↘ 10.7 * 10.4 * 9.8 ↗ 10.4 *
 10.5 * 10.6 * 10.4 * 10.5 * 10.9 *
 beste Teiler 18.3 (30.) 64.7 (22.) 78.1 (27.)
 Trefferlage 0.28 mm rechts, 0.66 mm hoch
 Streuwert 1.08, horizontal: 1.14, vertikal: 1.01

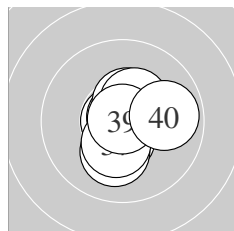

Serie 4:
 10.2 * 10.5 * 10.8 * 10.1 ↓ 10.9 *
 10.5 * 10.4 * 10.4 * 10.9 * 9.9 →
 beste Teiler 13.1 (39.) 25.9 (35.) 46.0 (33.)
 Trefferlage 0.38 mm rechts, 0.09 mm tief
 Streuwert 1.06, horizontal: 1.06, vertikal: 1.06

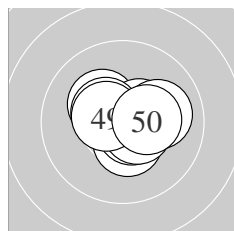

Serie 5:
 10.3 * 10.4 * 10.6 * 10.6 * 10.5 *
 10.5 * 10.0 → 10.5 * 10.5 * 10.3 *
 beste Teiler 78.6 (43.) 83.5 (44.) 105.0 (46.)
 Trefferlage 0.41 mm rechts, 0.09 mm hoch
 Streuwert 0.98, horizontal: 1.20, vertikal: 0.70

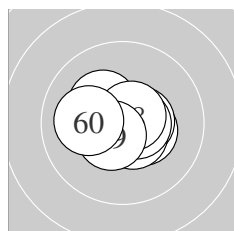

Serie 6:
 10.4 * 10.8 * 10.5 * 10.6 * 10.3 *
 10.6 * 10.6 * 10.7 * 10.5 * 10.1 ←
 beste Teiler 42.4 (52.) 71.0 (58.) 89.2 (57.)
 Trefferlage 0.00 mm , 0.11 mm tief
 Streuwert 0.92, horizontal: 1.15, vertikal: 0.61

Meyton Elektronik

QF – Schütze hat sich fürs Finale qualifiziert

Unterschrift des Schützen

Meyton Elektronik

Ergebnis:	611.7	(586)						
Serien:	103.7	103.0	101.3	100.1	102.8	100.8		
Zähler:	46	14	0	0	0	0	0	0
Innenzehner:	35							
weiteste:	429 (39), 387 (51), 362 (32)							
beste Teiler	10.4 (42.) 22.0 (47.) 47.0 (4.)							
Trefferlage	0.07 mm links, 0.22 mm hoch							
Streuwert	1.48, horizontal: 1.54, vertikal: 1.41							

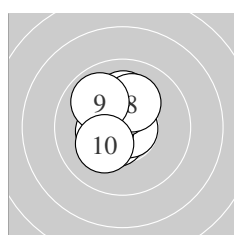
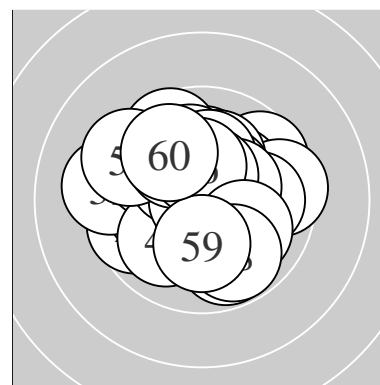

Serie 1:					
	10.4 *	10.6 *	10.1 ↑	10.8 *	10.8 *
	10.4 *	10.3 *	10.2 *	9.9 ↘	10.2 *
beste Teiler	47.0 (4.) 48.2 (5.) 94.3 (2.)				
Trefferlage	0.36 mm links, 0.67 mm hoch				
Streuwert	1.07, horizontal: 0.86, vertikal: 1.24				

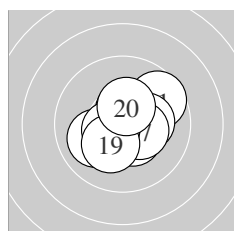

Serie 2:					
	9.7 ↗	10.4 *	10.5 *	10.2 *	10.0 ↙
	10.7 *	10.4 *	10.5 *	10.2 *	10.4 *
beste Teiler	63.3 (16.) 102.4 (18.) 107.0 (13.)				
Trefferlage	0.37 mm rechts, 0.01 mm tief				
Streuwert	1.27, horizontal: 1.40, vertikal: 1.12				

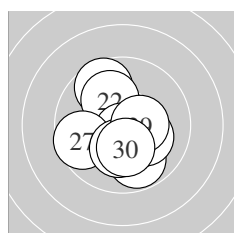

Serie 3:					
	9.6 ↘	10.1 ↘	10.7 *	9.8 ↘	10.4 *
	10.2 *	9.6 ↙	10.2 *	10.4 *	10.3 *
beste Teiler	53.1 (23.) 133.0 (29.) 147.5 (25.)				
Trefferlage	0.07 mm links, 0.51 mm tief				
Streuwert	1.60, horizontal: 1.45, vertikal: 1.73				

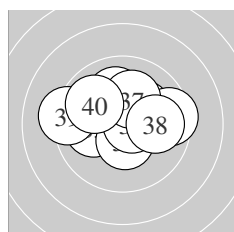

Serie 4:					
	10.2 *	9.5 →	10.1 ←	10.1 ↑	10.4 *
	10.7 *	10.1 ↑	9.9 →	9.2 ←	9.9 ↘
beste Teiler	72.0 (36.) 128.4 (35.) 189.8 (31.)				
Trefferlage	0.00 mm, 0.64 mm hoch				
Streuwert	1.84, horizontal: 2.37, vertikal: 1.07				

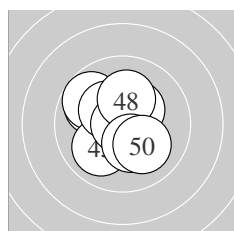

Serie 5:					
	9.9 ↘	10.9 *	9.8 ↘	10.4 *	10.0 ↙
	10.3 *	10.9 *	10.2 *	10.3 *	10.1 ↘
beste Teiler	10.4 (42.) 22.0 (47.) 149.3 (44.)				
Trefferlage	0.42 mm links, 0.23 mm hoch				
Streuwert	1.41, horizontal: 1.38, vertikal: 1.43				

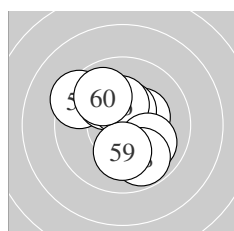

Serie 6:					
	9.4 ↘	10.4 *	10.3 *	10.1 ↘	10.5 *
	10.3 *	10.0 ↘	9.8 ↘	10.1 ↓	9.9 ↘
beste Teiler	117.6 (55.) 136.3 (52.) 155.4 (53.)				
Trefferlage	0.02 mm rechts, 0.34 mm hoch				
Streuwert	1.70, horizontal: 1.66, vertikal: 1.73				

Meyton Elektronik

ISSF AR Women Jun – Wertung – Juniorinnen

StartNr: 16

StandNr: 116

19. Januar 2019 9:56

Surny, Kim #70811184

SUI

Unterschrift des Schützen

Meyton Elektronik

Ergebnis: **604.0** (579)

Serien: 101.4 102.1 100.3 101.4 100.8 98.0

Zähler: 40 19 1 0 0 0 0 0 0 0

Innenzehner: 29

weiteste: 551 (51), 420 (55), 413 (30)

beste Teiler 9.2 (32.) 26.4 (47.) 27.3 (50.)

Trefferlage 0.16 mm links, 0.47 mm hoch

Streuwert 1.72, horizontal: 2.12, vertikal: 1.20

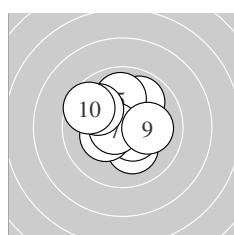
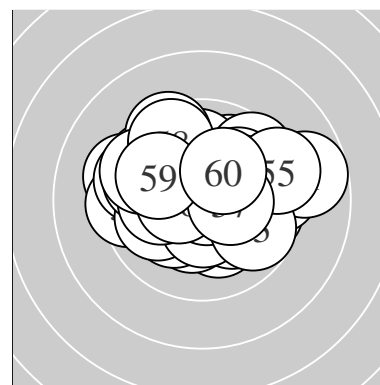

Serie 1:

10.2 *	9.9 ↗	10.2 *	10.5 *	10.0 ↑
10.3 *	10.7 *	9.9 ↘	10.1 →	9.6 ↖

beste Teiler 69.8 (7.) 113.2 (4.) 165.0 (6.)

Trefferlage 0.33 mm links, 0.59 mm hoch

Streuwert 1.56, horizontal: 1.65, vertikal: 1.46

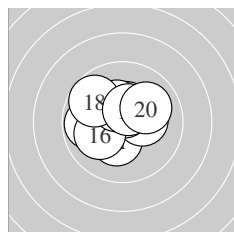

Serie 2:

10.3 *	10.4 *	10.3 *	10.6 *	9.8 ←
10.1 ←	10.4 *	9.7 ↘	10.5 *	10.0 ↗

beste Teiler 88.2 (14.) 119.0 (19.) 131.7 (12.)

Trefferlage 0.35 mm links, 0.52 mm hoch

Streuwert 1.41, horizontal: 1.65, vertikal: 1.11

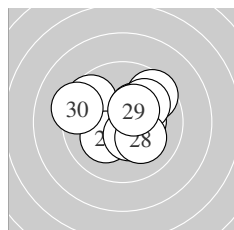

Serie 3:

9.6 ↗	10.3 *	9.6 ↘	10.2 *	10.5 *
10.3 *	10.0 ↗	10.1 ↘	10.4 *	9.3 ←

beste Teiler 124.3 (25.) 141.5 (29.) 155.1 (22.)

Trefferlage 0.20 mm rechts, 0.54 mm hoch

Streuwert 1.81, horizontal: 2.17, vertikal: 1.36

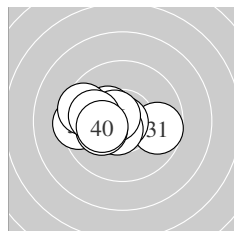

Serie 4:

9.7 →	10.9 *	10.6 *	10.3 *	9.4 ←
10.6 *	9.5 ←	10.2 *	10.0 ←	10.2 *

beste Teiler 9.2 (32.) 82.6 (36.) 84.3 (33.)

Trefferlage 1.27 mm links, 0.00 mm

Streuwert 1.45, horizontal: 1.94, vertikal: 0.65

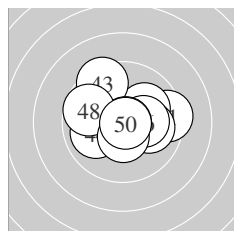

Serie 5:

9.4 →	10.1 ↗	9.4 ↘	10.0 ←	10.0 →
10.2 *	10.8 *	9.7 ←	10.4 *	10.8 *

beste Teiler 26.4 (47.) 27.3 (50.) 127.1 (49.)

Trefferlage 0.34 mm rechts, 0.33 mm hoch

Streuwert 1.80, horizontal: 2.19, vertikal: 1.32

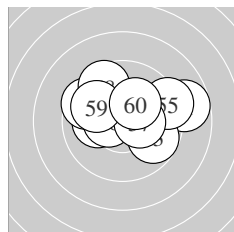

Serie 6:

8.7 →	10.1 ←	9.7 ↘	9.6 ↘	9.3 →
10.5 *	10.4 *	9.6 ↘	9.9 ↘	10.2 *

beste Teiler 121.0 (56.) 149.3 (57.) 186.8 (60.)

Trefferlage 0.41 mm rechts, 0.85 mm hoch

Streuwert 2.24, horizontal: 2.91, vertikal: 1.25

Meyton Elektronik

ISSF AR Women Jun – Wertung – Juniorinnen

StartNr: 17

StandNr: 117

19. Januar 2019 9:45

Edlyn, Nadra Mohammed Sophian #70811186

SGP

Unterschrift des Schützen

Meyton Elektronik

Ergebnis: **606.1** (575)

Serien: 102.1 98.3 99.5 104.0 100.6 101.6

Zähler: 36 23 1 0 0 0 0 0 0 0

Innenzehner: 28

weiteste: 505 (43), 496 (11), 457 (18)

beste Teiler 4.1 (36.) 25.3 (42.) 31.0 (1.)

Trefferlage 0.42 mm rechts, 0.13 mm hoch

Streuwert 1.72, horizontal: 1.96, vertikal: 1.45

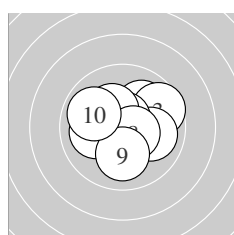
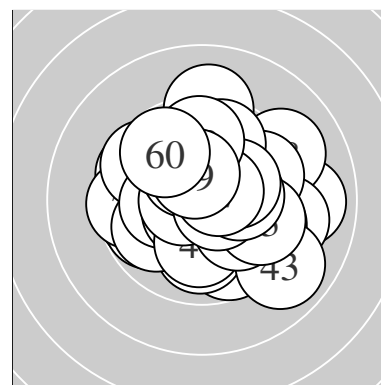

Serie 1:

10.8 *	10.0 ↗	9.6 ↗	10.0 →	10.7 *
10.3 *	10.1 ←	10.6 *	10.1 ↓	9.9 ↖

beste Teiler 31.0 (1.) 71.4 (5.) 99.7 (8.)

Trefferlage 0.20 mm rechts, 0.26 mm hoch

Streuwert 1.53, horizontal: 1.78, vertikal: 1.23

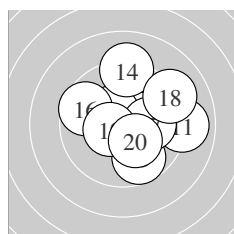

Serie 2:

9.0 →	10.5 *	10.4 *	9.1 ↑	9.7 ↓
9.6 ↖	10.1 →	9.1 ↗	10.5 *	10.3 *

beste Teiler 114.5 (12.) 114.7 (19.) 128.8 (13.)

Trefferlage 0.99 mm rechts, 0.49 mm hoch

Streuwert 2.20, horizontal: 2.38, vertikal: 2.00

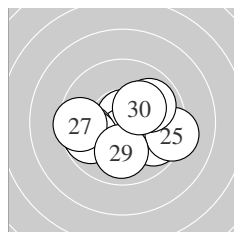

Serie 3:

10.8 *	9.8 ↘	10.5 *	9.7 ←	9.3 →
9.8 ↖	9.5 ←	9.9 ↗	10.0 ↓	10.2 *

beste Teiler 48.8 (21.) 108.6 (23.) 183.7 (30.)

Trefferlage 0.12 mm rechts, 0.50 mm tief

Streuwert 2.00, horizontal: 2.55, vertikal: 1.21

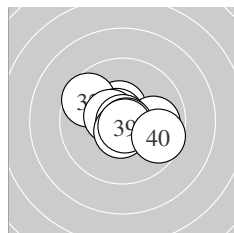

Serie 4:

10.5 *	9.6 ↖	9.9 →	10.7 *	10.5 *
10.9 *	10.6 *	10.8 *	10.8 *	9.7 ↘

beste Teiler 4.1 (36.) 45.1 (39.) 45.2 (38.)

Trefferlage 0.13 mm rechts, 0.06 mm hoch

Streuwert 1.33, horizontal: 1.66, vertikal: 0.89

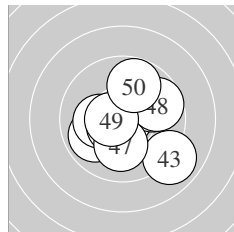

Serie 5:

9.9 ↖	10.9 *	8.9 ↘	9.9 ↗	10.2 *
10.6 *	10.1 ↓	9.7 ↗	10.6 *	9.8 ↑

beste Teiler 25.3 (42.) 93.0 (49.) 98.2 (46.)

Trefferlage 0.43 mm rechts, 0.22 mm tief

Streuwert 1.91, horizontal: 2.08, vertikal: 1.74

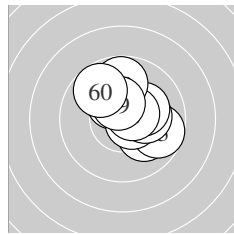

Serie 6:

10.3 *	10.1 ↘	9.7 ↘	10.6 *	10.2 *
10.2 *	10.6 *	9.8 ↑	10.4 *	9.7 ↖

beste Teiler 82.8 (54.) 94.8 (57.) 135.8 (59.)

Trefferlage 0.67 mm rechts, 0.69 mm hoch

Streuwert 1.41, horizontal: 1.46, vertikal: 1.37

Meyton Elektronik

ISSF AR Women Jun – Wertung – Juniorinnen

StandNr: 118

Ohler, Laura #70811227

StartNr: 18

19. Januar 2019 9:31

Theuerwang

Unterschrift des Schützen

Meyton Elektronik

Ergebnis:	623.1	(595)							
Serien:	103.8	104.7	104.3	103.6	102.4	104.3			
Zähler:	55	5	0	0	0	0	0	0	0
Innenzehner:	50								
weiteste:	356	(41),	345	(31),	308	(38)			
beste Teiler	10.0	(36.)	54.3	(56.)	61.7	(37.)			
Trefferlage	0.10	mm	rechts,	0.23	mm	hoch			
Streuwert	1.11,	horizontal:	1.09,	vertikal:	1.14				

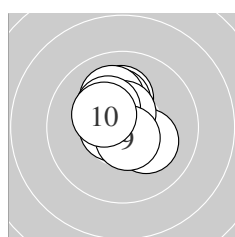
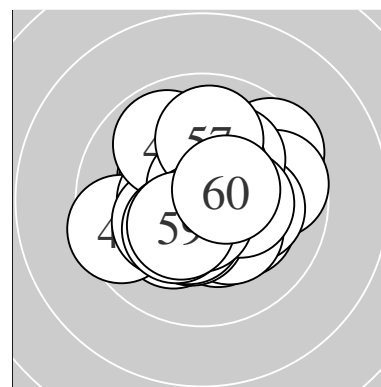

Serie 1:						
	10.7 *	10.1 ↑	10.7 *	10.2 *	10.2 *	
	10.1 ↖	10.6 *	10.3 *	10.6 *	10.3 *	
beste Teiler	72.0	(3.)	74.5	(1.)	81.8	(9.)
Trefferlage	0.21	mm	links,	0.79	mm	hoch
Streuwert	0.96,	horizontal:	0.83,	vertikal:	1.08	

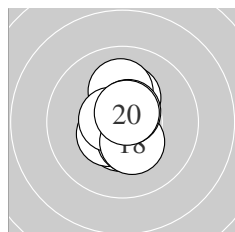

Serie 2:						
	10.5 *	10.3 *	10.7 *	10.5 *	10.4 *	
	10.1 ↑	10.6 *	10.3 *	10.6 *	10.7 *	
beste Teiler	71.0	(13.)	71.1	(20.)	80.1	(19.)
Trefferlage	0.05	mm	links,	0.06	mm	hoch
Streuwert	0.97,	horizontal:	0.59,	vertikal:	1.24	

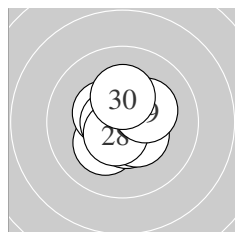

Serie 3:						
	10.2 *	10.4 *	10.4 *	10.7 *	10.5 *	
	10.6 *	10.4 *	10.6 *	10.2 *	10.3 *	
beste Teiler	70.0	(24.)	91.0	(28.)	100.0	(26.)
Trefferlage	0.10	mm	rechts,	0.10	mm	hoch
Streuwert	1.02,	horizontal:	0.99,	vertikal:	1.06	

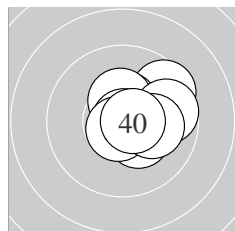

Serie 4:						
	9.6 ↗	10.5 *	10.4 *	10.6 *	10.4 *	
	10.9 *	10.7 *	9.7 →	10.1 →	10.7 *	
beste Teiler	10.0	(36.)	61.7	(37.)	71.0	(40.)
Trefferlage	1.04	mm	rechts,	0.29	mm	hoch
Streuwert	1.09,	horizontal:	1.20,	vertikal:	0.97	

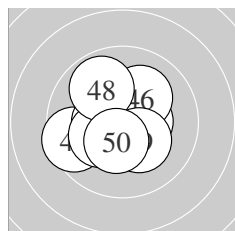

Serie 5:						
	9.5 ↙	10.3 *	10.7 *	10.4 *	10.5 *	
	10.1 ↗	10.3 *	9.9 ↘	10.3 *	10.4 *	
beste Teiler	64.3	(43.)	125.0	(45.)	129.0	(44.)
Trefferlage	0.39	mm	links,	0.14	mm	hoch
Streuwert	1.43,	horizontal:	1.51,	vertikal:	1.34	

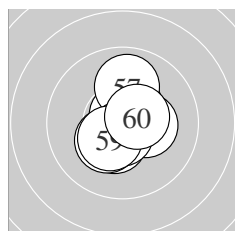

Serie 6:						
	10.7 *	10.4 *	10.3 *	10.3 *	10.4 *	
	10.7 *	9.9 ↑	10.7 *	10.4 *	10.5 *	
beste Teiler	54.3	(56.)	69.0	(51.)	75.8	(58.)
Trefferlage	0.13	mm	rechts,	0.03	mm	hoch
Streuwert	1.04,	horizontal:	0.84,	vertikal:	1.20	

Meyton Elektronik

ISSF AR Women Jun – Wertung – Juniorinnen

StartNr: 19

StandNr: 119

19. Januar 2019 9:52

Kharkova, Tatiana #70811182

RUS

Unterschrift des Schützen

Meyton Elektronik

Ergebnis:	616.4	(590)						
Serien:	101.0	102.3	105.3	103.1	102.5	102.2		
Zähler:	50	10	0	0	0	0	0	0
Innenzehner:	39							
weiteste:	404 (1), 362 (33), 361 (56)							
beste Teiler	13.3 (22.)	23.3 (10.)	27.8 (30.)					
Trefferlage	0.13 mm rechts, 0.10 mm tief							
Streuwert	1.36, horizontal: 1.39, vertikal: 1.33							

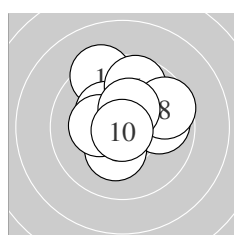
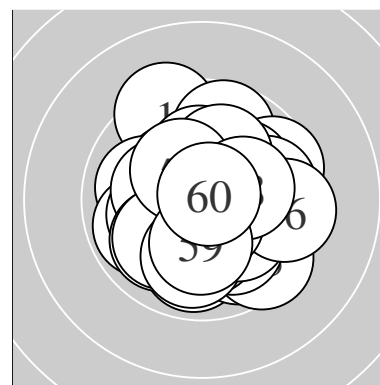

Serie 1:	9.3 ↖	10.3 *	9.9 →	10.3 *	9.7 ↑
	10.3 *	10.3 *	9.6 ↗	10.4 *	10.9 *
beste Teiler	23.3 (10.)	138.8 (9.)	160.7 (4.)		
Trefferlage	0.34 mm rechts, 0.99 mm hoch				
Streuwert	1.61, horizontal: 1.67, vertikal: 1.54				

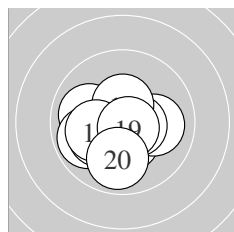

Serie 2:	10.0 ↙	10.4 *	10.1 →	10.5 *	9.9 ↖
	10.5 *	10.2 *	10.1 ↖	10.7 *	9.9 ↓
beste Teiler	57.2 (19.)	101.1 (14.)	124.0 (16.)		
Trefferlage	0.48 mm links, 0.57 mm tief				
Streuwert	1.35, horizontal: 1.60, vertikal: 1.05				

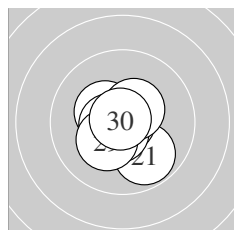

Serie 3:	9.8 ↘	10.9 *	10.8 *	10.6 *	10.6 *
	10.4 *	10.6 *	10.5 *	10.3 *	10.8 *
beste Teiler	13.3 (22.)	27.8 (30.)	49.0 (23.)		
Trefferlage	0.21 mm links, 0.14 mm tief				
Streuwert	0.96, horizontal: 0.90, vertikal: 1.01				

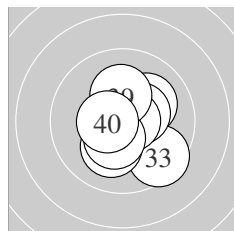

Serie 4:	10.6 *	10.1 ↗	9.5 ↘	10.6 *	10.4 *
	10.1 ↓	10.7 *	10.4 *	10.2 *	10.5 *
beste Teiler	51.0 (37.)	79.2 (31.)	92.7 (34.)		
Trefferlage	0.37 mm rechts, 0.05 mm tief				
Streuwert	1.30, horizontal: 1.18, vertikal: 1.40				

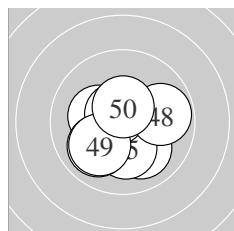

Serie 5:	10.2 *	10.0 ↘	10.6 *	10.6 *	10.2 *
	10.6 *	10.0 ↖	9.8 →	10.0 ↖	10.5 *
beste Teiler	77.2 (46.)	81.4 (43.)	97.1 (44.)		
Trefferlage	0.02 mm links, 0.53 mm tief				
Streuwert	1.34, horizontal: 1.47, vertikal: 1.19				

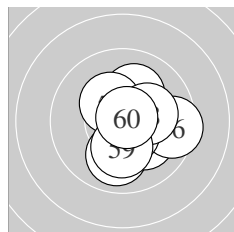

Serie 6:	10.5 *	10.1 ↑	10.3 *	10.0 ↓	10.1 ↘
	9.5 →	10.5 *	10.2 *	10.2 *	10.8 *
beste Teiler	39.0 (60.)	101.0 (57.)	106.7 (51.)		
Trefferlage	0.81 mm rechts, 0.32 mm tief				
Streuwert	1.33, horizontal: 1.28, vertikal: 1.37				

Meyton Elektronik

ISSF AR Women Jun – Wertung – Juniorinnen

StartNr: 20

StandNr: 120

19. Januar 2019 9:25

Mok, Rui Ping #70811165

SGP

Unterschrift des Schützen

Meyton Elektronik

Ergebnis: **617.9** (591)
 Serien: 102.9 102.5 102.1 103.7 103.4 103.3
 Zähler: 51 9 0 0 0 0 0 0 0
 Innenzehner: 41
 weiteste: 465 (8), 395 (13), 347 (14)
 beste Teiler 13.0 (60.) 36.4 (6.) 38.0 (4.)
 Trefferlage 0.00 mm , 0.00 mm
 Streuwert 1.35, horizontal: 1.51, vertikal: 1.16

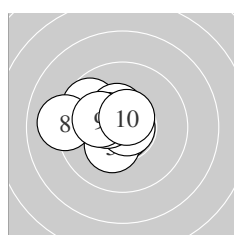
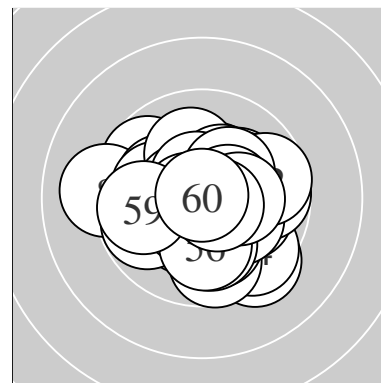

Serie 1:
 10.6 * 9.7 ↖ 10.4 * 10.8 * 10.3 *
 10.8 * 10.4 * 9.1 ← 10.2 * 10.6 *
 beste Teiler 36.4 (6.) 38.0 (4.) 85.6 (10.)
 Trefferlage 1.15 mm links, 0.41 mm hoch
 Streuwert 1.26, horizontal: 1.55, vertikal: 0.88

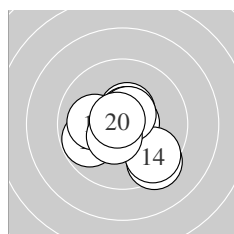

Serie 2:
 10.7 * 9.8 ← 9.4 ↘ 9.6 ↘ 10.5 *
 10.6 * 10.6 * 10.1 ← 10.5 * 10.7 *
 beste Teiler 53.6 (20.) 72.6 (11.) 83.9 (16.)
 Trefferlage 0.08 mm rechts, 0.44 mm tief
 Streuwert 1.57, horizontal: 1.70, vertikal: 1.42

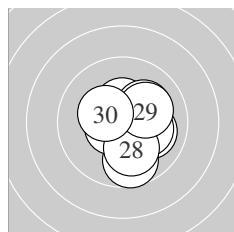

Serie 3:
 10.4 * 10.1 ↗ 10.0 ↘ 9.7 ↓ 10.2 *
 10.6 * 10.6 * 10.1 ↓ 10.1 ↗ 10.3 *
 beste Teiler 91.2 (27.) 94.8 (26.) 132.0 (21.)
 Trefferlage 0.69 mm rechts, 0.35 mm tief
 Streuwert 1.33, horizontal: 1.20, vertikal: 1.44

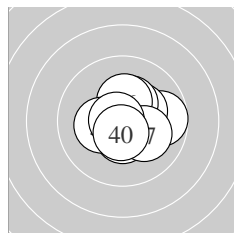

Serie 4:
 9.7 → 10.7 * 10.3 * 10.3 * 10.5 *
 10.3 * 10.2 * 10.3 * 10.8 * 10.6 *
 beste Teiler 50.6 (39.) 69.6 (32.) 94.8 (40.)
 Trefferlage 0.47 mm rechts, 0.12 mm hoch
 Streuwert 1.16, horizontal: 1.30, vertikal: 0.99

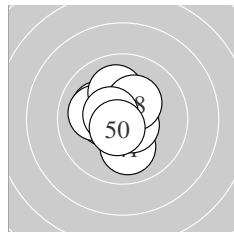

Serie 5:
 10.0 ↓ 10.4 * 10.1 ↖ 10.1 ← 10.7 *
 10.6 * 10.1 ↑ 10.3 * 10.5 * 10.6 *
 beste Teiler 63.2 (45.) 82.6 (50.) 85.7 (46.)
 Trefferlage 0.57 mm links, 0.20 mm hoch
 Streuwert 1.12, horizontal: 1.05, vertikal: 1.19

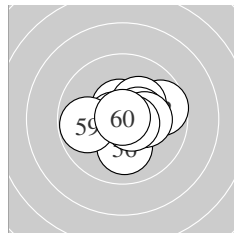

Serie 6:
 10.6 * 9.7 → 10.7 * 10.3 * 10.4 *
 10.1 ↓ 10.2 * 10.6 * 9.8 ← 10.9 *
 beste Teiler 13.0 (60.) 66.2 (53.) 81.4 (58.)
 Trefferlage 0.44 mm rechts, 0.03 mm hoch
 Streuwert 1.32, horizontal: 1.59, vertikal: 0.97

Meyton Elektronik

ISSF AR Women Jun – Wertung – Juniorinnen

StartNr: 21

StandNr: 121

19. Januar 2019 9:28

Mayr, Carmen #145

TLSB

Unterschrift des Schützen

Meyton Elektronik

Ergebnis:	613.4	(586)
Serien:	101.2 99.8	102.9 104.4 102.5 102.6
Zähler:	47 12 1 0 0 0 0 0 0	
Innenzehner:	38	
weiteste:	637 (45), 392 (9), 389 (17)	
beste Teiler	6.7 (5.) 23.0 (48.) 35.3 (47.)	
Trefferlage	0.32 mm links, 0.07 mm hoch	
Streuwert	1.50, horizontal: 1.57, vertikal: 1.43	

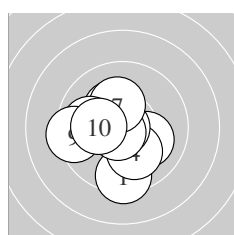
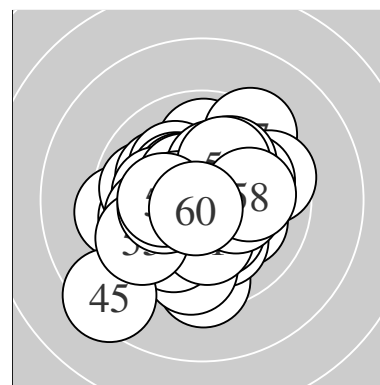

Serie 1:	9.4 ↓	10.3 *	10.1 ↘	10.1 ↘	10.9 *
	10.7 *	10.2 *	9.9 ←	9.4 ←	10.2 *
beste Teiler	6.7 (5.)	55.9 (6.)	170.4 (2.)		
Trefferlage	0.72 mm links, 0.43 mm tief				
Streuwert	1.66, horizontal: 1.69, vertikal: 1.62				

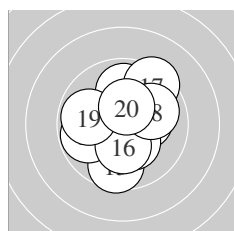

Serie 2:	10.2 *	9.9 ↑	9.6 ↓	9.8 ←	10.3 *
	10.3 *	9.4 ↗	10.0 →	9.9 ←	10.4 *
beste Teiler	141.6 (20.)	163.3 (15.)	172.0 (16.)		
Trefferlage	0.16 mm rechts, 0.16 mm hoch				
Streuwert	1.90, horizontal: 1.80, vertikal: 2.00				

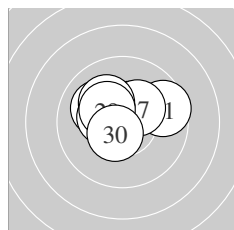

Serie 3:	9.6 →	10.7 *	10.5 *	10.3 *	10.1 ↘
	10.4 *	10.3 *	10.2 *	10.3 *	10.5 *
beste Teiler	55.0 (22.)	107.3 (30.)	114.0 (23.)		
Trefferlage	0.30 mm links, 0.76 mm hoch				
Streuwert	1.21, horizontal: 1.55, vertikal: 0.72				

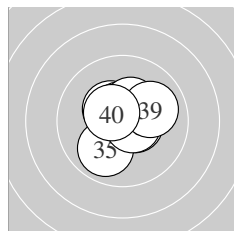

Serie 4:	10.4 *	10.5 *	10.7 *	10.8 *	9.9 ↙
	10.6 *	10.4 *	10.6 *	10.0 →	10.5 *
beste Teiler	45.4 (34.)	57.6 (33.)	86.0 (38.)		
Trefferlage	0.12 mm rechts, 0.20 mm hoch				
Streuwert	1.06, horizontal: 1.08, vertikal: 1.03				

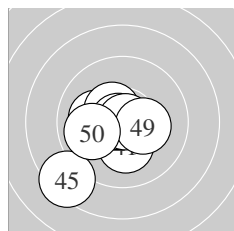

Serie 5:	10.2 *	10.1 ←	10.8 *	10.7 *	8.4 ↙
	10.4 *	10.8 *	10.9 *	10.3 *	9.9 ←
beste Teiler	23.0 (48.)	35.3 (47.)	46.8 (43.)		
Trefferlage	0.89 mm links, 0.57 mm tief				
Streuwert	1.64, horizontal: 1.70, vertikal: 1.59				

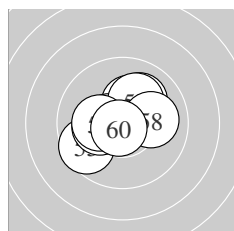

Serie 6:	10.8 *	10.3 *	10.1 ↗	10.5 *	9.6 ↙
	10.2 *	10.1 ↗	10.0 →	10.2 *	10.8 *
beste Teiler	45.4 (51.)	50.8 (60.)	111.3 (54.)		
Trefferlage	0.30 mm links, 0.32 mm hoch				
Streuwert	1.40, horizontal: 1.62, vertikal: 1.13				

Meyton Elektronik

ISSF AR Women Jun – Wertung – Juniorinnen

StartNr: 22

StandNr: 122

19. Januar 2019 9:36

Arnold, Sandra #70811196

SUI

Unterschrift des Schützen

Meyton Elektronik

Ergebnis:	623.7	(595) ^{QF}							
Serien:	104.0	104.9	104.4	102.6	103.1	104.7			
Zähler:	55	5	0	0	0	0	0	0	0
Innenzehner:	47								
weiteste:	347 (50), 292 (1), 288 (35)								
beste Teiler	5.0 (2.)	11.7 (53.)	13.3 (56.)						
Trefferlage	0.12 mm links, 0.06 mm hoch								
Streuwert	1.14, horizontal: 1.21, vertikal: 1.07								

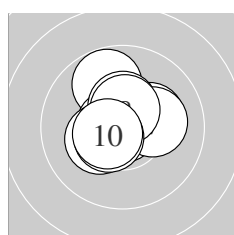
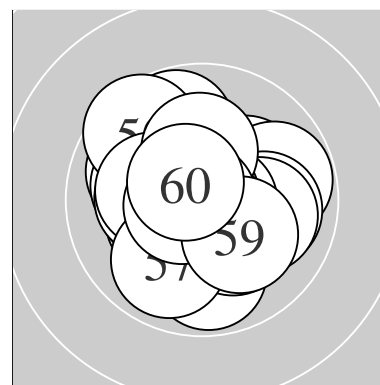

Serie 1:	9.8 ↗	10.9 *	10.7 *	10.2 *	10.4 *
	10.3 *	10.2 *	10.5 *	10.5 *	10.5 *
beste Teiler	5.0 (2.)	72.5 (3.)	106.1 (10.)		
Trefferlage	0.11 mm links, 0.44 mm hoch				
Streuwert	1.11, horizontal: 1.15, vertikal: 1.07				

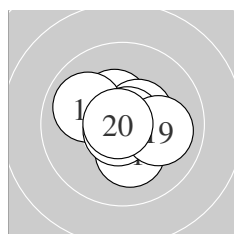

Serie 2:	10.2 *	10.8 *	10.7 *	10.4 *	10.5 *
	10.0 ↖	10.8 *	10.7 *	10.0 →	10.8 *
beste Teiler	30.1 (20.)	35.3 (17.)	41.0 (12.)		
Trefferlage	0.00 mm, 0.10 mm hoch				
Streuwert	1.04, horizontal: 1.17, vertikal: 0.88				

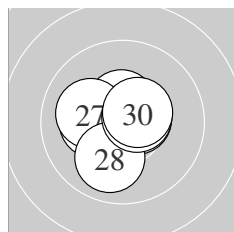

Serie 3:	10.6 *	10.6 *	10.6 *	10.2 *	10.5 *
	10.7 *	10.1 ↖	10.0 ↓	10.6 *	10.5 *
beste Teiler	67.1 (26.)	82.4 (23.)	90.8 (21.)		
Trefferlage	0.33 mm links, 0.08 mm hoch				
Streuwert	1.02, horizontal: 1.10, vertikal: 0.94				

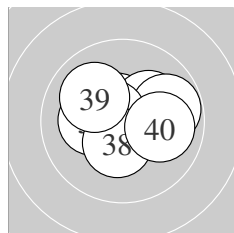

Serie 4:	10.7 *	10.6 *	10.2 *	10.1 ↖	9.8 →
	10.6 *	10.2 *	10.4 *	10.0 ↖	10.0 →
beste Teiler	71.1 (31.)	82.7 (36.)	90.4 (32.)		
Trefferlage	0.00 mm, 0.46 mm hoch				
Streuwert	1.36, horizontal: 1.72, vertikal: 0.84				

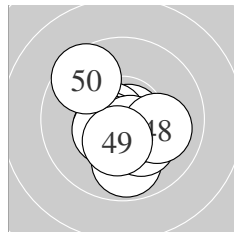

Serie 5:	10.8 *	9.8 ↓	10.7 *	10.5 *	10.5 *
	10.2 *	10.6 *	10.0 →	10.4 *	9.6 ↖
beste Teiler	38.0 (41.)	75.6 (43.)	88.4 (47.)		
Trefferlage	0.08 mm links, 0.54 mm tief				
Streuwert	1.33, horizontal: 1.28, vertikal: 1.37				

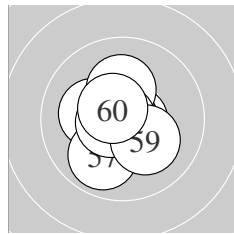

Serie 6:	10.2 *	10.7 *	10.9 *	10.5 *	10.2 *
	10.9 *	9.9 ↙	10.6 *	10.2 *	10.6 *
beste Teiler	11.7 (53.)	13.3 (56.)	67.0 (52.)		
Trefferlage	0.21 mm links, 0.18 mm tief				
Streuwert	1.06, horizontal: 0.97, vertikal: 1.14				

Meyton Elektronik

QF – Schütze hat sich fürs Finale qualifiziert

Unterschrift des Schützen

Meyton Elektronik

Ergebnis:	619.0	(592)						
Serien:	103.9	104.7	103.1	103.6	102.0	101.7		
Zähler:	52	8	0	0	0	0	0	0
Innenzehner:	39							
weiteste:	411 (52), 357 (9), 342 (43)							
beste Teiler	13.1 (14.) 14.1 (17.) 18.1 (38.)							
Trefferlage	0.14 mm links, 0.36 mm hoch							
Streuwert	1.25, horizontal: 1.40, vertikal: 1.09							

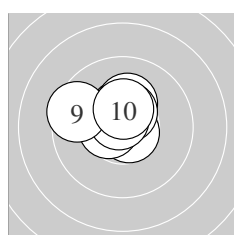
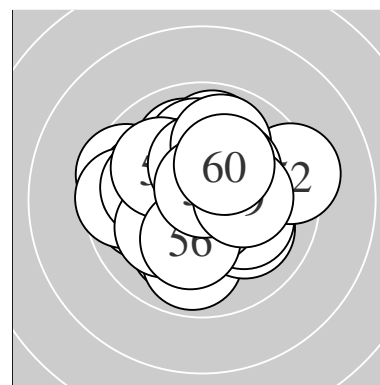

Serie 1:					
	10.5 *	10.4 *	10.5 *	10.7 *	10.2 *
	10.5 *	10.5 *	10.7 *	9.5 ↖	10.4 *
beste Teiler	62.6 (8.) 63.2 (4.) 104.3 (7.)				
Trefferlage	0.58 mm links, 0.77 mm hoch				
Streuwert	0.95, horizontal: 1.16, vertikal: 0.67				

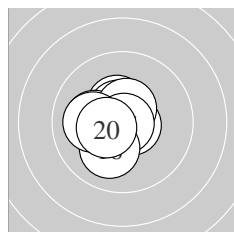

Serie 2:					
	10.4 *	10.7 *	10.6 *	10.9 *	10.1 ←
	10.5 *	10.9 *	10.1 ↙	10.1 ←	10.4 *
beste Teiler	13.1 (14.) 14.1 (17.) 67.0 (12.)				
Trefferlage	0.61 mm links, 0.04 mm hoch				
Streuwert	0.94, horizontal: 0.97, vertikal: 0.90				

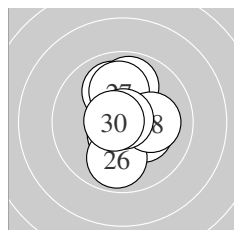

Serie 3:					
	10.0 ↕	9.9 ↑	10.7 *	10.6 *	10.3 *
	9.9 ↓	10.0 ↑	10.1 →	10.9 *	10.7 *
beste Teiler	23.5 (29.) 53.1 (23.) 64.6 (30.)				
Trefferlage	0.14 mm rechts, 0.37 mm hoch				
Streuwert	1.35, horizontal: 0.94, vertikal: 1.66				

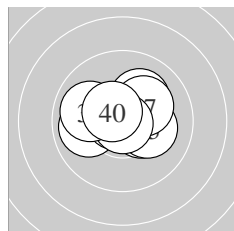

Serie 4:					
	10.1 ↗	9.9 ←	10.8 *	10.4 *	10.2 *
	10.7 *	10.2 *	10.9 *	9.9 ↖	10.5 *
beste Teiler	18.1 (38.) 40.2 (33.) 52.9 (36.)				
Trefferlage	0.05 mm links, 0.29 mm hoch				
Streuwert	1.23, horizontal: 1.58, vertikal: 0.74				

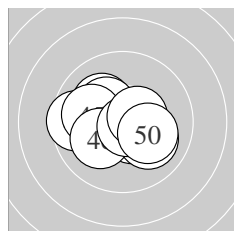

Serie 5:					
	10.1 ↘	10.3 *	9.6 ←	10.5 *	10.0 ←
	10.1 ↙	10.0 ↘	10.8 *	10.5 *	10.1 ↗
beste Teiler	46.6 (48.) 110.1 (44.) 116.4 (49.)				
Trefferlage	0.42 mm links, 0.09 mm tief				
Streuwert	1.47, horizontal: 1.85, vertikal: 0.95				

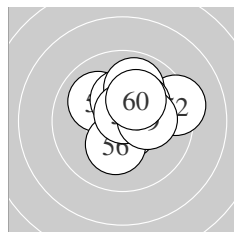

Serie 6:					
	10.7 *	9.3 →	10.0 ↘	10.3 *	9.9 ↑
	10.2 *	10.7 *	10.2 *	10.2 *	10.2 *
beste Teiler	57.0 (57.) 66.2 (51.) 157.9 (54.)				
Trefferlage	0.68 mm rechts, 0.78 mm hoch				
Streuwert	1.39, horizontal: 1.54, vertikal: 1.23				

Meyton Elektronik

ISSF AR Women Jun – Wertung – Juniorinnen

StartNr: 24

StandNr: 124

19. Januar 2019 9:48

Caluori, Valentina #70811188

SUI

Unterschrift des Schützen

Meyton Elektronik

Ergebnis:	607.6	(580)
Serien:	98.6	101.6 103.3 100.0 102.5 101.6
Zähler:	40	20 0 0 0 0 0 0 0 0
Innenzehner:	31	
weiteste:	420 (7), 396 (35), 382 (52)	
beste Teiler	20.5 (26.)	46.0 (29.) 47.0 (51.)
Trefferlage	0.02 mm links, 0.27 mm hoch	
Streuwert	1.64, horizontal: 1.86, vertikal: 1.39	

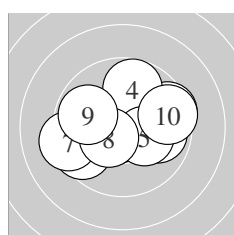
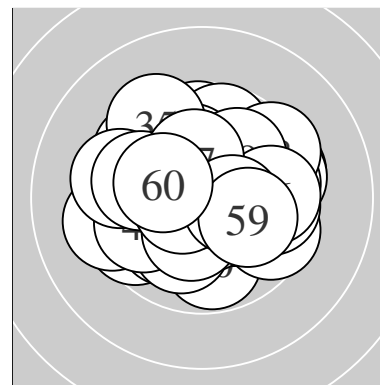

Serie 1:

10.6 *	9.5 →	9.9 →	9.8 ↑	10.2 *
9.6 ←	9.3 ←	10.4 *	9.8 ↖	9.5 →
beste Teiler	78.4 (1.) 130.0 (8.) 178.0 (5.)			
Trefferlage	0.05 mm rechts, 0.07 mm hoch			
Streuwert	2.16, horizontal: 2.73, vertikal: 1.38			

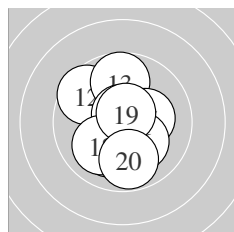

Serie 2:

10.5 *	9.6 ↘	9.7 ↑	10.1 ↓	10.3 *
10.2 *	10.7 *	10.0 ↙	10.7 *	9.8 ↓
beste Teiler	61.0 (17.) 73.3 (19.) 111.3 (11.)			
Trefferlage	0.19 mm links, 0.00 mm			
Streuwert	1.62, horizontal: 1.30, vertikal: 1.89			

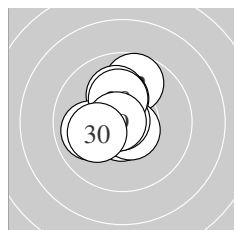

Serie 3:

10.7 *	9.7 ↑	10.2 *	10.6 *	10.1 ↑
10.9 *	10.0 ←	10.2 *	10.8 *	10.1 ←
beste Teiler	20.5 (26.) 46.0 (29.) 71.4 (21.)			
Trefferlage	0.47 mm links, 0.58 mm hoch			
Streuwert	1.22, horizontal: 1.01, vertikal: 1.39			

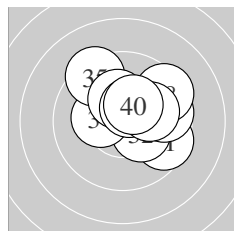

Serie 4:

9.6 ↘	10.3 *	9.7 →	10.3 *	9.4 ↖
10.3 *	10.5 *	9.4 ↗	10.1 →	10.4 *
beste Teiler	112.6 (37.) 148.1 (40.) 163.2 (32.)			
Trefferlage	1.00 mm rechts, 0.87 mm hoch			
Streuwert	1.68, horizontal: 1.93, vertikal: 1.39			

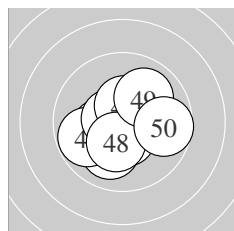

Serie 5:

10.5 *	10.0 ↓	10.3 *	9.8 ←	10.8 *
10.6 *	10.5 *	10.3 *	10.0 ↗	9.7 →
beste Teiler	49.8 (45.) 91.4 (46.) 113.0 (41.)			
Trefferlage	0.19 mm links, 0.36 mm tief			
Streuwert	1.43, horizontal: 1.62, vertikal: 1.21			

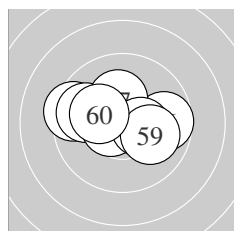

Serie 6:

10.8 *	9.4 ←	9.8 ←	10.4 *	10.6 *
9.7 →	10.2 *	10.4 *	10.1 →	10.2 *
beste Teiler	47.0 (51.) 93.3 (55.) 140.4 (58.)			
Trefferlage	0.31 mm links, 0.46 mm hoch			
Streuwert	1.61, horizontal: 2.12, vertikal: 0.82			

Meyton Elektronik

ISSF AR Women Jun – Wertung – Juniorinnen

StandNr: 125

Kitzbichler, Jasmin #95

StartNr: 25

19. Januar 2019 9:57

AUT

Unterschrift des Schützen

Meyton Elektronik

Ergebnis: **597.3** (571)

Serien: 101.2 98.6 100.2 100.4 99.2 97.7

Zähler: 36 19 5 0 0 0 0 0 0 0

Innenzehner: 26

weiteste: 715 (37), 609 (18), 584 (21)

beste Teiler 23.4 (33.) 34.7 (22.) 38.0 (4.)

Trefferlage 0.61 mm rechts, 0.58 mm hoch

Streuwert 2.02, horizontal: 2.21, vertikal: 1.81

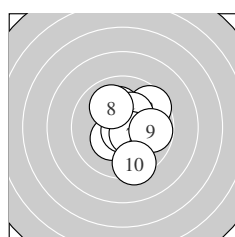
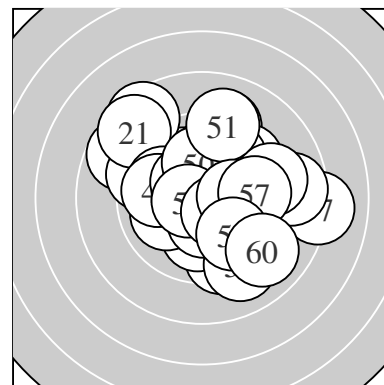

Serie 1:

10.3 *	9.6 ↗	10.3 *	10.8 *	10.2 *
10.3 *	10.5 *	10.0 ↘	9.8 →	9.4 ↓

beste Teiler 38.0 (4.) 107.2 (7.) 157.7 (3.)

Trefferlage 0.70 mm rechts, 0.01 mm tief

Streuwert 1.65, horizontal: 1.41, vertikal: 1.86

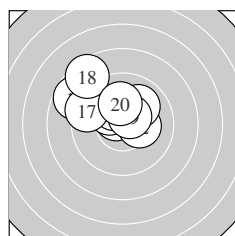

Serie 2:

10.6 *	10.3 *	10.0 ↗	10.3 *	8.7 ↖
10.2 *	9.4 ↖	8.5 ↘	10.5 *	10.1 ↑

beste Teiler 84.5 (11.) 106.0 (19.) 173.0 (12.)

Trefferlage 1.12 mm links, 1.67 mm hoch

Streuwert 1.89, horizontal: 2.28, vertikal: 1.40

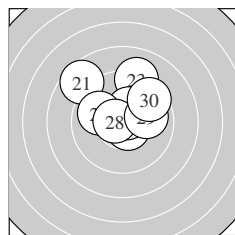

Serie 3:

8.6 ↖	10.8 *	9.1 ↑	10.6 *	10.7 *
10.4 *	9.9 ↖	10.6 *	10.0 →	9.5 ↗

beste Teiler 34.7 (22.) 62.2 (25.) 79.6 (28.)

Trefferlage 0.05 mm rechts, 1.35 mm hoch

Streuwert 1.92, horizontal: 2.11, vertikal: 1.72

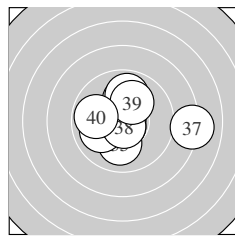

Serie 4:

10.1 ↑	9.9 ↑	10.9 *	10.7 *	10.0 ↓
10.0 ↖	8.1 →	10.7 *	10.1 ↗	9.9 ←

beste Teiler 23.4 (33.) 55.7 (34.) 56.5 (38.)

Trefferlage 0.39 mm rechts, 0.23 mm hoch

Streuwert 2.17, horizontal: 2.64, vertikal: 1.57

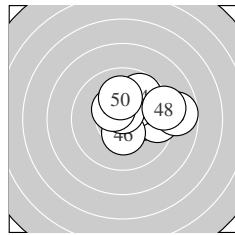

Serie 5:

10.1 →	9.5 →	10.3 *	9.8 ↗	8.7 →
10.4 *	10.7 *	9.2 →	10.4 *	10.1 ↑

beste Teiler 75.0 (47.) 135.7 (49.) 143.2 (46.)

Trefferlage 1.71 mm rechts, 0.77 mm hoch

Streuwert 1.71, horizontal: 2.14, vertikal: 1.12

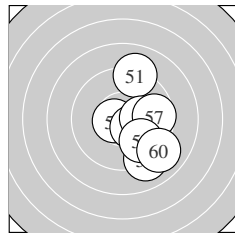

Serie 6:

9.1 ↑	9.9 →	10.6 *	9.9 →	10.4 *
10.2 *	9.7 →	9.1 ↓	9.8 ↘	9.0 ↘

beste Teiler 88.0 (53.) 127.4 (55.) 192.3 (56.)

Trefferlage 1.96 mm rechts, 0.54 mm tief

Streuwert 1.90, horizontal: 1.29, vertikal: 2.36

ISSF AR Women Jun – Wertung – Juniorinnen

StandNr: 126

Mair, Katrin #70811228

StartNr: 26

19. Januar 2019 9:32

Schützenbezirk Schwaben

Unterschrift des Schützen

Meyton Elektronik

Ergebnis: **625.0** (597)^{QF}
 Serien: 104.8 103.9 104.1 104.0 104.8 103.4
 Zähler: 57 3 0 0 0 0 0 0 0 0
 Innenzehner: 52
 weiteste: 365 (18), 272 (56), 267 (24)
 beste Teiler 47.4 (22.) 50.4 (41.) 54.7 (46.)
 Trefferlage 0.01 mm rechts, 0.07 mm hoch
 Streuwert 1.06, horizontal: 1.15, vertikal: 0.97

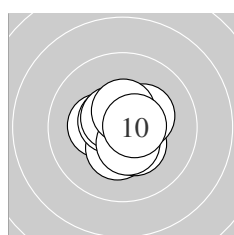
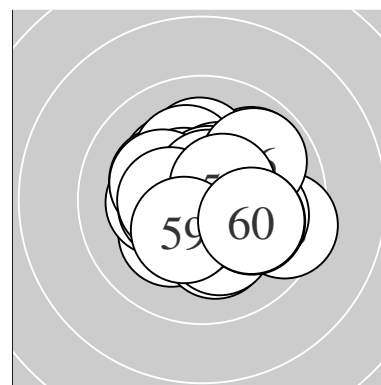

Serie 1:
 10.3 * 10.7 * 10.3 * 10.6 * 10.4 *
 10.6 * 10.3 * 10.5 * 10.5 * 10.6 *
 beste Teiler 71.1 (2.) 84.5 (10.) 96.2 (6.)
 Trefferlage 0.02 mm rechts, 0.11 mm tief
 Streuwert 0.93, horizontal: 0.94, vertikal: 0.92

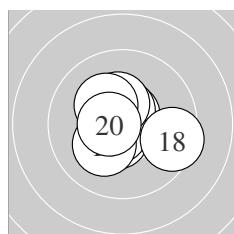

Serie 2:
 10.5 * 10.7 * 10.5 * 10.6 * 10.7 *
 10.2 * 10.4 * 9.5 ↘ 10.2 * 10.6 *
 beste Teiler 70.9 (15.) 73.2 (12.) 95.0 (20.)
 Trefferlage 0.12 mm links, 0.13 mm hoch
 Streuwert 1.23, horizontal: 1.37, vertikal: 1.06

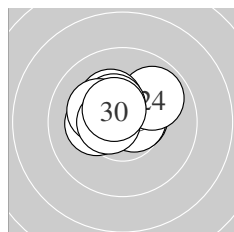

Serie 3:
 10.6 * 10.8 * 10.6 * 9.9 ↗ 10.2 *
 10.3 * 10.4 * 10.2 * 10.6 * 10.5 *
 beste Teiler 47.4 (22.) 82.2 (23.) 96.3 (21.)
 Trefferlage 0.31 mm links, 0.65 mm hoch
 Streuwert 0.98, horizontal: 1.23, vertikal: 0.64

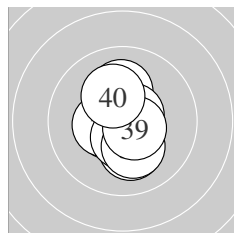

Serie 4:
 10.5 * 10.1 ↑ 10.7 * 10.6 * 10.4 *
 10.2 * 10.5 * 10.2 * 10.6 * 10.2 *
 beste Teiler 64.8 (33.) 79.9 (34.) 97.2 (39.)
 Trefferlage 0.05 mm links, 0.23 mm tief
 Streuwert 1.09, horizontal: 0.76, vertikal: 1.34

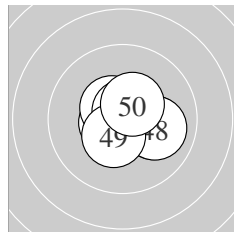

Serie 5:
 10.8 * 10.7 * 10.6 * 10.6 * 10.5 *
 10.7 * 10.0 ↘ 10.0 ↘ 10.4 * 10.5 *
 beste Teiler 50.4 (41.) 54.7 (46.) 57.2 (42.)
 Trefferlage 0.22 mm rechts, 0.12 mm tief
 Streuwert 0.97, horizontal: 1.17, vertikal: 0.70

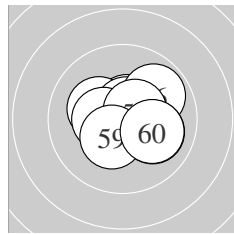

Serie 6:
 10.6 * 10.7 * 10.2 * 10.6 * 10.4 *
 9.9 ↗ 10.5 * 10.0 ↘ 10.4 * 10.1 ↘
 beste Teiler 65.7 (52.) 76.2 (54.) 92.9 (51.)
 Trefferlage 0.34 mm rechts, 0.11 mm hoch
 Streuwert 1.22, horizontal: 1.44, vertikal: 0.94

Meyton Elektronik

ISSF AR Women Jun – Wertung – Juniorinnen

StandNr: 127

Rossiter, Victoria #189

StartNr: 27

19. Januar 2019 9:50

AUS

QF – Schütze hat sich fürs Finale qualifiziert

Unterschrift des Schützen

Meyton Elektronik

Ergebnis: **576.2** (551)

Serien: 93.8 97.1 97.8 98.1 95.8 93.6

Zähler: 20 31 9 0 0 0 0 0 0

Innenzehner: 17

weiteste: 721 (47), 685 (56), 632 (7)

beste Teiler 23.0 (60.) 32.2 (36.) 55.2 (17.)

Trefferlage 0.53 mm rechts, 0.18 mm hoch

Streuwert 2.67, horizontal: 3.24, vertikal: 1.95

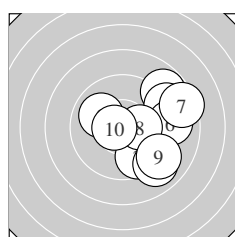
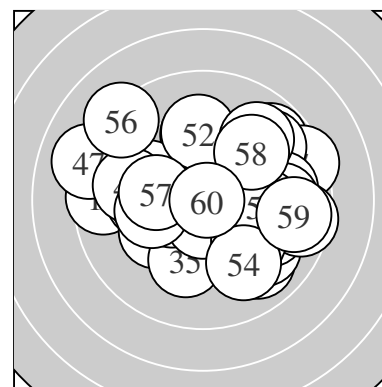

Serie 1:

8.8 ↗	10.0 ↖	9.6 ↘	9.0 ↘	9.0 ↗
9.0 →	8.4 →	10.3 *	9.1 ↘	10.6 *

beste Teiler 83.1 (10.) 172.0 (8.) 243.8 (2.)

Trefferlage 2.62 mm rechts, 0.00 mm

Streuwert 2.51, horizontal: 2.55, vertikal: 2.46

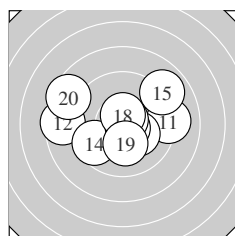

Serie 2:

9.1 →	8.6 ←	10.2 *	9.6 ↖	8.9 ↗
10.7 *	10.7 *	10.6 *	10.2 *	8.5 ↖

beste Teiler 55.2 (17.) 64.4 (16.) 90.0 (18.)

Trefferlage 0.30 mm links, 0.26 mm hoch

Streuwert 2.77, horizontal: 3.52, vertikal: 1.71

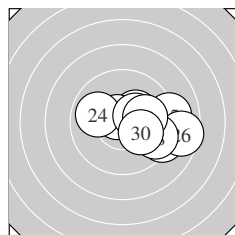

Serie 3:

10.3 *	10.7 *	9.2 ↘	9.9 ↖	9.1 →
8.6 →	10.4 *	9.5 ↘	10.0 →	10.1 ↘

beste Teiler 73.5 (22.) 142.6 (27.) 161.6 (21.)

Trefferlage 2.14 mm rechts, 0.13 mm tief

Streuwert 1.90, horizontal: 2.47, vertikal: 1.07

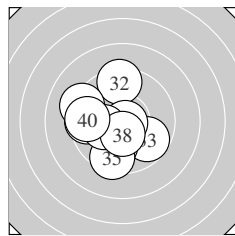

Serie 4:

9.5 ←	9.4 ↑	9.7 ↘	9.9 ↓	9.5 ↓
10.8 *	10.2 *	10.4 *	9.2 ↖	9.5 ←

beste Teiler 32.2 (36.) 128.0 (38.) 194.7 (37.)

Trefferlage 1.23 mm links, 0.43 mm tief

Streuwert 2.08, horizontal: 2.04, vertikal: 2.11

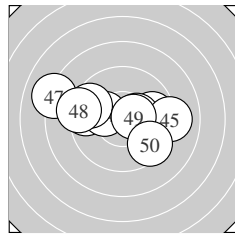

Serie 5:

9.5 ←	9.8 →	10.4 *	10.2 *	9.1 →
9.5 ↖	8.1 ←	9.2 ←	10.5 *	9.5 ↘

beste Teiler 112.1 (49.) 144.8 (43.) 187.3 (44.)

Trefferlage 0.70 mm links, 0.41 mm hoch

Streuwert 2.82, horizontal: 3.80, vertikal: 1.21

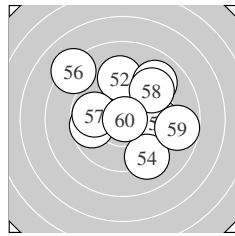

Serie 6:

9.5 →	9.3 ↑	9.0 ↗	9.2 ↘	9.7 ←
8.2 ↖	9.8 ←	9.3 ↗	8.7 →	10.9 *

beste Teiler 23.0 (60.) 284.4 (57.) 313.6 (55.)

Trefferlage 0.67 mm rechts, 1.01 mm hoch

Streuwert 3.08, horizontal: 3.40, vertikal: 2.71

ISSF AR Women Jun – Wertung – Juniorinnen

StandNr: 128

Fuchs, Verena #106

StartNr: 28

19. Januar 2019 9:48

T – SG Ampass

Unterschrift des Schützen

Meyton Elektronik

Ergebnis: **604.4** (577)

Serien: 99.0 102.0 100.8 102.1 101.6 98.9

Zähler: 39 19 2 0 0 0 0 0 0 0

Innenzehner: 27

weiteste: 536 (53), 518 (41), 486 (59)

beste Teiler 32.2 (35.) 55.9 (48.) 56.4 (33.)

Trefferlage 0.13 mm links, 0.23 mm hoch

Streuwert 1.78, horizontal: 2.04, vertikal: 1.47

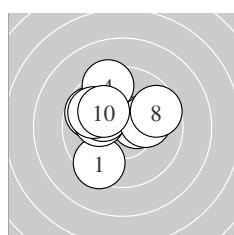
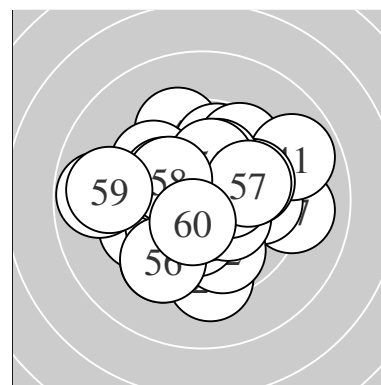

Serie 1:

9.5 ↙	10.4 *	9.7 ↘	9.4 ↑	10.1 ↖
10.2 *	10.1 →	9.7 ↗	9.8 ↘	10.1 ↖

beste Teiler 129.0 (2.) 197.7 (6.) 203.9 (7.)

Trefferlage 0.78 mm links, 0.82 mm hoch

Streuwert 1.85, horizontal: 2.04, vertikal: 1.65

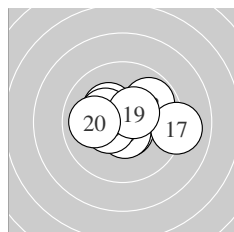

Serie 2:

10.4 *	9.8 ↗	10.3 *	10.6 *	10.6 *
10.3 *	9.1 →	10.5 *	10.4 *	10.0 ←

beste Teiler 87.8 (14.) 92.4 (15.) 124.7 (18.)

Trefferlage 0.09 mm rechts, 0.23 mm hoch

Streuwert 1.63, horizontal: 2.13, vertikal: 0.88

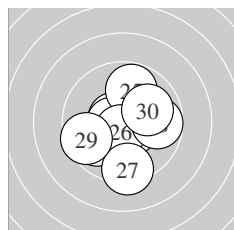

Serie 3:

9.9 ↙	10.6 *	10.6 *	10.5 *	9.8 ↑
10.7 *	9.3 ↓	9.8 →	9.6 ↙	10.0 →

beste Teiler 75.7 (26.) 82.3 (22.) 89.3 (23.)

Trefferlage 0.00 mm , 0.44 mm tief

Streuwert 1.83, horizontal: 1.86, vertikal: 1.80

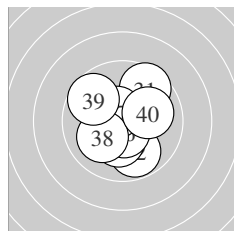

Serie 4:

9.6 ↗	9.8 ↓	10.7 *	10.2 *	10.8 *
10.6 *	10.6 *	10.1 ↙	9.7 ↘	10.0 →

beste Teiler 32.2 (35.) 56.4 (33.) 92.6 (37.)

Trefferlage 0.07 mm rechts, 0.05 mm tief

Streuwert 1.59, horizontal: 1.49, vertikal: 1.68

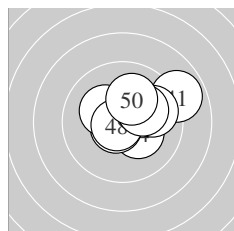

Serie 5:

8.9 →	10.3 *	10.4 *	10.3 *	10.7 *
10.2 *	9.9 →	10.7 *	10.1 →	10.1 ↑

beste Teiler 55.9 (48.) 73.2 (45.) 135.3 (43.)

Trefferlage 1.05 mm rechts, 0.77 mm hoch

Streuwert 1.45, horizontal: 1.77, vertikal: 1.02

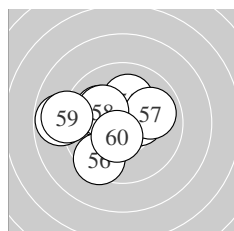

Serie 6:

10.1 ↘	10.4 *	8.8 ←	10.5 *	10.1 ↑
9.5 ↙	9.9 →	10.1 ↘	9.0 ←	10.5 *

beste Teiler 110.9 (54.) 125.9 (60.) 138.2 (52.)

Trefferlage 1.26 mm links, 0.06 mm hoch

Streuwert 2.04, horizontal: 2.48, vertikal: 1.46

ISSF AR Women Jun – Wertung – Juniorinnen

StartNr: 49

StandNr: 101

19. Januar 2019 11:22

Münzinger, Ramona #70811238

Schützenbezirk Schwaben

Unterschrift des Schützen

Meyton Elektronik

Ergebnis:	606.2	(578)
Serien:	98.9	103.8 100.8 99.2 102.7 100.8
Zähler:	40	18 2 0 0 0 0 0 0 0
Innenzehner:	31	
weiteste:	604 (8), 533 (40), 416 (25)	
beste Teiler	20.8 (12.)	27.1 (53.) 35.5 (50.)
Trefferlage	0.04 mm links, 0.12 mm tief	
Streuwert	1.75, horizontal: 1.43, vertikal: 2.02	

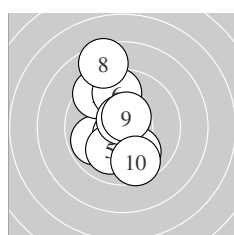
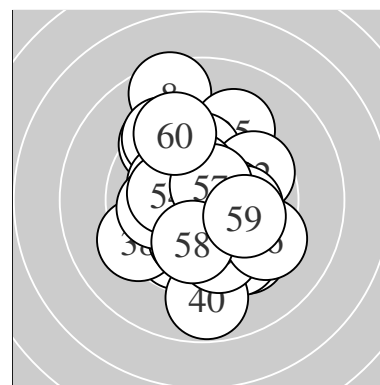

Serie 1:

9.9 ↙	9.4 ↘	10.6 *	9.9 ↘	10.0 ↘
9.7 ↑	10.7 *	8.5 ↑	10.6 *	9.6 ↘
beste Teiler	67.4 (7.) 83.8 (3.) 99.9 (9.)			
Trefferlage	0.60 mm links, 0.43 mm hoch			
Streuwert	2.21, horizontal: 1.32, vertikal: 2.83			

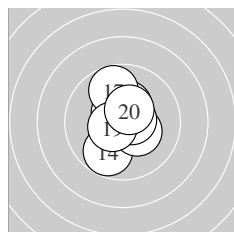

Serie 2:

10.7 *	10.9 *	10.5 *	9.8 ↘	10.3 *
10.3 *	9.8 ↑	10.6 *	10.5 *	10.4 *
beste Teiler	20.8 (12.) 63.5 (11.) 86.3 (18.)			
Trefferlage	0.11 mm links, 0.31 mm hoch			
Streuwert	1.21, horizontal: 0.87, vertikal: 1.47			

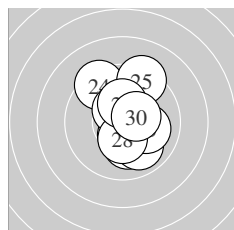

Serie 3:

10.1 ↘	9.9 ↘	10.1 →	9.4 ↘	9.3 ↑
10.5 *	10.5 *	10.3 *	10.3 *	10.4 *
beste Teiler	116.0 (26.) 123.4 (27.) 133.5 (30.)			
Trefferlage	0.43 mm rechts, 0.30 mm hoch			
Streuwert	1.76, horizontal: 1.26, vertikal: 2.15			

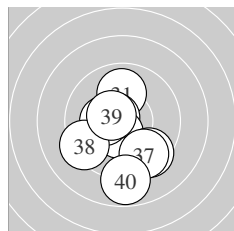

Serie 4:

9.9 ↑	10.3 *	10.6 *	10.5 *	9.5 ↘
10.3 *	9.5 ↘	9.3 ↙	10.5 *	8.8 ↓
beste Teiler	76.0 (33.) 114.0 (39.) 117.6 (34.)			
Trefferlage	0.41 mm links, 1.16 mm tief			
Streuwert	1.99, horizontal: 1.71, vertikal: 2.23			

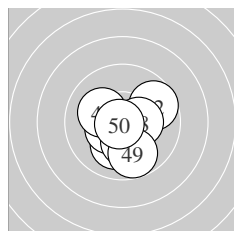

Serie 5:

10.1 ↘	9.7 →	10.7 *	10.5 *	10.4 *
10.1 ↘	10.2 *	10.4 *	9.8 ↘	10.8 *
beste Teiler	35.5 (50.) 51.2 (43.) 111.3 (44.)			
Trefferlage	0.23 mm rechts, 0.64 mm tief			
Streuwert	1.33, horizontal: 1.34, vertikal: 1.32			

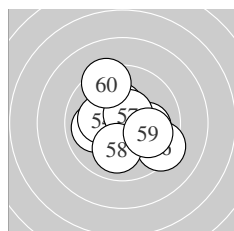

Serie 6:

10.4 *	10.0 ←	10.8 *	10.2 *	10.1 →
9.3 ↘	10.6 *	10.0 ↓	10.0 →	9.4 ↘
beste Teiler	27.1 (53.) 93.8 (57.) 148.1 (51.)			
Trefferlage	0.21 mm rechts, 0.01 mm hoch			
Streuwert	1.83, horizontal: 1.93, vertikal: 1.72			

Meyton Elektronik

ISSF AR Women Jun – Wertung – Juniorinnen

StandNr: 102

Harrasser, Pia #1

StartNr: 50

19. Januar 2019 11:36

TLSB

Unterschrift des Schützen

Meyton Elektronik

Ergebnis:	613.4	(585)
Serien:	102.6	101.9 101.4 103.9 99.3 104.3
Zähler:	45	15 0 0 0 0 0 0 0 0
Innenzehner:	36	
weiteste:	459 (44), 407 (14), 396 (49)	
beste Teiler	20.2 (1.)	39.3 (53.) 46.1 (56.)
Trefferlage	0.20 mm rechts, 0.30 mm hoch	
Streuwert	1.46, horizontal: 1.65, vertikal: 1.25	

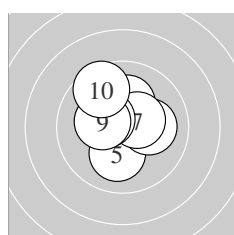
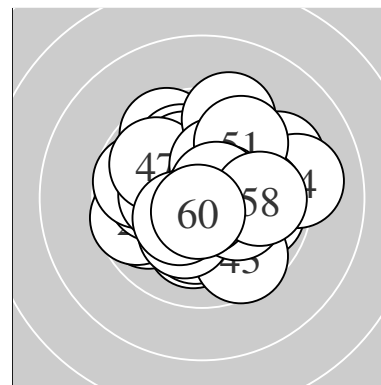

Serie 1:	10.9 *	10.3 *	10.3 *	10.2 *	10.1 ↓
	10.1 →	10.4 *	10.4 *	10.3 *	9.6 ↘
beste Teiler	20.2 (1.) 128.8 (7.) 141.3 (8.)				
Trefferlage	0.38 mm links, 0.61 mm hoch				
Streuwert	1.31, horizontal: 1.30, vertikal: 1.32				

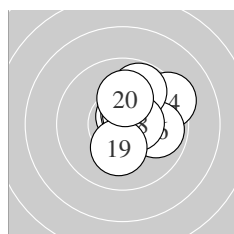

Serie 2:	10.7 *	10.2 *	10.6 *	9.3 ↗	10.6 *
	9.9 →	9.8 ↗	10.5 *	10.2 *	10.1 ↑
beste Teiler	61.9 (11.) 93.7 (13.) 94.7 (15.)				
Trefferlage	1.16 mm rechts, 0.68 mm hoch				
Streuwert	1.26, horizontal: 1.23, vertikal: 1.29				

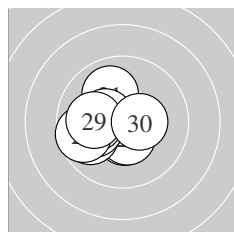

Serie 3:	10.0 ↘	10.5 *	10.4 *	10.5 *	9.8 ↖
	10.0 ←	10.1 ←	9.7 ↖	10.0 ←	10.4 *
beste Teiler	119.8 (22.) 121.7 (24.) 135.0 (30.)				
Trefferlage	1.28 mm links, 0.22 mm tief				
Streuwert	1.28, horizontal: 1.47, vertikal: 1.05				

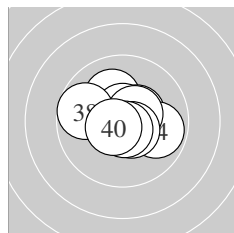

Serie 4:	10.1 ↘	10.4 *	10.7 *	9.9 →	10.7 *
	10.5 *	10.6 *	9.7 ↖	10.7 *	10.6 *
beste Teiler	59.3 (33.) 67.9 (39.) 75.0 (35.)				
Trefferlage	0.05 mm rechts, 0.17 mm hoch				
Streuwert	1.22, horizontal: 1.49, vertikal: 0.87				

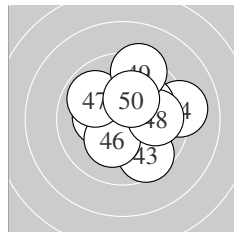

Serie 5:	10.5 *	10.3 *	9.6 ↘	9.1 →	10.1 ↗
	10.2 *	9.9 ↘	9.9 →	9.4 ↑	10.3 *
beste Teiler	117.3 (41.) 173.3 (50.) 175.5 (42.)				
Trefferlage	0.89 mm rechts, 0.55 mm hoch				
Streuwert	1.92, horizontal: 2.04, vertikal: 1.79				

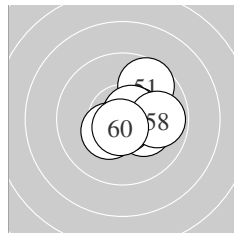

Serie 6:	9.7 ↗	10.5 *	10.8 *	10.2 *	10.7 *
	10.8 *	10.6 *	9.9 →	10.4 *	10.7 *
beste Teiler	39.3 (53.) 46.1 (56.) 63.0 (55.)				
Trefferlage	0.78 mm rechts, 0.04 mm hoch				
Streuwert	1.06, horizontal: 1.10, vertikal: 1.01				

Meyton Elektronik

ISSF AR Women Jun – Wertung – Juniorinnen

StandNr: 103

Leopold, Magdalena #3

StartNr: 51

19. Januar 2019 11:21

T – SG Aschau

Unterschrift des Schützen

Meyton Elektronik

Ergebnis: **619.6** (591)
 Serien: 103.0 103.9 102.5 104.1 102.5 103.6
 Zähler: 51 9 0 0 0 0 0 0 0
 Innenzehner: 47
 weiteste: 391 (31), 303 (4), 301 (41)
 beste Teiler 13.0 (32.) 37.3 (17.) 40.3 (59.)
 Trefferlage 0.05 mm links, 0.10 mm tief
 Streuwert 1.22, horizontal: 1.01, vertikal: 1.40

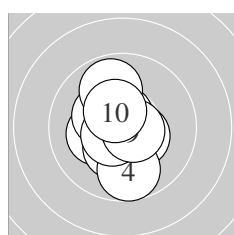
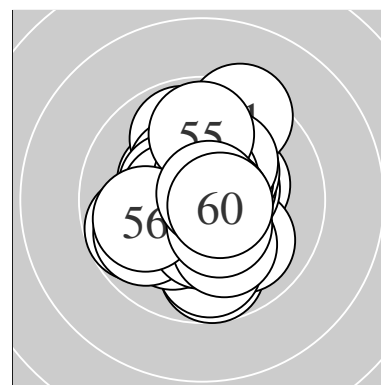

Serie 1:
 10.2 * 10.4 * 10.3 * 9.7 ↓ 10.3 *
 10.6 * 9.9 ↑ 10.6 * 10.6 * 10.4 *
 beste Teiler 76.3 (6.) 79.0 (9.) 89.6 (8.)
 Trefferlage 0.36 mm links, 0.09 mm tief
 Streuwert 1.27, horizontal: 0.92, vertikal: 1.54

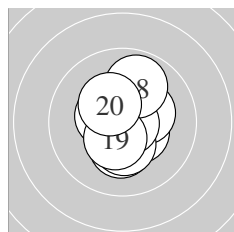

Serie 2:
 10.4 * 10.6 * 10.5 * 10.3 * 10.3 *
 10.3 * 10.8 * 9.9 ↑ 10.5 * 10.3 *
 beste Teiler 37.3 (17.) 86.2 (12.) 124.0 (13.)
 Trefferlage 0.04 mm rechts, 0.02 mm tief
 Streuwert 1.14, horizontal: 0.92, vertikal: 1.32

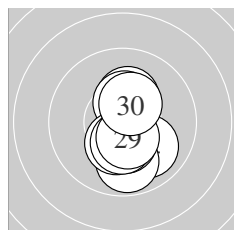

Serie 3:
 10.3 * 10.4 * 10.0 ↓ 10.0 ↘ 9.8 ↓
 10.4 * 10.3 * 10.4 * 10.5 * 10.4 *
 beste Teiler 113.8 (29.) 139.7 (22.) 140.6 (30.)
 Trefferlage 0.35 mm rechts, 0.78 mm tief
 Streuwert 1.21, horizontal: 0.56, vertikal: 1.62

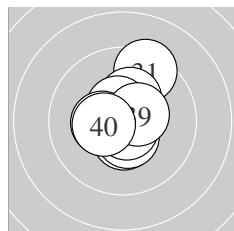

Serie 4:
 9.4 ↑ 10.9 * 10.5 * 10.5 * 10.7 *
 10.3 * 10.5 * 10.4 * 10.5 * 10.4 *
 beste Teiler 13.0 (32.) 60.0 (35.) 102.1 (37.)
 Trefferlage 0.09 mm rechts, 0.34 mm hoch
 Streuwert 1.21, horizontal: 0.96, vertikal: 1.42

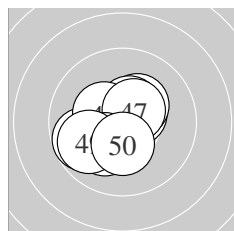

Serie 5:
 9.7 ← 10.5 * 10.3 * 10.5 * 10.4 *
 10.4 * 10.5 * 10.1 ↙ 9.8 ← 10.3 *
 beste Teiler 107.3 (42.) 113.2 (44.) 114.5 (47.)
 Trefferlage 0.57 mm links, 0.22 mm tief
 Streuwert 1.29, horizontal: 1.40, vertikal: 1.16

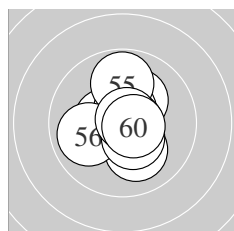

Serie 6:
 10.2 * 10.5 * 10.6 * 10.1 ↓ 9.8 ↑
 9.9 ← 10.7 * 10.4 * 10.8 * 10.6 *
 beste Teiler 40.3 (59.) 66.4 (57.) 80.3 (60.)
 Trefferlage 0.09 mm rechts, 0.17 mm hoch
 Streuwert 1.23, horizontal: 1.09, vertikal: 1.35

Meyton Elektronik

ISSF AR Women Jun – Wertung – Juniorinnen

StartNr: 52

StandNr: 104

19. Januar 2019 11:56

Takagi, Aoi #70811174

Japan

Unterschrift des Schützen

Meyton Elektronik

Ergebnis: **625.5** (595)^{QF}
 Serien: 104.1 104.7 105.2 103.4 105.4 102.7
 Zähler: 56 3 1 0 0 0 0 0 0
 Innenzehner: 54
 weiteste: 571 (56), 369 (32), 303 (60)
 beste Teiler 12.0 (49.) 12.2 (14.) 32.5 (9.)
 Trefferlage 0.06 mm links, 0.25 mm hoch
 Streuwert 1.12, horizontal: 1.30, vertikal: 0.90

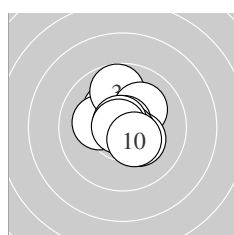
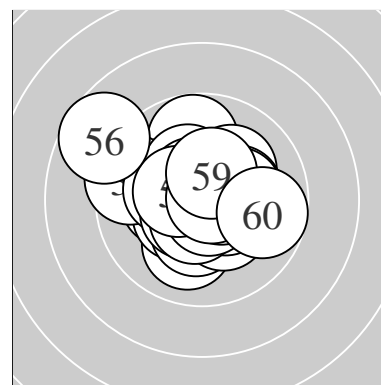

Serie 1:
 10.2 * 10.2 * 9.8 ↑ 10.1 ↗ 10.8 *
 10.3 * 10.7 * 10.8 * 10.8 * 10.4 *
 beste Teiler 32.5 (9.) 37.3 (5.) 43.0 (8.)
 Trefferlage 0.03 mm rechts, 0.46 mm hoch
 Streuwert 1.14, horizontal: 1.05, vertikal: 1.21

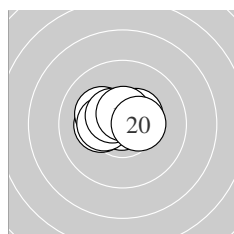

Serie 2:
 10.2 * 10.7 * 10.5 * 10.9 * 10.2 *
 10.3 * 10.4 * 10.5 * 10.6 * 10.4 *
 beste Teiler 12.2 (14.) 70.6 (12.) 86.2 (19.)
 Trefferlage 0.20 mm links, 0.40 mm hoch
 Streuwert 0.88, horizontal: 1.19, vertikal: 0.37

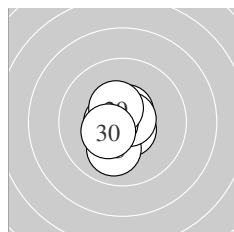

Serie 3:
 10.6 * 10.6 * 10.6 * 10.7 * 10.0 ↓
 10.6 * 10.7 * 10.6 * 10.4 * 10.4 *
 beste Teiler 56.3 (27.) 71.0 (24.) 78.6 (21.)
 Trefferlage 0.34 mm links, 0.00 mm
 Streuwert 0.82, horizontal: 0.62, vertikal: 0.99

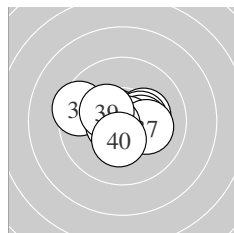

Serie 4:
 10.7 * 9.5 ← 10.2 * 10.4 * 10.4 *
 10.8 * 10.2 * 10.6 * 10.3 * 10.3 *
 beste Teiler 41.5 (36.) 67.1 (31.) 85.4 (38.)
 Trefferlage 0.04 mm rechts, 0.02 mm hoch
 Streuwert 1.32, horizontal: 1.72, vertikal: 0.73

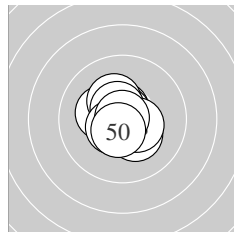

Serie 5:
 10.3 * 10.6 * 10.3 * 10.8 * 10.3 *
 10.6 * 10.5 * 10.5 * 10.9 * 10.6 *
 beste Teiler 12.0 (49.) 45.7 (44.) 80.3 (42.)
 Trefferlage 0.17 mm links, 0.08 mm hoch
 Streuwert 0.86, horizontal: 0.84, vertikal: 0.88

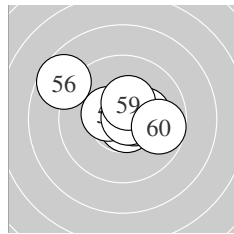

Serie 6:
 10.7 * 10.6 * 10.5 * 10.5 * 10.5 *
 8.7 ↘ 10.3 * 10.8 * 10.4 * 9.7 →
 beste Teiler 48.0 (58.) 60.7 (51.) 96.0 (52.)
 Trefferlage 0.26 mm rechts, 0.56 mm hoch
 Streuwert 1.65, horizontal: 2.08, vertikal: 1.06

Meyton Elektronik

ISSF AR Women Jun – Wertung – Juniorinnen

StartNr: 53

StandNr: 105

19. Januar 2019 11:45

Bolotkova, Polina #70811200

RUS

QF – Schütze hat sich fürs Finale qualifiziert

Unterschrift des Schützen

Meyton Elektronik

Ergebnis:	603.1	(576)							
Serien:	100.9	101.7	98.2	102.7	99.5	100.1			
Zähler:	38	20	2	0	0	0	0	0	0
Innenzehner:	32								
weiteste:	542 (3),	539 (21),	474 (34)						
beste Teiler	7.0 (40.)	22.8 (5.)	42.2 (9.)						
Trefferlage	0.15 mm links, 0.06 mm tief								
Streuwert	1.84, horizontal: 1.47, vertikal: 2.15								

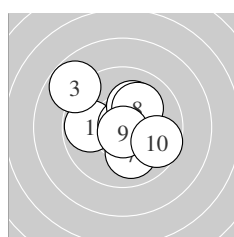
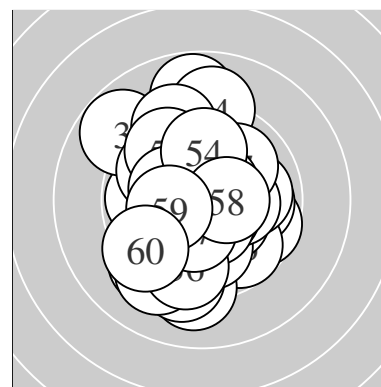

Serie 1:

9.8 ←	10.2 *	8.8 ↖	10.4 *	10.9 *
10.2 *	10.0 ↓	10.1 ↗	10.8 *	9.7 ↘
beste Teiler	22.8 (5.) 42.2 (9.) 142.3 (4.)			
Trefferlage	0.08 mm rechts, 0.62 mm hoch			
Streuwert	1.88, horizontal: 2.07, vertikal: 1.67			

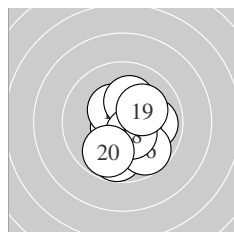

Serie 2:

10.7 *	10.5 *	10.4 *	9.8 ↓	9.9 →
9.7 ↘	10.2 *	10.5 *	10.2 *	9.8 ↓
beste Teiler	71.0 (11.) 123.4 (18.) 124.5 (12.)			
Trefferlage	0.56 mm rechts, 0.50 mm tief			
Streuwert	1.49, horizontal: 1.30, vertikal: 1.66			

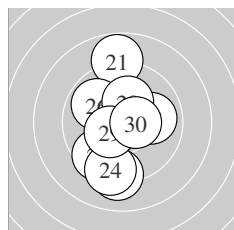

Serie 3:

8.8 ↑	9.5 ↙	9.1 ↓	9.3 ↓	10.5 *
9.9 ↖	10.0 →	10.2 *	10.4 *	10.5 *
beste Teiler	110.2 (25.) 114.0 (30.) 139.0 (29.)			
Trefferlage	0.42 mm links, 0.40 mm tief			
Streuwert	2.34, horizontal: 1.45, vertikal: 2.98			

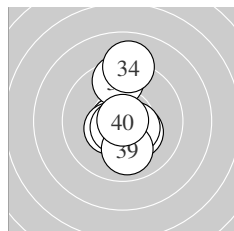

Serie 4:

10.7 *	9.5 ↑	10.7 *	9.1 ↑	10.3 *
10.5 *	10.4 *	10.6 *	10.0 ↓	10.9 *
beste Teiler	7.0 (40.) 59.0 (33.) 63.1 (31.)			
Trefferlage	0.05 mm rechts, 0.24 mm hoch			
Streuwert	1.62, horizontal: 0.76, vertikal: 2.16			

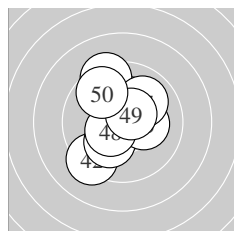

Serie 5:

9.8 ↖	9.3 ↙	10.2 *	10.1 ↙	10.2 *
9.3 ↖	10.0 ↗	10.4 *	10.5 *	9.7 ↘
beste Teiler	101.8 (49.) 127.6 (48.) 177.5 (43.)			
Trefferlage	0.46 mm links, 0.73 mm hoch			
Streuwert	1.89, horizontal: 1.54, vertikal: 2.20			

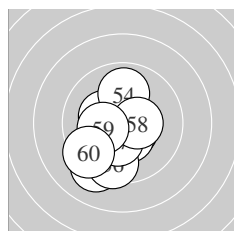

Serie 6:

10.3 *	10.5 *	10.4 *	9.9 ↑	9.2 ↓
9.5 ↓	10.3 *	10.4 *	10.2 *	9.4 ↙
beste Teiler	106.9 (52.) 128.0 (58.) 130.0 (53.)			
Trefferlage	0.71 mm links, 1.05 mm tief			
Streuwert	1.68, horizontal: 1.41, vertikal: 1.91			

Meyton Elektronik

ISSF AR Women Jun – Wertung – Juniorinnen

StandNr: 106

Vinto, Debora #70811239

StartNr: 54

19. Januar 2019 11:35

ITA – Accademia

Unterschrift des Schützen

Meyton Elektronik

Ergebnis:	624.8	(593) ^{QF}							
Serien:	105.7	101.9	103.2	104.4	104.4	105.2			
Zähler:	53	7	0	0	0	0	0	0	0
Innenzehner:	49								
weiteste:	415 (19), 401 (43), 372 (35)								
beste Teiler	4.1 (58.) 13.1 (57.) 14.1 (54.)								
Trefferlage	0.42 mm rechts, 0.08 mm hoch								
Streuwert	1.12, horizontal: 1.30, vertikal: 0.90								

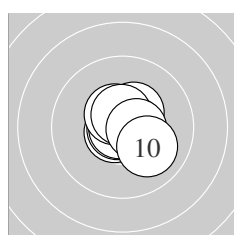
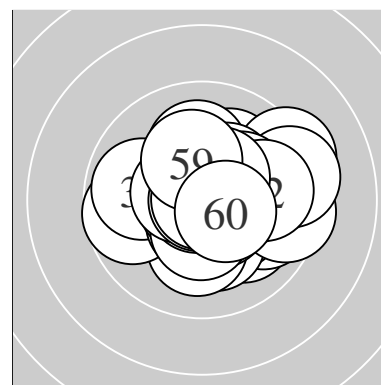

Serie 1:					
	10.7 *	10.4 *	10.7 *	10.7 *	10.8 *
	10.8 *	10.5 *	10.6 *	10.5 *	10.0 ↘
beste Teiler	27.2 (6.) 41.7 (5.) 65.0 (4.)				
Trefferlage	0.30 mm rechts, 0.08 mm hoch				
Streuwert	0.78, horizontal: 0.81, vertikal: 0.75				

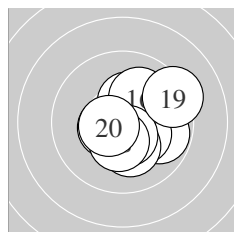

Serie 2:					
	9.8 ↘	10.5 *	10.3 *	10.2 *	10.3 *
	10.1 ↗	10.5 *	10.4 *	9.3 ↗	10.5 *
beste Teiler	104.8 (20.) 106.8 (17.) 116.4 (12.)				
Trefferlage	0.79 mm rechts, 0.14 mm tief				
Streuwert	1.45, horizontal: 1.53, vertikal: 1.36				

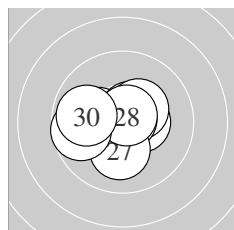

Serie 3:					
	10.2 *	10.4 *	10.6 *	10.4 *	10.4 *
	10.8 *	10.1 ↓	10.7 *	9.7 ←	9.9 ←
beste Teiler	35.2 (26.) 57.9 (28.) 94.4 (23.)				
Trefferlage	0.45 mm links, 0.07 mm tief				
Streuwert	1.28, horizontal: 1.54, vertikal: 0.95				

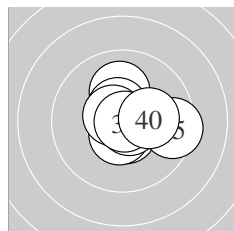

Serie 4:					
	10.6 *	10.5 *	10.8 *	10.1 ↑	9.5 →
	10.7 *	10.5 *	10.6 *	10.9 *	10.2 *
beste Teiler	14.5 (39.) 48.7 (33.) 58.3 (36.)				
Trefferlage	0.53 mm rechts, 0.13 mm hoch				
Streuwert	1.15, horizontal: 1.32, vertikal: 0.94				

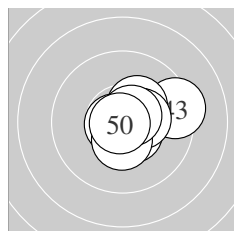

Serie 5:					
	10.5 *	10.8 *	9.3 →	10.3 *	10.7 *
	10.5 *	10.4 *	10.4 *	10.6 *	10.9 *
beste Teiler	23.2 (50.) 31.9 (42.) 60.1 (45.)				
Trefferlage	0.82 mm rechts, 0.10 mm hoch				
Streuwert	1.03, horizontal: 1.24, vertikal: 0.75				

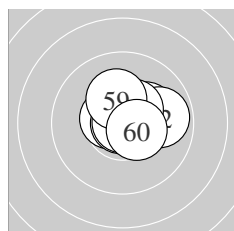

Serie 6:					
	10.2 *	9.9 →	10.6 *	10.9 *	10.5 *
	10.6 *	10.9 *	10.9 *	10.2 *	10.5 *
beste Teiler	4.1 (58.) 13.1 (57.) 14.1 (54.)				
Trefferlage	0.54 mm rechts, 0.41 mm hoch				
Streuwert	0.89, horizontal: 1.08, vertikal: 0.63				

Meyton Elektronik

ISSF AR Women Jun – Wertung – Juniorinnen

StartNr: 55

StandNr: 107

19. Januar 2019 11:29

Sysoeva, Elizaveta #70811240

RUS

QF – Schütze hat sich fürs Finale qualifiziert

Unterschrift des Schützen

Meyton Elektronik

Ergebnis: **617.1** (586)
 Serien: 103.8 101.3 103.5 104.4 102.4 101.7
 Zähler: 46 14 0 0 0 0 0 0 0
 Innenzehner: 43
 weiteste: 366 (55), 361 (17), 341 (15)
 beste Teiler 33.3 (5.) 34.7 (10.) 38.6 (3.)
 Trefferlage 0.07 mm rechts, 0.22 mm hoch
 Streuwert 1.33, horizontal: 1.27, vertikal: 1.38

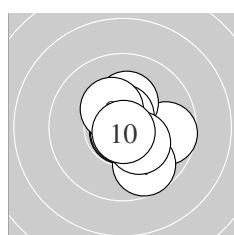
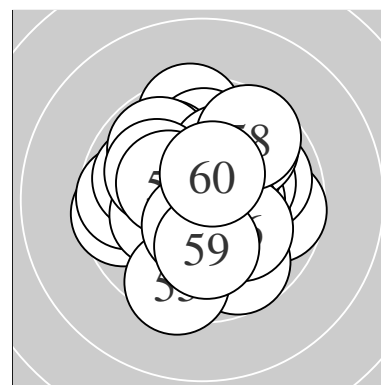

Serie 1:
 9.7 → 10.6 * 10.8 * 9.7 ↘ 10.8 *
 10.2 * 10.6 * 10.3 * 10.3 * 10.8 *
 beste Teiler 33.3 (5.) 34.7 (10.) 38.6 (3.)
 Trefferlage 0.50 mm rechts, 0.05 mm tief
 Streuwert 1.21, horizontal: 1.13, vertikal: 1.29

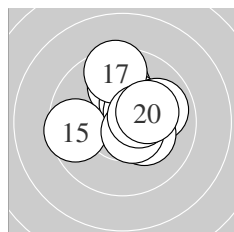

Serie 2:
 9.9 ↑ 10.4 * 9.9 → 10.5 * 9.6 ←
 10.2 * 9.5 ↑ 10.6 * 10.5 * 10.2 *
 beste Teiler 98.3 (18.) 113.5 (14.) 123.0 (19.)
 Trefferlage 0.49 mm rechts, 0.80 mm hoch
 Streuwert 1.52, horizontal: 1.62, vertikal: 1.41

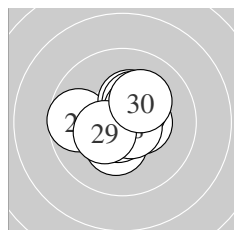

Serie 3:
 9.7 ← 10.3 * 10.3 * 10.7 * 10.3 *
 10.4 * 10.5 * 10.7 * 10.4 * 10.2 *
 beste Teiler 67.4 (28.) 71.1 (24.) 123.7 (27.)
 Trefferlage 0.00 mm , 0.20 mm hoch
 Streuwert 1.23, horizontal: 1.38, vertikal: 1.06

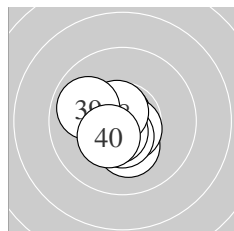

Serie 4:
 10.5 * 10.2 * 10.8 * 10.3 * 10.6 *
 10.5 * 10.6 * 10.6 * 9.9 ↖ 10.4 *
 beste Teiler 43.9 (33.) 76.3 (38.) 79.1 (35.)
 Trefferlage 0.46 mm links, 0.37 mm tief
 Streuwert 0.94, horizontal: 0.96, vertikal: 0.92

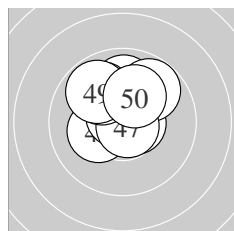

Serie 5:
 9.9 ↑ 10.6 * 10.2 * 10.7 * 10.6 *
 9.8 ↗ 10.8 * 9.9 ↘ 9.8 ↘ 10.1 ↗
 beste Teiler 45.4 (47.) 58.1 (44.) 85.3 (45.)
 Trefferlage 0.16 mm links, 1.11 mm hoch
 Streuwert 1.21, horizontal: 1.22, vertikal: 1.19

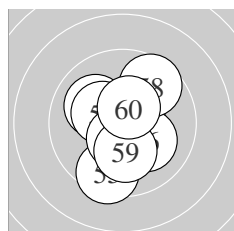

Serie 6:
 10.0 ↖ 10.3 * 10.5 * 10.5 * 9.5 ↓
 10.1 ↘ 10.5 * 9.6 ↗ 10.2 * 10.5 *
 beste Teiler 106.0 (53.) 113.8 (57.) 114.9 (54.)
 Trefferlage 0.08 mm rechts, 0.36 mm tief
 Streuwert 1.57, horizontal: 1.29, vertikal: 1.80

Meyton Elektronik

ISSF AR Women Jun – Wertung –

Juniorinnen

StartNr: 56

StandNr: 108

19. Januar 2019 11:34

Zirfass, Alisa #70811241

BY – SV Riednelke Benningen

Unterschrift des Schützen

Meyton Elektronik

Ergebnis:	603.9	(576)							
Serien:	101.1	101.3	100.2	98.6	100.7	102.0			
Zähler:	36	24	0	0	0	0	0	0	0
Innenzehner:	28								
weiteste:	483 (38), 432 (3), 424 (1)								
beste Teiler	54.2 (13.) 59.3 (36.) 61.2 (24.)								
Trefferlage	0.27 mm links, 0.41 mm hoch								
Streuwert	1.70, horizontal: 1.77, vertikal: 1.62								

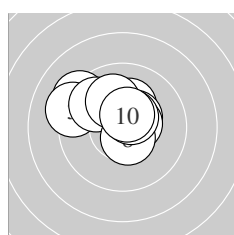
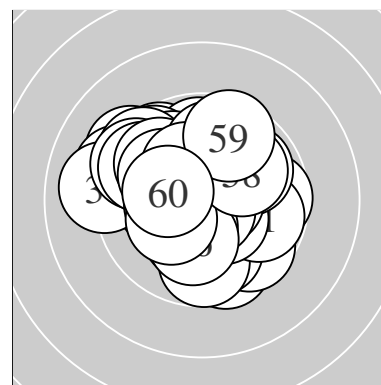

Serie 1:	9.3 ↘	10.2 *	9.2 ↖	9.8 ↘	10.1 ↗
	10.4 *	10.5 *	10.6 *	10.5 *	10.5 *
beste Teiler	96.1 (8.) 106.0 (7.) 107.8 (9.)				
Trefferlage	0.64 mm links, 1.16 mm hoch				
Streuwert	1.52, horizontal: 1.92, vertikal: 0.97				

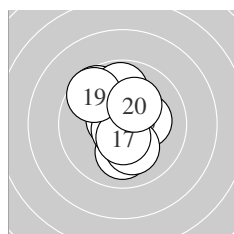

Serie 2:	10.0 ↓	10.6 *	10.7 *	9.6 ↖	10.2 *
	10.1 ↓	10.5 *	9.8 ↑	9.6 ↖	10.2 *
beste Teiler	54.2 (13.) 82.3 (12.) 108.1 (17.)				
Trefferlage	0.20 mm links, 0.42 mm hoch				
Streuwert	1.60, horizontal: 1.29, vertikal: 1.86				

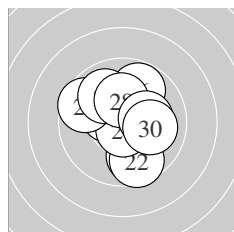

Serie 3:	9.8 ↓	9.6 ↓	10.4 *	10.7 *	9.6 ↖
	9.8 ↗	9.9 ↖	10.2 *	10.2 *	10.0 →
beste Teiler	61.2 (24.) 133.2 (23.) 179.2 (28.)				
Trefferlage	0.17 mm rechts, 0.18 mm hoch				
Streuwert	1.82, horizontal: 1.67, vertikal: 1.95				

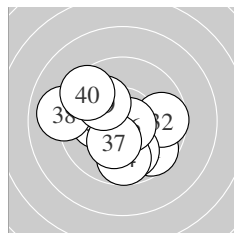

Serie 4:	9.7 ↘	9.7 →	9.9 ↓	9.7 ↓	10.1 ←
	10.7 *	10.2 *	9.0 ←	10.1 ↖	9.5 ↖
beste Teiler	59.3 (36.) 179.2 (37.) 203.0 (35.)				
Trefferlage	0.51 mm links, 0.51 mm tief				
Streuwert	2.11, horizontal: 2.41, vertikal: 1.77				

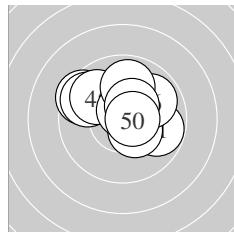

Serie 5:	9.8 →	10.4 *	9.5 ↖	9.6 ↖	9.9 ↖
	9.9 ↗	10.7 *	9.9 ↑	10.4 *	10.6 *
beste Teiler	72.6 (47.) 81.0 (50.) 132.0 (49.)				
Trefferlage	0.00 mm , 0.93 mm hoch				
Streuwert	1.68, horizontal: 2.06, vertikal: 1.17				



Serie 6:	10.7 *	10.0 ↖	10.3 *	10.4 *	10.3 *
	10.2 *	10.2 *	10.0 ↗	9.6 ↑	10.3 *
beste Teiler	63.6 (51.) 144.5 (54.) 160.6 (53.)				
Trefferlage	0.47 mm links, 0.28 mm hoch				
Streuwert	1.45, horizontal: 1.33, vertikal: 1.57				

Meyton Elektronik

ISSF AR Women Jun – Wertung – Juniorinnen

StartNr: 57

StandNr: 109

19. Januar 2019 11:48

Callie, Siah Yong Xin #70811177

SGP

Unterschrift des Schützen

Meyton Elektronik

Ergebnis: **602.3** (575)

Serien: 100.1 101.3 100.0 100.4 101.3 99.2

Zähler: 36 23 1 0 0 0 0 0 0 0

Innenzehner: 27

weiteste: 670 (56), 453 (25), 446 (20)

beste Teiler 36.1 (30.) 46.8 (15.) 77.6 (17.)

Trefferlage 0.35 mm rechts, 0.40 mm hoch

Streuwert 1.79, horizontal: 2.01, vertikal: 1.54

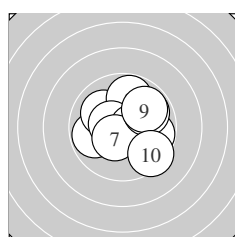
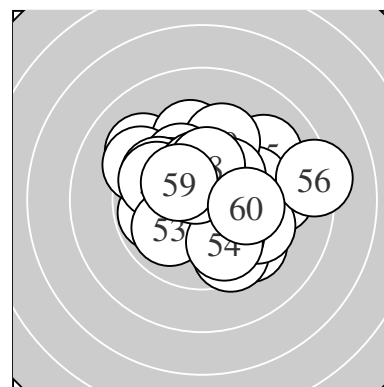

Serie 1:

9.8 ←	10.0 ↘	9.8 ↑	10.5 *	9.8 →
10.6 *	10.4 *	9.9 ↗	9.9 ↗	9.4 ↘

beste Teiler 100.0 (6.) 114.5 (4.) 128.2 (7.)

Trefferlage 0.53 mm rechts, 0.26 mm hoch

Streuwert 1.82, horizontal: 2.02, vertikal: 1.60

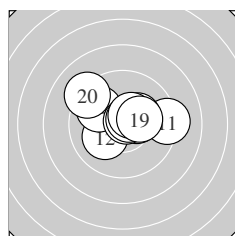

Serie 2:

9.2 →	10.1 ↖	10.4 *	9.9 ↘	10.8 *
10.3 *	10.6 *	10.5 *	10.3 *	9.2 ↘

beste Teiler 46.8 (15.) 77.6 (17.) 118.1 (18.)

Trefferlage 0.31 mm rechts, 0.66 mm hoch

Streuwert 1.75, horizontal: 2.26, vertikal: 1.02

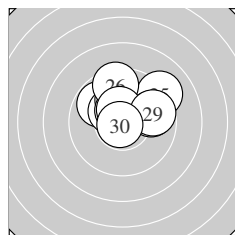

Serie 3:

9.8 ↘	10.3 *	10.1 ↑	10.5 *	9.1 ↗
9.5 ↑	9.8 →	10.4 *	9.7 →	10.8 *

beste Teiler 36.1 (30.) 123.6 (24.) 126.8 (28.)

Trefferlage 0.37 mm rechts, 1.51 mm hoch

Streuwert 1.60, horizontal: 1.98, vertikal: 1.09

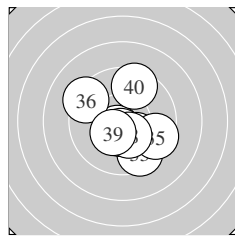

Serie 4:

10.6 *	10.2 *	9.5 ↘	10.5 *	9.5 →
9.3 ↘	10.5 *	10.4 *	10.4 *	9.5 ↑

beste Teiler 88.0 (31.) 102.5 (37.) 123.4 (34.)

Trefferlage 0.24 mm rechts, 0.59 mm tief

Streuwert 1.87, horizontal: 1.83, vertikal: 1.90

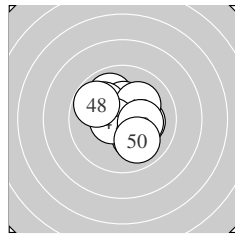

Serie 5:

9.9 ↘	10.4 *	10.0 ↘	10.2 *	10.1 ↗
10.1 ↘	10.6 *	9.8 ↘	10.2 *	10.0 ↘

beste Teiler 99.6 (47.) 143.3 (42.) 177.4 (49.)

Trefferlage 0.11 mm rechts, 0.33 mm hoch

Streuwert 1.56, horizontal: 1.65, vertikal: 1.46

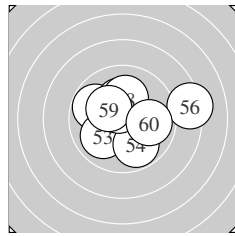

Serie 6:

10.2 *	9.8 ↘	10.0 ↖	9.8 ↘	10.2 *
8.3 →	10.6 *	10.1 ↑	10.3 *	9.9 →

beste Teiler 93.1 (57.) 168.4 (59.) 178.2 (51.)

Trefferlage 0.55 mm rechts, 0.24 mm hoch

Streuwert 2.17, horizontal: 2.65, vertikal: 1.55

Meyton Elektronik

ISSF AR Women Jun – Wertung – Juniorinnen

StandNr: 110

Mautz, Leonie #198

StartNr: 58

19. Januar 2019 11:43

VLSV

Unterschrift des Schützen

Meyton Elektronik

Ergebnis: **617.9** (588)

Serien: 102.9 103.7 103.2 103.7 100.3 104.1

Zähler: 48 12 0 0 0 0 0 0 0 0

Innenzehner: 42

weiteste: 415 (49), 389 (22), 371 (50)

beste Teiler 17.6 (15.) 27.0 (26.) 28.6 (33.)

Trefferlage 0.11 mm links, 0.17 mm hoch

Streuwert 1.35, horizontal: 1.36, vertikal: 1.34

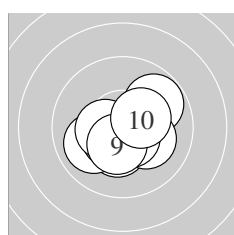
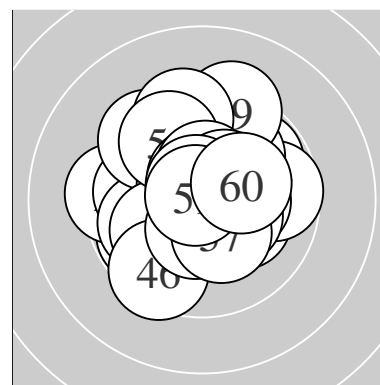

Serie 1:

9.8 ↗	10.4 *	10.3 *	10.2 *	10.6 *
10.0 ↙	10.5 *	10.4 *	10.4 *	10.3 *

beste Teiler 93.8 (5.) 113.1 (7.) 130.2 (8.)

Trefferlage 0.23 mm rechts, 0.46 mm tief

Streuwert 1.24, horizontal: 1.46, vertikal: 0.98

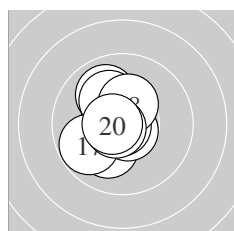

Serie 2:

10.6 *	10.1 ↘	9.9 ↖	10.7 *	10.9 *
10.1 ↖	9.8 ↙	10.3 *	10.7 *	10.6 *

beste Teiler 17.6 (15.) 57.3 (19.) 63.2 (14.)

Trefferlage 0.72 mm links, 0.14 mm hoch

Streuwert 1.11, horizontal: 0.85, vertikal: 1.32

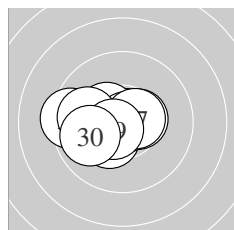

Serie 3:

10.5 *	9.4 ←	10.3 *	10.8 *	10.4 *
10.8 *	10.6 *	9.9 ←	10.6 *	9.9 ↙

beste Teiler 27.0 (26.) 32.0 (24.) 87.0 (29.)

Trefferlage 0.92 mm links, 0.06 mm tief

Streuwert 1.25, horizontal: 1.64, vertikal: 0.63

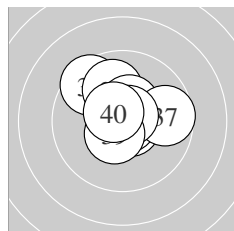

Serie 4:

9.5 ↖	10.0 ↖	10.8 *	10.4 *	10.7 *
10.8 *	9.7 →	10.7 *	10.5 *	10.6 *

beste Teiler 28.6 (33.) 33.2 (36.) 57.9 (38.)

Trefferlage 0.07 mm rechts, 0.64 mm hoch

Streuwert 1.28, horizontal: 1.41, vertikal: 1.14

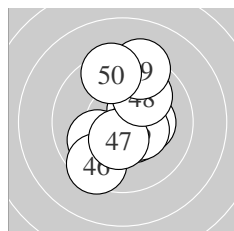

Serie 5:

10.4 *	10.0 ↙	10.5 *	10.3 *	10.4 *
9.5 ↘	10.4 *	10.0 ↗	9.3 ↑	9.5 ↑

beste Teiler 109.6 (43.) 131.2 (47.) 136.4 (45.)

Trefferlage 0.26 mm rechts, 0.32 mm hoch

Streuwert 1.88, horizontal: 1.39, vertikal: 2.27

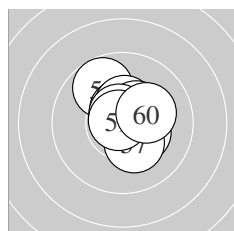

Serie 6:

9.8 ↖	10.6 *	10.4 *	10.4 *	10.3 *
10.6 *	10.3 *	10.7 *	10.8 *	10.2 *

beste Teiler 36.0 (59.) 70.3 (58.) 94.9 (56.)

Trefferlage 0.37 mm rechts, 0.48 mm hoch

Streuwert 1.06, horizontal: 0.97, vertikal: 1.14

Meyton Elektronik

ISSF AR Women Jun – Wertung – Juniorinnen

StartNr: 59

StandNr: 111

19. Januar 2019 11:52

Waibel, Sheileen #188

AUT

Unterschrift des Schützen

Meyton Elektronik

Ergebnis:	620.4	(589)							
Serien:	103.9	102.8	102.8	103.8	103.4	103.7			
Zähler:	49	11	0	0	0	0	0	0	0
Innenzehner:	42								
weiteste:	376 (12), 314 (14), 314 (59)								
beste Teiler	17.8 (51.)	19.1 (36.)	19.6 (16.)						
Trefferlage	0.06 mm rechts, 0.04 mm hoch								
Streuwert	1.26, horizontal: 1.31, vertikal: 1.20								

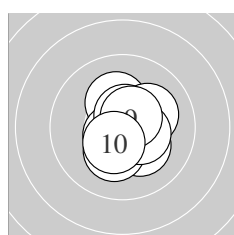

Serie 1:	10.2 *	10.2 *	10.2 *	10.6 *	10.1 ↗
	10.6 *	10.4 *	10.6 *	10.6 *	10.4 *
beste Teiler	84.2 (4.)	86.2 (6.)	86.6 (8.)		
Trefferlage	0.34 mm rechts, 0.13 mm tief				
Streuwert	1.03, horizontal: 0.91, vertikal: 1.13				

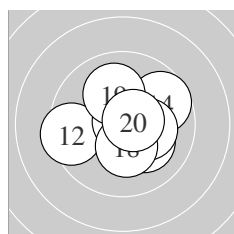

Serie 2:	10.2 *	9.4 ←	10.6 *	9.7 ↗	10.8 *
	10.9 *	10.2 *	10.3 *	10.1 ↑	10.6 *
beste Teiler	19.6 (16.)	46.0 (15.)	80.5 (13.)		
Trefferlage	0.38 mm rechts, 0.02 mm hoch				
Streuwert	1.47, horizontal: 1.72, vertikal: 1.16				

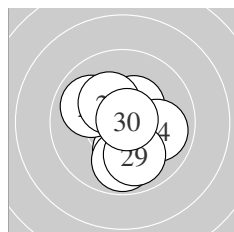

Serie 3:	10.4 *	10.8 *	10.8 *	9.9 →	10.1 ↓
	9.8 ↓	9.9 ↖	10.3 *	10.0 ↓	10.8 *
beste Teiler	36.7 (30.)	45.7 (22.)	47.1 (23.)		
Trefferlage	0.14 mm rechts, 0.37 mm tief				
Streuwert	1.39, horizontal: 1.23, vertikal: 1.52				

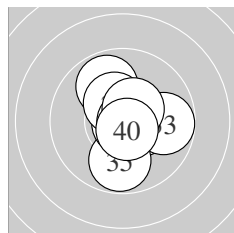

Serie 4:	9.9 ↖	10.4 *	9.8 →	10.6 *	9.8 ↓
	10.9 *	10.4 *	10.8 *	10.5 *	10.7 *
beste Teiler	19.1 (36.)	39.1 (38.)	68.0 (40.)		
Trefferlage	0.36 mm rechts, 0.13 mm hoch				
Streuwert	1.28, horizontal: 1.14, vertikal: 1.41				

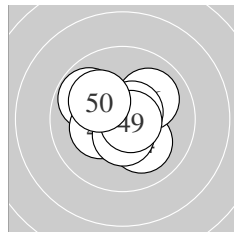

Serie 5:	9.8 ↖	10.3 *	10.6 *	10.1 ↘	10.7 *
	10.0 ↗	10.5 *	10.6 *	10.7 *	10.1 ↖
beste Teiler	61.5 (45.)	61.6 (49.)	84.4 (48.)		
Trefferlage	0.09 mm links, 0.08 mm hoch				
Streuwert	1.27, horizontal: 1.40, vertikal: 1.13				

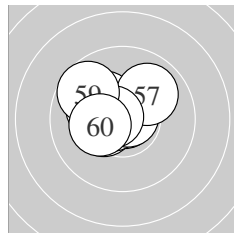

Serie 6:	10.9 *	10.4 *	10.6 *	10.8 *	10.2 *
	10.2 *	9.9 ↗	10.7 *	9.7 ↖	10.3 *
beste Teiler	17.8 (51.)	43.0 (54.)	74.7 (58.)		
Trefferlage	0.78 mm links, 0.51 mm hoch				
Streuwert	1.08, horizontal: 1.25, vertikal: 0.86				

ISSF AR Women Jun – Wertung – Juniorinnen

StandNr: 112

Gabrielli, Nicole #70811242

StartNr: 60

19. Januar 2019 11:03

ITA – Accademia

Unterschrift des Schützen

Meyton Elektronik

Ergebnis: **607.0** (579)
 Serien: 100.5 99.4 101.5 100.9 102.8 101.9
 Zähler: 41 17 2 0 0 0 0 0 0
 Innenzehner: 31
 weiteste: 515 (16), 504 (3), 458 (8)
 beste Teiler 38.9 (60.) 41.3 (14.) 44.0 (34.)
 Trefferlage 0.23 mm links, 0.24 mm hoch
 Streuwert 1.69, horizontal: 1.86, vertikal: 1.49

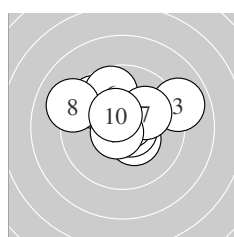
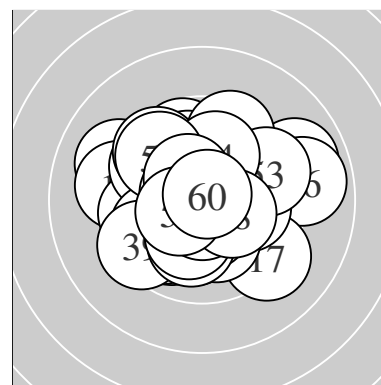

Serie 1:
 10.4 * 10.7 * 8.9 ↗ 10.7 * 9.7 ↘
 9.7 ↖ 10.1 ↗ 9.1 ↖ 10.7 * 10.5 *
 beste Teiler 60.1 (4.) 64.4 (9.) 73.1 (2.)
 Trefferlage 0.00 mm , 0.97 mm hoch
 Streuwert 1.92, horizontal: 2.40, vertikal: 1.26

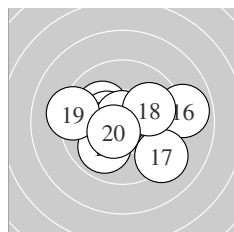

Serie 2:
 10.1 ↘ 10.4 * 10.3 * 10.8 * 9.9 ↙
 8.9 → 9.2 ↘ 10.0 ↗ 9.3 ← 10.5 *
 beste Teiler 41.3 (14.) 110.3 (20.) 137.0 (12.)
 Trefferlage 0.05 mm links, 0.15 mm tief
 Streuwert 2.19, horizontal: 2.77, vertikal: 1.39

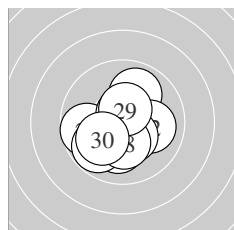

Serie 3:
 9.9 ↗ 10.0 → 9.7 ← 10.1 ↓ 9.8 ↙
 10.7 * 10.4 * 10.3 * 10.5 * 10.1 ↙
 beste Teiler 72.0 (26.) 110.4 (29.) 139.2 (27.)
 Trefferlage 0.27 mm links, 0.53 mm tief
 Streuwert 1.53, horizontal: 1.58, vertikal: 1.47

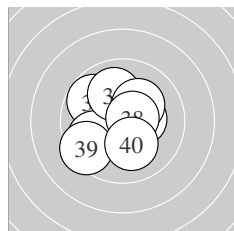

Serie 4:
 9.8 ↘ 9.8 ↘ 10.4 * 10.8 * 9.8 ↙
 10.0 ↖ 10.2 * 10.6 * 9.4 ↙ 10.1 ↓
 beste Teiler 44.0 (34.) 87.2 (38.) 149.9 (33.)
 Trefferlage 0.69 mm links, 0.18 mm hoch
 Streuwert 1.67, horizontal: 1.74, vertikal: 1.61

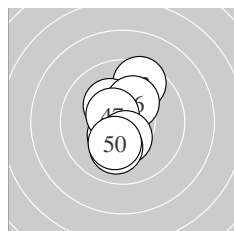

Serie 5:
 10.4 * 10.6 * 9.5 ↗ 10.7 * 10.2 *
 10.2 * 10.5 * 10.4 * 10.1 ↓ 10.2 *
 beste Teiler 57.3 (44.) 91.6 (42.) 105.2 (47.)
 Trefferlage 0.23 mm links, 0.18 mm hoch
 Streuwert 1.35, horizontal: 0.81, vertikal: 1.73

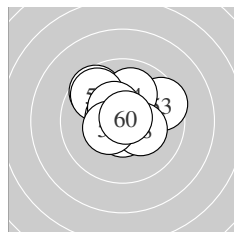

Serie 6:
 10.6 * 9.6 ↘ 9.5 ↗ 10.0 ↗ 9.7 ↘
 10.6 * 10.4 * 10.3 * 10.4 * 10.8 *
 beste Teiler 38.9 (60.) 80.0 (51.) 97.7 (56.)
 Trefferlage 0.14 mm links, 0.80 mm hoch
 Streuwert 1.49, horizontal: 1.68, vertikal: 1.27

Meyton Elektronik

ISSF AR Women Jun – Wertung – Juniorinnen

StandNr: 113

Kocher, Jennifer #70811243

StartNr: 61

19. Januar 2019 11:57

SUI

Unterschrift des Schützen

Meyton Elektronik

Ergebnis: **615.5** (592)

Serien: 102.8 103.8 101.2 101.2 102.0 104.5

Zähler: 53 6 1 0 0 0 0 0 0

Innenzehner: 41

weiteste: 538 (37), 496 (25), 366 (43)

beste Teiler 25.9 (19.) 48.6 (58.) 50.2 (2.)

Trefferlage 0.02 mm links, 0.16 mm tief

Streuwert 1.41, horizontal: 1.64, vertikal: 1.14

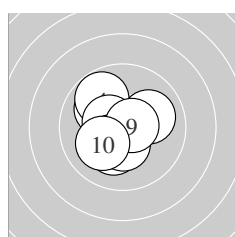
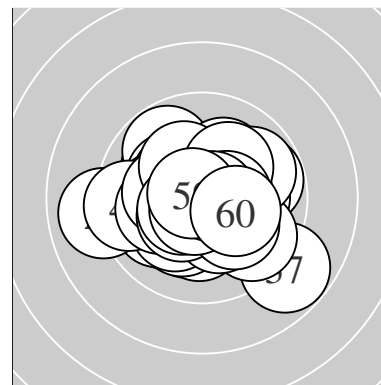

Serie 1:

10.2 *	10.8 *	10.0 ↘	9.8 ↘	10.0 →
10.5 *	10.4 *	10.4 *	10.6 *	10.1 ↙

beste Teiler 50.2 (2.) 78.2 (9.) 118.6 (6.)

Trefferlage 0.52 mm links, 0.00 mm

Streuwert 1.31, horizontal: 1.25, vertikal: 1.37

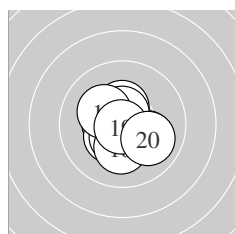

Serie 2:

10.5 *	10.4 *	10.4 *	10.1 ↘	10.6 *
10.5 *	10.2 *	10.2 *	10.9 *	10.0 ↘

beste Teiler 25.9 (19.) 90.0 (15.) 115.2 (11.)

Trefferlage 0.04 mm links, 0.31 mm tief

Streuwert 1.16, horizontal: 1.21, vertikal: 1.12

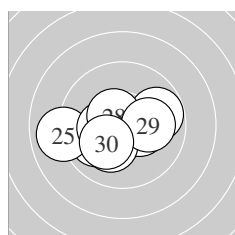

Serie 3:

10.0 ↙	10.7 *	9.8 →	10.4 *	9.0 ←
10.3 *	10.2 *	10.5 *	10.1 →	10.2 *

beste Teiler 75.7 (22.) 105.4 (28.) 146.2 (24.)

Trefferlage 0.54 mm links, 0.46 mm tief

Streuwert 1.71, horizontal: 2.26, vertikal: 0.86

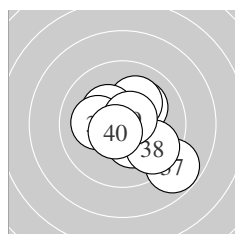

Serie 4:

10.1 ↗	10.1 ↗	10.6 *	10.3 *	10.3 *
10.1 ←	8.8 ↘	9.7 ↘	10.6 *	10.6 *

beste Teiler 77.8 (39.) 88.4 (40.) 91.3 (33.)

Trefferlage 0.60 mm rechts, 0.20 mm tief

Streuwert 1.74, horizontal: 1.84, vertikal: 1.64

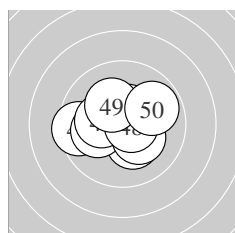

Serie 5:

10.3 *	10.3 *	9.5 ←	10.1 ←	10.3 *
10.2 *	10.5 *	10.7 *	10.2 *	9.9 →

beste Teiler 72.8 (48.) 113.4 (47.) 168.4 (41.)

Trefferlage 0.11 mm links, 0.13 mm hoch

Streuwert 1.53, horizontal: 1.90, vertikal: 1.04

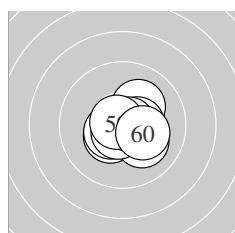

Serie 6:

10.4 *	10.4 *	10.5 *	10.2 *	10.1 ↘
10.7 *	10.5 *	10.8 *	10.7 *	10.2 *

beste Teiler 48.6 (58.) 53.2 (59.) 70.1 (56.)

Trefferlage 0.46 mm rechts, 0.15 mm tief

Streuwert 0.96, horizontal: 1.08, vertikal: 0.83

Meyton Elektronik

ISSF AR Women Jun – Wertung – Juniorinnen

StandNr: 114

Mainetti, Giulia #70811244

StartNr: 62

19. Januar 2019 11:40

ITA – Accademia

Unterschrift des Schützen

Meyton Elektronik

Ergebnis:	618.9	(588)						
Serien:	101.1	103.0	102.9	105.4	103.4	103.1		
Zähler:	48	12	0	0	0	0	0	0
Innenzehner:	42							
weiteste:	432 (13), 402 (51), 363 (2)							
beste Teiler	20.0 (33.)	25.0 (32.)	33.3 (56.)					
Trefferlage	0.08 mm links, 0.28 mm hoch							
Streuwert	1.34, horizontal: 1.45, vertikal: 1.21							

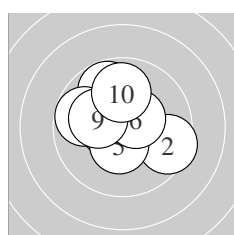
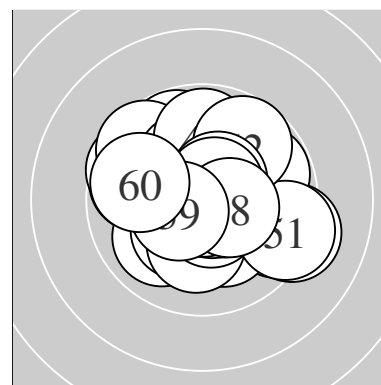

Serie 1:	10.1 ↑	9.5 →	10.3 *	10.6 *	10.4 *
	10.5 *	9.8 ↖	9.8 ←	10.2 *	9.9 ↑
beste Teiler	96.0 (4.) 118.7 (6.) 130.6 (5.)				
Trefferlage	0.46 mm links, 0.80 mm hoch				
Streuwert	1.58, horizontal: 1.72, vertikal: 1.44				

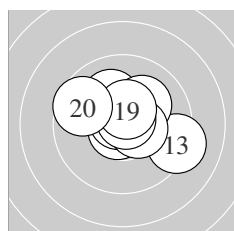

Serie 2:	10.1 ↖	10.7 *	9.2 →	10.1 ↗	10.7 *
	10.8 *	10.5 *	10.8 *	10.5 *	9.6 ↖
beste Teiler	43.6 (18.) 45.2 (16.) 53.1 (12.)				
Trefferlage	0.26 mm rechts, 0.47 mm hoch				
Streuwert	1.47, horizontal: 1.82, vertikal: 1.02				

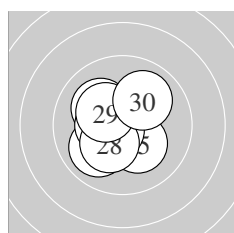

Serie 3:	10.6 *	10.1 ↖	10.3 *	10.0 ↙	10.2 *
	10.7 *	10.4 *	10.3 *	10.3 *	10.0 ↗
beste Teiler	72.4 (26.) 95.7 (21.) 137.0 (27.)				
Trefferlage	0.60 mm links, 0.10 mm tief				
Streuwert	1.23, horizontal: 1.16, vertikal: 1.30				

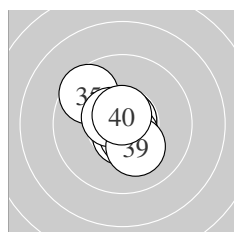

Serie 4:	10.6 *	10.9 *	10.9 *	10.8 *	9.6 ↖
	10.6 *	10.6 *	10.5 *	10.2 *	10.7 *
beste Teiler	20.0 (33.) 25.0 (32.) 42.0 (34.)				
Trefferlage	0.24 mm links, 0.06 mm hoch				
Streuwert	1.02, horizontal: 0.97, vertikal: 1.07				

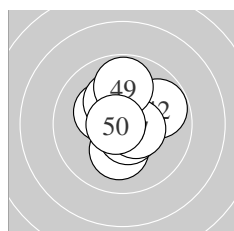

Serie 5:	10.7 *	9.8 →	10.6 *	10.2 *	10.3 *
	10.6 *	10.5 *	10.2 *	9.8 ↑	10.7 *
beste Teiler	52.1 (50.) 61.6 (41.) 91.6 (46.)				
Trefferlage	0.11 mm rechts, 0.30 mm hoch				
Streuwert	1.27, horizontal: 1.11, vertikal: 1.41				

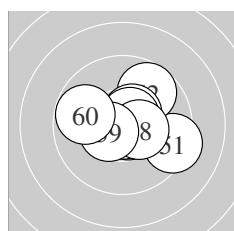

Serie 6:	9.3 →	9.7 ↗	10.8 *	10.5 *	10.7 *
	10.8 *	10.6 *	10.4 *	10.5 *	9.8 ↖
beste Teiler	33.3 (56.) 34.2 (53.) 59.5 (55.)				
Trefferlage	0.44 mm rechts, 0.18 mm hoch				
Streuwert	1.44, horizontal: 1.74, vertikal: 1.05				

ISSF AR Women Jun – Wertung – Juniorinnen

StandNr: 115

Michalkova, Katerina #70811245

StartNr: 63

19. Januar 2019 11:45

CZE

Unterschrift des Schützen

Meyton Elektronik

Ergebnis: **623.3** (594)^{QF}

Serien: 103.2 105.6 102.0 104.9 104.8 102.8

Zähler: 54 6 0 0 0 0 0 0 0 0

Innenzehner: 47

weiteste: 350 (51), 278 (30), 275 (29)

beste Teiler 33.0 (14.) 36.3 (36.) 46.8 (24.)

Trefferlage 0.12 mm rechts, 0.23 mm tief

Streuwert 1.10, horizontal: 1.22, vertikal: 0.96

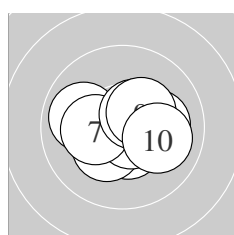
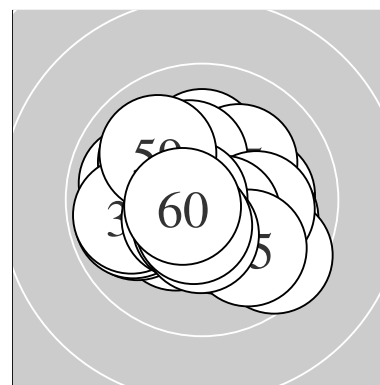

Serie 1:

10.6 *	10.5 *	9.9 ↖	10.3 *	10.1 →
10.7 *	10.3 *	10.5 *	10.3 *	10.0 →

beste Teiler 69.0 (6.) 86.8 (1.) 111.1 (8.)

Trefferlage 0.26 mm rechts, 0.14 mm tief

Streuwert 1.23, horizontal: 1.56, vertikal: 0.77

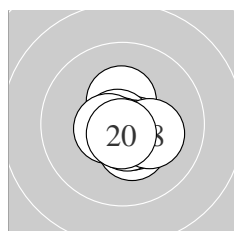

Serie 2:

10.4 *	10.4 *	10.6 *	10.8 *	10.6 *
10.6 *	10.7 *	10.2 *	10.6 *	10.7 *

beste Teiler 33.0 (14.) 56.3 (17.) 62.5 (20.)

Trefferlage 0.24 mm rechts, 0.38 mm tief

Streuwert 0.74, horizontal: 0.73, vertikal: 0.75

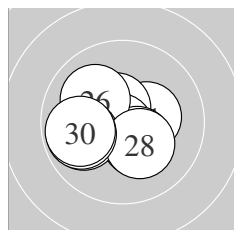

Serie 3:

10.3 *	10.3 *	10.5 *	10.8 *	10.3 *
10.0 ↘	9.9 ↖	10.2 *	9.9 ↖	9.8 ↖

beste Teiler 46.8 (24.) 101.9 (23.) 152.7 (22.)

Trefferlage 0.82 mm links, 0.20 mm tief

Streuwert 1.33, horizontal: 1.62, vertikal: 0.95

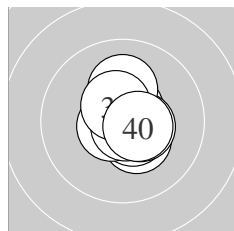

Serie 4:

10.4 *	10.3 *	10.6 *	10.6 *	10.6 *
10.8 *	10.5 *	10.1 ↑	10.5 *	10.5 *

beste Teiler 36.3 (36.) 77.3 (34.) 83.6 (35.)

Trefferlage 0.31 mm rechts, 0.22 mm hoch

Streuwert 0.85, horizontal: 0.61, vertikal: 1.04

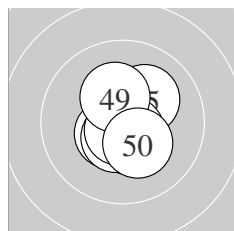

Serie 5:

10.6 *	10.6 *	10.5 *	10.5 *	10.1 ↗
10.5 *	10.7 *	10.7 *	10.3 *	10.3 *

beste Teiler 57.0 (48.) 75.2 (47.) 79.0 (41.)

Trefferlage 0.19 mm rechts, 0.24 mm tief

Streuwert 0.91, horizontal: 0.70, vertikal: 1.09

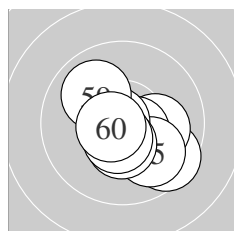

Serie 6:

9.6 ↘	10.3 *	10.1 →	10.6 *	9.9 ↘
10.8 *	10.4 *	10.5 *	10.0 ↘	10.6 *

beste Teiler 50.4 (56.) 79.0 (60.) 94.0 (54.)

Trefferlage 0.54 mm rechts, 0.64 mm tief

Streuwert 1.28, horizontal: 1.43, vertikal: 1.10

Meyton Elektronik

ISSF AR Women Jun – Wertung – Juniorinnen

StartNr: 64

StandNr: 116

19. Januar 2019 11:53

Emily, Stith #70811246

USA

QF – Schütze hat sich fürs Finale qualifiziert

Unterschrift des Schützen

Meyton Elektronik

Ergebnis:	622.9	(590)					
Serien:	103.5	104.4	102.0	104.2	104.5	104.3	
Zähler:	50	10	0	0	0	0	0
Innenzehner:	49						
weiteste:	384 (30), 357 (21), 320 (54)						
beste Teiler	7.0 (59.) 13.6 (58.) 18.0 (26.)						
Trefferlage	0.11 mm links, 0.09 mm tief						
Streuwert	1.20, horizontal: 1.49, vertikal: 0.82						

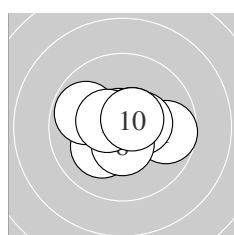
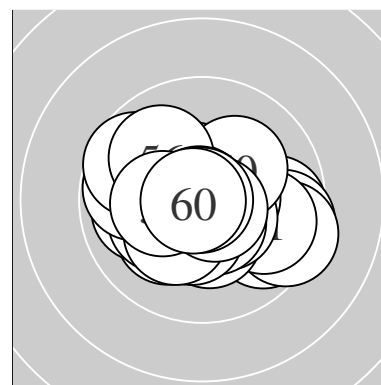

Serie 1:					
9.7 →	10.7 *	10.5 *	10.2 *	9.8 ↖	
10.6 *	10.4 *	10.5 *	10.5 *	10.6 *	
beste Teiler	57.2 (2.) 87.2 (6.) 88.0 (10.)				
Trefferlage	0.08 mm links, 0.07 mm hoch				
Streuwert	1.27, horizontal: 1.62, vertikal: 0.79				

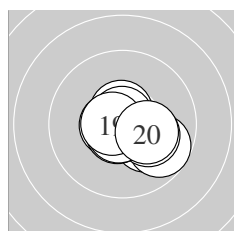

Serie 2:					
10.6 *	10.2 *	10.8 *	10.6 *	9.7 ↘	
10.2 *	10.7 *	10.7 *	10.7 *	10.2 *	
beste Teiler	44.2 (13.) 58.6 (18.) 67.6 (17.)				
Trefferlage	0.54 mm rechts, 0.38 mm tief				
Streuwert	1.03, horizontal: 1.26, vertikal: 0.72				

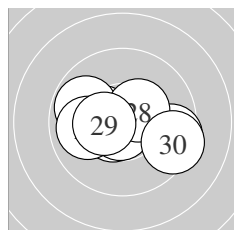

Serie 3:					
9.5 →	10.4 *	9.8 ↖	10.6 *	9.9 ←	
10.9 *	10.7 *	10.4 *	10.4 *	9.4 →	
beste Teiler	18.0 (26.) 51.2 (27.) 90.0 (24.)				
Trefferlage	0.05 mm links, 0.19 mm tief				
Streuwert	1.64, horizontal: 2.19, vertikal: 0.77				

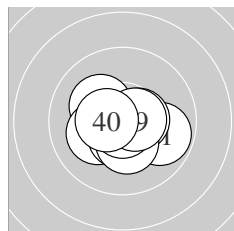

Serie 4:					
9.8 →	10.2 *	10.2 *	10.5 *	10.8 *	
10.5 *	10.3 *	10.8 *	10.6 *	10.5 *	
beste Teiler	40.0 (38.) 45.3 (35.) 88.5 (39.)				
Trefferlage	0.06 mm rechts, 0.35 mm tief				
Streuwert	1.09, horizontal: 1.34, vertikal: 0.75				

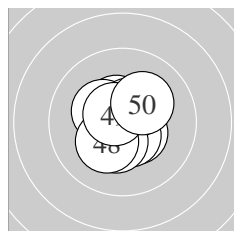

Serie 5:					
10.5 *	10.7 *	10.5 *	10.5 *	10.3 *	
10.6 *	10.4 *	10.2 *	10.6 *	10.2 *	
beste Teiler	74.4 (42.) 80.6 (49.) 100.1 (46.)				
Trefferlage	0.08 mm links, 0.05 mm tief				
Streuwert	0.99, horizontal: 0.90, vertikal: 1.08				

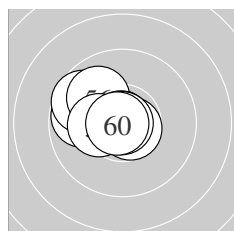

Serie 6:					
10.4 *	10.7 *	9.8 ←	9.7 ↖	10.8 *	
10.0 ↘	10.3 *	10.9 *	10.9 *	10.8 *	
beste Teiler	7.0 (59.) 13.6 (58.) 30.4 (55.)				
Trefferlage	1.07 mm links, 0.33 mm hoch				
Streuwert	0.99, horizontal: 1.19, vertikal: 0.73				

ISSF AR Women Jun – Wertung – Juniorinnen

StandNr: 117

Potutkina, Anna #70811247

StartNr: 65

19. Januar 2019 11:42

RUS

Unterschrift des Schützen

Meyton Elektronik

Ergebnis:	614.5	(586)
Serien:	99.2	102.1 103.1 103.5 102.1 104.5
Zähler:	46	14 0 0 0 0 0 0 0 0
Innenzehner:	38	
weiteste:	499 (4), 433 (28), 426 (48)	
beste Teiler	33.9 (26.)	38.0 (23.) 49.3 (57.)
Trefferlage	0.17 mm links, 0.37 mm hoch	
Streuwert	1.45, horizontal: 1.46, vertikal: 1.45	

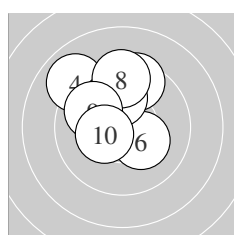
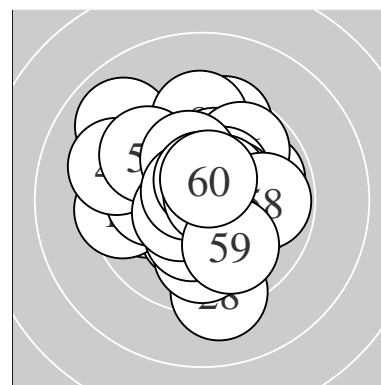

Serie 1:	10.6 *	9.9 ↘	9.5 ↑	9.0 ↘	10.1 ↘
	10.3 *	10.0 ↑	9.5 ↑	9.9 ↘	10.4 *
beste Teiler	81.4 (1.) 150.0 (10.) 174.8 (6.)				
Trefferlage	0.87 mm links, 1.70 mm hoch				
Streuwert	1.59, horizontal: 1.51, vertikal: 1.66				

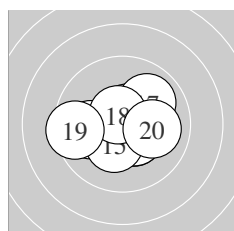

Serie 2:	10.4 *	9.9 ←	10.4 *	10.4 *	10.3 *
	10.6 *	10.0 ↗	10.6 *	9.5 ←	10.0 →
beste Teiler	80.4 (18.) 94.4 (16.) 133.0 (14.)				
Trefferlage	0.15 mm links, 0.27 mm tief				
Streuwert	1.50, horizontal: 1.85, vertikal: 1.03				

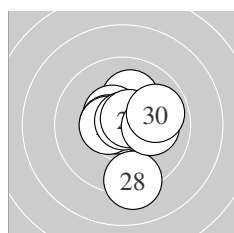

Serie 3:	10.1 ↑	10.5 *	10.8 *	10.5 *	10.5 *
	10.8 *	10.7 *	9.2 ↓	10.1 →	9.9 →
beste Teiler	33.9 (26.) 38.0 (23.) 72.8 (27.)				
Trefferlage	0.33 mm rechts, 0.03 mm hoch				
Streuwert	1.46, horizontal: 1.26, vertikal: 1.64				

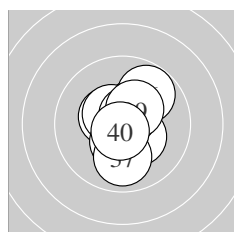

Serie 4:	10.4 *	10.4 *	10.5 *	10.4 *	10.4 *
	9.8 ↗	9.9 ↓	10.6 *	10.4 *	10.7 *
beste Teiler	57.2 (40.) 76.3 (38.) 118.1 (33.)				
Trefferlage	0.26 mm rechts, 0.12 mm hoch				
Streuwert	1.22, horizontal: 0.94, vertikal: 1.44				

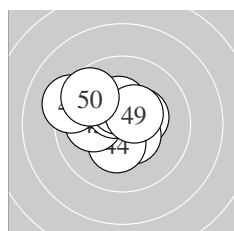

Serie 5:	10.7 *	10.4 *	10.5 *	10.3 *	10.1 ←
	10.4 *	10.4 *	9.2 ↘	10.5 *	9.6 ↘
beste Teiler	72.3 (41.) 112.1 (43.) 118.3 (49.)				
Trefferlage	0.78 mm links, 0.51 mm hoch				
Streuwert	1.43, horizontal: 1.67, vertikal: 1.13				

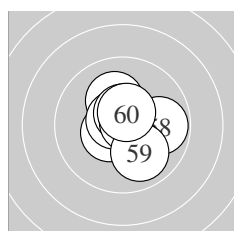

Serie 6:	10.2 *	10.7 *	10.7 *	10.5 *	10.7 *
	10.6 *	10.8 *	9.8 →	10.0 ↓	10.5 *
beste Teiler	49.3 (57.) 65.1 (52.) 70.1 (55.)				
Trefferlage	0.17 mm rechts, 0.15 mm hoch				
Streuwert	1.11, horizontal: 1.15, vertikal: 1.08				

Meyton Elektronik

ISSF AR Women Jun – Wertung – Juniorinnen

StandNr: 118

Stark, Franziska #70811192

StartNr: 66

19. Januar 2019 11:40

SUI

Unterschrift des Schützen

Meyton Elektronik

Ergebnis: **591.6** (567)
 Serien: 100.5 95.7 97.3 100.7 98.1 99.3
 Zähler: 28 31 1 0 0 0 0 0 0
 Innenzehner: 22
 weiteste: 599 (43), 498 (20), 477 (21)
 beste Teiler 39.2 (46.) 56.1 (8.) 93.6 (41.)
 Trefferlage 0.09 mm rechts, 0.02 mm hoch
 Streuwert 2.14, horizontal: 2.52, vertikal: 1.68

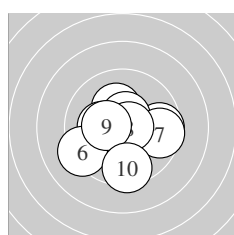
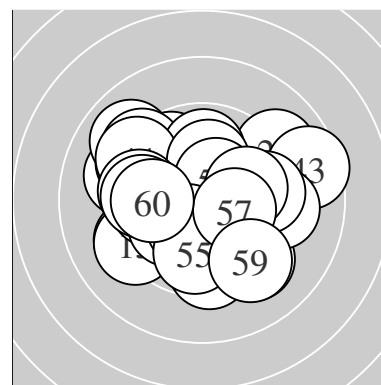

Serie 1:
 9.6 → 10.2 * 10.2 * 10.6 * 10.4 *
 9.3 ↙ 9.6 → 10.7 * 10.4 * 9.5 ↓
 beste Teiler 56.1 (8.) 99.4 (4.) 131.7 (5.)
 Trefferlage 0.01 mm rechts, 0.47 mm tief
 Streuwert 1.88, horizontal: 2.16, vertikal: 1.56

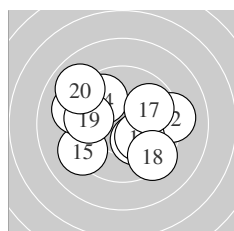

Serie 2:
 10.2 * 9.2 → 10.2 * 9.8 ↘ 9.2 ↙
 9.2 ↖ 9.8 ↗ 9.4 ↘ 9.7 ← 9.0 ↘
 beste Teiler 183.0 (11.) 189.6 (13.) 277.4 (17.)
 Trefferlage 0.43 mm links, 0.15 mm hoch
 Streuwert 2.66, horizontal: 3.18, vertikal: 2.01

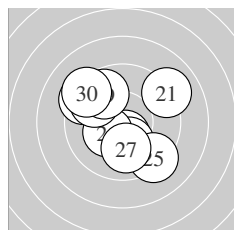

Serie 3:
 9.0 ↗ 9.3 ↖ 10.5 * 10.2 * 9.3 ↘
 10.3 * 10.0 ↓ 9.7 ↖ 9.7 ↘ 9.3 ↖
 beste Teiler 119.2 (23.) 162.2 (26.) 188.4 (24.)
 Trefferlage 0.44 mm links, 0.22 mm hoch
 Streuwert 2.41, horizontal: 2.49, vertikal: 2.33

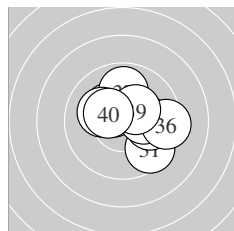

Serie 4:
 9.6 ↘ 10.3 * 10.5 * 10.0 → 10.2 *
 9.4 → 9.9 ↑ 10.1 ↖ 10.3 * 10.4 *
 beste Teiler 116.0 (33.) 147.2 (40.) 156.6 (39.)
 Trefferlage 0.68 mm rechts, 0.42 mm hoch
 Streuwert 1.69, horizontal: 1.99, vertikal: 1.33

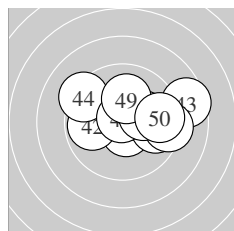

Serie 5:
 10.6 * 9.9 ← 8.6 → 9.3 ↖ 9.7 →
 10.8 * 9.3 → 10.2 * 10.1 ↑ 9.6 →
 beste Teiler 39.2 (46.) 93.6 (41.) 195.7 (48.)
 Trefferlage 1.23 mm rechts, 0.52 mm hoch
 Streuwert 2.24, horizontal: 2.95, vertikal: 1.14

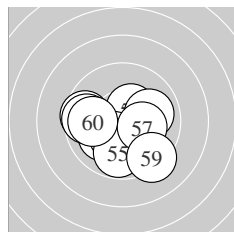

Serie 6:
 10.1 ↙ 10.4 * 10.0 → 10.3 * 9.8 ↓
 9.6 ← 10.2 * 9.7 ← 9.3 ↘ 9.9 ←
 beste Teiler 133.9 (52.) 159.3 (54.) 183.8 (57.)
 Trefferlage 0.47 mm links, 0.70 mm tief
 Streuwert 1.93, horizontal: 2.29, vertikal: 1.49

ISSF AR Women Jun – Wertung – Juniorinnen

StandNr: 119

Vanoni, Lorena #195

StartNr: 67

19. Januar 2019 11:41

VLSV

Unterschrift des Schützen

Meyton Elektronik

Ergebnis: **612.1** (587)
 Serien: 102.3 101.8 102.5 99.5 103.8 102.2
 Zähler: 47 13 0 0 0 0 0 0 0
 Innenzehner: 37
 weiteste: 476 (40), 431 (30), 414 (53)
 beste Teiler 30.0 (26.) 36.3 (16.) 39.8 (1.)
 Trefferlage 0.12 mm links, 0.53 mm tief
 Streuwert 1.46, horizontal: 1.62, vertikal: 1.28

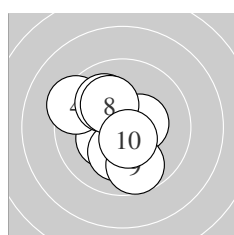
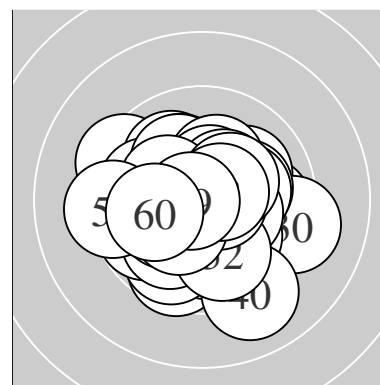

Serie 1:
 10.8 * 10.7 * 10.3 * 9.4 ↖ 10.0 ↗
 10.4 * 10.2 * 10.2 * 9.7 ↓ 10.6 *
 beste Teiler 39.8 (1.) 65.8 (2.) 99.3 (10.)
 Trefferlage 0.52 mm links, 0.16 mm tief
 Streuwert 1.51, horizontal: 1.42, vertikal: 1.60

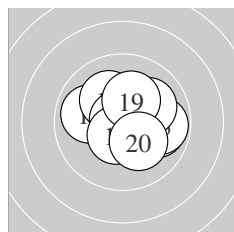

Serie 2:
 10.3 * 9.9 ← 10.1 ↖ 9.9 → 9.8 →
 10.8 * 10.1 ↗ 10.5 * 10.2 * 10.2 *
 beste Teiler 36.3 (16.) 110.0 (18.) 170.8 (11.)
 Trefferlage 0.32 mm rechts, 0.29 mm hoch
 Streuwert 1.49, horizontal: 1.80, vertikal: 1.09

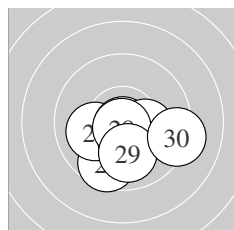

Serie 3:
 10.7 * 10.7 * 9.6 ↓ 10.1 ← 10.4 *
 10.8 * 10.2 * 10.8 * 10.0 ↓ 9.2 →
 beste Teiler 30.0 (26.) 43.4 (28.) 70.2 (22.)
 Trefferlage 0.31 mm rechts, 1.13 mm tief
 Streuwert 1.36, horizontal: 1.69, vertikal: 0.93

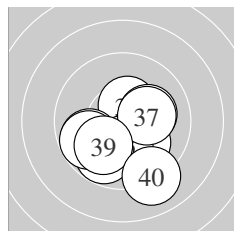

Serie 4:
 10.1 ↘ 10.5 * 10.2 * 9.8 ↓ 9.8 ↖
 10.1 → 10.2 * 9.8 ↖ 10.0 ↗ 9.0 ↓
 beste Teiler 125.5 (32.) 182.2 (33.) 190.4 (37.)
 Trefferlage 0.01 mm links, 1.27 mm tief
 Streuwert 1.75, horizontal: 1.88, vertikal: 1.62

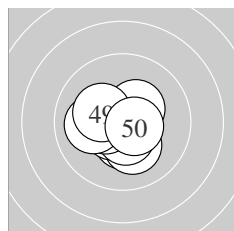

Serie 5:
 10.4 * 10.4 * 10.2 * 10.5 * 10.5 *
 10.4 * 10.4 * 10.1 ← 10.3 * 10.6 *
 beste Teiler 95.8 (50.) 101.9 (44.) 109.8 (45.)
 Trefferlage 0.42 mm links, 0.41 mm tief
 Streuwert 1.03, horizontal: 1.17, vertikal: 0.87

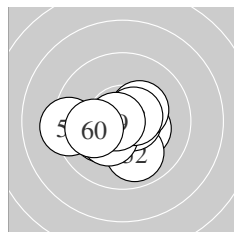

Serie 6:
 10.3 * 9.9 ↓ 9.3 ← 10.2 * 10.6 *
 10.3 * 10.3 * 10.6 * 10.7 * 10.0 ←
 beste Teiler 51.2 (59.) 76.1 (55.) 91.3 (58.)
 Trefferlage 0.41 mm links, 0.50 mm tief
 Streuwert 1.44, horizontal: 1.83, vertikal: 0.90

Meyton Elektronik

ISSF AR Women Jun – Wertung – Juniorinnen

StandNr: 120

Razimova, Tereza #196

StartNr: 68

19. Januar 2019 11:35

CZE

Unterschrift des Schützen

Meyton Elektronik

Ergebnis: **616.9** (591)
 Serien: 103.8 105.6 101.5 104.2 100.1 101.7
 Zähler: 51 9 0 0 0 0 0 0 0
 Innenzehner: 41
 weiteste: 460 (47), 341 (49), 313 (41)
 beste Teiler 23.5 (17.) 29.0 (35.) 48.8 (5.)
 Trefferlage 0.06 mm rechts, 0.14 mm hoch
 Streuwert 1.36, horizontal: 1.56, vertikal: 1.12

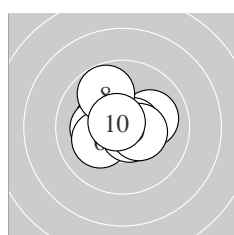
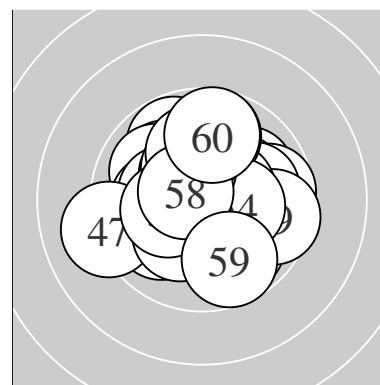

Serie 1:
 10.3 * 10.1 → 10.2 * 10.6 * 10.8 *
 10.2 * 10.7 * 9.8 ↘ 10.4 * 10.7 *
 beste Teiler 48.8 (5.) 61.0 (10.) 72.8 (7.)
 Trefferlage 0.26 mm links, 0.25 mm hoch
 Streuwert 1.20, horizontal: 1.39, vertikal: 0.96

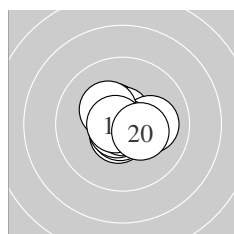

Serie 2:
 10.5 * 10.7 * 10.6 * 10.1 → 10.7 *
 10.7 * 10.9 * 10.3 * 10.7 * 10.4 *
 beste Teiler 23.5 (17.) 57.0 (19.) 57.3 (16.)
 Trefferlage 0.01 mm rechts, 0.01 mm hoch
 Streuwert 0.86, horizontal: 1.01, vertikal: 0.69

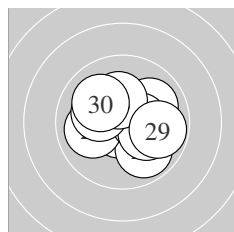

Serie 3:
 10.0 ↗ 10.7 * 9.9 ↘ 10.0 ← 10.4 *
 10.2 * 10.2 * 10.3 * 9.8 → 10.0 ↘
 beste Teiler 63.0 (22.) 132.0 (25.) 173.7 (28.)
 Trefferlage 0.32 mm rechts, 0.06 mm hoch
 Streuwert 1.56, horizontal: 1.85, vertikal: 1.21

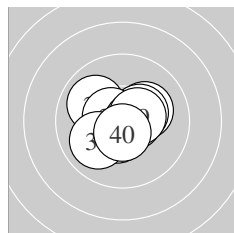

Serie 4:
 10.2 * 10.5 * 10.0 ↖ 10.4 * 10.8 *
 10.6 * 10.6 * 10.0 ↗ 10.5 * 10.6 *
 beste Teiler 29.0 (35.) 82.0 (37.) 90.0 (40.)
 Trefferlage 0.06 mm links, 0.00 mm
 Streuwert 1.14, horizontal: 1.34, vertikal: 0.90

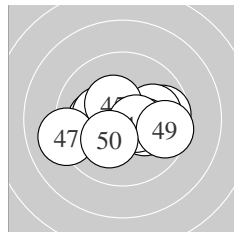

Serie 5:
 9.7 → 10.1 ← 10.0 → 10.3 * 10.4 *
 10.2 * 9.1 ← 10.5 * 9.6 → 10.2 *
 beste Teiler 111.0 (48.) 139.6 (45.) 173.9 (44.)
 Trefferlage 0.16 mm rechts, 0.24 mm tief
 Streuwert 1.90, horizontal: 2.54, vertikal: 0.88

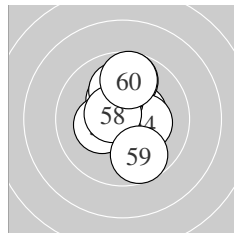

Serie 6:
 10.4 * 9.7 ↑ 10.6 * 10.3 * 10.3 *
 10.1 ↑ 10.3 * 10.6 * 9.7 ↓ 9.7 ↑
 beste Teiler 79.2 (53.) 86.7 (58.) 130.1 (51.)
 Trefferlage 0.18 mm rechts, 0.78 mm hoch
 Streuwert 1.45, horizontal: 1.04, vertikal: 1.77

Meyton Elektronik

ISSF AR Women Jun – Wertung – Juniorinnen

StartNr: 69

StandNr: 121

19. Januar 2019 11:43

Hafner, Lisa #125

AUT

Unterschrift des Schützen

Meyton Elektronik

Ergebnis:	599.1	(568)							
Serien:	99.0	98.0	99.8	101.4	100.1	100.8			
Zähler:	31	26	3	0	0	0	0	0	0
Innenzehner:	27								
weiteste:	552 (57), 524 (11), 506 (6)								
beste Teiler	19.9 (52.) 39.0 (36.) 50.9 (42.)								
Trefferlage	0.32 mm links, 0.05 mm tief								
Streuwert	1.94, horizontal: 2.08, vertikal: 1.78								

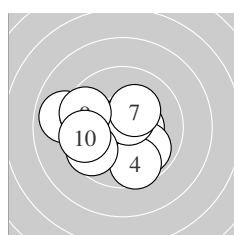
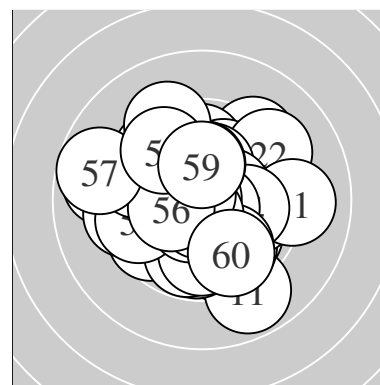

Serie 1:	10.6 *	10.4 *	9.9 ↘	9.6 ↘	10.6 *
	8.9 ←	10.2 *	9.6 ↗	9.6 ↖	9.6 ←
beste Teiler	87.0 (5.) 93.4 (1.) 136.0 (2.)				
Trefferlage	0.80 mm links, 0.43 mm tief				
Streuwert	2.05, horizontal: 2.47, vertikal: 1.53				

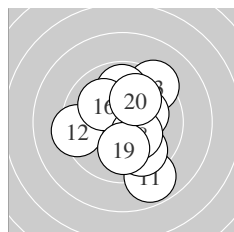

Serie 2:	8.9 ↘	9.4 ←	9.3 ↗	9.9 ↑	10.2 *
	10.1 ↖	9.8 ↘	10.3 *	10.0 ↓	10.1 ↗
beste Teiler	158.9 (18.) 190.1 (15.) 222.8 (16.)				
Trefferlage	0.52 mm rechts, 0.11 mm tief				
Streuwert	2.29, horizontal: 2.01, vertikal: 2.55				

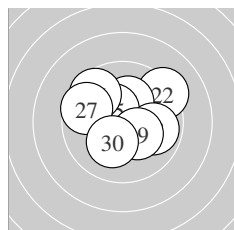

Serie 3:	9.8 ↖	9.3 ↗	10.5 *	10.2 *	10.4 *
	9.6 ↖	9.6 ←	9.9 →	10.3 *	10.2 *
beste Teiler	107.6 (23.) 134.4 (25.) 162.2 (29.)				
Trefferlage	0.10 mm links, 0.65 mm hoch				
Streuwert	1.90, horizontal: 2.18, vertikal: 1.56				

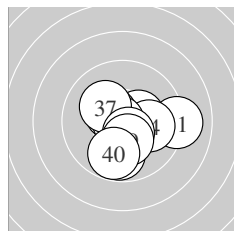

Serie 4:	9.1 →	9.8 ↓	10.4 *	10.0 →	10.5 *
	10.8 *	10.2 *	10.5 *	10.3 *	9.8 ↓
beste Teiler	39.0 (36.) 116.2 (38.) 118.4 (35.)				
Trefferlage	0.53 mm rechts, 0.65 mm tief				
Streuwert	1.64, horizontal: 1.85, vertikal: 1.41				

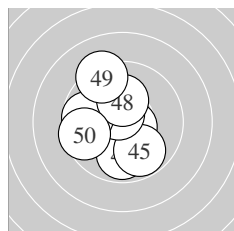

Serie 5:	9.7 ←	10.8 *	10.6 *	9.9 ↓	9.8 ↘
	10.6 *	9.7 ←	10.2 *	9.2 ↖	9.6 ←
beste Teiler	50.9 (42.) 77.3 (46.) 85.0 (43.)				
Trefferlage	0.89 mm links, 0.03 mm tief				
Streuwert	1.85, horizontal: 1.75, vertikal: 1.95				

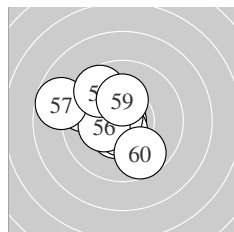

Serie 6:	10.5 *	10.9 *	10.6 *	9.5 ↖	10.7 *
	10.3 *	8.7 ←	9.7 ↘	10.2 *	9.7 ↘
beste Teiler	19.9 (52.) 57.8 (55.) 81.4 (53.)				
Trefferlage	1.20 mm links, 0.25 mm hoch				
Streuwert	1.78, horizontal: 1.95, vertikal: 1.59				

Meyton Elektronik

ISSF AR Women Jun – Wertung – Juniorinnen

StartNr: 70

StandNr: 122

19. Januar 2019 11:19

Ariana, Beh Yoke Ching #70811194

SGP

Unterschrift des Schützen

Meyton Elektronik

Ergebnis:	620.6	(594)						
Serien:	102.8	103.0	103.1	104.1	102.2	105.4		
Zähler:	54	6	0	0	0	0	0	0
Innenzehner:	42							
weiteste:	343 (1), 340 (12), 329 (45)							
beste Teiler	15.5 (3.) 35.2 (15.) 38.6 (13.)							
Trefferlage	0.28 mm rechts, 0.35 mm hoch							
Streuwert	1.18, horizontal: 1.27, vertikal: 1.07							

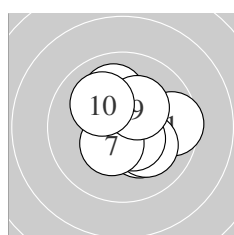
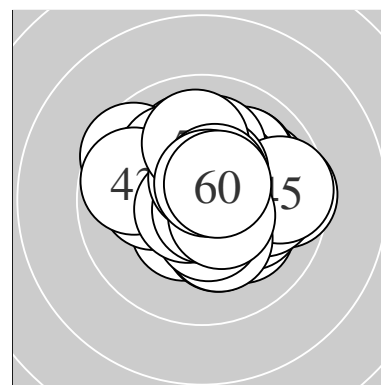

Serie 1:	9.6 →	10.6 *	10.9 *	10.3 *	10.1 ↘
	10.5 *	10.4 *	10.0 ↑	10.3 *	10.1 ↗
beste Teiler	15.5 (3.) 90.1 (2.) 110.3 (6.)				
Trefferlage	0.50 mm rechts, 0.01 mm hoch				
Streuwert	1.36, horizontal: 1.41, vertikal: 1.30				

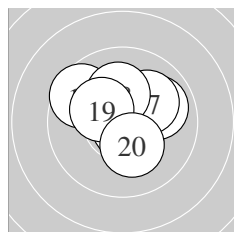

Serie 2:	10.4 *	9.6 ↖	10.8 *	10.6 *	10.8 *
	9.9 →	10.1 ↗	10.2 *	10.3 *	10.3 *
beste Teiler	35.2 (15.) 38.6 (13.) 90.5 (14.)				
Trefferlage	0.18 mm rechts, 0.31 mm hoch				
Streuwert	1.39, horizontal: 1.49, vertikal: 1.27				

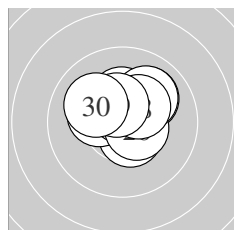

Serie 3:	10.5 *	10.0 ↗	10.3 *	10.3 *	10.6 *
	10.5 *	10.0 ↗	10.3 *	10.5 *	10.1 ↖
beste Teiler	79.9 (25.) 104.9 (21.) 106.6 (26.)				
Trefferlage	0.18 mm rechts, 0.83 mm hoch				
Streuwert	1.08, horizontal: 1.25, vertikal: 0.88				

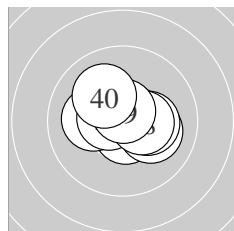

Serie 4:	10.6 *	10.5 *	10.1 ←	10.7 *	10.1 →
	10.6 *	10.3 *	10.4 *	10.7 *	10.1 ↘
beste Teiler	55.8 (34.) 69.2 (39.) 80.0 (31.)				
Trefferlage	0.06 mm rechts, 0.20 mm hoch				
Streuwert	1.08, horizontal: 1.35, vertikal: 0.73				

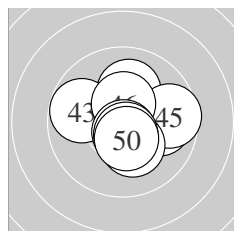

Serie 5:	10.3 *	10.1 ↑	9.8 ↖	9.9 →	9.6 →
	10.4 *	10.3 *	10.7 *	10.6 *	10.5 *
beste Teiler	69.5 (48.) 88.7 (49.) 119.1 (50.)				
Trefferlage	0.49 mm rechts, 0.17 mm hoch				
Streuwert	1.46, horizontal: 1.62, vertikal: 1.27				

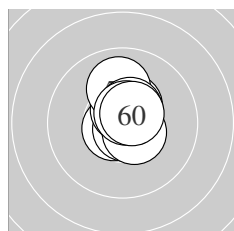

Serie 6:	10.6 *	10.7 *	10.4 *	10.8 *	10.6 *
	10.5 *	10.0 ↑	10.5 *	10.7 *	10.6 *
beste Teiler	44.5 (54.) 71.5 (52.) 74.0 (59.)				
Trefferlage	0.26 mm rechts, 0.60 mm hoch				
Streuwert	0.71, horizontal: 0.45, vertikal: 0.90				

Meyton Elektronik

ISSF AR Women Jun – Wertung – Juniorinnen

StandNr: 123

Benetti, Sofia #70811248

StartNr: 71

19. Januar 2019 11:15

ITA – Accademia

Unterschrift des Schützen

Meyton Elektronik

Ergebnis:	624.0	(596) ^{QF}							
Serien:	105.6	104.2	103.4	104.0	103.3	103.5			
Zähler:	56	4	0	0	0	0	0	0	0
Innenzehner:	45								
weiteste:	416 (50), 362 (60), 277 (37)								
beste Teiler	17.0 (8.)	20.8 (4.)	29.6 (9.)						
Trefferlage	0.33 mm links, 0.30 mm hoch								
Streuwert	1.10, horizontal: 1.23, vertikal: 0.95								

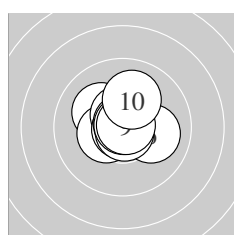
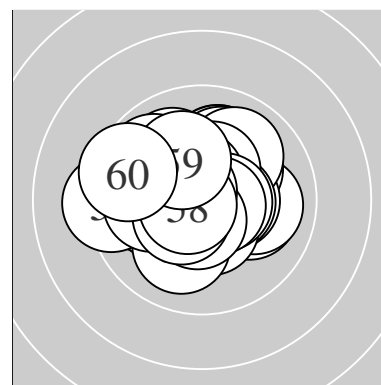

Serie 1:	10.2 *	10.4 *	10.6 *	10.9 *	10.8 *
	10.1 →	10.8 *	10.9 *	10.8 *	10.1 ↗
beste Teiler	17.0 (8.)	20.8 (4.)	29.6 (9.)		
Trefferlage	0.01 mm rechts, 0.33 mm hoch				
Streuwert	0.94, horizontal: 1.03, vertikal: 0.83				

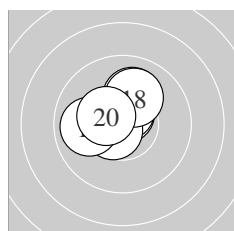

Serie 2:	10.8 *	10.5 *	10.7 *	10.6 *	10.5 *
	10.6 *	10.1 ↗	10.1 ↗	9.9 ←	10.4 *
beste Teiler	46.6 (11.)	53.8 (13.)	82.2 (14.)		
Trefferlage	0.42 mm links, 0.70 mm hoch				
Streuwert	0.93, horizontal: 1.02, vertikal: 0.84				

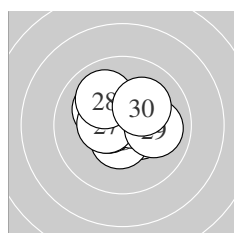

Serie 3:	10.2 *	10.4 *	10.5 *	10.6 *	10.5 *
	10.6 *	10.5 *	10.0 ↘	10.0 →	10.1 ↗
beste Teiler	81.0 (24.)	83.0 (26.)	111.1 (23.)		
Trefferlage	0.04 mm links, 0.40 mm hoch				
Streuwert	1.18, horizontal: 1.39, vertikal: 0.92				

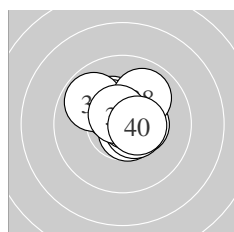

Serie 4:	10.7 *	10.4 *	10.6 *	10.3 *	10.4 *
	10.7 *	9.8 ↘	10.0 ↗	10.6 *	10.5 *
beste Teiler	53.0 (36.)	69.8 (31.)	83.1 (39.)		
Trefferlage	0.14 mm rechts, 0.61 mm hoch				
Streuwert	1.05, horizontal: 1.17, vertikal: 0.91				

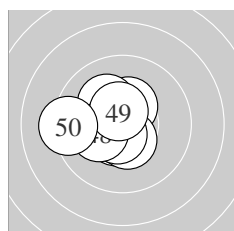

Serie 5:	10.5 *	10.6 *	10.4 *	10.2 *	10.5 *
	10.5 *	10.6 *	10.2 *	10.5 *	9.3 ←
beste Teiler	88.2 (42.)	88.5 (47.)	101.5 (49.)		
Trefferlage	0.88 mm links, 0.11 mm tief				
Streuwert	1.19, horizontal: 1.33, vertikal: 1.02				

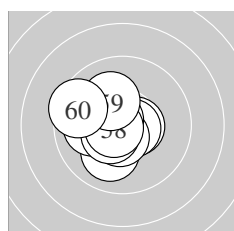

Serie 6:	10.6 *	10.1 ↘	10.7 *	10.0 ←	10.6 *
	10.7 *	10.5 *	10.7 *	10.1 ↗	9.5 ↘
beste Teiler	69.8 (58.)	71.8 (53.)	75.2 (56.)		
Trefferlage	0.83 mm links, 0.09 mm tief				
Streuwert	1.19, horizontal: 1.28, vertikal: 1.09				

Meyton Elektronik

ISSF AR Women Jun – Wertung – Juniorinnen

StandNr: 124

Dereviagina, Anastasiia #70811198

StartNr: 72

19. Januar 2019 11:14

RUS

QF – Schütze hat sich fürs Finale qualifiziert

Unterschrift des Schützen

Meyton Elektronik

Ergebnis:	614.4	(588)							
Serien:	100.9	101.7	101.2	102.4	103.6	104.6			
Zähler:	48	12	0	0	0	0	0	0	0
Innenzehner:	39								
weiteste:	473 (24), 419 (1), 380 (12)								
beste Teiler	42.0 (43.)	49.0 (7.)	49.0 (52.)						
Trefferlage	0.27 mm rechts, 0.01 mm hoch								
Streuwert	1.43, horizontal: 1.68, vertikal: 1.13								

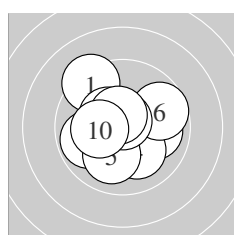
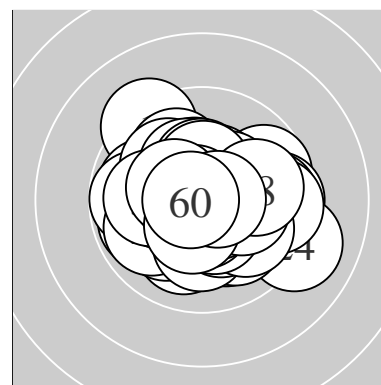

Serie 1:

9.3 ↘	9.8 ←	10.0 →	10.1 ↘	10.0 ↙
9.7 ↗	10.8 *	10.4 *	10.6 *	10.2 *

beste Teiler 49.0 (7.) 99.0 (9.) 142.8 (8.)
 Trefferlage 0.27 mm links, 0.16 mm hoch
 Streuwert 1.76, horizontal: 1.90, vertikal: 1.61

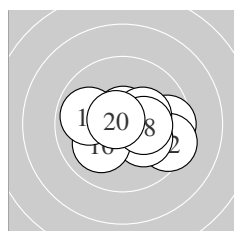

Serie 2:

9.6 →	9.4 ↘	10.7 *	10.2 *	10.5 *
10.1 ↙	10.3 *	10.3 *	9.9 ←	10.7 *

beste Teiler 62.6 (20.) 69.1 (13.) 112.7 (15.)
 Trefferlage 0.81 mm rechts, 0.15 mm tief
 Streuwert 1.55, horizontal: 2.01, vertikal: 0.86

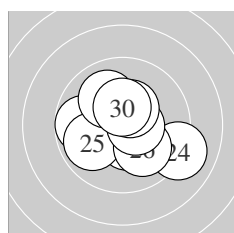

Serie 3:

10.4 *	9.8 ←	10.7 *	9.1 ↘	9.9 ↙
10.0 ↘	10.5 *	10.4 *	10.0 ↘	10.4 *

beste Teiler 75.8 (23.) 101.3 (27.) 130.0 (21.)
 Trefferlage 0.13 mm rechts, 0.08 mm tief
 Streuwert 1.77, horizontal: 2.05, vertikal: 1.42

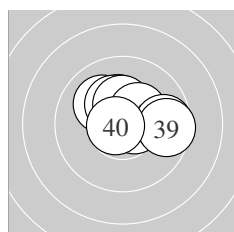

Serie 4:

10.5 *	10.6 *	10.3 *	10.1 ↘	10.3 *
10.3 *	10.3 *	9.7 →	9.6 →	10.7 *

beste Teiler 56.5 (40.) 92.1 (32.) 107.3 (31.)
 Trefferlage 0.63 mm rechts, 0.73 mm hoch
 Streuwert 1.28, horizontal: 1.64, vertikal: 0.79

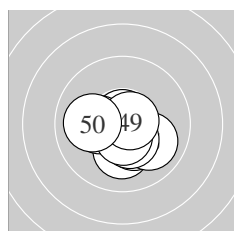

Serie 5:

10.4 *	10.2 *	10.8 *	10.3 *	10.0 ↘
10.2 *	10.4 *	10.6 *	10.7 *	10.0 ←

beste Teiler 42.0 (43.) 62.2 (49.) 95.2 (48.)
 Trefferlage 0.11 mm rechts, 0.69 mm tief
 Streuwert 1.09, horizontal: 1.31, vertikal: 0.82

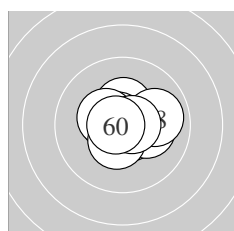

Serie 6:

10.4 *	10.8 *	10.5 *	10.6 *	10.2 *
10.4 *	10.4 *	9.9 →	10.7 *	10.7 *

beste Teiler 49.0 (52.) 53.0 (60.) 72.0 (59.)
 Trefferlage 0.20 mm rechts, 0.11 mm hoch
 Streuwert 1.00, horizontal: 1.22, vertikal: 0.71

Meyton Elektronik

ISSF AR Women Jun – Wertung – Juniorinnen

StandNr: 125

Schwertberger, Nadine #70811249

StartNr: 73

19. Januar 2019 11:45

Schützenbezirk Schwaben

Unterschrift des Schützen

Meyton Elektronik

Ergebnis: **615.5** (589)
 Serien: 101.7 101.7 101.1 103.6 104.1 103.3
 Zähler: 49 11 0 0 0 0 0 0 0
 Innenzehner: 41
 weiteste: 419 (9), 356 (25), 350 (17)
 beste Teiler 34.1 (5.) 35.5 (37.) 36.6 (46.)
 Trefferlage 0.07 mm rechts, 0.39 mm hoch
 Streuwert 1.37, horizontal: 1.23, vertikal: 1.49

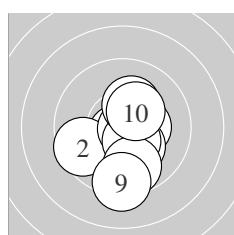
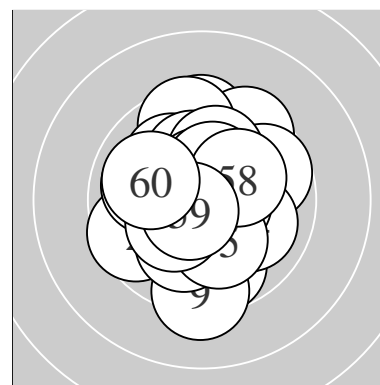

Serie 1:
 10.7 * 9.6 ↙ 10.4 * 10.2 * 10.8 *
 10.5 * 10.2 * 9.7 ↓ 9.3 ↓ 10.3 *
 beste Teiler 34.1 (5.) 65.6 (1.) 125.0 (6.)
 Trefferlage 0.23 mm rechts, 0.88 mm tief
 Streuwert 1.55, horizontal: 1.28, vertikal: 1.78

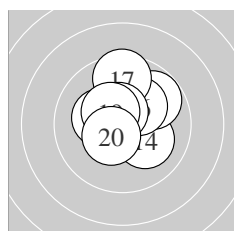

Serie 2:
 9.7 ↑ 10.5 * 10.3 * 10.1 ↘ 9.8 ↗
 10.2 * 9.6 ↑ 10.6 * 10.4 * 10.5 *
 beste Teiler 99.3 (18.) 123.5 (12.) 125.1 (20.)
 Trefferlage 0.26 mm rechts, 1.02 mm hoch
 Streuwert 1.40, horizontal: 1.28, vertikal: 1.51

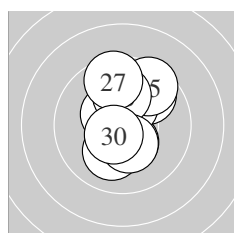

Serie 3:
 10.4 * 10.4 * 9.8 ↗ 10.3 * 9.5 ↗
 10.0 ↑ 9.6 ↑ 10.1 ↓ 10.4 * 10.6 *
 beste Teiler 99.7 (30.) 129.8 (21.) 139.0 (22.)
 Trefferlage 0.20 mm rechts, 0.78 mm hoch
 Streuwert 1.60, horizontal: 1.07, vertikal: 1.99

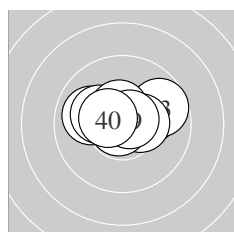

Serie 4:
 10.1 ↗ 10.7 * 9.7 ↗ 10.0 ↖ 10.4 *
 10.2 * 10.8 * 10.5 * 10.7 * 10.5 *
 beste Teiler 35.5 (37.) 64.8 (39.) 70.7 (32.)
 Trefferlage 0.03 mm rechts, 0.57 mm hoch
 Streuwert 1.21, horizontal: 1.65, vertikal: 0.44

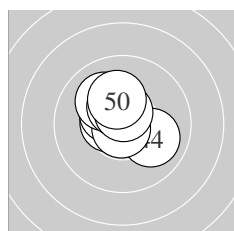

Serie 5:
 10.5 * 10.7 * 10.4 * 10.0 ↘ 10.4 *
 10.8 * 10.1 ↘ 10.4 * 10.6 * 10.2 *
 beste Teiler 36.6 (46.) 66.7 (42.) 90.2 (49.)
 Trefferlage 0.38 mm links, 0.66 mm hoch
 Streuwert 0.96, horizontal: 1.01, vertikal: 0.91

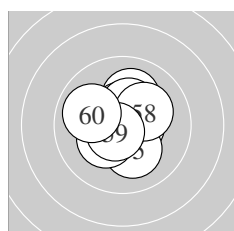

Serie 6:
 10.1 ↑ 10.5 * 10.5 * 10.6 * 10.2 *
 10.3 * 10.4 * 10.2 * 10.6 * 9.9 ↖
 beste Teiler 76.4 (59.) 96.7 (54.) 106.5 (53.)
 Trefferlage 0.07 mm rechts, 0.19 mm hoch
 Streuwert 1.22, horizontal: 1.18, vertikal: 1.26

Meyton Elektronik

ISSF AR Women Jun – Wertung – Juniorinnen

StandNr: 126

Vogl, Jana #15

StartNr: 74

19. Januar 2019 11:10

T – SG Wattens

Unterschrift des Schützen

Meyton Elektronik

Ergebnis:	614.5	(592)							
Serien:	101.9	102.0	102.6	101.6	102.9	103.5			
Zähler:	52	8	0	0	0	0	0	0	0
Innenzehner:	39								
weiteste:	347	(31),	328	(39),	315	(19)			
beste Teiler	34.5	(46.)	41.1	(29.)	42.5	(52.)			
Trefferlage	0.38 mm links, 0.02 mm tief								
Streuwert	1.35, horizontal: 1.50, vertikal: 1.18								

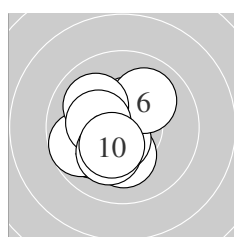
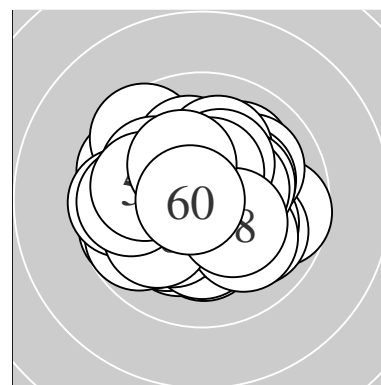

Serie 1:					
	10.2 *	10.0 ↙	9.7 ↙	10.5 *	10.6 *
	10.0 ↗	10.0 ↘	10.3 *	10.2 *	10.4 *
beste Teiler	85.4 (5.) 124.4 (4.) 144.4 (10.)				
Trefferlage	0.84 mm links, 0.33 mm tief				
Streuwert	1.34, horizontal: 1.28, vertikal: 1.40				

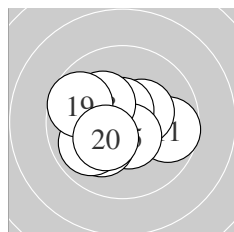

Serie 2:					
	9.7 →	10.6 *	10.4 *	10.6 *	10.5 *
	10.1 ↙	9.9 ↙	10.2 *	9.7 ↖	10.3 *
beste Teiler	82.6 (14.) 98.0 (12.) 105.1 (15.)				
Trefferlage	0.52 mm links, 0.15 mm tief				
Streuwert	1.47, horizontal: 1.77, vertikal: 1.08				

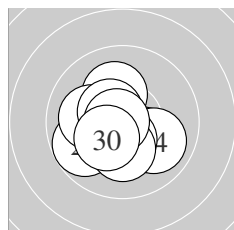

Serie 3:					
	10.2 *	10.2 *	9.8 ↙	10.0 ↘	10.5 *
	10.1 ←	10.2 *	10.5 *	10.8 *	10.3 *
beste Teiler	41.1 (29.) 111.5 (28.) 121.4 (25.)				
Trefferlage	0.39 mm links, 0.51 mm tief				
Streuwert	1.32, horizontal: 1.44, vertikal: 1.20				

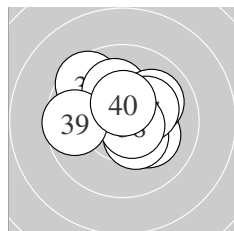

Serie 4:					
	9.6 ↘	10.1 ↑	10.3 *	10.2 *	10.0 ↗
	10.4 *	10.2 *	10.7 *	9.6 ←	10.5 *
beste Teiler	72.0 (38.) 122.0 (40.) 139.7 (36.)				
Trefferlage	0.22 mm rechts, 0.55 mm hoch				
Streuwert	1.54, horizontal: 1.80, vertikal: 1.23				

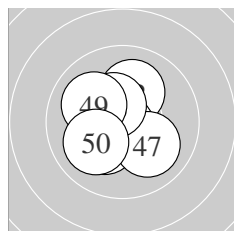

Serie 5:					
	10.6 *	10.1 ↑	10.2 *	10.4 *	10.4 *
	10.8 *	10.0 ↘	10.4 *	10.0 ↖	10.0 ↙
beste Teiler	34.5 (46.) 99.8 (41.) 129.7 (48.)				
Trefferlage	0.68 mm links, 0.14 mm tief				
Streuwert	1.19, horizontal: 1.15, vertikal: 1.22				

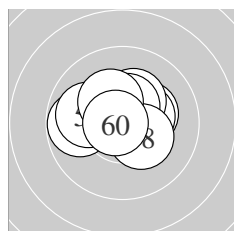

Serie 6:					
	10.3 *	10.8 *	10.4 *	9.8 ←	10.0 ←
	10.3 *	10.5 *	10.3 *	10.3 *	10.8 *
beste Teiler	42.5 (52.) 49.0 (60.) 119.1 (57.)				
Trefferlage	0.09 mm links, 0.46 mm hoch				
Streuwert	1.22, horizontal: 1.55, vertikal: 0.76				

Meyton Elektronik

ISSF AR Women Jun – Wertung – Juniorinnen

StandNr: 127

Fricke, Barbara #70811250

StartNr: 75

19. Januar 2019 11:42

Schützenbezirk Schwaben

Unterschrift des Schützen

Meyton Elektronik