

Ergebnis:	612.7	(588)
Serien:	102.5	102.3 103.1 101.9 101.1 101.8
Zähler:	48	12 0 0 0 0 0 0 0 0
Innenzehner:	32	
weiteste:	407	(44), 328 (49), 318 (21)
beste Teiler	13.6	(26.) 23.3 (23.) 49.6 (31.)
Trefferlage	0.20 mm	links, 0.36 mm hoch
Streuwert	1.42,	horizontal: 1.51, vertikal: 1.31

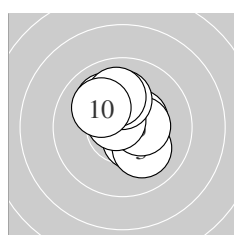

Serie 1:	10.5 *	10.0 ↘	10.1 ↘	10.4 *	10.4 *
	10.2 *	10.7 *	10.1 ↑	10.0 ↑	10.1 ↘
beste Teiler	68.5	(7.) 119.2 (1.)	132.3 (4.)		
Trefferlage	0.02 mm	rechts, 0.81 mm hoch			
Streuwert	1.22,	horizontal: 1.11, vertikal: 1.32			

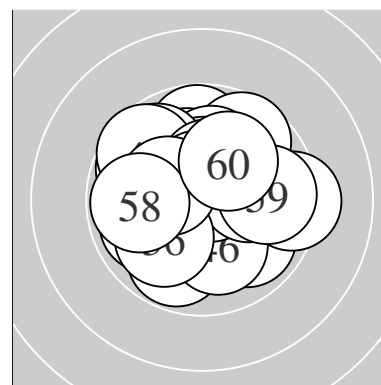
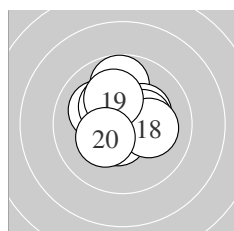

Serie 2:	9.8 ↑	10.3 *	10.6 *	10.3 *	10.3 *
	10.1 ↘	10.3 *	10.2 *	10.1 ↑	10.3 *
beste Teiler	96.5	(13.) 153.5 (15.)	164.0 (20.)		
Trefferlage	0.20 mm	links, 0.71 mm hoch			
Streuwert	1.31,	horizontal: 1.38, vertikal: 1.23			

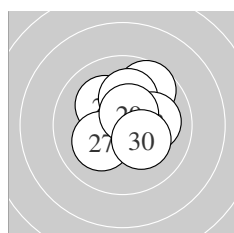

Serie 3:	9.7 ↗	10.3 *	10.9 *	10.1 ↘	10.1 ↑
	10.9 *	10.2 *	10.1 →	10.6 *	10.2 *
beste Teiler	13.6	(26.) 23.3 (23.)	98.8 (29.)		
Trefferlage	0.23 mm	rechts, 0.38 mm hoch			
Streuwert	1.33,	horizontal: 1.33, vertikal: 1.34			

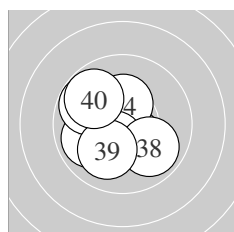

Serie 4:	10.8 *	10.5 *	10.4 *	10.3 *	9.9 ↙
	9.8 ↘	10.4 *	9.9 ↘	10.1 ↙	9.8 ↘
beste Teiler	49.6	(31.) 125.0 (32.)	129.3 (33.)		
Trefferlage	0.77 mm	links, 0.20 mm tief			
Streuwert	1.44,	horizontal: 1.45, vertikal: 1.42			

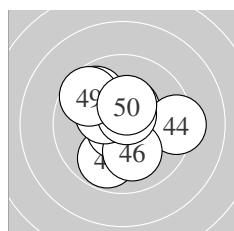

Serie 5:	9.8 ↘	9.8 ↙	10.4 *	9.3 →	10.7 *
	10.1 ↓	10.3 *	10.7 *	9.6 ↘	10.4 *
beste Teiler	61.7	(45.) 75.6 (48.)	128.3 (43.)		
Trefferlage	0.15 mm	links, 0.31 mm hoch			
Streuwert	1.74,	horizontal: 1.86, vertikal: 1.61			

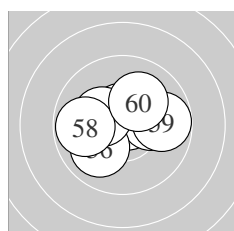

Serie 6:	10.6 *	10.3 *	10.0 ←	10.8 *	10.1 →
	10.0 ↙	10.3 *	9.8 ←	9.8 →	10.1 ↗
beste Teiler	50.9	(54.) 91.2 (51.)	167.3 (57.)		
Trefferlage	0.35 mm	links, 0.15 mm hoch			
Streuwert	1.54,	horizontal: 1.97, vertikal: 0.92			

Meyton Elektronik

ISSF AR Women Jun – Wertung – Juniorinnen

StartNr: 24

StandNr: 124

20. Januar 2018 9:52

Adams, Emma #59

AUS

Unterschrift des Schützen

Meyton Elektronik

Ergebnis:	622.2	(592) ^{QF}						
Serien:	103.7	103.1	102.9	104.3	104.7	103.5		
Zähler:	52	8	0	0	0	0	0	0
Innenzehner:	48							
weiteste:	370 (21), 360 (13), 299 (50)							
beste Teiler	24.1 (53.) 30.1 (27.) 31.5 (6.)							
Trefferlage	0.08 mm rechts, 0.01 mm tief							
Streuwert	1.17, horizontal: 1.33, vertikal: 0.97							

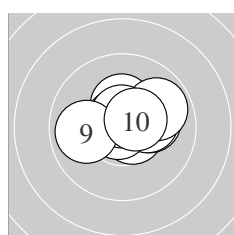
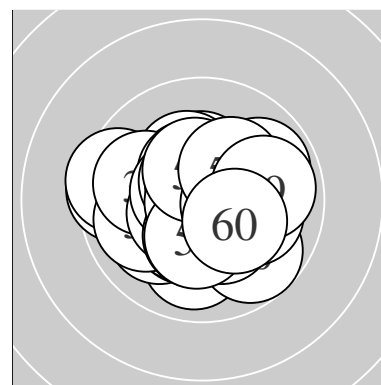

Serie 1:	10.6 *	10.3 *	10.2 *	10.2 *	10.7 *
	10.8 *	9.9 ↗	10.6 *	9.9 ←	10.5 *
beste Teiler	31.5 (6.) 61.5 (5.) 77.3 (8.)				
Trefferlage	0.42 mm rechts, 0.46 mm hoch				
Streuwert	1.12, horizontal: 1.46, vertikal: 0.63				

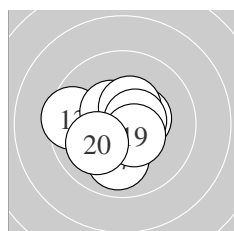

Serie 2:	10.6 *	10.4 *	9.5 ←	10.5 *	10.4 *
	10.6 *	10.0 ↓	10.6 *	10.5 *	10.0 ↙
beste Teiler	87.6 (11.) 93.6 (18.) 94.2 (16.)				
Trefferlage	0.33 mm links, 0.30 mm tief				
Streuwert	1.31, horizontal: 1.47, vertikal: 1.13				

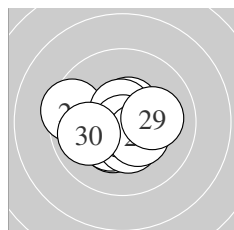

Serie 3:	9.5 ←	10.5 *	10.6 *	10.3 *	10.4 *
	10.4 *	10.8 *	10.4 *	10.1 →	9.9 ←
beste Teiler	30.1 (27.) 83.7 (23.) 105.7 (22.)				
Trefferlage	0.36 mm links, 0.31 mm tief				
Streuwert	1.36, horizontal: 1.66, vertikal: 0.97				

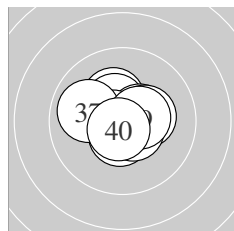

Serie 4:	10.3 *	10.5 *	10.4 *	10.4 *	10.3 *
	10.7 *	9.9 ←	10.6 *	10.5 *	10.7 *
beste Teiler	65.7 (40.) 68.0 (36.) 95.1 (38.)				
Trefferlage	0.01 mm links, 0.21 mm hoch				
Streuwert	1.03, horizontal: 1.21, vertikal: 0.81				

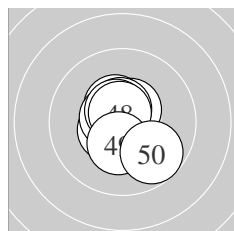

Serie 5:	10.5 *	10.5 *	10.5 *	10.6 *	10.6 *
	10.6 *	10.6 *	10.7 *	10.3 *	9.8 ↘
beste Teiler	68.9 (48.) 91.4 (44.) 91.5 (45.)				
Trefferlage	0.10 mm links, 0.04 mm tief				
Streuwert	1.03, horizontal: 0.87, vertikal: 1.17				

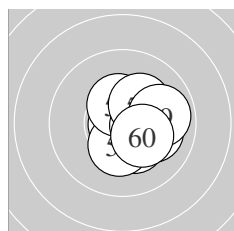

Serie 6:	10.7 *	10.3 *	10.9 *	10.3 *	10.1 →
	10.4 *	10.4 *	10.2 *	9.9 →	10.3 *
beste Teiler	24.1 (53.) 54.4 (51.) 131.7 (56.)				
Trefferlage	0.88 mm rechts, 0.10 mm tief				
Streuwert	1.03, horizontal: 1.04, vertikal: 1.02				

Meyton Elektronik

ISSF AR Women Jun – Wertung – Juniorinnen

StartNr: 25

StandNr: 125

20. Januar 2018 9:38

Boldinova, Daria #60

RUS

QF – Schütze hat sich fürs Finale qualifiziert

Unterschrift des Schützen

Meyton Elektronik

Ergebnis:	596.6	(570)
Serien:	97.5	101.8 99.6 99.5 100.6 97.6
Zähler:	32 26 2 0 0 0 0 0 0	
Innenzehner:	23	
weiteste:	544 (41), 520 (5), 491 (57)	
beste Teiler	14.5 (27.) 35.8 (40.) 48.2 (11.)	
Trefferlage	0.08 mm rechts, 0.61 mm hoch	
Streuwert	1.97, horizontal: 2.08, vertikal: 1.85	

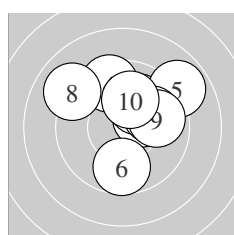
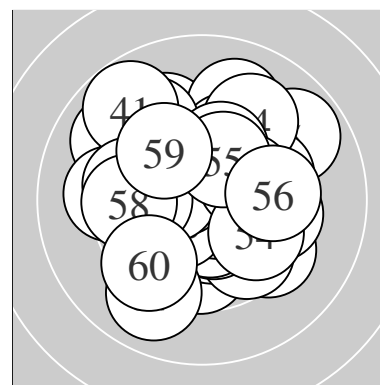

Serie 1:

10.3 *	10.0 ↗	10.1 ↗	9.5 ↑	8.9 ↗
9.7 ↓	10.0 →	9.0 ↘	9.9 →	10.1 ↑
beste Teiler	161.4 (1.)	201.3 (3.)	223.2 (10.)	
Trefferlage	0.86 mm rechts, 1.41 mm hoch			
Streuwert	2.06, horizontal: 2.24, vertikal: 1.85			

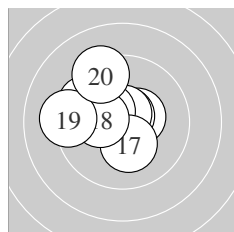

Serie 2:

10.8 *	10.5 *	10.7 *	10.7 *	9.7 ↘
10.3 *	10.3 *	10.3 *	9.2 ←	9.3 ↘
beste Teiler	48.2 (11.)	55.4 (13.)	66.1 (14.)	
Trefferlage	0.95 mm links, 0.67 mm hoch			
Streuwert	1.54, horizontal: 1.72, vertikal: 1.34			

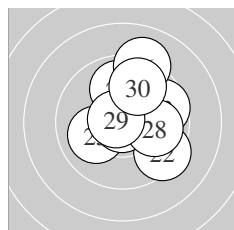

Serie 3:

10.3 *	9.4 ↘	9.7 →	9.9 ↑	10.0 ←
9.1 ↑	10.9 *	9.9 →	10.7 *	9.7 ↑
beste Teiler	14.5 (27.)	55.9 (29.)	163.8 (21.)	
Trefferlage	0.97 mm rechts, 0.81 mm hoch			
Streuwert	1.85, horizontal: 1.70, vertikal: 2.00			

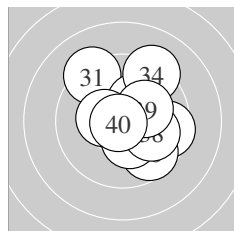

Serie 4:

9.2 ↘	10.2 *	10.4 *	9.2 ↗	9.5 →
9.7 ↘	10.3 *	10.0 →	10.2 *	10.8 *
beste Teiler	35.8 (40.)	143.8 (33.)	158.2 (37.)	
Trefferlage	0.92 mm rechts, 0.43 mm hoch			
Streuwert	1.93, horizontal: 1.83, vertikal: 2.02			

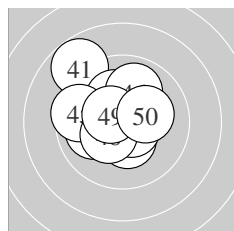

Serie 5:

8.8 ↘	10.4 *	10.0 ←	10.2 *	9.6 ←
9.9 ↑	10.6 *	10.4 *	10.5 *	10.2 *
beste Teiler	87.2 (47.)	110.4 (49.)	145.3 (42.)	
Trefferlage	0.79 mm links, 0.68 mm hoch			
Streuwert	1.77, horizontal: 1.79, vertikal: 1.75			

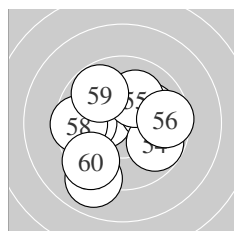

Serie 6:

10.3 *	9.9 ←	10.1 →	9.8 ↘	10.1 ↑
9.6 →	9.0 ↙	9.6 ←	9.8 ↘	9.4 ↙
beste Teiler	151.6 (51.)	214.2 (55.)	224.8 (53.)	
Trefferlage	0.52 mm links, 0.32 mm tief			
Streuwert	2.30, horizontal: 2.49, vertikal: 2.08			

Meyton Elektronik

ISSF AR Women Jun – Wertung – Juniorinnen

StandNr: 126

Grieser, Verena #61

StartNr: 26

20. Januar 2018 9:42

BAY – Schwaben

Unterschrift des Schützen

Meyton Elektronik

Ergebnis:	623.8	(594) ^{QF}							
Serien:	103.1	104.9	102.3	105.3	103.6	104.6			
Zähler:	54	6	0	0	0	0	0	0	0
Innenzehner:	48								
weiteste:	365 (27), 336 (30), 329 (44)								
beste Teiler	24.0 (47.) 30.4 (34.) 36.6 (58.)								
Trefferlage	0.07 mm links, 0.11 mm hoch								
Streuwert	1.14, horizontal: 1.25, vertikal: 1.01								

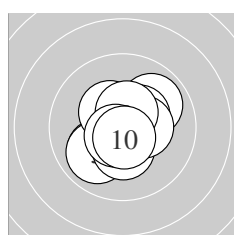
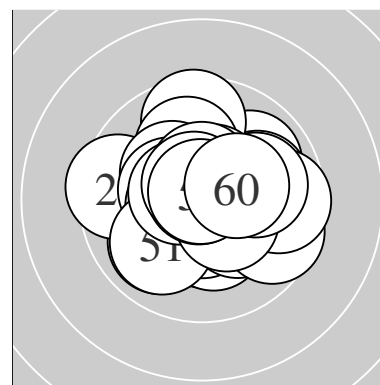

Serie 1:

9.9 ↗	10.0 ↙	9.9 ↙	10.4 *	10.3 *
10.4 *	10.4 *	10.5 *	10.6 *	10.7 *
beste Teiler	74.8 (10.) 78.8 (9.) 109.8 (8.)			
Trefferlage	0.01 mm rechts, 0.17 mm tief			
Streuwert	1.27, horizontal: 1.29, vertikal: 1.26			

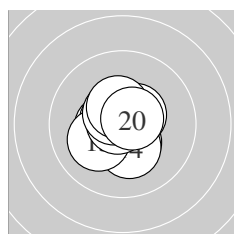

Serie 2:

10.4 *	10.5 *	10.6 *	10.3 *	10.1 ↙
10.8 *	10.5 *	10.6 *	10.5 *	10.6 *
beste Teiler	37.3 (16.) 78.8 (20.) 87.3 (13.)			
Trefferlage	0.24 mm links, 0.08 mm tief			
Streuwert	0.92, horizontal: 0.87, vertikal: 0.96			

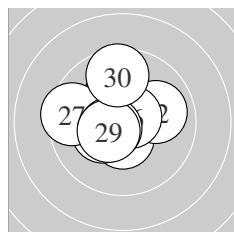

Serie 3:

10.5 *	10.0 →	10.3 *	10.2 *	10.4 *
10.7 *	9.5 ←	10.6 *	10.5 *	9.6 ↑
beste Teiler	66.2 (26.) 98.4 (28.) 111.0 (21.)			
Trefferlage	0.58 mm links, 0.48 mm hoch			
Streuwert	1.43, horizontal: 1.52, vertikal: 1.34			

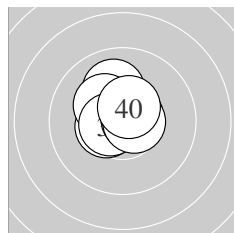

Serie 4:

10.5 *	10.6 *	10.0 ↑	10.8 *	10.3 *
10.7 *	10.6 *	10.7 *	10.6 *	10.5 *
beste Teiler	30.4 (34.) 71.1 (38.) 75.4 (36.)			
Trefferlage	0.20 mm links, 0.52 mm hoch			
Streuwert	0.79, horizontal: 0.81, vertikal: 0.77			

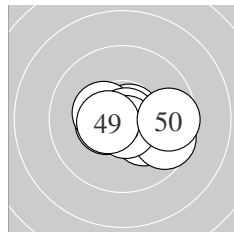

Serie 5:

10.7 *	10.5 *	10.2 *	9.6 ↘	10.5 *
10.4 *	10.9 *	10.7 *	10.5 *	9.6 →
beste Teiler	24.0 (47.) 53.2 (41.) 61.4 (48.)			
Trefferlage	0.41 mm rechts, 0.29 mm tief			
Streuwert	1.27, horizontal: 1.70, vertikal: 0.56			

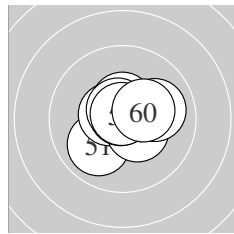

Serie 6:

10.0 ↙	10.6 *	10.4 *	10.8 *	10.6 *
10.5 *	10.6 *	10.8 *	10.0 →	10.3 *
beste Teiler	36.6 (58.) 36.7 (54.) 76.4 (57.)			
Trefferlage	0.16 mm rechts, 0.24 mm hoch			
Streuwert	1.04, horizontal: 1.17, vertikal: 0.89			

Meyton Elektronik

ISSF AR Women Jun – Wertung – Juniorinnen

StartNr: 27

StandNr: 127

20. Januar 2018 9:41

Bolotkova, Polina #62

RUS

QF – Schütze hat sich fürs Finale qualifiziert

Unterschrift des Schützen

Meyton Elektronik

Ergebnis: **600.2** (573)
 Serien: 93.1 99.2 99.9 100.8 104.4 102.8
 Zähler: 37 19 4 0 0 0 0 0 0
 Innenzehner: 29
 weiteste: 659 (6), 639 (15), 575 (3)
 beste Teiler 27.5 (49.) 32.5 (26.) 41.3 (43.)
 Trefferlage 0.11 mm links, 0.18 mm tief
 Streuwert 1.98, horizontal: 2.19, vertikal: 1.75

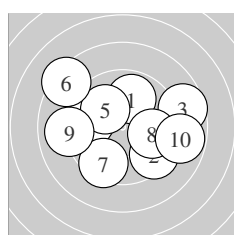
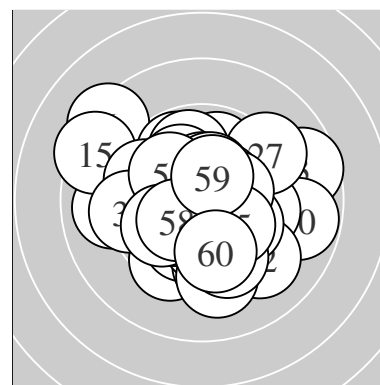

Serie 1:
 9.9 ↗ 9.4 ↘ 8.7 → 9.7 ← 10.0 ↖
 8.3 ↖ 9.5 ↙ 9.8 → 9.0 ← 8.8 →
 beste Teiler 227.7 (5.) 269.1 (1.) 276.3 (8.)
 Trefferlage 0.07 mm rechts, 0.26 mm hoch
 Streuwert 3.21, horizontal: 3.92, vertikal: 2.29

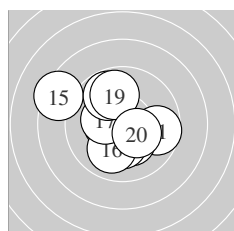

Serie 2:
 9.7 → 10.4 * 10.3 * 10.2 * 8.4 ↖
 10.0 ↙ 10.3 * 9.8 ↘ 9.8 ↗ 10.3 *
 beste Teiler 128.3 (12.) 152.8 (20.) 163.4 (17.)
 Trefferlage 0.66 mm links, 0.11 mm hoch
 Streuwert 2.13, horizontal: 2.34, vertikal: 1.89

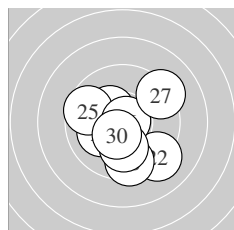

Serie 3:
 10.7 * 9.2 ↘ 10.3 * 10.1 ← 9.6 ↖
 10.8 * 9.2 ↗ 9.5 ↓ 10.0 ↓ 10.5 *
 beste Teiler 32.5 (26.) 56.0 (21.) 124.8 (30.)
 Trefferlage 0.03 mm rechts, 0.62 mm tief
 Streuwert 2.01, horizontal: 2.06, vertikal: 1.97

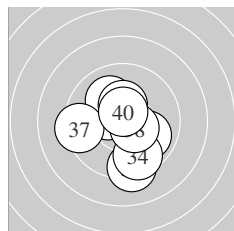

Serie 4:
 9.9 ↘ 10.7 * 9.2 ↓ 9.6 ↓ 10.4 *
 10.1 ↖ 9.4 ← 10.5 * 10.4 * 10.6 *
 beste Teiler 52.0 (32.) 85.1 (40.) 125.0 (38.)
 Trefferlage 0.06 mm links, 0.46 mm tief
 Streuwert 1.85, horizontal: 1.74, vertikal: 1.96

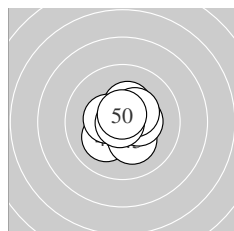

Serie 5:
 10.3 * 10.1 ↗ 10.8 * 10.3 * 10.2 *
 10.4 * 10.4 * 10.4 * 10.8 * 10.7 *
 beste Teiler 27.5 (49.) 41.3 (43.) 69.2 (50.)
 Trefferlage 0.04 mm links, 0.03 mm tief
 Streuwert 1.02, horizontal: 1.03, vertikal: 1.02

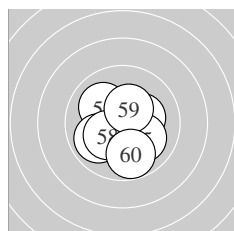

Serie 6:
 10.7 * 10.6 * 10.3 * 10.7 * 10.1 ↘
 10.0 ↖ 9.9 ↗ 10.3 * 10.4 * 9.8 ↓
 beste Teiler 53.2 (54.) 65.2 (51.) 84.6 (52.)
 Trefferlage 0.01 mm links, 0.34 mm tief
 Streuwert 1.37, horizontal: 1.37, vertikal: 1.37

Meyton Elektronik

ISSF AR Women Jun – Wertung – Juniorinnen

StartNr: 28

StandNr: 128

20. Januar 2018 9:42

Brabcova, Karolina #63

CZE

Unterschrift des Schützen

Meyton Elektronik

Ergebnis:	622.3	(592) ^{QF}							
Serien:	104.7	104.4	104.5	101.6	103.1	104.0			
Zähler:	52	8	0	0	0	0	0	0	0
Innenzehner:	46								
weiteste:	420 (44), 398 (10), 371 (35)								
beste Teiler	4.1 (24.)	13.9 (54.)	19.2 (49.)						
Trefferlage	0.20 mm rechts, 0.11 mm hoch								
Streuwert	1.26, horizontal: 1.30, vertikal: 1.21								

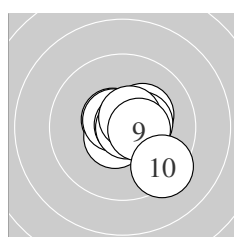
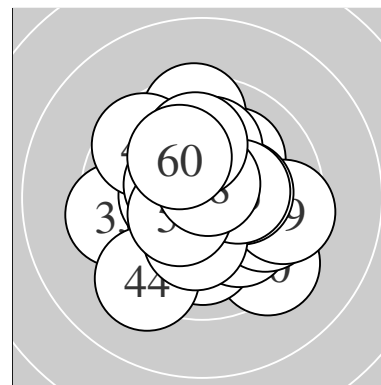

Serie 1:	10.6 *	10.6 *	10.3 *	10.6 *	10.9 *
	10.8 *	10.4 *	10.6 *	10.5 *	9.4 ↘
beste Teiler	25.8 (5.)	31.1 (6.)	79.6 (4.)		
Trefferlage	0.59 mm rechts, 0.06 mm tief				
Streuwert	1.10, horizontal: 1.12, vertikal: 1.07				

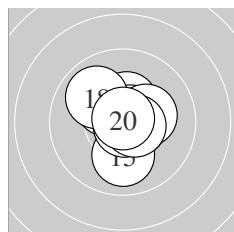

Serie 2:	10.3 *	10.6 *	10.4 *	10.7 *	10.0 ↓
	10.8 *	10.3 *	9.9 ↘	10.6 *	10.8 *
beste Teiler	26.3 (20.)	30.4 (16.)	70.8 (14.)		
Trefferlage	0.15 mm rechts, 0.24 mm hoch				
Streuwert	1.09, horizontal: 1.02, vertikal: 1.17				

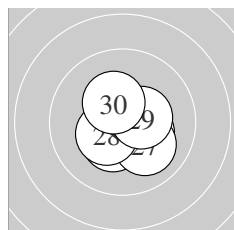

Serie 3:	10.4 *	10.6 *	10.3 *	10.9 *	10.7 *
	10.4 *	10.1 ↘	10.4 *	10.4 *	10.3 *
beste Teiler	4.1 (24.)	75.9 (25.)	91.2 (22.)		
Trefferlage	0.35 mm rechts, 0.21 mm tief				
Streuwert	0.99, horizontal: 1.04, vertikal: 0.94				

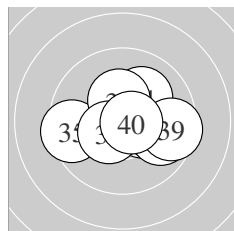

Serie 4:	10.4 *	10.0 →	10.9 *	10.1 ↗	9.5 ←
	9.8 →	10.3 *	10.4 *	9.5 →	10.7 *
beste Teiler	19.9 (33.)	63.9 (40.)	127.1 (38.)		
Trefferlage	0.71 mm rechts, 0.12 mm tief				
Streuwert	1.61, horizontal: 2.07, vertikal: 0.93				

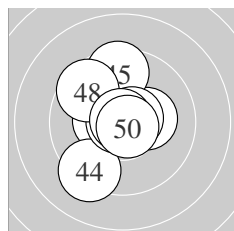

Serie 5:	10.3 *	10.8 *	10.4 *	9.3 ✓	9.5 ↑
	10.8 *	10.7 *	9.6 ↘	10.9 *	10.8 *
beste Teiler	19.2 (49.)	34.3 (42.)	38.0 (46.)		
Trefferlage	0.46 mm links, 0.27 mm hoch				
Streuwert	1.57, horizontal: 1.31, vertikal: 1.80				

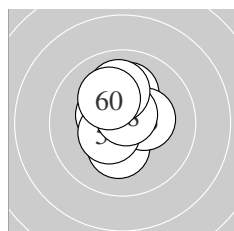

Serie 6:	10.1 ↑	10.4 *	10.3 *	10.9 *	10.6 *
	10.3 *	10.5 *	10.7 *	10.0 ↑	10.2 *
beste Teiler	13.9 (54.)	66.3 (58.)	76.4 (55.)		
Trefferlage	0.10 mm links, 0.59 mm hoch				
Streuwert	1.06, horizontal: 0.82, vertikal: 1.25				

Meyton Elektronik

ISSF AR Women Jun – Wertung – Juniorinnen

StartNr: 29

StandNr: 129

20. Januar 2018 9:49

Bratchikova, Natalia #64

RUS

QF – Schütze hat sich fürs Finale qualifiziert

Unterschrift des Schützen

Meyton Elektronik

Ergebnis: **620.2** (594)
 Serien: 102.7 103.9 104.2 104.3 102.1 103.0
 Zähler: 54 6 0 0 0 0 0 0 0
 Innenzehner: 45
 weiteste: 410 (11), 322 (59), 314 (50)
 beste Teiler 14.2 (18.) 36.4 (17.) 39.0 (19.)
 Trefferlage 0.25 mm links, 0.28 mm hoch
 Streuwert 1.21, horizontal: 1.32, vertikal: 1.09

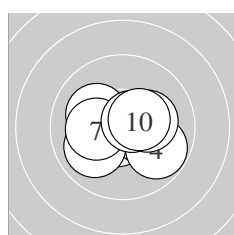
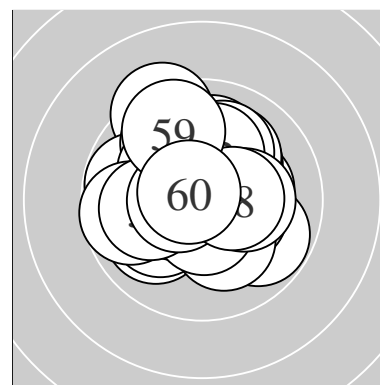

Serie 1:
 10.7 * 10.3 * 10.4 * 9.8 ↘ 10.1 ↘
 10.0 ↙ 10.2 * 10.6 * 10.2 * 10.4 *
 beste Teiler 72.7 (1.) 80.7 (8.) 132.0 (10.)
 Trefferlage 0.01 mm rechts, 0.13 mm tief
 Streuwert 1.35, horizontal: 1.71, vertikal: 0.84

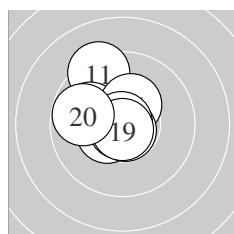

Serie 2:
 9.3 ↖ 10.0 ↖ 10.5 * 10.7 * 10.3 *
 10.8 * 10.8 * 10.9 * 10.8 * 9.8 ↖
 beste Teiler 14.2 (18.) 36.4 (17.) 39.0 (19.)
 Trefferlage 0.78 mm links, 0.54 mm hoch
 Streuwert 1.23, horizontal: 1.17, vertikal: 1.29

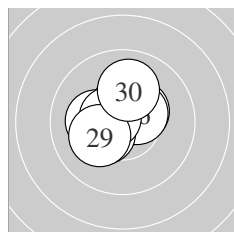

Serie 3:
 10.8 * 10.7 * 10.4 * 10.2 * 10.5 *
 10.5 * 10.3 * 10.6 * 10.2 * 10.0 ↑
 beste Teiler 42.5 (21.) 66.3 (22.) 95.5 (28.)
 Trefferlage 0.35 mm links, 0.45 mm hoch
 Streuwert 1.01, horizontal: 1.07, vertikal: 0.94

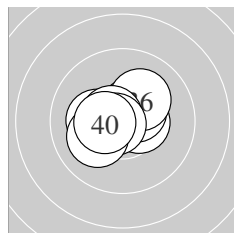

Serie 4:
 10.6 * 10.2 * 10.5 * 10.5 * 10.5 *
 10.2 * 10.6 * 10.7 * 10.1 ↙ 10.4 *
 beste Teiler 58.3 (38.) 83.5 (31.) 87.0 (37.)
 Trefferlage 0.17 mm links, 0.25 mm hoch
 Streuwert 1.01, horizontal: 1.23, vertikal: 0.72

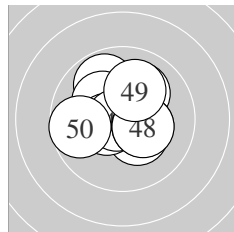

Serie 5:
 10.3 * 10.1 ↗ 9.8 ↖ 10.2 * 10.5 *
 10.8 * 10.3 * 10.3 * 10.1 ↑ 9.7 ↖
 beste Teiler 42.7 (46.) 119.2 (45.) 154.1 (41.)
 Trefferlage 0.13 mm links, 0.44 mm hoch
 Streuwert 1.45, horizontal: 1.58, vertikal: 1.32

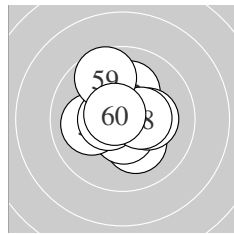

Serie 6:
 10.2 * 10.1 ↑ 10.7 * 10.5 * 10.0 ↖
 10.5 * 10.2 * 10.4 * 9.7 ↗ 10.7 *
 beste Teiler 66.3 (60.) 75.1 (53.) 102.0 (56.)
 Trefferlage 0.08 mm links, 0.16 mm hoch
 Streuwert 1.32, horizontal: 1.26, vertikal: 1.38

Meyton Elektronik

ISSF AR Women Jun – Wertung – Juniorinnen

StartNr: 30

StandNr: 130

20. Januar 2018 9:52

Ho, Xiu Yi #65

SGP

Unterschrift des Schützen

Meyton Elektronik

Ergebnis:	591.0	(562)
Serien:	101.0 99.9 97.9 96.6 98.2 97.4	
Zähler:	29 24 7 0 0 0 0 0 0	
Innenzehner:	19	
weiteste:	647 (48), 575 (38), 575 (54)	
beste Teiler	31.7 (12.) 72.8 (37.) 86.0 (45.)	
Trefferlage	0.19 mm rechts, 0.19 mm tief	
Streuwert	2.20, horizontal: 2.50, vertikal: 1.86	

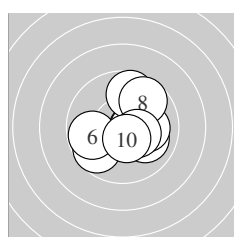
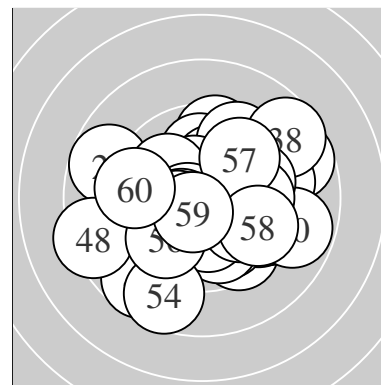

Serie 1:	10.0 ↘	10.6 *	9.7 ↙	10.5 *	10.1 →
	9.8 ←	9.7 ↑	9.7 ↗	10.4 *	10.5 *
beste Teiler	97.3 (2.)	107.1 (4.)	112.6 (10.)		
Trefferlage	0.54 mm rechts, 0.02 mm tief				
Streuwert	1.68, horizontal: 1.77, vertikal: 1.58				

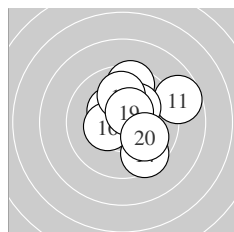

Serie 2:	8.7 →	10.8 *	9.5 ↑	9.5 ↘	10.3 *
	10.4 *	10.2 *	10.0 ↑	10.5 *	10.0 ↘
beste Teiler	31.7 (12.)	114.8 (19.)	145.8 (16.)		
Trefferlage	0.90 mm rechts, 0.68 mm hoch				
Streuwert	1.91, horizontal: 1.91, vertikal: 1.90				

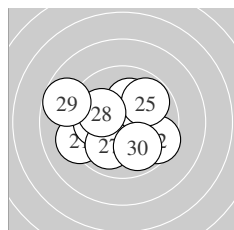

Serie 3:	9.2 ←	9.5 ↘	10.2 *	10.5 *	9.8 ↗
	10.0 ←	10.0 ↙	10.1 ↖	8.7 ↖	9.9 ↘
beste Teiler	103.0 (24.)	195.7 (23.)	213.9 (28.)		
Trefferlage	0.80 mm links, 0.20 mm tief				
Streuwert	2.25, horizontal: 2.68, vertikal: 1.71				

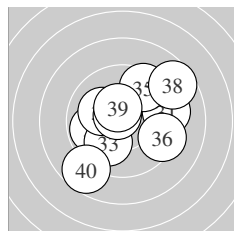

Serie 4:	9.3 →	9.8 ←	10.0 ↙	10.1 ↖	9.5 ↗
	9.4 →	10.7 *	8.7 ↗	10.4 *	8.7 ↙
beste Teiler	72.8 (37.)	131.9 (39.)	212.0 (34.)		
Trefferlage	0.40 mm rechts, 0.13 mm hoch				
Streuwert	2.69, horizontal: 2.96, vertikal: 2.38				

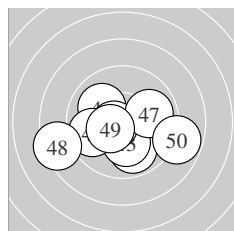

Serie 5:	10.2 *	9.9 ↘	10.2 *	10.0 ↖	10.6 *
	9.8 ←	9.9 →	8.4 ←	10.4 *	8.8 →
beste Teiler	86.0 (45.)	130.6 (49.)	193.0 (43.)		
Trefferlage	0.24 mm links, 0.93 mm tief				
Streuwert	2.35, horizontal: 3.07, vertikal: 1.27				

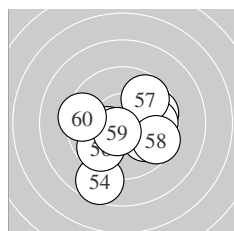

Serie 6:	10.3 *	9.7 →	9.9 ↘	8.7 ↙	9.8 →
	9.7 ↙	9.7 ↗	9.6 ↘	10.6 *	9.4 ←
beste Teiler	95.4 (59.)	155.6 (51.)	251.3 (53.)		
Trefferlage	0.34 mm rechts, 0.83 mm tief				
Streuwert	2.34, horizontal: 2.58, vertikal: 2.06				

ISSF AR Women Jun – Wertung – Juniorinnen

StandNr: 131

Ceric, Angelina #66

StartNr: 31

20. Januar 2018 9:41

VSBL NWLZ

Unterschrift des Schützen

Meyton Elektronik

Ergebnis:	620.4	(594)					
Serien:	103.5	103.0	103.2	104.1	103.0	103.6	
Zähler:	54	6	0	0	0	0	0
Innenzehner:	46						
weiteste:	416 (40), 288 (6), 287 (45)						
beste Teiler	25.2 (22.) 36.1 (39.) 40.0 (3.)						
Trefferlage	0.02 mm links, 0.16 mm hoch						
Streuwert	1.21, horizontal: 1.16, vertikal: 1.26						

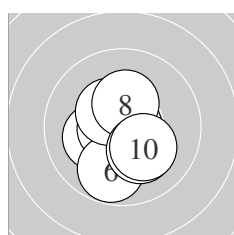
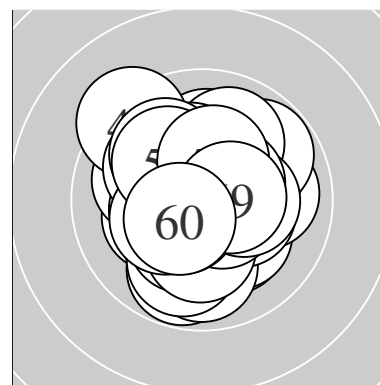

Serie 1:

10.4 *	10.6 *	10.8 *	10.2 *	10.6 *
9.8 ↓	10.4 *	10.3 *	10.2 *	10.2 *
beste Teiler	40.0 (3.) 80.6 (5.) 88.6 (2.)			
Trefferlage	0.18 mm links, 0.51 mm tief			
Streuwert	1.17, horizontal: 1.07, vertikal: 1.25			

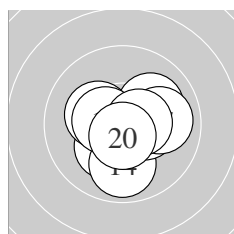

Serie 2:

10.5 *	10.1 ↗	10.2 *	9.9 ↓	10.4 *
10.3 *	10.0 →	10.5 *	10.5 *	10.6 *
beste Teiler	78.0 (20.) 108.4 (19.) 117.6 (18.)			
Trefferlage	0.30 mm rechts, 0.38 mm tief			
Streuwert	1.26, horizontal: 1.37, vertikal: 1.14			

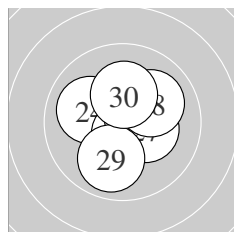

Serie 3:

10.4 *	10.9 *	10.4 *	10.0 ↖	10.6 *
10.5 *	10.3 *	10.0 ↗	9.9 ↓	10.2 *
beste Teiler	25.2 (22.) 79.6 (25.) 109.1 (26.)			
Trefferlage	0.26 mm rechts, 0.24 mm hoch			
Streuwert	1.24, horizontal: 1.22, vertikal: 1.25			

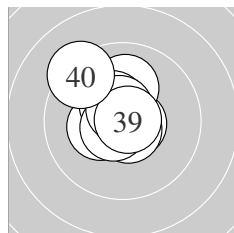

Serie 4:

10.3 *	10.7 *	10.7 *	10.5 *	10.1 ↑
10.4 *	10.7 *	10.6 *	10.8 *	9.3 ↘
beste Teiler	36.1 (39.) 68.5 (33.) 72.2 (32.)			
Trefferlage	0.45 mm links, 0.67 mm hoch			
Streuwert	1.14, horizontal: 1.04, vertikal: 1.22			

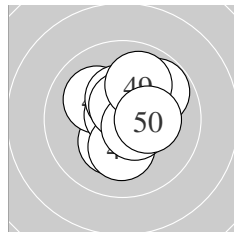

Serie 5:

10.3 *	10.1 ↖	10.8 *	10.2 *	9.8 ↗
10.4 *	10.6 *	10.6 *	9.9 ↑	10.3 *
beste Teiler	42.6 (43.) 92.0 (47.) 95.7 (48.)			
Trefferlage	0.26 mm rechts, 0.40 mm hoch			
Streuwert	1.29, horizontal: 1.19, vertikal: 1.39			

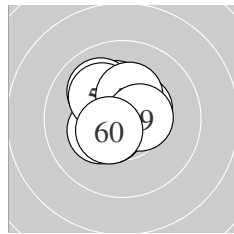

Serie 6:

10.3 *	10.3 *	10.5 *	10.4 *	10.0 ↘
10.7 *	10.1 ↖	10.3 *	10.5 *	10.5 *
beste Teiler	75.1 (56.) 106.8 (53.) 114.4 (59.)			
Trefferlage	0.33 mm links, 0.56 mm hoch			
Streuwert	1.05, horizontal: 1.04, vertikal: 1.06			

Meyton Elektronik

ISSF AR Women Jun – Wertung – Juniorinnen

StandNr: 132

Efimova, Olga #67

StartNr: 32

20. Januar 2018 9:41

RUS

Unterschrift des Schützen

Meyton Elektronik

Ergebnis: **619.8** (594)
 Serien: 102.9 103.2 103.3 103.8 102.9 103.7
 Zähler: 54 6 0 0 0 0 0 0 0 0
 Innenzehner: 45
 weiteste: 430 (1), 353 (45), 304 (17)
 beste Teiler 10.1 (39.) 38.6 (14.) 51.7 (52.)
 Trefferlage 0.04 mm rechts, 0.04 mm hoch
 Streuwert 1.25, horizontal: 1.28, vertikal: 1.21

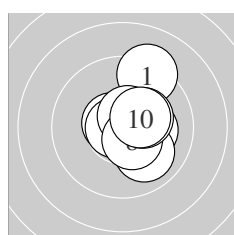
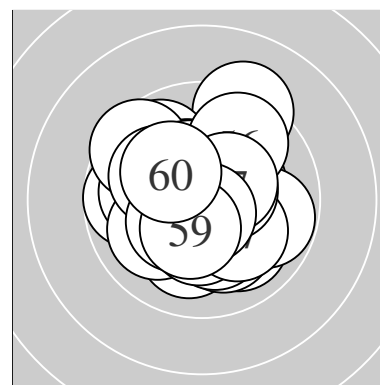

Serie 1:
 9.2 ↗ 10.2 * 10.4 * 10.0 ↘ 10.6 *
 10.7 * 10.6 * 10.5 * 10.3 * 10.4 *
 beste Teiler 52.1 (6.) 83.9 (5.) 90.8 (7.)
 Trefferlage 0.88 mm rechts, 0.25 mm hoch
 Streuwert 1.28, horizontal: 0.94, vertikal: 1.54

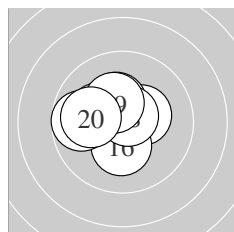

Serie 2:
 10.5 * 10.4 * 10.3 * 10.8 * 10.2 *
 10.3 * 9.7 ← 10.7 * 10.3 * 10.0 ←
 beste Teiler 38.6 (14.) 61.6 (18.) 123.0 (11.)
 Trefferlage 0.53 mm links, 0.41 mm hoch
 Streuwert 1.20, horizontal: 1.46, vertikal: 0.87

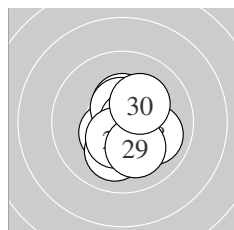

Serie 3:
 10.5 * 10.4 * 10.1 ↓ 10.4 * 10.5 *
 10.7 * 10.4 * 10.0 → 10.1 ↘ 10.2 *
 beste Teiler 53.3 (26.) 107.0 (25.) 116.1 (21.)
 Trefferlage 0.39 mm rechts, 0.29 mm tief
 Streuwert 1.15, horizontal: 1.01, vertikal: 1.28

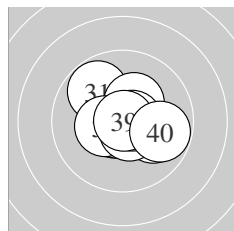

Serie 4:
 9.8 ↘ 10.6 * 10.3 * 10.7 * 10.0 →
 10.4 * 10.6 * 10.7 * 10.9 * 9.8 →
 beste Teiler 10.1 (39.) 64.5 (34.) 70.0 (38.)
 Trefferlage 0.29 mm rechts, 0.01 mm tief
 Streuwert 1.25, horizontal: 1.45, vertikal: 1.01

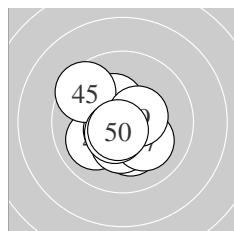

Serie 5:
 10.2 * 10.4 * 10.0 ↙ 10.6 * 9.5 ↖
 10.3 * 10.1 ↘ 10.6 * 10.5 * 10.7 *
 beste Teiler 68.9 (50.) 87.2 (44.) 99.8 (48.)
 Trefferlage 0.38 mm links, 0.39 mm tief
 Streuwert 1.31, horizontal: 1.31, vertikal: 1.32

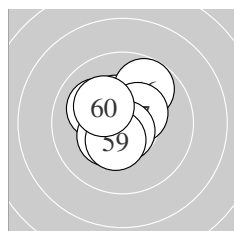

Serie 6:
 10.4 * 10.7 * 10.1 ↖ 10.6 * 10.4 *
 9.8 ↗ 10.4 * 10.7 * 10.4 * 10.2 *
 beste Teiler 51.7 (52.) 60.8 (58.) 90.4 (54.)
 Trefferlage 0.37 mm links, 0.32 mm hoch
 Streuwert 1.15, horizontal: 1.08, vertikal: 1.22

Meyton Elektronik

ISSF AR Women Jun – Wertung – Juniorinnen

StartNr: 33

StandNr: 133

20. Januar 2018 9:36

Engler, Tal #68

ISR

Unterschrift des Schützen

Meyton Elektronik

Ergebnis: **611.4** (582)
 Serien: 101.4 103.6 103.3 100.3 101.2 101.6
 Zähler: 43 16 1 0 0 0 0 0 0
 Innenzehner: 33
 weiteste: 627 (6), 445 (36), 381 (47)
 beste Teiler 13.0 (31.) 18.2 (3.) 43.3 (46.)
 Trefferlage 0.41 mm links, 0.08 mm tief
 Streuwert 1.55, horizontal: 1.84, vertikal: 1.20

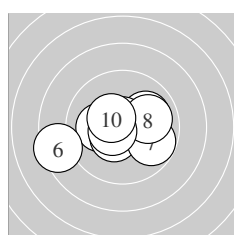
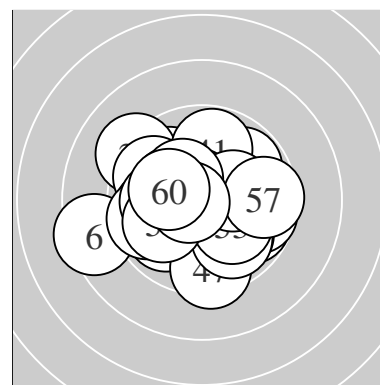

Serie 1:
 10.0 → 10.7 * 10.9 * 10.1 ← 10.5 *
 8.4 ← 9.8 ↘ 10.0 → 10.6 * 10.4 *
 beste Teiler 18.2 (3.) 56.0 (2.) 100.6 (9.)
 Trefferlage 0.38 mm links, 0.13 mm tief
 Streuwert 1.93, horizontal: 2.54, vertikal: 1.00

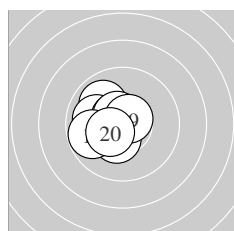

Serie 2:
 9.9 ↘ 10.5 * 10.4 * 10.0 ← 10.7 *
 10.6 * 10.6 * 9.8 ← 10.7 * 10.4 *
 beste Teiler 57.2 (15.) 73.6 (19.) 90.6 (16.)
 Trefferlage 1.05 mm links, 0.15 mm hoch
 Streuwert 0.98, horizontal: 1.02, vertikal: 0.94

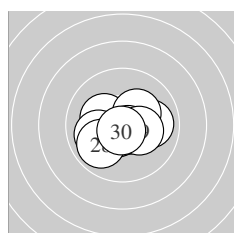

Serie 3:
 10.5 * 10.0 → 10.7 * 10.2 * 10.0 ←
 10.3 * 10.7 * 9.9 ↙ 10.3 * 10.7 *
 beste Teiler 51.6 (30.) 66.6 (27.) 74.3 (23.)
 Trefferlage 0.14 mm links, 0.36 mm tief
 Streuwert 1.26, horizontal: 1.59, vertikal: 0.80

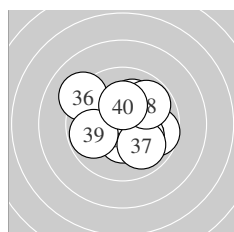

Serie 4:
 10.9 * 10.1 ↑ 9.7 → 10.2 * 10.4 *
 9.2 ↘ 9.9 ↘ 9.8 ↗ 9.8 ← 10.3 *
 beste Teiler 13.0 (31.) 135.0 (35.) 173.0 (40.)
 Trefferlage 0.32 mm rechts, 0.20 mm hoch
 Streuwert 1.88, horizontal: 2.10, vertikal: 1.63

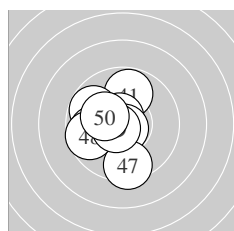

Serie 5:
 9.8 ↑ 10.2 * 10.7 * 9.8 ↘ 9.9 ←
 10.8 * 9.4 ↓ 9.7 ← 10.7 * 10.2 *
 beste Teiler 43.3 (46.) 68.4 (43.) 71.5 (49.)
 Trefferlage 1.17 mm links, 0.11 mm tief
 Streuwert 1.56, horizontal: 1.39, vertikal: 1.71

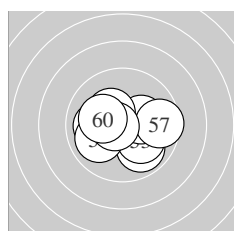

Serie 6:
 9.9 ↘ 10.6 * 10.1 ↘ 10.2 * 10.0 ←
 10.0 ← 9.6 → 10.3 * 10.7 * 10.2 *
 beste Teiler 73.1 (59.) 81.2 (52.) 157.0 (58.)
 Trefferlage 0.04 mm links, 0.25 mm tief
 Streuwert 1.57, horizontal: 1.99, vertikal: 0.99

ISSF AR Women Jun – Wertung – Juniorinnen

StandNr: 134

Fölzer, Verona #69

StartNr: 34

20. Januar 2018 9:35

AUT

Unterschrift des Schützen

Meyton Elektronik

Ergebnis:	616.3	(589)							
Serien:	105.2	103.9	101.3	103.9	101.5	100.5			
Zähler:	49	11	0	0	0	0	0	0	0
Innenzehner:	41								
weiteste:	399 (60), 336 (49), 322 (59)								
beste Teiler	10.7 (6.)	45.0 (34.)	46.5 (48.)						
Trefferlage	0.00 mm , 0.14 mm hoch								
Streuwert	1.35, horizontal: 1.45, vertikal: 1.24								

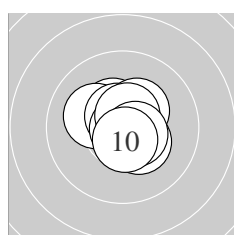
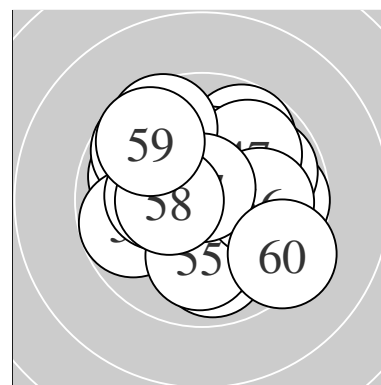

Serie 1:	10.4 *	10.4 *	10.5 *	10.2 *	10.6 *
	10.9 *	10.4 *	10.6 *	10.6 *	10.6 *
beste Teiler	10.7 (6.)	86.3 (5.)	86.5 (8.)		
Trefferlage	0.12 mm rechts, 0.29 mm hoch				
Streuwert	0.86, horizontal: 0.91, vertikal: 0.82				

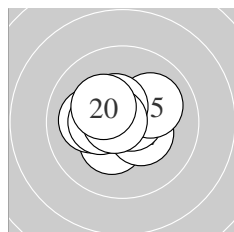

Serie 2:	10.3 *	10.4 *	10.7 *	10.5 *	10.1 ↗
	10.5 *	10.1 ←	10.3 *	10.7 *	10.3 *
beste Teiler	55.9 (19.)	64.0 (13.)	115.7 (14.)		
Trefferlage	0.39 mm links, 0.24 mm hoch				
Streuwert	1.07, horizontal: 1.28, vertikal: 0.82				

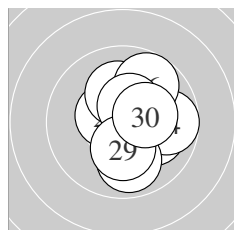

Serie 3:	10.1 →	10.1 ↘	10.5 *	9.7 →	10.2 *
	9.8 ↗	10.5 *	9.9 ↓	10.2 *	10.3 *
beste Teiler	112.8 (23.)	121.3 (27.)	162.2 (30.)		
Trefferlage	0.99 mm rechts, 0.19 mm hoch				
Streuwert	1.43, horizontal: 1.28, vertikal: 1.57				

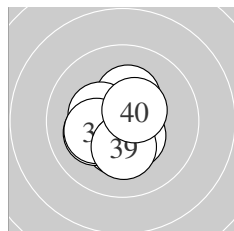

Serie 4:	10.5 *	10.6 *	10.3 *	10.8 *	10.3 *
	10.4 *	10.1 ←	10.2 *	10.2 *	10.5 *
beste Teiler	45.0 (34.)	95.5 (32.)	111.1 (40.)		
Trefferlage	0.33 mm links, 0.22 mm tief				
Streuwert	1.07, horizontal: 1.05, vertikal: 1.09				

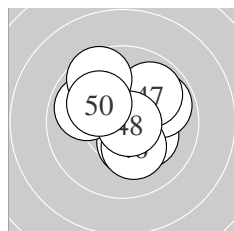

Serie 5:	10.4 *	10.2 *	9.8 ↗	10.6 *	9.9 ↖
	10.2 *	9.9 ↗	10.8 *	9.6 ↘	10.1 ↖
beste Teiler	46.5 (48.)	78.5 (44.)	147.6 (41.)		
Trefferlage	0.18 mm rechts, 0.48 mm hoch				
Streuwert	1.57, horizontal: 1.65, vertikal: 1.49				

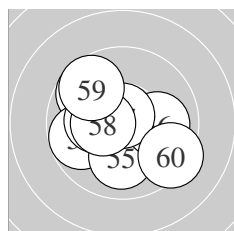

Serie 6:	9.7 ↘	10.5 *	9.8 ←	10.2 *	10.0 ↓
	10.0 →	10.8 *	10.4 *	9.7 ↘	9.4 ↘
beste Teiler	50.1 (57.)	108.8 (52.)	135.0 (58.)		
Trefferlage	0.53 mm links, 0.15 mm tief				
Streuwert	1.82, horizontal: 2.03, vertikal: 1.57				

ISSF AR Women Jun – Wertung – Juniorinnen

StandNr: 135

Fricke, Barbara #70

StartNr: 35

20. Januar 2018 9:50

BAY – Schwaben

Unterschrift des Schützen

Meyton Elektronik

Ergebnis: **0.0** (0)_{DNS}
 Serien:
 Zähler: 0 0 0 0 0 0 0 0 0 0
 Innenzehner: 0
 weiteste:
 beste Teiler – Schütze ist nicht zum Wettkampf angetreten
 Trefferlage 0.00 mm , 0.00 mm
 Streuwert
 Unterschrift des Schützen

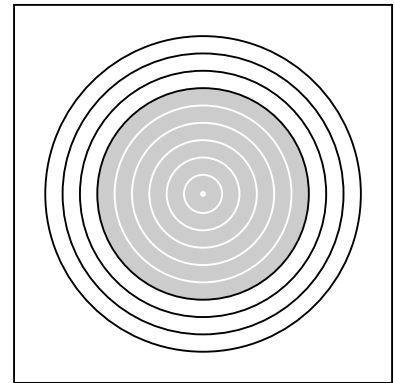

Ergebnis: **596.2** (576)

Serien: 98.7 101.2 97.9 97.0 100.1 101.3

Zähler: 40 16 4 0 0 0 0 0 0

Innenzehner: 27

weiteste: 739 (22), 668 (38), 663 (50)

beste Teiler 59.8 (17.) 59.9 (20.) 62.1 (25.)

Trefferlage 0.54 mm rechts, 0.24 mm hoch

Streuwert 2.10, horizontal: 1.92, vertikal: 2.26

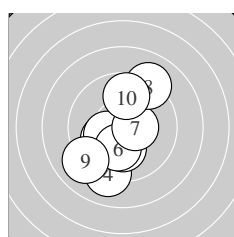
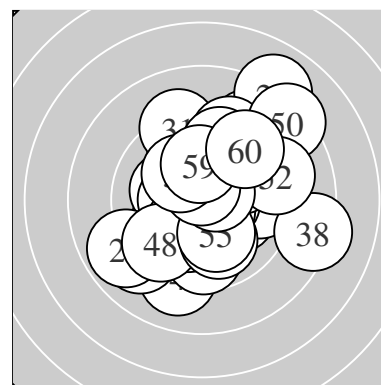

Serie 1:

10.6 *	10.1 ↖	10.3 *	9.1 ↓	10.1 ↓
10.2 *	10.5 *	9.1 ↗	9.0 ↖	9.7 ↑

beste Teiler 97.8 (1.) 122.0 (7.) 166.8 (3.)

Trefferlage 0.52 mm links, 0.72 mm tief

Streuwert 2.18, horizontal: 1.69, vertikal: 2.57

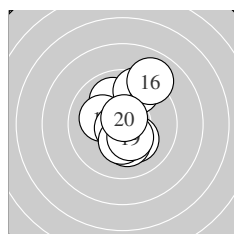

Serie 2:

10.0 ↖	9.6 ↗	10.1 ↖	10.2 *	10.2 *
9.0 ↗	10.7 *	10.3 *	10.4 *	10.7 *

beste Teiler 59.8 (17.) 59.9 (20.) 145.6 (19.)

Trefferlage 0.30 mm rechts, 0.42 mm hoch

Streuwert 1.77, horizontal: 1.30, vertikal: 2.14

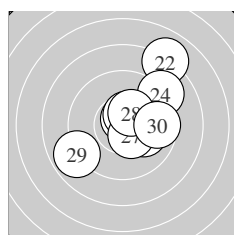

Serie 3:

10.1 ↘	8.0 ↗	10.2 *	9.1 ↗	10.7 *
10.5 *	10.4 *	10.4 *	8.9 ↖	9.6 →

beste Teiler 62.1 (25.) 107.2 (26.) 127.6 (27.)

Trefferlage 1.25 mm rechts, 0.79 mm hoch

Streuwert 2.43, horizontal: 2.44, vertikal: 2.43

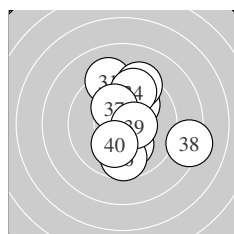

Serie 4:

9.2 ↖	10.0 ↗	9.3 ↗	9.6 ↗	10.1 ↓
9.7 ↓	10.2 *	8.3 ↘	10.5 *	10.1 ↓

beste Teiler 111.7 (39.) 179.7 (37.) 207.2 (40.)

Trefferlage 0.93 mm rechts, 0.54 mm hoch

Streuwert 2.45, horizontal: 2.18, vertikal: 2.69

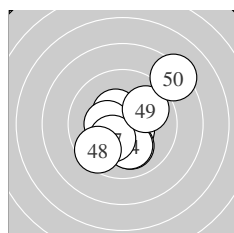

Serie 5:

10.5 *	10.5 *	10.1 ↓	10.1 ↓	10.4 *
10.4 *	10.3 *	9.6 ↖	9.9 ↗	8.3 ↗

beste Teiler 102.2 (42.) 110.0 (41.) 130.5 (45.)

Trefferlage 0.43 mm rechts, 0.25 mm tief

Streuwert 2.09, horizontal: 2.06, vertikal: 2.13

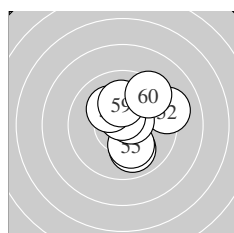

Serie 6:

10.5 *	9.2 →	10.6 *	10.0 ↓	10.1 ↓
10.6 *	10.6 *	10.2 *	10.1 ↑	9.4 ↗

beste Teiler 77.1 (57.) 90.3 (56.) 96.0 (53.)

Trefferlage 0.84 mm rechts, 0.67 mm hoch

Streuwert 1.59, horizontal: 1.55, vertikal: 1.64

Meyton Elektronik

ISSF AR Women Jun – Wertung – Juniorinnen

StandNr: 137

Graf, Melissa #72

StartNr: 37

20. Januar 2018 9:33

BAY – Schwaben

Unterschrift des Schützen

Meyton Elektronik

Ergebnis: **617.3** (589)
 Serien: 104.1 101.7 101.5 101.9 104.4 103.7
 Zähler: 49 11 0 0 0 0 0 0 0
 Innenzehner: 44
 weiteste: 392 (28), 381 (11), 363 (38)
 beste Teiler 20.5 (47.) 28.0 (23.) 38.4 (43.)
 Trefferlage 0.40 mm links, 0.27 mm hoch
 Streuwert 1.30, horizontal: 1.54, vertikal: 1.00

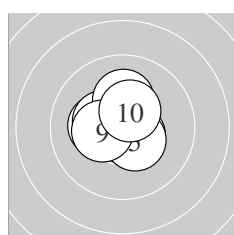
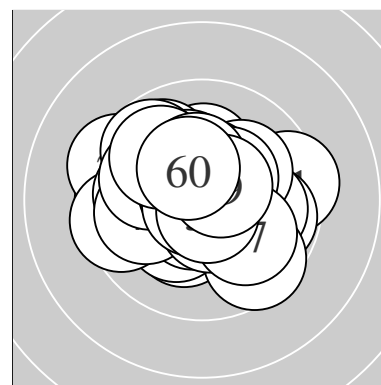

Serie 1:
 10.7 * 10.5 * 10.4 * 10.4 * 10.4 *
 10.3 * 10.4 * 10.2 * 10.4 * 10.4 *
 beste Teiler 55.5 (1.) 103.7 (2.) 129.3 (10.)
 Trefferlage 0.33 mm links, 0.25 mm hoch
 Streuwert 1.00, horizontal: 1.04, vertikal: 0.96

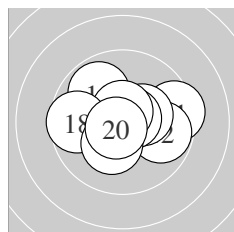

Serie 2:
 9.4 → 9.8 → 10.3 * 10.4 * 9.9 ↖
 10.7 * 10.6 * 9.6 ← 10.3 * 10.7 *
 beste Teiler 63.7 (20.) 63.9 (16.) 78.1 (17.)
 Trefferlage 0.08 mm rechts, 0.16 mm hoch
 Streuwert 1.66, horizontal: 2.12, vertikal: 1.00

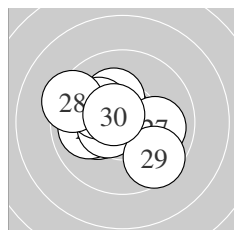

Serie 3:
 10.2 * 10.0 ← 10.8 * 10.5 * 10.2 *
 10.2 * 10.0 → 9.4 ↖ 9.6 ↘ 10.6 *
 beste Teiler 28.0 (23.) 83.7 (30.) 112.5 (24.)
 Trefferlage 0.72 mm links, 0.08 mm hoch
 Streuwert 1.61, horizontal: 1.91, vertikal: 1.23

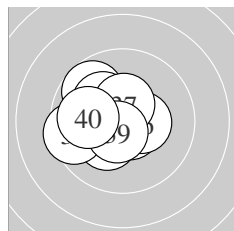

Serie 4:
 10.2 * 10.3 * 9.7 ↖ 10.6 * 10.2 *
 10.4 * 10.5 * 9.5 ← 10.6 * 9.9 ←
 beste Teiler 76.4 (34.) 88.5 (39.) 122.3 (37.)
 Trefferlage 1.09 mm links, 0.23 mm hoch
 Streuwert 1.33, horizontal: 1.48, vertikal: 1.16

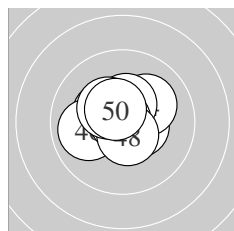

Serie 5:
 10.3 * 10.5 * 10.8 * 10.1 ↗ 10.4 *
 9.9 ← 10.9 * 10.6 * 10.4 * 10.5 *
 beste Teiler 20.5 (47.) 38.4 (43.) 99.1 (48.)
 Trefferlage 0.20 mm links, 0.37 mm hoch
 Streuwert 1.03, horizontal: 1.22, vertikal: 0.78

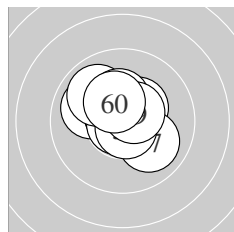

Serie 6:
 10.0 ↖ 10.4 * 10.7 * 10.8 * 9.9 ↖
 10.3 * 10.0 ↘ 10.7 * 10.5 * 10.4 *
 beste Teiler 42.5 (54.) 55.9 (58.) 66.6 (53.)
 Trefferlage 0.17 mm links, 0.55 mm hoch
 Streuwert 1.15, horizontal: 1.26, vertikal: 1.03

Meyton Elektronik

ISSF AR Women Jun – Wertung – Juniorinnen

StandNr: 138

Burtscher, Jaqueline #73

StartNr: 38

20. Januar 2018 9:51

VSBL NWLZ

Unterschrift des Schützen

Meyton Elektronik

Ergebnis: **614.2** (588)
 Serien: 101.6 102.3 101.5 102.2 102.1 104.5
 Zähler: 48 12 0 0 0 0 0 0 0
 Innenzehner: 36
 weiteste: 376 (14), 347 (20), 345 (3)
 beste Teiler 13.4 (31.) 61.5 (2.) 62.3 (55.)
 Trefferlage 0.07 mm links, 0.26 mm hoch
 Streuwert 1.39, horizontal: 1.55, vertikal: 1.21

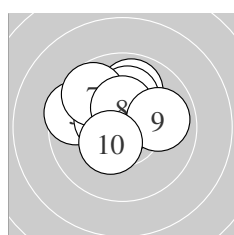
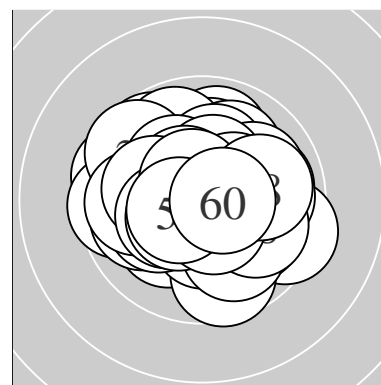

Serie 1:
 10.5 * 10.7 * 9.6 ↖ 9.9 ↑ 10.4 *
 10.1 ↑ 9.7 ↘ 10.4 * 9.9 → 10.4 *
 beste Teiler 61.5 (2.) 117.4 (1.) 130.2 (5.)
 Trefferlage 0.45 mm links, 1.06 mm hoch
 Streuwert 1.37, horizontal: 1.60, vertikal: 1.08

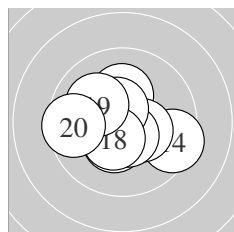

Serie 2:
 10.2 * 10.4 * 10.7 * 9.4 ↗ 10.4 *
 10.6 * 10.5 * 10.4 * 10.1 ↖ 9.6 ←
 beste Teiler 66.6 (13.) 99.6 (16.) 102.0 (17.)
 Trefferlage 0.24 mm links, 0.12 mm tief
 Streuwert 1.53, horizontal: 1.83, vertikal: 1.15

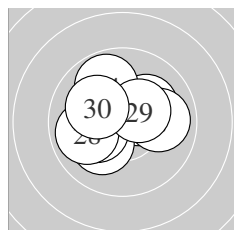

Serie 3:
 10.5 * 10.2 * 10.4 * 9.8 ↖ 10.1 ↙
 10.2 * 9.9 → 9.9 ← 10.4 * 10.1 ↖
 beste Teiler 123.7 (21.) 128.7 (23.) 140.9 (29.)
 Trefferlage 0.11 mm links, 0.41 mm hoch
 Streuwert 1.50, horizontal: 1.79, vertikal: 1.14

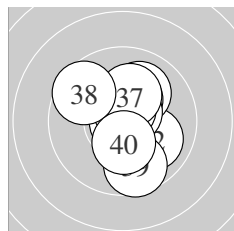

Serie 4:
 10.9 * 10.0 ↘ 10.0 ↗ 10.3 * 10.6 *
 10.6 * 10.2 * 9.6 ↖ 9.7 ↓ 10.3 *
 beste Teiler 13.4 (31.) 85.0 (35.) 86.9 (36.)
 Trefferlage 0.31 mm rechts, 0.28 mm hoch
 Streuwert 1.51, horizontal: 1.24, vertikal: 1.75

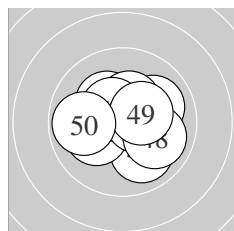

Serie 5:
 10.0 → 10.3 * 10.0 ↘ 10.1 ← 10.4 *
 10.5 * 10.5 * 10.0 ↘ 10.4 * 9.9 ←
 beste Teiler 103.1 (47.) 115.8 (46.) 143.5 (45.)
 Trefferlage 0.21 mm rechts, 0.13 mm hoch
 Streuwert 1.46, horizontal: 1.72, vertikal: 1.15

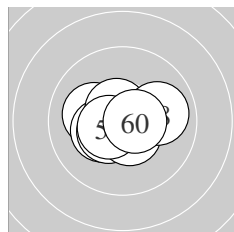

Serie 6:
 10.1 ↖ 10.7 * 10.3 * 10.5 * 10.7 *
 10.5 * 10.6 * 10.0 → 10.5 * 10.6 *
 beste Teiler 62.3 (55.) 69.1 (52.) 87.0 (60.)
 Trefferlage 0.17 mm links, 0.15 mm tief
 Streuwert 1.02, horizontal: 1.31, vertikal: 0.60

Meyton Elektronik

ISSF AR Women Jun – Wertung – Juniorinnen

StandNr: 139

Hafner, Lisa #74

StartNr: 39

20. Januar 2018 9:39

T – SG Umhausen

Unterschrift des Schützen

Meyton Elektronik

Ergebnis: **612.1** (590)

Serien: 101.4 101.0 104.5 103.0 100.5 101.7

Zähler: 51 8 1 0 0 0 0 0 0

Innenzehner: 38

weiteste: 590 (45), 452 (38), 381 (9)

beste Teiler 31.3 (29.) 43.0 (36.) 54.4 (27.)

Trefferlage 0.01 mm links, 0.12 mm hoch

Streuwert 1.53, horizontal: 1.81, vertikal: 1.19

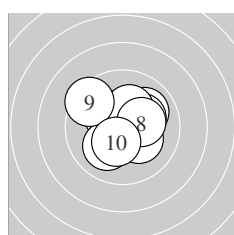
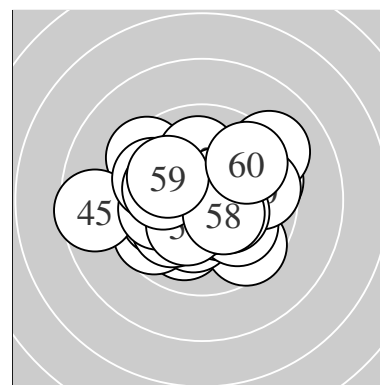

Serie 1:

10.3 *	10.3 *	10.0 ↗	10.1 ↙	10.2 *
10.3 *	10.2 *	10.2 *	9.4 ↘	10.4 *

beste Teiler 145.4 (10.) 154.0 (2.) 173.2 (1.)

Trefferlage 0.01 mm rechts, 0.24 mm hoch

Streuwert 1.59, horizontal: 1.72, vertikal: 1.44

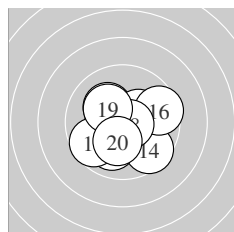

Serie 2:

10.2 *	10.0 ↙	10.5 *	9.6 ↘	10.3 *
9.6 →	9.7 ↙	10.7 *	10.2 *	10.2 *

beste Teiler 64.8 (18.) 121.0 (13.) 162.8 (15.)

Trefferlage 0.02 mm links, 0.39 mm tief

Streuwert 1.72, horizontal: 1.90, vertikal: 1.52

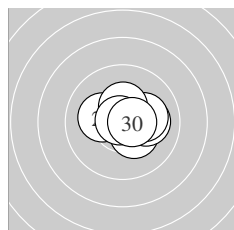

Serie 3:

10.4 *	10.6 *	10.5 *	10.1 →	10.2 *
10.2 *	10.7 *	10.4 *	10.8 *	10.6 *

beste Teiler 31.3 (29.) 54.4 (27.) 87.0 (30.)

Trefferlage 0.44 mm rechts, 0.30 mm hoch

Streuwert 0.96, horizontal: 1.20, vertikal: 0.65

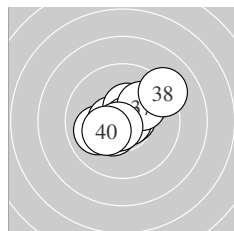

Serie 4:

10.6 *	10.4 *	10.0 ↙	10.6 *	10.4 *
10.8 *	10.1 ↗	9.1 ↗	10.7 *	10.3 *

beste Teiler 43.0 (36.) 64.8 (39.) 81.3 (31.)

Trefferlage 0.10 mm rechts, 0.23 mm hoch

Streuwert 1.47, horizontal: 1.72, vertikal: 1.18

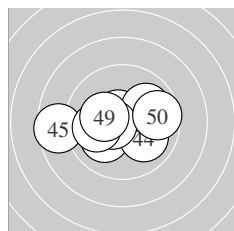

Serie 5:

10.6 *	10.1 ↙	10.6 *	10.0 ↘	8.6 ←
10.0 ↗	10.6 *	10.0 ←	10.3 *	9.7 →

beste Teiler 78.7 (41.) 80.2 (43.) 96.0 (47.)

Trefferlage 0.48 mm links, 0.09 mm tief

Streuwert 1.98, horizontal: 2.65, vertikal: 0.91

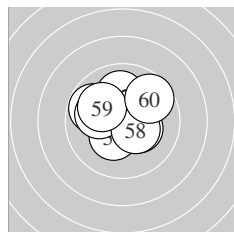

Serie 6:

9.8 ↘	10.3 *	10.0 ↑	10.5 *	10.6 *
10.3 *	10.1 ←	10.4 *	10.0 ↘	9.7 ↗

beste Teiler 85.0 (55.) 107.6 (54.) 140.1 (58.)

Trefferlage 0.17 mm links, 0.44 mm hoch

Streuwert 1.51, horizontal: 1.70, vertikal: 1.29

Meyton Elektronik

ISSF AR Women Jun – Wertung – Juniorinnen

StandNr: 140

Haselsberger, Carmen #75

StartNr: 40

20. Januar 2018 9:45

AUT

Unterschrift des Schützen

Meyton Elektronik

Ergebnis:	623.7	(593) ^{QF}							
Serien:	104.0	103.9	105.3	104.6	102.4	103.5			
Zähler:	53	7	0	0	0	0	0	0	0
Innenzehner:	45								
weiteste:	327 (19), 316 (52), 281 (46)								
beste Teiler	9.2 (11.)	12.1 (60.)	19.1 (15.)						
Trefferlage	0.25 mm links, 0.13 mm hoch								
Streuwert	1.13, horizontal: 1.23, vertikal: 1.02								

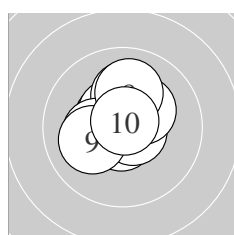
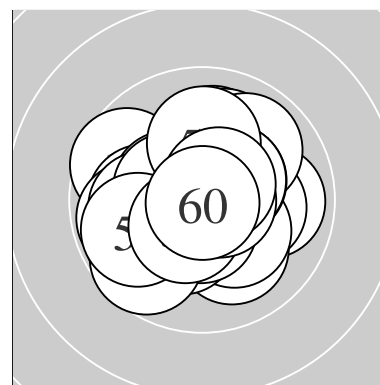

Serie 1:	10.7 *	10.5 *	10.5 *	10.1 ↑	10.3 *
	10.7 *	10.3 *	10.0 ↑	10.1 ←	10.8 *
beste Teiler	43.3 (10.)	64.4 (1.)	73.1 (6.)		
Trefferlage	0.27 mm links, 0.53 mm hoch				
Streuwert	1.06, horizontal: 1.04, vertikal: 1.08				

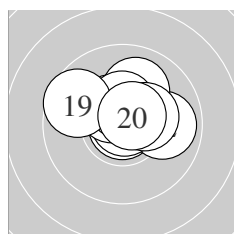

Serie 2:	10.9 *	9.9 →	10.0 ↑	10.7 *	10.9 *
	10.5 *	10.5 *	10.3 *	9.6 ↘	10.6 *
beste Teiler	9.2 (11.)	19.1 (15.)	63.9 (14.)		
Trefferlage	0.21 mm rechts, 0.74 mm hoch				
Streuwert	1.14, horizontal: 1.45, vertikal: 0.71				

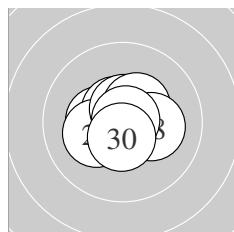

Serie 3:	10.3 *	10.6 *	10.8 *	10.7 *	10.2 *
	10.6 *	10.4 *	10.2 *	10.9 *	10.6 *
beste Teiler	24.4 (29.)	48.3 (23.)	63.2 (24.)		
Trefferlage	0.00 mm , 0.13 mm hoch				
Streuwert	0.89, horizontal: 1.06, vertikal: 0.68				

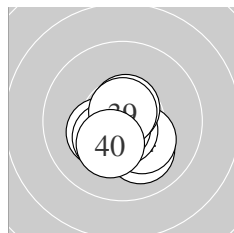

Serie 4:	10.1 ↘	10.7 *	10.3 *	10.2 *	10.7 *
	10.7 *	10.6 *	10.3 *	10.7 *	10.3 *
beste Teiler	58.7 (36.)	61.0 (39.)	62.3 (35.)		
Trefferlage	0.15 mm links, 0.63 mm tief				
Streuwert	0.88, horizontal: 0.90, vertikal: 0.86				

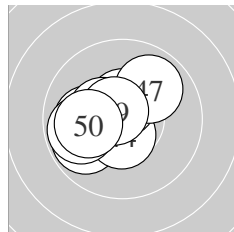

Serie 5:	10.8 *	9.8 ←	10.0 ←	10.5 *	10.5 *
	9.8 ←	9.9 ↗	10.4 *	10.7 *	10.0 ←
beste Teiler	46.5 (41.)	75.6 (49.)	104.1 (44.)		
Trefferlage	1.01 mm links, 0.01 mm hoch				
Streuwert	1.24, horizontal: 1.43, vertikal: 1.02				

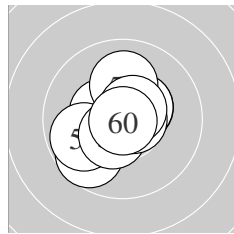

Serie 6:	10.4 *	9.7 ↙	9.8 ←	10.4 *	10.5 *
	10.4 *	10.7 *	10.1 ↑	10.6 *	10.9 *
beste Teiler	12.1 (60.)	68.0 (57.)	90.5 (59.)		
Trefferlage	0.30 mm links, 0.01 mm hoch				
Streuwert	1.29, horizontal: 1.32, vertikal: 1.27				

Meyton Elektronik

ISSF AR Women Jun – Wertung – Juniorinnen

StartNr: 41

StandNr: 141

20. Januar 2018 9:52

Henry, Angeline #76

USA

QF – Schütze hat sich fürs Finale qualifiziert

Unterschrift des Schützen

Meyton Elektronik

Ergebnis:	623.4	(595) ^{QF}							
Serien:	103.8	103.5	105.3	102.6	104.7	103.5			
Zähler:	55	5	0	0	0	0	0	0	0
Innenzehner:	51								
weiteste:	314 (32), 281 (59), 278 (3)								
beste Teiler	20.3 (1.)	21.1 (52.)	23.8 (44.)						
Trefferlage	0.26 mm rechts, 0.08 mm hoch								
Streuwert	1.10, horizontal: 1.08, vertikal: 1.12								

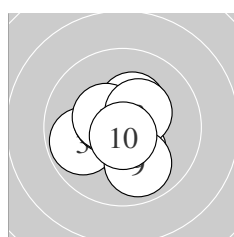
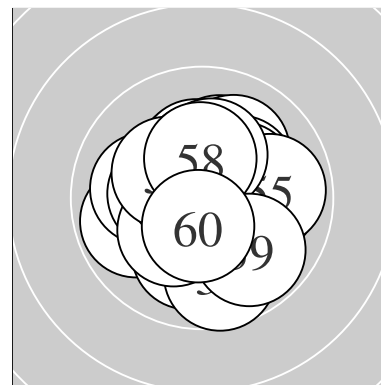

Serie 1:	10.9 *	10.3 *	9.8 ←	10.6 *	10.3 *
	10.5 *	10.4 *	10.4 *	9.9 ↓	10.7 *
beste Teiler	20.3 (1.)	57.0 (10.)	85.8 (4.)		
Trefferlage	0.09 mm links, 0.12 mm tief				
Streuwert	1.19, horizontal: 1.17, vertikal: 1.22				

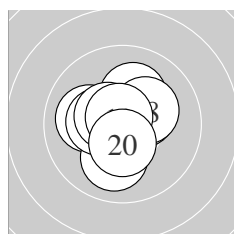

Serie 2:	10.0 ←	10.7 *	10.0 ↓	10.3 *	10.4 *
	10.2 *	10.5 *	10.2 *	10.7 *	10.5 *
beste Teiler	52.7 (19.)	66.4 (12.)	112.7 (17.)		
Trefferlage	0.27 mm links, 0.14 mm hoch				
Streuwert	1.17, horizontal: 1.19, vertikal: 1.14				

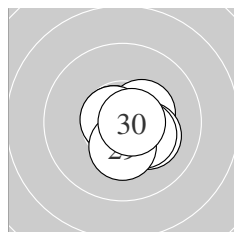

Serie 3:	10.7 *	10.6 *	10.7 *	10.7 *	10.4 *
	10.2 *	10.7 *	10.3 *	10.3 *	10.7 *
beste Teiler	57.8 (23.)	61.0 (30.)	61.4 (27.)		
Trefferlage	0.55 mm rechts, 0.34 mm tief				
Streuwert	0.72, horizontal: 0.77, vertikal: 0.67				

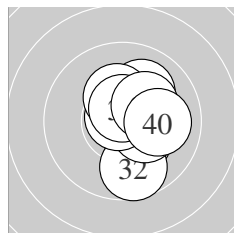

Serie 4:	10.3 *	9.7 ↓	10.3 *	10.8 *	10.3 *
	10.1 ↗	10.3 *	10.6 *	10.2 *	10.0 →
beste Teiler	40.3 (34.)	85.0 (38.)	156.0 (35.)		
Trefferlage	0.86 mm rechts, 0.18 mm hoch				
Streuwert	1.23, horizontal: 0.87, vertikal: 1.50				

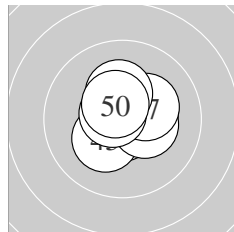

Serie 5:	10.4 *	10.3 *	10.7 *	10.9 *	10.3 *
	10.3 *	10.3 *	10.3 *	10.7 *	10.5 *
beste Teiler	23.8 (44.)	55.1 (43.)	75.1 (49.)		
Trefferlage	0.32 mm rechts, 0.20 mm hoch				
Streuwert	0.96, horizontal: 1.04, vertikal: 0.86				

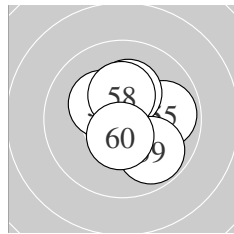

Serie 6:	10.4 *	10.9 *	10.4 *	10.8 *	9.9 →
	10.3 *	10.2 *	10.3 *	9.8 ↓	10.5 *
beste Teiler	21.1 (52.)	45.1 (54.)	114.1 (60.)		
Trefferlage	0.22 mm rechts, 0.44 mm hoch				
Streuwert	1.22, horizontal: 1.20, vertikal: 1.24				

ISSF AR Women Jun – Wertung – Juniorinnen

StartNr: 42

StandNr: 142

20. Januar 2018 9:16

Dereviagina, Anastasiia #77

RUS

QF – Schütze hat sich fürs Finale qualifiziert

Unterschrift des Schützen

Meyton Elektronik

Ergebnis: **617.1** (589)
 Serien: 101.4 103.7 103.0 101.4 103.6 104.0
 Zähler: 49 11 0 0 0 0 0 0 0
 Innenzehner: 39
 weiteste: 486 (33), 413 (8), 385 (48)
 beste Teiler 19.1 (27.) 31.0 (57.) 34.7 (12.)
 Trefferlage 0.20 mm rechts, 0.50 mm hoch
 Streuwert 1.32, horizontal: 1.35, vertikal: 1.29

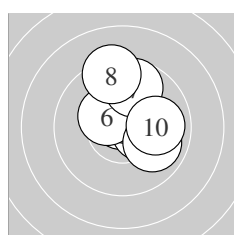
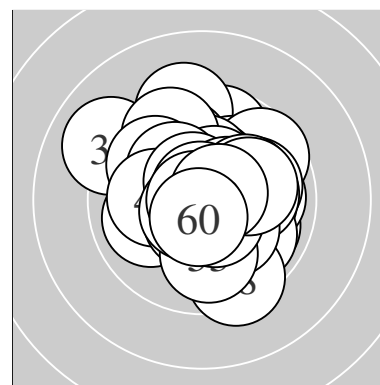

Serie 1:
 10.7 * 10.4 * 10.5 * 10.4 * 10.2 *
 10.4 * 9.7 ↑ 9.3 ↑ 9.9 ↘ 9.9 →
 beste Teiler 54.9 (1.) 105.0 (3.) 130.8 (4.)
 Trefferlage 0.67 mm rechts, 1.08 mm hoch
 Streuwert 1.38, horizontal: 1.20, vertikal: 1.54

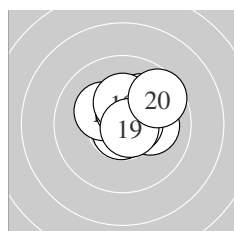

Serie 2:
 10.1 ↗ 10.8 * 10.1 → 10.8 * 10.6 *
 10.2 * 10.5 * 10.3 * 10.7 * 9.6 ↗
 beste Teiler 34.7 (12.) 48.2 (14.) 60.4 (19.)
 Trefferlage 0.64 mm rechts, 0.66 mm hoch
 Streuwert 1.05, horizontal: 1.19, vertikal: 0.90

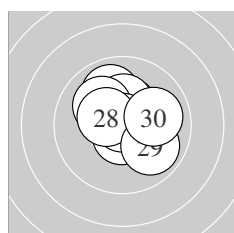

Serie 3:
 9.9 ↖ 10.5 * 10.4 * 10.3 * 10.1 ↖
 10.6 * 10.9 * 10.4 * 9.9 ↘ 10.0 →
 beste Teiler 19.1 (27.) 78.4 (26.) 102.1 (22.)
 Trefferlage 0.14 mm rechts, 0.69 mm hoch
 Streuwert 1.24, horizontal: 1.29, vertikal: 1.18

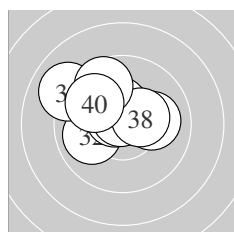

Serie 4:
 10.6 * 10.0 ← 9.0 ↘ 10.1 → 10.6 *
 10.4 * 10.7 * 10.4 * 9.7 ↖ 9.9 ↘
 beste Teiler 54.8 (37.) 77.4 (35.) 100.4 (31.)
 Trefferlage 0.75 mm links, 1.03 mm hoch
 Streuwert 1.53, horizontal: 1.86, vertikal: 1.10

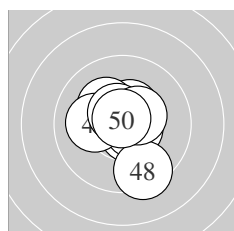

Serie 5:
 10.5 * 10.6 * 10.4 * 10.6 * 10.2 *
 10.1 ← 10.6 * 9.4 ↓ 10.4 * 10.8 *
 beste Teiler 43.9 (50.) 83.0 (42.) 91.0 (44.)
 Trefferlage 0.02 mm links, 0.08 mm hoch
 Streuwert 1.30, horizontal: 1.16, vertikal: 1.42

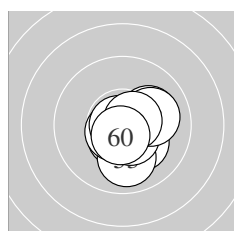

Serie 6:
 10.5 * 10.2 * 10.0 ↓ 10.1 → 10.5 *
 10.6 * 10.8 * 10.1 → 10.6 * 10.6 *
 beste Teiler 31.0 (57.) 80.6 (60.) 82.4 (56.)
 Trefferlage 0.55 mm rechts, 0.51 mm tief
 Streuwert 0.99, horizontal: 0.99, vertikal: 0.98

Meyton Elektronik

ISSF AR Women Jun – Wertung – Juniorinnen

StartNr: 43

StandNr: 143

20. Januar 2018 9:37

Holzer, Susanne #78

ITA

Unterschrift des Schützen

Meyton Elektronik

Ergebnis:	623.3	(593) ^{QF}							
Serien:	104.6	103.0	104.2	103.4	103.3	104.8			
Zähler:	53	7	0	0	0	0	0	0	0
Innenzehner:	49								
weiteste:	447 (50), 347 (14), 282 (32)								
beste Teiler	5.3 (11.)	24.3 (5.)	25.0 (56.)						
Trefferlage	0.07 mm rechts, 0.06 mm tief								
Streuwert	1.16, horizontal: 1.17, vertikal: 1.15								

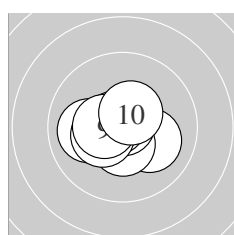
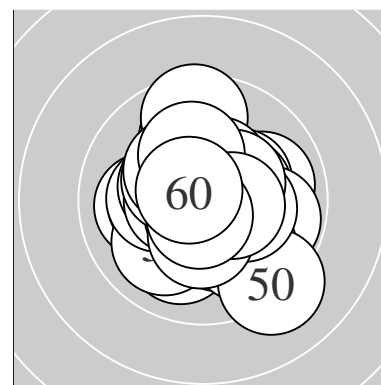

Serie 1:	10.7 *	10.4 *	10.1 ↘	10.5 *	10.9 *
	10.7 *	10.0 ←	10.4 *	10.4 *	10.5 *
beste Teiler	24.3 (5.)	52.3 (1.)	62.1 (6.)		
Trefferlage	0.40 mm links, 0.13 mm tief				
Streuwert	0.99, horizontal: 1.23, vertikal: 0.66				

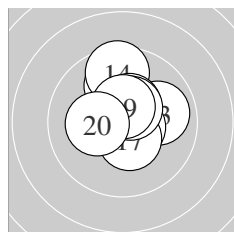

Serie 2:	10.9 *	9.9 ↑	9.9 →	9.6 ↑	10.6 *
	10.4 *	10.5 *	10.5 *	10.5 *	10.2 *
beste Teiler	5.3 (11.)	84.1 (15.)	108.0 (19.)		
Trefferlage	0.21 mm rechts, 0.83 mm hoch				
Streuwert	1.23, horizontal: 1.08, vertikal: 1.37				

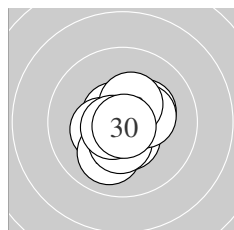

Serie 3:	10.6 *	10.3 *	10.0 ↙	10.5 *	10.4 *
	10.3 *	10.3 *	10.4 *	10.6 *	10.8 *
beste Teiler	30.6 (30.)	80.0 (29.)	81.4 (21.)		
Trefferlage	0.02 mm rechts, 0.28 mm tief				
Streuwert	1.03, horizontal: 1.00, vertikal: 1.06				

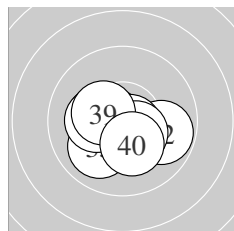

Serie 4:	10.7 *	9.8 →	10.5 *	10.7 *	10.0 ↙
	10.5 *	10.3 *	10.2 *	10.4 *	10.3 *
beste Teiler	62.8 (34.)	66.0 (31.)	106.5 (33.)		
Trefferlage	0.17 mm links, 0.54 mm tief				
Streuwert	1.19, horizontal: 1.49, vertikal: 0.77				

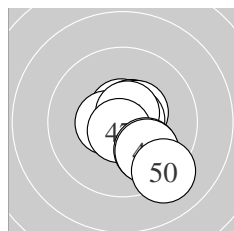

Serie 5:	10.6 *	10.5 *	10.6 *	10.5 *	10.7 *
	10.7 *	10.7 *	9.9 ↘	9.9 ↘	9.2 ↘
beste Teiler	64.2 (47.)	71.5 (46.)	73.0 (45.)		
Trefferlage	0.74 mm rechts, 0.50 mm tief				
Streuwert	1.31, horizontal: 1.13, vertikal: 1.47				

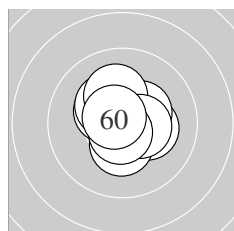

Serie 6:	10.3 *	10.4 *	10.4 *	10.4 *	10.3 *
	10.9 *	10.2 *	10.5 *	10.7 *	10.7 *
beste Teiler	25.0 (56.)	66.7 (59.)	71.8 (60.)		
Trefferlage	0.05 mm rechts, 0.26 mm hoch				
Streuwert	0.99, horizontal: 1.01, vertikal: 0.98				

Meyton Elektronik

ISSF AR Women Jun – Wertung – Juniorinnen

StandNr: 144

Ivanova, Maria #79

StartNr: 44

20. Januar 2018 9:40

RUS

QF – Schütze hat sich fürs Finale qualifiziert

Unterschrift des Schützen

Meyton Elektronik

Ergebnis: **613.8** (585)

Serien: 102.1 103.2 103.1 100.5 103.5 101.4

Zähler: 46 13 1 0 0 0 0 0 0

Innenzehner: 38

weiteste: 566 (37), 399 (58), 394 (31)

beste Teiler 30.5 (25.) 43.3 (41.) 58.8 (59.)

Trefferlage 0.06 mm rechts, 0.09 mm tief

Streuwert 1.50, horizontal: 1.40, vertikal: 1.59

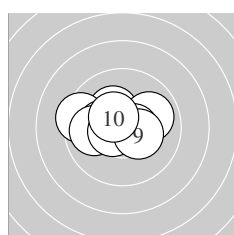
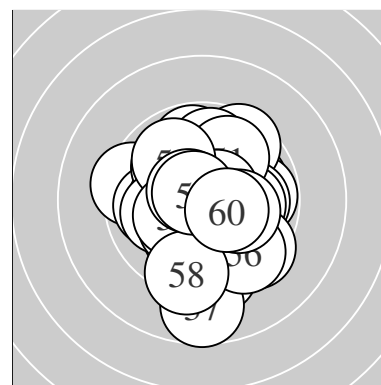

Serie 1:

10.4 *	10.3 *	9.9 ↗	9.4 ↖	10.6 *
10.2 *	9.9 ←	10.6 *	10.3 *	10.5 *

beste Teiler 96.7 (8.) 97.0 (5.) 121.8 (10.)

Trefferlage 0.46 mm links, 0.29 mm hoch

Streuwert 1.46, horizontal: 1.94, vertikal: 0.69

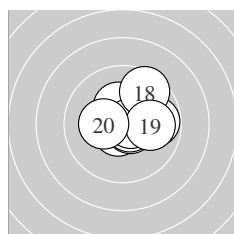

Serie 2:

10.7 *	9.8 →	10.6 *	10.7 *	10.6 *
10.3 *	10.7 *	9.5 ↗	10.0 →	10.3 *

beste Teiler 69.2 (14.) 73.3 (17.) 74.3 (11.)

Trefferlage 0.66 mm rechts, 0.43 mm hoch

Streuwert 1.27, horizontal: 1.44, vertikal: 1.08

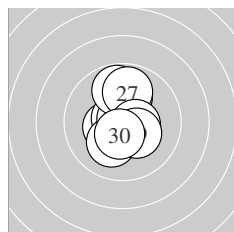

Serie 3:

10.4 *	10.7 *	10.1 ↑	10.1 ↘	10.8 *
9.8 ↑	9.9 ↑	10.5 *	10.3 *	10.5 *

beste Teiler 30.5 (25.) 66.0 (22.) 110.3 (30.)

Trefferlage 0.04 mm links, 0.38 mm hoch

Streuwert 1.31, horizontal: 0.86, vertikal: 1.64

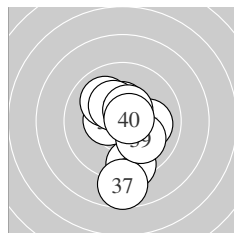

Serie 4:

9.4 ↓	10.4 *	10.4 *	10.0 ↖	10.3 *
10.0 →	8.7 ↓	10.5 *	10.1 ↘	10.7 *

beste Teiler 62.0 (40.) 109.1 (38.) 129.1 (32.)

Trefferlage 0.19 mm rechts, 0.56 mm tief

Streuwert 1.93, horizontal: 1.22, vertikal: 2.45

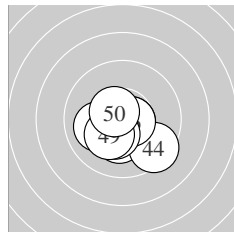

Serie 5:

10.8 *	10.7 *	10.3 *	9.4 ↘	10.4 *
10.7 *	10.1 ←	10.3 *	10.2 *	10.6 *

beste Teiler 43.3 (41.) 72.7 (46.) 73.6 (42.)

Trefferlage 0.24 mm links, 0.81 mm tief

Streuwert 1.18, horizontal: 1.38, vertikal: 0.93

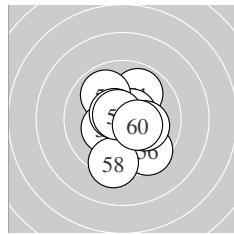

Serie 6:

9.9 ↗	10.6 *	9.9 ↖	10.3 *	10.6 *
9.5 ↘	10.1 →	9.4 ↓	10.7 *	10.4 *

beste Teiler 58.8 (59.) 88.2 (55.) 90.9 (52.)

Trefferlage 0.26 mm rechts, 0.29 mm tief

Streuwert 1.70, horizontal: 1.43, vertikal: 1.94

ISSF AR Women Jun – Wertung – Juniorinnen

StartNr: 45

StandNr: 145

20. Januar 2018 9:38

Kaps, Jessie #80

BEL

Unterschrift des Schützen

Meyton Elektronik

Ergebnis: **611.8** (583)

Serien: 100.7 104.2 101.1 102.2 102.3 101.3

Zähler: 43 17 0 0 0 0 0 0 0 0

Innenzehner: 40

weiteste: 464 (8), 440 (47), 399 (30)

beste Teiler 49.7 (58.) 59.3 (17.) 65.7 (18.)

Trefferlage 0.57 mm rechts, 0.18 mm tief

Streuwert 1.48, horizontal: 1.52, vertikal: 1.45

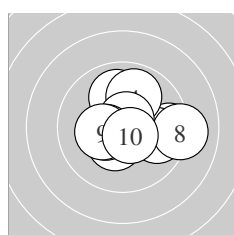
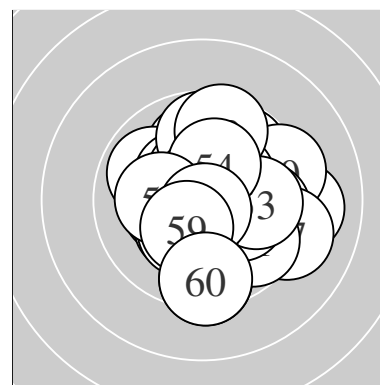

Serie 1:

9.5 →	10.0 ↑	9.8 →	9.9 ↑	10.4 *
10.7 *	10.4 *	9.1 →	10.3 *	10.6 *

beste Teiler 66.6 (6.) 90.6 (10.) 139.9 (5.)

Trefferlage 0.88 mm rechts, 0.13 mm hoch

Streuwert 1.77, horizontal: 2.14, vertikal: 1.29

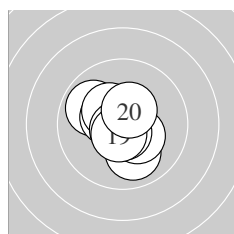

Serie 2:

10.7 *	9.9 ↖	10.4 *	10.0 ↓	10.4 *
10.3 *	10.7 *	10.7 *	10.6 *	10.5 *

beste Teiler 59.3 (17.) 65.7 (18.) 72.8 (11.)

Trefferlage 0.21 mm links, 0.15 mm tief

Streuwert 1.11, horizontal: 1.08, vertikal: 1.14

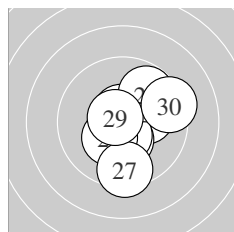

Serie 3:

10.6 *	9.8 ↗	10.2 *	10.4 *	10.5 *
10.3 *	9.4 ↓	9.8 ↗	10.7 *	9.4 →

beste Teiler 70.4 (29.) 80.2 (21.) 107.7 (25.)

Trefferlage 0.87 mm rechts, 0.07 mm tief

Streuwert 1.68, horizontal: 1.53, vertikal: 1.81

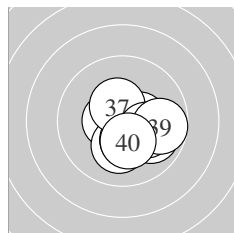

Serie 4:

10.5 *	10.4 *	10.4 *	10.2 *	9.9 ↘
10.3 *	10.4 *	10.1 ↘	9.7 →	10.3 *

beste Teiler 102.0 (31.) 129.3 (37.) 133.3 (32.)

Trefferlage 0.76 mm rechts, 0.75 mm tief

Streuwert 1.16, horizontal: 1.31, vertikal: 0.99

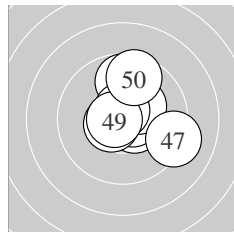

Serie 5:

10.5 *	10.3 *	10.6 *	9.8 ↑	10.3 *
10.7 *	9.2 ↘	10.6 *	10.7 *	9.6 ↑

beste Teiler 66.1 (49.) 70.2 (46.) 82.0 (43.)

Trefferlage 0.74 mm rechts, 0.69 mm hoch

Streuwert 1.48, horizontal: 1.39, vertikal: 1.56

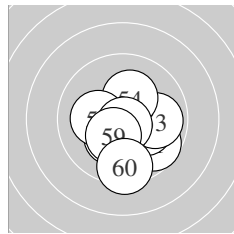

Serie 6:

9.7 ↘	10.2 *	9.9 →	10.2 *	10.3 *
10.3 *	10.2 *	10.8 *	10.3 *	9.4 ↓

beste Teiler 49.7 (58.) 152.2 (59.) 167.0 (55.)

Trefferlage 0.37 mm rechts, 0.97 mm tief

Streuwert 1.48, horizontal: 1.52, vertikal: 1.45

ISSF AR Women Jun – Wertung – Juniorinnen

StartNr: 46

StandNr: 146

20. Januar 2018 9:35

Karasova, Sara #81

CZE

Unterschrift des Schützen

Meyton Elektronik

Ergebnis: **621.1** (597)
 Serien: 104.4 103.0 102.3 103.4 103.3 104.7
 Zähler: 57 3 0 0 0 0 0 0 0 0
 Innenzehner: 47
 weiteste: 278 (25), 265 (48), 257 (13)
 beste Teiler 2.2 (56.) 50.2 (9.) 53.6 (51.)
 Trefferlage 0.04 mm rechts, 0.35 mm hoch
 Streuwert 1.13, horizontal: 1.28, vertikal: 0.97

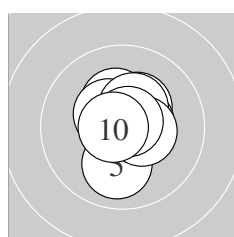
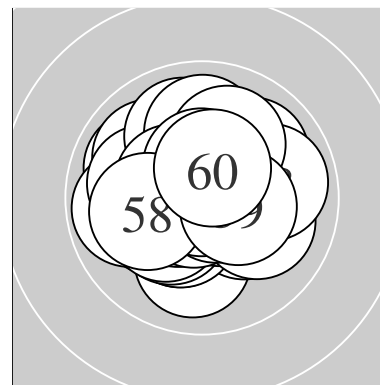

Serie 1:
 10.3 * 10.5 * 10.3 * 10.5 * 10.0 ↓
 10.5 * 10.4 * 10.4 * 10.8 * 10.7 *
 beste Teiler 50.2 (9.) 60.0 (10.) 102.8 (4.)
 Trefferlage 0.24 mm rechts, 0.38 mm hoch
 Streuwert 0.96, horizontal: 0.76, vertikal: 1.12

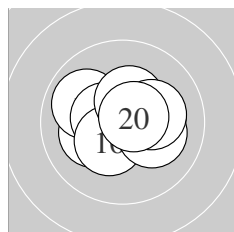

Serie 2:
 10.2 * 10.2 * 9.9 ↖ 10.5 * 10.4 *
 10.4 * 10.2 * 10.4 * 10.2 * 10.6 *
 beste Teiler 79.1 (20.) 113.7 (14.) 127.3 (15.)
 Trefferlage 0.18 mm rechts, 0.18 mm hoch
 Streuwert 1.26, horizontal: 1.59, vertikal: 0.80

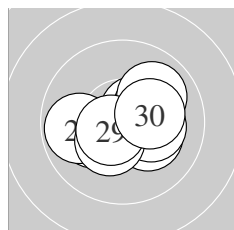

Serie 3:
 10.2 * 10.2 * 10.5 * 10.2 * 9.8 ←
 10.0 ↗ 10.2 * 10.4 * 10.6 * 10.2 *
 beste Teiler 90.4 (29.) 107.7 (23.) 144.5 (28.)
 Trefferlage 0.33 mm rechts, 0.02 mm tief
 Streuwert 1.38, horizontal: 1.73, vertikal: 0.90

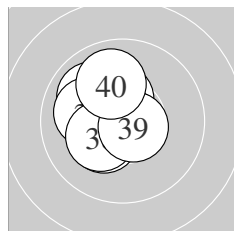

Serie 4:
 10.4 * 10.7 * 10.3 * 10.6 * 10.4 *
 10.0 ↖ 10.1 ← 10.3 * 10.6 * 10.0 ↗
 beste Teiler 55.2 (32.) 77.4 (39.) 81.6 (34.)
 Trefferlage 0.80 mm links, 0.45 mm hoch
 Streuwert 1.05, horizontal: 0.94, vertikal: 1.15

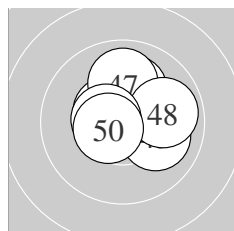

Serie 5:
 10.5 * 10.5 * 10.6 * 10.6 * 10.0 ↘
 10.1 ↑ 10.0 ↑ 9.9 → 10.5 * 10.6 *
 beste Teiler 85.1 (43.) 91.2 (44.) 100.3 (50.)
 Trefferlage 0.27 mm rechts, 0.66 mm hoch
 Streuwert 1.16, horizontal: 1.29, vertikal: 1.01

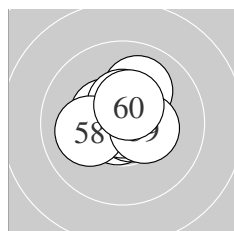

Serie 6:
 10.7 * 10.4 * 10.5 * 10.7 * 10.0 ↗
 10.9 * 10.5 * 10.1 ← 10.4 * 10.5 *
 beste Teiler 2.2 (56.) 53.6 (51.) 59.0 (54.)
 Trefferlage 0.05 mm rechts, 0.45 mm hoch
 Streuwert 0.96, horizontal: 1.03, vertikal: 0.88

Meyton Elektronik

ISSF AR Women Jun – Wertung – Juniorinnen

StandNr: 147

Kharkova, Tatiana #82

StartNr: 47

20. Januar 2018 9:36

RUS

Unterschrift des Schützen

Meyton Elektronik

Ergebnis: **612.9** (584)
 Serien: 103.0 101.9 100.3 102.8 102.8 102.1
 Zähler: 44 16 0 0 0 0 0 0 0
 Innenzehner: 38
 weiteste: 438 (27), 403 (33), 369 (30)
 beste Teiler 22.5 (18.) 36.2 (37.) 52.3 (23.)
 Trefferlage 0.14 mm rechts, 0.38 mm hoch
 Streuwert 1.47, horizontal: 1.69, vertikal: 1.20

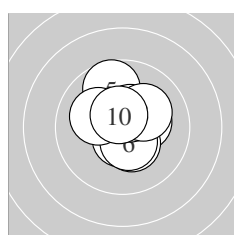
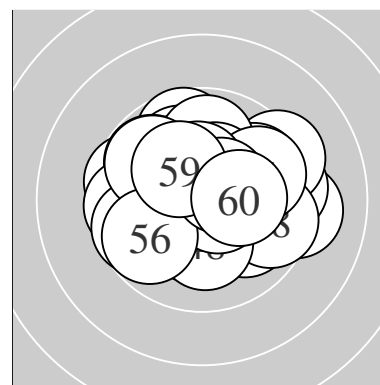

Serie 1:
 10.3 * 10.6 * 10.1 ↗ 10.4 * 9.7 ↗
 10.5 * 10.5 * 10.2 * 10.1 ↖ 10.6 *
 beste Teiler 88.1 (2.) 100.2 (10.) 122.3 (6.)
 Trefferlage 0.09 mm rechts, 0.61 mm hoch
 Streuwert 1.25, horizontal: 1.12, vertikal: 1.37

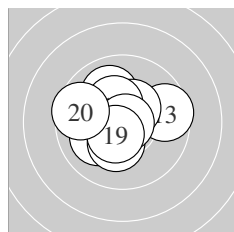

Serie 2:
 10.2 * 10.0 ↗ 9.6 → 10.4 * 10.3 *
 10.1 ↖ 10.3 * 10.9 * 10.5 * 9.6 ↖
 beste Teiler 22.5 (18.) 109.4 (19.) 132.5 (14.)
 Trefferlage 0.51 mm links, 0.37 mm hoch
 Streuwert 1.52, horizontal: 1.75, vertikal: 1.25

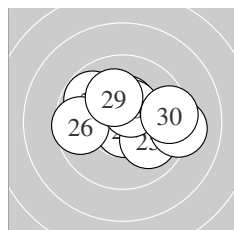

Serie 3:
 9.8 ↖ 10.5 * 10.7 * 10.4 * 10.0 ↘
 9.6 ← 9.2 → 10.5 * 10.1 ↗ 9.5 →
 beste Teiler 52.3 (23.) 120.2 (22.) 124.1 (28.)
 Trefferlage 0.39 mm rechts, 0.49 mm hoch
 Streuwert 1.88, horizontal: 2.42, vertikal: 1.10

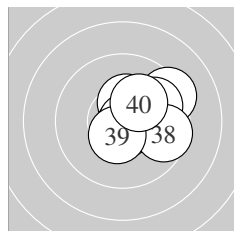

Serie 4:
 10.7 * 10.4 * 9.3 ↗ 10.7 * 9.9 →
 10.7 * 10.8 * 9.6 ↘ 10.5 * 10.2 *
 beste Teiler 36.2 (37.) 53.3 (34.) 61.8 (36.)
 Trefferlage 1.13 mm rechts, 0.25 mm hoch
 Streuwert 1.28, horizontal: 1.42, vertikal: 1.13

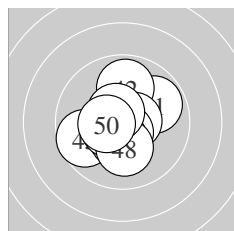

Serie 5:
 9.8 ↗ 9.9 ↑ 10.6 * 10.6 * 9.7 ↖
 10.4 * 10.5 * 10.2 * 10.6 * 10.5 *
 beste Teiler 83.4 (43.) 83.5 (44.) 93.4 (49.)
 Trefferlage 0.22 mm links, 0.12 mm tief
 Streuwert 1.40, horizontal: 1.40, vertikal: 1.40

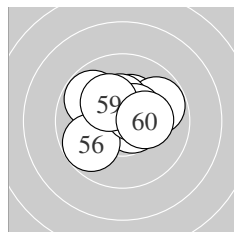

Serie 6:
 10.4 * 10.6 * 10.3 * 9.8 → 9.8 ↖
 9.8 ↖ 10.4 * 10.5 * 10.2 * 10.3 *
 beste Teiler 79.3 (52.) 110.6 (58.) 130.2 (51.)
 Trefferlage 0.04 mm links, 0.68 mm hoch
 Streuwert 1.39, horizontal: 1.67, vertikal: 1.05

Meyton Elektronik

ISSF AR Women Jun – Wertung – Juniorinnen

StandNr: 148

Helesicova, Barbora #83

StartNr: 48

20. Januar 2018 9:51

CZE

Unterschrift des Schützen

Meyton Elektronik

Ergebnis:	613.8	(586)
Serien:	102.4	103.1 100.3 103.1 103.8 101.1
Zähler:	47	12 1 0 0 0 0 0 0 0
Innenzehner:	42	
weiteste:	592	(14), 419 (60), 390 (51)
beste Teiler	44.5	(16.) 46.7 (54.) 58.4 (15.)
Trefferlage	0.57 mm links, 0.07 mm hoch	
Streuwert	1.47, horizontal: 1.82, vertikal: 1.01	

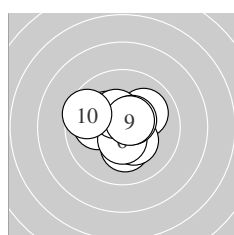
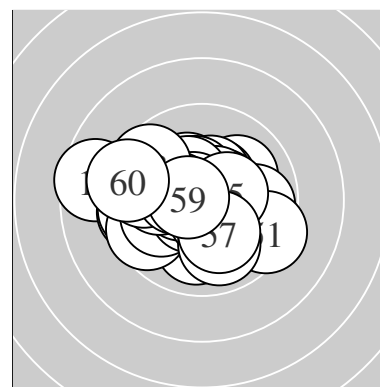

Serie 1:				
10.0 ↗	10.2 *	10.2 *	10.3 *	10.1 ←
10.5 *	10.4 *	10.5 *	10.6 *	9.6 ↖
beste Teiler	88.4 (9.) 107.0 (8.) 112.0 (6.)			
Trefferlage	0.29 mm links, 0.20 mm hoch			
Streuwert	1.40, horizontal: 1.60, vertikal: 1.16			

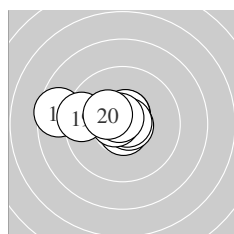

Serie 2:				
10.6 *	10.6 *	10.7 *	8.6 ←	10.7 *
10.8 *	10.7 *	10.7 *	9.4 ←	10.3 *
beste Teiler	44.5 (16.) 58.4 (15.) 60.6 (13.)			
Trefferlage	1.03 mm links, 0.45 mm hoch			
Streuwert	1.55, horizontal: 2.12, vertikal: 0.54			

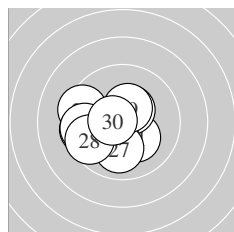

Serie 3:				
10.2 *	9.4 ↖	9.5 ←	10.4 *	10.6 *
9.6 ←	10.0 ↓	9.6 ↖	10.4 *	10.6 *
beste Teiler	92.7 (25.) 93.2 (30.) 130.9 (24.)			
Trefferlage	1.32 mm links, 0.33 mm tief			
Streuwert	1.61, horizontal: 1.91, vertikal: 1.25			

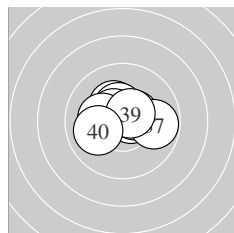

Serie 4:				
10.3 *	10.4 *	10.2 *	10.6 *	10.5 *
10.5 *	9.8 →	10.2 *	10.6 *	10.0 ←
beste Teiler	77.8 (34.) 99.7 (39.) 107.0 (35.)			
Trefferlage	0.25 mm links, 0.40 mm hoch			
Streuwert	1.23, horizontal: 1.59, vertikal: 0.68			

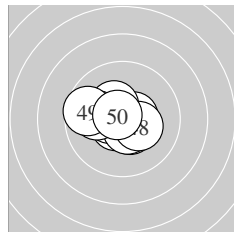

Serie 5:				
10.6 *	10.6 *	10.5 *	10.5 *	10.5 *
10.4 *	10.0 ←	10.3 *	9.7 ←	10.7 *
beste Teiler	60.6 (50.) 89.0 (41.) 100.6 (42.)			
Trefferlage	0.49 mm links, 0.02 mm tief			
Streuwert	1.16, horizontal: 1.46, vertikal: 0.75			

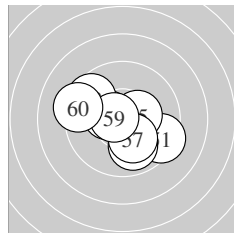

Serie 6:				
9.4 ↘	10.5 *	9.9 ↓	10.8 *	10.4 *
10.4 *	10.2 *	9.6 ↘	10.6 *	9.3 ←
beste Teiler	46.7 (54.) 78.2 (59.) 125.5 (52.)			
Trefferlage	0.07 mm links, 0.22 mm tief			
Streuwert	1.84, horizontal: 2.22, vertikal: 1.36			

Meyton Elektronik

ISSF AR Women Jun – Wertung – Juniorinnen

StandNr: 102

Oliver, Lorena Ayelen #85

StartNr: 50

20. Januar 2018 11:19

ARG

Unterschrift des Schützen

Meyton Elektronik

Ergebnis:	622.1	(593)
Serien:	103.1	103.1 103.7 103.9 104.1 104.2
Zähler:	53 7 0 0 0 0 0 0 0	
Innenzehner:	44	
weiteste:	310 (20), 306 (1), 304 (60)	
beste Teiler	27.1 (19.) 36.0 (59.) 37.8 (34.)	
Trefferlage	0.36 mm rechts, 0.13 mm hoch	
Streuwert	1.15, horizontal: 1.22, vertikal: 1.08	

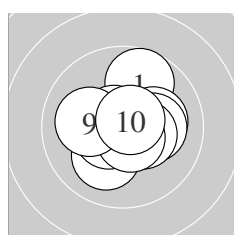
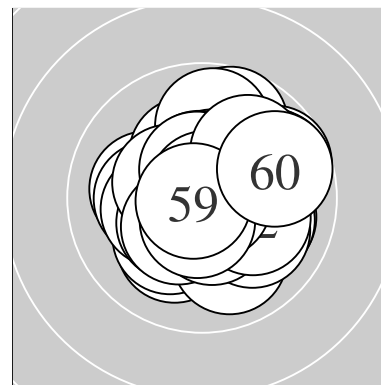

Serie 1:	9.7 ↗	10.1 →	10.2 *	10.4 *	10.1 ↘
	10.5 *	10.7 *	10.6 *	10.1 ←	10.7 *
beste Teiler	68.6 (10.)	73.1 (7.)	84.2 (8.)		
Trefferlage	0.26 mm rechts, 0.10 mm hoch				
Streuwert	1.30, horizontal: 1.38, vertikal: 1.20				

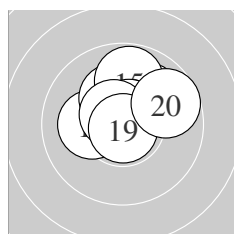

Serie 2:	10.4 *	10.2 *	10.2 *	10.0 ↗	9.8 ↑
	10.8 *	10.6 *	10.6 *	10.8 *	9.7 →
beste Teiler	27.1 (19.)	41.1 (16.)	77.6 (17.)		
Trefferlage	0.22 mm rechts, 1.03 mm hoch				
Streuwert	1.12, horizontal: 1.28, vertikal: 0.93				

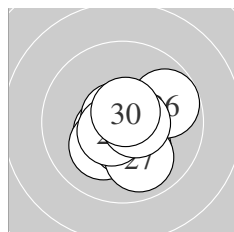

Serie 3:	10.5 *	10.2 *	10.7 *	10.5 *	10.2 *
	9.8 →	9.9 ↘	10.6 *	10.6 *	10.7 *
beste Teiler	56.0 (23.)	68.6 (30.)	86.2 (29.)		
Trefferlage	0.26 mm rechts, 0.58 mm tief				
Streuwert	1.15, horizontal: 1.19, vertikal: 1.11				

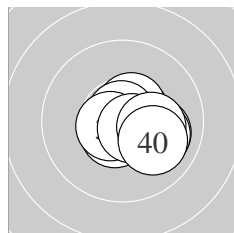

Serie 4:	10.6 *	10.6 *	10.5 *	10.8 *	10.6 *
	10.6 *	10.0 →	10.0 →	10.2 *	10.0 ↘
beste Teiler	37.8 (34.)	77.0 (36.)	85.6 (35.)		
Trefferlage	0.88 mm rechts, 0.31 mm tief				
Streuwert	0.92, horizontal: 1.12, vertikal: 0.67				

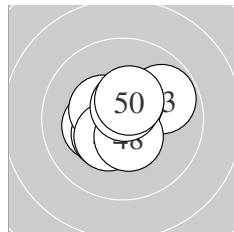

Serie 5:	10.3 *	10.4 *	9.8 ↗	10.5 *	10.8 *
	10.4 *	10.4 *	10.5 *	10.6 *	10.4 *
beste Teiler	50.4 (45.)	81.2 (49.)	114.5 (44.)		
Trefferlage	0.15 mm links, 0.11 mm hoch				
Streuwert	1.11, horizontal: 1.22, vertikal: 0.99				

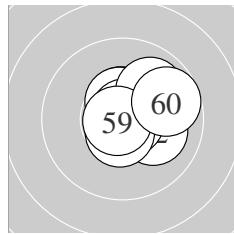

Serie 6:	10.4 *	10.1 →	10.5 *	10.8 *	10.5 *
	10.8 *	10.6 *	10.0 ↗	10.8 *	9.7 →
beste Teiler	36.0 (59.)	39.3 (56.)	47.8 (54.)		
Trefferlage	0.72 mm rechts, 0.45 mm hoch				
Streuwert	1.01, horizontal: 1.11, vertikal: 0.89				

Meyton Elektronik

ISSF AR Women Jun – Wertung – Juniorinnen

StandNr: 103

Rossiter, Victoria #86

StartNr: 51

20. Januar 2018 11:42

AUS

Unterschrift des Schützen

Meyton Elektronik

Ergebnis: **615.9** (591)
 Serien: 102.2 103.0 102.2 102.2 103.0 103.3
 Zähler: 51 9 0 0 0 0 0 0 0
 Innenzehner: 40
 weiteste: 326 (12), 306 (33), 295 (28)
 beste Teiler 19.2 (32.) 21.9 (13.) 58.8 (47.)
 Trefferlage 0.04 mm rechts, 0.08 mm hoch
 Streuwert 1.33, horizontal: 1.46, vertikal: 1.17

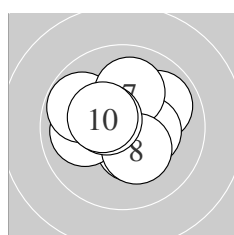
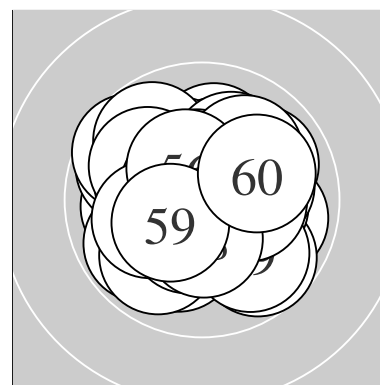

Serie 1:
 10.4 * 10.0 ← 9.9 ↗ 9.8 ↘ 10.3 *
 10.5 * 10.1 ↑ 10.3 * 10.5 * 10.4 *
 beste Teiler 105.9 (6.) 111.8 (9.) 132.9 (1.)
 Trefferlage 0.22 mm links, 0.37 mm hoch
 Streuwert 1.40, horizontal: 1.61, vertikal: 1.14

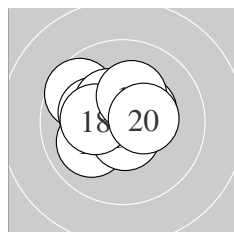

Serie 2:
 10.4 * 9.6 ↘ 10.9 * 10.0 ↙ 10.2 *
 10.6 * 10.4 * 10.3 * 10.2 * 10.4 *
 beste Teiler 21.9 (13.) 84.5 (16.) 135.9 (20.)
 Trefferlage 0.57 mm links, 0.44 mm hoch
 Streuwert 1.24, horizontal: 1.44, vertikal: 0.98

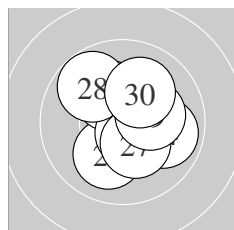

Serie 3:
 10.5 * 10.5 * 10.1 ↓ 9.9 → 10.2 *
 10.6 * 10.3 * 9.8 ↘ 10.2 * 10.1 ↗
 beste Teiler 84.6 (26.) 105.8 (22.) 121.5 (21.)
 Trefferlage 0.41 mm rechts, 0.06 mm hoch
 Streuwert 1.42, horizontal: 1.37, vertikal: 1.47

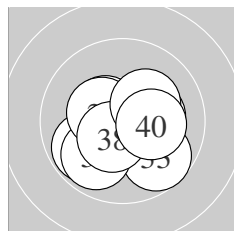

Serie 4:
 10.4 * 10.9 * 9.7 ↘ 9.8 ↙ 10.2 *
 9.9 ↙ 10.4 * 10.5 * 10.2 * 10.2 *
 beste Teiler 19.2 (32.) 120.6 (38.) 126.4 (31.)
 Trefferlage 0.00 mm, 0.45 mm tief
 Streuwert 1.44, horizontal: 1.65, vertikal: 1.21

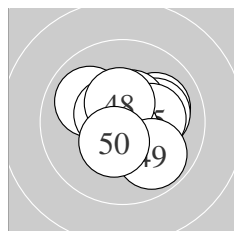

Serie 5:
 10.1 → 10.1 → 10.5 * 10.0 ↘ 10.2 *
 10.6 * 10.7 * 10.5 * 9.9 ↘ 10.4 *
 beste Teiler 58.8 (47.) 100.4 (46.) 119.4 (43.)
 Trefferlage 0.47 mm rechts, 0.18 mm hoch
 Streuwert 1.29, horizontal: 1.44, vertikal: 1.13

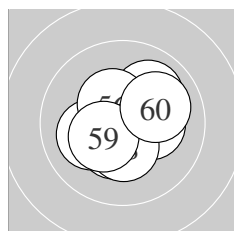

Serie 6:
 10.4 * 10.1 ← 10.6 * 10.0 ↗ 10.7 *
 10.4 * 10.3 * 10.4 * 10.4 * 10.0 →
 beste Teiler 73.1 (55.) 84.2 (53.) 136.8 (56.)
 Trefferlage 0.19 mm rechts, 0.08 mm tief
 Streuwert 1.24, horizontal: 1.34, vertikal: 1.13

Meyton Elektronik

ISSF AR Women Jun – Wertung – Juniorinnen

StandNr: 104

Kokoskova, Daniela #87

StartNr: 52

20. Januar 2018 11:51

CZE

Unterschrift des Schützen

Meyton Elektronik

Ergebnis:	598.4	(575)
Serien:	97.9	103.7 97.8 99.5 98.6 100.9
Zähler:	37	21 2 0 0 0 0 0 0 0
Innenzehner:	29	
weiteste:	559 (4), 550 (22), 488 (34)	
beste Teiler	44.3 (47.)	54.9 (16.) 71.3 (18.)
Trefferlage	0.33 mm links, 0.28 mm hoch	
Streuwert	1.95, horizontal: 2.12, vertikal: 1.78	

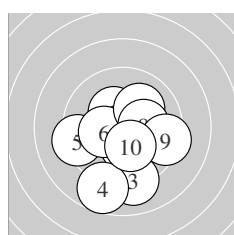
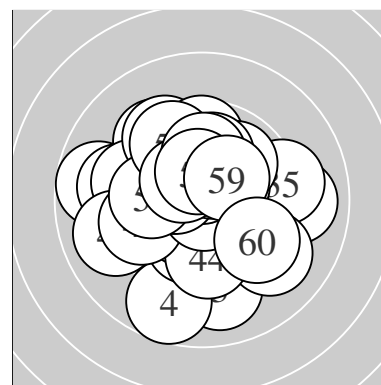

Serie 1:	10.3 *	10.3 *	9.1 ↓	8.7 ↓	9.3 ←
	10.3 *	10.1 ↗	10.2 *	9.4 →	10.2 *
beste Teiler	151.9 (2.) 167.1 (1.) 168.0 (6.)				
Trefferlage	0.08 mm rechts, 1.27 mm tief				
Streuwert	2.22, horizontal: 2.18, vertikal: 2.25				

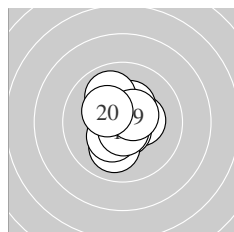

Serie 2:	10.3 *	10.3 *	10.6 *	10.0 ↖	10.0 ↓
	10.7 *	10.3 *	10.7 *	10.5 *	10.3 *
beste Teiler	54.9 (16.) 71.3 (18.) 76.3 (13.)				
Trefferlage	0.09 mm links, 0.00 mm				
Streuwert	1.15, horizontal: 0.94, vertikal: 1.32				

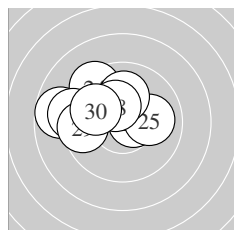

Serie 3:	10.6 *	8.8 ←	10.0 ↖	9.4 ↖	10.0 →
	9.2 ←	10.1 ↑	10.3 *	9.5 ←	9.9 ↖
beste Teiler	95.0 (21.) 155.3 (28.) 223.2 (27.)				
Trefferlage	1.67 mm links, 1.08 mm hoch				
Streuwert	1.87, horizontal: 2.42, vertikal: 1.06				

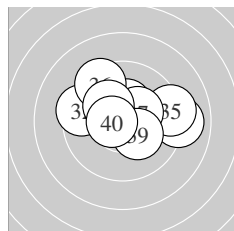

Serie 4:	10.6 *	9.5 ←	10.4 *	9.0 →	9.2 →
	9.4 ↖	10.3 *	10.2 *	10.3 *	10.6 *
beste Teiler	94.1 (40.) 97.6 (31.) 148.7 (33.)				
Trefferlage	0.33 mm rechts, 0.75 mm hoch				
Streuwert	2.06, horizontal: 2.67, vertikal: 1.17				

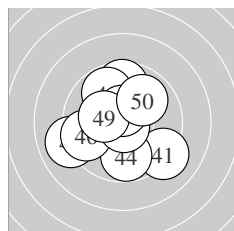

Serie 5:	9.1 ↘	9.7 ↑	9.0 ←	9.8 ↓	9.8 ↖
	9.6 ←	10.8 *	10.6 *	10.3 *	9.9 ↗
beste Teiler	44.3 (47.) 98.0 (48.) 169.9 (49.)				
Trefferlage	0.50 mm links, 0.00 mm				
Streuwert	2.25, horizontal: 2.32, vertikal: 2.18				

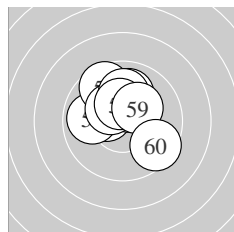

Serie 6:	10.4 *	10.4 *	9.9 ←	9.6 ↖	10.4 *
	10.0 ↑	10.0 ↑	10.4 *	10.3 *	9.5 ↘
beste Teiler	137.0 (52.) 147.3 (51.) 147.7 (55.)				
Trefferlage	0.15 mm links, 1.11 mm hoch				
Streuwert	1.51, horizontal: 1.60, vertikal: 1.42				

Meyton Elektronik

ISSF AR Women Jun – Wertung – Juniorinnen

StandNr: 105

Obholzer, Magdalena #88

StartNr: 53

20. Januar 2018 11:35

T – SG Eben

Unterschrift des Schützen

Meyton Elektronik

Ergebnis: **618.4** (590)
 Serien: 102.1 101.9 104.4 103.8 103.5 102.7
 Zähler: 50 10 0 0 0 0 0 0 0
 Innenzehner: 42
 weiteste: 357 (38), 355 (16), 326 (6)
 beste Teiler 14.0 (46.) 14.8 (53.) 34.5 (50.)
 Trefferlage 0.01 mm rechts, 0.24 mm hoch
 Streuwert 1.30, horizontal: 1.43, vertikal: 1.15

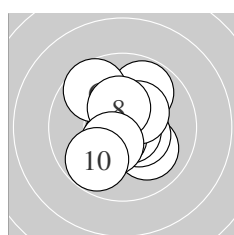
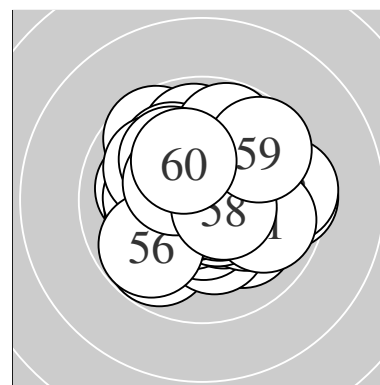

Serie 1:
 10.0 ↘ 10.4 * 10.7 * 10.6 * 9.8 ↗
 9.6 ↘ 10.4 * 10.4 * 10.4 * 9.8 ↙
 beste Teiler 57.9 (3.) 86.6 (4.) 130.1 (2.)
 Trefferlage 0.05 mm rechts, 0.09 mm hoch
 Streuwert 1.51, horizontal: 1.32, vertikal: 1.68

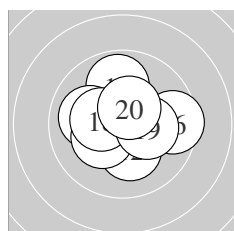

Serie 2:
 10.5 * 10.2 * 9.9 ↑ 10.4 * 10.0 ←
 9.5 → 10.3 * 10.3 * 10.3 * 10.5 *
 beste Teiler 110.1 (11.) 125.1 (20.) 141.4 (14.)
 Trefferlage 0.04 mm links, 0.10 mm hoch
 Streuwert 1.53, horizontal: 1.76, vertikal: 1.25

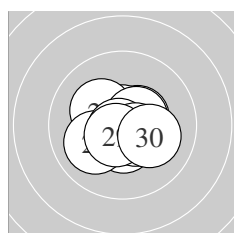

Serie 3:
 10.5 * 10.7 * 10.2 * 10.5 * 10.5 *
 10.0 ↙ 10.8 * 10.5 * 10.6 * 10.1 →
 beste Teiler 44.2 (27.) 61.1 (22.) 85.7 (29.)
 Trefferlage 0.07 mm rechts, 0.21 mm tief
 Streuwert 1.02, horizontal: 1.19, vertikal: 0.82

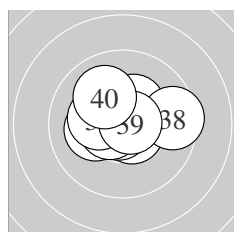

Serie 4:
 10.6 * 10.8 * 10.2 * 10.6 * 10.7 *
 10.3 * 10.4 * 9.5 → 10.7 * 10.0 ↘
 beste Teiler 41.1 (32.) 55.1 (39.) 68.5 (35.)
 Trefferlage 0.03 mm links, 0.32 mm hoch
 Streuwert 1.26, horizontal: 1.59, vertikal: 0.80

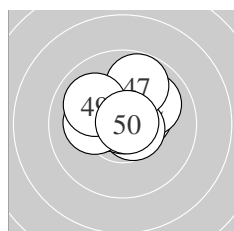

Serie 5:
 10.4 * 10.0 ↗ 10.4 * 10.4 * 10.6 *
 10.9 * 9.8 ↑ 10.2 * 10.0 ↘ 10.8 *
 beste Teiler 14.0 (46.) 34.5 (50.) 82.3 (45.)
 Trefferlage 0.13 mm links, 0.66 mm hoch
 Streuwert 1.20, horizontal: 1.43, vertikal: 0.91

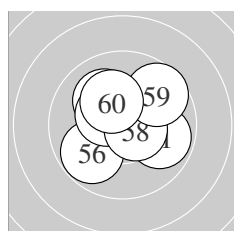

Serie 6:
 9.9 → 10.7 * 10.9 * 10.1 ↘ 10.4 *
 9.8 ↙ 10.4 * 10.6 * 9.7 ↗ 10.2 *
 beste Teiler 14.8 (53.) 65.7 (52.) 97.7 (58.)
 Trefferlage 0.19 mm rechts, 0.48 mm hoch
 Streuwert 1.43, horizontal: 1.57, vertikal: 1.26

Meyton Elektronik

ISSF AR Women Jun – Wertung – Juniorinnen

StandNr: 106

Tan, Qian Ni Fernel #89

StartNr: 54

20. Januar 2018 11:43

SGP

Unterschrift des Schützen

Meyton Elektronik

Ergebnis:	621.7	(592)						
Serien:	102.9	103.8	102.8	102.4	105.5	104.3		
Zähler:	52	8	0	0	0	0	0	0
Innenzehner:	46							
weiteste:	427 (2), 401 (26), 362 (60)							
beste Teiler	9.2 (52.) 16.5 (27.) 21.0 (46.)							
Trefferlage	0.10 mm rechts, 0.11 mm hoch							
Streuwert	1.24, horizontal: 1.48, vertikal: 0.95							

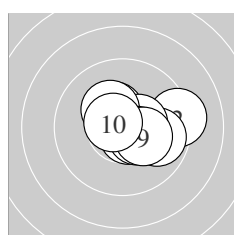
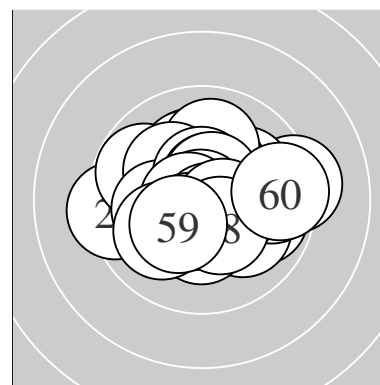

Serie 1:	10.6 *	9.2 →	10.7 *	10.4 *	9.9 →
	10.5 *	10.3 *	10.4 *	10.3 *	10.6 *
beste Teiler	74.4 (3.) 79.1 (1.) 81.3 (10.)				
Trefferlage	0.96 mm rechts, 0.15 mm hoch				
Streuwert	1.27, horizontal: 1.61, vertikal: 0.80				

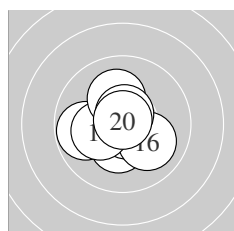

Serie 2:	10.5 *	10.3 *	10.8 *	10.7 *	9.8 ←
	10.0 ↘	10.2 *	10.1 ↑	10.6 *	10.8 *
beste Teiler	32.0 (20.) 50.2 (13.) 53.0 (14.)				
Trefferlage	0.22 mm links, 0.26 mm tief				
Streuwert	1.17, horizontal: 1.28, vertikal: 1.05				

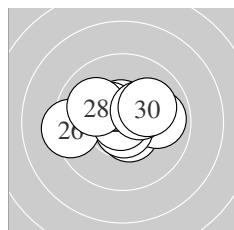

Serie 3:	10.6 *	10.6 *	9.9 →	10.4 *	10.7 *
	9.3 ←	10.9 *	10.0 ↘	10.3 *	10.1 →
beste Teiler	16.5 (27.) 51.1 (25.) 96.2 (21.)				
Trefferlage	0.08 mm links, 0.35 mm hoch				
Streuwert	1.47, horizontal: 1.93, vertikal: 0.75				

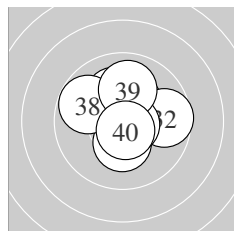

Serie 4:	10.3 *	9.7 →	10.2 *	10.3 *	10.5 *
	10.7 *	10.2 *	9.8 ↘	10.0 ↑	10.7 *
beste Teiler	65.7 (36.) 74.3 (40.) 107.0 (35.)				
Trefferlage	0.11 mm rechts, 0.72 mm hoch				
Streuwert	1.38, horizontal: 1.47, vertikal: 1.28				

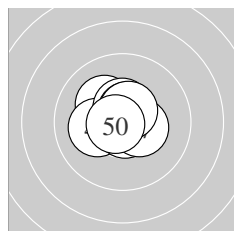

Serie 5:	10.2 *	10.7 *	10.2 *	10.7 *	10.5 *
	10.9 *	10.4 *	10.6 *	10.6 *	10.7 *
beste Teiler	21.0 (46.) 56.3 (44.) 57.2 (50.)				
Trefferlage	0.22 mm links, 0.29 mm hoch				
Streuwert	0.82, horizontal: 0.93, vertikal: 0.70				

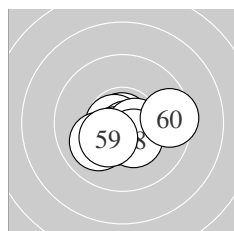

Serie 6:	10.8 *	10.9 *	10.7 *	10.7 *	10.5 *
	10.0 ↙	10.5 *	10.4 *	10.3 *	9.5 →
beste Teiler	9.2 (52.) 47.2 (51.) 63.2 (53.)				
Trefferlage	0.11 mm rechts, 0.54 mm tief				
Streuwert	1.14, horizontal: 1.49, vertikal: 0.61				

ISSF AR Women Jun – Wertung – Juniorinnen

StandNr: 107

Schachner, Christine #90

StartNr: 55

20. Januar 2018 11:43

AUT

Unterschrift des Schützen

Meyton Elektronik

Ergebnis: **617.2** (590)
 Serien: 103.6 103.7 102.6 101.0 102.2 104.1
 Zähler: 51 8 1 0 0 0 0 0 0
 Innenzehner: 45
 weiteste: 425 (49), 424 (30), 352 (34)
 beste Teiler 37.0 (19.) 42.2 (35.) 48.4 (37.)
 Trefferlage 0.24 mm links, 0.20 mm tief
 Streuwert 1.27, horizontal: 1.34, vertikal: 1.20

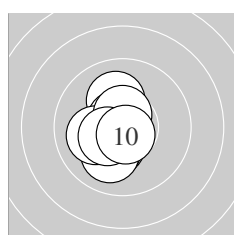
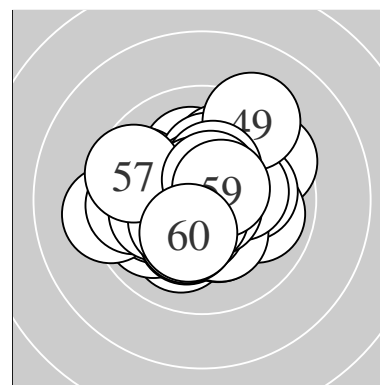

Serie 1:
 10.3 * 10.4 * 10.2 * 10.1 ↑ 10.1 ↘
 10.7 * 10.1 ← 10.6 * 10.4 * 10.7 *
 beste Teiler 61.4 (10.) 72.4 (6.) 95.0 (8.)
 Trefferlage 0.73 mm links, 0.45 mm tief
 Streuwert 1.01, horizontal: 0.64, vertikal: 1.28

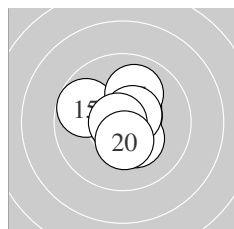

Serie 2:
 10.6 * 10.4 * 10.4 * 10.3 * 9.8 ↖
 10.4 * 10.0 ↑ 10.6 * 10.8 * 10.4 *
 beste Teiler 37.0 (19.) 92.4 (11.) 93.8 (18.)
 Trefferlage 0.24 mm rechts, 0.29 mm hoch
 Streuwert 1.18, horizontal: 1.14, vertikal: 1.21

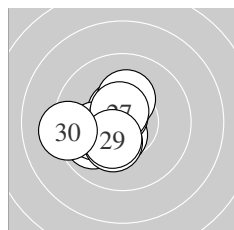

Serie 3:
 10.5 * 9.9 ↙ 10.6 * 10.1 ← 10.7 *
 10.2 * 10.6 * 10.3 * 10.4 * 9.3 ←
 beste Teiler 58.6 (25.) 87.3 (27.) 95.7 (23.)
 Trefferlage 1.10 mm links, 0.25 mm tief
 Streuwert 1.25, horizontal: 1.34, vertikal: 1.15

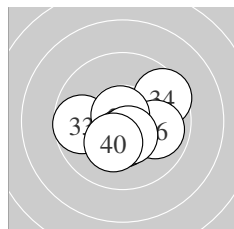

Serie 4:
 10.5 * 10.7 * 9.7 ← 9.5 ↗ 10.8 *
 9.9 → 10.8 * 10.4 * 8.5 * 10.2 *
ISSF 6.16.5.2c
 beste Teiler 42.2 (35.) 48.4 (37.) 66.0 (32.)
 Trefferlage 0.11 mm rechts, 0.43 mm tief
 Streuwert 1.40, horizontal: 1.72, vertikal: 0.97

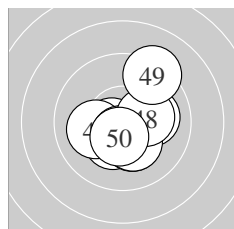

Serie 5:
 10.1 → 10.6 * 10.3 * 10.3 * 10.1 ←
 10.5 * 10.3 * 10.2 * 9.3 ↗ 10.5 *
 beste Teiler 92.1 (42.) 101.1 (46.) 114.7 (50.)
 Trefferlage 0.36 mm rechts, 0.31 mm tief
 Streuwert 1.48, horizontal: 1.42, vertikal: 1.55

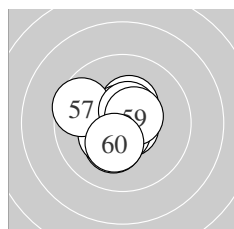

Serie 6:
 10.7 * 10.7 * 10.3 * 10.4 * 10.4 *
 10.7 * 9.6 ↖ 10.5 * 10.5 * 10.3 *
 beste Teiler 61.5 (51.) 71.1 (56.) 74.6 (52.)
 Trefferlage 0.36 mm links, 0.03 mm tief
 Streuwert 1.14, horizontal: 1.17, vertikal: 1.12

Meyton Elektronik

ISSF AR Women Jun – Wertung – Juniorinnen

StartNr: 56

StandNr: 108

20. Januar 2018 12:03

Oberholzer, Julia #91

SUI

ISSF 6.16.5.2c – nicht stattgebener Protest gegen Schusswertung (-2)

Unterschrift des Schützen

Meyton Elektronik

Ergebnis:	607.2	(585)
Serien:	100.3	101.2 101.2 100.3 101.8 102.4
Zähler:	46	13 1 0 0 0 0 0 0 0
Innenzehner:	34	
weiteste:	538	(28), 466 (38), 453 (10)
beste Teiler	42.0	(26.) 72.0 (42.) 79.5 (51.)
Trefferlage	0.03 mm	rechts, 0.51 mm hoch
Streuwert	1.61,	horizontal: 1.93, vertikal: 1.20

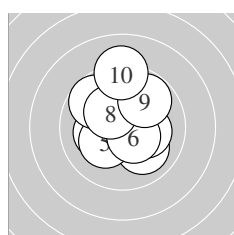
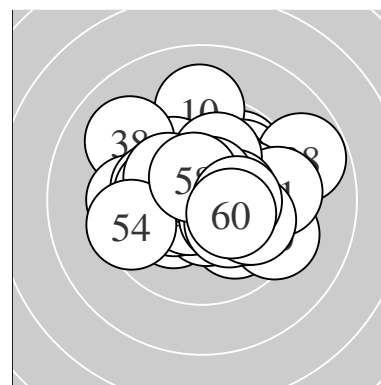

Serie 1:	10.0 ↘	10.3 *	10.2 *	10.2 *	10.2 *
	10.5 *	9.7 ↖	10.3 *	9.8 ↗	9.1 ↑
beste Teiler	119.3	(6.) 155.5 (2.)	160.8 (8.)		
Trefferlage	0.08 mm	links, 0.71 mm hoch			
Streuwert	1.76,	horizontal: 1.57, vertikal: 1.93			

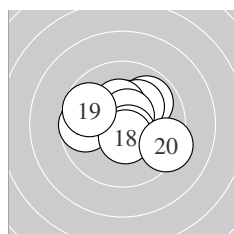

Serie 2:	9.9 ↗	10.4 *	10.2 *	10.3 *	9.7 ←
	10.6 *	10.6 *	10.5 *	9.7 ↖	9.3 ↘
beste Teiler	79.7	(16.) 80.2 (17.)	108.4 (18.)		
Trefferlage	0.21 mm	rechts, 0.45 mm hoch			
Streuwert	1.67,	horizontal: 2.01, vertikal: 1.24			

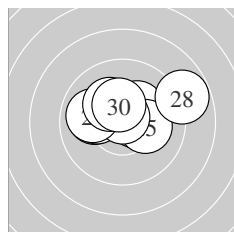

Serie 3:	10.0 ←	10.1 ←	10.5 *	10.3 *	10.2 *
	10.8 *	9.9 ←	8.8 ↗	10.2 *	10.4 *
beste Teiler	42.0	(26.) 105.3 (23.)	146.3 (30.)		
Trefferlage	0.07 mm	rechts, 0.77 mm hoch			
Streuwert	1.72,	horizontal: 2.31, vertikal: 0.75			

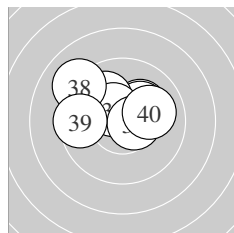

Serie 4:	10.2 *	10.1 →	10.2 *	10.1 ↖	10.0 ↖
	10.5 *	10.6 *	9.1 ↖	9.5 ←	10.0 →
beste Teiler	96.3	(37.) 122.2 (36.)	181.8 (33.)		
Trefferlage	0.28 mm	links, 1.08 mm hoch			
Streuwert	1.68,	horizontal: 2.20, vertikal: 0.90			

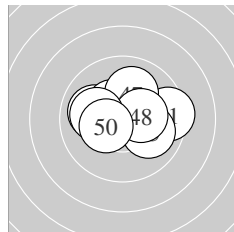

Serie 5:	9.4 →	10.7 *	10.0 ←	10.4 *	10.0 ↘
	10.4 *	10.1 ↑	10.3 *	10.1 ←	10.4 *
beste Teiler	72.0	(42.) 133.2 (44.)	143.8 (46.)		
Trefferlage	0.08 mm	rechts, 0.29 mm hoch			
Streuwert	1.56,	horizontal: 2.03, vertikal: 0.88			

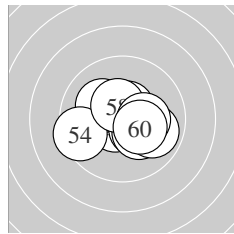

Serie 6:	10.6 *	10.1 ↖	10.4 *	9.5 ←	10.2 *
	10.6 *	9.9 ↘	10.5 *	10.3 *	10.3 *
beste Teiler	79.5	(51.) 99.5 (56.)	119.2 (58.)		
Trefferlage	0.22 mm	rechts, 0.23 mm tief			
Streuwert	1.45,	horizontal: 1.82, vertikal: 0.95			

Meyton Elektronik

ISSF AR Women Jun – Wertung – Juniorinnen

StandNr: 109

Schneider, Antonia #92

StartNr: 57

20. Januar 2018 11:23

BAY – Schwaben

Unterschrift des Schützen

Meyton Elektronik

Ergebnis: **608.9** (579)

Serien: 99.7 102.4 102.4 102.4 103.2 98.8

Zähler: 39 21 0 0 0 0 0 0 0 0

Innenzehner: 30

weiteste: 455 (60), 400 (31), 391 (53)

beste Teiler 21.0 (24.) 29.2 (11.) 31.3 (22.)

Trefferlage 0.50 mm rechts, 0.26 mm hoch

Streuwert 1.55, horizontal: 1.67, vertikal: 1.42

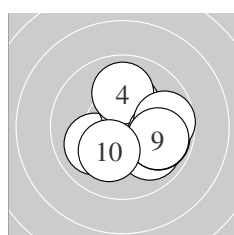
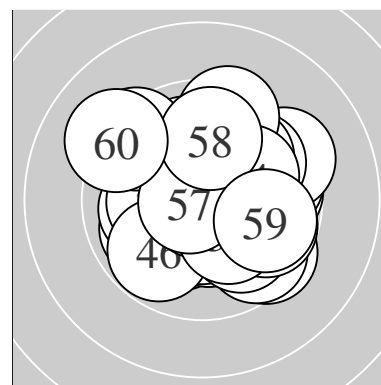

Serie 1:

10.0 ↙	10.3 *	9.9 ↘	10.0 ↑	9.9 →
9.9 →	9.9 →	9.7 →	9.9 →	10.2 *

beste Teiler 163.1 (2.) 197.0 (10.) 235.6 (1.)

Trefferlage 1.29 mm rechts, 0.30 mm tief

Streuwert 1.59, horizontal: 1.79, vertikal: 1.37

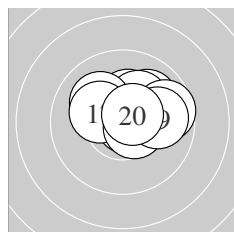

Serie 2:

10.8 *	10.3 *	10.0 ↗	10.2 *	10.1 ↖
9.7 →	10.2 *	10.6 *	9.9 →	10.6 *

beste Teiler 29.2 (11.) 91.2 (20.) 93.4 (18.)

Trefferlage 0.74 mm rechts, 0.81 mm hoch

Streuwert 1.20, horizontal: 1.54, vertikal: 0.72

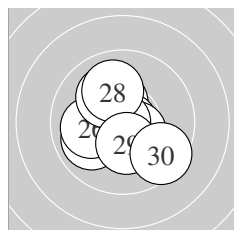

Serie 3:

10.4 *	10.8 *	10.5 *	10.9 *	9.9 ↙
10.0 ←	10.1 ↖	10.0 ↖	10.3 *	9.5 ↘

beste Teiler 21.0 (24.) 31.3 (22.) 119.6 (23.)

Trefferlage 0.26 mm links, 0.07 mm tief

Streuwert 1.50, horizontal: 1.51, vertikal: 1.50

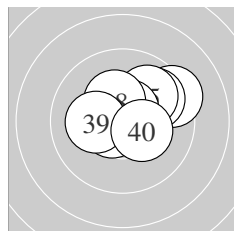

Serie 4:

9.4 ↗	10.7 *	9.8 ↗	10.6 *	9.9 ↗
10.6 *	10.6 *	10.3 *	10.2 *	10.3 *

beste Teiler 68.0 (32.) 86.9 (36.) 87.6 (37.)

Trefferlage 0.71 mm rechts, 0.72 mm hoch

Streuwert 1.33, horizontal: 1.61, vertikal: 0.96

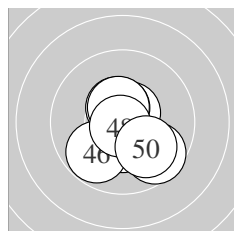

Serie 5:

10.6 *	10.5 *	10.4 *	10.5 *	10.5 *
9.8 ↗	10.5 *	10.8 *	9.6 ↘	10.0 ↘

beste Teiler 34.0 (48.) 84.2 (41.) 106.4 (44.)

Trefferlage 0.12 mm rechts, 0.52 mm tief

Streuwert 1.29, horizontal: 1.18, vertikal: 1.39

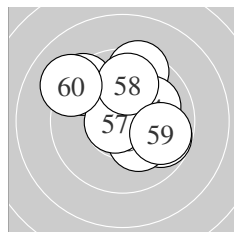

Serie 6:

10.5 *	9.4 ↑	9.4 ↖	10.1 ↗	9.7 →
10.2 *	10.7 *	9.9 ↑	9.8 →	9.1 ↖

beste Teiler 54.7 (57.) 104.6 (51.) 183.3 (56.)

Trefferlage 0.40 mm rechts, 0.93 mm hoch

Streuwert 2.03, horizontal: 2.21, vertikal: 1.84

ISSF AR Women Jun – Wertung – Juniorinnen

StandNr: 110

Tschaudi, Angelina #93

StartNr: 58

20. Januar 2018 11:24

VSBL NWLZ

Unterschrift des Schützen

Meyton Elektronik

Ergebnis: **621.4** (595)
 Serien: 103.8 102.8 103.4 103.4 104.0 104.0
 Zähler: 55 5 0 0 0 0 0 0 0 0
 Innenzehner: 47
 weiteste: 330 (11), 329 (45), 283 (6)
 beste Teiler 12.2 (46.) 35.6 (47.) 36.6 (5.)
 Trefferlage 0.06 mm links, 0.17 mm hoch
 Streuwert 1.18, horizontal: 1.38, vertikal: 0.94

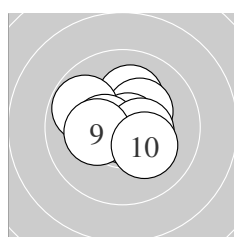
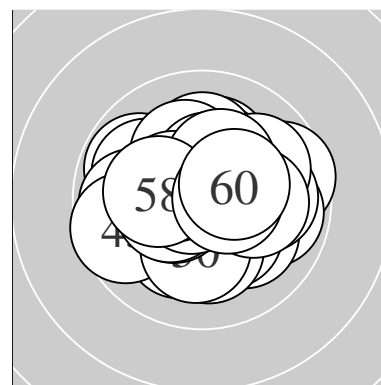

Serie 1:
 10.1 ↑ 10.7 * 10.3 * 10.7 * 10.8 *
 9.8 ↖ 10.5 * 10.4 * 10.3 * 10.2 *
 beste Teiler 36.6 (5.) 52.6 (4.) 75.4 (2.)
 Trefferlage 0.10 mm links, 0.21 mm hoch
 Streuwert 1.18, horizontal: 1.37, vertikal: 0.94

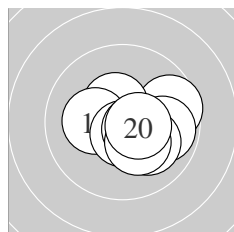

Serie 2:
 9.6 → 9.9 → 10.5 * 10.5 * 10.1 ↘
 10.2 * 10.6 * 10.6 * 10.3 * 10.5 *
 beste Teiler 78.1 (17.) 95.8 (18.) 108.9 (20.)
 Trefferlage 0.70 mm rechts, 0.21 mm tief
 Streuwert 1.28, horizontal: 1.60, vertikal: 0.85

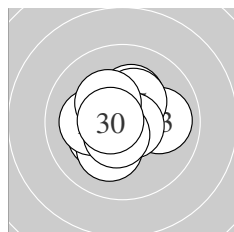

Serie 3:
 10.3 * 10.3 * 10.0 → 10.2 * 10.3 *
 10.1 ← 10.7 * 10.6 * 10.3 * 10.6 *
 beste Teiler 60.9 (27.) 82.6 (30.) 94.3 (28.)
 Trefferlage 0.23 mm links, 0.08 mm hoch
 Streuwert 1.22, horizontal: 1.32, vertikal: 1.10

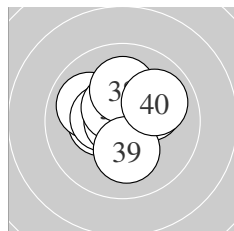

Serie 4:
 10.4 * 10.8 * 10.2 * 10.0 ↖ 10.4 *
 10.8 * 10.5 * 10.1 ↑ 10.2 * 10.0 →
 beste Teiler 37.0 (36.) 45.8 (32.) 106.8 (37.)
 Trefferlage 0.21 mm links, 0.42 mm hoch
 Streuwert 1.24, horizontal: 1.37, vertikal: 1.10

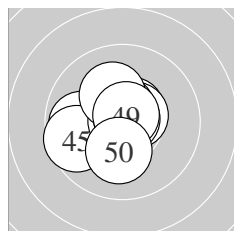

Serie 5:
 9.8 ← 10.6 * 10.6 * 10.6 * 9.6 ←
 10.9 * 10.8 * 10.2 * 10.7 * 10.2 *
 beste Teiler 12.2 (46.) 35.6 (47.) 53.2 (49.)
 Trefferlage 0.50 mm links, 0.14 mm hoch
 Streuwert 1.21, horizontal: 1.35, vertikal: 1.05

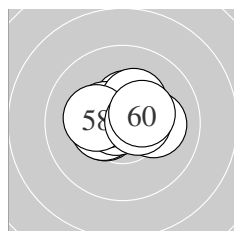

Serie 6:
 10.5 * 10.4 * 10.4 * 10.8 * 10.4 *
 10.3 * 10.1 → 10.2 * 10.5 * 10.4 *
 beste Teiler 43.4 (54.) 104.2 (59.) 119.1 (51.)
 Trefferlage 0.03 mm links, 0.37 mm hoch
 Streuwert 1.02, horizontal: 1.31, vertikal: 0.62

Meyton Elektronik

ISSF AR Women Jun – Wertung – Juniorinnen

StandNr: 111

Pavlova, Veronika #94

StartNr: 59

20. Januar 2018 11:44

RUS

Unterschrift des Schützen

Meyton Elektronik

Ergebnis: **617.5** (589)
 Serien: 103.2 103.1 100.9 103.2 101.8 105.3
 Zähler: 50 9 1 0 0 0 0 0 0
 Innenzehner: 39
 weiteste: 559 (22), 434 (47), 292 (44)
 beste Teiler 8.5 (53.) 13.4 (59.) 43.1 (7.)
 Trefferlage 0.01 mm links, 0.15 mm hoch
 Streuwert 1.36, horizontal: 1.60, vertikal: 1.07

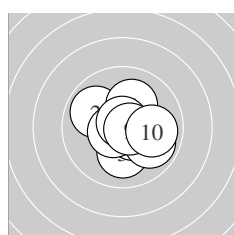
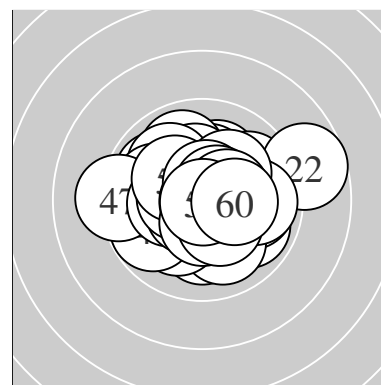

Serie 1:
 10.7 * 9.9 ↖ 10.1 ↓ 10.5 * 10.1 ↗
 10.6 * 10.8 * 9.9 ↘ 10.7 * 9.9 →
 beste Teiler 43.1 (7.) 52.2 (1.) 63.0 (9.)
 Trefferlage 0.39 mm rechts, 0.18 mm tief
 Streuwert 1.30, horizontal: 1.41, vertikal: 1.18

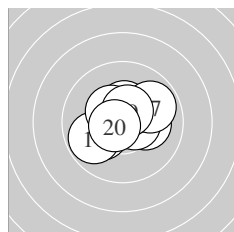

Serie 2:
 10.1 ↙ 10.4 * 10.2 * 9.8 ↖ 10.7 *
 10.5 * 9.9 ↗ 10.4 * 10.5 * 10.6 *
 beste Teiler 72.6 (15.) 76.5 (20.) 105.3 (19.)
 Trefferlage 0.06 mm rechts, 0.19 mm hoch
 Streuwert 1.29, horizontal: 1.56, vertikal: 0.95

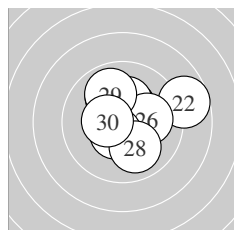

Serie 3:
 10.0 ↖ 8.7 → 10.4 * 10.3 * 10.6 *
 10.1 → 10.5 * 10.0 ↘ 9.9 ↖ 10.4 *
 beste Teiler 77.1 (25.) 113.7 (27.) 132.3 (30.)
 Trefferlage 0.47 mm rechts, 0.68 mm hoch
 Streuwert 1.76, horizontal: 2.02, vertikal: 1.46

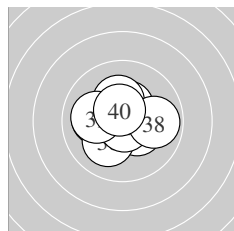

Serie 4:
 10.1 ← 10.4 * 10.4 * 10.3 * 10.6 *
 10.1 ↙ 10.8 * 9.9 → 10.0 ← 10.6 *
 beste Teiler 45.8 (37.) 86.2 (35.) 98.7 (40.)
 Trefferlage 0.23 mm links, 0.08 mm hoch
 Streuwert 1.29, horizontal: 1.51, vertikal: 1.03

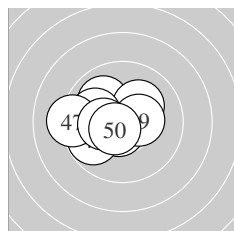

Serie 5:
 10.7 * 10.6 * 10.0 ↖ 9.8 ↖ 10.2 *
 10.0 ← 9.2 ← 10.3 * 10.4 * 10.6 *
 beste Teiler 54.1 (41.) 81.0 (42.) 90.0 (50.)
 Trefferlage 1.03 mm links, 0.13 mm hoch
 Streuwert 1.47, horizontal: 1.84, vertikal: 0.97

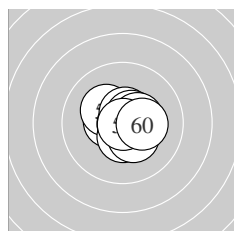

Serie 6:
 10.5 * 10.2 * 10.9 * 10.6 * 10.6 *
 10.5 * 10.4 * 10.4 * 10.9 * 10.3 *
 beste Teiler 8.5 (53.) 13.4 (59.) 88.5 (54.)
 Trefferlage 0.24 mm rechts, 0.03 mm hoch
 Streuwert 0.88, horizontal: 0.98, vertikal: 0.76

Meyton Elektronik

ISSF AR Women Jun – Wertung – Juniorinnen

StandNr: 112

Zirfaß, Alisa #95

StartNr: 60

20. Januar 2018 11:25

BAY – Schwaben

Unterschrift des Schützen

Meyton Elektronik

Ergebnis:	574.4	(551)
Serien:	97.0 96.5 93.3 101.2 93.5 92.9	
Zähler:	25 22 12 1 0 0 0 0 0 0	
Innenzehner:	17	
weiteste:	758 (51), 717 (48), 715 (44)	
beste Teiler	42.0 (40.) 77.6 (7.) 89.0 (13.)	
Trefferlage	0.44 mm links, 0.52 mm hoch	
Streuwert	2.75, horizontal: 3.10, vertikal: 2.36	

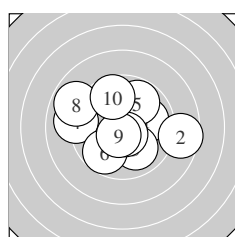
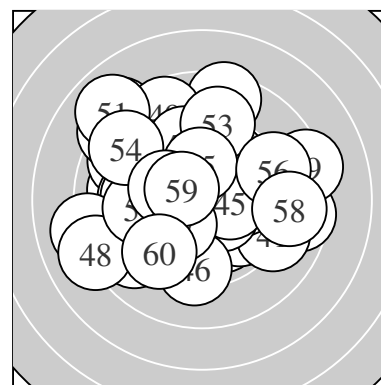

Serie 1:	10.0 →	8.6 →	10.0 ↘	9.1 ←	9.8 ↗
	9.7 ↙	10.6 *	8.9 ↖	10.6 *	9.7 ↗
beste Teiler	77.6 (7.)	89.4 (9.)	244.1 (3.)		
Trefferlage	0.12 mm links, 0.22 mm hoch				
Streuwert	2.64, horizontal: 3.19, vertikal: 1.93				

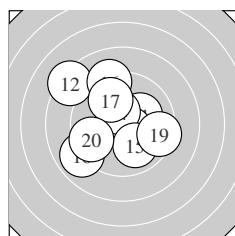

Serie 2:	10.2 *	8.3 ↖	10.6 *	10.4 *	10.0 ↘
	9.2 ↗	9.9 ↘	8.9 ↙	9.4 →	9.6 ←
beste Teiler	89.0 (13.)	132.6 (14.)	198.5 (11.)		
Trefferlage	0.80 mm links, 0.46 mm hoch				
Streuwert	2.68, horizontal: 2.79, vertikal: 2.56				

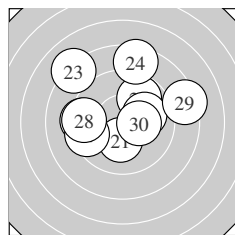

Serie 3:	10.2 *	9.8 ↗	8.1 ↖	8.5 ↑	10.0 →
	9.3 ←	9.4 ←	9.4 ←	8.3 →	10.3 *
beste Teiler	165.4 (30.)	180.3 (21.)	233.7 (25.)		
Trefferlage	0.35 mm links, 1.36 mm hoch				
Streuwert	3.15, horizontal: 3.63, vertikal: 2.58				

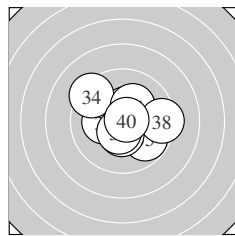

Serie 4:	10.2 *	10.2 *	10.4 *	9.3 ↖	9.8 ↘
	10.4 *	10.2 *	9.4 →	10.5 *	10.8 *
beste Teiler	42.0 (40.)	113.5 (39.)	127.6 (33.)		
Trefferlage	0.43 mm rechts, 0.16 mm hoch				
Streuwert	1.72, horizontal: 2.02, vertikal: 1.35				

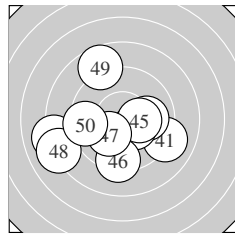

Serie 5:	9.1 ↘	10.0 →	10.4 *	8.1 ←	10.3 *
	9.3 ↓	10.1 ↙	8.1 ←	8.7 ↘	9.4 ←
beste Teiler	146.0 (43.)	169.5 (45.)	201.7 (47.)		
Trefferlage	1.16 mm links, 0.89 mm tief				
Streuwert	3.18, horizontal: 3.73, vertikal: 2.52				

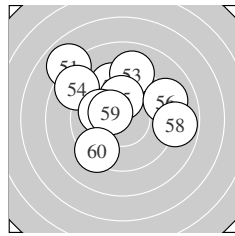

Serie 6:	7.9 ↖	9.5 ↗	9.1 ↑	8.7 ↖	10.1 ↑
	9.1 →	10.0 ←	8.8 →	10.4 *	9.3 ↙
beste Teiler	139.5 (59.)	212.3 (55.)	233.0 (57.)		
Trefferlage	0.67 mm links, 1.81 mm hoch				
Streuwert	3.02, horizontal: 3.45, vertikal: 2.51				

Meyton Elektronik

ISSF AR Women Jun – Wertung – Juniorinnen

StandNr: 113

Sponring, Lea #96

StartNr: 61

20. Januar 2018 11:20

T – SG Eben

Unterschrift des Schützen

Meyton Elektronik

Ergebnis:	620.3	(592)
Serien:	102.9	100.7 105.5 102.5 104.5 104.2
Zähler:	52 8	0 0 0 0 0 0 0 0
Innenzehner:	46	
weiteste:	449 (31), 410 (12), 359 (13)	
beste Teiler	9.8 (28.)	21.0 (48.) 43.3 (2.)
Trefferlage	0.00 mm , 0.28 mm hoch	
Streuwert	1.26, horizontal: 1.31, vertikal: 1.20	

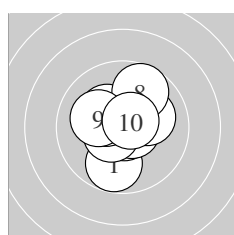
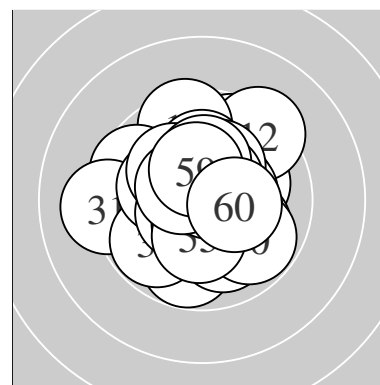

Serie 1:	9.8 ↓	10.8 *	10.6 *	10.5 *	10.4 *
	10.1 ↗	10.3 *	9.7 ↑	10.1 ↖	10.6 *
beste Teiler	43.3 (2.) 76.5 (3.) 81.0 (10.)				
Trefferlage	0.11 mm links, 0.26 mm hoch				
Streuwert	1.37, horizontal: 1.28, vertikal: 1.45				

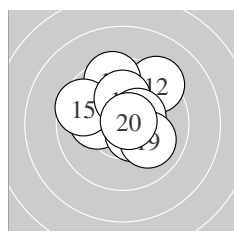

Serie 2:	10.1 ↖	9.3 ↗	9.5 ↑	10.5 *	9.6 ↖
	10.5 *	10.1 ↑	10.4 *	10.0 ↘	10.7 *
beste Teiler	53.6 (20.) 102.0 (16.) 112.0 (14.)				
Trefferlage	0.17 mm rechts, 1.00 mm hoch				
Streuwert	1.65, horizontal: 1.75, vertikal: 1.53				

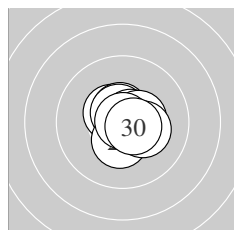

Serie 3:	10.5 *	10.6 *	10.6 *	10.7 *	10.4 *
	10.5 *	10.4 *	10.9 *	10.3 *	10.6 *
beste Teiler	9.8 (28.) 72.0 (24.) 81.1 (23.)				
Trefferlage	0.38 mm rechts, 0.02 mm hoch				
Streuwert	0.77, horizontal: 0.81, vertikal: 0.73				

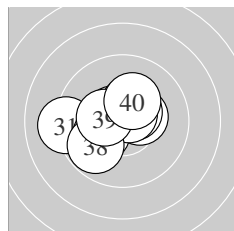

Serie 4:	9.2 ↖	10.6 *	10.2 *	10.4 *	10.4 *
	10.5 *	10.7 *	9.8 ↙	10.4 *	10.3 *
beste Teiler	72.8 (37.) 93.4 (32.) 113.8 (36.)				
Trefferlage	0.64 mm links, 0.20 mm hoch				
Streuwert	1.47, horizontal: 1.81, vertikal: 1.03				

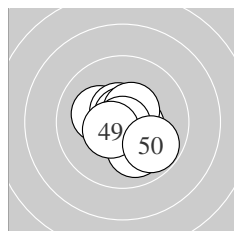

Serie 5:	10.5 *	10.2 *	10.6 *	10.7 *	10.8 *
	10.5 *	10.0 ↘	10.9 *	10.5 *	9.8 ↘
beste Teiler	21.0 (48.) 50.1 (45.) 68.1 (44.)				
Trefferlage	0.23 mm rechts, 0.16 mm tief				
Streuwert	1.10, horizontal: 1.14, vertikal: 1.07				

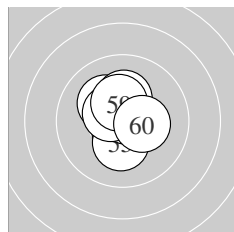

Serie 6:	10.4 *	10.5 *	10.2 *	10.7 *	10.3 *
	10.7 *	10.2 *	10.5 *	10.4 *	10.3 *
beste Teiler	54.4 (56.) 71.7 (54.) 112.6 (58.)				
Trefferlage	0.05 mm links, 0.36 mm hoch				
Streuwert	1.01, horizontal: 0.81, vertikal: 1.17				

Meyton Elektronik

ISSF AR Women Jun – Wertung – Juniorinnen

StandNr: 114

Surny, Kim #97

StartNr: 62

20. Januar 2018 11:31

SUI

Unterschrift des Schützen

Meyton Elektronik

Ergebnis: **602.8** (575)
 Serien: 102.2 99.8 100.8 98.3 99.6 102.1
 Zähler: 37 21 2 0 0 0 0 0 0
 Innenzehner: 31
 weiteste: 565 (28), 511 (48), 491 (40)
 beste Teiler 30.0 (24.) 32.2 (5.) 41.2 (4.)
 Trefferlage 0.28 mm links, 0.00 mm
 Streuwert 1.83, horizontal: 2.16, vertikal: 1.43

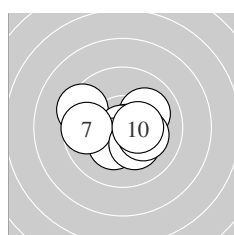
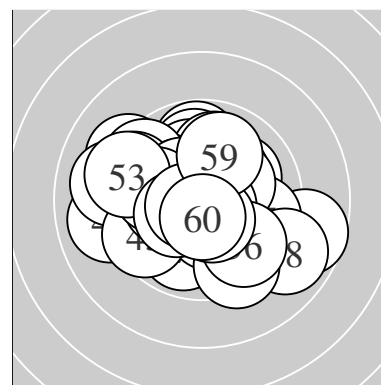

Serie 1:
 10.1 ↗ 10.3 * 9.4 ↘ 10.8 * 10.8 *
 10.3 * 9.7 ← 10.2 * 10.2 * 10.4 *
 beste Teiler 32.2 (5.) 41.2 (4.) 133.0 (10.)
 Trefferlage 0.01 mm rechts, 0.28 mm tief
 Streuwert 1.55, horizontal: 1.94, vertikal: 1.02

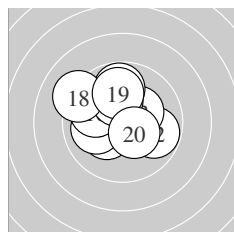

Serie 2:
 10.3 * 9.8 → 10.3 * 9.8 ↑ 10.0 ←
 9.9 ↖ 10.2 * 9.2 ↘ 9.9 ↑ 10.4 *
 beste Teiler 136.6 (20.) 162.2 (13.) 170.8 (11.)
 Trefferlage 0.59 mm links, 0.80 mm hoch
 Streuwert 1.77, horizontal: 1.97, vertikal: 1.55

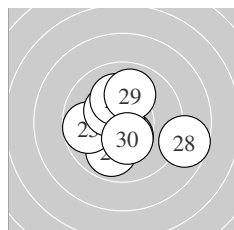

Serie 3:
 10.4 * 9.9 ↓ 10.5 * 10.8 * 9.7 ←
 10.3 * 10.1 ↑ 8.7 → 10.0 ↑ 10.4 *
 beste Teiler 30.0 (24.) 119.6 (23.) 132.1 (21.)
 Trefferlage 0.00 mm, 0.11 mm tief
 Streuwert 1.92, horizontal: 2.17, vertikal: 1.63

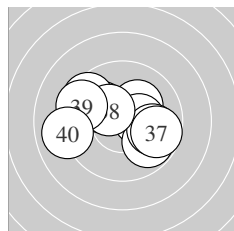

Serie 4:
 10.2 * 10.4 * 9.8 ↘ 10.1 ↘ 9.5 ↘
 9.9 → 9.7 → 10.3 * 9.4 ↘ 9.0 ←
 beste Teiler 144.6 (32.) 152.1 (38.) 186.0 (31.)
 Trefferlage 0.39 mm links, 0.24 mm hoch
 Streuwert 2.20, horizontal: 2.83, vertikal: 1.30

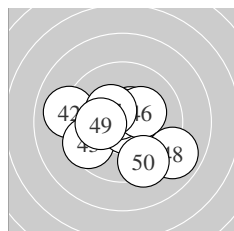

Serie 5:
 10.5 * 9.1 ← 9.6 ↙ 10.7 * 10.6 *
 10.2 * 10.4 * 8.9 ↘ 10.2 * 9.4 ↓
 beste Teiler 60.9 (44.) 79.1 (45.) 106.0 (41.)
 Trefferlage 0.22 mm links, 0.43 mm tief
 Streuwert 2.17, horizontal: 2.59, vertikal: 1.65

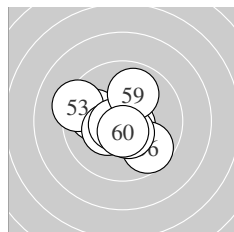

Serie 6:
 10.0 ↖ 10.5 * 9.3 ↘ 10.3 * 10.7 *
 9.7 ↘ 10.5 * 10.6 * 9.9 ↑ 10.6 *
 beste Teiler 69.8 (55.) 80.6 (58.) 90.0 (60.)
 Trefferlage 0.50 mm links, 0.21 mm tief
 Streuwert 1.56, horizontal: 1.77, vertikal: 1.31

ISSF AR Women Jun – Wertung – Juniorinnen

StandNr: 115

Merkl, Tatjana #98

StartNr: 63

20. Januar 2018 11:21

BAY – Schwaben

Unterschrift des Schützen

Meyton Elektronik

Ergebnis:	618.1	(595)
Serien:	102.7	103.3 103.3 103.4 102.5 102.9
Zähler:	55	5 0 0 0 0 0 0 0 0
Innenzehner:	44	
weiteste:	426	(1), 369 (7), 337 (54)
beste Teiler	3.1	(5.) 54.0 (6.) 60.4 (13.)
Trefferlage	0.04	mm links, 0.35 mm hoch
Streuwert	1.26,	horizontal: 1.09, vertikal: 1.42

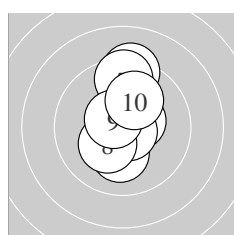
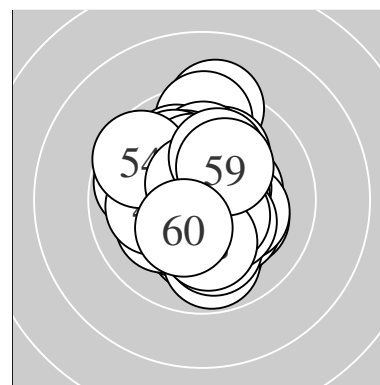

Serie 1:	9.2 ↑	10.2 *	10.7 *	10.5 *	10.9 *
	10.7 *	9.5 ↑	10.3 *	10.6 *	10.1 ↗
beste Teiler	3.1	(5.) 54.0 (6.)	75.4 (3.)		
Trefferlage	0.05	mm rechts,	0.80 mm hoch		
Streuwert	1.50,	horizontal: 0.71,	vertikal: 2.00		

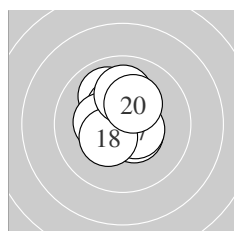

Serie 2:	10.0 ↘	10.5 *	10.7 *	10.4 *	10.3 *
	10.2 *	10.5 *	10.4 *	10.0 ↑	10.3 *
beste Teiler	60.4	(13.) 107.1 (17.)	115.1 (12.)		
Trefferlage	0.12	mm links,	0.77 mm hoch		
Streuwert	1.09,	horizontal: 0.93,	vertikal: 1.23		

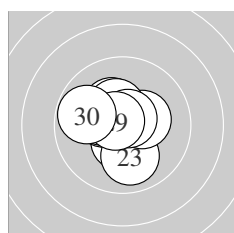

Serie 3:	10.5 *	10.3 *	10.0 ↓	10.3 *	10.3 *
	10.3 *	10.4 *	10.7 *	10.7 *	9.8 ↖
beste Teiler	64.0	(28.) 64.4 (29.)	124.6 (21.)		
Trefferlage	0.53	mm links,	0.24 mm hoch		
Streuwert	1.18,	horizontal: 1.21,	vertikal: 1.16		

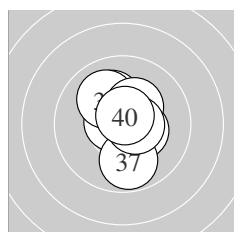

Serie 4:	10.4 *	10.7 *	10.1 ↘	10.7 *	10.1 ↘
	10.0 ↘	9.8 ↓	10.3 *	10.6 *	10.7 *
beste Teiler	67.4	(40.) 68.8 (32.)	74.5 (34.)		
Trefferlage	0.03	mm links,	0.49 mm hoch		
Streuwert	1.20,	horizontal: 0.93,	vertikal: 1.43		

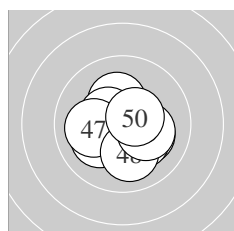

Serie 5:	10.2 *	10.2 *	10.4 *	10.2 *	10.1 ↖
	10.5 *	10.1 ↖	10.1 ↓	10.2 *	10.5 *
beste Teiler	109.7	(50.) 125.7 (46.)	136.0 (43.)		
Trefferlage	0.21	mm rechts,	0.39 mm tief		
Streuwert	1.31,	horizontal: 1.48,	vertikal: 1.10		

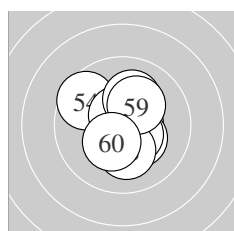

Serie 6:	10.6 *	10.5 *	10.3 *	9.6 ↘	10.5 *
	10.6 *	10.1 ↑	10.2 *	10.2 *	10.3 *
beste Teiler	84.0	(56.) 89.1 (51.)	105.3 (52.)		
Trefferlage	0.13	mm rechts,	0.23 mm hoch		
Streuwert	1.32,	horizontal: 1.22,	vertikal: 1.41		

Meyton Elektronik

ISSF AR Women Jun – Wertung – Juniorinnen

StandNr: 116

Zaisberger, Verena #99

StartNr: 64

20. Januar 2018 11:32

AUT

Unterschrift des Schützen

Meyton Elektronik

Ergebnis: **612.0** (584)
 Serien: 100.3 103.0 102.8 103.6 100.4 101.9
 Zähler: 44 16 0 0 0 0 0 0 0
 Innenzehner: 37
 weiteste: 376 (30), 364 (48), 360 (31)
 beste Teiler 50.2 (20.) 50.9 (29.) 56.0 (56.)
 Trefferlage 0.27 mm links, 0.36 mm hoch
 Streuwert 1.44, horizontal: 1.81, vertikal: 0.95

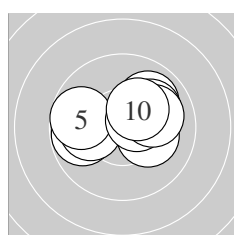
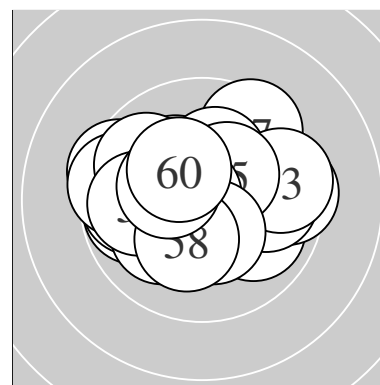

Serie 1:
 9.9 ← 9.9 ↗ 9.8 ← 10.0 ← 9.7 ←
 10.2 * 10.0 ↘ 10.5 * 10.0 → 10.3 *
 beste Teiler 113.5 (8.) 167.4 (10.) 191.0 (6.)
 Trefferlage 0.09 mm links, 0.51 mm hoch
 Streuwert 1.70, horizontal: 2.27, vertikal: 0.79

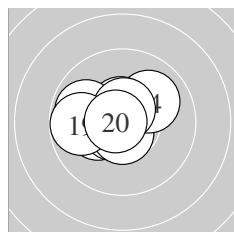

Serie 2:
 10.2 * 10.6 * 10.6 * 10.0 ↗ 10.0 ←
 10.5 * 9.9 ← 10.6 * 9.8 ← 10.8 *
 beste Teiler 50.2 (20.) 78.0 (13.) 85.0 (12.)
 Trefferlage 0.91 mm links, 0.26 mm hoch
 Streuwert 1.19, horizontal: 1.51, vertikal: 0.76

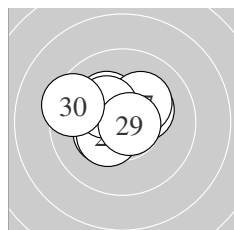

Serie 3:
 10.4 * 10.2 * 10.6 * 10.2 * 10.3 *
 10.4 * 10.2 * 10.3 * 10.8 * 9.4 ←
 beste Teiler 50.9 (29.) 85.2 (23.) 141.0 (26.)
 Trefferlage 0.68 mm links, 0.57 mm hoch
 Streuwert 1.23, horizontal: 1.51, vertikal: 0.86

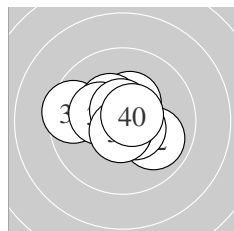

Serie 4:
 9.5 ← 9.9 ↘ 10.5 * 10.4 * 10.4 *
 10.7 * 10.3 * 10.6 * 10.7 * 10.6 *
 beste Teiler 63.9 (36.) 74.5 (39.) 78.9 (38.)
 Trefferlage 0.21 mm links, 0.17 mm hoch
 Streuwert 1.27, horizontal: 1.56, vertikal: 0.88

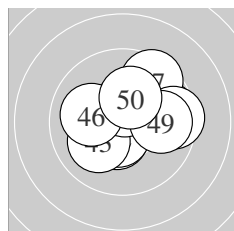

Serie 5:
 10.5 * 10.5 * 10.1 ↙ 10.5 * 9.7 →
 10.0 ← 9.5 ↗ 9.5 → 9.9 → 10.2 *
 beste Teiler 103.4 (42.) 119.0 (44.) 123.0 (41.)
 Trefferlage 0.75 mm rechts, 0.39 mm hoch
 Streuwert 1.72, horizontal: 2.02, vertikal: 1.36

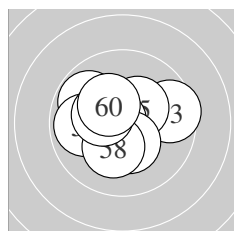

Serie 6:
 9.8 ↘ 9.9 ← 9.6 → 10.4 * 10.3 *
 10.7 * 10.4 * 10.2 * 10.3 * 10.3 *
 beste Teiler 56.0 (56.) 146.1 (57.) 149.4 (54.)
 Trefferlage 0.51 mm links, 0.29 mm hoch
 Streuwert 1.48, horizontal: 1.79, vertikal: 1.09

ISSF AR Women Jun – Wertung –

Juniorinnen

StartNr: 65

StandNr: 117

20. Januar 2018 11:44

Nurul, Syafiqa Binte Nassaruddin #100

SGP

Unterschrift des Schützen

Meyton Elektronik

Ergebnis: **594.6** (568)

Serien: 99.0 100.6 97.7 100.4 99.5 97.4

Zähler: 33 23 3 1 0 0 0 0 0 0

Innenzehner: 26

weiteste: 826 (44), 572 (27), 550 (58)

beste Teiler 73.8 (46.) 74.0 (56.) 87.7 (32.)

Trefferlage 0.37 mm rechts, 0.10 mm tief

Streuwert 2.10, horizontal: 2.22, vertikal: 1.99

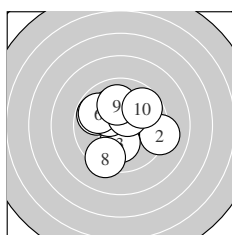
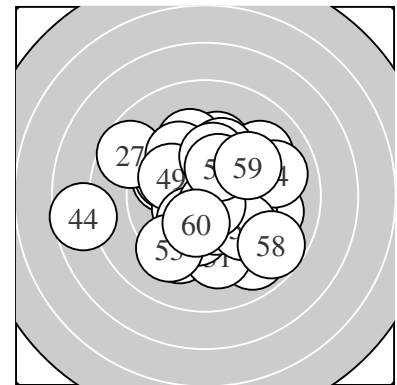

Serie 1:

10.1 ↖	9.2 →	10.2 *	9.8 ↙	10.3 *
9.8 ↙	10.5 *	9.4 ↘	10.0 ↑	9.7 ↗

beste Teiler 125.4 (7.) 162.6 (5.) 193.1 (3.)

Trefferlage 0.20 mm links, 0.38 mm hoch

Streuwert 2.07, horizontal: 2.21, vertikal: 1.92

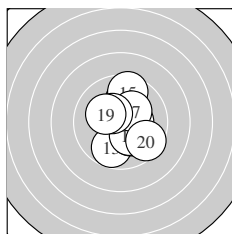

Serie 2:

10.4 *	9.9 ↑	9.8 ↘	10.2 *	9.6 ↑
10.2 *	10.3 *	10.4 *	10.2 *	9.6 ↘

beste Teiler 132.9 (18.) 145.1 (11.) 174.6 (17.)

Trefferlage 0.53 mm rechts, 0.11 mm hoch

Streuwert 1.73, horizontal: 1.35, vertikal: 2.04

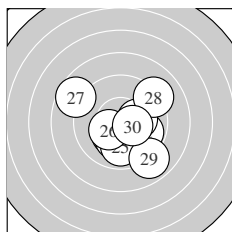

Serie 3:

10.3 *	9.8 →	10.2 *	10.1 ↘	9.9 ↓
10.3 *	8.7 ↙	9.1 ↗	8.9 ↘	10.4 *

beste Teiler 139.5 (30.) 156.1 (26.) 172.2 (21.)

Trefferlage 0.47 mm rechts, 0.64 mm tief

Streuwert 2.40, horizontal: 2.61, vertikal: 2.17

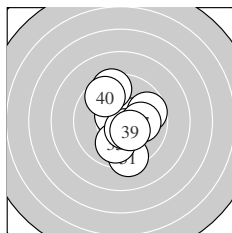

Serie 4:

9.3 ↓	10.6 *	10.5 *	9.7 →	10.0 ↓
10.6 *	10.1 →	9.5 ↑	10.4 *	9.7 ↙

beste Teiler 87.7 (32.) 98.3 (36.) 115.5 (33.)

Trefferlage 0.46 mm rechts, 0.02 mm tief

Streuwert 1.89, horizontal: 1.48, vertikal: 2.23

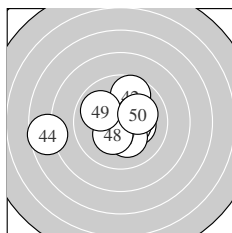

Serie 5:

10.3 *	9.7 ↑	10.2 *	7.6 ←	10.5 *
10.7 *	10.2 *	10.3 *	9.9 ↙	10.1 →

beste Teiler 73.8 (46.) 120.5 (45.) 161.4 (48.)

Trefferlage 0.24 mm links, 0.00 mm

Streuwert 2.40, horizontal: 3.07, vertikal: 1.45

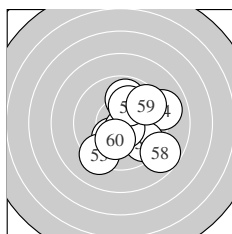

Serie 6:

10.2 *	9.9 ↑	9.3 ↘	9.0 →	9.6 ↘
10.7 *	10.1 ↑	8.8 ↘	9.6 ↗	10.2 *

beste Teiler 74.0 (56.) 191.6 (60.) 193.7 (51.)

Trefferlage 1.23 mm rechts, 0.48 mm tief

Streuwert 2.32, horizontal: 2.33, vertikal: 2.31

Meyton Elektronik

ISSF AR Women Jun – Wertung – Juniorinnen

StandNr: 118

Rinner, Pia #101

StartNr: 66

20. Januar 2018 11:42

BAY – Schwaben

Unterschrift des Schützen

Meyton Elektronik

Ergebnis: **615.3** (587)
 Serien: 102.7 103.4 103.7 103.1 101.8 100.6
 Zähler: 47 13 0 0 0 0 0 0 0
 Innenzehner: 40
 weiteste: 459 (45), 409 (14), 378 (53)
 beste Teiler 25.3 (13.) 26.9 (42.) 34.0 (51.)
 Trefferlage 0.13 mm links, 0.24 mm hoch
 Streuwert 1.43, horizontal: 1.44, vertikal: 1.42

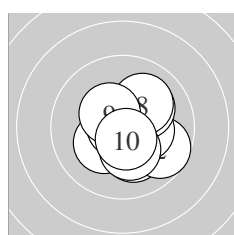
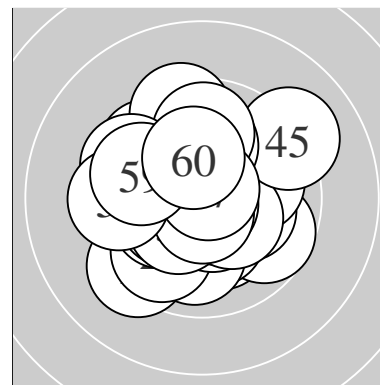

Serie 1:
 10.2 * 9.7 ↘ 10.3 * 10.1 ↗ 10.2 *
 10.3 * 10.8 * 10.1 ↗ 10.4 * 10.6 *
 beste Teiler 37.0 (7.) 91.4 (10.) 136.5 (9.)
 Trefferlage 0.62 mm rechts, 0.30 mm tief
 Streuwert 1.28, horizontal: 1.26, vertikal: 1.29

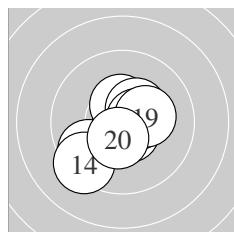

Serie 2:
 10.8 * 9.7 ↙ 10.9 * 9.3 ↘ 10.4 *
 10.4 * 10.6 * 10.5 * 10.3 * 10.5 *
 beste Teiler 25.3 (13.) 36.4 (11.) 83.7 (17.)
 Trefferlage 0.15 mm links, 0.39 mm tief
 Streuwert 1.40, horizontal: 1.46, vertikal: 1.35

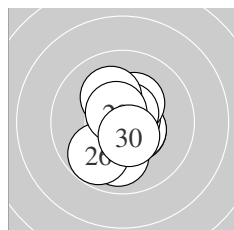

Serie 3:
 10.0 ↓ 10.5 * 10.5 * 10.7 * 10.3 *
 9.8 ↙ 10.7 * 10.1 ↘ 10.6 * 10.5 *
 beste Teiler 56.7 (24.) 75.8 (27.) 85.9 (29.)
 Trefferlage 0.06 mm rechts, 0.20 mm tief
 Streuwert 1.20, horizontal: 0.89, vertikal: 1.45

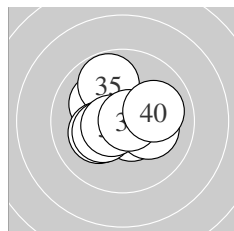

Serie 4:
 10.6 * 10.5 * 10.1 ↘ 10.2 * 9.8 ↘
 10.2 * 10.3 * 10.6 * 10.8 * 10.0 →
 beste Teiler 46.2 (39.) 87.8 (38.) 94.7 (31.)
 Trefferlage 0.04 mm links, 0.19 mm hoch
 Streuwert 1.32, horizontal: 1.49, vertikal: 1.12

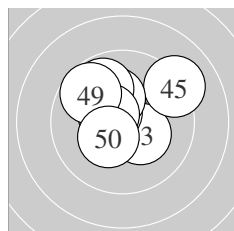

Serie 5:
 10.5 * 10.8 * 10.3 * 10.5 * 9.1 ↗
 10.2 * 9.8 ↘ 10.5 * 9.7 ↘ 10.4 *
 beste Teiler 26.9 (42.) 107.0 (44.) 116.3 (48.)
 Trefferlage 0.28 mm links, 0.93 mm hoch
 Streuwert 1.52, horizontal: 1.71, vertikal: 1.30

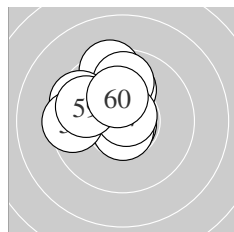

Serie 6:
 10.8 * 10.0 ↑ 9.4 ↑ 9.8 ↑ 9.6 ↘
 10.7 * 10.8 * 9.5 ← 9.8 ↙ 10.2 *
 beste Teiler 34.0 (51.) 47.4 (57.) 63.0 (56.)
 Trefferlage 0.99 mm links, 1.24 mm hoch
 Streuwert 1.48, horizontal: 1.54, vertikal: 1.41

ISSF AR Women Jun – Wertung – Juniorinnen

StandNr: 119

Suremann, Lisa #102

StartNr: 67

20. Januar 2018 11:34

SUI

Unterschrift des Schützen

Meyton Elektronik

Ergebnis: **614.8** (587)
 Serien: 102.1 104.1 103.4 102.4 102.5 100.3
 Zähler: 47 13 0 0 0 0 0 0 0
 Innenzehner: 40
 weiteste: 399 (9), 387 (42), 372 (24)
 beste Teiler 31.1 (41.) 35.9 (13.) 44.5 (14.)
 Trefferlage 0.09 mm links, 0.09 mm hoch
 Streuwert 1.42, horizontal: 1.52, vertikal: 1.30

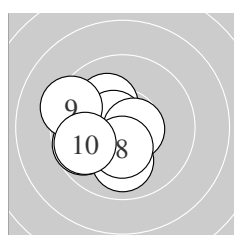
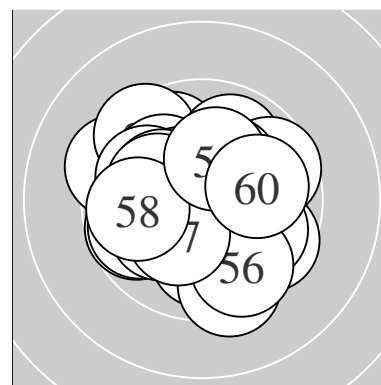

Serie 1:
 10.7 * 9.7 ← 10.2 * 10.7 * 10.0 ↓
 10.6 * 10.6 * 10.4 * 9.4 ↖ 9.8 ←
 beste Teiler 63.6 (1.) 64.7 (4.) 79.0 (6.)
 Trefferlage 1.11 mm links, 0.34 mm tief
 Streuwert 1.39, horizontal: 1.48, vertikal: 1.30

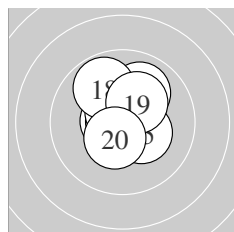

Serie 2:
 10.6 * 10.5 * 10.8 * 10.8 * 10.3 *
 10.6 * 10.0 ↗ 9.8 ↘ 10.3 * 10.4 *
 beste Teiler 35.9 (13.) 44.5 (14.) 84.3 (11.)
 Trefferlage 0.07 mm rechts, 0.58 mm hoch
 Streuwert 1.06, horizontal: 0.94, vertikal: 1.18

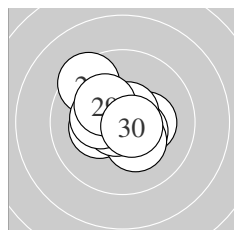

Serie 3:
 10.3 * 10.5 * 10.3 * 9.5 ↘ 10.3 *
 10.7 * 10.6 * 10.3 * 10.2 * 10.7 *
 beste Teiler 52.3 (26.) 72.4 (30.) 77.0 (27.)
 Trefferlage 0.27 mm links, 0.20 mm hoch
 Streuwert 1.29, horizontal: 1.41, vertikal: 1.16

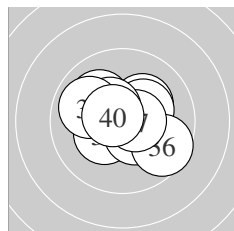

Serie 4:
 10.3 * 10.2 * 10.4 * 10.3 * 10.1 ↘
 9.6 ↘ 10.6 * 10.4 * 9.9 ↖ 10.6 *
 beste Teiler 81.0 (40.) 93.0 (37.) 128.7 (33.)
 Trefferlage 0.06 mm rechts, 0.22 mm hoch
 Streuwert 1.42, horizontal: 1.69, vertikal: 1.08

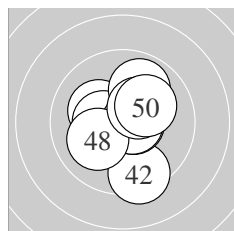

Serie 5:
 10.8 * 9.4 ↓ 10.2 * 10.6 * 10.4 *
 9.9 ↗ 10.7 * 10.1 ← 10.3 * 10.1 ↗
 beste Teiler 31.1 (41.) 70.4 (47.) 79.6 (44.)
 Trefferlage 0.17 mm rechts, 0.00 mm
 Streuwert 1.49, horizontal: 1.33, vertikal: 1.63

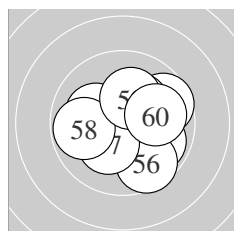

Serie 6:
 9.7 ↗ 10.2 * 10.6 * 9.9 ↘ 10.1 ↘
 9.6 ↓ 10.2 * 9.8 ← 10.2 * 10.0 →
 beste Teiler 94.8 (53.) 177.8 (52.) 179.4 (57.)
 Trefferlage 0.48 mm rechts, 0.10 mm tief
 Streuwert 1.75, horizontal: 1.97, vertikal: 1.50

ISSF AR Women Jun – Wertung – Juniorinnen

StandNr: 120

Vogl, Jana #103

StartNr: 68

20. Januar 2018 11:11

T – SG Wattens

Unterschrift des Schützen

Meyton Elektronik

Ergebnis:	620.4	(593)
Serien:	102.2	103.3 104.0 104.6 103.4 102.9
Zähler:	53	7 0 0 0 0 0 0 0 0
Innenzehner:	43	
weiteste:	395	(4), 316 (53), 295 (5)
beste Teiler	16.4	(34.) 29.6 (43.) 38.4 (56.)
Trefferlage	0.14 mm	links, 0.28 mm hoch
Streuwert	1.21,	horizontal: 1.31, vertikal: 1.10

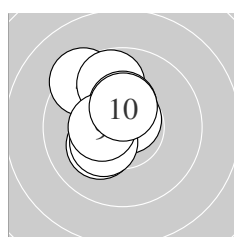
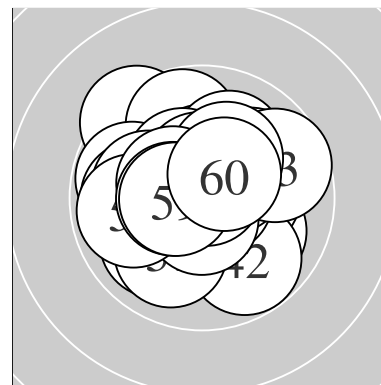

Serie 1:	10.2 *	10.7 *	10.4 *	9.4 ↘	9.8 ↗
	10.4 *	10.2 *	10.3 *	10.4 *	10.4 *
beste Teiler	59.3	(2.) 133.0	(10.) 135.0	(9.)	
Trefferlage	0.80 mm	links, 1.02 mm	hoch		
Streuwert	1.19,	horizontal: 0.88,	vertikal: 1.44		

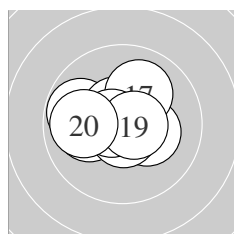

Serie 2:	9.8 ↙	10.5 *	10.3 *	10.1 ←	10.7 *
	10.6 *	10.0 ↗	10.7 *	10.7 *	9.9 ←
beste Teiler	63.3	(15.) 71.2	(18.) 75.3	(19.)	
Trefferlage	0.42 mm	links, 0.28 mm	hoch		
Streuwert	1.26,	horizontal: 1.60,	vertikal: 0.79		

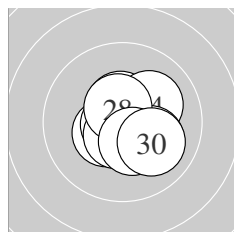

Serie 3:	10.5 *	10.4 *	10.6 *	10.1 ↗	10.7 *
	10.1 ↘	10.6 *	10.6 *	10.4 *	10.0 ↘
beste Teiler	56.3	(25.) 91.0	(27.) 94.5	(23.)	
Trefferlage	0.45 mm	rechts, 0.18 mm	tief		
Streuwert	1.05,	horizontal: 1.09,	vertikal: 1.01		

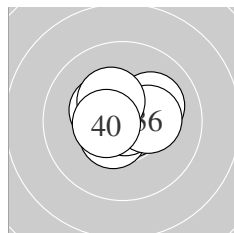

Serie 4:	10.7 *	10.5 *	10.1 ↗	10.9 *	10.5 *
	10.3 *	10.4 *	10.4 *	10.3 *	10.5 *
beste Teiler	16.4	(34.) 54.8	(31.) 108.1	(40.)	
Trefferlage	0.14 mm	links, 0.35 mm	hoch		
Streuwert	0.95,	horizontal: 1.15,	vertikal: 0.68		

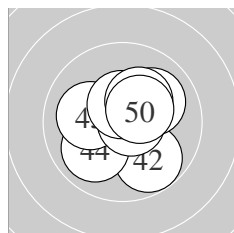

Serie 5:	10.8 *	9.8 ↘	10.8 *	10.0 ↗	10.1 ←
	10.7 *	10.0 ↗	10.5 *	10.3 *	10.4 *
beste Teiler	29.6	(43.) 50.4	(41.) 57.0	(46.)	
Trefferlage	0.29 mm	rechts, 0.09 mm	hoch		
Streuwert	1.31,	horizontal: 1.35,	vertikal: 1.27		

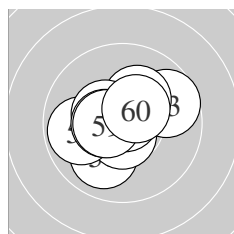

Serie 6:	10.0 ↗	10.6 *	9.7 ↗	10.2 *	9.8 ←
	10.8 *	10.4 *	10.5 *	10.5 *	10.4 *
beste Teiler	38.4	(56.) 80.0	(52.) 104.1	(59.)	
Trefferlage	0.24 mm	links, 0.12 mm	hoch		
Streuwert	1.35,	horizontal: 1.57,	vertikal: 1.08		

Meyton Elektronik

ISSF AR Women Jun – Wertung – Juniorinnen

StandNr: 121

Waibel, Sheileen #104

StartNr: 69

20. Januar 2018 11:27

AUT

Unterschrift des Schützen

Meyton Elektronik

Ergebnis:	616.1	(588)
Serien:	102.3	103.0 103.0 102.4 102.7 102.7
Zähler:	48	12 0 0 0 0 0 0 0 0
Innenzehner:	39	
weiteste:	362	(38), 342 (47), 333 (15)
beste Teiler	10.8	(28.) 49.0 (18.) 58.4 (1.)
Trefferlage	0.24 mm	rechts, 0.44 mm hoch
Streuwert	1.32,	horizontal: 1.56, vertikal: 1.01

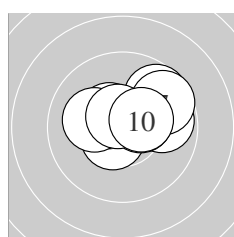
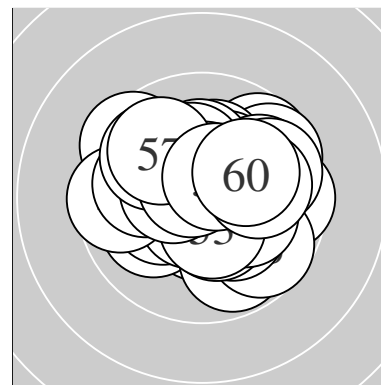

Serie 1:				
10.7 *	10.4 *	10.6 *	9.8 →	9.7 ↗
10.1 ←	9.6 ↗	10.4 *	10.6 *	10.4 *
beste Teiler	58.4 (1.)	81.9 (9.)	99.7 (3.)	
Trefferlage	0.64 mm rechts, 0.72 mm hoch			
Streuwert	1.30, horizontal: 1.67, vertikal: 0.77			

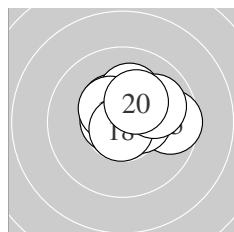

Serie 2:				
10.4 *	10.2 *	10.1 ↗	10.7 *	9.6 →
10.4 *	10.5 *	10.8 *	10.0 ↗	10.3 *
beste Teiler	49.0 (18.)	73.9 (14.)	118.2 (17.)	
Trefferlage	0.77 mm rechts, 0.70 mm hoch			
Streuwert	1.13, horizontal: 1.42, vertikal: 0.74			

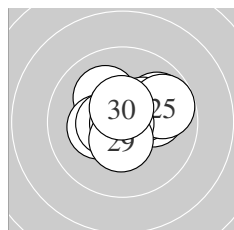

Serie 3:				
10.1 ↘	10.1 →	9.9 ↗	10.3 *	9.8 →
10.3 *	10.5 *	10.9 *	10.5 *	10.6 *
beste Teiler	10.8 (28.)	100.3 (30.)	103.4 (27.)	
Trefferlage	0.45 mm rechts, 0.46 mm hoch			
Streuwert	1.29, horizontal: 1.60, vertikal: 0.89			

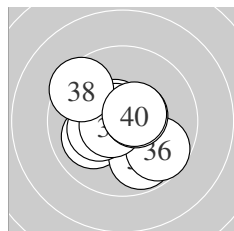

Serie 4:				
10.0 ←	9.8 ↘	10.6 *	10.3 *	10.7 *
9.7 ↘	10.6 *	9.5 ↘	10.6 *	10.6 *
beste Teiler	62.0 (35.)	84.0 (33.)	84.5 (37.)	
Trefferlage	0.28 mm links, 0.22 mm tief			
Streuwert	1.52, horizontal: 1.65, vertikal: 1.37			

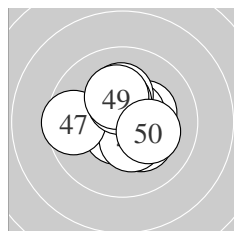

Serie 5:				
10.3 *	10.2 *	10.6 *	10.2 *	10.6 *
10.4 *	9.6 ←	10.4 *	10.2 *	10.2 *
beste Teiler	84.0 (45.)	92.4 (43.)	137.2 (46.)	
Trefferlage	0.13 mm rechts, 0.23 mm hoch			
Streuwert	1.35, horizontal: 1.50, vertikal: 1.19			

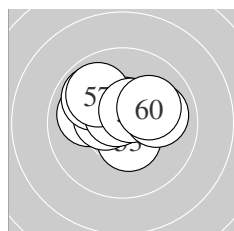

Serie 6:				
10.6 *	10.0 ←	10.5 *	10.5 *	9.9 ↘
10.7 *	9.9 ↘	10.5 *	10.0 →	10.1 ↗
beste Teiler	75.0 (56.)	95.5 (51.)	105.3 (58.)	
Trefferlage	0.24 mm links, 0.75 mm hoch			
Streuwert	1.28, horizontal: 1.61, vertikal: 0.84			

ISSF AR Women Jun – Wertung – Juniorinnen

StandNr: 122

Thurnwaldova, Sabina #105

StartNr: 70

20. Januar 2018 11:34

CZE

Unterschrift des Schützen

Meyton Elektronik

Ergebnis: **620.2** (592)
 Serien: 104.2 103.6 104.0 103.3 104.0 101.1
 Zähler: 52 8 0 0 0 0 0 0 0 0
 Innenzehner: 48
 weiteste: 358 (39), 340 (58), 334 (59)
 beste Teiler 35.3 (8.) 44.2 (14.) 52.4 (28.)
 Trefferlage 0.04 mm rechts, 0.42 mm hoch
 Streuwert 1.19, horizontal: 1.40, vertikal: 0.92

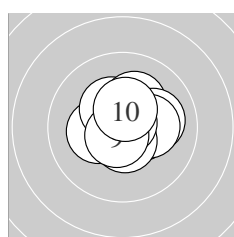
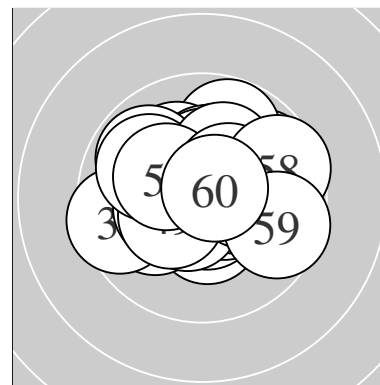

Serie 1:
 10.5 * 10.3 * 10.4 * 10.2 * 10.1 →
 10.2 * 10.6 * 10.8 * 10.7 * 10.4 *
 beste Teiler 35.3 (8.) 71.0 (9.) 96.5 (7.)
 Trefferlage 0.35 mm rechts, 0.30 mm hoch
 Streuwert 1.03, horizontal: 1.17, vertikal: 0.87

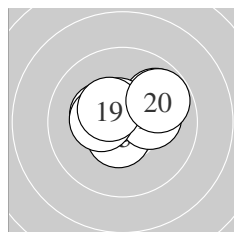

Serie 2:
 10.3 * 10.6 * 9.9 ↗ 10.8 * 10.6 *
 10.6 * 10.2 * 10.4 * 10.4 * 9.8 ↗
 beste Teiler 44.2 (14.) 88.0 (12.) 91.0 (16.)
 Trefferlage 0.13 mm rechts, 0.44 mm hoch
 Streuwert 1.22, horizontal: 1.53, vertikal: 0.79

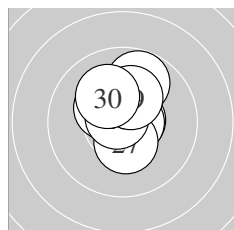

Serie 3:
 10.6 * 10.6 * 10.3 * 9.8 ↑ 10.6 *
 10.7 * 10.4 * 10.7 * 10.2 * 10.1 ↘
 beste Teiler 52.4 (28.) 68.0 (26.) 78.4 (25.)
 Trefferlage 0.09 mm rechts, 0.79 mm hoch
 Streuwert 0.98, horizontal: 0.78, vertikal: 1.14

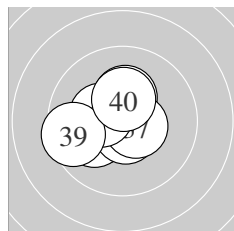

Serie 4:
 10.3 * 10.6 * 10.1 ↙ 10.7 * 10.3 *
 10.6 * 10.6 * 10.3 * 9.5 ← 10.3 *
 beste Teiler 70.2 (34.) 76.4 (32.) 80.0 (36.)
 Trefferlage 0.75 mm links, 0.02 mm hoch
 Streuwert 1.18, horizontal: 1.34, vertikal: 0.99

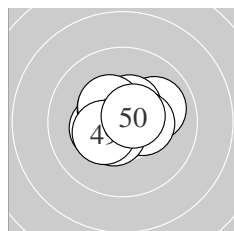

Serie 5:
 10.0 → 10.3 * 10.4 * 10.5 * 10.5 *
 10.4 * 10.4 * 10.5 * 10.4 * 10.6 *
 beste Teiler 85.0 (50.) 103.0 (48.) 115.5 (44.)
 Trefferlage 0.14 mm links, 0.19 mm hoch
 Streuwert 1.06, horizontal: 1.28, vertikal: 0.77

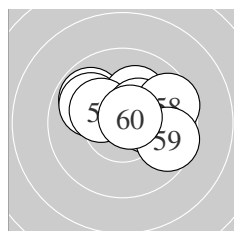

Serie 6:
 9.8 ↖ 9.9 ↖ 10.4 * 10.2 * 10.3 *
 10.2 * 10.4 * 9.6 → 9.6 → 10.7 *
 beste Teiler 67.0 (60.) 142.9 (57.) 149.2 (53.)
 Trefferlage 0.58 mm rechts, 0.80 mm hoch
 Streuwert 1.53, horizontal: 1.99, vertikal: 0.85

ISSF AR Women Jun – Wertung – Juniorinnen

StandNr: 123

Paravati, Paola #106

StartNr: 71

20. Januar 2018 11:15

ITA

Unterschrift des Schützen

Meyton Elektronik

Ergebnis: **611.2** (583)
 Serien: 100.6 102.1 102.9 101.6 102.1 101.9
 Zähler: 43 17 0 0 0 0 0 0 0
 Innenzehner: 31
 weiteste: 377 (9), 362 (45), 340 (46)
 beste Teiler 55.1 (54.) 58.3 (21.) 64.8 (58.)
 Trefferlage 0.00 mm , 0.17 mm hoch
 Streuwert 1.49, horizontal: 1.52, vertikal: 1.45

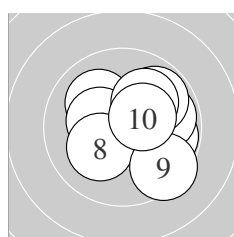
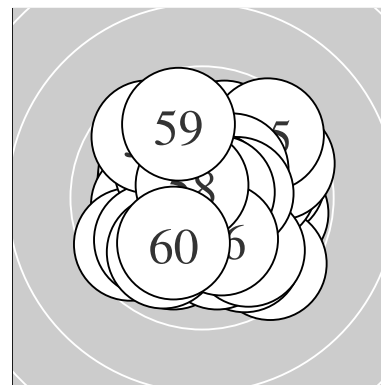

Serie 1:
 9.8 → 10.6 * 10.1 ↘ 10.3 * 9.9 →
 9.8 ↗ 10.1 ↗ 10.2 * 9.4 ↘ 10.4 *
 beste Teiler 91.7 (2.) 148.4 (10.) 156.4 (4.)
 Trefferlage 0.77 mm rechts, 0.27 mm hoch
 Streuwert 1.67, horizontal: 1.90, vertikal: 1.42

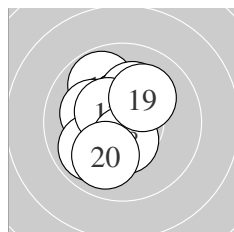

Serie 2:
 9.8 ↖ 10.5 * 10.1 ↖ 9.9 ↙ 10.5 *
 10.2 * 10.5 * 10.5 * 10.1 ↗ 10.0 ↙
 beste Teiler 105.0 (12.) 119.4 (17.) 119.9 (18.)
 Trefferlage 0.55 mm links, 0.43 mm hoch
 Streuwert 1.37, horizontal: 1.12, vertikal: 1.58

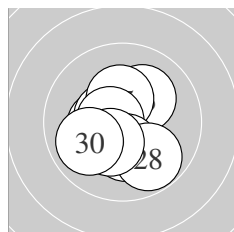

Serie 3:
 10.7 * 10.4 * 10.1 ↗ 10.5 * 10.3 *
 10.6 * 10.3 * 9.8 ↘ 10.3 * 9.9 ↙
 beste Teiler 58.3 (21.) 83.7 (26.) 106.6 (24.)
 Trefferlage 0.30 mm links, 0.26 mm tief
 Streuwert 1.28, horizontal: 1.21, vertikal: 1.34

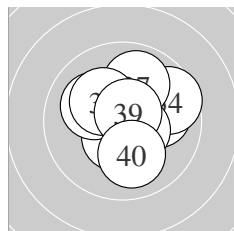

Serie 4:
 10.1 ↗ 10.0 → 10.5 * 9.6 → 10.5 *
 10.1 ↖ 9.9 ↑ 10.2 * 10.7 * 10.0 ↓
 beste Teiler 66.5 (39.) 110.1 (35.) 116.3 (33.)
 Trefferlage 0.63 mm rechts, 0.42 mm hoch
 Streuwert 1.46, horizontal: 1.55, vertikal: 1.35

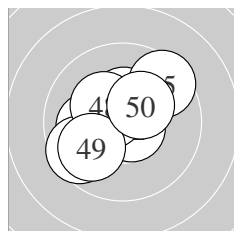

Serie 5:
 10.7 * 10.7 * 10.1 ← 10.4 * 9.5 ↗
 9.6 ↙ 10.6 * 10.3 * 9.9 ↙ 10.3 *
 beste Teiler 70.2 (41.) 71.2 (42.) 94.6 (47.)
 Trefferlage 0.40 mm links, 0.27 mm hoch
 Streuwert 1.56, horizontal: 1.72, vertikal: 1.37

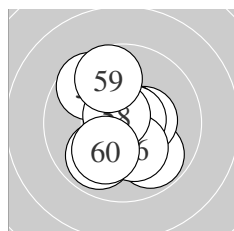

Serie 6:
 9.8 ↘ 10.4 * 9.9 ↙ 10.7 * 10.7 *
 10.2 * 9.7 ↘ 10.7 * 9.7 ↑ 10.1 ↙
 beste Teiler 55.1 (54.) 64.8 (58.) 68.9 (55.)
 Trefferlage 0.11 mm links, 0.10 mm tief
 Streuwert 1.60, horizontal: 1.33, vertikal: 1.82

ISSF AR Women Jun – Wertung – Juniorinnen

StandNr: 124

Stark, Franziska #107

StartNr: 72

20. Januar 2018 11:32

SUI

Unterschrift des Schützen

Meyton Elektronik

Ergebnis: **611.9** (581)
 Serien: 101.1 101.7 102.7 102.2 101.7 102.5
 Zähler: 41 19 0 0 0 0 0 0 0
 Innenzehner: 30
 weiteste: 425 (14), 375 (1), 360 (37)
 beste Teiler 23.5 (32.) 24.1 (29.) 36.1 (52.)
 Trefferlage 0.20 mm links, 0.95 mm hoch
 Streuwert 1.36, horizontal: 1.63, vertikal: 1.02

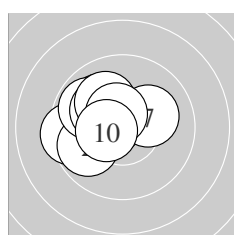
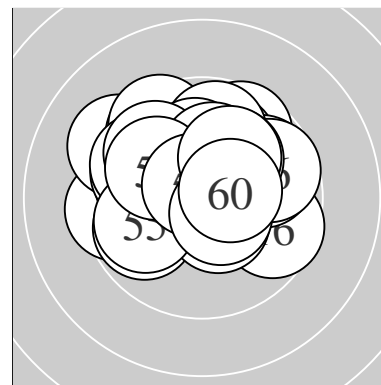

Serie 1:
 9.5 ← 9.8 ↙ 10.0 ↘ 9.8 ↘ 10.2 *
 10.6 * 10.1 → 10.1 ↘ 10.5 * 10.5 *
 beste Teiler 78.3 (6.) 106.0 (9.) 119.6 (10.)
 Trefferlage 1.36 mm links, 0.60 mm hoch
 Streuwert 1.27, horizontal: 1.48, vertikal: 1.01

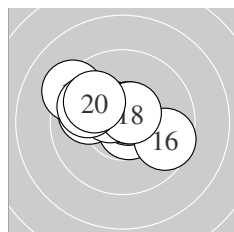

Serie 2:
 9.9 ↙ 10.7 * 10.7 * 9.3 ↘ 10.6 *
 9.6 → 10.5 * 10.6 * 9.9 ↘ 9.9 ↘
 beste Teiler 65.0 (12.) 70.2 (13.) 78.8 (15.)
 Trefferlage 0.66 mm links, 0.64 mm hoch
 Streuwert 1.57, horizontal: 2.00, vertikal: 0.96

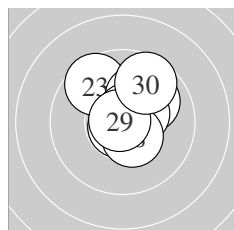

Serie 3:
 10.0 ↗ 10.1 ↘ 9.6 ↘ 10.8 * 10.1 ↗
 10.7 * 10.4 * 10.5 * 10.9 * 9.6 ↗
 beste Teiler 24.1 (29.) 44.0 (24.) 69.1 (26.)
 Trefferlage 0.36 mm rechts, 1.08 mm hoch
 Streuwert 1.24, horizontal: 1.18, vertikal: 1.30

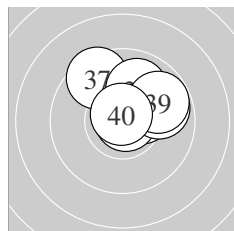

Serie 4:
 10.3 * 10.9 * 10.4 * 10.2 * 10.5 *
 9.8 → 9.5 ↘ 10.0 ↑ 9.8 → 10.8 *
 beste Teiler 23.5 (32.) 49.8 (40.) 122.1 (35.)
 Trefferlage 0.76 mm rechts, 1.30 mm hoch
 Streuwert 1.12, horizontal: 1.30, vertikal: 0.91

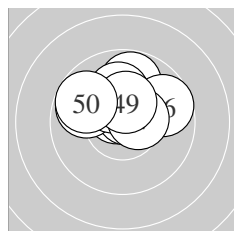

Serie 5:
 10.6 * 10.7 * 9.8 ↘ 10.3 * 9.8 ↑
 9.7 → 10.5 * 10.1 ↑ 10.4 * 9.8 ↘
 beste Teiler 65.8 (42.) 80.1 (41.) 114.7 (47.)
 Trefferlage 0.15 mm links, 1.30 mm hoch
 Streuwert 1.28, horizontal: 1.65, vertikal: 0.76

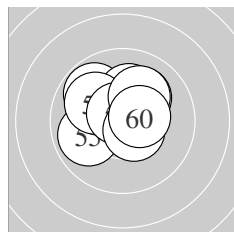

Serie 6:
 9.8 ↘ 10.8 * 10.1 ↗ 10.2 * 9.9 ←
 10.0 ↘ 10.7 * 10.5 * 10.1 ↗ 10.4 *
 beste Teiler 36.1 (52.) 66.2 (57.) 105.8 (58.)
 Trefferlage 0.16 mm links, 0.80 mm hoch
 Streuwert 1.29, horizontal: 1.47, vertikal: 1.08

Meyton Elektronik

ISSF AR Women Jun – Wertung – Juniorinnen

StandNr: 125

Wolf, Melissa #108

StartNr: 73

20. Januar 2018 11:29

VSBL NWLZ

Unterschrift des Schützen

Meyton Elektronik

Ergebnis:	612.8	(589)							
Serien:	100.5	101.8	102.8	102.9	102.6	102.2			
Zähler:	50	9	1	0	0	0	0	0	0
Innenzehner:	36								
weiteste:	553 (1), 437 (19), 339 (9)								
beste Teiler	34.7 (8.)	35.6 (13.)	48.3 (53.)						
Trefferlage	0.09 mm rechts, 0.07 mm hoch								
Streuwert	1.48, horizontal: 1.62, vertikal: 1.32								

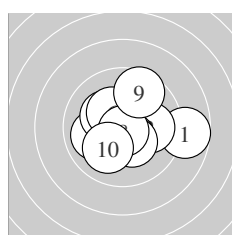
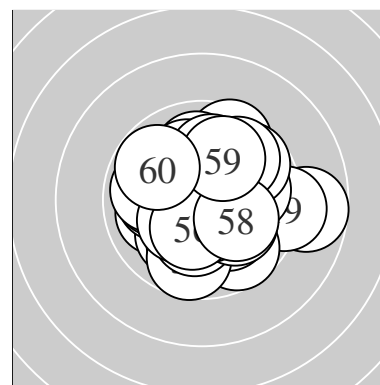

Serie 1:	8.7 →	10.0 →	10.5 *	10.0 ←	10.2 *
	10.3 *	10.3 *	10.8 *	9.6 ↗	10.1 ↘
beste Teiler	34.7 (8.)	108.4 (3.)	152.5 (7.)		
Trefferlage	0.47 mm rechts, 0.02 mm tief				
Streuwert	1.91, horizontal: 2.29, vertikal: 1.44				

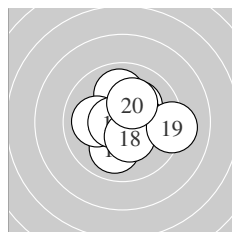

Serie 2:	10.0 ↘	10.0 ↑	10.8 *	10.2 *	10.0 ←
	10.6 *	10.4 *	10.4 *	9.2 →	10.2 *
beste Teiler	35.6 (13.)	82.0 (16.)	141.7 (18.)		
Trefferlage	0.48 mm rechts, 0.17 mm hoch				
Streuwert	1.59, horizontal: 1.76, vertikal: 1.39				

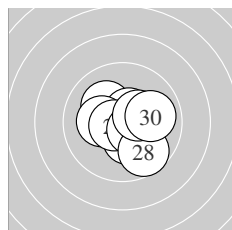

Serie 3:	10.4 *	10.2 *	10.3 *	10.6 *	10.2 *
	10.6 *	10.5 *	9.7 ↘	10.4 *	9.9 →
beste Teiler	79.4 (26.)	94.6 (24.)	107.0 (27.)		
Trefferlage	0.48 mm rechts, 0.17 mm tief				
Streuwert	1.29, horizontal: 1.41, vertikal: 1.16				

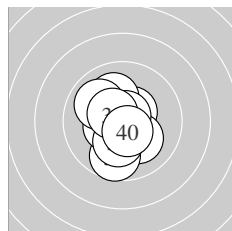

Serie 4:	10.5 *	10.1 ↘	9.7 ↓	10.4 *	10.1 ↗
	10.0 ↘	10.8 *	10.2 *	10.5 *	10.6 *
beste Teiler	50.6 (37.)	98.8 (40.)	110.2 (39.)		
Trefferlage	0.31 mm links, 0.23 mm tief				
Streuwert	1.34, horizontal: 1.02, vertikal: 1.59				

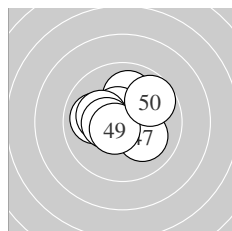

Serie 5:	10.5 *	10.0 ↑	10.5 *	10.6 *	10.0 ←
	10.2 *	10.1 ↘	10.4 *	10.6 *	9.7 ↗
beste Teiler	90.7 (49.)	97.0 (44.)	105.1 (41.)		
Trefferlage	0.41 mm links, 0.49 mm hoch				
Streuwert	1.32, horizontal: 1.54, vertikal: 1.04				

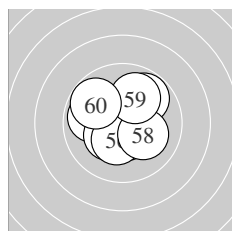

Serie 6:	9.9 ←	10.3 *	10.8 *	10.7 *	10.5 *
	10.3 *	9.8 ↗	10.1 ↘	10.0 ↑	9.8 ↘
beste Teiler	48.3 (53.)	63.0 (54.)	111.8 (55.)		
Trefferlage	0.13 mm links, 0.19 mm hoch				
Streuwert	1.50, horizontal: 1.58, vertikal: 1.42				

ISSF AR Women Jun – Wertung – Juniorinnen

StandNr: 126

Ng, Cecilia #109

StartNr: 74

20. Januar 2018 11:19

SGP

Unterschrift des Schützen

Meyton Elektronik

Ergebnis:	612.2	(587)
Serien:	102.1	104.6 103.4 104.4 98.2 99.5
Zähler:	47	13 0 0 0 0 0 0 0 0
Innenzehner:	36	
weiteste:	424 (45), 415 (41), 366 (56)	
beste Teiler	36.4 (27.)	38.6 (12.) 39.2 (31.)
Trefferlage	0.02 mm links, 0.56 mm hoch	
Streuwert	1.45, horizontal: 1.38, vertikal: 1.52	

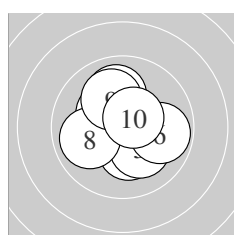
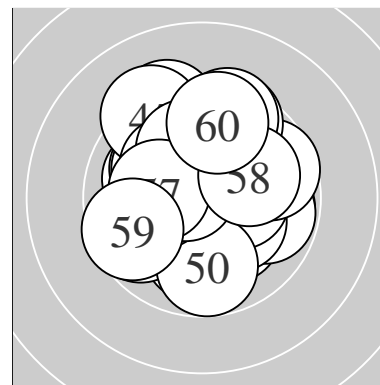

Serie 1:	10.5 *	10.3 *	10.2 *	10.0 ↑	10.3 *
	9.8 →	10.5 *	9.9 ←	10.1 ↑	10.5 *
beste Teiler	105.5 (10.) 113.6 (1.) 115.1 (7.)				
Trefferlage	0.05 mm links, 0.38 mm hoch				
Streuwert	1.42, horizontal: 1.43, vertikal: 1.41				

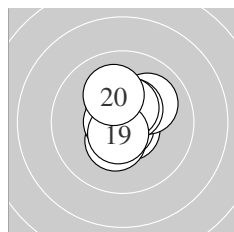

Serie 2:	10.7 *	10.8 *	10.3 *	10.4 *	10.0 ↗
	10.7 *	10.5 *	10.5 *	10.6 *	10.1 ↑
beste Teiler	38.6 (12.) 64.0 (16.) 75.8 (11.)				
Trefferlage	0.08 mm rechts, 0.37 mm hoch				
Streuwert	0.98, horizontal: 0.80, vertikal: 1.14				

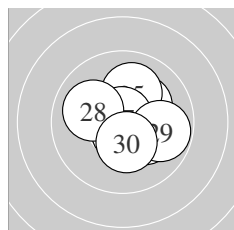

Serie 3:	10.6 *	10.2 *	10.7 *	10.2 *	10.1 ↑
	10.6 *	10.8 *	10.0 ↖	9.8 →	10.4 *
beste Teiler	36.4 (27.) 72.1 (23.) 87.0 (26.)				
Trefferlage	0.57 mm rechts, 0.09 mm hoch				
Streuwert	1.22, horizontal: 1.29, vertikal: 1.14				

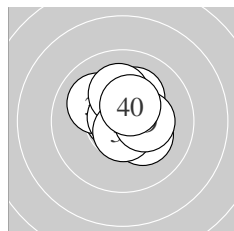

Serie 4:	10.8 *	10.2 *	10.7 *	10.1 ↘	10.8 *
	10.2 *	10.2 *	10.7 *	10.3 *	10.4 *
beste Teiler	39.2 (31.) 45.6 (35.) 59.0 (33.)				
Trefferlage	0.16 mm rechts, 0.52 mm hoch				
Streuwert	1.02, horizontal: 1.03, vertikal: 1.00				

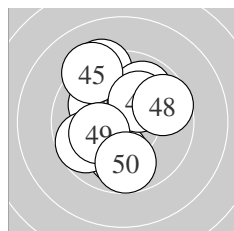

Serie 5:	9.3 ↘	10.0 ↓	9.9 ↗	10.1 ↘	9.3 ↘
	10.2 *	9.7 ←	9.7 →	10.2 *	9.8 ↓
beste Teiler	190.8 (46.) 190.9 (49.) 217.0 (44.)				
Trefferlage	0.45 mm links, 0.60 mm hoch				
Streuwert	2.15, horizontal: 1.86, vertikal: 2.40				

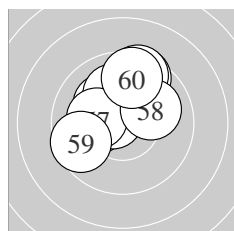

Serie 6:	9.5 ↑	10.2 *	10.2 *	10.1 ↑	10.6 *
	9.5 ↑	10.2 *	10.0 →	9.6 ←	9.6 ↑
beste Teiler	80.5 (55.) 189.0 (52.) 191.8 (57.)				
Trefferlage	0.44 mm links, 1.38 mm hoch				
Streuwert	1.66, horizontal: 1.68, vertikal: 1.65				

Meyton Elektronik

ISSF AR Women Jun – Wertung – Juniorinnen

StandNr: 127

Pichler, Julia #110

StartNr: 75

20. Januar 2018 11:45

AUT

Unterschrift des Schützen

Meyton Elektronik

Ergebnis: **614.4** (587)
 Serien: 104.1 102.8 104.8 100.0 101.0 101.7
 Zähler: 47 13 0 0 0 0 0 0 0
 Innenzehner: 35
 weiteste: 481 (43), 413 (38), 409 (35)
 beste Teiler 30.8 (46.) 34.3 (24.) 38.6 (21.)
 Trefferlage 0.67 mm rechts, 0.34 mm hoch
 Streuwert 1.37, horizontal: 1.47, vertikal: 1.27

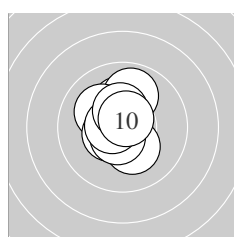
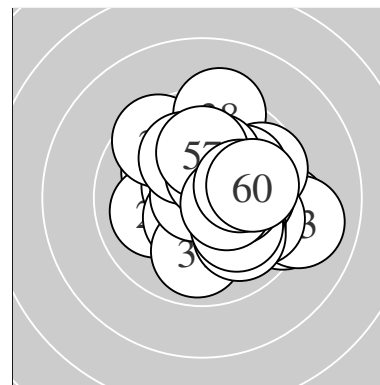

Serie 1:
 10.8 * 10.2 * 9.9 ↑ 10.3 * 10.1 ↘
 10.5 * 10.6 * 10.6 * 10.4 * 10.7 *
 beste Teiler 45.2 (1.) 73.1 (10.) 83.7 (8.)
 Trefferlage 0.28 mm links, 0.53 mm hoch
 Streuwert 1.04, horizontal: 0.76, vertikal: 1.26

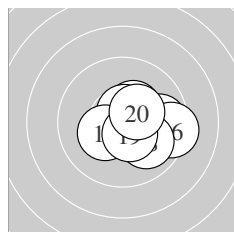

Serie 2:
 10.6 * 10.4 * 10.8 * 9.8 → 10.6 *
 9.4 → 10.3 * 10.0 ↘ 10.5 * 10.4 *
 beste Teiler 45.6 (13.) 81.2 (15.) 95.1 (11.)
 Trefferlage 1.09 mm rechts, 0.07 mm tief
 Streuwert 1.25, horizontal: 1.51, vertikal: 0.92

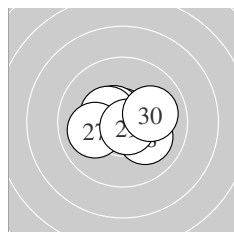

Serie 3:
 10.8 * 10.6 * 10.8 * 10.8 * 10.6 *
 10.4 * 10.0 ← 10.1 ↘ 10.7 * 10.0 →
 beste Teiler 34.3 (24.) 38.6 (21.) 49.2 (23.)
 Trefferlage 0.00 mm , 0.05 mm hoch
 Streuwert 1.06, horizontal: 1.35, vertikal: 0.64

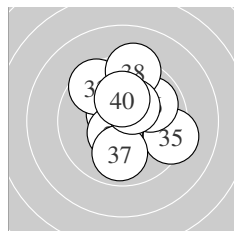

Serie 4:
 10.3 * 10.6 * 9.6 ↘ 10.5 * 9.3 →
 9.9 ↗ 9.9 ↓ 9.3 ↑ 10.4 * 10.2 *
 beste Teiler 89.4 (32.) 113.4 (34.) 141.4 (39.)
 Trefferlage 0.53 mm rechts, 0.78 mm hoch
 Streuwert 1.83, horizontal: 1.69, vertikal: 1.96

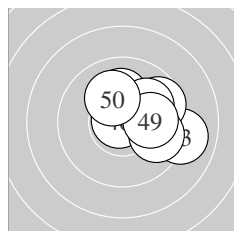

Serie 5:
 10.1 ↑ 10.6 * 9.0 → 9.7 → 10.8 *
 10.8 * 10.0 ↗ 9.8 ↘ 10.1 → 10.1 ↘
 beste Teiler 30.8 (46.) 39.2 (45.) 81.0 (42.)
 Trefferlage 1.31 mm rechts, 0.60 mm hoch
 Streuwert 1.51, horizontal: 1.82, vertikal: 1.12

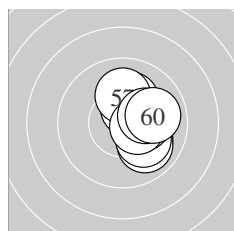

Serie 6:
 10.1 ↘ 9.9 ↘ 10.4 * 10.2 * 10.1 ↘
 10.3 * 10.1 ↑ 10.5 * 10.2 * 9.9 →
 beste Teiler 123.4 (58.) 126.6 (53.) 164.0 (56.)
 Trefferlage 1.35 mm rechts, 0.16 mm hoch
 Streuwert 1.11, horizontal: 0.75, vertikal: 1.37

Meyton Elektronik

ISSF AR Women Jun – Wertung – Juniorinnen

StandNr: 128

Caluori, Valentina #111

StartNr: 76

20. Januar 2018 11:47

SUI

Unterschrift des Schützen

Meyton Elektronik

Ergebnis: **623.7** (595)^{QF}
 Serien: 103.1 104.6 105.0 102.8 103.2 105.0
 Zähler: 55 5 0 0 0 0 0 0 0 0
 Innenzehner: 48
 weiteste: 417 (7), 295 (16), 264 (24)
 beste Teiler 11.4 (18.) 27.2 (17.) 31.9 (60.)
 Trefferlage 0.20 mm links, 0.05 mm tief
 Streuwert 1.13, horizontal: 1.25, vertikal: 1.01

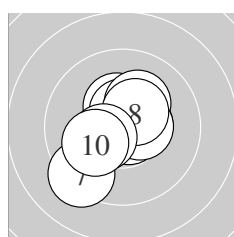
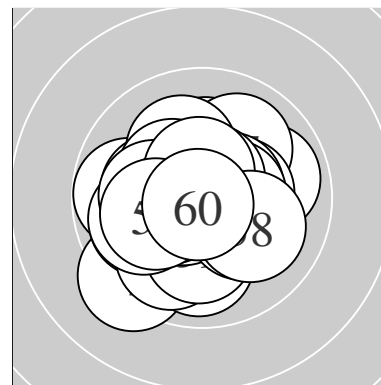

Serie 1:
 10.4 * 10.8 * 10.5 * 10.5 * 10.2 *
 10.5 * 9.3 ↙ 10.4 * 10.4 * 10.1 ↙
 beste Teiler 49.9 (2.) 101.0 (3.) 115.1 (4.)
 Trefferlage 0.17 mm links, 0.00 mm
 Streuwert 1.40, horizontal: 1.38, vertikal: 1.41

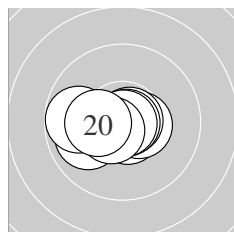

Serie 2:
 10.7 * 10.2 * 10.0 ↙ 10.5 * 10.8 *
 9.8 ← 10.8 * 10.9 * 10.6 * 10.3 *
 beste Teiler 11.4 (18.) 27.2 (17.) 48.0 (15.)
 Trefferlage 0.72 mm links, 0.25 mm tief
 Streuwert 1.01, horizontal: 1.38, vertikal: 0.35

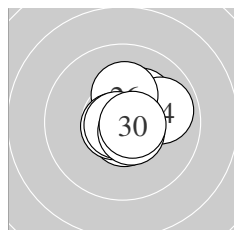

Serie 3:
 10.5 * 10.7 * 10.2 * 9.9 → 10.7 *
 10.2 * 10.7 * 10.8 * 10.6 * 10.7 *
 beste Teiler 40.3 (28.) 57.3 (25.) 64.4 (27.)
 Trefferlage 0.59 mm rechts, 0.20 mm hoch
 Streuwert 0.87, horizontal: 0.89, vertikal: 0.85

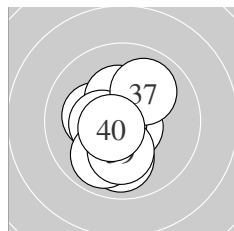

Serie 4:
 10.7 * 10.7 * 10.2 * 10.3 * 10.4 *
 9.9 ↓ 10.0 ↗ 9.9 ↙ 10.1 ↓ 10.6 *
 beste Teiler 60.6 (31.) 63.7 (32.) 89.3 (40.)
 Trefferlage 0.45 mm links, 0.41 mm tief
 Streuwert 1.26, horizontal: 0.95, vertikal: 1.51

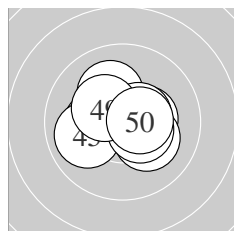

Serie 5:
 10.3 * 10.4 * 10.5 * 10.1 ↖ 10.0 ←
 10.2 * 10.4 * 10.5 * 10.3 * 10.5 *
 beste Teiler 107.3 (43.) 113.6 (48.) 116.5 (50.)
 Trefferlage 0.05 mm links, 0.15 mm hoch
 Streuwert 1.23, horizontal: 1.50, vertikal: 0.87

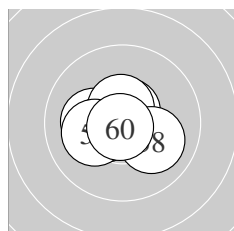

Serie 6:
 10.8 * 10.6 * 10.2 * 10.4 * 10.8 *
 10.6 * 10.5 * 10.1 ↘ 10.2 * 10.8 *
 beste Teiler 31.9 (60.) 43.5 (55.) 46.9 (51.)
 Trefferlage 0.41 mm links, 0.02 mm tief
 Streuwert 0.93, horizontal: 1.15, vertikal: 0.65

Meyton Elektronik

ISSF AR Women Jun – Wertung – Juniorinnen

StartNr: 77

StandNr: 129

20. Januar 2018 11:37

Kitzbichler, Jasmin #112

AUT

QF – Schütze hat sich fürs Finale qualifiziert

Unterschrift des Schützen

Meyton Elektronik

Ergebnis: **605.4** (579)
 Serien: 99.7 102.3 99.6 101.2 100.7 101.9
 Zähler: 39 21 0 0 0 0 0 0 0
 Innenzehner: 28
 weiteste: 472 (20), 455 (23), 413 (10)
 beste Teiler 43.9 (17.) 70.8 (3.) 73.8 (54.)
 Trefferlage 0.24 mm links, 0.16 mm hoch
 Streuwert 1.71, horizontal: 1.71, vertikal: 1.72

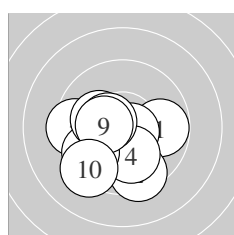
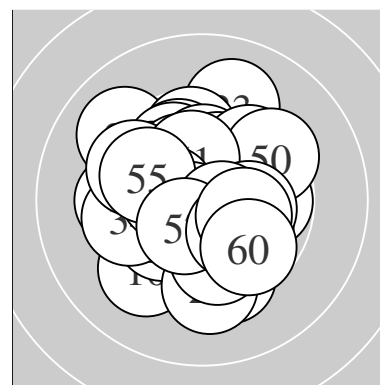

Serie 1:
 9.8 → 9.5 ↓ 10.7 * 10.1 ↓ 9.5 ←
 9.7 ↙ 10.2 * 10.5 * 10.4 * 9.3 ↘
 beste Teiler 70.8 (3.) 121.4 (8.) 145.1 (9.)
 Trefferlage 0.78 mm links, 1.00 mm tief
 Streuwert 1.83, horizontal: 2.07, vertikal: 1.55

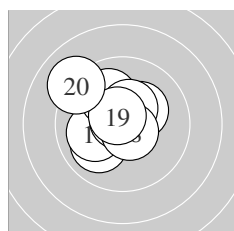

Serie 2:
 10.4 * 10.3 * 10.0 ↙ 10.1 ← 10.0 ↖
 10.4 * 10.8 * 10.6 * 10.6 * 9.1 ↗
 beste Teiler 43.9 (17.) 76.8 (19.) 79.2 (18.)
 Trefferlage 0.84 mm links, 0.59 mm hoch
 Streuwert 1.42, horizontal: 1.48, vertikal: 1.35

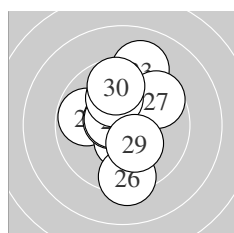

Serie 3:
 9.8 ← 10.5 * 9.1 ↑ 10.6 * 10.6 *
 9.3 ↓ 9.6 ↗ 10.1 ↖ 10.3 * 9.7 ↑
 beste Teiler 87.9 (25.) 92.6 (24.) 119.0 (22.)
 Trefferlage 0.02 mm links, 0.63 mm hoch
 Streuwert 2.00, horizontal: 1.47, vertikal: 2.42

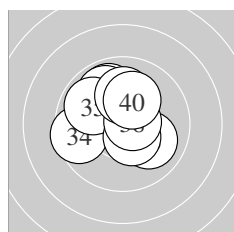

Serie 4:
 9.9 ↖ 9.9 ↖ 10.5 * 9.6 ← 9.9 ↖
 10.0 ↘ 10.5 * 10.6 * 10.1 ↑ 10.2 *
 beste Teiler 80.0 (38.) 104.2 (33.) 123.8 (37.)
 Trefferlage 0.32 mm links, 0.82 mm hoch
 Streuwert 1.56, horizontal: 1.66, vertikal: 1.46

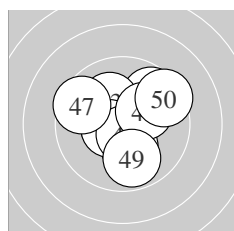

Serie 5:
 9.7 ↗ 10.5 * 10.1 ↖ 10.2 * 10.5 *
 10.6 * 9.6 ↖ 10.2 * 9.9 ↓ 9.4 ↗
 beste Teiler 81.0 (46.) 105.5 (42.) 105.9 (45.)
 Trefferlage 0.23 mm rechts, 0.27 mm hoch
 Streuwert 1.78, horizontal: 1.87, vertikal: 1.68

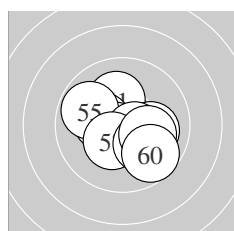

Serie 6:
 10.2 * 10.1 → 10.3 * 10.7 * 9.8 ↖
 10.5 * 10.4 * 10.1 ↘ 10.1 → 9.7 ↘
 beste Teiler 73.8 (54.) 102.8 (56.) 147.8 (57.)
 Trefferlage 0.26 mm rechts, 0.36 mm tief
 Streuwert 1.48, horizontal: 1.70, vertikal: 1.22

Meyton Elektronik

ISSF AR Women Jun – Wertung – Juniorinnen

StartNr: 78

StandNr: 130

20. Januar 2018 11:31

Lepri, Virginia #113

ITA

Unterschrift des Schützen

Meyton Elektronik

Ergebnis: **597.6** (575)
 Serien: 101.6 99.9 101.7 99.0 98.7 96.7
 Zähler: 37 21 2 0 0 0 0 0 0 0
 Innenzehner: 21
 weiteste: 715 (43), 521 (15), 476 (54)
 beste Teiler 63.2 (49.) 74.1 (14.) 95.1 (23.)
 Trefferlage 0.11 mm links, 0.02 mm hoch
 Streuwert 1.97, horizontal: 2.32, vertikal: 1.55

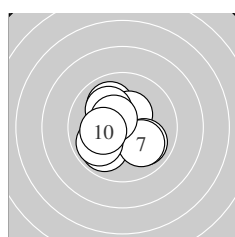
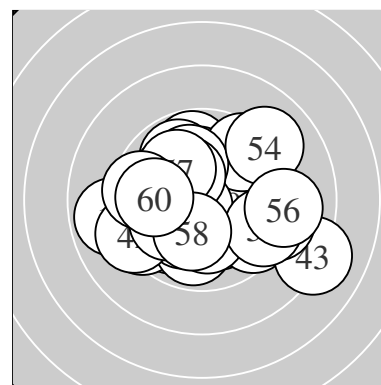

Serie 1:
 10.6 * 9.9 ↙ 10.0 ↘ 10.4 * 10.1 ↘
 10.0 ↘ 10.0 ↘ 9.9 ↙ 10.5 * 10.2 *
 beste Teiler 96.7 (1.) 118.0 (9.) 137.3 (4.)
 Trefferlage 0.48 mm links, 0.00 mm
 Streuwert 1.53, horizontal: 1.52, vertikal: 1.53

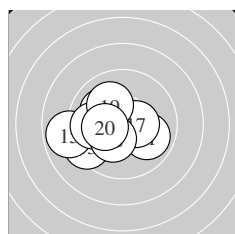

Serie 2:
 9.9 ↘ 10.1 ↘ 9.4 ↙ 10.7 * 8.9 ←
 9.8 ← 10.4 * 10.3 * 10.1 ↘ 10.3 *
 beste Teiler 74.1 (14.) 129.0 (17.) 167.5 (18.)
 Trefferlage 1.41 mm links, 0.28 mm tief
 Streuwert 1.74, horizontal: 2.16, vertikal: 1.19

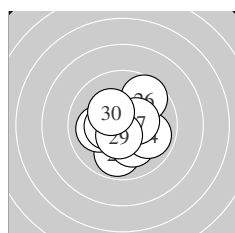

Serie 3:
 9.9 ↓ 10.1 ↘ 10.6 * 9.9 ↘ 10.0 ←
 9.6 ↗ 10.4 * 10.4 * 10.5 * 10.3 *
 beste Teiler 95.1 (23.) 104.6 (29.) 135.4 (27.)
 Trefferlage 0.20 mm rechts, 0.28 mm tief
 Streuwert 1.52, horizontal: 1.56, vertikal: 1.48

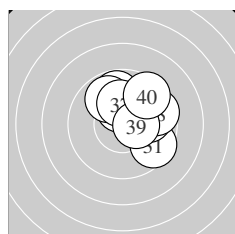

Serie 4:
 9.5 ↘ 9.7 → 9.8 ↑ 10.4 * 9.9 ↘
 10.0 → 10.2 * 9.6 → 10.4 * 9.5 ↗
 beste Teiler 130.3 (39.) 148.6 (34.) 200.4 (37.)
 Trefferlage 1.27 mm rechts, 1.21 mm hoch
 Streuwert 1.61, horizontal: 1.73, vertikal: 1.47

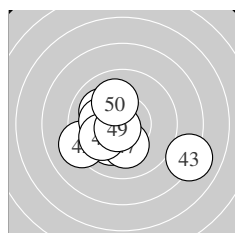

Serie 5:
 10.1 ↙ 9.2 ↙ 8.1 ↘ 10.2 * 10.0 ↘
 10.2 * 10.1 ↓ 10.0 ↙ 10.7 * 10.1 ↑
 beste Teiler 63.2 (49.) 183.2 (44.) 199.1 (46.)
 Trefferlage 0.72 mm links, 0.70 mm tief
 Streuwert 2.25, horizontal: 2.74, vertikal: 1.62

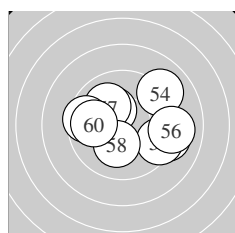

Serie 6:
 10.1 ← 10.3 * 9.2 → 9.0 ↗ 9.4 →
 9.1 → 10.0 ↘ 10.2 * 9.5 ← 9.9 ←
 beste Teiler 166.4 (52.) 190.7 (58.) 218.5 (51.)
 Trefferlage 0.47 mm rechts, 0.24 mm hoch
 Streuwert 2.51, horizontal: 3.18, vertikal: 1.58

Meyton Elektronik

ISSF AR Women Jun – Wertung – Juniorinnen

StandNr: 131

Mair, Katrin #114

StartNr: 79

20. Januar 2018 11:29

BAY – Schwaben

Unterschrift des Schützen

Meyton Elektronik

Ergebnis:	623.5	(597) ^{QF}							
Serien:	103.6	103.9	103.9	104.5	103.0	104.6			
Zähler:	57	3	0	0	0	0	0	0	0
Innenzehner:	46								
weiteste:	345 (22), 276 (18), 252 (46)								
beste Teiler	16.0 (55.)	18.0 (33.)	20.2 (15.)						
Trefferlage	0.11 mm links, 0.33 mm hoch								
Streuwert	1.08, horizontal: 1.20, vertikal: 0.95								

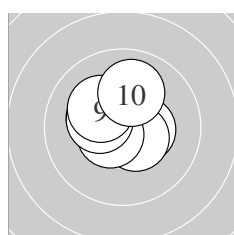
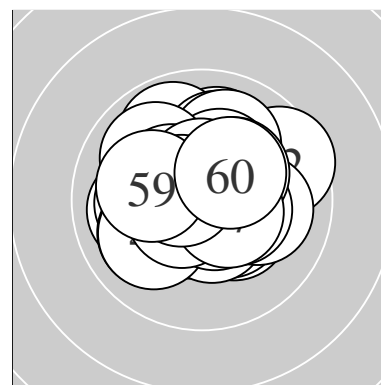

Serie 1:	10.5 *	10.5 *	10.3 *	10.4 *	10.3 *
	10.5 *	10.6 *	10.3 *	10.2 *	10.0 ↑
beste Teiler	95.5 (7.)	105.2 (2.)	105.4 (1.)		
Trefferlage	0.56 mm links, 0.50 mm hoch				
Streuwert	0.99, horizontal: 1.09, vertikal: 0.88				

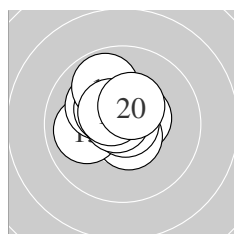

Serie 2:	10.5 *	10.6 *	10.0 ←	10.1 ↘	10.9 *
	10.7 *	10.4 *	9.8 ↘	10.5 *	10.4 *
beste Teiler	20.2 (15.)	51.8 (16.)	92.1 (12.)		
Trefferlage	0.51 mm links, 0.63 mm hoch				
Streuwert	1.01, horizontal: 1.08, vertikal: 0.95				

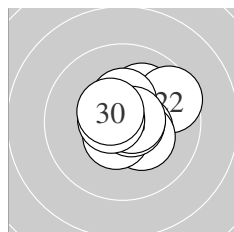

Serie 3:	10.1 ↗	9.6 ↗	10.5 *	10.4 *	10.3 *
	10.5 *	10.7 *	10.7 *	10.6 *	10.5 *
beste Teiler	58.5 (27.)	64.7 (28.)	78.6 (29.)		
Trefferlage	0.60 mm rechts, 0.31 mm hoch				
Streuwert	1.09, horizontal: 1.19, vertikal: 0.98				

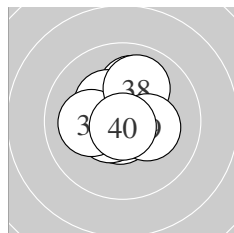

Serie 4:	10.1 ↑	10.7 *	10.9 *	10.7 *	10.3 *
	10.6 *	10.1 ←	10.0 ↑	10.3 *	10.8 *
beste Teiler	18.0 (33.)	37.0 (40.)	61.2 (32.)		
Trefferlage	0.13 mm links, 0.32 mm hoch				
Streuwert	1.08, horizontal: 1.06, vertikal: 1.11				

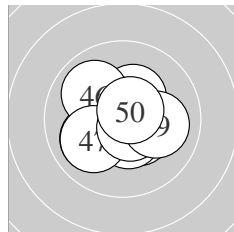

Serie 5:	10.4 *	10.3 *	10.0 ↙	10.7 *	10.5 *
	9.9 ↘	10.0 ↙	10.6 *	10.0 →	10.6 *
beste Teiler	59.4 (44.)	77.2 (48.)	78.6 (50.)		
Trefferlage	0.05 mm links, 0.13 mm tief				
Streuwert	1.29, horizontal: 1.43, vertikal: 1.12				

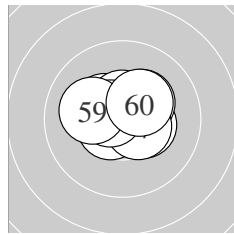

Serie 6:	10.4 *	10.4 *	10.5 *	10.3 *	10.9 *
	10.6 *	10.5 *	10.6 *	10.1 ←	10.3 *
beste Teiler	16.0 (55.)	90.8 (58.)	94.6 (56.)		
Trefferlage	0.00 mm, 0.35 mm hoch				
Streuwert	0.96, horizontal: 1.19, vertikal: 0.65				

Meyton Elektronik

QF – Schütze hat sich fürs Finale qualifiziert

Unterschrift des Schützen

Meyton Elektronik

Ergebnis: **619.2** (590)
 Serien: 102.8 102.4 104.9 103.3 102.3 103.5
 Zähler: 50 10 0 0 0 0 0 0 0
 Innenzehner: 42
 weiteste: 335 (53), 316 (47), 301 (12)
 beste Teiler 15.6 (29.) 22.0 (18.) 39.6 (21.)
 Trefferlage 0.07 mm links, 0.17 mm hoch
 Streuwert 1.24, horizontal: 1.30, vertikal: 1.18

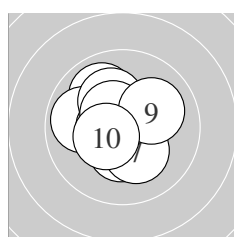
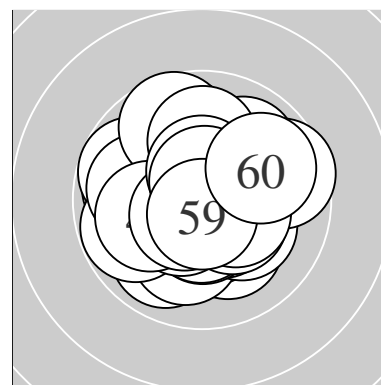

Serie 1:
 10.6 * 9.9 ↘ 9.9 ← 10.4 * 10.2 *
 10.6 * 10.2 * 10.5 * 10.1 ↗ 10.4 *
 beste Teiler 93.0 (6.) 98.6 (1.) 111.0 (8.)
 Trefferlage 0.48 mm links, 0.36 mm hoch
 Streuwert 1.26, horizontal: 1.26, vertikal: 1.27

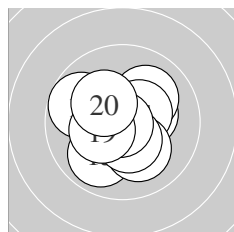

Serie 2:
 10.3 * 9.7 ← 10.1 ↗ 10.4 * 9.9 ↘
 10.1 ↘ 10.4 * 10.9 * 10.4 * 10.2 *
 beste Teiler 22.0 (18.) 126.5 (17.) 128.0 (14.)
 Trefferlage 0.14 mm links, 0.06 mm tief
 Streuwert 1.42, horizontal: 1.51, vertikal: 1.32

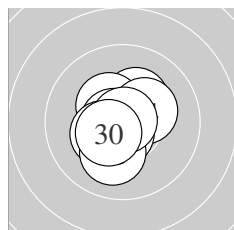

Serie 3:
 10.8 * 10.3 * 10.4 * 10.3 * 10.7 *
 10.3 * 10.6 * 10.1 ↓ 10.9 * 10.5 *
 beste Teiler 15.6 (29.) 39.6 (21.) 61.0 (25.)
 Trefferlage 0.21 mm links, 0.04 mm tief
 Streuwert 0.96, horizontal: 0.87, vertikal: 1.05

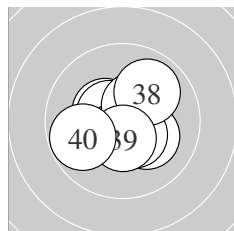

Serie 4:
 10.6 * 10.2 * 10.4 * 10.5 * 10.5 *
 10.4 * 10.5 * 9.9 ↗ 10.5 * 9.8 ←
 beste Teiler 83.0 (31.) 101.2 (35.) 101.8 (34.)
 Trefferlage 0.09 mm rechts, 0.03 mm tief
 Streuwert 1.24, horizontal: 1.35, vertikal: 1.13

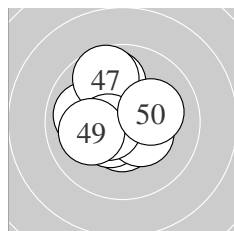

Serie 5:
 10.6 * 10.5 * 10.5 * 10.4 * 9.9 ↑
 10.0 ← 9.7 ↘ 10.5 * 10.1 ← 10.1 →
 beste Teiler 99.0 (41.) 102.1 (48.) 112.0 (42.)
 Trefferlage 0.44 mm links, 0.21 mm hoch
 Streuwert 1.43, horizontal: 1.38, vertikal: 1.48

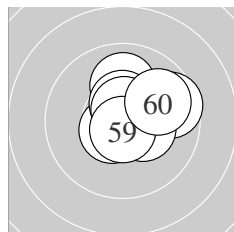

Serie 6:
 10.6 * 10.0 ↑ 9.6 → 10.5 * 10.6 *
 10.6 * 10.6 * 10.4 * 10.7 * 9.9 ↗
 beste Teiler 58.0 (59.) 76.6 (57.) 81.7 (56.)
 Trefferlage 0.78 mm rechts, 0.58 mm hoch
 Streuwert 1.09, horizontal: 1.21, vertikal: 0.97

Meyton Elektronik

ISSF AR Women Jun – Wertung – Juniorinnen

StandNr: 133

Müller, Victoria #116

StartNr: 81

20. Januar 2018 11:32

AUT

Unterschrift des Schützen

Meyton Elektronik

Ergebnis: **602.6** (576)
 Serien: 100.1 100.8 101.5 100.2 100.3 99.7
 Zähler: 37 22 1 0 0 0 0 0 0
 Innenzehner: 28
 weiteste: 576 (49), 486 (24), 420 (33)
 beste Teiler 54.8 (22.) 68.4 (41.) 72.5 (31.)
 Trefferlage 0.10 mm links, 0.08 mm tief
 Streuwert 1.78, horizontal: 1.99, vertikal: 1.54

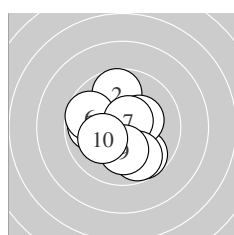
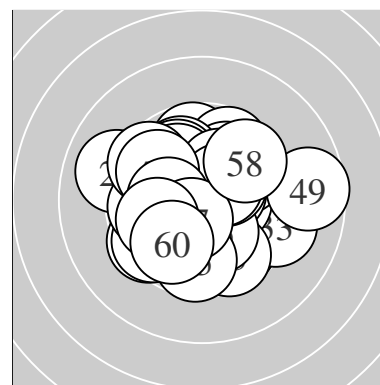

Serie 1:
 9.9 ← 9.7 ↑ 9.7 ↘ 10.3 * 10.2 *
 9.7 ↖ 10.6 * 9.8 ↘ 10.1 ↓ 10.1 ↙
 beste Teiler 77.9 (7.) 162.1 (4.) 182.0 (5.)
 Trefferlage 0.44 mm links, 0.33 mm tief
 Streuwert 1.76, horizontal: 1.76, vertikal: 1.77

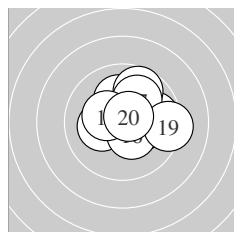

Serie 2:
 10.2 * 10.3 * 10.1 ↑ 9.8 → 9.7 ↗
 10.4 * 10.0 ↗ 10.3 * 9.3 → 10.7 *
 beste Teiler 74.9 (20.) 136.6 (16.) 153.3 (18.)
 Trefferlage 0.89 mm rechts, 0.61 mm hoch
 Streuwert 1.57, horizontal: 1.82, vertikal: 1.27

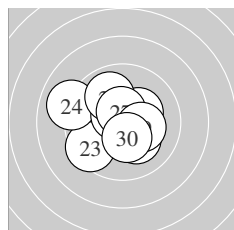

Serie 3:
 10.3 * 10.7 * 9.5 ↙ 9.0 ↖ 10.6 *
 9.9 ↘ 10.6 * 10.2 * 10.3 * 10.4 *
 beste Teiler 54.8 (22.) 86.9 (25.) 96.8 (27.)
 Trefferlage 0.51 mm links, 0.03 mm hoch
 Streuwert 1.74, horizontal: 1.99, vertikal: 1.46

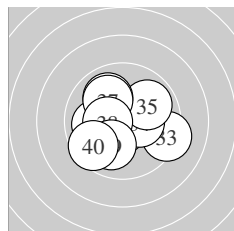

Serie 4:
 10.7 * 10.0 ← 9.3 → 10.3 * 9.9 ↗
 10.0 ↘ 10.0 ↘ 10.4 * 10.0 ↓ 9.6 ↙
 beste Teiler 72.5 (31.) 135.1 (38.) 153.3 (34.)
 Trefferlage 0.24 mm links, 0.15 mm tief
 Streuwert 1.88, horizontal: 2.15, vertikal: 1.56

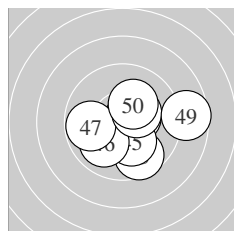

Serie 5:
 10.7 * 10.4 * 9.6 ↘ 10.5 * 10.2 *
 10.0 ↙ 9.8 ← 10.3 * 8.6 → 10.2 *
 beste Teiler 68.4 (41.) 125.3 (44.) 129.6 (42.)
 Trefferlage 0.67 mm rechts, 0.40 mm tief
 Streuwert 1.91, horizontal: 2.29, vertikal: 1.43

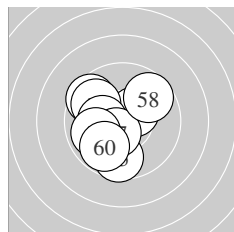

Serie 6:
 10.4 * 9.6 ↘ 9.8 ↘ 10.2 * 9.6 ↓
 10.2 * 10.5 * 9.7 ↗ 9.9 ← 9.8 ↙
 beste Teiler 120.8 (57.) 133.2 (51.) 182.0 (56.)
 Trefferlage 1.01 mm links, 0.24 mm tief
 Streuwert 1.75, horizontal: 1.66, vertikal: 1.85

Meyton Elektronik

ISSF AR Women Jun – Wertung – Juniorinnen

StandNr: 134

Züger, Muriel #117

StartNr: 82

20. Januar 2018 11:44

SUI

Unterschrift des Schützen

Meyton Elektronik

Ergebnis: **595.9** (571)

Serien: 99.2 99.4 101.6 100.2 100.4 95.1

Zähler: 36 19 5 0 0 0 0 0 0 0

Innenzehner: 29

weiteste: 689 (26), 599 (14), 556 (49)

beste Teiler 6.0 (43.) 50.6 (30.) 63.5 (56.)

Trefferlage 0.50 mm links, 0.00 mm

Streuwert 2.09, horizontal: 2.29, vertikal: 1.88

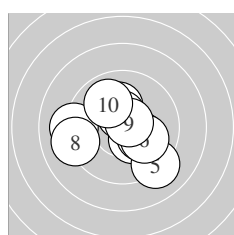
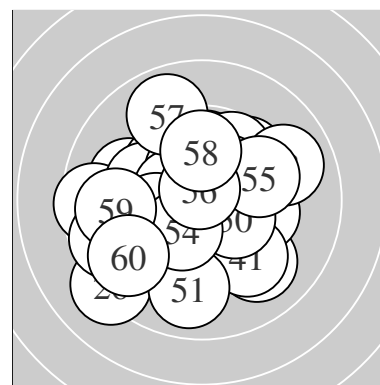

Serie 1:

10.4 *	10.2 *	10.2 *	10.5 *	9.1 ↘
10.0 ↘	9.1 ←	9.1 ←	10.7 *	9.9 ↖

beste Teiler 73.8 (9.) 115.7 (4.) 146.2 (1.)

Trefferlage 0.24 mm links, 0.21 mm tief

Streuwert 2.17, horizontal: 2.54, vertikal: 1.70

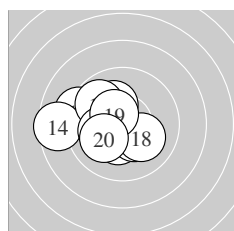

Serie 2:

9.3 ↖	10.3 *	10.2 *	8.6 ←	9.8 ↗
10.2 *	10.3 *	10.1 ↘	10.5 *	10.1 ↙

beste Teiler 122.9 (19.) 156.7 (12.) 162.9 (17.)

Trefferlage 1.50 mm links, 0.02 mm tief

Streuwert 1.87, horizontal: 2.27, vertikal: 1.34

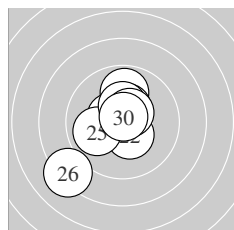

Serie 3:

9.9 ↑	10.4 *	10.5 *	10.5 *	10.0 ←
8.2 ↙	10.4 *	10.4 *	10.5 *	10.8 *

beste Teiler 50.6 (30.) 108.6 (29.) 112.3 (24.)

Trefferlage 0.62 mm links, 0.17 mm hoch

Streuwert 1.93, horizontal: 1.81, vertikal: 2.04

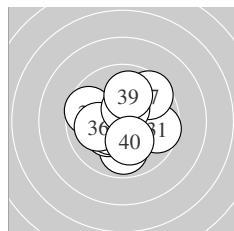

Serie 4:

9.7 →	9.9 ↓	10.3 *	9.6 ↖	10.4 *
10.0 ←	9.6 ↗	10.5 *	10.0 ↑	10.2 *

beste Teiler 115.9 (38.) 135.5 (35.) 168.8 (33.)

Trefferlage 0.06 mm links, 0.07 mm tief

Streuwert 1.84, horizontal: 1.95, vertikal: 1.72

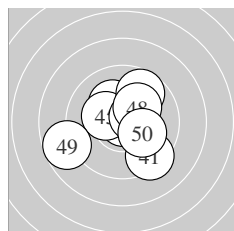

Serie 5:

9.4 ↘	10.4 *	10.9 *	10.2 *	10.3 *
10.5 *	9.7 ↗	10.2 *	8.7 ←	10.1 ↘

beste Teiler 6.0 (43.) 110.4 (46.) 133.2 (42.)

Trefferlage 0.19 mm rechts, 0.10 mm hoch

Streuwert 2.02, horizontal: 2.26, vertikal: 1.75

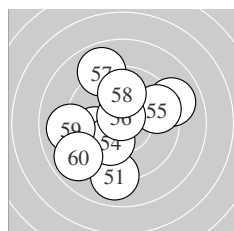

Serie 6:

9.0 ↓	9.9 ←	9.0 ↗	10.2 *	9.6 →
10.7 *	8.9 ↘	9.9 ↑	9.0 ←	8.9 ↙

beste Teiler 63.5 (56.) 200.5 (54.) 265.8 (52.)

Trefferlage 0.77 mm links, 0.04 mm hoch

Streuwert 2.87, horizontal: 2.91, vertikal: 2.84

ISSF AR Women Jun – Wertung – Juniorinnen

StandNr: 135

Vanoni, Larissa #118

StartNr: 83

20. Januar 2018 11:48

VLSV

Unterschrift des Schützen

Meyton Elektronik

Ergebnis: **598.4** (569)

Serien: 98.4 100.7 100.2 100.2 100.4 98.5

Zähler: 30 29 1 0 0 0 0 0 0 0

Innenzehner: 23

weiteste: 513 (9), 500 (10), 464 (16)

beste Teiler 14.5 (27.) 82.1 (33.) 87.7 (3.)

Trefferlage 0.42 mm rechts, 0.40 mm tief

Streuwert 1.87, horizontal: 1.94, vertikal: 1.79

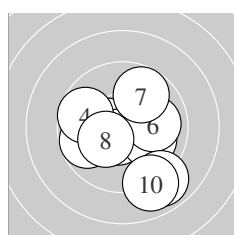
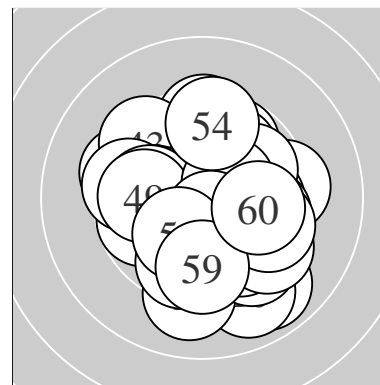

Serie 1:

10.4 *	9.7 ←	10.6 *	9.7 ↖	10.0 →
10.0 →	9.8 ↗	10.3 *	8.9 ↘	9.0 ↘

beste Teiler 87.7 (3.) 131.3 (1.) 166.2 (8.)

Trefferlage 0.24 mm rechts, 0.84 mm tief

Streuwert 2.21, horizontal: 2.28, vertikal: 2.14

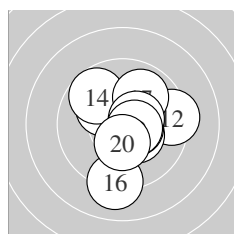

Serie 2:

10.2 *	9.4 →	10.4 *	9.7 ↖	10.5 *
9.1 ↓	9.9 ↗	10.5 *	10.6 *	10.4 *

beste Teiler 100.2 (19.) 108.2 (15.) 117.0 (18.)

Trefferlage 0.53 mm rechts, 0.09 mm tief

Streuwert 1.86, horizontal: 1.70, vertikal: 2.00

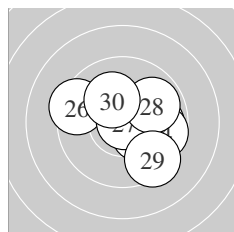

Serie 3:

10.3 *	10.0 →	9.9 →	9.7 →	10.5 *
9.4 ↖	10.9 *	9.9 ↗	9.4 ↘	10.2 *

beste Teiler 14.5 (27.) 114.5 (25.) 162.5 (21.)

Trefferlage 1.09 mm rechts, 0.07 mm tief

Streuwert 1.76, horizontal: 2.07, vertikal: 1.38

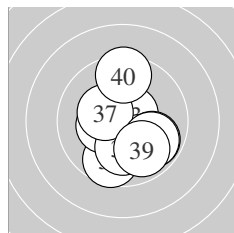

Serie 4:

9.7 ↓	10.3 *	10.6 *	9.8 ↘	10.1 ↘
10.1 ↓	10.3 *	9.9 ↘	9.9 ↘	9.5 ↑

beste Teiler 82.1 (33.) 153.8 (32.) 156.0 (37.)

Trefferlage 0.42 mm rechts, 0.75 mm tief

Streuwert 1.73, horizontal: 1.43, vertikal: 1.98

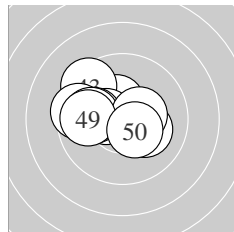

Serie 5:

10.4 *	10.2 *	9.4 ↖	9.5 ←	10.4 *
10.0 ←	9.9 ←	10.4 *	9.8 ←	10.4 *

beste Teiler 131.0 (50.) 132.5 (45.) 138.0 (48.)

Trefferlage 1.15 mm links, 0.40 mm hoch

Streuwert 1.55, horizontal: 1.94, vertikal: 1.01

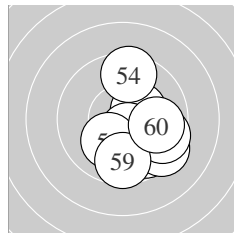

Serie 6:

10.4 *	9.8 ↘	9.7 ↘	9.5 ↑	10.5 *
10.1 ↗	9.4 ↘	9.6 ↘	9.6 ↓	9.9 →

beste Teiler 102.9 (55.) 143.6 (51.) 205.5 (56.)

Trefferlage 1.41 mm rechts, 1.03 mm tief

Streuwert 1.73, horizontal: 1.45, vertikal: 1.98

ISSF AR Women Jun – Wertung – Juniorinnen

StandNr: 136

Patka, Anna #119

StartNr: 84

20. Januar 2018 11:18

T – SG Thierberg

Unterschrift des Schützen

Meyton Elektronik

Ergebnis: **612.6** (588)

Serien: 102.2 103.9 102.1 102.8 101.5 100.1

Zähler: 48 12 0 0 0 0 0 0 0

Innenzehner: 39

weiteste: 457 (8), 362 (25), 348 (56)

beste Teiler 37.8 (36.) 66.7 (9.) 70.4 (26.)

Trefferlage 0.18 mm rechts, 0.59 mm hoch

Streuwert 1.39, horizontal: 1.38, vertikal: 1.39

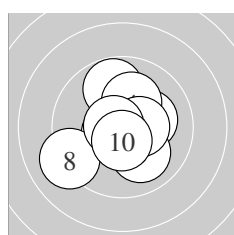
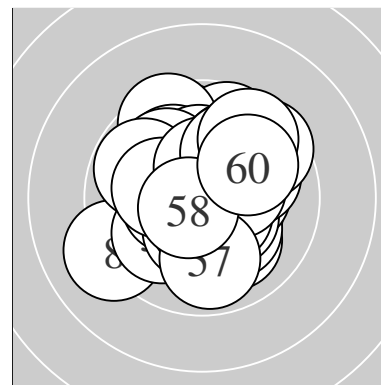

Serie 1:

10.2 *	10.5 *	9.8 ↑	10.2 *	10.6 *
10.0 ↘	10.5 *	9.1 ↙	10.7 *	10.6 *

beste Teiler 66.7 (9.) 94.0 (5.) 100.1 (10.)

Trefferlage 0.07 mm links, 0.08 mm hoch

Streuwert 1.63, horizontal: 1.64, vertikal: 1.61

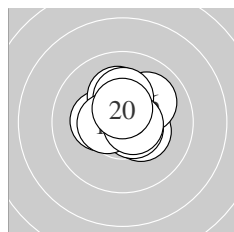

Serie 2:

10.3 *	10.3 *	10.7 *	10.2 *	10.6 *
10.0 ↗	10.2 *	10.5 *	10.6 *	10.5 *

beste Teiler 73.4 (13.) 79.6 (19.) 90.5 (15.)

Trefferlage 0.11 mm rechts, 0.55 mm hoch

Streuwert 1.02, horizontal: 1.08, vertikal: 0.95

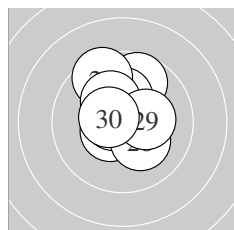

Serie 3:

9.7 ↑	10.3 *	10.2 *	10.5 *	9.5 ↑
10.7 *	10.2 *	10.2 *	10.3 *	10.5 *

beste Teiler 70.4 (26.) 108.1 (30.) 113.6 (24.)

Trefferlage 0.13 mm links, 0.97 mm hoch

Streuwert 1.33, horizontal: 1.12, vertikal: 1.50

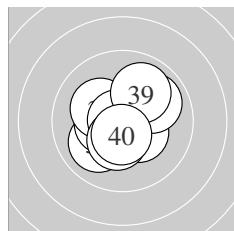

Serie 4:

10.2 *	10.4 *	10.0 ↙	10.4 *	10.2 *
10.8 *	9.9 ↗	10.4 *	10.0 ↗	10.5 *

beste Teiler 37.8 (36.) 101.4 (40.) 135.9 (34.)

Trefferlage 0.05 mm rechts, 0.07 mm hoch

Streuwert 1.36, horizontal: 1.42, vertikal: 1.29

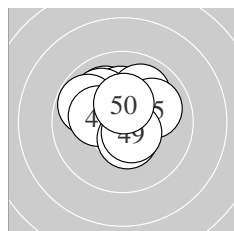

Serie 5:

10.0 ↘	10.2 *	10.0 ↘	10.0 ↗	10.0 →
9.8 ↖	10.2 *	10.4 *	10.5 *	10.4 *

beste Teiler 102.1 (49.) 127.8 (48.) 137.2 (50.)

Trefferlage 0.27 mm links, 0.97 mm hoch

Streuwert 1.34, horizontal: 1.50, vertikal: 1.15

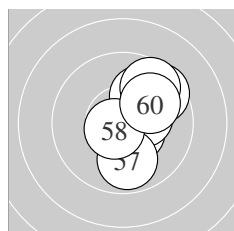

Serie 6:

10.5 *	9.8 ↗	10.3 *	9.8 ↗	10.0 ↗
9.6 ↗	9.9 ↓	10.7 *	9.6 ↗	9.9 ↗

beste Teiler 75.2 (58.) 113.0 (51.) 156.3 (53.)

Trefferlage 1.41 mm rechts, 0.91 mm hoch

Streuwert 1.40, horizontal: 0.98, vertikal: 1.72

ISSF AR Women Jun – Wertung – Juniorinnen

StandNr: 137

Köck, Rebecca #120

StartNr: 85

20. Januar 2018 11:41

AUT

Unterschrift des Schützen

Meyton Elektronik

Ergebnis: **594.0** (568)

Serien: 103.1 98.2 97.1 97.8 101.0 96.8

Zähler: 33 22 5 0 0 0 0 0 0 0

Innenzehner: 22

weiteste: 667 (39), 619 (53), 590 (50)

beste Teiler 33.2 (23.) 41.3 (10.) 75.8 (41.)

Trefferlage 0.02 mm rechts, 0.29 mm tief

Streuwert 2.14, horizontal: 2.03, vertikal: 2.25

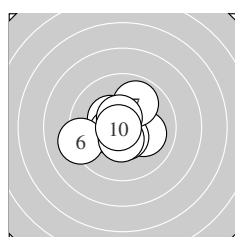
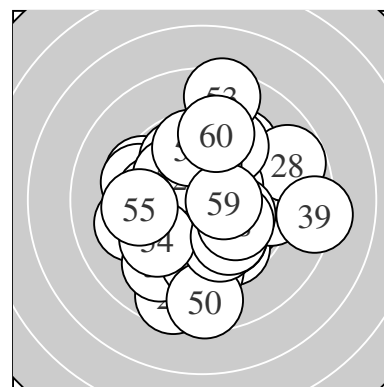

Serie 1:

10.1 →	10.5 *	10.6 *	10.4 *	10.5 *
9.2 ←	9.9 ↗	10.6 *	10.5 *	10.8 *

beste Teiler 41.3 (10.) 82.0 (3.) 96.4 (8.)

Trefferlage 0.40 mm links, 0.12 mm tief

Streuwert 1.42, horizontal: 1.64, vertikal: 1.15

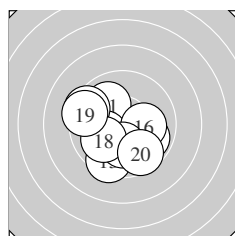

Serie 2:

10.0 ↖	10.2 *	9.5 ↓	9.4 ↖	9.9 →
10.1 →	10.1 ↓	10.0 ↙	9.4 ↖	9.6 ↘

beste Teiler 197.7 (12.) 205.0 (17.) 206.7 (16.)

Trefferlage 0.73 mm links, 0.77 mm tief

Streuwert 2.03, horizontal: 2.21, vertikal: 1.83

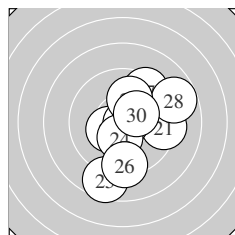

Serie 3:

9.3 →	10.3 *	10.8 *	10.3 *	8.6 ↓
9.3 ↓	9.4 ↗	8.8 →	10.0 ↑	10.3 *

beste Teiler 33.2 (23.) 152.2 (24.) 153.4 (22.)

Trefferlage 1.05 mm rechts, 0.42 mm tief

Streuwert 2.51, horizontal: 2.18, vertikal: 2.80

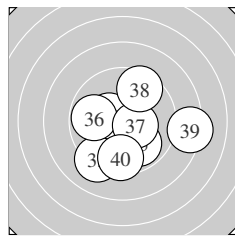

Serie 4:

10.5 *	10.3 *	9.2 ↙	10.4 *	9.9 ↘
9.8 ←	10.4 *	9.5 ↗	8.3 →	9.5 ↓

beste Teiler 107.2 (31.) 131.8 (37.) 141.5 (34.)

Trefferlage 0.23 mm rechts, 0.80 mm tief

Streuwert 2.43, horizontal: 2.74, vertikal: 2.07

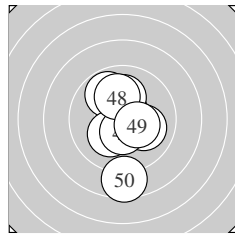

Serie 5:

10.7 *	10.6 *	9.8 ↖	10.1 ↑	10.2 *
10.1 →	10.5 *	10.1 ↑	10.3 *	8.6 ↓

beste Teiler 75.8 (41.) 76.0 (42.) 124.0 (47.)

Trefferlage 0.07 mm rechts, 0.18 mm tief

Streuwert 1.91, horizontal: 1.06, vertikal: 2.48

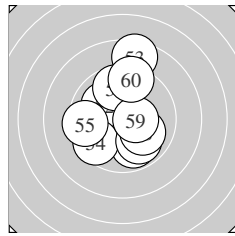

Serie 6:

9.8 ↓	10.0 ↖	8.5 ↑	9.6 ↙	9.5 ←
9.9 ↓	9.7 ↑	10.0 ↘	10.4 *	9.4 ↑

beste Teiler 128.1 (59.) 229.2 (52.) 236.0 (58.)

Trefferlage 0.09 mm links, 0.56 mm hoch

Streuwert 2.52, horizontal: 1.98, vertikal: 2.95

ISSF AR Women Jun – Wertung – Juniorinnen

StandNr: 138

Fuchs, Verena #121

StartNr: 86

20. Januar 2018 11:38

T – SG Ampass

Unterschrift des Schützen

Meyton Elektronik

Ergebnis: **617.1** (589)
 Serien: 102.0 104.3 102.4 101.9 103.6 102.9
 Zähler: 50 9 1 0 0 0 0 0 0
 Innenzehner: 41
 weiteste: 523 (25), 365 (4), 331 (57)
 beste Teiler 11.1 (18.) 25.7 (53.) 30.4 (19.)
 Trefferlage 0.19 mm links, 0.02 mm hoch
 Streuwert 1.36, horizontal: 1.53, vertikal: 1.17

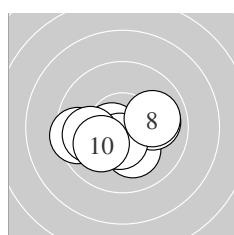
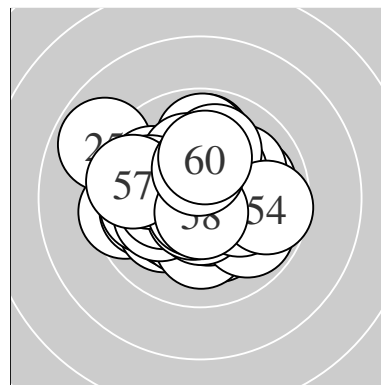

Serie 1:
 10.2 * 10.0 → 10.5 * 9.5 ← 10.7 *
 10.6 * 10.5 * 10.0 → 9.9 ← 10.1 ↙
 beste Teiler 75.7 (5.) 91.0 (6.) 115.1 (7.)
 Trefferlage 0.40 mm links, 0.65 mm tief
 Streuwert 1.48, horizontal: 1.94, vertikal: 0.76

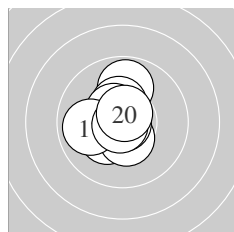

Serie 2:
 10.3 * 9.9 ↑ 10.4 * 10.5 * 10.4 *
 10.5 * 9.9 ← 10.9 * 10.8 * 10.7 *
 beste Teiler 11.1 (18.) 30.4 (19.) 71.5 (20.)
 Trefferlage 0.52 mm links, 0.27 mm hoch
 Streuwert 1.06, horizontal: 0.89, vertikal: 1.21

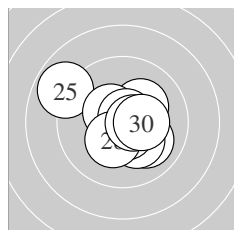

Serie 3:
 10.0 ↘ 10.2 * 10.2 * 10.6 * 8.9 ↘
 10.5 * 10.8 * 10.3 * 10.6 * 10.3 *
 beste Teiler 49.9 (27.) 82.8 (24.) 85.2 (29.)
 Trefferlage 0.10 mm rechts, 0.01 mm tief
 Streuwert 1.63, horizontal: 1.89, vertikal: 1.32

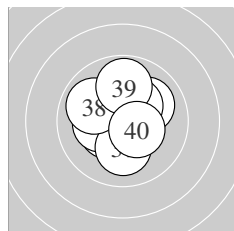

Serie 4:
 10.4 * 10.3 * 10.0 ↗ 10.3 * 10.5 *
 10.2 * 10.1 ↓ 9.9 ↖ 9.8 ↑ 10.4 *
 beste Teiler 121.8 (35.) 132.7 (40.) 142.5 (31.)
 Trefferlage 0.08 mm links, 0.30 mm hoch
 Streuwert 1.42, horizontal: 1.44, vertikal: 1.40

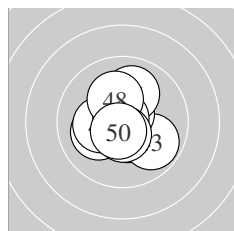

Serie 5:
 10.5 * 10.1 ← 9.8 ↘ 10.7 * 10.0 ↑
 10.3 * 10.8 * 10.2 * 10.6 * 10.6 *
 beste Teiler 32.2 (47.) 73.4 (44.) 79.2 (50.)
 Trefferlage 0.09 mm links, 0.02 mm tief
 Streuwert 1.24, horizontal: 1.20, vertikal: 1.27

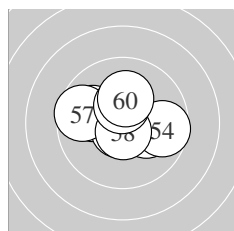

Serie 6:
 10.2 * 10.0 ← 10.9 * 9.7 → 10.5 *
 10.7 * 9.6 ← 10.7 * 10.4 * 10.2 *
 beste Teiler 25.7 (53.) 61.7 (56.) 69.2 (58.)
 Trefferlage 0.17 mm links, 0.29 mm hoch
 Streuwert 1.46, horizontal: 1.85, vertikal: 0.93

Meyton Elektronik

ISSF AR Women Jun – Wertung – Juniorinnen

StandNr: 128

Mayr, Carmen #159

StartNr: 124

20. Januar 2018 13:22

T – SG Innervillgraten

Unterschrift des Schützen

Meyton Elektronik