

Ergebnis: **625.5** (596)^{QF}
 Serien: 104.7 104.2 104.2 103.6 103.6 105.2
 Zähler: 56 4 0 0 0 0 0 0 0 0
 Innenzehner: 47
 weiteste: 285 (6), 273 (26), 271 (35)
 beste Teiler 16.6 (14.) 31.0 (50.) 36.0 (3.)
 Trefferlage 0.06 mm links, 0.12 mm hoch
 Streuwert 1.06, horizontal: 1.06, vertikal: 1.07

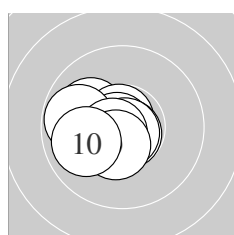

Serie 1:
 10.1 ↖ 10.7 * 10.8 * 10.8 * 10.8 *
 9.8 ← 10.6 * 10.7 * 10.5 * 9.9 ←
 beste Teiler 36.0 (3.) 38.2 (5.) 50.7 (4.)
 Trefferlage 0.92 mm links, 0.19 mm tief
 Streuwert 0.90, horizontal: 1.08, vertikal: 0.67

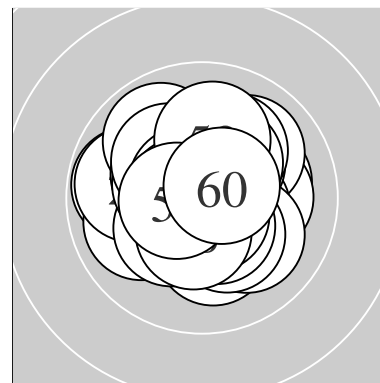
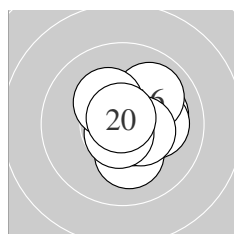

Serie 2:
 10.6 * 10.1 → 10.2 * 10.9 * 10.1 →
 10.0 ↗ 10.5 * 10.7 * 10.3 * 10.8 *
 beste Teiler 16.6 (14.) 41.2 (20.) 64.2 (18.)
 Trefferlage 0.61 mm rechts, 0.20 mm hoch
 Streuwert 1.06, horizontal: 1.05, vertikal: 1.07

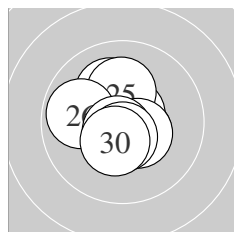

Serie 3:
 10.6 * 10.5 * 10.7 * 10.1 ↗ 10.2 *
 9.9 ← 10.5 * 10.7 * 10.6 * 10.4 *
 beste Teiler 66.0 (28.) 71.4 (23.) 95.0 (29.)
 Trefferlage 0.13 mm links, 0.00 mm
 Streuwert 1.12, horizontal: 1.09, vertikal: 1.16

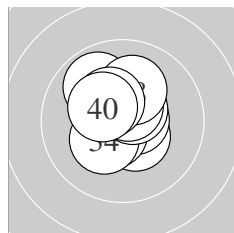

Serie 4:
 10.4 * 10.6 * 10.5 * 10.3 * 9.9 ↖
 10.6 * 10.5 * 10.1 ↑ 10.4 * 10.3 *
 beste Teiler 76.4 (32.) 99.1 (36.) 101.6 (33.)
 Trefferlage 0.23 mm links, 0.51 mm hoch
 Streuwert 1.09, horizontal: 0.96, vertikal: 1.20

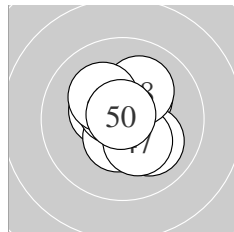

Serie 5:
 10.4 * 10.3 * 10.5 * 10.3 * 10.1 ↖
 10.6 * 10.3 * 10.1 ↑ 10.2 * 10.8 *
 beste Teiler 31.0 (50.) 91.2 (46.) 120.3 (43.)
 Trefferlage 0.21 mm rechts, 0.08 mm hoch
 Streuwert 1.17, horizontal: 1.06, vertikal: 1.27

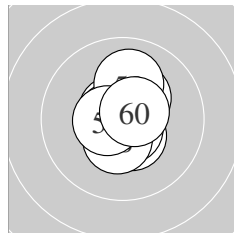

Serie 6:
 10.6 * 10.7 * 10.5 * 10.8 * 10.7 *
 10.4 * 10.3 * 10.0 ↑ 10.6 * 10.6 *
 beste Teiler 39.2 (54.) 67.4 (52.) 72.5 (55.)
 Trefferlage 0.06 mm rechts, 0.13 mm hoch
 Streuwert 0.90, horizontal: 0.65, vertikal: 1.08

Meyton Elektronik

ISSF AR Men – Wertung – **Männer**

StandNr: 125

Sampson, Dane #224

StartNr: 23

22. Januar 2019 9:45

AUS

QF – Schütze hat sich fürs Finale qualifiziert

Unterschrift des Schützen

Meyton Elektronik

Ergebnis:	629.5	(598) ^{QF}
Serien:	103.5	106.2 104.1 105.3 105.5 104.9
Zähler:	58	2 0 0 0 0 0 0 0 0
Innenzehner:	53	
weiteste:	342	(2), 317 (31), 244 (9)
beste Teiler	8.0	(34.) 13.0 (26.) 18.3 (43.)
Trefferlage	0.10 mm links, 0.08 mm hoch	
Streuwert	0.96, horizontal: 0.90, vertikal: 1.01	

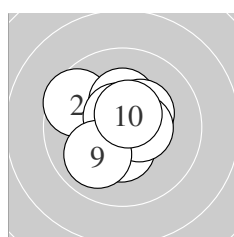
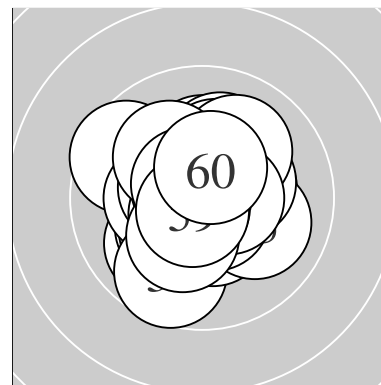

Serie 1:	10.4 *	9.6 ↖	10.7 *	10.3 *	10.4 *
	10.4 *	10.5 *	10.6 *	10.0 ↙	10.6 *
beste Teiler	62.2 (3.) 77.4 (8.) 94.5 (10.)				
Trefferlage	0.28 mm links, 0.19 mm hoch				
Streuwert	1.25, horizontal: 1.28, vertikal: 1.22				

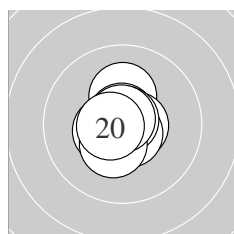

Serie 2:	10.2 *	10.8 *	10.8 *	10.6 *	10.7 *
	10.8 *	10.5 *	10.4 *	10.8 *	10.6 *
beste Teiler	31.7 (16.) 35.9 (19.) 40.3 (12.)				
Trefferlage	0.16 mm links, 0.04 mm hoch				
Streuwert	0.71, horizontal: 0.57, vertikal: 0.82				

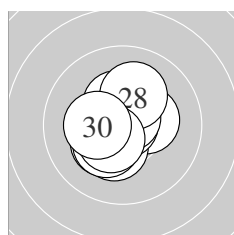

Serie 3:	10.3 *	10.3 *	10.3 *	10.4 *	10.3 *
	10.9 *	10.7 *	10.1 ↑	10.5 *	10.3 *
beste Teiler	13.0 (26.) 56.4 (27.) 119.2 (29.)				
Trefferlage	0.30 mm links, 0.05 mm tief				
Streuwert	1.06, horizontal: 0.97, vertikal: 1.14				

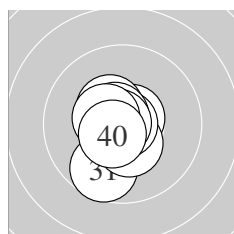

Serie 4:	9.7 ↓	10.7 *	10.4 *	10.9 *	10.4 *
	10.6 *	10.7 *	10.8 *	10.5 *	10.6 *
beste Teiler	8.0 (34.) 34.7 (38.) 67.4 (32.)				
Trefferlage	0.45 mm links, 0.23 mm tief				
Streuwert	0.92, horizontal: 0.62, vertikal: 1.14				

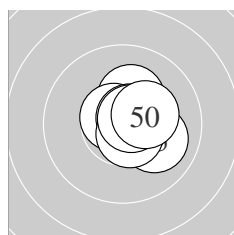

Serie 5:	10.7 *	10.2 *	10.9 *	10.7 *	10.0 ↘
	10.7 *	10.7 *	10.6 *	10.7 *	10.3 *
beste Teiler	18.3 (43.) 63.1 (47.) 64.7 (44.)				
Trefferlage	0.55 mm rechts, 0.24 mm hoch				
Streuwert	0.76, horizontal: 0.78, vertikal: 0.74				

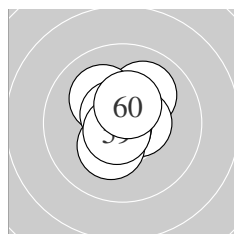

Serie 6:	10.0 ↗	10.7 *	10.7 *	10.5 *	10.3 *
	10.8 *	10.1 ↖	10.6 *	10.7 *	10.5 *
beste Teiler	48.0 (56.) 54.4 (53.) 62.8 (59.)				
Trefferlage	0.00 mm, 0.34 mm hoch				
Streuwert	0.94, horizontal: 0.83, vertikal: 1.04				

ISSF AR Men – Wertung – Männer

StandNr: 126

Maslennikov, Vladimir #70811309

StartNr: 24

22. Januar 2019 9:32

RUS

QF – Schütze hat sich fürs Finale qualifiziert

Unterschrift des Schützen

Meyton Elektronik

Ergebnis:	598.3	(570)
Serien:	99.7 98.0 99.7 102.8 98.4 99.7	
Zähler:	36 19 4 1 0 0 0 0 0 0	
Innenzehner:	25	
weiteste:	789 (8), 557 (43), 532 (57)	
beste Teiler	33.0 (55.) 33.9 (53.) 46.8 (28.)	
Trefferlage	0.73 mm rechts, 0.57 mm hoch	
Streuwert	1.94, horizontal: 2.17, vertikal: 1.68	

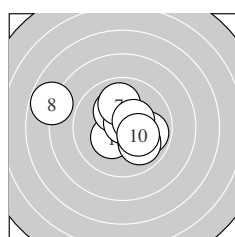
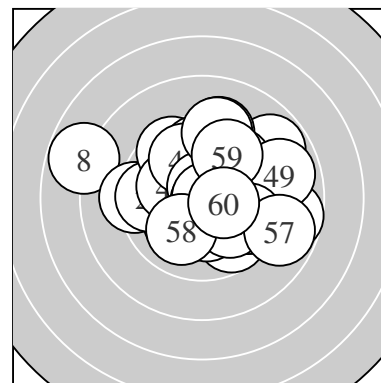

Serie 1:

10.3 *	10.2 *	9.9 →	10.8 *	10.1 ↘
10.0 ↘	10.0 ↑	7.8 ←	10.4 *	10.2 *
beste Teiler	48.7 (4.) 132.7 (9.) 156.3 (1.)			
Trefferlage	0.06 mm links, 0.21 mm hoch			
Streuwert	2.33, horizontal: 2.89, vertikal: 1.58			

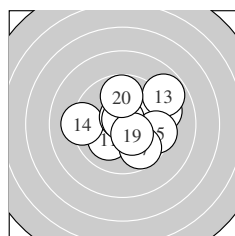

Serie 2:

10.1 ↗	9.2 →	8.8 ↗	9.2 ←	9.5 →
10.6 *	9.7 ↘	10.7 *	10.4 *	9.8 ↑
beste Teiler	51.1 (18.) 77.8 (16.) 144.2 (19.)			
Trefferlage	0.87 mm rechts, 0.27 mm hoch			
Streuwert	2.30, horizontal: 2.68, vertikal: 1.84			

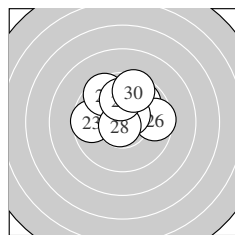

Serie 3:

10.0 ↗	9.9 ↗	9.6 ←	9.6 ↘	10.1 ↑
9.6 →	10.5 *	10.8 *	10.0 ↑	9.6 ↑
beste Teiler	46.8 (28.) 102.7 (27.) 206.5 (25.)			
Trefferlage	0.35 mm rechts, 1.49 mm hoch			
Streuwert	1.62, horizontal: 1.92, vertikal: 1.25			

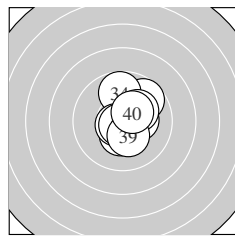

Serie 4:

9.7 ↗	10.3 *	10.3 *	9.8 ↑	10.4 *
10.6 *	10.8 *	10.2 *	10.3 *	10.4 *
beste Teiler	48.8 (37.) 77.1 (36.) 139.4 (40.)			
Trefferlage	0.70 mm rechts, 0.40 mm hoch			
Streuwert	1.25, horizontal: 1.01, vertikal: 1.46			

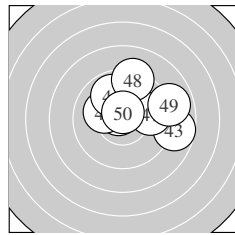

Serie 5:

10.7 *	10.1 ↘	8.7 →	10.3 *	10.1 ↑
9.9 ↘	9.8 →	9.2 ↑	8.9 →	10.7 *
beste Teiler	64.5 (41.) 71.0 (50.) 168.8 (44.)			
Trefferlage	1.24 mm rechts, 1.27 mm hoch			
Streuwert	2.01, horizontal: 2.47, vertikal: 1.40			

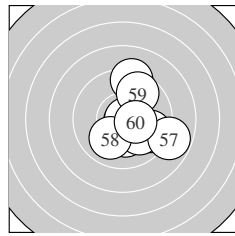

Serie 6:

10.2 *	9.7 ↘	10.8 *	10.0 ↘	10.8 *
9.3 ↑	8.8 ↘	10.0 ↗	9.7 ↑	10.4 *
beste Teiler	33.0 (55.) 33.9 (53.) 140.4 (60.)			
Trefferlage	1.30 mm rechts, 0.23 mm tief			
Streuwert	1.91, horizontal: 1.70, vertikal: 2.10			

Meyton Elektronik

ISSF AR Men – Wertung – Männer

StandNr: 127

Shjinbat, Erdembileg #70811359

StartNr: 25

22. Januar 2019 9:32

SUI – ZH

Unterschrift des Schützen

Meyton Elektronik

Ergebnis:	622.9	(597)
Serien:	104.5	104.5 104.1 103.5 103.8 102.5
Zähler:	57 3	0 0 0 0 0 0 0 0
Innenzehner:	49	
weiteste:	284 (1), 258 (41), 253 (58)	
beste Teiler	41.7 (2.)	44.4 (17.) 57.6 (49.)
Trefferlage	0.06 mm rechts,	0.10 mm tief
Streuwert	1.09, horizontal:	1.03, vertikal: 1.16

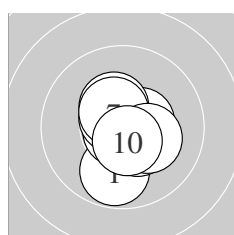
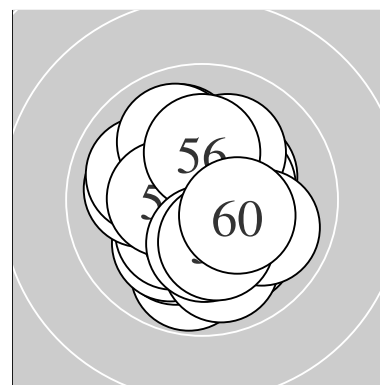

Serie 1:	9.8 ↓	10.8 *	10.5 *	10.6 *	10.6 *
	10.4 *	10.5 *	10.4 *	10.3 *	10.6 *
beste Teiler	41.7 (2.)	82.0 (4.)	92.0 (10.)		
Trefferlage	0.18 mm rechts, 0.32 mm tief				
Streuwert	1.02, horizontal: 0.81, vertikal: 1.19				

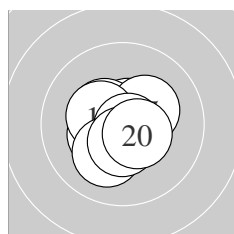

Serie 2:	10.5 *	10.6 *	10.4 *	10.4 *	10.3 *
	10.4 *	10.8 *	10.1 ↙	10.5 *	10.5 *
beste Teiler	44.4 (17.)	77.3 (12.)	112.6 (20.)		
Trefferlage	0.07 mm links, 0.11 mm tief				
Streuwert	1.00, horizontal: 1.08, vertikal: 0.91				

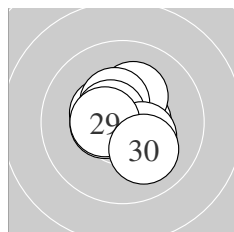

Serie 3:	10.4 *	10.6 *	10.5 *	10.5 *	10.2 *
	10.4 *	10.6 *	10.3 *	10.5 *	10.1 ↘
beste Teiler	89.0 (22.)	90.2 (27.)	114.0 (29.)		
Trefferlage	0.05 mm links, 0.24 mm hoch				
Streuwert	1.03, horizontal: 1.02, vertikal: 1.04				

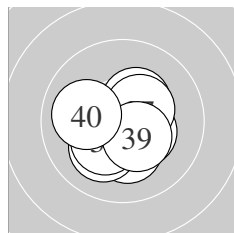

Serie 4:	10.2 *	10.7 *	10.4 *	10.6 *	10.1 ↙
	10.4 *	10.4 *	10.3 *	10.4 *	10.0 ←
beste Teiler	69.3 (32.)	93.1 (34.)	133.9 (37.)		
Trefferlage	0.05 mm links, 0.48 mm tief				
Streuwert	1.12, horizontal: 1.23, vertikal: 1.00				

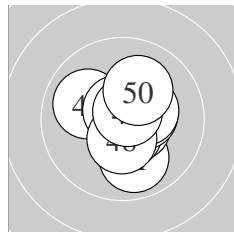

Serie 5:	9.9 ↓	10.0 ↖	10.7 *	10.6 *	10.6 *
	10.4 *	10.4 *	10.4 *	10.7 *	10.1 ↗
beste Teiler	57.6 (49.)	65.3 (43.)	97.4 (45.)		
Trefferlage	0.32 mm rechts, 0.04 mm tief				
Streuwert	1.16, horizontal: 1.06, vertikal: 1.25				

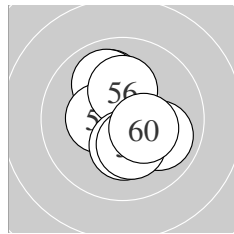

Serie 6:	10.0 ↗	10.0 ↗	10.6 *	10.4 *	10.4 *
	10.2 *	10.3 *	9.9 ↘	10.3 *	10.4 *
beste Teiler	87.4 (53.)	128.7 (54.)	143.0 (55.)		
Trefferlage	0.09 mm rechts, 0.09 mm hoch				
Streuwert	1.37, horizontal: 1.14, vertikal: 1.57				

Meyton Elektronik

ISSF AR Men – Wertung – Männer
StandNr: 128
Krishnaprasad, Tejas #70811303

StartNr: 26
22. Januar 2019 9:51
India

Unterschrift des Schützen

Meyton Elektronik

Ergebnis: **626.0** (597)^{QF}
 Serien: 103.5 104.8 105.0 104.8 105.3 102.6
 Zähler: 57 3 0 0 0 0 0 0 0 0
 Innenzehner: 50
 weiteste: 486 (58), 316 (59), 255 (17)
 beste Teiler 7.6 (22.) 11.6 (20.) 35.0 (46.)
 Trefferlage 0.21 mm links, 0.04 mm hoch
 Streuwert 1.06, horizontal: 1.27, vertikal: 0.80

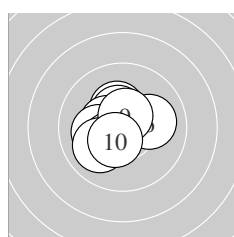
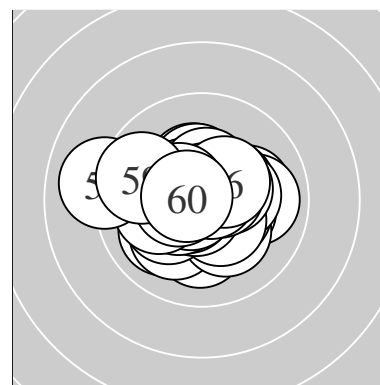

Serie 1:
 10.6 * 10.3 * 10.5 * 10.4 * 10.1 ←
 10.1 → 10.4 * 10.0 ↙ 10.6 * 10.5 *
 beste Teiler 79.4 (1.) 96.7 (9.) 121.9 (10.)
 Trefferlage 0.51 mm links, 0.12 mm hoch
 Streuwert 1.12, horizontal: 1.20, vertikal: 1.04

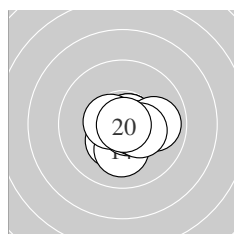

Serie 2:
 10.7 * 10.7 * 10.3 * 10.1 ↓ 10.7 *
 10.6 * 9.9 → 10.5 * 10.4 * 10.9 *
 beste Teiler 11.6 (20.) 51.0 (12.) 54.0 (15.)
 Trefferlage 0.44 mm rechts, 0.39 mm tief
 Streuwert 0.91, horizontal: 1.03, vertikal: 0.76

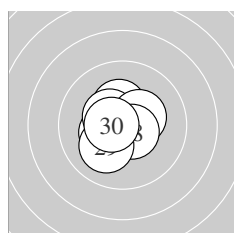

Serie 3:
 10.6 * 10.9 * 10.3 * 10.7 * 10.4 *
 10.4 * 10.4 * 10.6 * 10.1 ↙ 10.6 *
 beste Teiler 7.6 (22.) 69.3 (24.) 85.6 (21.)
 Trefferlage 0.15 mm links, 0.09 mm hoch
 Streuwert 0.93, horizontal: 0.98, vertikal: 0.88

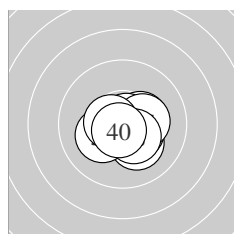

Serie 4:
 10.2 * 10.4 * 10.8 * 10.8 * 10.4 *
 10.2 * 10.3 * 10.4 * 10.6 * 10.7 *
 beste Teiler 40.3 (34.) 50.4 (33.) 59.1 (40.)
 Trefferlage 0.34 mm rechts, 0.38 mm tief
 Streuwert 0.91, horizontal: 1.11, vertikal: 0.65

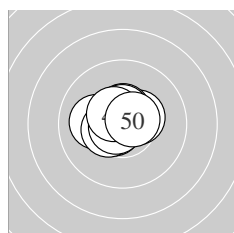

Serie 5:
 10.6 * 10.4 * 10.5 * 10.1 ← 10.6 *
 10.8 * 10.5 * 10.7 * 10.5 * 10.6 *
 beste Teiler 35.0 (46.) 59.2 (48.) 80.0 (41.)
 Trefferlage 0.30 mm links, 0.31 mm hoch
 Streuwert 0.79, horizontal: 0.97, vertikal: 0.55

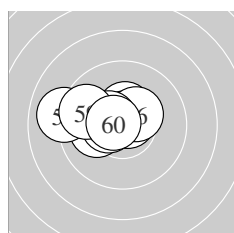

Serie 6:
 10.1 ← 10.4 * 10.7 * 10.7 * 10.5 *
 10.4 * 10.5 * 9.0 ← 9.7 ← 10.6 *
 beste Teiler 54.2 (54.) 55.3 (53.) 77.1 (60.)
 Trefferlage 1.10 mm links, 0.52 mm hoch
 Streuwert 1.31, horizontal: 1.78, vertikal: 0.52

Meyton Elektronik

ISSF AR Men – Wertung – Männer

StandNr: 129

Dempster, Christenson #70811312

StartNr: 27

22. Januar 2019 10:00

USA

QF – Schütze hat sich fürs Finale qualifiziert

Unterschrift des Schützen

Meyton Elektronik

Ergebnis:	624.8	(596)						
Serien:	103.4	103.0	104.4	103.9	105.4	104.7		
Zähler:	56	4	0	0	0	0	0	0
Innenzehner:	48							
weiteste:	339	(6),	293	(28),	291	(20)		
beste Teiler	25.0	(7.)	28.3	(49.)	33.1	(19.)		
Trefferlage	0.04 mm rechts, 0.06 mm hoch							
Streuwert	1.08, horizontal: 1.13, vertikal: 1.03							

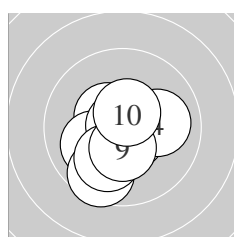
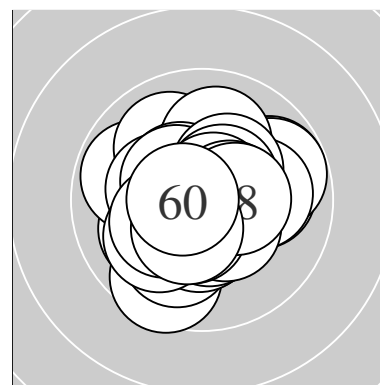

Serie 1:

10.8 *	10.6 *	10.5 *	10.0 →	10.1 ↙
9.6 ↘	10.9 *	10.0 ↘	10.4 *	10.5 *
beste Teiler	25.0 (7.)	47.1 (1.)	82.7 (2.)	
Trefferlage	0.26 mm links, 0.65 mm tief			
Streuwert	1.24, horizontal: 1.20, vertikal: 1.28			

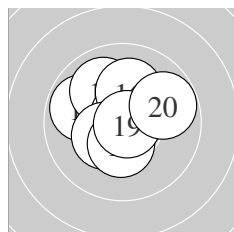

Serie 2:

9.8 ↖	10.4 *	10.0 ↖	10.8 *	10.5 *
10.1 ↑	10.4 *	10.4 *	10.8 *	9.8 →
beste Teiler	33.1 (19.)	38.6 (14.)	101.2 (15.)	
Trefferlage	0.11 mm links, 0.59 mm hoch			
Streuwert	1.29, horizontal: 1.42, vertikal: 1.16			

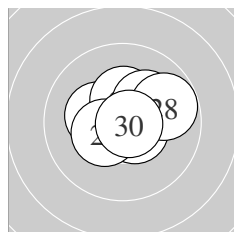

Serie 3:

10.3 *	10.5 *	10.7 *	10.7 *	10.6 *
10.4 *	10.2 *	9.8 →	10.4 *	10.8 *
beste Teiler	44.6 (30.)	56.6 (24.)	65.1 (23.)	
Trefferlage	0.40 mm rechts, 0.44 mm hoch			
Streuwert	1.02, horizontal: 1.25, vertikal: 0.73			

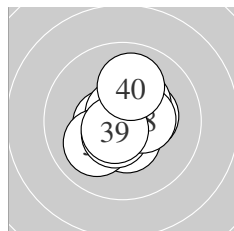

Serie 4:

10.5 *	10.5 *	10.7 *	10.1 ↙	10.3 *
10.3 *	10.5 *	10.4 *	10.6 *	10.0 ↑
beste Teiler	57.6 (33.)	77.8 (39.)	101.2 (37.)	
Trefferlage	0.05 mm rechts, 0.01 mm hoch			
Streuwert	1.10, horizontal: 1.05, vertikal: 1.14			

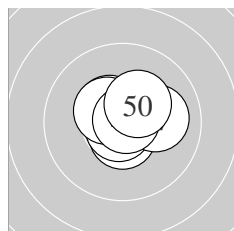

Serie 5:

10.5 *	10.6 *	10.6 *	10.8 *	10.8 *
10.5 *	10.1 →	10.4 *	10.8 *	10.3 *
beste Teiler	28.3 (49.)	33.6 (44.)	46.3 (45.)	
Trefferlage	0.17 mm rechts, 0.33 mm hoch			
Streuwert	0.83, horizontal: 0.99, vertikal: 0.63			

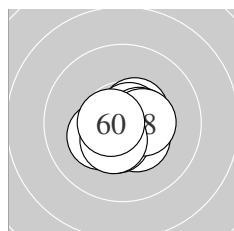

Serie 6:

10.5 *	10.4 *	10.7 *	10.4 *	10.5 *
10.3 *	10.5 *	10.4 *	10.4 *	10.6 *
beste Teiler	63.6 (53.)	78.0 (60.)	110.7 (55.)	
Trefferlage	0.03 mm rechts, 0.34 mm tief			
Streuwert	0.86, horizontal: 1.00, vertikal: 0.71			

Meyton Elektronik

ISSF AR Men – Wertung – Männer

StandNr: 130

Schmir, Alexander #232

StartNr: 28

22. Januar 2019 9:51

AUT

Unterschrift des Schützen

Meyton Elektronik

Ergebnis:	623.5	(596)					
Serien:	103.6	102.8	103.9	104.0	104.2	105.0	
Zähler:	56	4	0	0	0	0	0
Innenzehner:	54						
weiteste:	331	(13),	289	(9),	279	(30)	
beste Teiler	39.6	(60.)	42.5	(49.)	48.7	(44.)	
Trefferlage	0.48 mm rechts, 0.20 mm hoch						
Streuwert	1.03, horizontal: 1.07, vertikal: 0.99						

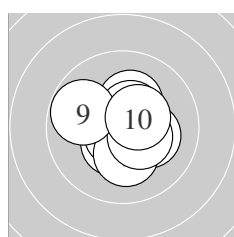
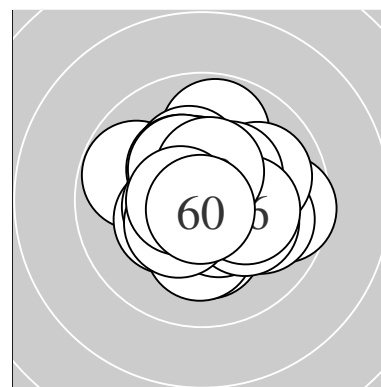

Serie 1:	10.2 *	10.4 *	10.3 *	10.6 *	10.5 *
	10.7 *	10.2 *	10.4 *	9.8 ↖	10.5 *
beste Teiler	64.0 (6.) 97.2 (4.) 111.1 (5.)				
Trefferlage	0.24 mm rechts, 0.08 mm tief				
Streuwert	1.18, horizontal: 1.26, vertikal: 1.10				

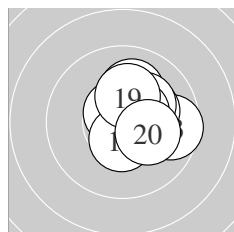

Serie 2:	10.1 ↗	10.6 *	9.6 →	10.7 *	10.2 *
	10.2 *	10.5 *	10.5 *	10.2 *	10.2 *
beste Teiler	66.1 (14.) 79.6 (12.) 116.2 (18.)				
Trefferlage	1.01 mm rechts, 0.47 mm hoch				
Streuwert	1.07, horizontal: 1.08, vertikal: 1.07				

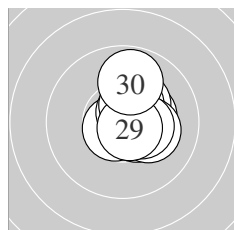

Serie 3:	10.3 *	10.7 *	10.5 *	10.3 *	10.6 *
	10.4 *	10.2 *	10.4 *	10.7 *	9.8 ↑
beste Teiler	63.2 (29.) 67.4 (22.) 79.4 (25.)				
Trefferlage	0.81 mm rechts, 0.40 mm hoch				
Streuwert	0.89, horizontal: 0.65, vertikal: 1.07				

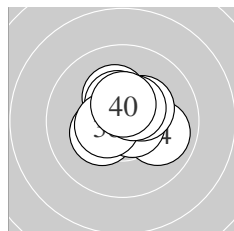

Serie 4:	10.3 *	10.3 *	10.6 *	9.9 ↘	10.4 *
	10.7 *	10.3 *	10.5 *	10.5 *	10.5 *
beste Teiler	71.5 (36.) 95.2 (33.) 109.6 (38.)				
Trefferlage	0.23 mm rechts, 0.44 mm hoch				
Streuwert	1.02, horizontal: 1.14, vertikal: 0.89				

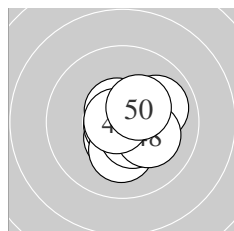

Serie 5:	10.2 *	10.5 *	10.6 *	10.8 *	10.2 *
	10.0 →	10.5 *	10.2 *	10.8 *	10.4 *
beste Teiler	42.5 (49.) 48.7 (44.) 87.2 (43.)				
Trefferlage	0.58 mm rechts, 0.15 mm tief				
Streuwert	1.05, horizontal: 1.08, vertikal: 1.02				

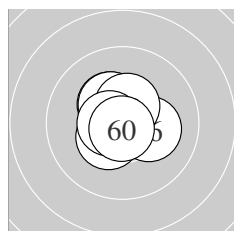

Serie 6:	10.3 *	10.4 *	10.4 *	10.4 *	10.7 *
	10.2 *	10.7 *	10.5 *	10.6 *	10.8 *
beste Teiler	39.6 (60.) 57.5 (55.) 60.2 (57.)				
Trefferlage	0.01 mm links, 0.15 mm hoch				
Streuwert	0.91, horizontal: 1.01, vertikal: 0.79				

Meyton Elektronik

ISSF AR Men – Wertung – Männer

StandNr: 131

Dürr, Christoph #70811317

StartNr: 29

22. Januar 2019 9:43

SUI

Unterschrift des Schützen

Meyton Elektronik

Ergebnis: **625.4** (597)^{QF}
 Serien: 105.6 104.3 104.2 103.0 102.9 105.4
 Zähler: 57 3 0 0 0 0 0 0 0 0
 Innenzehner: 52
 weiteste: 308 (39), 281 (52), 255 (50)
 beste Teiler 5.8 (1.) 12.0 (20.) 36.6 (10.)
 Trefferlage 0.06 mm rechts, 0.00 mm
 Streuwert 1.04, horizontal: 1.13, vertikal: 0.93

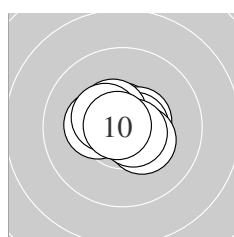
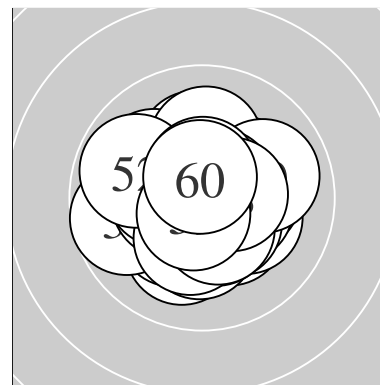

Serie 1:
 10.9 * 10.7 * 10.5 * 10.3 * 10.6 *
 10.5 * 10.3 * 10.6 * 10.4 * 10.8 *
 beste Teiler 5.8 (1.) 36.6 (10.) 68.0 (2.)
 Trefferlage 0.00 mm , 0.17 mm hoch
 Streuwert 0.77, horizontal: 0.96, vertikal: 0.52

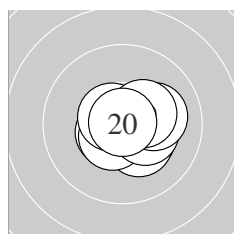

Serie 2:
 10.3 * 10.5 * 10.4 * 10.3 * 10.5 *
 10.3 * 10.1 → 10.6 * 10.4 * 10.9 *
 beste Teiler 12.0 (20.) 85.4 (18.) 102.9 (15.)
 Trefferlage 0.60 mm rechts, 0.31 mm tief
 Streuwert 0.90, horizontal: 1.06, vertikal: 0.70

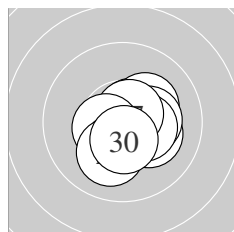

Serie 3:
 10.2 * 10.6 * 10.2 * 10.7 * 10.3 *
 10.4 * 10.7 * 10.5 * 10.1 ↓ 10.5 *
 beste Teiler 53.7 (24.) 71.8 (27.) 89.8 (22.)
 Trefferlage 0.59 mm rechts, 0.26 mm tief
 Streuwert 0.95, horizontal: 1.00, vertikal: 0.90

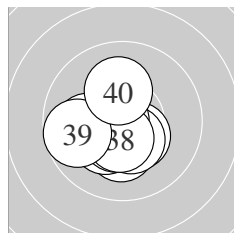

Serie 4:
 10.2 * 10.4 * 10.3 * 10.0 ← 10.5 *
 10.4 * 10.8 * 10.5 * 9.7 ← 10.2 *
 beste Teiler 50.1 (37.) 114.4 (38.) 120.7 (35.)
 Trefferlage 0.64 mm links, 0.66 mm tief
 Streuwert 1.13, horizontal: 1.20, vertikal: 1.06

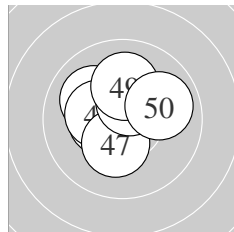

Serie 5:
 10.6 * 10.4 * 10.0 ↖ 10.4 * 10.4 *
 10.3 * 10.3 * 10.5 * 10.1 ↑ 9.9 →
 beste Teiler 85.6 (41.) 123.6 (48.) 133.7 (42.)
 Trefferlage 0.15 mm links, 0.69 mm hoch
 Streuwert 1.17, horizontal: 1.30, vertikal: 1.02

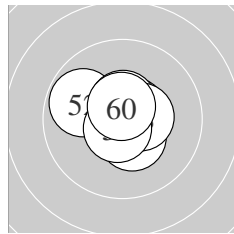

Serie 6:
 10.6 * 9.8 ↖ 10.6 * 10.8 * 10.7 *
 10.4 * 10.7 * 10.5 * 10.7 * 10.6 *
 beste Teiler 46.8 (54.) 57.9 (57.) 63.1 (55.)
 Trefferlage 0.02 mm links, 0.33 mm hoch
 Streuwert 0.87, horizontal: 1.00, vertikal: 0.71

Meyton Elektronik

ISSF AR Men – Wertung – Männer

StandNr: 132

Germond, Etienne #70811300

StartNr: 30

22. Januar 2019 9:57

FRA

QF – Schütze hat sich fürs Finale qualifiziert

Unterschrift des Schützen

Meyton Elektronik

Ergebnis: **624.6** (595)
 Serien: 104.3 104.1 104.2 104.6 103.7 103.7
 Zähler: 55 5 0 0 0 0 0 0 0 0
 Innenzehner: 51
 weiteste: 368 (2), 355 (22), 333 (11)
 beste Teiler 5.8 (39.) 9.0 (3.) 41.1 (4.)
 Trefferlage 0.25 mm rechts, 0.10 mm tief
 Streuwert 1.10, horizontal: 1.14, vertikal: 1.06

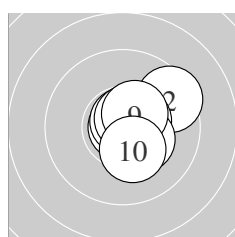
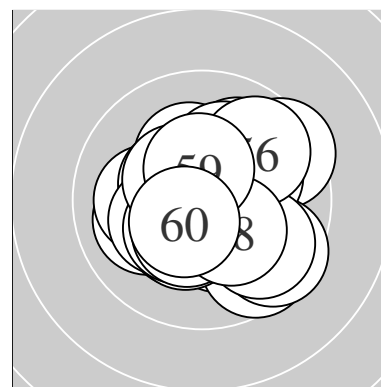

Serie 1:
 10.4 * 9.5 ↗ 10.9 * 10.8 * 10.4 *
 10.5 * 10.3 * 10.7 * 10.5 * 10.3 *
 beste Teiler 9.0 (3.) 41.1 (4.) 67.6 (8.)
 Trefferlage 0.96 mm rechts, 0.16 mm hoch
 Streuwert 0.95, horizontal: 0.92, vertikal: 0.99

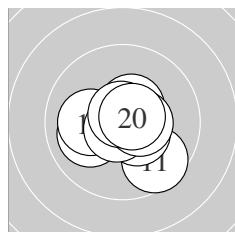

Serie 2:
 9.6 ↘ 10.8 * 10.5 * 10.0 ↖ 10.1 ←
 10.7 * 10.5 * 10.5 * 10.7 * 10.7 *
 beste Teiler 42.0 (12.) 52.9 (19.) 59.5 (16.)
 Trefferlage 0.11 mm rechts, 0.26 mm tief
 Streuwert 1.20, horizontal: 1.39, vertikal: 0.97

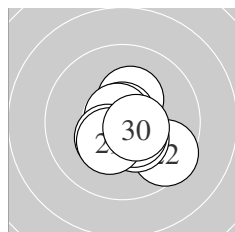

Serie 3:
 10.3 * 9.5 ↘ 10.6 * 10.8 * 10.4 *
 10.5 * 10.8 * 10.4 * 10.3 * 10.6 *
 beste Teiler 46.0 (24.) 50.9 (27.) 97.1 (23.)
 Trefferlage 0.36 mm rechts, 0.53 mm tief
 Streuwert 1.09, horizontal: 1.12, vertikal: 1.05

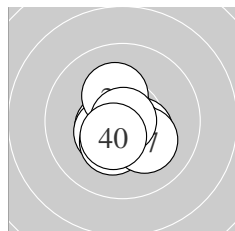

Serie 4:
 10.4 * 10.6 * 10.6 * 10.5 * 10.4 *
 10.3 * 10.2 * 10.2 * 10.9 * 10.5 *
 beste Teiler 5.8 (39.) 78.2 (32.) 80.4 (33.)
 Trefferlage 0.10 mm links, 0.36 mm tief
 Streuwert 0.92, horizontal: 0.88, vertikal: 0.96

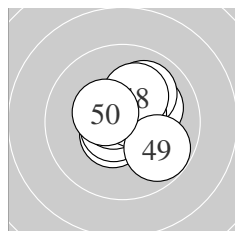

Serie 5:
 10.7 * 10.5 * 10.7 * 10.1 ↗ 10.7 *
 10.0 ↗ 10.6 * 10.2 * 9.8 ↘ 10.4 *
 beste Teiler 53.1 (41.) 73.8 (43.) 74.3 (45.)
 Trefferlage 0.36 mm rechts, 0.32 mm hoch
 Streuwert 1.18, horizontal: 1.23, vertikal: 1.13

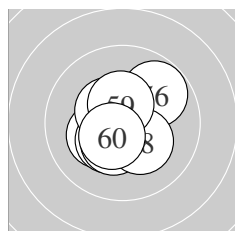

Serie 6:
 10.2 * 10.8 * 10.4 * 10.4 * 10.5 *
 9.8 ↗ 10.4 * 10.3 * 10.4 * 10.5 *
 beste Teiler 44.2 (52.) 111.4 (55.) 114.4 (60.)
 Trefferlage 0.17 mm links, 0.02 mm hoch
 Streuwert 1.17, horizontal: 1.10, vertikal: 1.22

Meyton Elektronik

ISSF AR Men – Wertung – Männer

StandNr: 133

Akhil, Sheoran #70811313

StartNr: 31

22. Januar 2019 9:54

IND

Unterschrift des Schützen

Meyton Elektronik

Ergebnis: **621.3** (598)
 Serien: 104.2 102.6 103.7 103.3 103.7 103.8
 Zähler: 58 2 0 0 0 0 0 0 0 0
 Innenzehner: 46
 weiteste: 306 (14), 271 (46), 246 (45)
 beste Teiler 41.4 (48.) 46.0 (53.) 46.7 (47.)
 Trefferlage 0.04 mm rechts, 0.44 mm hoch
 Streuwert 1.11, horizontal: 1.25, vertikal: 0.95

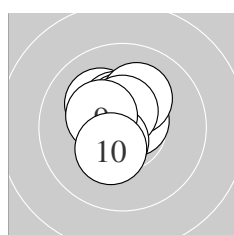
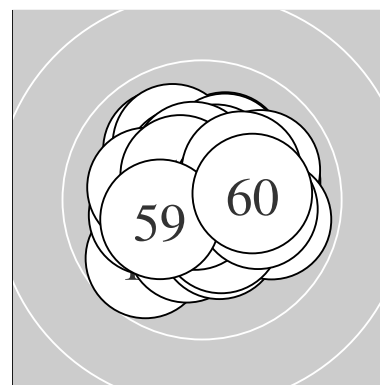

Serie 1:
 10.1 ↘ 10.4 * 10.7 * 10.6 * 10.5 *
 10.2 * 10.5 * 10.5 * 10.4 * 10.3 *
 beste Teiler 56.5 (3.) 78.5 (4.) 101.0 (7.)
 Trefferlage 0.35 mm links, 0.59 mm hoch
 Streuwert 0.88, horizontal: 0.74, vertikal: 1.00

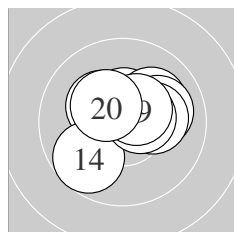

Serie 2:
 10.5 * 10.4 * 10.3 * 9.7 ↙ 10.1 ↗
 10.0 → 10.2 * 10.5 * 10.5 * 10.4 *
 beste Teiler 114.4 (18.) 116.2 (11.) 117.5 (19.)
 Trefferlage 0.23 mm rechts, 0.49 mm hoch
 Streuwert 1.31, horizontal: 1.55, vertikal: 1.00

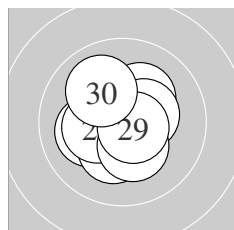

Serie 3:
 10.2 * 10.7 * 10.1 ← 10.4 * 10.3 *
 10.7 * 10.3 * 10.3 * 10.7 * 10.0 ↘
 beste Teiler 52.1 (22.) 60.2 (26.) 74.2 (29.)
 Trefferlage 0.22 mm links, 0.03 mm tief
 Streuwert 1.16, horizontal: 1.16, vertikal: 1.15

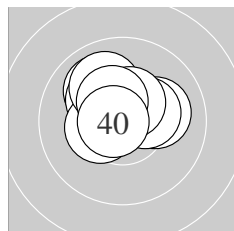

Serie 4:
 10.1 → 10.6 * 10.0 ↘ 10.4 * 10.2 *
 10.4 * 10.0 ↘ 10.5 * 10.4 * 10.7 *
 beste Teiler 59.0 (40.) 95.5 (32.) 124.4 (38.)
 Trefferlage 0.32 mm links, 0.90 mm hoch
 Streuwert 1.04, horizontal: 1.23, vertikal: 0.80

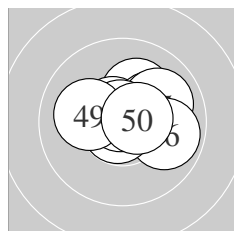

Serie 5:
 10.2 * 10.6 * 10.6 * 10.1 ↗ 10.0 ↗
 9.9 → 10.8 * 10.8 * 10.1 ← 10.6 *
 beste Teiler 41.4 (48.) 46.7 (47.) 77.4 (43.)
 Trefferlage 0.44 mm rechts, 0.46 mm hoch
 Streuwert 1.16, horizontal: 1.48, vertikal: 0.71

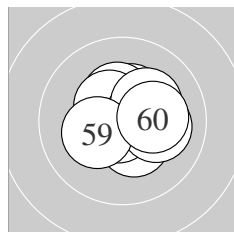

Serie 6:
 10.4 * 10.4 * 10.8 * 10.4 * 10.5 *
 10.5 * 10.1 → 10.2 * 10.3 * 10.2 *
 beste Teiler 46.0 (53.) 121.8 (56.) 124.7 (55.)
 Trefferlage 0.48 mm rechts, 0.26 mm hoch
 Streuwert 1.08, horizontal: 1.22, vertikal: 0.93

Meyton Elektronik

ISSF AR Men – Wertung – Männer

StandNr: 134

Timothy, Sherry #70811318

StartNr: 32

22. Januar 2019 9:57

USA

Unterschrift des Schützen

Meyton Elektronik

Ergebnis:	611.0	(585)							
Serien:	102.7	103.1	101.5	100.8	100.9	102.0			
Zähler:	45	15	0	0	0	0	0	0	0
Innenzehner:	35								
weiteste:	435 (32), 356 (37), 341 (23)								
beste Teiler	51.6 (24.) 62.5 (7.) 68.1 (20.)								
Trefferlage	0.26 mm rechts, 0.11 mm hoch								
Streuwert	1.47, horizontal: 1.59, vertikal: 1.35								

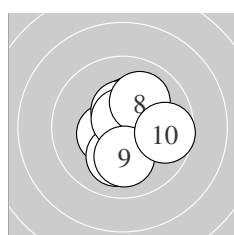
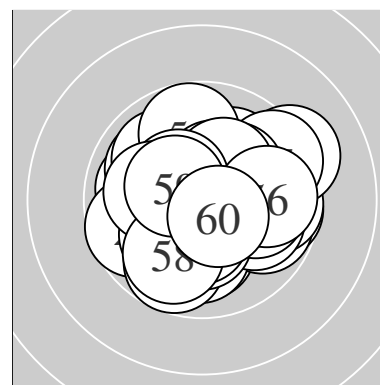

Serie 1:					
	10.5 *	10.5 *	10.3 *	10.3 *	10.1 ↓
	10.5 *	10.7 *	10.0 ↗	10.1 ↓	9.7 →
beste Teiler	62.5 (7.) 111.1 (1.) 121.4 (6.)				
Trefferlage	0.35 mm rechts, 0.02 mm hoch				
Streuwert	1.35, horizontal: 1.25, vertikal: 1.44				

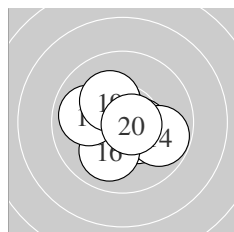

Serie 2:					
	10.7 *	10.4 *	10.4 *	9.8 ↘	10.7 *
	10.0 ↓	10.3 *	9.9 ←	10.2 *	10.7 *
beste Teiler	68.1 (20.) 72.1 (15.) 75.7 (11.)				
Trefferlage	0.06 mm links, 0.12 mm tief				
Streuwert	1.31, horizontal: 1.48, vertikal: 1.13				

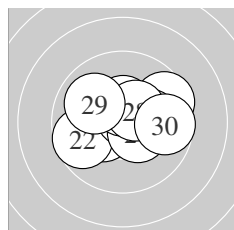

Serie 3:					
	10.3 *	9.7 ←	9.6 ↗	10.7 *	10.2 *
	10.4 *	10.5 *	10.4 *	10.0 ↖	9.7 →
beste Teiler	51.6 (24.) 120.0 (27.) 128.2 (28.)				
Trefferlage	0.41 mm rechts, 0.27 mm hoch				
Streuwert	1.62, horizontal: 2.08, vertikal: 0.95				

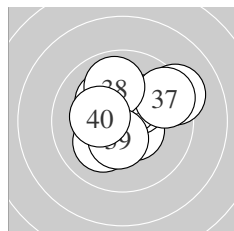

Serie 4:					
	10.5 *	9.2 ↗	10.2 *	10.1 ↙	10.3 *
	10.4 *	9.5 ↗	9.9 ↑	10.4 *	10.3 *
beste Teiler	108.8 (31.) 134.1 (39.) 138.2 (36.)				
Trefferlage	0.40 mm rechts, 0.70 mm hoch				
Streuwert	1.67, horizontal: 1.89, vertikal: 1.42				

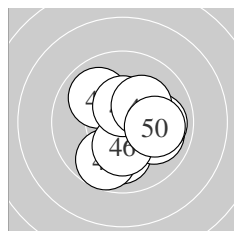

Serie 5:					
	10.4 *	10.0 ↓	9.9 ↖	10.0 ↘	9.7 ↓
	10.3 *	10.5 *	9.9 →	10.2 *	10.0 →
beste Teiler	117.0 (47.) 137.8 (41.) 174.0 (46.)				
Trefferlage	0.65 mm rechts, 0.49 mm tief				
Streuwert	1.53, horizontal: 1.52, vertikal: 1.55				

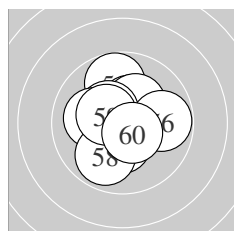

Serie 6:					
	9.8 ↑	10.4 *	10.4 *	10.3 *	10.4 *
	9.8 →	10.1 ←	9.9 ↓	10.4 *	10.5 *
beste Teiler	101.8 (60.) 134.6 (59.) 137.7 (55.)				
Trefferlage	0.13 mm links, 0.30 mm hoch				
Streuwert	1.49, horizontal: 1.45, vertikal: 1.53				

Meyton Elektronik

ISSF AR Men – Wertung – Männer

StandNr: 135

Harlacher, Renato #70811308

StartNr: 33

22. Januar 2019 9:59

SUI – ZH

Unterschrift des Schützen

Meyton Elektronik

Ergebnis: **616.5** (591)

Serien: 104.6 103.3 101.4 102.9 101.2 103.1

Zähler: 51 9 0 0 0 0 0 0 0 0

Innenzehner: 37

weiteste: 329 (31), 312 (13), 294 (60)

beste Teiler 10.8 (3.) 34.1 (51.) 36.1 (9.)

Trefferlage 0.19 mm links, 0.04 mm hoch

Streuwert 1.31, horizontal: 1.43, vertikal: 1.19

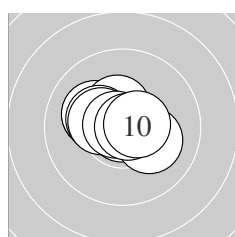
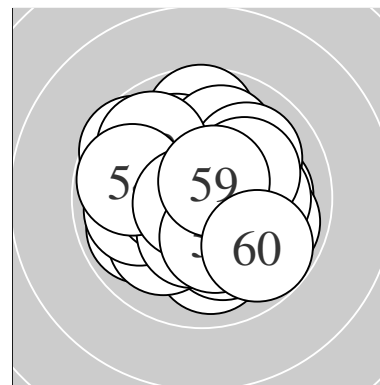

Serie 1:

10.1 ↖	10.1 ↖	10.9 *	10.4 *	10.2 *
10.3 *	10.4 *	10.8 *	10.8 *	10.6 *

beste Teiler 10.8 (3.) 36.1 (9.) 47.1 (8.)

Trefferlage 0.44 mm links, 0.33 mm hoch

Streuwert 0.98, horizontal: 1.25, vertikal: 0.60

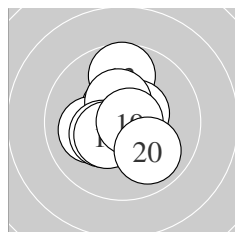

Serie 2:

10.6 *	10.6 *	9.7 ↑	10.1 ←	10.5 *
10.4 *	10.3 *	10.4 *	10.8 *	9.9 ↘

beste Teiler 47.1 (19.) 78.4 (11.) 100.1 (12.)

Trefferlage 0.28 mm links, 0.24 mm hoch

Streuwert 1.26, horizontal: 1.10, vertikal: 1.40

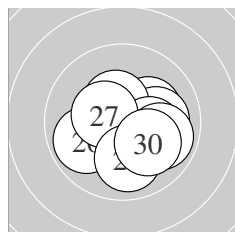

Serie 3:

10.2 *	10.1 →	10.2 *	10.4 *	10.2 *
9.9 ↙	10.4 *	10.0 ↓	9.9 ↘	10.1 ↘

beste Teiler 131.3 (27.) 132.6 (24.) 176.8 (23.)

Trefferlage 0.47 mm rechts, 0.48 mm tief

Streuwert 1.48, horizontal: 1.76, vertikal: 1.13

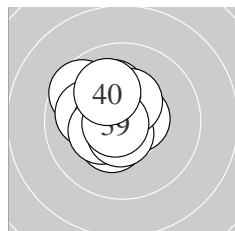

Serie 4:

9.6 ↖	10.4 *	10.0 ←	10.6 *	10.2 *
10.3 *	10.6 *	10.4 *	10.7 *	10.1 ↘

beste Teiler 51.8 (39.) 84.3 (37.) 95.3 (34.)

Trefferlage 0.80 mm links, 0.48 mm hoch

Streuwert 1.17, horizontal: 1.13, vertikal: 1.21

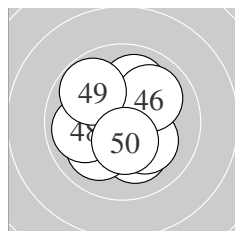

Serie 5:

10.0 ↑	10.1 ↘	10.2 *	10.7 *	10.1 ←
10.0 ↗	10.0 ↙	9.9 ←	9.8 ↖	10.4 *

beste Teiler 57.9 (44.) 128.0 (50.) 194.6 (43.)

Trefferlage 0.36 mm links, 0.04 mm tief

Streuwert 1.57, horizontal: 1.58, vertikal: 1.55

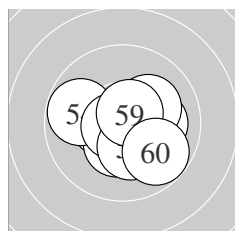

Serie 6:

10.8 *	10.4 *	10.4 *	9.8 ←	10.7 *
10.1 →	10.2 *	10.3 *	10.6 *	9.8 ↘

beste Teiler 34.1 (51.) 59.2 (55.) 82.4 (59.)

Trefferlage 0.23 mm rechts, 0.28 mm tief

Streuwert 1.33, horizontal: 1.58, vertikal: 1.02

Meyton Elektronik

ISSF AR Men – Wertung – Männer

StandNr: 137

Greuter, Sandro #70811311

StartNr: 34

22. Januar 2019 9:52

SUI – Sportschützen Sargans

Unterschrift des Schützen

Meyton Elektronik

Ergebnis: **630.1** (600)^{QF}
 Serien: 105.2 104.1 105.1 106.4 103.4 105.9
 Zähler: 60 0 0 0 0 0 0 0 0 0
 Innenzehner: 53
 weiteste: 240 (13), 237 (48), 226 (18)
 beste Teiler 13.3 (54.) 29.4 (20.) 37.3 (1.)
 Trefferlage 0.09 mm links, 0.07 mm hoch
 Streuwert 0.92, horizontal: 0.90, vertikal: 0.93

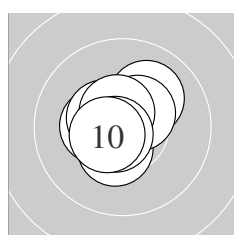
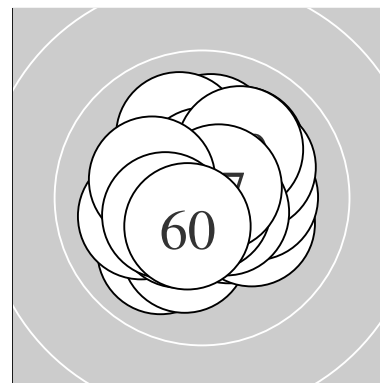

Serie 1:
 10.8 * 10.4 * 10.4 * 10.1 ↗ 10.7 *
 10.5 * 10.5 * 10.6 * 10.7 * 10.5 *
 beste Teiler 37.3 (1.) 60.1 (5.) 60.8 (9.)
 Trefferlage 0.28 mm links, 0.26 mm hoch
 Streuwert 0.85, horizontal: 0.88, vertikal: 0.83

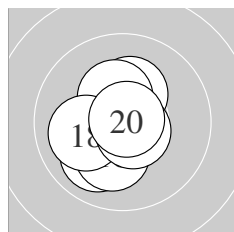

Serie 2:
 10.7 * 10.7 * 10.0 ✓ 10.5 * 10.3 *
 10.2 * 10.3 * 10.0 ← 10.6 * 10.8 *
 beste Teiler 29.4 (20.) 63.1 (12.) 75.2 (11.)
 Trefferlage 0.39 mm links, 0.37 mm tief
 Streuwert 1.05, horizontal: 0.89, vertikal: 1.20

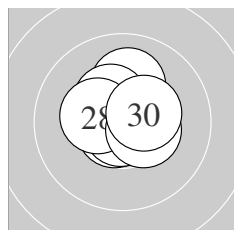

Serie 3:
 10.7 * 10.5 * 10.8 * 10.7 * 10.8 *
 10.1 ↑ 10.4 * 10.3 * 10.4 * 10.4 *
 beste Teiler 39.8 (25.) 44.1 (23.) 63.5 (24.)
 Trefferlage 0.05 mm rechts, 0.43 mm hoch
 Streuwert 0.86, horizontal: 0.86, vertikal: 0.85

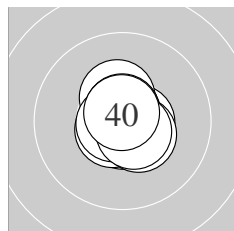

Serie 4:
 10.6 * 10.7 * 10.4 * 10.6 * 10.8 *
 10.7 * 10.7 * 10.5 * 10.6 * 10.8 *
 beste Teiler 50.0 (35.) 50.3 (40.) 54.7 (37.)
 Trefferlage 0.09 mm rechts, 0.01 mm hoch
 Streuwert 0.63, horizontal: 0.55, vertikal: 0.70

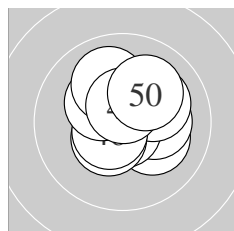

Serie 5:
 10.2 * 10.2 * 10.8 * 10.1 ↗ 10.5 *
 10.6 * 10.3 * 10.0 ↘ 10.6 * 10.1 ↗
 beste Teiler 46.2 (43.) 94.4 (46.) 97.1 (49.)
 Trefferlage 0.33 mm rechts, 0.43 mm hoch
 Streuwert 1.20, horizontal: 1.25, vertikal: 1.14

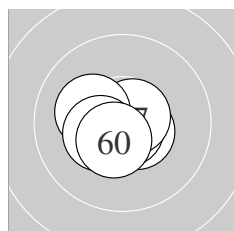

Serie 6:
 10.6 * 10.8 * 10.6 * 10.9 * 10.7 *
 10.5 * 10.7 * 10.2 * 10.4 * 10.5 *
 beste Teiler 13.3 (54.) 40.8 (52.) 51.0 (55.)
 Trefferlage 0.38 mm links, 0.31 mm tief
 Streuwert 0.69, horizontal: 0.82, vertikal: 0.53

Meyton Elektronik

ISSF AR Men – Wertung – Männer

StandNr: 138

Driagin, Aleksandr #70811319

StartNr: 35

22. Januar 2019 9:40

RUS

QF – Schütze hat sich fürs Finale qualifiziert

Unterschrift des Schützen

Meyton Elektronik

Ergebnis:	604.9	(580)
Serien:	99.6	103.0 95.9 101.3 102.3 102.8
Zähler:	41 18 1 0 0 0 0 0 0 0	
Innenzehner:	30	
weiteste:	580 (4), 499 (29), 477 (24)	
beste Teiler	39.6 (50.) 42.4 (56.) 68.1 (14.)	
Trefferlage	0.43 mm links, 0.56 mm hoch	
Streuwert	1.67, horizontal: 1.87, vertikal: 1.45	

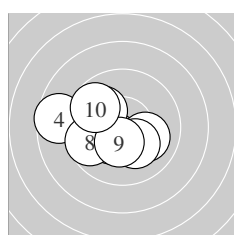
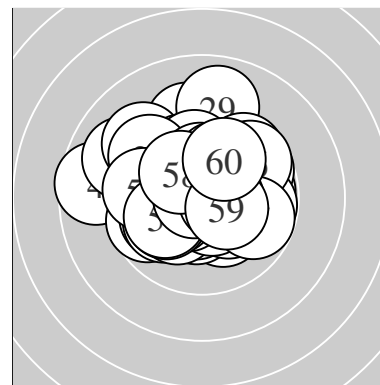

Serie 1:	10.5 *	10.0 ↖	10.1 ↗	8.6 ↖	10.4 *
	10.2 *	10.0 ↖	9.7 ↖	10.4 *	9.7 ↖
beste Teiler	120.3 (1.)	138.2 (9.)	147.9 (5.)		
Trefferlage	1.40 mm links, 0.19 mm tief				
Streuwert	1.80, horizontal: 2.19, vertikal: 1.28				

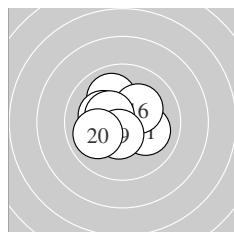

Serie 2:	10.1 ↗	10.0 ↖	10.6 *	10.7 *	10.3 *
	10.2 *	10.2 *	10.4 *	10.5 *	10.0 ↖
beste Teiler	68.1 (14.)	78.6 (13.)	113.8 (19.)		
Trefferlage	0.60 mm links, 0.23 mm hoch				
Streuwert	1.21, horizontal: 1.36, vertikal: 1.02				

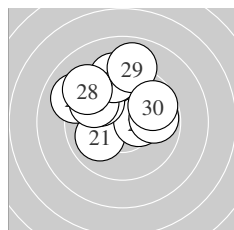

Serie 3:	10.0 ↖	10.4 *	9.8 →	9.0 ↖	9.8 ↖
	9.7 ↖	9.3 ↑	9.2 ↖	9.0 ↑	9.7 ↗
beste Teiler	144.0 (22.)	240.6 (21.)	278.2 (25.)		
Trefferlage	0.71 mm links, 1.82 mm hoch				
Streuwert	2.21, horizontal: 2.52, vertikal: 1.85				

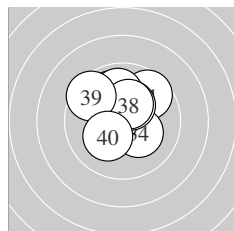

Serie 4:	9.7 ↗	9.9 ↖	10.7 *	10.2 *	9.9 ↑
	10.6 *	10.3 *	10.3 *	9.5 ↖	10.2 *
beste Teiler	70.1 (33.)	76.0 (36.)	159.2 (37.)		
Trefferlage	0.06 mm links, 1.03 mm hoch				
Streuwert	1.47, horizontal: 1.48, vertikal: 1.46				

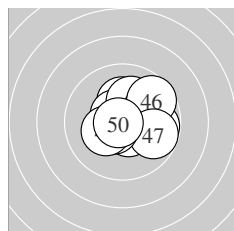

Serie 5:	10.2 *	10.6 *	10.5 *	10.1 ↑	9.8 →
	9.7 ↗	9.8 ↗	10.5 *	10.3 *	10.8 *
beste Teiler	39.6 (50.)	95.4 (42.)	104.1 (43.)		
Trefferlage	0.60 mm rechts, 0.24 mm hoch				
Streuwert	1.44, horizontal: 1.62, vertikal: 1.23				

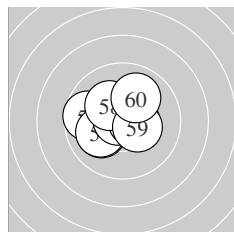

Serie 6:	10.1 ↖	10.5 *	9.7 ↖	10.1 ↖	10.4 *
	10.8 *	10.6 *	10.2 *	10.4 *	10.0 ↑
beste Teiler	42.4 (56.)	97.4 (57.)	112.1 (52.)		
Trefferlage	0.46 mm links, 0.24 mm hoch				
Streuwert	1.35, horizontal: 1.59, vertikal: 1.05				

Meyton Elektronik

ISSF AR Men – Wertung – **Männer**

StandNr: 139

Köppel, Michael #70811298

StartNr: 36

22. Januar 2019 9:49

SUI – Sportschützen Sargans

Unterschrift des Schützen

Meyton Elektronik

Ergebnis: **619.9** (593)
 Serien: 102.3 101.6 105.6 102.2 104.1 104.1
 Zähler: 53 7 0 0 0 0 0 0 0
 Innenzehner: 46
 weiteste: 455 (16), 361 (10), 359 (12)
 beste Teiler 40.1 (31.) 42.1 (28.) 47.1 (37.)
 Trefferlage 0.09 mm links, 0.45 mm hoch
 Streuwert 1.23, horizontal: 1.42, vertikal: 1.00

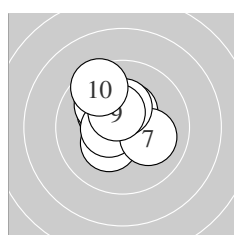
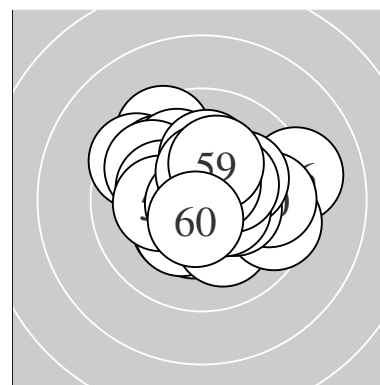

Serie 1:
 10.4 * 10.3 * 10.5 * 10.0 ↘ 10.3 *
 10.5 * 10.1 → 10.3 * 10.4 * 9.5 ↘
 beste Teiler 106.5 (6.) 111.2 (3.) 126.0 (9.)
 Trefferlage 0.53 mm links, 0.87 mm hoch
 Streuwert 1.21, horizontal: 1.15, vertikal: 1.28

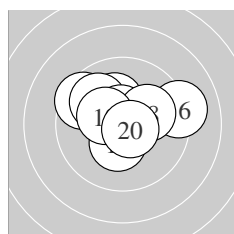

Serie 2:
 10.2 * 9.5 ↘ 9.9 ↘ 10.7 * 10.4 *
 9.1 → 10.6 * 10.1 → 10.4 * 10.7 *
 beste Teiler 68.1 (14.) 71.5 (20.) 84.1 (17.)
 Trefferlage 0.10 mm links, 0.65 mm hoch
 Streuwert 1.67, horizontal: 2.09, vertikal: 1.11

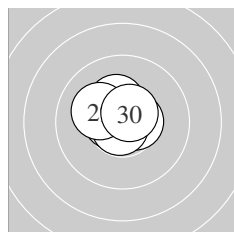

Serie 3:
 10.8 * 10.5 * 10.6 * 10.6 * 10.5 *
 10.7 * 10.3 * 10.8 * 10.2 * 10.6 *
 beste Teiler 42.1 (28.) 50.0 (21.) 73.5 (26.)
 Trefferlage 0.29 mm links, 0.55 mm hoch
 Streuwert 0.70, horizontal: 0.80, vertikal: 0.58

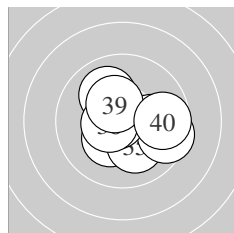

Serie 4:
 10.8 * 10.1 → 10.3 * 10.0 ↘ 10.1 ↘
 9.5 → 10.8 * 10.5 * 10.4 * 9.7 →
 beste Teiler 40.1 (31.) 47.1 (37.) 104.9 (38.)
 Trefferlage 0.50 mm rechts, 0.10 mm tief
 Streuwert 1.51, horizontal: 1.79, vertikal: 1.16

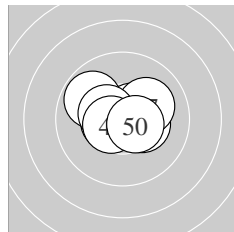

Serie 5:
 10.5 * 10.8 * 10.5 * 10.6 * 9.8 ↘
 10.3 * 10.1 → 10.4 * 10.6 * 10.5 *
 beste Teiler 50.0 (42.) 92.6 (44.) 99.2 (49.)
 Trefferlage 0.10 mm rechts, 0.22 mm hoch
 Streuwert 1.09, horizontal: 1.39, vertikal: 0.67

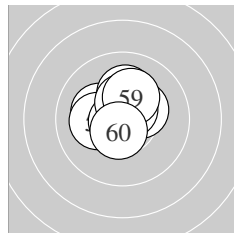

Serie 6:
 10.2 * 10.3 * 10.6 * 10.2 * 10.8 *
 10.2 * 10.6 * 10.4 * 10.2 * 10.6 *
 beste Teiler 47.9 (55.) 90.1 (53.) 92.9 (57.)
 Trefferlage 0.24 mm links, 0.53 mm hoch
 Streuwert 1.01, horizontal: 1.05, vertikal: 0.96

Meyton Elektronik

ISSF AR Men – Wertung – **Männer**

StandNr: 140

Cipro, Adam #70811305

StartNr: 37

22. Januar 2019 9:49

CZE

Unterschrift des Schützen

Meyton Elektronik

Ergebnis: **624.3** (599)
 Serien: 102.7 104.7 102.9 103.5 105.4 105.1
 Zähler: 59 1 0 0 0 0 0 0 0
 Innenzehner: 47
 weiteste: 266 (27), 245 (38), 241 (21)
 beste Teiler 15.1 (54.) 32.1 (15.) 40.1 (46.)
 Trefferlage 0.14 mm rechts, 0.31 mm hoch
 Streuwert 1.04, horizontal: 1.17, vertikal: 0.89

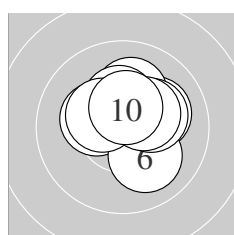
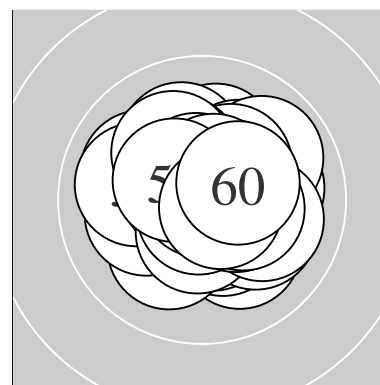

Serie 1:
 10.4 * 10.1 ↗ 10.1 ↑ 10.3 * 10.3 *
 10.1 ↘ 10.2 * 10.3 * 10.4 * 10.5 *
 beste Teiler 120.5 (10.) 130.4 (1.) 142.1 (9.)
 Trefferlage 0.41 mm rechts, 0.78 mm hoch
 Streuwert 1.10, horizontal: 1.19, vertikal: 0.99

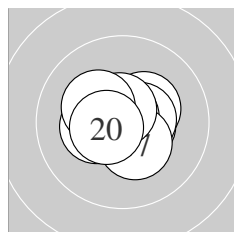

Serie 2:
 10.4 * 10.3 * 10.6 * 10.5 * 10.8 *
 10.3 * 10.4 * 10.6 * 10.3 * 10.5 *
 beste Teiler 32.1 (15.) 77.1 (18.) 100.2 (13.)
 Trefferlage 0.15 mm links, 0.14 mm hoch
 Streuwert 0.93, horizontal: 1.13, vertikal: 0.67

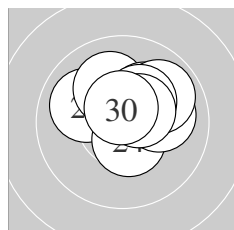

Serie 3:
 10.0 ↖ 10.7 * 10.1 ↘ 10.5 * 10.1 →
 10.2 * 9.9 ↗ 10.3 * 10.5 * 10.6 *
 beste Teiler 75.2 (22.) 87.4 (30.) 112.6 (24.)
 Trefferlage 0.56 mm rechts, 0.86 mm hoch
 Streuwert 1.12, horizontal: 1.34, vertikal: 0.84

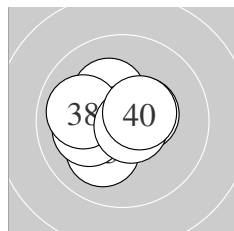

Serie 4:
 10.5 * 10.3 * 10.1 ↙ 10.8 * 10.3 *
 10.1 ← 10.2 * 10.0 ← 10.7 * 10.5 *
 beste Teiler 48.3 (34.) 59.6 (39.) 114.4 (40.)
 Trefferlage 0.60 mm links, 0.04 mm hoch
 Streuwert 1.12, horizontal: 1.30, vertikal: 0.92

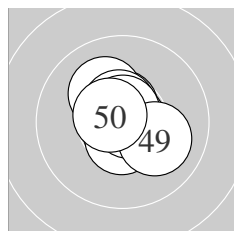

Serie 5:
 10.6 * 10.6 * 10.7 * 10.1 ↘ 10.6 *
 10.8 * 10.6 * 10.7 * 10.1 ↙ 10.6 *
 beste Teiler 40.1 (46.) 52.5 (43.) 60.0 (48.)
 Trefferlage 0.06 mm rechts, 0.15 mm hoch
 Streuwert 0.87, horizontal: 0.83, vertikal: 0.92

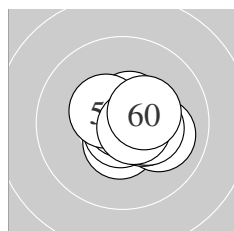

Serie 6:
 10.5 * 10.8 * 10.6 * 10.9 * 10.5 *
 10.0 → 10.4 * 10.3 * 10.7 * 10.4 *
 beste Teiler 15.1 (54.) 48.7 (52.) 73.1 (59.)
 Trefferlage 0.59 mm rechts, 0.09 mm tief
 Streuwert 0.83, horizontal: 0.96, vertikal: 0.67

Meyton Elektronik

ISSF AR Men – Wertung – **Männer**

StandNr: 141

Matsumoto, Takayuki #70811315

StartNr: 38

22. Januar 2019 9:50

JPN

Unterschrift des Schützen

Meyton Elektronik

Ergebnis: **622.7** (593)
 Serien: 102.5 103.8 103.4 105.6 103.9 103.5
 Zähler: 53 7 0 0 0 0 0 0 0
 Innenzehner: 51
 weiteste: 375 (1), 364 (49), 323 (24)
 beste Teiler 9.0 (12.) 10.7 (46.) 16.1 (56.)
 Trefferlage 0.10 mm links, 0.17 mm tief
 Streuwert 1.16, horizontal: 1.34, vertikal: 0.94

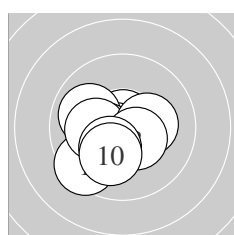
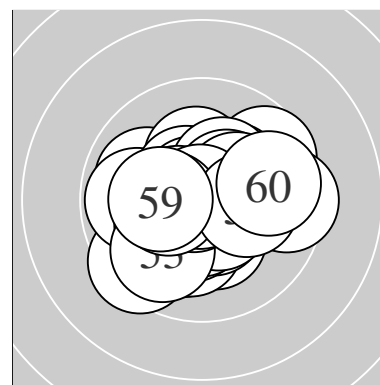

Serie 1:
 9.5 ↙ 10.8 * 10.7 * 9.9 ↖ 10.4 *
 10.2 * 10.2 * 10.4 * 10.3 * 10.1 ↘
 beste Teiler 44.1 (2.) 65.9 (3.) 126.2 (8.)
 Trefferlage 0.76 mm links, 0.65 mm tief
 Streuwert 1.26, horizontal: 1.41, vertikal: 1.10

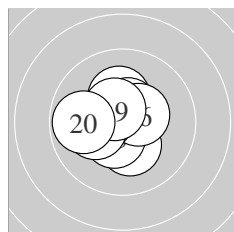

Serie 2:
 10.3 * 10.9 * 10.5 * 10.2 * 10.5 *
 10.5 * 10.4 * 10.2 * 10.5 * 9.8 ←
 beste Teiler 9.0 (12.) 101.0 (15.) 108.7 (19.)
 Trefferlage 0.56 mm links, 0.13 mm hoch
 Streuwert 1.11, horizontal: 1.21, vertikal: 1.00

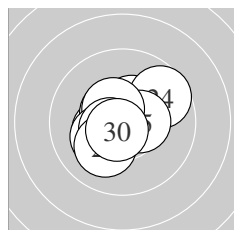

Serie 3:
 10.3 * 10.5 * 10.4 * 9.7 ↗ 10.5 *
 10.5 * 10.2 * 10.5 * 10.1 ↘ 10.7 *
 beste Teiler 69.4 (30.) 103.8 (28.) 106.8 (22.)
 Trefferlage 0.24 mm links, 0.01 mm hoch
 Streuwert 1.23, horizontal: 1.35, vertikal: 1.09

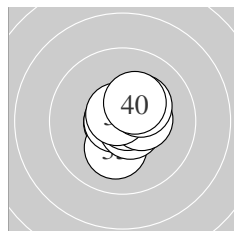

Serie 4:
 10.7 * 10.8 * 10.2 * 10.7 * 10.7 *
 10.8 * 10.4 * 10.7 * 10.3 * 10.3 *
 beste Teiler 37.6 (36.) 45.3 (32.) 53.0 (34.)
 Trefferlage 0.20 mm rechts, 0.05 mm hoch
 Streuwert 0.84, horizontal: 0.78, vertikal: 0.89

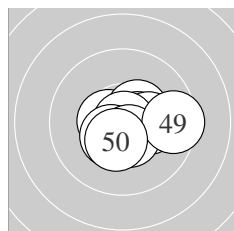

Serie 5:
 10.5 * 10.6 * 10.4 * 10.5 * 10.2 *
 10.9 * 10.4 * 10.5 * 9.5 → 10.4 *
 beste Teiler 10.7 (46.) 78.1 (42.) 103.3 (41.)
 Trefferlage 0.59 mm rechts, 0.34 mm tief
 Streuwert 1.09, horizontal: 1.40, vertikal: 0.64

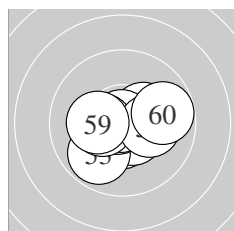

Serie 6:
 10.5 * 10.5 * 9.9 ↙ 10.8 * 10.3 *
 10.9 * 10.4 * 10.2 * 10.2 * 9.8 →
 beste Teiler 16.1 (56.) 36.0 (54.) 106.2 (52.)
 Trefferlage 0.15 mm rechts, 0.28 mm tief
 Streuwert 1.28, horizontal: 1.59, vertikal: 0.86

ISSF AR Men – Wertung – **Männer**

StandNr: 142

Hrckulak, David #226

StartNr: 39

22. Januar 2019 9:56

CZE

Unterschrift des Schützen

Meyton Elektronik

Ergebnis:	624.1	(595)					
Serien:	104.2	103.5	103.8	104.7	103.6	104.3	
Zähler:	55	5	0	0	0	0	0
Innenzehner:	52						
weiteste:	367 (57), 322 (47), 298 (12)						
beste Teiler	28.4 (7.) 47.1 (1.) 47.8 (54.)						
Trefferlage	0.27 mm links, 0.13 mm hoch						
Streuwert	1.08, horizontal: 1.11, vertikal: 1.04						

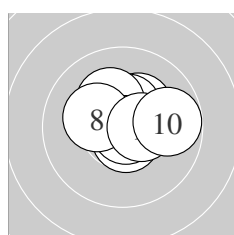
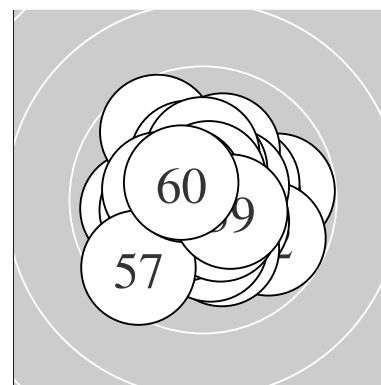

Serie 1:	10.8 *	10.5 *	10.3 *	10.4 *	10.2 *
	10.7 *	10.8 *	10.2 *	10.5 *	9.8 →
beste Teiler	28.4 (7.) 47.1 (1.) 75.2 (6.)				
Trefferlage	0.29 mm rechts, 0.46 mm hoch				
Streuwert	1.06, horizontal: 1.27, vertikal: 0.79				

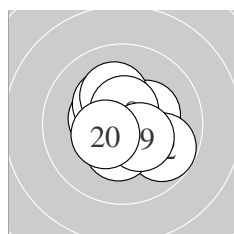

Serie 2:	10.3 *	9.8 ↘	10.4 *	10.7 *	10.3 *
	10.4 *	10.2 *	10.6 *	10.4 *	10.4 *
beste Teiler	73.8 (14.) 92.6 (18.) 131.3 (20.)				
Trefferlage	0.13 mm rechts, 0.01 mm tief				
Streuwert	1.23, horizontal: 1.28, vertikal: 1.18				

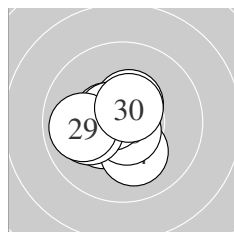

Serie 3:	10.5 *	10.4 *	10.4 *	10.1 ↘	10.6 *
	10.7 *	10.6 *	10.1 ←	9.9 ←	10.5 *
beste Teiler	63.5 (26.) 80.2 (25.) 85.4 (27.)				
Trefferlage	0.67 mm links, 0.15 mm tief				
Streuwert	1.03, horizontal: 1.14, vertikal: 0.91				

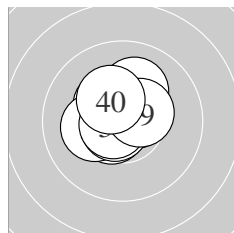

Serie 4:	10.4 *	10.1 ↗	10.6 *	10.6 *	10.6 *
	10.2 *	10.7 *	10.7 *	10.5 *	10.3 *
beste Teiler	63.4 (37.) 64.8 (38.) 85.0 (34.)				
Trefferlage	0.35 mm links, 0.34 mm hoch				
Streuwert	0.91, horizontal: 0.94, vertikal: 0.87				

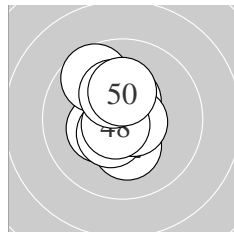

Serie 5:	10.6 *	10.2 *	10.5 *	10.3 *	10.5 *
	10.7 *	9.7 ↘	10.7 *	10.2 *	10.2 *
beste Teiler	59.0 (48.) 72.8 (46.) 76.5 (41.)				
Trefferlage	0.45 mm links, 0.31 mm hoch				
Streuwert	1.15, horizontal: 0.79, vertikal: 1.41				

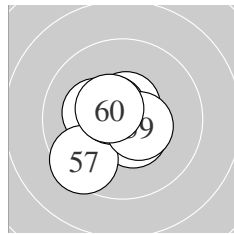

Serie 6:	10.6 *	10.7 *	10.4 *	10.8 *	10.2 *
	10.5 *	9.5 ↙	10.6 *	10.5 *	10.5 *
beste Teiler	47.8 (54.) 61.0 (52.) 88.0 (51.)				
Trefferlage	0.58 mm links, 0.14 mm tief				
Streuwert	1.08, horizontal: 1.09, vertikal: 1.06				

ISSF AR Men – Wertung – Männer

StandNr: 143

Baudouin, Brian #70811304

StartNr: 40

22. Januar 2019 9:52

FRA

Unterschrift des Schützen

Meyton Elektronik

Ergebnis: **616.6** (593)
 Serien: 103.3 102.8 101.9 103.3 104.0 101.3
 Zähler: 53 7 0 0 0 0 0 0 0
 Innenzehner: 43
 weiteste: 349 (21), 316 (30), 316 (55)
 beste Teiler 39.0 (34.) 52.0 (52.) 64.2 (48.)
 Trefferlage 0.01 mm links, 0.05 mm hoch
 Streuwert 1.32, horizontal: 1.34, vertikal: 1.29

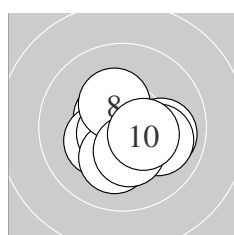
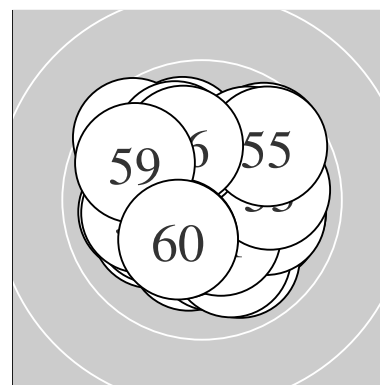

Serie 1:
 10.6 * 10.5 * 10.0 → 10.3 * 10.0 →
 10.7 * 10.2 * 10.3 * 10.3 * 10.4 *
 beste Teiler 74.9 (6.) 96.8 (1.) 104.8 (2.)
 Trefferlage 0.28 mm rechts, 0.50 mm tief
 Streuwert 1.15, horizontal: 1.32, vertikal: 0.97

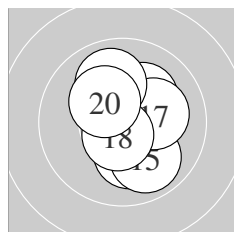

Serie 2:
 10.4 * 10.6 * 10.4 * 10.2 * 9.9 ↓
 10.2 * 10.2 * 10.6 * 10.0 ↑ 10.3 *
 beste Teiler 85.4 (18.) 95.5 (12.) 140.8 (13.)
 Trefferlage 0.57 mm rechts, 0.07 mm tief
 Streuwert 1.29, horizontal: 1.01, vertikal: 1.51

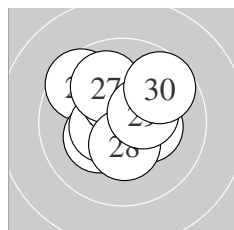

Serie 3:
 9.6 ↘ 10.3 * 10.3 * 10.3 * 10.5 *
 10.4 * 10.0 ↘ 10.4 * 10.4 * 9.7 ↗
 beste Teiler 114.9 (25.) 140.1 (29.) 141.5 (28.)
 Trefferlage 0.16 mm links, 0.73 mm hoch
 Streuwert 1.45, horizontal: 1.51, vertikal: 1.39

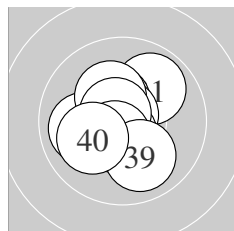

Serie 4:
 9.9 ↗ 10.0 ← 10.4 * 10.8 * 10.6 *
 10.3 * 10.7 * 10.5 * 10.0 ↓ 10.1 ←
 beste Teiler 39.0 (34.) 65.7 (37.) 83.3 (35.)
 Trefferlage 0.37 mm links, 0.01 mm hoch
 Streuwert 1.27, horizontal: 1.22, vertikal: 1.33

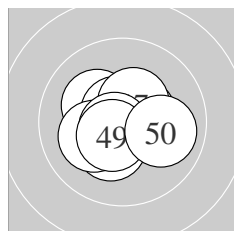

Serie 5:
 10.2 * 10.5 * 10.5 * 10.7 * 10.3 *
 10.2 * 10.4 * 10.7 * 10.5 * 10.0 →
 beste Teiler 64.2 (48.) 72.7 (44.) 106.2 (49.)
 Trefferlage 0.20 mm links, 0.19 mm tief
 Streuwert 1.11, horizontal: 1.26, vertikal: 0.94

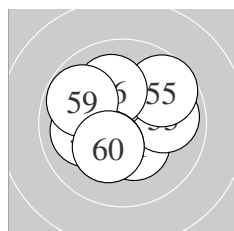

Serie 6:
 10.3 * 10.7 * 9.9 → 10.2 * 9.7 ↗
 10.1 ↘ 10.3 * 10.0 ← 9.8 ↘ 10.3 *
 beste Teiler 52.0 (52.) 152.5 (51.) 171.1 (57.)
 Trefferlage 0.22 mm links, 0.34 mm hoch
 Streuwert 1.60, horizontal: 1.72, vertikal: 1.46

ISSF AR Men – Wertung – **Männer**

StandNr: 144

Lohbihler, Jan #70811307

StartNr: 41

22. Januar 2019 9:52

SUI

Unterschrift des Schützen

Meyton Elektronik

Ergebnis: **623.3** (594)
 Serien: 105.0 104.8 104.9 103.5 101.1 104.0
 Zähler: 54 6 0 0 0 0 0 0 0
 Innenzehner: 48
 weiteste: 369 (44), 333 (56), 282 (43)
 beste Teiler 18.0 (20.) 22.0 (16.) 28.3 (14.)
 Trefferlage 0.16 mm links, 0.10 mm tief
 Streuwert 1.14, horizontal: 1.26, vertikal: 1.02

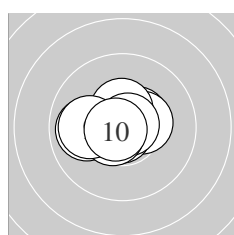
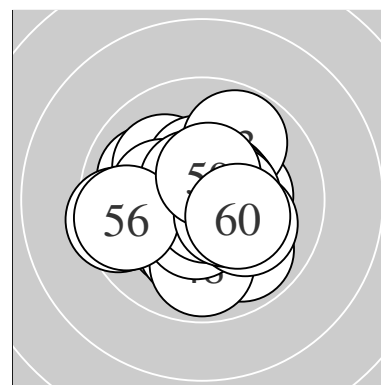

Serie 1:
 9.9 ← 10.8 * 10.5 * 10.4 * 10.5 *
 10.8 * 10.8 * 10.6 * 10.0 ← 10.7 *
 beste Teiler 35.4 (6.) 41.5 (7.) 47.1 (2.)
 Trefferlage 0.35 mm links, 0.17 mm hoch
 Streuwert 0.97, horizontal: 1.27, vertikal: 0.52

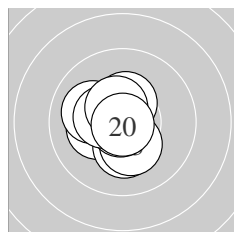

Serie 2:
 10.2 * 10.3 * 10.3 * 10.8 * 10.1 ↗
 10.9 * 10.4 * 10.4 * 10.5 * 10.9 *
 beste Teiler 18.0 (20.) 22.0 (16.) 28.3 (14.)
 Trefferlage 0.51 mm links, 0.06 mm tief
 Streuwert 0.97, horizontal: 0.91, vertikal: 1.02

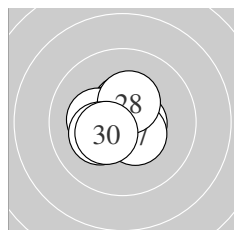

Serie 3:
 10.5 * 10.6 * 10.8 * 10.6 * 10.2 *
 10.7 * 10.5 * 10.4 * 10.2 * 10.4 *
 beste Teiler 33.8 (23.) 68.0 (26.) 86.3 (22.)
 Trefferlage 0.23 mm links, 0.13 mm hoch
 Streuwert 0.91, horizontal: 1.01, vertikal: 0.79

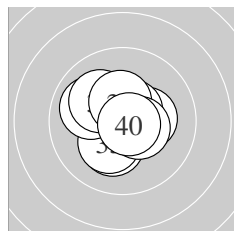

Serie 4:
 10.2 * 10.5 * 10.2 * 10.3 * 10.6 *
 10.0 ↖ 10.1 ↖ 10.4 * 10.5 * 10.7 *
 beste Teiler 51.4 (40.) 95.7 (35.) 104.3 (32.)
 Trefferlage 0.25 mm links, 0.14 mm hoch
 Streuwert 1.17, horizontal: 1.24, vertikal: 1.10

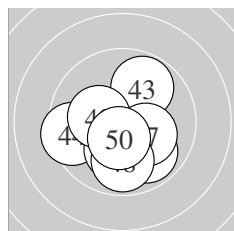

Serie 5:
 10.6 * 10.3 * 9.8 ↗ 9.5 ← 10.1 ↓
 9.9 ↘ 10.2 * 9.9 ↓ 10.3 * 10.5 *
 beste Teiler 92.2 (41.) 117.9 (50.) 172.7 (49.)
 Trefferlage 0.02 mm links, 0.93 mm tief
 Streuwert 1.56, horizontal: 1.64, vertikal: 1.47

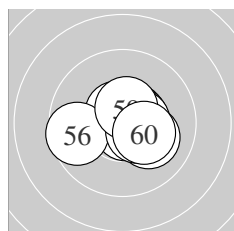

Serie 6:
 10.6 * 10.8 * 10.6 * 10.1 ↘ 10.5 *
 9.6 ← 10.5 * 10.5 * 10.5 * 10.3 *
 beste Teiler 49.6 (52.) 85.5 (51.) 96.8 (53.)
 Trefferlage 0.41 mm rechts, 0.07 mm tief
 Streuwert 1.14, horizontal: 1.45, vertikal: 0.73

Meyton Elektronik

ISSF AR Men – Wertung – Männer

StandNr: 145

Shimada, Atsushi #70811301

StartNr: 42

22. Januar 2019 10:01

Japan

Unterschrift des Schützen

Meyton Elektronik

Ergebnis:	598.2	(571)
Serien:	98.3	101.1 100.2 98.6 99.8 100.2
Zähler:	34	23 3 0 0 0 0 0 0 0
Innenzehner:	21	
weiteste:	579	(49), 542 (54), 505 (5)
beste Teiler	6.3	(44.) 34.4 (14.) 41.2 (26.)
Trefferlage	0.42 mm	rechts, 0.27 mm hoch
Streuwert	1.93,	horizontal: 2.26, vertikal: 1.54

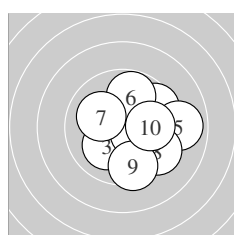
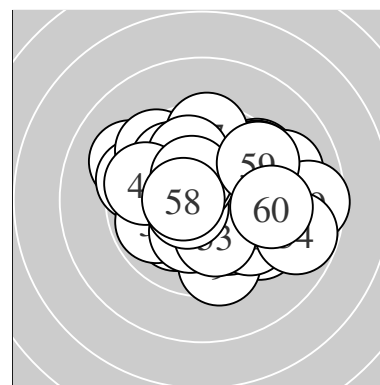

Serie 1:	9.6 ↗	10.5 *	10.1 ↙	10.5 *	8.9 →
	9.8 ↑	10.1 ↖	9.4 ↘	9.5 ↓	9.9 →
beste Teiler	110.6	(2.) 124.3 (4.)	215.4 (3.)		
Trefferlage	1.21 mm	rechts, 0.13 mm	tief		
Streuwert	2.06,	horizontal: 2.22,	vertikal: 1.88		

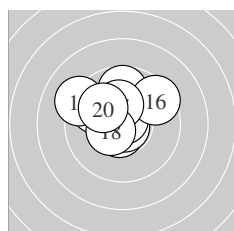

Serie 2:	9.7 ↑	10.6 *	9.8 ↖	10.8 *	10.8 *
	9.5 ↗	10.2 *	10.5 *	9.2 ↖	10.0 ↖
beste Teiler	34.4	(14.) 41.9 (15.)	83.2 (12.)		
Trefferlage	0.65 mm	links, 1.07 mm	hoch		
Streuwert	1.60,	horizontal: 1.84,	vertikal: 1.31		

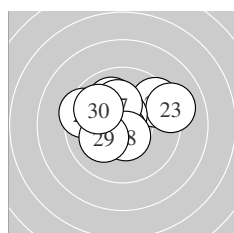

Serie 3:	9.5 ↗	9.5 ↖	9.1 ↗	10.0 ↖	10.6 *
	10.8 *	10.2 *	10.5 *	10.1 ↙	9.9 ↖
beste Teiler	41.2	(26.) 89.0 (25.)	103.1 (28.)		
Trefferlage	0.14 mm	links, 0.85 mm	hoch		
Streuwert	1.87,	horizontal: 2.34,	vertikal: 1.24		

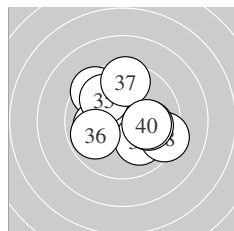

Serie 4:	9.5 ↖	10.0 ←	10.4 *	10.0 ↘	9.9 ↖
	9.9 ←	9.5 ↑	9.3 ↘	10.0 →	10.1 →
beste Teiler	128.6	(33.) 220.0 (40.)	227.3 (32.)		
Trefferlage	0.00 mm	, 0.29 mm	hoch		
Streuwert	2.10,	horizontal: 2.33,	vertikal: 1.83		

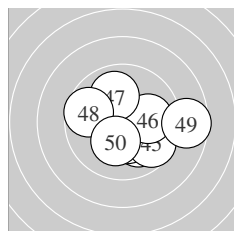

Serie 5:	10.0 ↘	10.3 *	10.4 *	10.9 *	9.7 ↘
	10.0 →	10.0 ↖	9.7 ↖	8.6 →	10.2 *
beste Teiler	6.3	(44.) 127.2 (43.)	158.9 (42.)		
Trefferlage	0.76 mm	rechts, 0.46 mm	tief		
Streuwert	1.98,	horizontal: 2.42,	vertikal: 1.40		

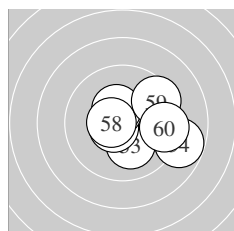

Serie 6:	10.5 *	9.9 →	10.1 ↓	8.8 →	10.6 *
	10.5 *	10.4 *	10.5 *	9.5 ↗	9.4 →
beste Teiler	89.8	(55.) 102.0 (58.)	114.0 (56.)		
Trefferlage	1.34 mm	rechts, 0.03 mm	hoch		
Streuwert	1.77,	horizontal: 2.16,	vertikal: 1.25		

ISSF AR Men – Wertung – Männer

StandNr: 146

Heidegger, Daniel #312

StartNr: 43

22. Januar 2019 10:01

Wien

Unterschrift des Schützen

Meyton Elektronik

Ergebnis:	566.5	(540)
Serien:	91.4 93.3 98.2 93.8 96.1 93.7	
Zähler:	20 25 10 5 0 0 0 0 0 0	
Innenzehner:	16	
weiteste:	890 (58), 875 (12), 844 (3)	
beste Teiler	12.1 (27.) 89.0 (43.) 99.4 (22.)	
Trefferlage	1.34 mm rechts, 0.16 mm tief	
Streuwert	2.99, horizontal: 2.85, vertikal: 3.12	

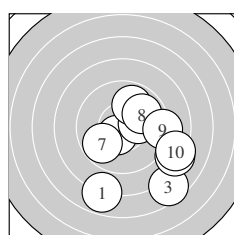
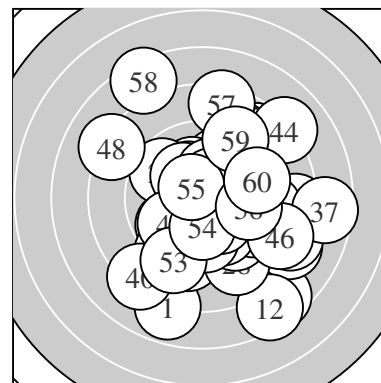

Serie 1:	7.9 ↓	10.5 *	7.6 ↘	8.2 ↘	10.2 *
	9.9 ↑	9.8 ↙	9.9 ↗	9.1 →	8.3 ↘
beste Teiler	108.7 (2.) 179.2 (5.) 266.5 (8.)				
Trefferlage	2.13 mm rechts, 1.85 mm tief				
Streuwert	3.23, horizontal: 3.21, vertikal: 3.25				

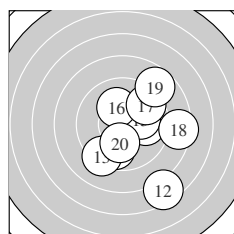

Serie 2:	9.7 ↓	7.5 ↘	9.2 ↙	9.9 →	10.1 →
	10.1 ↖	9.6 ↗	8.4 →	8.7 ↗	10.1 ↓
beste Teiler	201.8 (16.) 211.9 (15.) 213.4 (20.)				
Trefferlage	1.77 mm rechts, 0.80 mm tief				
Streuwert	3.07, horizontal: 2.76, vertikal: 3.36				

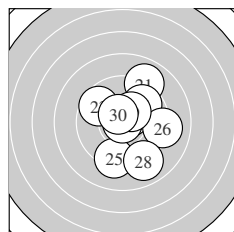

Serie 3:	9.0 ↑	10.6 *	9.7 ↘	9.8 ↗	9.3 ↓
	9.1 →	10.9 *	9.0 ↘	10.3 *	10.5 *
beste Teiler	12.1 (27.) 99.4 (22.) 101.2 (30.)				
Trefferlage	0.91 mm rechts, 0.15 mm hoch				
Streuwert	2.40, horizontal: 2.07, vertikal: 2.68				

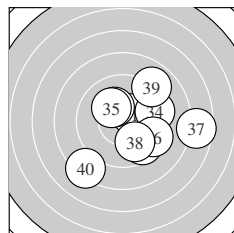

Serie 4:	10.5 *	10.2 *	9.5 ↘	9.4 →	10.2 *
	9.4 ↘	7.6 →	9.9 ↘	8.9 ↗	8.2 ↙
beste Teiler	122.3 (31.) 183.6 (32.) 197.3 (35.)				
Trefferlage	1.68 mm rechts, 0.41 mm tief				
Streuwert	3.08, horizontal: 3.42, vertikal: 2.69				

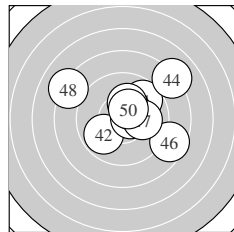

Serie 5:	9.7 ↗	9.9 ↙	10.6 *	8.1 ↗	10.4 *
	8.6 ↘	10.1 →	8.1 ↘	10.2 *	10.4 *
beste Teiler	89.0 (43.) 131.2 (50.) 138.4 (45.)				
Trefferlage	1.00 mm rechts, 0.98 mm hoch				
Streuwert	2.87, horizontal: 3.40, vertikal: 2.20				

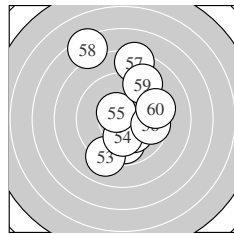

Serie 6:	9.8 ↓	10.2 *	9.1 ↓	10.2 *	10.5 *
	9.7 →	8.3 ↑	7.4 ↘	9.1 ↑	9.4 →
beste Teiler	103.2 (55.) 197.0 (54.) 198.8 (52.)				
Trefferlage	0.53 mm rechts, 0.91 mm hoch				
Streuwert	3.31, horizontal: 2.35, vertikal: 4.04				

Meyton Elektronik

ISSF AR Men – Wertung – **Männer**

StandNr: 147

Prakash, Nitesh #70811296

StartNr: 44

22. Januar 2019 9:28

IND

Unterschrift des Schützen

Meyton Elektronik

Ergebnis:	596.2	(566)
Serien:	98.1 98.0 98.7 103.0 99.1 99.3	
Zähler:	30 27 2 1 0 0 0 0 0 0	
Innenzehner:	27	
weiteste:	767 (19), 541 (55), 508 (6)	
beste Teiler	30.0 (34.) 34.7 (22.) 55.1 (17.)	
Trefferlage	0.22 mm links, 0.50 mm hoch	
Streuwert	2.03, horizontal: 2.15, vertikal: 1.90	

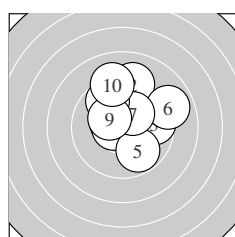
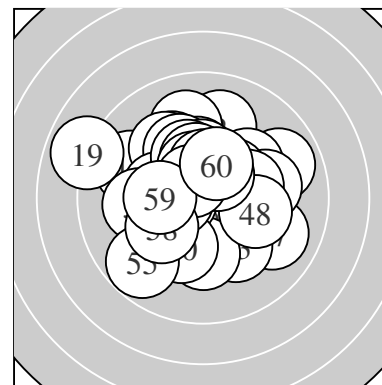

Serie 1:	10.5 *	9.1 ↑	9.7 →	10.6 *	9.8 ↘
	8.9 ↗	10.3 *	9.7 ↘	10.3 *	9.2 ↑
beste Teiler	92.7 (4.)	124.2 (1.)	161.7 (9.)		
Trefferlage	0.55 mm rechts, 1.42 mm hoch				
Streuwert	2.10, horizontal: 2.14, vertikal: 2.06				

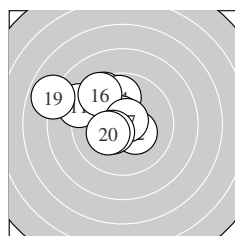

Serie 2:	9.0 ↖	10.3 *	9.5 ↘	9.8 ↑	10.7 *
	9.4 ↘	10.7 *	10.4 *	7.9 ↖	10.3 *
beste Teiler	55.1 (17.)	71.1 (15.)	130.8 (18.)		
Trefferlage	1.72 mm links, 1.20 mm hoch				
Streuwert	2.13, horizontal: 2.49, vertikal: 1.70				

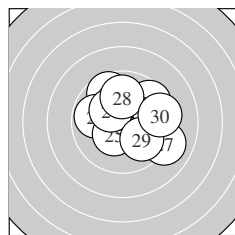

Serie 3:	9.6 ↘	10.8 *	9.8 ↖	9.6 ↗	10.4 *
	10.3 *	9.0 ↘	9.9 ↑	9.9 ↘	9.4 →
beste Teiler	34.7 (22.)	149.2 (25.)	171.8 (26.)		
Trefferlage	0.68 mm rechts, 0.50 mm hoch				
Streuwert	2.11, horizontal: 2.39, vertikal: 1.78				

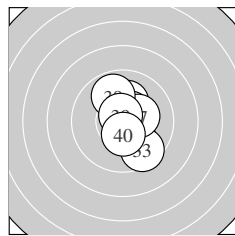

Serie 4:	10.5 *	10.2 *	9.5 ↘	10.8 *	10.2 *
	10.5 *	10.3 *	9.9 ↘	10.7 *	10.4 *
beste Teiler	30.0 (34.)	63.5 (39.)	113.2 (36.)		
Trefferlage	0.51 mm rechts, 0.18 mm hoch				
Streuwert	1.35, horizontal: 0.88, vertikal: 1.68				

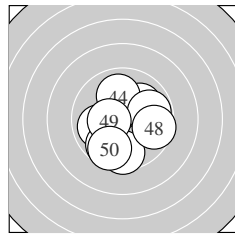

Serie 5:	10.0 ↗	9.9 ↖	10.5 *	10.0 ↑	9.7 ↘
	9.8 →	9.6 ↓	9.6 →	10.4 *	9.6 ↘
beste Teiler	114.9 (43.)	139.0 (49.)	228.1 (41.)		
Trefferlage	0.02 mm rechts, 0.52 mm tief				
Streuwert	1.95, horizontal: 1.92, vertikal: 1.99				

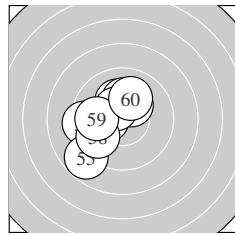

Serie 6:	10.3 *	10.3 *	9.4 ↖	10.2 *	8.8 ↘
	10.2 *	10.5 *	9.7 ↗	9.9 ↖	10.0 ↑
beste Teiler	125.0 (57.)	158.2 (51.)	169.8 (52.)		
Trefferlage	1.39 mm links, 0.22 mm hoch				
Streuwert	1.85, horizontal: 1.78, vertikal: 1.92				

Meyton Elektronik

ISSF AR Men – Wertung – Männer

StandNr: 119

Mattle, Michael #221

StartNr: 62

22. Januar 2019 11:53

VLSV

Unterschrift des Schützen

Meyton Elektronik

Ergebnis: **625.0** (597)

Serien: 103.6 104.6 104.0 103.8 104.9 104.1

Zähler: 57 3 0 0 0 0 0 0 0 0

Innenzehner: 49

weiteste: 317 (36), 260 (10), 251 (20)

beste Teiler 23.7 (51.) 34.0 (28.) 40.3 (26.)

Trefferlage 0.44 mm links, 0.19 mm hoch

Streuwert 1.01, horizontal: 0.97, vertikal: 1.05

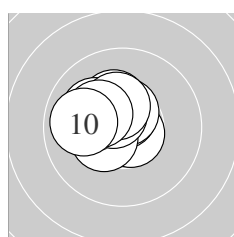
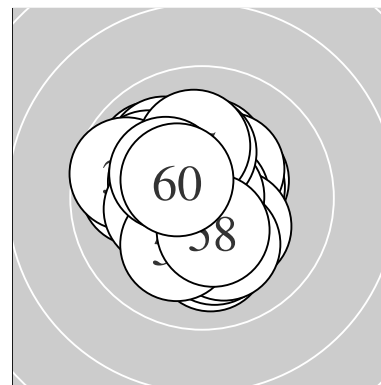

Serie 1:

10.7 *	10.3 *	10.6 *	10.5 *	10.4 *
10.1 ↖	10.5 *	10.4 *	10.2 *	9.9 ←

beste Teiler 68.4 (1.) 81.0 (3.) 101.2 (4.)

Trefferlage 0.81 mm links, 0.67 mm hoch

Streuwert 0.87, horizontal: 0.98, vertikal: 0.73

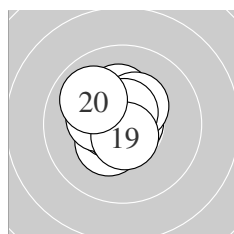

Serie 2:

10.4 *	10.6 *	10.8 *	10.8 *	10.3 *
10.2 *	10.4 *	10.6 *	10.6 *	9.9 ↗

beste Teiler 42.7 (14.) 47.8 (13.) 78.7 (18.)

Trefferlage 0.40 mm links, 0.34 mm hoch

Streuwert 0.94, horizontal: 0.88, vertikal: 0.99

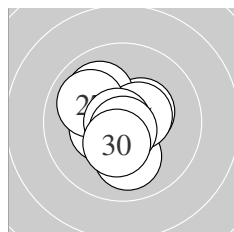

Serie 3:

10.0 ↓	10.4 *	10.4 *	10.0 ↖	10.5 *
10.8 *	10.0 ↖	10.8 *	10.7 *	10.4 *

beste Teiler 34.0 (28.) 40.3 (26.) 53.0 (29.)

Trefferlage 0.34 mm links, 0.05 mm tief

Streuwert 1.14, horizontal: 1.07, vertikal: 1.20

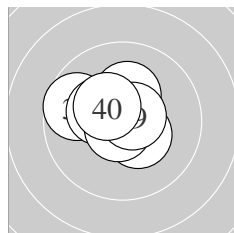

Serie 4:

10.3 *	10.6 *	10.3 *	10.4 *	10.4 *
9.7 ↖	10.3 *	10.7 *	10.7 *	10.4 *

beste Teiler 54.0 (38.) 72.8 (39.) 76.2 (32.)

Trefferlage 0.71 mm links, 0.51 mm hoch

Streuwert 1.00, horizontal: 1.20, vertikal: 0.74

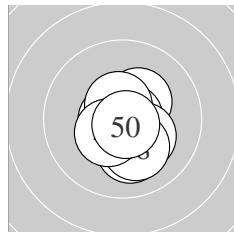

Serie 5:

10.8 *	10.3 *	10.8 *	10.1 ↓	10.7 *
10.6 *	10.3 *	10.1 ↓	10.4 *	10.8 *

beste Teiler 42.5 (50.) 42.9 (41.) 43.7 (43.)

Trefferlage 0.25 mm rechts, 0.45 mm tief

Streuwert 0.91, horizontal: 0.74, vertikal: 1.05

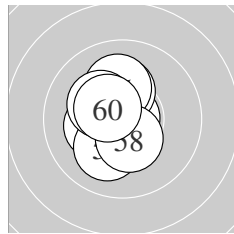

Serie 6:

10.9 *	10.3 *	10.7 *	10.2 *	10.1 ↑
10.6 *	10.1 ↙	10.4 *	10.3 *	10.5 *

beste Teiler 23.7 (51.) 71.5 (53.) 96.8 (56.)

Trefferlage 0.62 mm links, 0.14 mm hoch

Streuwert 1.03, horizontal: 0.69, vertikal: 1.28

Meyton Elektronik

ISSF AR Men – Wertung – Männer

StandNr: 121

Piasecki, Pierre-Edmond #70811297

StartNr: 63

22. Januar 2019 11:43

FRA

Unterschrift des Schützen

Meyton Elektronik

Ergebnis: **621.6** (594)
 Serien: 102.9 103.6 103.2 103.7 105.3 102.9
 Zähler: 55 4 1 0 0 0 0 0 0
 Innenzehner: 47
 weiteste: 517 (60), 264 (4), 264 (24)
 beste Teiler 5.8 (39.) 39.2 (49.) 40.7 (45.)
 Trefferlage 0.32 mm rechts, 0.01 mm tief
 Streuwert 1.18, horizontal: 1.15, vertikal: 1.22

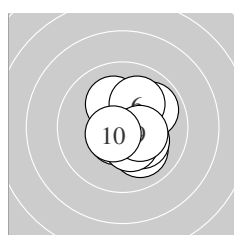
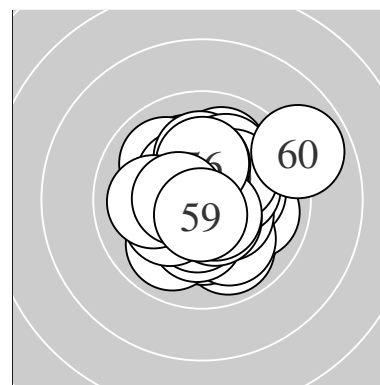

Serie 1:
 10.2 * 10.0 ↘ 10.6 * 9.9 ↗ 10.5 *
 10.1 ↗ 10.2 * 10.4 * 10.4 * 10.6 *
 beste Teiler 92.6 (3.) 93.2 (10.) 122.3 (5.)
 Trefferlage 0.72 mm rechts, 0.18 mm tief
 Streuwert 1.21, horizontal: 1.05, vertikal: 1.36

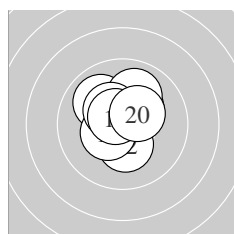

Serie 2:
 10.0 ↘ 10.3 * 10.5 * 10.3 * 10.7 *
 10.4 * 10.0 ↗ 10.4 * 10.6 * 10.4 *
 beste Teiler 51.8 (15.) 83.4 (19.) 112.2 (13.)
 Trefferlage 0.19 mm links, 0.69 mm hoch
 Streuwert 1.07, horizontal: 1.01, vertikal: 1.12

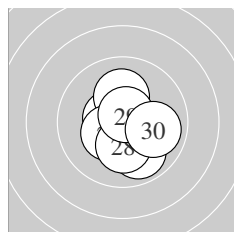

Serie 3:
 10.6 * 10.4 * 10.5 * 9.9 ↘ 10.1 ↑
 10.5 * 10.4 * 10.2 * 10.7 * 9.9 →
 beste Teiler 65.7 (29.) 97.8 (21.) 102.1 (23.)
 Trefferlage 0.29 mm rechts, 0.37 mm tief
 Streuwert 1.21, horizontal: 1.07, vertikal: 1.33

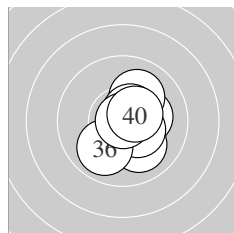

Serie 4:
 10.2 * 10.7 * 10.4 * 10.0 ↘ 10.4 *
 9.9 ↗ 10.1 ↗ 10.6 * 10.9 * 10.5 *
 beste Teiler 5.8 (39.) 58.1 (32.) 96.5 (38.)
 Trefferlage 0.61 mm rechts, 0.20 mm tief
 Streuwert 1.11, horizontal: 0.91, vertikal: 1.27

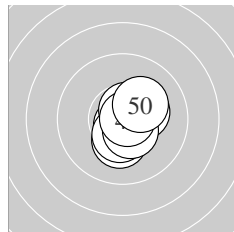

Serie 5:
 10.6 * 10.3 * 10.8 * 10.3 * 10.8 *
 10.4 * 10.5 * 10.6 * 10.8 * 10.2 *
 beste Teiler 39.2 (49.) 40.7 (45.) 48.8 (43.)
 Trefferlage 0.45 mm rechts, 0.26 mm tief
 Streuwert 0.79, horizontal: 0.62, vertikal: 0.93

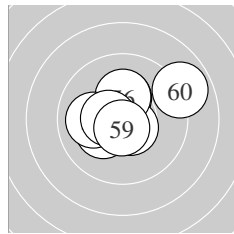

Serie 6:
 10.3 * 10.7 * 10.8 * 10.6 * 10.2 *
 10.2 * 10.0 ← 10.5 * 10.7 * 8.9 →
 beste Teiler 47.0 (53.) 56.0 (52.) 72.3 (59.)
 Trefferlage 0.02 mm rechts, 0.23 mm hoch
 Streuwert 1.57, horizontal: 1.85, vertikal: 1.21

Meyton Elektronik

ISSF AR Men – Wertung – Männer

StandNr: 122

Eberlberger, Florian #308

StartNr: 64

22. Januar 2019 11:53

OÖ – Bad Goisern

Unterschrift des Schützen

Meyton Elektronik

Ergebnis:	615.6	(590)						
Serien:	102.6	103.1	102.5	104.0	102.2	101.2		
Zähler:	50	10	0	0	0	0	0	0
Innenzehner:	42							
weiteste:	450 (28), 388 (17), 355 (49)							
beste Teiler	9.0 (43.) 43.0 (16.) 48.3 (6.)							
Trefferlage	0.20 mm rechts, 0.27 mm hoch							
Streuwert	1.36, horizontal: 1.31, vertikal: 1.42							

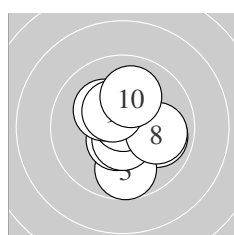
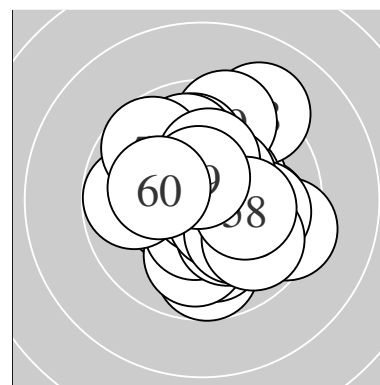

Serie 1:				
9.9 →	10.4 *	9.7 ↓	10.6 *	10.6 *
10.8 *	10.2 *	10.0 →	10.4 *	10.0 ↑
beste Teiler	48.3 (6.) 90.0 (5.) 99.8 (4.)			
Trefferlage	0.26 mm rechts, 0.03 mm hoch			
Streuwert	1.41, horizontal: 1.29, vertikal: 1.52			

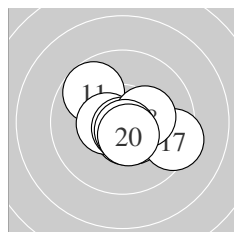

Serie 2:				
9.7 ↖	10.6 *	10.1 →	10.5 *	10.5 *
10.8 *	9.4 →	10.3 *	10.7 *	10.5 *
beste Teiler	43.0 (16.) 62.9 (19.) 89.4 (12.)			
Trefferlage	0.56 mm rechts, 0.28 mm tief			
Streuwert	1.33, horizontal: 1.61, vertikal: 0.98			

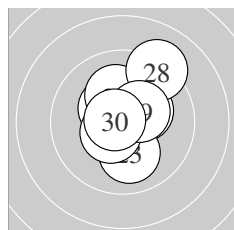

Serie 3:				
10.3 *	10.2 *	10.0 ↓	10.6 *	10.4 *
10.5 *	10.2 *	9.2 ↗	10.4 *	10.7 *
beste Teiler	59.2 (30.) 91.4 (24.) 114.1 (26.)			
Trefferlage	0.29 mm rechts, 0.80 mm hoch			
Streuwert	1.39, horizontal: 1.15, vertikal: 1.60			

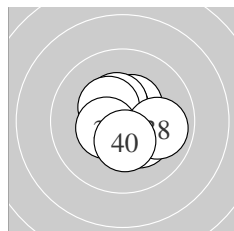

Serie 4:				
10.6 *	10.7 *	10.4 *	10.5 *	10.3 *
10.4 *	10.4 *	9.9 →	10.4 *	10.4 *
beste Teiler	65.2 (32.) 96.2 (31.) 116.0 (34.)			
Trefferlage	0.26 mm rechts, 0.21 mm hoch			
Streuwert	1.06, horizontal: 1.10, vertikal: 1.02			

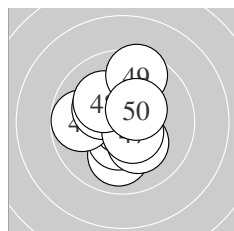

Serie 5:				
10.0 ↓	10.4 *	10.9 *	10.2 *	9.8 ←
10.3 *	10.5 *	10.2 *	9.5 ↑	10.4 *
beste Teiler	9.0 (43.) 106.0 (47.) 128.5 (42.)			
Trefferlage	0.25 mm links, 0.08 mm hoch			
Streuwert	1.52, horizontal: 1.34, vertikal: 1.69			

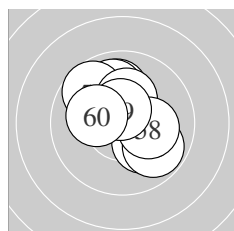

Serie 6:				
10.1 ↘	10.0 ↑	10.0 ↑	9.7 ↖	9.8 ↘
10.4 *	10.2 *	10.2 *	10.6 *	10.2 *
beste Teiler	99.1 (59.) 140.9 (56.) 177.2 (57.)			
Trefferlage	0.08 mm rechts, 0.82 mm hoch			
Streuwert	1.51, horizontal: 1.48, vertikal: 1.53			

Meyton Elektronik

ISSF AR Men – Wertung – **Männer**

StandNr: 123

Rossiter, Jack #70811314

StartNr: 65

22. Januar 2019 11:47

AUS

Unterschrift des Schützen

Meyton Elektronik

Ergebnis: **624.3** (596)
 Serien: 103.4 103.9 105.0 103.7 104.4 103.9
 Zähler: 56 4 0 0 0 0 0 0 0
 Innenzehner: 49
 weiteste: 330 (14), 302 (2), 274 (36)
 beste Teiler 24.2 (21.) 38.8 (47.) 43.4 (15.)
 Trefferlage 0.16 mm rechts, 0.09 mm hoch
 Streuwert 1.09, horizontal: 1.22, vertikal: 0.94

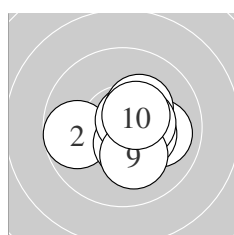
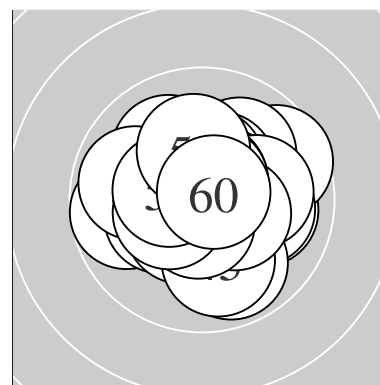

Serie 1:
 10.7 * 9.7 ← 10.0 → 10.5 * 10.4 *
 10.7 * 10.3 * 10.4 * 10.2 * 10.5 *
 beste Teiler 63.6 (6.) 72.0 (1.) 111.4 (4.)
 Trefferlage 0.61 mm rechts, 0.15 mm tief
 Streuwert 1.17, horizontal: 1.39, vertikal: 0.90

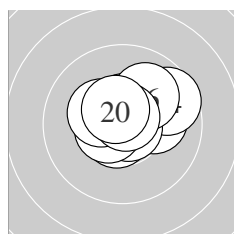

Serie 2:
 10.1 → 10.5 * 10.7 * 9.6 ↗ 10.8 *
 10.0 ↗ 10.6 * 10.3 * 10.8 * 10.5 *
 beste Teiler 43.4 (15.) 50.5 (19.) 75.2 (13.)
 Trefferlage 0.40 mm rechts, 0.57 mm hoch
 Streuwert 1.12, horizontal: 1.37, vertikal: 0.81

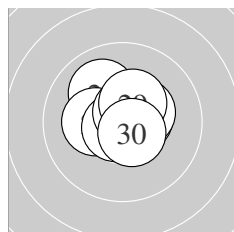

Serie 3:
 10.9 * 10.6 * 10.0 ↘ 10.2 * 10.7 *
 10.5 * 10.7 * 10.4 * 10.4 * 10.6 *
 beste Teiler 24.2 (21.) 58.4 (25.) 72.2 (27.)
 Trefferlage 0.06 mm links, 0.39 mm hoch
 Streuwert 0.90, horizontal: 1.01, vertikal: 0.78

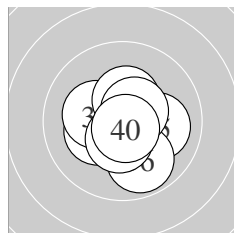

Serie 4:
 10.3 * 10.2 * 10.4 * 10.7 * 10.1 →
 9.9 ↓ 10.4 * 10.5 * 10.5 * 10.7 *
 beste Teiler 52.5 (40.) 71.1 (34.) 102.1 (39.)
 Trefferlage 0.19 mm rechts, 0.42 mm tief
 Streuwert 1.15, horizontal: 1.20, vertikal: 1.09

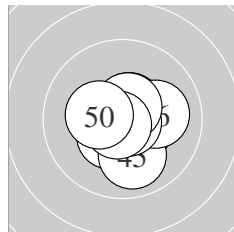

Serie 5:
 10.6 * 10.5 * 10.4 * 10.4 * 10.0 ↓
 10.1 → 10.8 * 10.6 * 10.7 * 10.3 *
 beste Teiler 38.8 (47.) 51.7 (49.) 87.3 (48.)
 Trefferlage 0.37 mm rechts, 0.21 mm tief
 Streuwert 1.03, horizontal: 1.08, vertikal: 0.97

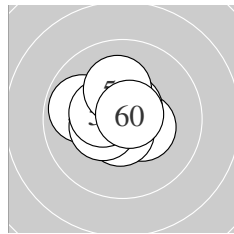

Serie 6:
 10.4 * 10.6 * 10.2 * 10.6 * 9.9 ←
 10.4 * 10.5 * 10.4 * 10.2 * 10.7 *
 beste Teiler 55.4 (60.) 80.5 (52.) 88.2 (54.)
 Trefferlage 0.55 mm links, 0.35 mm hoch
 Streuwert 1.03, horizontal: 1.18, vertikal: 0.85

Meyton Elektronik

ISSF AR Men – Wertung – Männer

StandNr: 124

Mathis, Thomas #223

StartNr: 66

22. Januar 2019 11:32

AUT

Unterschrift des Schützen

Meyton Elektronik

Ergebnis: **621.9** (594)
 Serien: 102.6 103.8 103.5 104.8 104.2 103.0
 Zähler: 54 6 0 0 0 0 0 0 0 0
 Innenzehner: 52
 weiteste: 299 (8), 294 (60), 286 (19)
 beste Teiler 24.0 (24.) 37.1 (38.) 53.9 (35.)
 Trefferlage 0.07 mm rechts, 0.26 mm hoch
 Streuwert 1.13, horizontal: 1.13, vertikal: 1.12

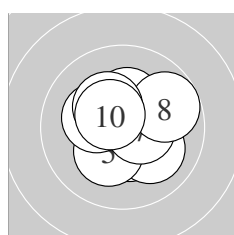
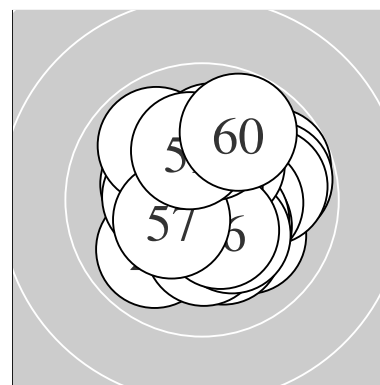

Serie 1:
 10.3 * 10.4 * 10.3 * 10.1 ↘ 10.2 *
 10.2 * 10.5 * 9.8 ↗ 10.3 * 10.5 *
 beste Teiler 113.5 (7.) 113.8 (10.) 130.6 (2.)
 Trefferlage 0.36 mm rechts, 0.17 mm hoch
 Streuwert 1.31, horizontal: 1.43, vertikal: 1.17

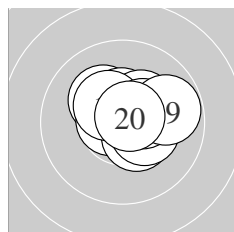

Serie 2:
 10.2 * 10.7 * 10.4 * 10.5 * 10.4 *
 10.3 * 10.4 * 10.4 * 9.8 → 10.7 *
 beste Teiler 59.6 (20.) 74.6 (12.) 123.1 (14.)
 Trefferlage 0.50 mm rechts, 0.51 mm hoch
 Streuwert 1.04, horizontal: 1.25, vertikal: 0.77

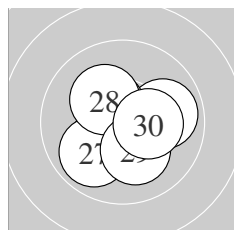

Serie 3:
 10.7 * 10.3 * 9.9 → 10.9 * 10.6 *
 10.5 * 9.9 ↙ 10.2 * 10.2 * 10.3 *
 beste Teiler 24.0 (24.) 69.6 (21.) 82.4 (25.)
 Trefferlage 0.00 mm , 0.21 mm tief
 Streuwert 1.26, horizontal: 1.37, vertikal: 1.13

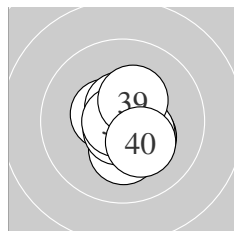

Serie 4:
 10.5 * 10.2 * 10.7 * 10.3 * 10.7 *
 10.4 * 10.6 * 10.8 * 10.4 * 10.2 *
 beste Teiler 37.1 (38.) 53.9 (35.) 62.6 (33.)
 Trefferlage 0.26 mm rechts, 0.25 mm tief
 Streuwert 0.90, horizontal: 0.77, vertikal: 1.02

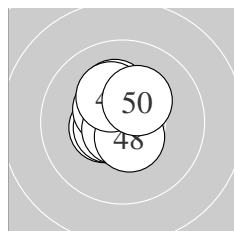

Serie 5:
 10.2 * 10.5 * 10.6 * 10.3 * 10.4 *
 10.5 * 10.7 * 10.5 * 10.2 * 10.3 *
 beste Teiler 59.8 (47.) 97.8 (43.) 104.6 (48.)
 Trefferlage 0.31 mm links, 0.61 mm hoch
 Streuwert 0.90, horizontal: 0.76, vertikal: 1.03

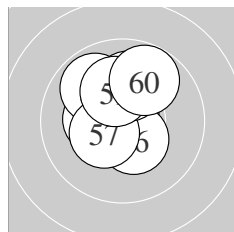

Serie 6:
 10.3 * 10.7 * 10.6 * 9.9 ↘ 10.6 *
 10.4 * 10.4 * 10.1 ↑ 10.2 * 9.8 ↗
 beste Teiler 57.5 (52.) 77.3 (55.) 92.1 (53.)
 Trefferlage 0.39 mm links, 0.75 mm hoch
 Streuwert 1.20, horizontal: 1.02, vertikal: 1.35

Meyton Elektronik

ISSF AR Men – Wertung – Männer

StandNr: 125

Hoberg, Alex #70811173

StartNr: 67

22. Januar 2019 11:31

AUS

Unterschrift des Schützen

Meyton Elektronik

Ergebnis: **627.2** (597)^{QF}
 Serien: 105.4 104.9 103.8 104.9 103.8 104.4
 Zähler: 57 3 0 0 0 0 0 0 0 0
 Innenzehner: 52
 weiteste: 416 (44), 315 (54), 272 (29)
 beste Teiler 20.0 (31.) 25.6 (8.) 28.0 (36.)
 Trefferlage 0.31 mm links, 0.05 mm tief
 Streuwert 1.01, horizontal: 1.11, vertikal: 0.91

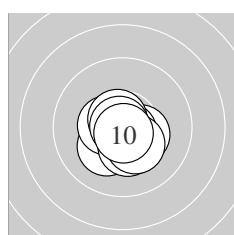
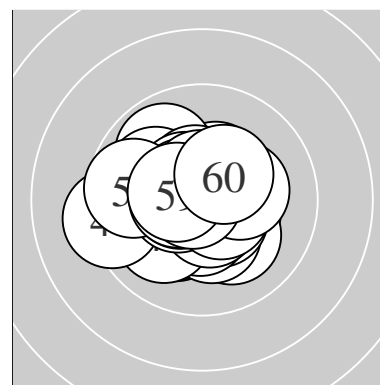

Serie 1:
 10.2 * 10.5 * 10.5 * 10.4 * 10.8 *
 10.7 * 10.3 * 10.9 * 10.3 * 10.8 *
 beste Teiler 25.6 (8.) 46.5 (10.) 50.2 (5.)
 Trefferlage 0.08 mm rechts, 0.54 mm tief
 Streuwert 0.78, horizontal: 0.85, vertikal: 0.71

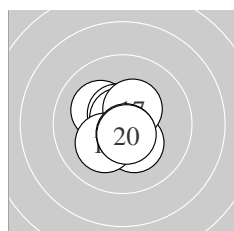

Serie 2:
 10.2 * 10.8 * 10.6 * 10.4 * 10.3 *
 10.7 * 10.4 * 10.2 * 10.7 * 10.6 *
 beste Teiler 32.3 (12.) 54.5 (16.) 74.9 (19.)
 Trefferlage 0.26 mm links, 0.18 mm tief
 Streuwert 0.93, horizontal: 0.84, vertikal: 1.02

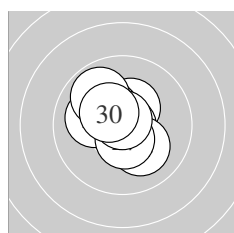

Serie 3:
 10.4 * 10.8 * 10.5 * 10.1 ↘ 10.1 ↖
 10.3 * 10.5 * 10.8 * 9.9 ↘ 10.4 *
 beste Teiler 32.2 (22.) 39.0 (28.) 102.0 (23.)
 Trefferlage 0.42 mm links, 0.42 mm hoch
 Streuwert 1.10, horizontal: 1.08, vertikal: 1.11

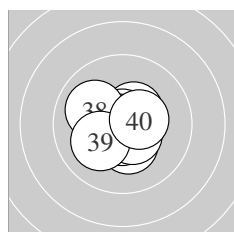

Serie 4:
 10.9 * 10.3 * 10.5 * 10.8 * 10.6 *
 10.8 * 10.5 * 10.0 ↖ 10.1 ↖ 10.4 *
 beste Teiler 20.0 (31.) 28.0 (36.) 40.0 (34.)
 Trefferlage 0.06 mm links, 0.17 mm tief
 Streuwert 0.99, horizontal: 1.07, vertikal: 0.91

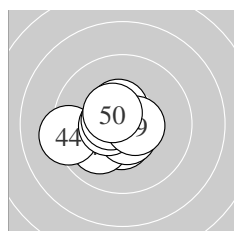

Serie 5:
 10.5 * 10.0 ↖ 10.6 * 9.3 ← 10.5 *
 10.7 * 10.6 * 10.5 * 10.6 * 10.5 *
 beste Teiler 73.5 (46.) 89.1 (43.) 93.6 (47.)
 Trefferlage 0.81 mm links, 0.18 mm tief
 Streuwert 1.16, horizontal: 1.37, vertikal: 0.90

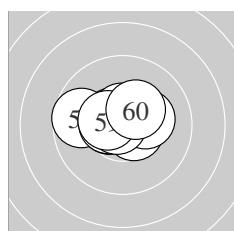

Serie 6:
 10.6 * 10.6 * 10.6 * 9.7 ← 10.2 *
 10.6 * 10.5 * 10.8 * 10.5 * 10.3 *
 beste Teiler 42.1 (58.) 92.2 (56.) 97.0 (52.)
 Trefferlage 0.40 mm links, 0.36 mm hoch
 Streuwert 1.03, horizontal: 1.37, vertikal: 0.47

ISSF AR Men – Wertung – Männer

StandNr: 126

Strepfl, Martin #350

StartNr: 68

22. Januar 2019 11:57

AUT

QF – Schütze hat sich fürs Finale qualifiziert

Unterschrift des Schützen

Meyton Elektronik

Ergebnis: **620.8** (595)
 Serien: 102.4 102.8 102.8 104.6 104.7 103.5
 Zähler: 55 5 0 0 0 0 0 0 0 0
 Innenzehner: 46
 weiteste: 303 (11), 291 (8), 264 (56)
 beste Teiler 17.8 (43.) 24.5 (58.) 46.0 (47.)
 Trefferlage 0.25 mm links, 0.19 mm hoch
 Streuwert 1.17, horizontal: 1.28, vertikal: 1.05

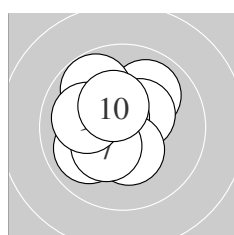
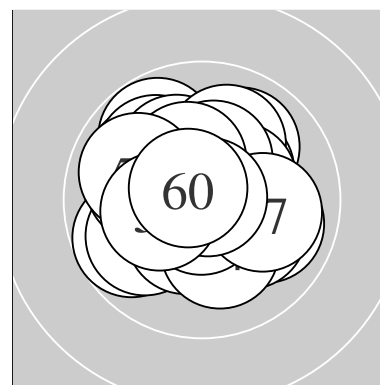

Serie 1:
 10.0 ↗ 10.4 * 10.6 * 10.0 ↙ 10.5 *
 10.4 * 10.3 * 9.8 ↘ 10.0 ↖ 10.4 *
 beste Teiler 80.6 (3.) 104.9 (5.) 135.6 (2.)
 Trefferlage 0.59 mm links, 0.30 mm hoch
 Streuwert 1.34, horizontal: 1.27, vertikal: 1.41

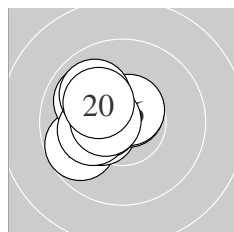

Serie 2:
 9.7 ↙ 10.4 * 10.0 ↘ 10.7 * 10.5 *
 10.6 * 10.2 * 10.5 * 10.0 ↘ 10.2 *
 beste Teiler 74.7 (14.) 86.7 (16.) 108.3 (18.)
 Trefferlage 1.28 mm links, 0.33 mm hoch
 Streuwert 0.99, horizontal: 0.99, vertikal: 0.98

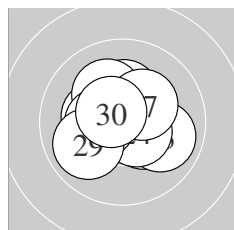

Serie 3:
 10.3 * 10.4 * 9.9 ↘ 10.5 * 10.3 *
 10.2 * 10.3 * 10.4 * 9.9 ↙ 10.6 *
 beste Teiler 96.3 (30.) 105.3 (24.) 143.1 (28.)
 Trefferlage 0.10 mm links, 0.18 mm hoch
 Streuwert 1.32, horizontal: 1.51, vertikal: 1.10

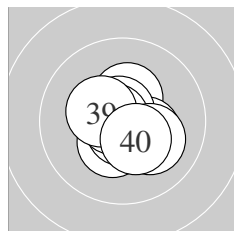

Serie 4:
 10.5 * 10.4 * 10.4 * 10.3 * 10.7 *
 10.7 * 10.7 * 10.1 ↘ 10.4 * 10.4 *
 beste Teiler 59.0 (35.) 59.4 (37.) 62.9 (36.)
 Trefferlage 0.24 mm rechts, 0.24 mm tief
 Streuwert 0.95, horizontal: 0.98, vertikal: 0.91

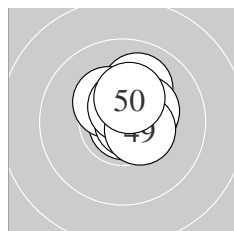

Serie 5:
 10.6 * 10.0 ↗ 10.9 * 10.4 * 10.3 *
 10.3 * 10.8 * 10.6 * 10.5 * 10.3 *
 beste Teiler 17.8 (43.) 46.0 (47.) 84.1 (41.)
 Trefferlage 0.55 mm rechts, 0.67 mm hoch
 Streuwert 0.75, horizontal: 0.69, vertikal: 0.80

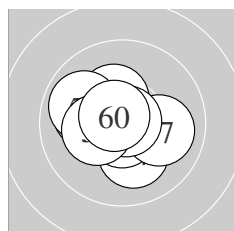

Serie 6:
 10.1 ↖ 10.4 * 10.3 * 10.2 * 10.7 *
 9.9 ↖ 10.0 → 10.9 * 10.3 * 10.7 *
 beste Teiler 24.5 (58.) 59.0 (55.) 69.5 (60.)
 Trefferlage 0.32 mm links, 0.08 mm tief
 Streuwert 1.26, horizontal: 1.47, vertikal: 1.02

Meyton Elektronik

ISSF AR Men – Wertung – Männer

StandNr: 127

Nymbursky, Petr #234

StartNr: 69

22. Januar 2019 11:52

CZE

Unterschrift des Schützen

Meyton Elektronik

Ergebnis: **622.8** (592)
 Serien: 104.2 102.9 103.5 104.0 103.7 104.5
 Zähler: 52 8 0 0 0 0 0 0 0
 Innenzehner: 46
 weiteste: 498 (12), 318 (19), 279 (54)
 beste Teiler 22.0 (6.) 33.2 (18.) 38.1 (9.)
 Trefferlage 0.01 mm links, 0.11 mm tief
 Streuwert 1.19, horizontal: 1.38, vertikal: 0.95

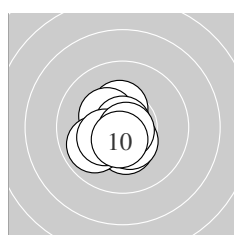
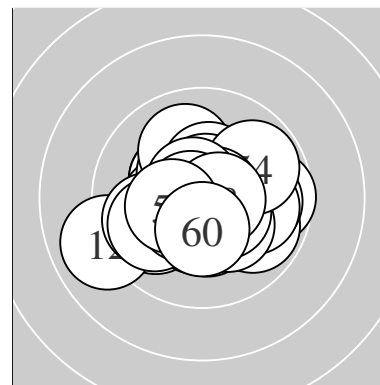

Serie 1:
 10.2 * 10.4 * 10.3 * 10.3 * 9.9 ↙
 10.9 * 10.3 * 10.5 * 10.8 * 10.6 *
 beste Teiler 22.0 (6.) 38.1 (9.) 100.8 (10.)
 Trefferlage 0.57 mm links, 0.46 mm tief
 Streuwert 0.98, horizontal: 0.94, vertikal: 1.01

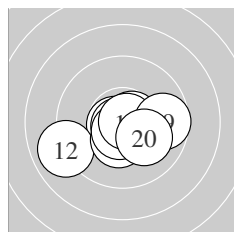

Serie 2:
 10.7 * 9.0 ↙ 10.4 * 10.1 ↘ 10.6 *
 10.8 * 10.7 * 10.8 * 9.7 → 10.1 ↘
 beste Teiler 33.2 (18.) 41.0 (16.) 65.1 (11.)
 Trefferlage 0.17 mm rechts, 0.67 mm tief
 Streuwert 1.54, horizontal: 2.04, vertikal: 0.76

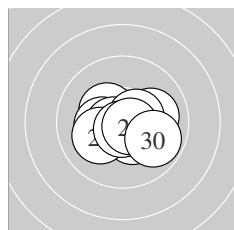

Serie 3:
 10.0 → 10.4 * 10.3 * 10.3 * 10.6 *
 10.1 ↙ 10.5 * 10.7 * 10.7 * 9.9 ↘
 beste Teiler 55.4 (28.) 68.9 (29.) 77.1 (25.)
 Trefferlage 0.16 mm rechts, 0.32 mm tief
 Streuwert 1.19, horizontal: 1.51, vertikal: 0.73

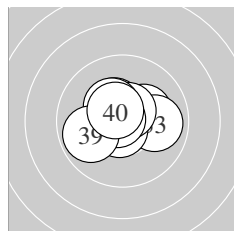

Serie 4:
 10.4 * 10.2 * 9.9 → 10.6 * 10.7 *
 10.6 * 10.4 * 10.8 * 9.9 ↙ 10.5 *
 beste Teiler 44.2 (38.) 69.2 (35.) 90.8 (34.)
 Trefferlage 0.10 mm links, 0.38 mm hoch
 Streuwert 1.13, horizontal: 1.40, vertikal: 0.78

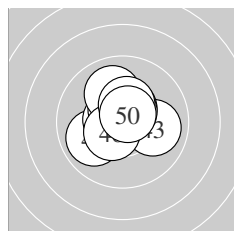

Serie 5:
 9.9 ↙ 10.6 * 10.0 → 10.5 * 10.5 *
 10.6 * 10.0 ↗ 10.5 * 10.4 * 10.7 *
 beste Teiler 74.3 (50.) 93.9 (42.) 97.2 (46.)
 Trefferlage 0.12 mm links, 0.48 mm hoch
 Streuwert 1.16, horizontal: 1.24, vertikal: 1.07

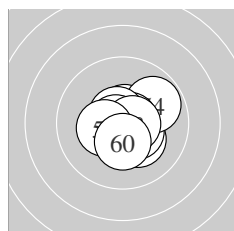

Serie 6:
 10.2 * 10.6 * 10.5 * 9.8 ↗ 10.7 *
 10.6 * 10.7 * 10.6 * 10.4 * 10.4 *
 beste Teiler 54.0 (57.) 57.2 (55.) 77.6 (56.)
 Trefferlage 0.37 mm rechts, 0.08 mm tief
 Streuwert 1.00, horizontal: 1.07, vertikal: 0.92

Meyton Elektronik

ISSF AR Men – Wertung – **Männer**

StandNr: 128

Ivan, Roe #70811302

StartNr: 70

22. Januar 2019 11:51

USA

Unterschrift des Schützen

Meyton Elektronik

Ergebnis: **624.5** (594)
 Serien: 103.9 105.0 105.7 102.7 103.5 103.7
 Zähler: 54 6 0 0 0 0 0 0 0 0
 Innenzehner: 47
 weiteste: 342 (37), 306 (35), 280 (60)
 beste Teiler 23.2 (22.) 30.0 (6.) 35.0 (38.)
 Trefferlage 0.32 mm rechts, 0.22 mm hoch
 Streuwert 1.08, horizontal: 1.31, vertikal: 0.80

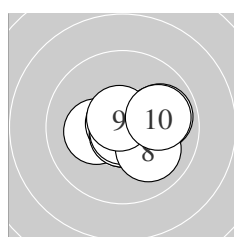
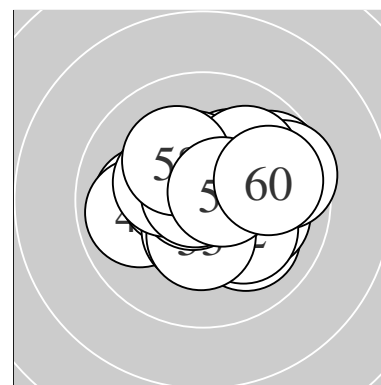

Serie 1:
 9.9 → 10.2 * 10.8 * 10.8 * 10.8 *
 10.8 * 10.0 → 10.0 ↘ 10.7 * 9.9 →
 beste Teiler 30.0 (6.) 39.6 (4.) 48.1 (5.)
 Trefferlage 0.67 mm rechts, 0.02 mm tief
 Streuwert 1.16, horizontal: 1.48, vertikal: 0.72

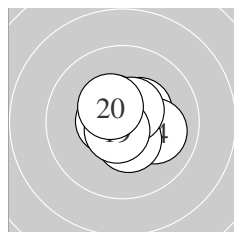

Serie 2:
 10.7 * 10.5 * 10.4 * 10.1 → 10.7 *
 10.6 * 10.4 * 10.5 * 10.7 * 10.4 *
 beste Teiler 67.0 (15.) 67.6 (19.) 73.0 (11.)
 Trefferlage 0.05 mm rechts, 0.19 mm hoch
 Streuwert 0.91, horizontal: 1.02, vertikal: 0.79

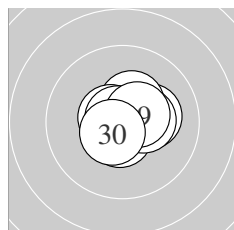

Serie 3:
 10.2 * 10.9 * 10.6 * 10.7 * 10.4 *
 10.6 * 10.4 * 10.8 * 10.5 * 10.6 *
 beste Teiler 23.2 (22.) 41.8 (28.) 68.0 (24.)
 Trefferlage 0.31 mm rechts, 0.20 mm hoch
 Streuwert 0.77, horizontal: 0.90, vertikal: 0.61

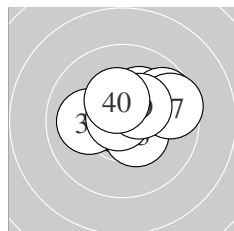

Serie 4:
 10.6 * 10.7 * 10.4 * 10.2 * 9.7 →
 10.0 ← 9.6 → 10.8 * 10.3 * 10.4 *
 beste Teiler 35.0 (38.) 73.2 (32.) 78.7 (31.)
 Trefferlage 0.51 mm rechts, 0.65 mm hoch
 Streuwert 1.30, horizontal: 1.66, vertikal: 0.77

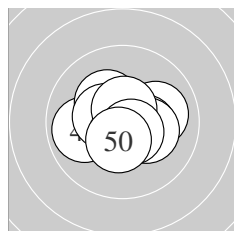

Serie 5:
 10.5 * 9.9 ← 10.3 * 10.5 * 10.0 →
 10.4 * 10.3 * 10.6 * 10.6 * 10.4 *
 beste Teiler 89.3 (49.) 89.5 (48.) 113.1 (41.)
 Trefferlage 0.01 mm links, 0.02 mm hoch
 Streuwert 1.22, horizontal: 1.52, vertikal: 0.81

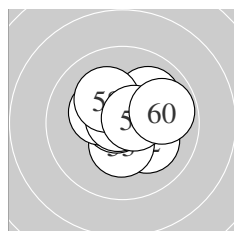

Serie 6:
 10.7 * 10.1 ↘ 10.4 * 10.8 * 10.3 *
 10.8 * 10.0 ↗ 10.2 * 10.6 * 9.8 →
 beste Teiler 43.8 (56.) 46.0 (54.) 66.2 (51.)
 Trefferlage 0.40 mm rechts, 0.25 mm hoch
 Streuwert 1.19, horizontal: 1.33, vertikal: 1.04

Meyton Elektronik

ISSF AR Men – Wertung – Männer

StandNr: 129

Blamauer, Nikolaus #334

StartNr: 71

22. Januar 2019 11:38

AUT

Unterschrift des Schützen

Meyton Elektronik

Ergebnis: **624.1** (597)
 Serien: 105.3 104.0 103.9 103.1 103.3 104.5
 Zähler: 57 3 0 0 0 0 0 0 0 0
 Innenzehner: 50
 weiteste: 303 (11), 298 (49), 270 (38)
 beste Teiler 20.1 (57.) 63.2 (12.) 64.8 (9.)
 Trefferlage 0.01 mm rechts, 0.17 mm hoch
 Streuwert 1.07, horizontal: 1.08, vertikal: 1.06

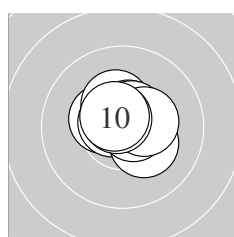
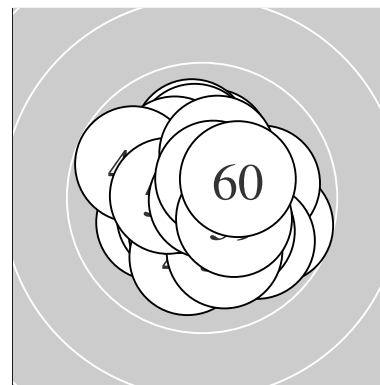

Serie 1:
 10.4 * 10.7 * 10.3 * 10.3 * 10.7 *
 10.6 * 10.6 * 10.4 * 10.7 * 10.6 *
 beste Teiler 64.8 (9.) 69.0 (5.) 72.4 (2.)
 Trefferlage 0.11 mm rechts, 0.44 mm hoch
 Streuwert 0.78, horizontal: 0.89, vertikal: 0.64

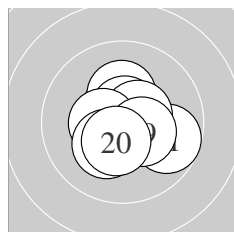

Serie 2:
 9.7 ↘ 10.7 * 10.6 * 10.3 * 10.7 *
 10.5 * 10.4 * 10.3 * 10.4 * 10.4 *
 beste Teiler 63.2 (12.) 75.3 (15.) 89.4 (13.)
 Trefferlage 0.24 mm rechts, 0.10 mm tief
 Streuwert 1.12, horizontal: 1.21, vertikal: 1.03

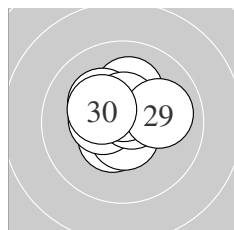

Serie 3:
 10.5 * 10.6 * 10.6 * 10.4 * 10.1 ↑
 10.2 * 10.6 * 10.6 * 10.0 → 10.3 *
 beste Teiler 77.1 (23.) 77.3 (27.) 86.7 (22.)
 Trefferlage 0.16 mm links, 0.49 mm hoch
 Streuwert 1.02, horizontal: 1.13, vertikal: 0.90

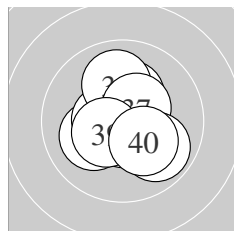

Serie 4:
 10.3 * 10.1 ↙ 10.5 * 10.6 * 10.6 *
 10.0 ↑ 10.5 * 9.9 ↘ 10.4 * 10.2 *
 beste Teiler 76.0 (35.) 82.0 (34.) 106.3 (33.)
 Trefferlage 0.12 mm rechts, 0.03 mm tief
 Streuwert 1.28, horizontal: 1.24, vertikal: 1.31

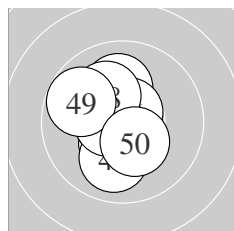

Serie 5:
 10.4 * 10.5 * 10.6 * 10.1 ↑ 10.0 ↓
 10.7 * 10.6 * 10.2 * 9.8 ↘ 10.4 *
 beste Teiler 72.5 (46.) 79.6 (43.) 90.0 (47.)
 Trefferlage 0.67 mm links, 0.13 mm hoch
 Streuwert 1.21, horizontal: 0.93, vertikal: 1.44

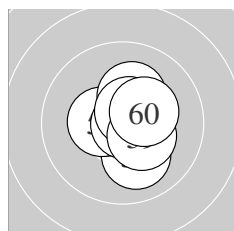

Serie 6:
 10.1 ↓ 10.6 * 10.4 * 10.4 * 10.2 *
 10.6 * 10.9 * 10.6 * 10.4 * 10.3 *
 beste Teiler 20.1 (57.) 86.4 (58.) 88.3 (56.)
 Trefferlage 0.43 mm rechts, 0.14 mm hoch
 Streuwert 0.96, horizontal: 0.92, vertikal: 1.01

Meyton Elektronik

ISSF AR Men – Wertung – Männer

StandNr: 130

Kamenskii, Sergei #70811295

StartNr: 72

22. Januar 2019 11:28

RUS

Unterschrift des Schützen

Meyton Elektronik

Ergebnis: **622.3** (593)
 Serien: 103.1 102.8 102.7 104.7 104.1 104.9
 Zähler: 53 7 0 0 0 0 0 0 0 0
 Innenzehner: 46
 weiteste: 359 (20), 297 (22), 285 (8)
 beste Teiler 30.5 (5.) 38.0 (27.) 40.2 (16.)
 Trefferlage 0.00 mm , 0.33 mm hoch
 Streuwert 1.14, horizontal: 1.26, vertikal: 1.01

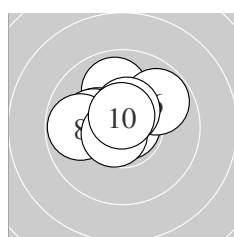
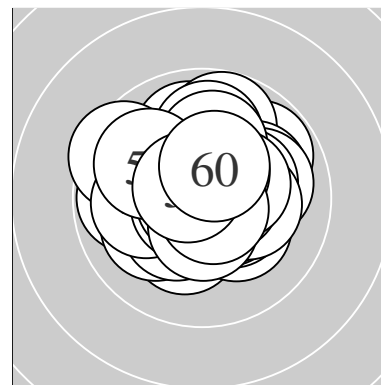

Serie 1:
 9.9 ↑ 10.2 * 10.2 * 10.6 * 10.8 *
 9.8 ↗ 10.5 * 9.8 ← 10.7 * 10.6 *
 beste Teiler 30.5 (5.) 71.8 (9.) 77.3 (10.)
 Trefferlage 0.56 mm links, 0.64 mm hoch
 Streuwert 1.19, horizontal: 1.42, vertikal: 0.91

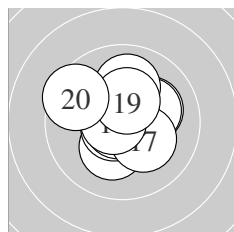

Serie 2:
 10.2 * 10.1 ↗ 10.2 * 10.0 ↑ 10.7 *
 10.8 * 10.2 * 10.7 * 10.4 * 9.5 ↘
 beste Teiler 40.2 (16.) 62.2 (18.) 70.1 (15.)
 Trefferlage 0.01 mm rechts, 0.37 mm hoch
 Streuwert 1.39, horizontal: 1.49, vertikal: 1.28

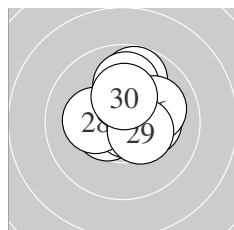

Serie 3:
 10.2 * 9.8 ↑ 10.6 * 9.9 ↑ 10.5 *
 10.0 ↗ 10.8 * 10.2 * 10.4 * 10.3 *
 beste Teiler 38.0 (27.) 100.0 (23.) 109.7 (25.)
 Trefferlage 0.43 mm rechts, 0.76 mm hoch
 Streuwert 1.21, horizontal: 1.19, vertikal: 1.23

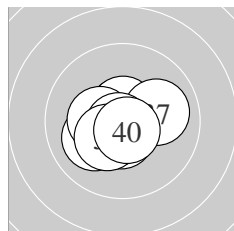

Serie 4:
 10.7 * 10.6 * 10.6 * 10.1 ↙ 10.3 *
 10.6 * 10.0 → 10.8 * 10.3 * 10.7 *
 beste Teiler 43.2 (38.) 68.4 (40.) 69.5 (31.)
 Trefferlage 0.26 mm links, 0.27 mm tief
 Streuwert 0.97, horizontal: 1.14, vertikal: 0.76

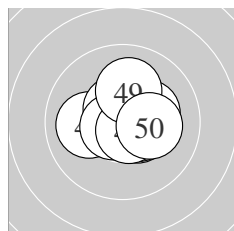

Serie 5:
 10.5 * 10.5 * 10.0 ← 10.3 * 10.6 *
 10.5 * 10.7 * 10.7 * 10.1 ↑ 10.2 *
 beste Teiler 70.0 (48.) 72.0 (47.) 97.9 (45.)
 Trefferlage 0.17 mm rechts, 0.12 mm hoch
 Streuwert 1.10, horizontal: 1.31, vertikal: 0.85

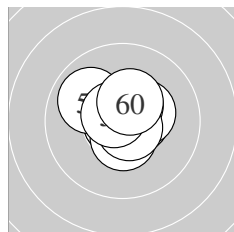

Serie 6:
 10.6 * 10.8 * 10.4 * 10.5 * 10.4 *
 10.5 * 10.7 * 9.9 ↘ 10.7 * 10.4 *
 beste Teiler 44.9 (52.) 63.6 (57.) 72.8 (59.)
 Trefferlage 0.17 mm rechts, 0.37 mm hoch
 Streuwert 0.92, horizontal: 1.03, vertikal: 0.79

Meyton Elektronik

ISSF AR Men – Wertung – **Männer**

StandNr: 131

Babuta, Arjun #70811265

StartNr: 73

22. Januar 2019 11:55

IND

Unterschrift des Schützen

Meyton Elektronik

Ergebnis: **626.7** (599)^{QF}
 Serien: 103.7 104.4 105.6 103.2 105.5 104.3
 Zähler: 59 1 0 0 0 0 0 0 0
 Innenzehner: 52
 weiteste: 292 (32), 250 (33), 246 (60)
 beste Teiler 10.2 (42.) 32.3 (36.) 33.2 (52.)
 Trefferlage 0.18 mm rechts, 0.00 mm
 Streuwert 1.00, horizontal: 1.20, vertikal: 0.76

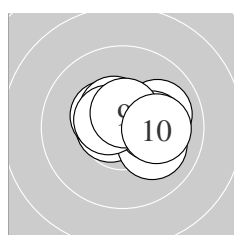
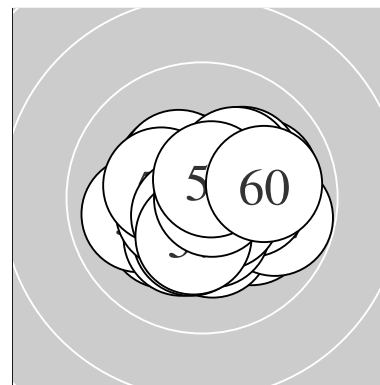

Serie 1:
 10.7 * 10.6 * 10.0 → 10.4 * 10.1 →
 10.2 * 10.5 * 10.5 * 10.6 * 10.1 →
 beste Teiler 63.7 (1.) 77.0 (2.) 92.2 (9.)
 Trefferlage 0.45 mm rechts, 0.33 mm hoch
 Streuwert 1.10, horizontal: 1.42, vertikal: 0.65

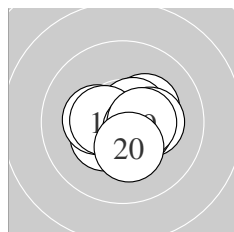

Serie 2:
 10.4 * 10.3 * 10.7 * 10.6 * 10.3 *
 10.3 * 10.5 * 10.5 * 10.5 * 10.3 *
 beste Teiler 63.4 (13.) 91.9 (14.) 106.0 (18.)
 Trefferlage 0.30 mm rechts, 0.08 mm tief
 Streuwert 1.00, horizontal: 1.20, vertikal: 0.74

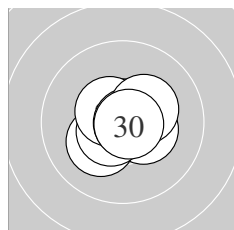

Serie 3:
 10.6 * 10.4 * 10.7 * 10.2 * 10.7 *
 10.6 * 10.5 * 10.8 * 10.3 * 10.8 *
 beste Teiler 36.3 (28.) 42.0 (30.) 54.0 (23.)
 Trefferlage 0.06 mm rechts, 0.04 mm hoch
 Streuwert 0.82, horizontal: 0.94, vertikal: 0.67

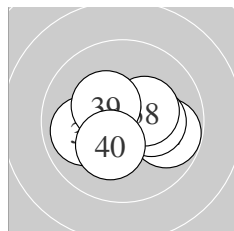

Serie 4:
 10.1 → 9.8 → 10.0 ← 10.2 * 10.7 *
 10.8 * 10.6 * 10.3 * 10.4 * 10.3 *
 beste Teiler 32.3 (36.) 52.6 (35.) 91.4 (37.)
 Trefferlage 0.30 mm rechts, 0.02 mm tief
 Streuwert 1.31, horizontal: 1.68, vertikal: 0.79

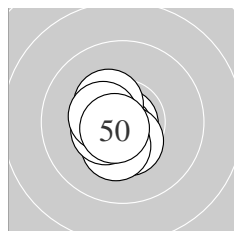

Serie 5:
 10.6 * 10.9 * 10.7 * 10.6 * 10.4 *
 10.4 * 10.3 * 10.5 * 10.4 * 10.7 *
 beste Teiler 10.2 (42.) 60.8 (43.) 66.2 (50.)
 Trefferlage 0.50 mm links, 0.38 mm tief
 Streuwert 0.67, horizontal: 0.53, vertikal: 0.79

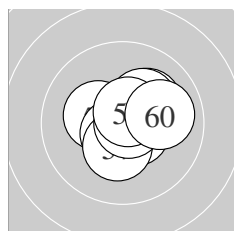

Serie 6:
 10.1 ↗ 10.8 * 10.6 * 10.3 * 10.2 *
 10.6 * 10.3 * 10.8 * 10.6 * 10.0 →
 beste Teiler 33.2 (52.) 39.1 (58.) 80.0 (59.)
 Trefferlage 0.46 mm rechts, 0.16 mm hoch
 Streuwert 1.01, horizontal: 1.13, vertikal: 0.88

Meyton Elektronik

ISSF AR Men – Wertung – Männer

StandNr: 132

Okada, Naoya #70811299

StartNr: 74

22. Januar 2019 11:54

JPN

QF – Schütze hat sich fürs Finale qualifiziert

Unterschrift des Schützen

Meyton Elektronik

Ergebnis:	620.9	(596)							
Serien:	103.2	103.3	103.0	104.7	103.0	103.7			
Zähler:	56	4	0	0	0	0	0	0	0
Innenzehner:	53								
weiteste:	355 (8), 327 (5), 283 (47)								
beste Teiler	38.8 (7.)	64.0 (36.)	70.0 (4.)						
Trefferlage	0.09 mm rechts, 0.01 mm hoch								
Streuwert	1.15, horizontal: 1.25, vertikal: 1.05								

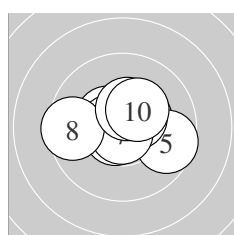
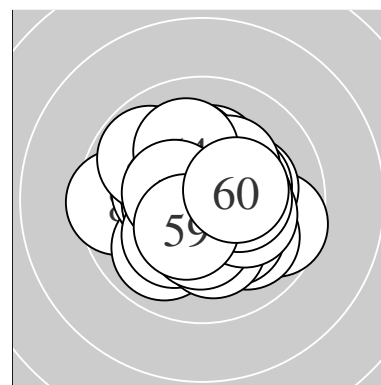

Serie 1:	10.4 *	10.6 *	10.4 *	10.7 *	9.6 ↘
	10.5 *	10.8 *	9.5 ←	10.4 *	10.3 *
beste Teiler	38.8 (7.)	70.0 (4.)	83.2 (2.)		
Trefferlage	0.06 mm rechts, 0.25 mm hoch				
Streuwert	1.36, horizontal: 1.76, vertikal: 0.76				

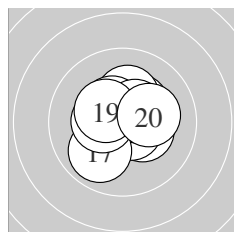

Serie 2:	10.3 *	10.3 *	10.2 *	10.7 *	10.4 *
	10.5 *	9.9 ↙	10.4 *	10.4 *	10.2 *
beste Teiler	74.0 (14.)	118.2 (16.)	126.8 (15.)		
Trefferlage	0.11 mm rechts, 0.31 mm hoch				
Streuwert	1.18, horizontal: 1.26, vertikal: 1.10				

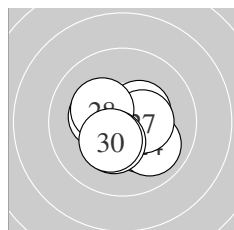

Serie 3:	10.4 *	10.2 *	10.4 *	10.0 ↘	10.3 *
	10.4 *	10.4 *	10.3 *	10.3 *	10.3 *
beste Teiler	132.0 (21.)	138.5 (26.)	140.0 (27.)		
Trefferlage	0.35 mm rechts, 0.46 mm tief				
Streuwert	1.16, horizontal: 1.33, vertikal: 0.96				

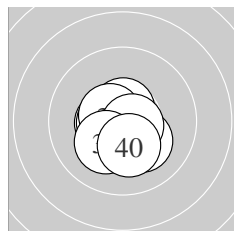

Serie 4:	10.5 *	10.5 *	10.2 *	10.5 *	10.6 *
	10.7 *	10.6 *	10.7 *	10.2 *	10.2 *
beste Teiler	64.0 (36.)	74.2 (38.)	82.0 (35.)		
Trefferlage	0.29 mm links, 0.51 mm tief				
Streuwert	0.85, horizontal: 0.87, vertikal: 0.84				

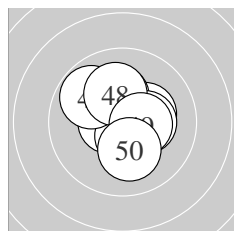

Serie 5:	10.3 *	10.6 *	10.6 *	10.2 *	10.3 *
	10.5 *	9.8 ↘	10.1 ↑	10.4 *	10.2 *
beste Teiler	93.0 (43.)	100.4 (42.)	101.6 (46.)		
Trefferlage	0.08 mm rechts, 0.39 mm hoch				
Streuwert	1.25, horizontal: 1.21, vertikal: 1.28				

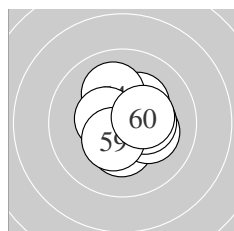

Serie 6:	10.3 *	10.3 *	10.6 *	10.1 ↑	10.2 *
	10.6 *	10.3 *	10.5 *	10.4 *	10.4 *
beste Teiler	92.6 (56.)	98.5 (53.)	121.0 (58.)		
Trefferlage	0.25 mm rechts, 0.11 mm hoch				
Streuwert	1.13, horizontal: 1.11, vertikal: 1.15				

ISSF AR Men – Wertung – Männer

StandNr: 133

Huber, Caspar #70811310

StartNr: 75

22. Januar 2019 11:38

SUI – ZH

Unterschrift des Schützen

Meyton Elektronik

Ergebnis: **626.1** (597)^{QF}
 Serien: 104.0 103.8 103.4 105.7 105.0 104.2
 Zähler: 57 3 0 0 0 0 0 0 0 0
 Innenzehner: 51
 weiteste: 345 (26), 276 (14), 268 (48)
 beste Teiler 11.4 (39.) 17.0 (11.) 29.0 (60.)
 Trefferlage 0.12 mm rechts, 0.20 mm hoch
 Streuwert 1.03, horizontal: 1.12, vertikal: 0.92

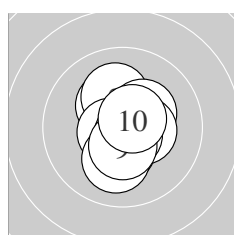
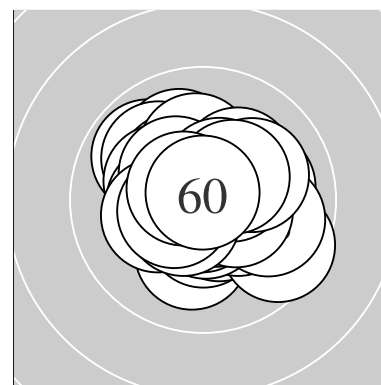

Serie 1:
 10.3 * 10.4 * 10.1 ↑ 10.3 * 10.6 *
 10.1 ↓ 10.4 * 10.7 * 10.5 * 10.6 *
 beste Teiler 62.2 (8.) 81.9 (5.) 84.3 (10.)
 Trefferlage 0.10 mm rechts, 0.09 mm tief
 Streuwert 1.08, horizontal: 0.79, vertikal: 1.30

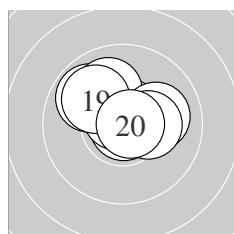

Serie 2:
 10.9 * 10.7 * 10.7 * 9.8 ↘ 10.6 *
 10.0 ↗ 10.1 → 10.3 * 10.0 ↘ 10.7 *
 beste Teiler 17.0 (11.) 51.0 (20.) 63.3 (12.)
 Trefferlage 0.03 mm links, 0.77 mm hoch
 Streuwert 1.12, horizontal: 1.37, vertikal: 0.80

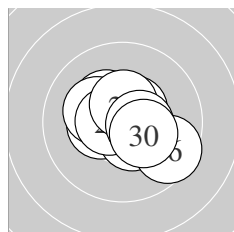

Serie 3:
 10.5 * 10.3 * 10.4 * 10.2 * 10.5 *
 9.6 ↘ 10.6 * 10.5 * 10.5 * 10.3 *
 beste Teiler 88.2 (27.) 107.7 (21.) 114.1 (29.)
 Trefferlage 0.18 mm rechts, 0.01 mm hoch
 Streuwert 1.25, horizontal: 1.46, vertikal: 0.98

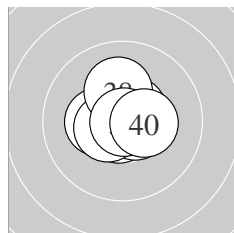

Serie 4:
 10.6 * 10.8 * 10.7 * 10.6 * 10.3 *
 10.5 * 10.7 * 10.2 * 10.9 * 10.4 *
 beste Teiler 11.4 (39.) 41.0 (32.) 57.2 (33.)
 Trefferlage 0.00 mm , 0.14 mm hoch
 Streuwert 0.81, horizontal: 0.89, vertikal: 0.73

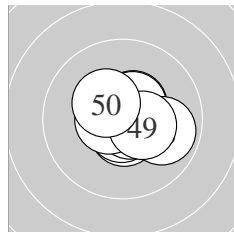

Serie 5:
 10.6 * 10.5 * 10.7 * 10.5 * 10.7 *
 10.7 * 10.6 * 9.9 ↘ 10.4 * 10.4 *
 beste Teiler 61.2 (45.) 63.4 (46.) 74.3 (43.)
 Trefferlage 0.30 mm rechts, 0.00 mm
 Streuwert 0.94, horizontal: 1.11, vertikal: 0.73

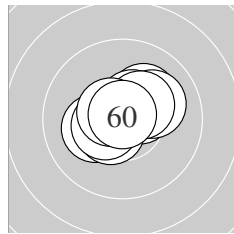

Serie 6:
 10.4 * 10.2 * 10.2 * 10.5 * 10.1 →
 10.5 * 10.5 * 10.4 * 10.6 * 10.8 *
 beste Teiler 29.0 (60.) 89.1 (59.) 108.2 (56.)
 Trefferlage 0.17 mm rechts, 0.38 mm hoch
 Streuwert 1.03, horizontal: 1.25, vertikal: 0.75

Meyton Elektronik

ISSF AR Men – Wertung – Männer

StandNr: 134

Zott, Georg #88

StartNr: 76

22. Januar 2019 11:28

AUT

QF – Schütze hat sich fürs Finale qualifiziert

Unterschrift des Schützen

Meyton Elektronik

Ergebnis: **620.6** (593)
 Serien: 104.4 101.3 104.0 104.0 103.4 103.5
 Zähler: 53 7 0 0 0 0 0 0 0
 Innenzehner: 45
 weiteste: 427 (18), 302 (50), 286 (11)
 beste Teiler 10.8 (24.) 11.6 (4.) 22.4 (3.)
 Trefferlage 0.18 mm rechts, 0.15 mm hoch
 Streuwert 1.23, horizontal: 1.26, vertikal: 1.20

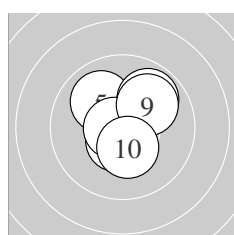
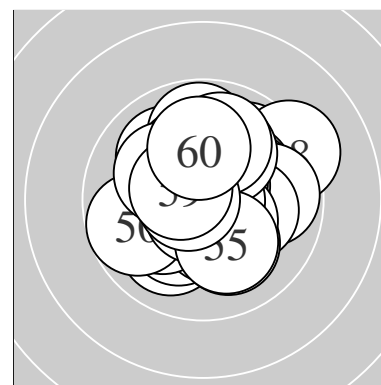

Serie 1:
 10.7 * 10.4 * 10.9 * 10.9 * 10.0 ↘
 10.5 * 9.9 ↗ 10.7 * 10.0 ↗ 10.4 *
 beste Teiler 11.6 (4.) 22.4 (3.) 60.5 (8.)
 Trefferlage 0.24 mm rechts, 0.44 mm hoch
 Streuwert 1.13, horizontal: 1.04, vertikal: 1.21

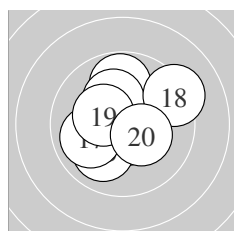

Serie 2:
 9.8 ↑ 10.3 * 10.6 * 10.6 * 10.2 *
 10.0 ↙ 10.0 ← 9.2 ↗ 10.3 * 10.3 *
 beste Teiler 82.7 (14.) 84.5 (13.) 151.0 (12.)
 Trefferlage 0.21 mm links, 0.37 mm hoch
 Streuwert 1.64, horizontal: 1.75, vertikal: 1.52

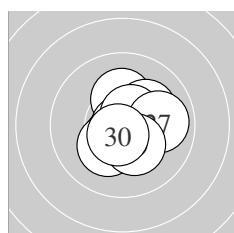

Serie 3:
 10.6 * 10.2 * 10.2 * 10.9 * 10.5 *
 10.6 * 9.9 → 10.2 * 10.3 * 10.6 *
 beste Teiler 10.8 (24.) 78.7 (30.) 89.1 (21.)
 Trefferlage 0.42 mm rechts, 0.01 mm tief
 Streuwert 1.10, horizontal: 1.09, vertikal: 1.11

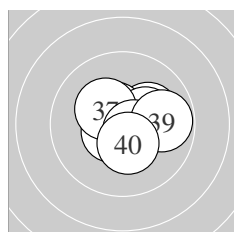

Serie 4:
 10.6 * 10.6 * 10.2 * 10.6 * 10.6 *
 10.3 * 10.3 * 10.6 * 9.8 → 10.4 *
 beste Teiler 82.8 (31.) 93.2 (35.) 93.8 (38.)
 Trefferlage 0.63 mm rechts, 0.07 mm hoch
 Streuwert 1.05, horizontal: 1.26, vertikal: 0.80

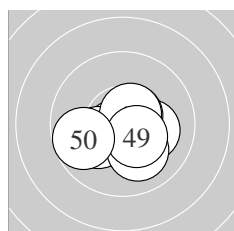

Serie 5:
 10.5 * 10.7 * 10.2 * 10.2 * 10.6 *
 10.4 * 10.6 * 10.1 ↘ 10.4 * 9.7 ←
 beste Teiler 75.0 (42.) 91.0 (47.) 91.2 (45.)
 Trefferlage 0.14 mm rechts, 0.66 mm tief
 Streuwert 1.17, horizontal: 1.45, vertikal: 0.80

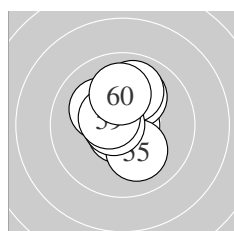

Serie 6:
 10.4 * 10.8 * 10.7 * 10.1 ↗ 10.1 ↘
 9.9 ↑ 10.2 * 10.7 * 10.5 * 10.1 ↑
 beste Teiler 45.1 (52.) 60.0 (53.) 64.0 (58.)
 Trefferlage 0.14 mm links, 0.71 mm hoch
 Streuwert 1.16, horizontal: 0.92, vertikal: 1.35

Meyton Elektronik

ISSF AR Men – Wertung – Männer

StandNr: 135

Höllwarth, Michael #102

StartNr: 77

22. Januar 2019 11:41

AUT

Unterschrift des Schützen

Meyton Elektronik

Ergebnis:	620.1	(592)					
Serien:	102.8	104.1	104.1	101.9	102.5	104.7	
Zähler:	52	8	0	0	0	0	0
Innenzehner:	44						
weiteste:	302 (9), 294 (34), 291 (37)						
beste Teiler	39.0 (18.) 46.5 (21.) 47.5 (36.)						
Trefferlage	0.07 mm rechts, 0.25 mm hoch						
Streuwert	1.19, horizontal: 1.37, vertikal: 0.98						

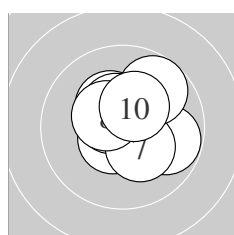
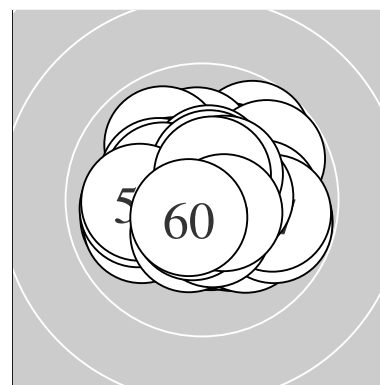

Serie 1:	10.6 *	9.8 →	10.4 *	10.3 *	10.4 *
	10.6 *	10.3 *	10.4 *	9.7 ↗	10.3 *
beste Teiler	89.2 (6.) 97.1 (1.) 126.2 (8.)				
Trefferlage	0.33 mm rechts, 0.59 mm hoch				
Streuwert	1.23, horizontal: 1.29, vertikal: 1.16				

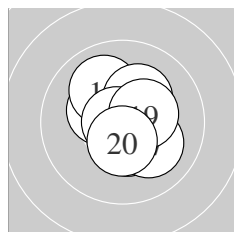

Serie 2:	10.3 *	10.0 ↘	10.7 *	10.7 *	10.4 *
	10.2 *	10.1 ↘	10.8 *	10.4 *	10.5 *
beste Teiler	39.0 (18.) 54.9 (14.) 70.7 (13.)				
Trefferlage	0.23 mm rechts, 0.16 mm hoch				
Streuwert	1.08, horizontal: 1.00, vertikal: 1.15				

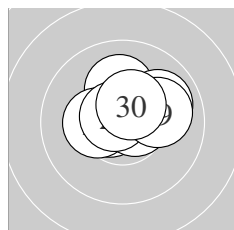

Serie 3:	10.8 *	10.6 *	10.6 *	10.1 ↑	9.9 →
	10.3 *	10.6 *	10.7 *	10.0 →	10.5 *
beste Teiler	46.5 (21.) 63.8 (28.) 80.0 (22.)				
Trefferlage	0.19 mm rechts, 0.65 mm hoch				
Streuwert	1.01, horizontal: 1.26, vertikal: 0.66				

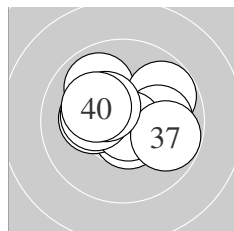

Serie 4:	9.9 ↘	10.6 *	10.2 *	9.8 ↗	10.0 →
	10.8 *	9.8 →	10.2 *	10.4 *	10.2 *
beste Teiler	47.5 (36.) 89.9 (32.) 143.2 (39.)				
Trefferlage	0.03 mm rechts, 0.40 mm hoch				
Streuwert	1.51, horizontal: 1.88, vertikal: 0.99				

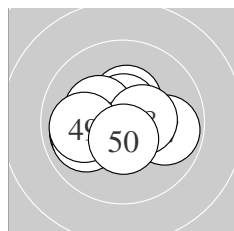

Serie 5:	10.4 *	9.9 ←	10.6 *	10.0 ←	10.5 *
	10.3 *	9.9 →	10.4 *	10.0 ←	10.5 *
beste Teiler	84.2 (43.) 102.4 (45.) 110.1 (50.)				
Trefferlage	0.34 mm links, 0.09 mm tief				
Streuwert	1.39, horizontal: 1.77, vertikal: 0.84				

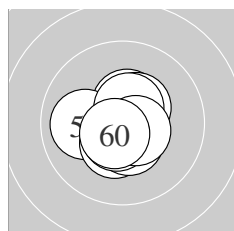

Serie 6:	10.6 *	10.5 *	10.0 ←	10.4 *	10.5 *
	10.4 *	10.5 *	10.6 *	10.6 *	10.6 *
beste Teiler	82.2 (51.) 85.0 (60.) 91.7 (58.)				
Trefferlage	0.02 mm links, 0.17 mm tief				
Streuwert	0.95, horizontal: 0.99, vertikal: 0.91				

ISSF AR Men – Wertung – Männer

StandNr: 136

Manpat, Rakesh #70811320

StartNr: 78

22. Januar 2019 11:43

India

Unterschrift des Schützen

Meyton Elektronik

Ergebnis:	606.2	(579)
Serien:	99.8	103.3 101.9 100.6 99.4 101.2
Zähler:	40	19 1 0 0 0 0 0 0 0
Innenzehner:	33	
weiteste:	613 (2), 473 (43), 465 (60)	
beste Teiler	8.6 (35.)	45.1 (18.) 70.0 (9.)
Trefferlage	0.08 mm links, 0.11 mm tief	
Streuwert	1.72, horizontal: 2.02, vertikal: 1.35	

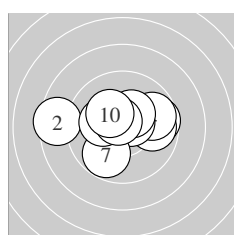
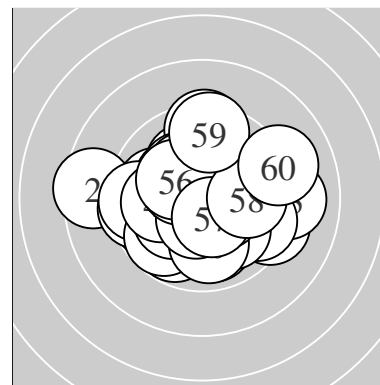

Serie 1:

9.7 →	8.5 ←	9.8 →	9.8 →	10.6 *
10.4 *	9.8 ↙	10.2 *	10.7 *	10.3 *
beste Teiler	70.0 (9.) 89.1 (5.) 148.6 (6.)			
Trefferlage	0.07 mm links, 0.37 mm hoch			
Streuwert	2.13, horizontal: 2.81, vertikal: 1.07			

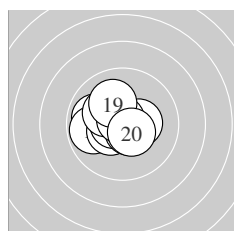

Serie 2:

9.9 ←	9.8 ←	10.4 *	10.4 *	10.6 *
10.2 *	10.6 *	10.8 *	10.1 ↗	10.5 *
beste Teiler	45.1 (18.) 81.0 (15.) 87.8 (17.)			
Trefferlage	0.69 mm links, 0.14 mm hoch			
Streuwert	1.16, horizontal: 1.39, vertikal: 0.88			

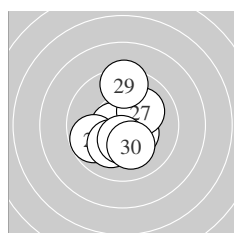

Serie 3:

10.4 *	10.6 *	10.6 *	10.4 *	9.8 ←
10.1 ↙	10.1 ↗	10.4 *	9.4 ↑	10.1 ↓
beste Teiler	77.9 (23.) 98.1 (22.) 135.5 (28.)			
Trefferlage	0.10 mm links, 0.42 mm tief			
Streuwert	1.52, horizontal: 1.23, vertikal: 1.76			

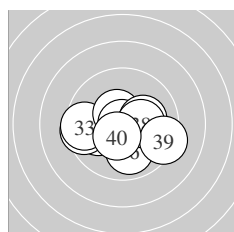

Serie 4:

10.0 ←	9.5 ←	9.5 ←	10.5 *	10.9 *
9.9 ↓	10.2 *	10.3 *	9.3 →	10.5 *
beste Teiler	8.6 (35.) 112.7 (34.) 123.9 (40.)			
Trefferlage	0.25 mm links, 0.50 mm tief			
Streuwert	1.85, horizontal: 2.41, vertikal: 1.01			

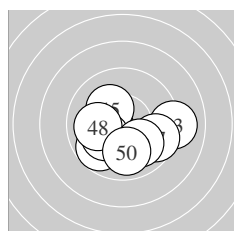

Serie 5:

10.2 *	10.5 *	9.1 →	9.7 ↙	10.2 *
10.2 *	9.6 →	10.0 ←	10.0 ↘	9.9 ↓
beste Teiler	122.0 (42.) 181.9 (41.) 186.8 (45.)			
Trefferlage	0.09 mm rechts, 0.98 mm tief			
Streuwert	1.87, horizontal: 2.36, vertikal: 1.20			

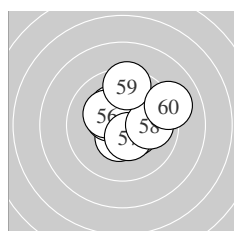

Serie 6:

10.5 *	10.3 *	10.4 *	10.4 *	10.4 *
10.2 *	10.5 *	9.9 →	9.5 ↑	9.1 →
beste Teiler	120.8 (51.) 121.1 (57.) 131.2 (55.)			
Trefferlage	0.51 mm rechts, 0.72 mm hoch			
Streuwert	1.64, horizontal: 1.78, vertikal: 1.50			

ISSF AR Men – Wertung – **Männer**

StandNr: 137

Davis, Michael #70811181

StartNr: 79

22. Januar 2019 11:50

AUS

Unterschrift des Schützen

Meyton Elektronik

Ergebnis: **625.3** (596)
 Serien: 103.9 103.9 104.5 105.6 102.9 104.5
 Zähler: 56 4 0 0 0 0 0 0 0 0
 Innenzehner: 51
 weiteste: 276 (10), 258 (20), 258 (49)
 beste Teiler 9.8 (34.) 36.1 (31.) 38.0 (5.)
 Trefferlage 0.13 mm links, 0.14 mm tief
 Streuwert 1.04, horizontal: 1.12, vertikal: 0.95

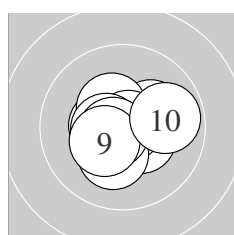
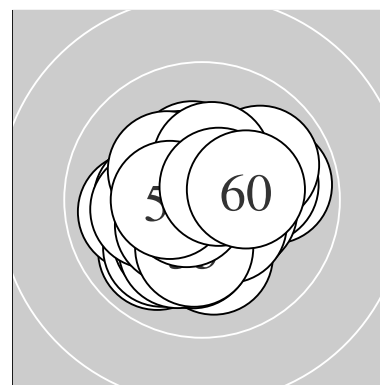

Serie 1:
 10.2 * 10.4 * 10.5 * 10.4 * 10.8 *
 10.5 * 10.2 * 10.7 * 10.4 * 9.8 →
 beste Teiler 38.0 (5.) 69.4 (8.) 105.4 (6.)
 Trefferlage 0.07 mm rechts, 0.10 mm tief
 Streuwert 1.14, horizontal: 1.37, vertikal: 0.85

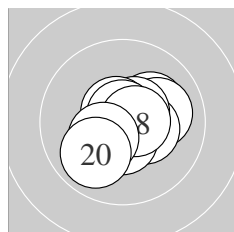

Serie 2:
 10.2 * 10.0 → 10.4 * 10.6 * 10.6 *
 10.5 * 10.8 * 10.6 * 10.3 * 9.9 ↙
 beste Teiler 43.1 (17.) 76.8 (15.) 79.2 (18.)
 Trefferlage 0.34 mm rechts, 0.11 mm tief
 Streuwert 1.12, horizontal: 1.26, vertikal: 0.96

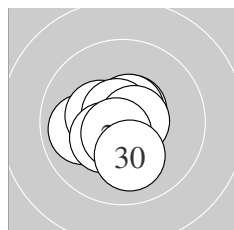

Serie 3:
 10.6 * 9.9 ← 10.4 * 10.6 * 10.5 *
 10.7 * 10.4 * 10.7 * 10.6 * 10.1 ↓
 beste Teiler 63.0 (26.) 73.3 (28.) 81.4 (29.)
 Trefferlage 0.43 mm links, 0.25 mm tief
 Streuwert 0.98, horizontal: 1.03, vertikal: 0.93

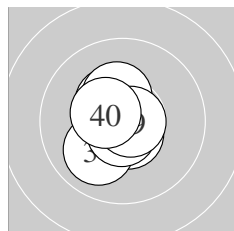

Serie 4:
 10.8 * 10.6 * 10.7 * 10.9 * 10.4 *
 10.0 ↙ 10.3 * 10.7 * 10.7 * 10.5 *
 beste Teiler 9.8 (34.) 36.1 (31.) 51.1 (39.)
 Trefferlage 0.31 mm links, 0.01 mm hoch
 Streuwert 0.83, horizontal: 0.67, vertikal: 0.97

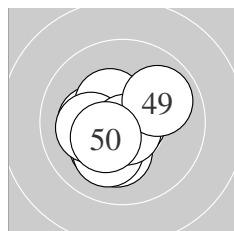

Serie 5:
 10.2 * 10.2 * 10.2 * 10.1 ↙ 10.7 *
 10.4 * 10.1 ← 10.7 * 9.9 → 10.4 *
 beste Teiler 52.0 (45.) 52.8 (48.) 139.2 (46.)
 Trefferlage 0.52 mm links, 0.45 mm tief
 Streuwert 1.20, horizontal: 1.25, vertikal: 1.14

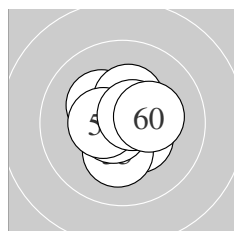

Serie 6:
 10.4 * 10.3 * 10.6 * 10.6 * 10.2 *
 10.3 * 10.7 * 10.5 * 10.6 * 10.3 *
 beste Teiler 66.6 (57.) 80.4 (59.) 87.6 (54.)
 Trefferlage 0.06 mm rechts, 0.01 mm hoch
 Streuwert 0.99, horizontal: 0.99, vertikal: 1.00

Meyton Elektronik

ISSF AR Men – Wertung – Männer

StandNr: 138

Pickl, Bernhard #228

StartNr: 80

22. Januar 2019 11:38

AUT

Unterschrift des Schützen

Meyton Elektronik

Ergebnis: **619.2** (595)

Serien: 103.2 103.4 103.0 101.6 105.2 102.8

Zähler: 56 3 1 0 0 0 0 0 0

Innenzehner: 47

weiteste: 516 (32), 270 (55), 266 (51)

beste Teiler 42.0 (4.) 60.3 (40.) 63.6 (46.)

Trefferlage 0.04 mm rechts, 0.29 mm hoch

Streuwert 1.22, horizontal: 1.38, vertikal: 1.03

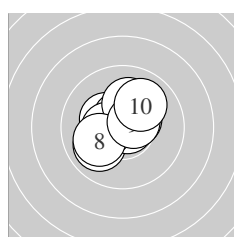
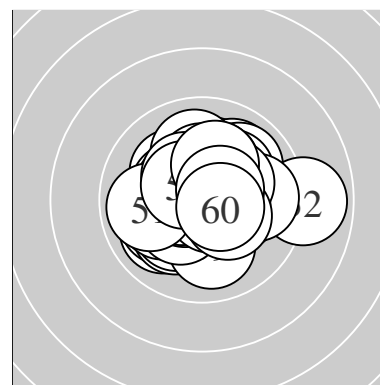

Serie 1:

10.0 ↙	10.3 *	10.4 *	10.8 *	10.6 *
10.4 *	10.1 ↑	10.1 ↙	10.5 *	10.0 ↗

beste Teiler 42.0 (4.) 84.4 (5.) 102.8 (9.)

Trefferlage 0.24 mm links, 0.37 mm hoch

Streuwert 1.23, horizontal: 1.32, vertikal: 1.12

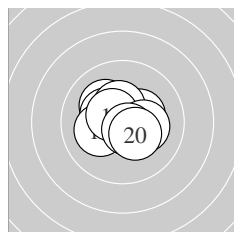

Serie 2:

10.4 *	10.3 *	10.1 ↘	10.3 *	10.4 *
10.2 *	10.5 *	10.2 *	10.6 *	10.4 *

beste Teiler 77.2 (19.) 107.0 (17.) 132.6 (15.)

Trefferlage 0.20 mm links, 0.30 mm hoch

Streuwert 1.11, horizontal: 1.30, vertikal: 0.89

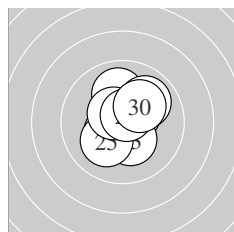

Serie 3:

10.5 *	10.4 *	10.3 *	10.4 *	10.1 ↘
10.0 ↑	10.5 *	10.7 *	9.9 ↗	10.2 *

beste Teiler 68.9 (28.) 106.7 (27.) 114.0 (21.)

Trefferlage 0.25 mm rechts, 0.47 mm hoch

Streuwert 1.22, horizontal: 1.10, vertikal: 1.33

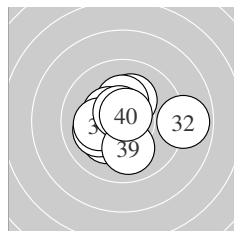

Serie 4:

10.2 *	8.9 →	10.2 *	10.3 *	10.4 *
10.1 ↙	10.2 *	10.6 *	10.0 ↓	10.7 *

beste Teiler 60.3 (40.) 80.9 (38.) 135.3 (35.)

Trefferlage 0.01 mm links, 0.06 mm hoch

Streuwert 1.72, horizontal: 2.06, vertikal: 1.29

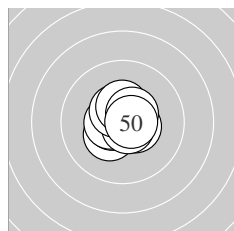

Serie 5:

10.3 *	10.6 *	10.5 *	10.5 *	10.5 *
10.7 *	10.5 *	10.4 *	10.5 *	10.7 *

beste Teiler 63.6 (46.) 73.0 (50.) 88.4 (42.)

Trefferlage 0.06 mm links, 0.21 mm hoch

Streuwert 0.80, horizontal: 0.81, vertikal: 0.80

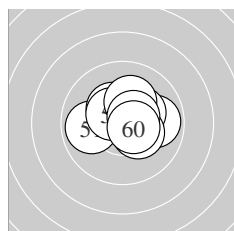

Serie 6:

9.9 ↙	10.4 *	10.5 *	10.2 *	9.9 →
10.3 *	10.2 *	10.3 *	10.5 *	10.6 *

beste Teiler 99.7 (60.) 105.6 (59.) 116.9 (53.)

Trefferlage 0.55 mm rechts, 0.37 mm hoch

Streuwert 1.25, horizontal: 1.58, vertikal: 0.81

Meyton Elektronik

ISSF AR Men – Wertung – Männer

StandNr: 139

Paynaud, Alexis #70811306

StartNr: 81

22. Januar 2019 11:30

FRA

Unterschrift des Schützen

Meyton Elektronik

Ergebnis: **615.9** (592)

Serien: 103.1 104.4 101.8 102.2 103.4 101.0

Zähler: 52 8 0 0 0 0 0 0 0 0

Innenzehner: 40

weiteste: 406 (57), 353 (59), 337 (12)

beste Teiler 55.1 (9.) 60.0 (15.) 69.3 (43.)

Trefferlage 0.11 mm rechts, 0.11 mm hoch

Streuwert 1.34, horizontal: 1.31, vertikal: 1.38

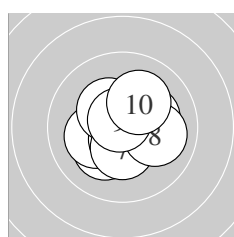
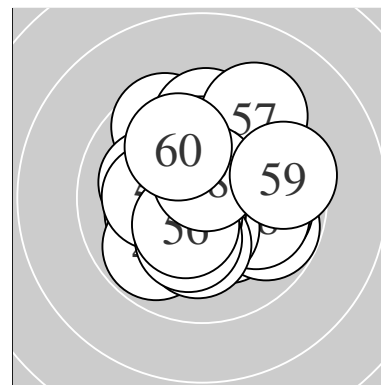

Serie 1:

10.4 *	10.2 *	10.2 *	10.6 *	10.2 *
10.3 *	10.4 *	10.0 →	10.7 *	10.1 ↗

beste Teiler 55.1 (9.) 85.1 (4.) 138.0 (1.)

Trefferlage 0.13 mm rechts, 0.05 mm hoch

Streuwert 1.24, horizontal: 1.32, vertikal: 1.16

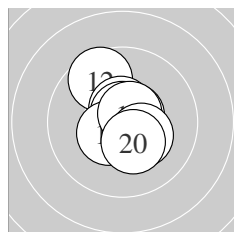

Serie 2:

10.6 *	9.6 ↖	10.6 *	10.6 *	10.7 *
10.6 *	10.5 *	10.6 *	10.3 *	10.3 *

beste Teiler 60.0 (15.) 78.1 (18.) 81.3 (11.)

Trefferlage 0.00 mm , 0.11 mm hoch

Streuwert 1.10, horizontal: 0.86, vertikal: 1.29

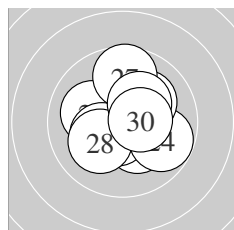

Serie 3:

10.3 *	10.6 *	10.1 ↖	9.8 →	10.3 *
10.1 ↗	9.7 ↑	10.1 ↙	10.3 *	10.5 *

beste Teiler 90.3 (22.) 125.0 (30.) 169.0 (21.)

Trefferlage 0.23 mm rechts, 0.11 mm hoch

Streuwert 1.54, horizontal: 1.57, vertikal: 1.52

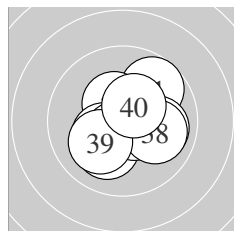

Serie 4:

9.7 ↗	10.4 *	10.3 *	10.0 →	10.6 *
10.1 ↙	10.6 *	10.0 →	10.1 ↙	10.4 *

beste Teiler 95.1 (37.) 97.0 (35.) 133.0 (40.)

Trefferlage 0.33 mm rechts, 0.23 mm tief

Streuwert 1.42, horizontal: 1.53, vertikal: 1.30

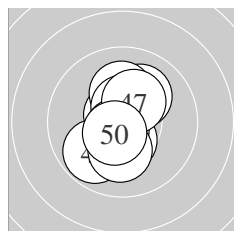

Serie 5:

10.1 ↗	10.4 *	10.7 *	10.1 ↑	10.5 *
10.7 *	10.3 *	9.8 ↙	10.2 *	10.6 *

beste Teiler 69.3 (43.) 69.6 (46.) 95.2 (50.)

Trefferlage 0.14 mm links, 0.01 mm hoch

Streuwert 1.24, horizontal: 0.84, vertikal: 1.53

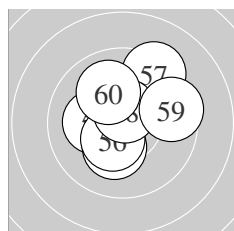

Serie 6:

10.5 *	10.5 *	10.2 *	9.8 ↗	10.2 *
10.4 *	9.3 ↗	10.6 *	9.5 →	10.0 ↖

beste Teiler 86.6 (58.) 107.1 (52.) 116.8 (51.)

Trefferlage 0.12 mm rechts, 0.62 mm hoch

Streuwert 1.68, horizontal: 1.74, vertikal: 1.61

ISSF AR Men – Wertung – **Männer**

StandNr: 140

Martz, Stephan #70811293

StartNr: 82

22. Januar 2019 11:50

SUI – ZH

Unterschrift des Schützen

Meyton Elektronik

Ergebnis:	613.2	(587)							
Serien:	101.9	101.8	98.9	103.2	102.9	104.5			
Zähler:	47	13	0	0	0	0	0	0	0
Innenzehner:	37								
weiteste:	444 (27), 401 (23), 345 (4)								
beste Teiler	34.9 (56.) 48.3 (55.) 51.6 (59.)								
Trefferlage	0.73 mm links, 0.74 mm hoch								
Streuwert	1.25, horizontal: 1.36, vertikal: 1.12								

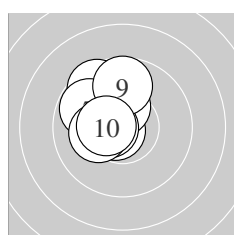
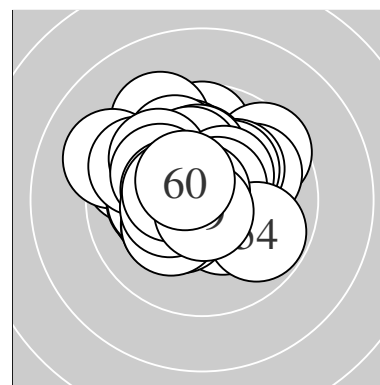

Serie 1:

10.7 *	10.4 *	10.3 *	9.6 ↘	10.2 *
10.5 *	9.8 ↘	10.2 *	9.7 ↑	10.5 *
beste Teiler	58.6 (1.) 105.1 (6.) 123.4 (10.)			
Trefferlage	1.22 mm links, 0.99 mm hoch			
Streuwert	1.05, horizontal: 0.81, vertikal: 1.25			

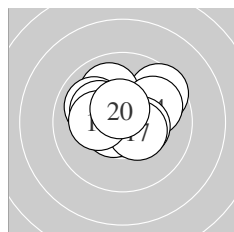

Serie 2:

9.6 ↗	10.0 ↘	10.0 ↘	9.9 ↗	10.6 *
10.4 *	10.4 *	10.2 *	10.2 *	10.5 *
beste Teiler	78.5 (15.) 102.1 (20.) 127.1 (17.)			
Trefferlage	0.01 mm links, 0.74 mm hoch			
Streuwert	1.44, horizontal: 1.76, vertikal: 1.02			

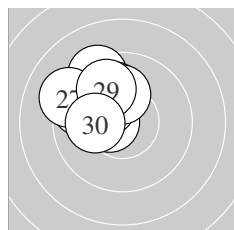

Serie 3:

10.6 *	10.3 *	9.3 ↘	10.0 ↑	9.6 ↘
9.9 ↘	9.2 ↘	10.1 ↑	9.8 ↘	10.1 ←
beste Teiler	97.0 (21.) 173.3 (22.) 207.1 (30.)			
Trefferlage	1.77 mm links, 1.54 mm hoch			
Streuwert	1.16, horizontal: 1.18, vertikal: 1.13			

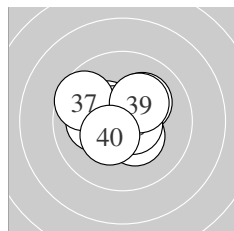

Serie 4:

10.1 ←	10.4 *	10.1 ↗	10.4 *	10.7 *
10.7 *	9.6 ↘	10.6 *	10.2 *	10.4 *
beste Teiler	55.7 (36.) 71.8 (35.) 80.3 (38.)			
Trefferlage	0.27 mm links, 0.28 mm hoch			
Streuwert	1.26, horizontal: 1.49, vertikal: 0.98			

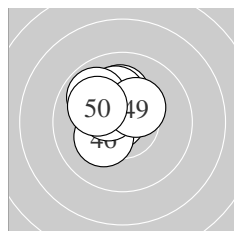

Serie 5:

10.1 ↑	10.5 *	10.5 *	10.7 *	10.1 ↑
10.2 *	10.4 *	9.9 ↘	10.4 *	10.1 ↘
beste Teiler	54.0 (44.) 101.4 (42.) 121.1 (43.)			
Trefferlage	0.73 mm links, 0.99 mm hoch			
Streuwert	0.94, horizontal: 0.91, vertikal: 0.96			

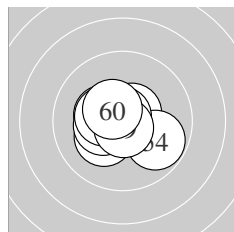

Serie 6:

10.2 *	10.6 *	10.3 *	9.8 ↘	10.8 *
10.8 *	10.4 *	10.4 *	10.7 *	10.5 *
beste Teiler	34.9 (56.) 48.3 (55.) 51.6 (59.)			
Trefferlage	0.37 mm links, 0.07 mm tief			
Streuwert	1.04, horizontal: 1.25, vertikal: 0.77			

Meyton Elektronik

ISSF AR Men – Wertung – **Männer**

StandNr: 141

Weithaler, Simon #19

StartNr: 83

22. Januar 2019 11:36

T – SG Thaur

Unterschrift des Schützen

Meyton Elektronik

Ergebnis:	612.5	(586)							
Serien:	101.6	101.7	101.3	101.4	101.8	104.7			
Zähler:	46	14	0	0	0	0	0	0	0
Innenzehner:	35								
weiteste:	372	(15),	368	(26),	360	(42)			
beste Teiler	21.0	(52.)	39.8	(50.)	41.1	(45.)			
Trefferlage	0.02	mm	rechts,	0.67	mm	hoch			
Streuwert	1.39,	horizontal:	1.40,	vertikal:	1.38				

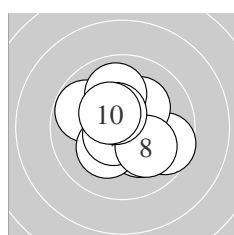
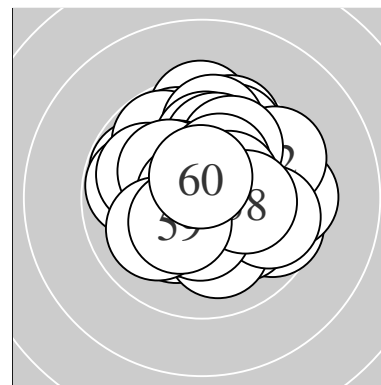

Serie 1:

9.8 ↖	9.6 ↘	10.2 *	10.2 *	10.0 ↑
10.2 *	10.6 *	10.1 ↘	10.5 *	10.4 *
beste Teiler	83.8	(7.)	110.9	(9.)
Trefferlage	0.08	mm	rechts,	0.10
Streuwert	1.56,	horizontal:	1.68,	vertikal:
			1.44	

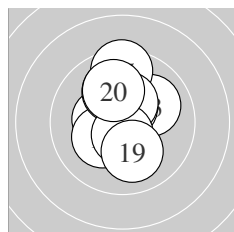

Serie 2:

10.4 *	10.2 *	10.0 ↗	10.0 ↑	9.5 ↑
10.5 *	10.4 *	10.6 *	10.1 ↓	10.0 ↑
beste Teiler	90.0	(18.)	110.8	(16.)
Trefferlage	0.10	mm	links,	0.80
Streuwert	1.45,	horizontal:	1.03,	vertikal:
			1.78	

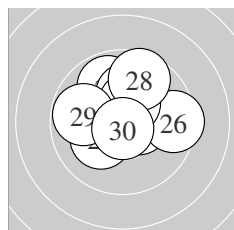

Serie 3:

9.8 ↖	10.2 *	10.6 *	10.5 *	10.1 ↑
9.5 →	10.4 *	9.6 ↑	9.8 ←	10.8 *
beste Teiler	47.0	(30.)	82.7	(23.)
Trefferlage	0.10	mm	rechts,	0.86
Streuwert	1.59,	horizontal:	1.77,	vertikal:
			1.38	

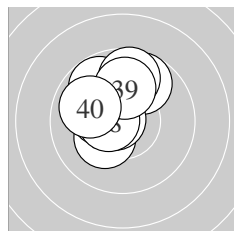

Serie 4:

10.5 *	10.3 *	9.8 ↖	10.3 *	9.7 ↑
10.7 *	9.7 ↑	10.5 *	10.0 ↑	9.9 ↖
beste Teiler	57.4	(36.)	101.0	(38.)
Trefferlage	0.71	mm	links,	1.21
Streuwert	1.27,	horizontal:	1.11,	vertikal:
			1.40	

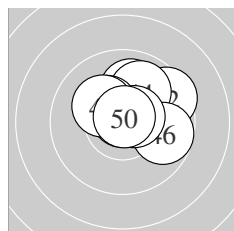

Serie 5:

10.0 ↑	9.5 ↗	10.0 ↑	9.9 ↑	10.8 *
9.7 →	10.6 *	10.3 *	10.2 *	10.8 *
beste Teiler	39.8	(50.)	41.1	(45.)
Trefferlage	0.72	mm	rechts,	1.10
Streuwert	1.28,	horizontal:	1.49,	vertikal:
			1.02	

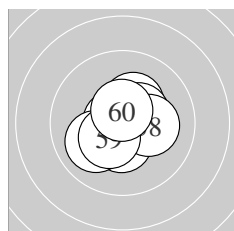

Serie 6:

10.7 *	10.9 *	10.4 *	10.3 *	10.4 *
10.0 ↙	10.8 *	10.2 *	10.4 *	10.6 *
beste Teiler	21.0	(52.)	46.0	(57.)
Trefferlage	0.05	mm	rechts,	0.03
Streuwert	1.02,	horizontal:	1.09,	vertikal:
			0.95	

Meyton Elektronik

ISSF AR Men – Wertung – **Männer**

StandNr: 142

Walder, Markus #150

StartNr: 84

22. Januar 2019 11:30

T – SG Innervillgraten

Unterschrift des Schützen

Meyton Elektronik