

Ergebnis: **0.0** (0)_{DNS}
Serien:
Zähler: 0 0 0 0 0 0 0 0 0 0
Innenzehner: 0
weiteste:
beste Teiler – Schütze ist nicht zum Wettkampf angetreten
Trefferlage 0.00 mm , 0.00 mm
Streuwert
Unterschrift des Schützen

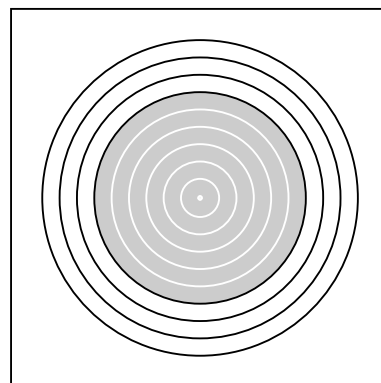

ISSF AR Men – Wertung – Männer

StandNr: 103

Armiraglio, Riccardo #309

StartNr: 3

9. Dezember 2018 10:15

TSN Busto Arsizio

Ergebnis: **0.0** (0)_{DNS}
Serien:
Zähler: 0 0 0 0 0 0 0 0 0 0
Innenzehner: 0
weiteste:
~~beste~~ Teiler – Schütze ist nicht zum Wettkampf angetreten
Trefferlage 0.00 mm , 0.00 mm
Streuwert
Unterschrift des Schützen

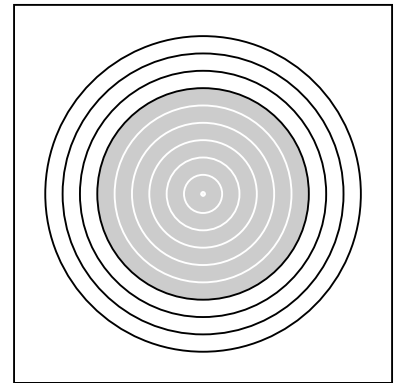

Meyton Elektronik

Ergebnis:	625.3	(600) ^{QF}
Serien:	103.7	104.3 104.4 105.0 103.3 104.6
Zähler:	60	0 0 0 0 0 0 0 0 0
Innenzehner:	53	
weiteste:	226 (30), 221 (8), 213 (44)	
beste Teiler	25.4 (21.)	55.0 (36.) 62.0 (57.)
Trefferlage	0.07 mm rechts, 0.10 mm tief	
Streuwert	1.00, horizontal: 1.14, vertikal: 0.85	

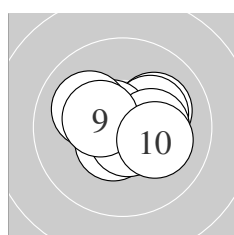
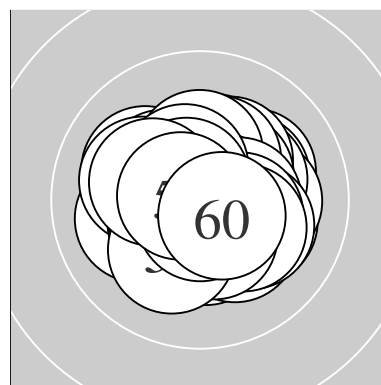

Serie 1:	10.1 ↗	10.7 *	10.5 *	10.2 *	10.6 *
	10.7 *	10.3 *	10.1 ↖	10.4 *	10.1 ↘
beste Teiler	62.6 (2.) 72.4 (6.) 86.0 (5.)				
Trefferlage	0.27 mm rechts, 0.09 mm hoch				
Streuwert	1.14, horizontal: 1.42, vertikal: 0.77				

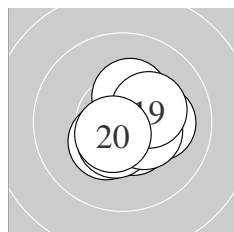

Serie 2:	10.5 *	10.1 →	10.7 *	10.4 *	10.3 *
	10.5 *	10.5 *	10.4 *	10.3 *	10.6 *
beste Teiler	64.0 (13.) 91.0 (20.) 103.3 (11.)				
Trefferlage	0.53 mm rechts, 0.28 mm tief				
Streuwert	0.91, horizontal: 0.96, vertikal: 0.85				

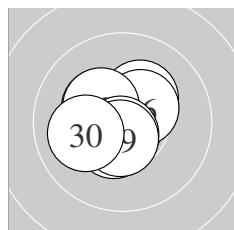

Serie 3:	10.9 *	10.5 *	10.4 *	10.3 *	10.3 *
	10.4 *	10.3 *	10.7 *	10.6 *	10.0 ←
beste Teiler	25.4 (21.) 72.9 (28.) 96.0 (29.)				
Trefferlage	0.23 mm links, 0.13 mm hoch				
Streuwert	1.03, horizontal: 1.11, vertikal: 0.95				

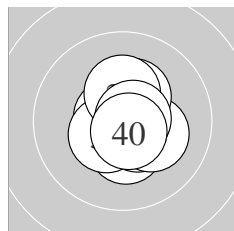

Serie 4:	10.4 *	10.7 *	10.5 *	10.2 *	10.5 *
	10.7 *	10.3 *	10.3 *	10.7 *	10.7 *
beste Teiler	55.0 (36.) 62.8 (39.) 68.0 (32.)				
Trefferlage	0.32 mm rechts, 0.08 mm tief				
Streuwert	0.88, horizontal: 0.75, vertikal: 1.00				

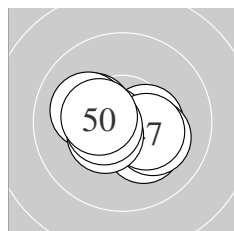

Serie 5:	10.2 *	10.4 *	10.2 *	10.1 ↖	10.2 *
	10.6 *	10.3 *	10.4 *	10.5 *	10.4 *
beste Teiler	77.2 (46.) 112.2 (49.) 127.8 (48.)				
Trefferlage	0.22 mm links, 0.24 mm tief				
Streuwert	1.15, horizontal: 1.48, vertikal: 0.67				

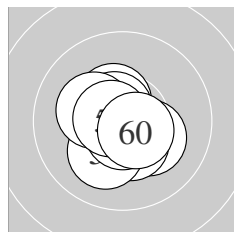

Serie 6:	10.2 *	10.5 *	10.4 *	10.6 *	10.1 ↙
	10.6 *	10.7 *	10.2 *	10.7 *	10.6 *
beste Teiler	62.0 (57.) 69.4 (59.) 80.8 (56.)				
Trefferlage	0.25 mm links, 0.27 mm tief				
Streuwert	0.94, horizontal: 0.95, vertikal: 0.93				

Meyton Elektronik

ISSF AR Men – Wertung – Männer

StandNr: 104

Nepejchal, Filip #230

StartNr: 4

9. Dezember 2018 9:32

CZE

QF – Schütze hat sich fürs Finale qualifiziert

Unterschrift des Schützen

Meyton Elektronik

Ergebnis:	624.8	(598) ^{QF}							
Serien:	104.0	104.5	104.7	104.5	103.0	104.1			
Zähler:	58	2	0	0	0	0	0	0	0
Innenzehner:	51								
weiteste:	304 (41), 273 (10), 237 (54)								
beste Teiler	4.2 (2.) 10.8 (22.) 38.0 (29.)								
Trefferlage	0.07 mm rechts, 0.03 mm hoch								
Streuwert	1.06, horizontal: 1.12, vertikal: 1.00								

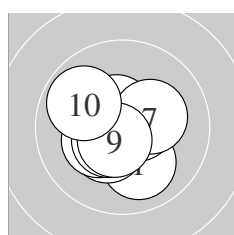
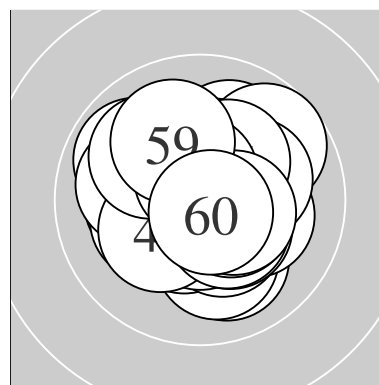

Serie 1:	10.0 ↘	10.9 *	10.4 *	10.6 *	10.6 *
	10.3 *	10.2 *	10.5 *	10.6 *	9.9 ↗
beste Teiler	4.2 (2.) 90.7 (9.) 92.1 (4.)				
Trefferlage	0.28 mm links, 0.23 mm tief				
Streuwert	1.14, horizontal: 1.21, vertikal: 1.07				

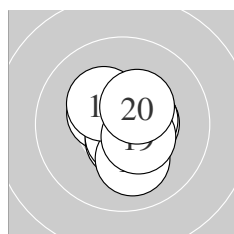

Serie 2:	10.4 *	10.6 *	10.5 *	10.7 *	10.5 *
	10.1 ↓	10.5 *	10.3 *	10.5 *	10.4 *
beste Teiler	73.0 (14.) 98.0 (12.) 110.6 (17.)				
Trefferlage	0.35 mm rechts, 0.12 mm tief				
Streuwert	0.95, horizontal: 0.89, vertikal: 1.01				

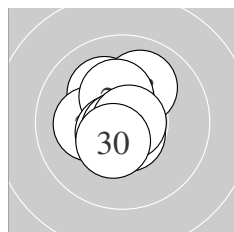

Serie 3:	10.1 ↖	10.9 *	10.0 ↗	10.2 *	10.3 *
	10.6 *	10.6 *	10.8 *	10.8 *	10.4 *
beste Teiler	10.8 (22.) 38.0 (29.) 49.2 (28.)				
Trefferlage	0.30 mm links, 0.21 mm hoch				
Streuwert	0.99, horizontal: 0.83, vertikal: 1.13				

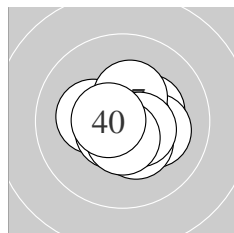

Serie 4:	10.3 *	10.2 *	10.4 *	10.2 *	10.7 *
	10.6 *	10.4 *	10.5 *	10.6 *	10.6 *
beste Teiler	64.0 (35.) 85.1 (40.) 87.6 (36.)				
Trefferlage	0.30 mm rechts, 0.14 mm tief				
Streuwert	0.98, horizontal: 1.12, vertikal: 0.80				

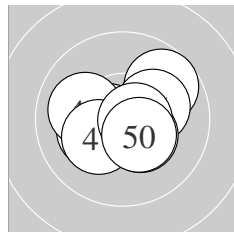

Serie 5:	9.7 ↗	10.2 *	10.6 *	10.6 *	10.2 *
	10.0 ↖	10.2 *	10.4 *	10.7 *	10.4 *
beste Teiler	75.3 (49.) 86.8 (43.) 97.8 (44.)				
Trefferlage	0.16 mm rechts, 0.07 mm tief				
Streuwert	1.32, horizontal: 1.60, vertikal: 0.95				

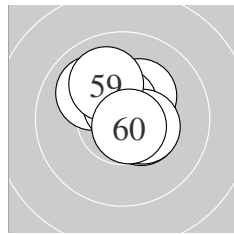

Serie 6:	10.6 *	10.5 *	10.3 *	10.0 ↖	10.7 *
	10.3 *	10.6 *	10.4 *	10.0 ↗	10.7 *
beste Teiler	59.5 (60.) 75.1 (55.) 86.1 (57.)				
Trefferlage	0.22 mm rechts, 0.59 mm hoch				
Streuwert	1.01, horizontal: 1.01, vertikal: 1.00				

Meyton Elektronik

ISSF AR Men – Wertung – Männer

StandNr: 105

Rumpler, Gernot #235

StartNr: 5

9. Dezember 2018 9:43

AUT

QF – Schütze hat sich fürs Finale qualifiziert

Unterschrift des Schützen

Meyton Elektronik

Ergebnis:	620.3	(593)
Serien:	104.3	102.9 103.4 101.8 104.4 103.5
Zähler:	53	7 0 0 0 0 0 0 0 0
Innenzehner:	49	
weiteste:	359	(32), 320 (15), 305 (33)
beste Teiler	13.4	(58.) 28.8 (9.) 45.0 (48.)
Trefferlage	0.11 mm links, 0.27 mm hoch	
Streuwert	1.20, horizontal: 1.26, vertikal: 1.13	

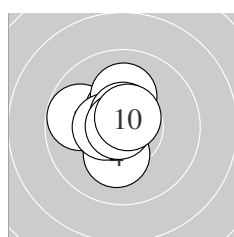
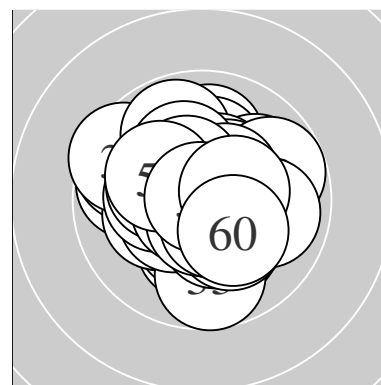

Serie 1:	10.5 *	10.6 *	9.8 ↖	10.2 *	10.5 *
	10.1 ↑	10.5 *	10.6 *	10.8 *	10.7 *
beste Teiler	28.8 (9.) 74.7 (10.) 79.0 (8.)				
Trefferlage	0.65 mm links, 0.33 mm hoch				
Streuwert	0.97, horizontal: 0.93, vertikal: 1.02				

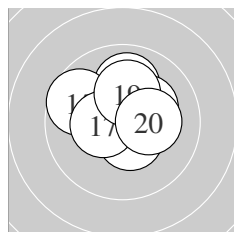

Serie 2:	10.6 *	10.0 ↑	10.5 *	10.5 *	9.7 ↖
	10.6 *	10.4 *	10.2 *	10.2 *	10.2 *
beste Teiler	89.0 (16.) 96.5 (11.) 102.6 (14.)				
Trefferlage	0.00 mm , 0.76 mm hoch				
Streuwert	1.21, horizontal: 1.39, vertikal: 1.01				

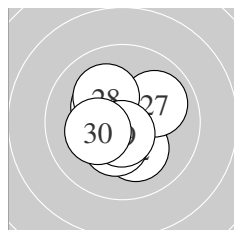

Serie 3:	10.6 *	10.2 *	10.3 *	10.4 *	10.6 *
	10.4 *	10.0 ↗	10.1 ↘	10.6 *	10.2 *
beste Teiler	79.2 (29.) 90.6 (25.) 99.7 (21.)				
Trefferlage	0.24 mm links, 0.04 mm tief				
Streuwert	1.19, horizontal: 1.18, vertikal: 1.21				

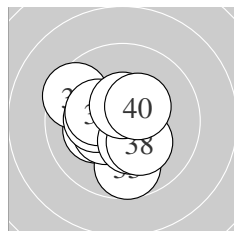

Serie 4:	10.2 *	9.5 ↖	9.7 ↓	10.4 *	10.2 *
	10.3 *	10.4 *	10.2 *	10.5 *	10.4 *
beste Teiler	106.0 (39.) 134.1 (34.) 142.8 (40.)				
Trefferlage	0.64 mm links, 0.26 mm tief				
Streuwert	1.44, horizontal: 1.45, vertikal: 1.44				

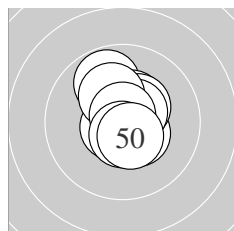

Serie 5:	10.5 *	10.7 *	9.8 ↖	10.4 *	10.4 *
	10.5 *	10.2 *	10.8 *	10.6 *	10.5 *
beste Teiler	45.0 (48.) 72.4 (42.) 84.0 (49.)				
Trefferlage	0.14 mm rechts, 0.49 mm hoch				
Streuwert	1.01, horizontal: 0.75, vertikal: 1.21				

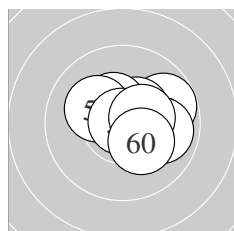

Serie 6:	10.7 *	9.8 ↗	10.5 *	10.5 *	10.4 *
	9.9 →	10.2 *	10.9 *	10.4 *	10.2 *
beste Teiler	13.4 (58.) 74.7 (51.) 120.8 (53.)				
Trefferlage	0.72 mm rechts, 0.38 mm hoch				
Streuwert	1.13, horizontal: 1.41, vertikal: 0.77				

Meyton Elektronik

ISSF AR Men – Wertung – Männer

StandNr: 106

Eberlberger, Florian #308

StartNr: 6

9. Dezember 2018 9:37

ASKÖ Bad Goisern

Unterschrift des Schützen

Meyton Elektronik

Ergebnis:	594.8	(567)
Serien:	99.4 97.7 100.0 100.3 99.6 97.8	
Zähler:	31 25 4 0 0 0 0 0 0 0	
Innenzehner:	19	
weiteste:	748 (13), 595 (58), 587 (59)	
beste Teiler	20.0 (8.) 44.2 (32.) 48.0 (12.)	
Trefferlage	0.40 mm rechts, 0.53 mm hoch	
Streuwert	2.06, horizontal: 2.40, vertikal: 1.67	

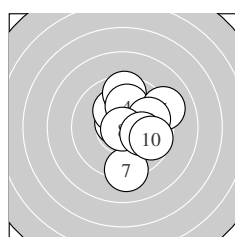
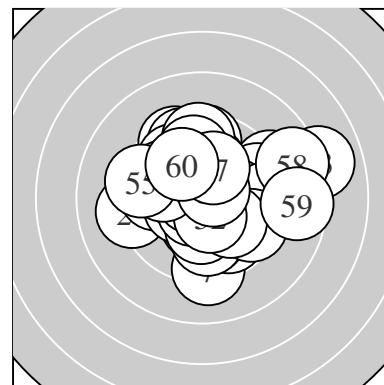

Serie 1:	10.7 *	10.2 *	9.6 ↑	10.1 ↑	9.1 ↗
	9.8 ↗	9.2 ↓	10.9 *	10.1 ↘	9.7 ↘
beste Teiler	20.0 (8.)	75.4 (1.)	187.8 (2.)		
Trefferlage	1.13 mm rechts, 0.41 mm hoch				
Streuwert	1.96, horizontal: 1.69, vertikal: 2.20				

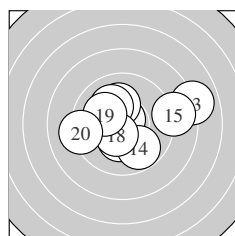

Serie 2:	10.3 *	10.8 *	8.0 ↗	9.8 ↘	8.8 →
	10.1 ↑	10.1 ↘	10.5 *	10.1 ↖	9.2 ←
beste Teiler	48.0 (12.)	123.8 (18.)	164.1 (11.)		
Trefferlage	0.55 mm rechts, 0.25 mm hoch				
Streuwert	2.65, horizontal: 3.37, vertikal: 1.63				

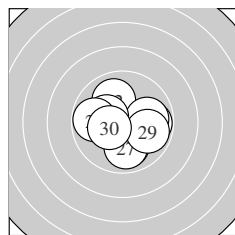

Serie 3:	9.8 ↗	10.0 ↘	10.0 ←	9.9 →	10.0 ↓
	10.3 *	9.9 ↓	9.8 ←	9.9 ↘	10.4 *
beste Teiler	147.4 (30.)	173.2 (26.)	238.1 (23.)		
Trefferlage	0.04 mm links, 0.30 mm tief				
Streuwert	1.80, horizontal: 2.12, vertikal: 1.42				

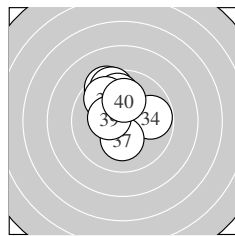

Serie 4:	9.4 ↘	10.8 *	10.3 *	9.8 →	9.6 ↑
	9.9 ↑	10.2 *	9.8 ↘	10.4 *	10.1 ↑
beste Teiler	44.2 (32.)	139.9 (39.)	154.5 (33.)		
Trefferlage	0.45 mm links, 1.44 mm hoch				
Streuwert	1.50, horizontal: 1.34, vertikal: 1.64				

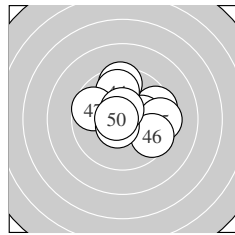

Serie 5:	9.5 ↗	10.2 *	9.5 ↑	9.8 ↑	9.4 →
	9.6 ↘	9.7 ↖	10.6 *	10.6 *	10.7 *
beste Teiler	63.2 (50.)	90.8 (48.)	97.1 (49.)		
Trefferlage	0.72 mm rechts, 0.73 mm hoch				
Streuwert	1.93, horizontal: 2.22, vertikal: 1.58				

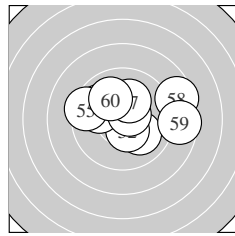

Serie 6:	10.0 ↘	10.5 *	9.9 ↘	10.0 ↖	9.4 ←
	10.6 *	10.2 *	8.6 ↗	8.6 →	10.0 ↘
beste Teiler	84.0 (56.)	124.4 (52.)	197.4 (57.)		
Trefferlage	0.53 mm rechts, 0.66 mm hoch				
Streuwert	2.45, horizontal: 3.23, vertikal: 1.28				

Meyton Elektronik

ISSF AR Men – Wertung – **Männer**
StandNr: 107
Schöfbeck, Marcel #79

StartNr: 7
9. Dezember 2018 9:24
T – SG Walchsee

Unterschrift des Schützen

Meyton Elektronik

Ergebnis:	623.4	(595) ^{QF}
Serien:	104.4	103.6 103.9 105.0 102.6 103.9
Zähler:	55	5 0 0 0 0 0 0 0 0
Innenzehner:	49	
weiteste:	351	(25), 317 (41), 279 (40)
beste Teiler	33.2	(53.) 44.0 (22.) 47.1 (37.)
Trefferlage	0.00 mm , 0.13 mm tief	
Streuwert	1.11, horizontal: 0.94, vertikal: 1.25	

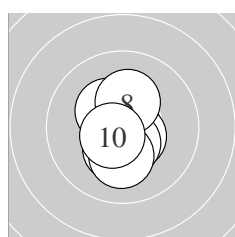
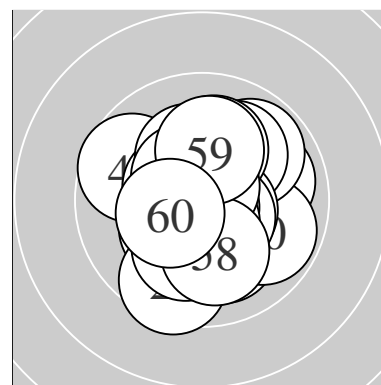

Serie 1:	10.3 *	10.3 *	10.6 *	10.5 *	10.7 *
	10.5 *	10.5 *	10.2 *	10.2 *	10.6 *
beste Teiler	75.0 (5.) 91.6 (10.) 99.4 (3.)				
Trefferlage	0.11 mm links, 0.58 mm tief				
Streuwert	0.90, horizontal: 0.54, vertikal: 1.15				

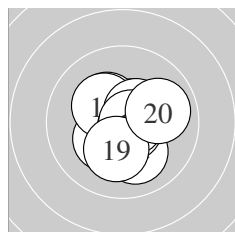

Serie 2:	10.6 *	10.3 *	10.3 *	10.1 ↘	10.3 *
	10.7 *	10.5 *	10.7 *	10.2 *	9.9 →
beste Teiler	60.0 (18.) 64.5 (16.) 95.7 (11.)				
Trefferlage	0.19 mm rechts, 0.08 mm tief				
Streuwert	1.20, horizontal: 1.18, vertikal: 1.21				

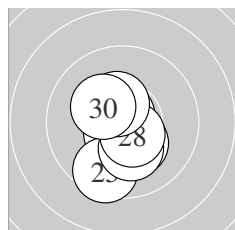

Serie 3:	10.7 *	10.8 *	10.6 *	10.6 *	9.5 ↘
	10.3 *	10.2 *	10.5 *	10.4 *	10.3 *
beste Teiler	44.0 (22.) 66.4 (21.) 91.7 (24.)				
Trefferlage	0.21 mm links, 0.62 mm tief				
Streuwert	1.12, horizontal: 0.76, vertikal: 1.39				

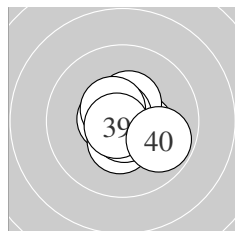

Serie 4:	10.4 *	10.7 *	10.6 *	10.4 *	10.7 *
	10.4 *	10.8 *	10.5 *	10.7 *	9.8 ↘
beste Teiler	47.1 (37.) 51.2 (39.) 53.5 (32.)				
Trefferlage	0.22 mm rechts, 0.18 mm tief				
Streuwert	0.93, horizontal: 1.01, vertikal: 0.84				

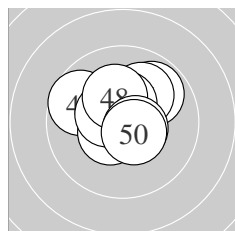

Serie 5:	9.7 ↙	10.5 *	10.5 *	10.4 *	9.8 ↗
	10.0 ↗	10.4 *	10.2 *	10.6 *	10.5 *
beste Teiler	97.9 (49.) 104.8 (50.) 110.7 (42.)				
Trefferlage	0.01 mm links, 0.82 mm hoch				
Streuwert	1.24, horizontal: 1.39, vertikal: 1.07				

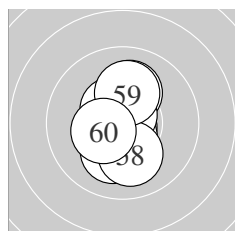

Serie 6:	10.1 ↘	10.5 *	10.8 *	10.1 ↑	10.5 *
	10.6 *	10.7 *	10.1 ↘	10.1 ↑	10.4 *
beste Teiler	33.2 (53.) 57.4 (57.) 96.0 (56.)				
Trefferlage	0.08 mm links, 0.12 mm tief				
Streuwert	1.14, horizontal: 0.60, vertikal: 1.49				

Meyton Elektronik

ISSF AR Men – Wertung – Männer

StandNr: 108

Schmirl, Alexander #232

StartNr: 8

9. Dezember 2018 9:42

AUT

QF – Schütze hat sich fürs Finale qualifiziert

Unterschrift des Schützen

Meyton Elektronik

Ergebnis: **624.7** (596)^{QF}
 Serien: 105.7 104.9 103.0 103.9 103.9 103.3
 Zähler: 56 4 0 0 0 0 0 0 0
 Innenzehner: 47
 weiteste: 369 (40), 323 (25), 275 (43)
 beste Teiler 2.0 (21.) 29.1 (33.) 45.1 (5.)
 Trefferlage 0.00 mm , 0.10 mm hoch
 Streuwert 1.10, horizontal: 1.17, vertikal: 1.02

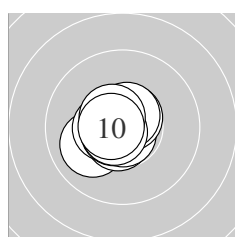
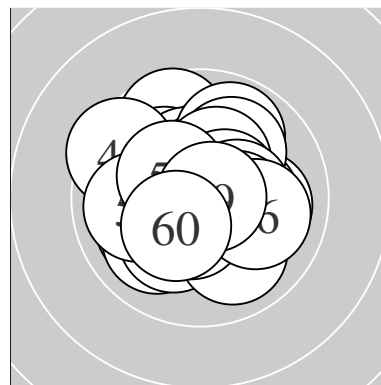

Serie 1:
 10.0 ↙ 10.6 * 10.5 * 10.7 * 10.8 *
 10.6 * 10.6 * 10.7 * 10.6 * 10.6 *
 beste Teiler 45.1 (5.) 65.5 (8.) 69.6 (4.)
 Trefferlage 0.53 mm links, 0.09 mm tief
 Streuwert 0.69, horizontal: 0.73, vertikal: 0.64

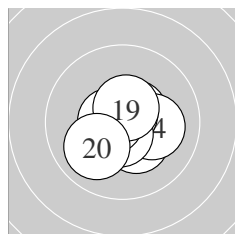

Serie 2:
 10.6 * 10.7 * 10.3 * 10.1 → 10.7 *
 10.7 * 10.6 * 10.6 * 10.6 * 10.0 ↙
 beste Teiler 53.0 (12.) 55.2 (15.) 55.7 (16.)
 Trefferlage 0.05 mm rechts, 0.25 mm tief
 Streuwert 0.94, horizontal: 1.03, vertikal: 0.83

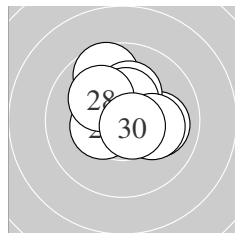

Serie 3:
 10.9 * 10.6 * 10.4 * 10.0 → 9.7 ↗
 10.2 * 10.4 * 10.1 ↘ 10.1 → 10.6 *
 beste Teiler 2.0 (21.) 77.1 (30.) 93.6 (22.)
 Trefferlage 0.11 mm rechts, 0.67 mm hoch
 Streuwert 1.25, horizontal: 1.31, vertikal: 1.19

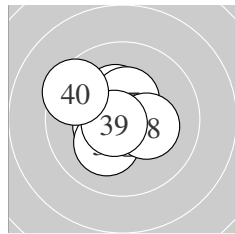

Serie 4:
 10.5 * 10.2 * 10.8 * 10.8 * 10.4 *
 10.3 * 10.4 * 10.3 * 10.7 * 9.5 ↘
 beste Teiler 29.1 (33.) 45.8 (34.) 63.9 (39.)
 Trefferlage 0.49 mm links, 0.25 mm hoch
 Streuwert 1.19, horizontal: 1.28, vertikal: 1.09

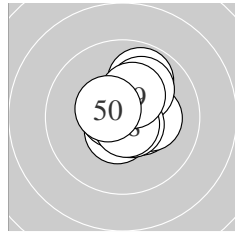

Serie 5:
 10.6 * 10.4 * 9.9 ↗ 10.7 * 10.2 *
 10.0 ↗ 10.6 * 10.7 * 10.3 * 10.5 *
 beste Teiler 55.4 (48.) 63.0 (44.) 77.2 (47.)
 Trefferlage 0.50 mm rechts, 0.41 mm hoch
 Streuwert 1.04, horizontal: 0.92, vertikal: 1.15

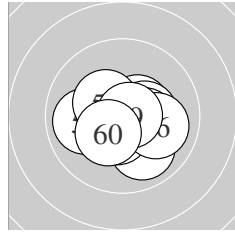

Serie 6:
 10.5 * 10.4 * 10.4 * 10.0 ↘ 10.5 *
 10.0 → 9.9 ← 10.4 * 10.8 * 10.4 *
 beste Teiler 46.1 (59.) 113.2 (55.) 114.1 (51.)
 Trefferlage 0.29 mm rechts, 0.40 mm tief
 Streuwert 1.23, horizontal: 1.50, vertikal: 0.88

Meyton Elektronik

ISSF AR Men – Wertung – Männer

StandNr: 109

Nymbursky, Petr #234

StartNr: 9

9. Dezember 2018 9:34

CZE

QF – Schütze hat sich fürs Finale qualifiziert

Unterschrift des Schützen

Meyton Elektronik

Ergebnis:	584.1	(560)
Serien:	95.2 99.0 97.2 98.3 98.2 96.2	
Zähler:	27 27 5 1 0 0 0 0 0 0	
Innenzehner:	20	
weiteste:	799 (59), 733 (23), 642 (7)	
beste Teiler	3.6 (55.) 39.0 (9.) 64.8 (26.)	
Trefferlage	0.30 mm links, 0.22 mm hoch	
Streuwert	2.47, horizontal: 2.95, vertikal: 1.88	

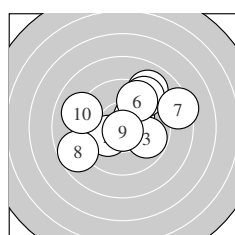
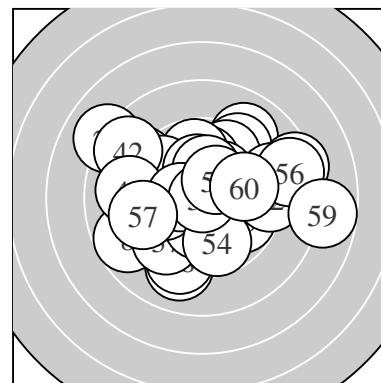

Serie 1:	10.3 *	10.2 *	9.8 ↘	9.0 ↗	9.3 ↗
	9.6 ↗	8.4 →	8.7 ↙	10.8 *	9.1 ↖
beste Teiler	39.0 (9.)	167.1 (1.)	186.9 (2.)		
Trefferlage	0.56 mm rechts, 0.98 mm hoch				
Streuwert	2.86, horizontal: 3.40, vertikal: 2.18				

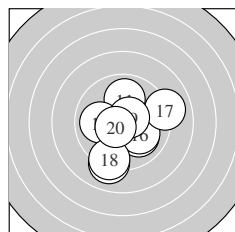

Serie 2:	9.9 ↑	10.5 *	10.0 ↘	10.0 ←	9.1 ↓
	10.1 ↘	9.0 →	9.2 ↓	10.6 *	10.6 *
beste Teiler	86.0 (19.)	93.4 (20.)	114.9 (12.)		
Trefferlage	0.22 mm rechts, 0.84 mm tief				
Streuwert	2.14, horizontal: 2.10, vertikal: 2.19				

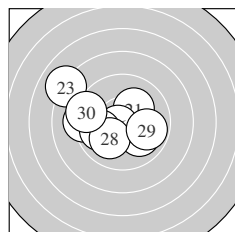

Serie 3:	10.2 *	10.1 ↙	8.0 ↖	10.0 ↘	9.2 ←
	10.7 *	9.9 ←	10.0 ↗	9.8 →	9.3 ←
beste Teiler	64.8 (26.)	193.3 (21.)	207.6 (22.)		
Trefferlage	1.48 mm links, 0.00 mm				
Streuwert	2.37, horizontal: 2.86, vertikal: 1.74				

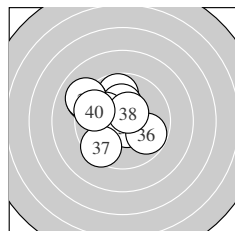

Serie 4:	9.8 ↑	9.1 ↖	10.2 *	10.1 ↖	10.6 *
	9.8 ↘	9.5 ↗	10.5 *	9.1 ↖	9.6 ↖
beste Teiler	80.8 (35.)	110.3 (38.)	182.3 (33.)		
Trefferlage	1.22 mm links, 0.77 mm hoch				
Streuwert	2.02, horizontal: 2.18, vertikal: 1.84				

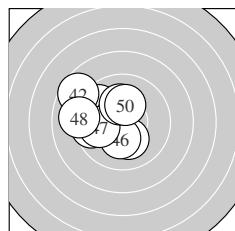

Serie 5:	9.7 ↖	8.6 ↖	9.6 ←	10.6 *	10.2 *
	10.2 *	9.9 ←	9.0 ←	10.2 *	10.2 *
beste Teiler	93.5 (44.)	179.8 (46.)	189.2 (50.)		
Trefferlage	1.85 mm links, 0.51 mm hoch				
Streuwert	1.88, horizontal: 2.06, vertikal: 1.69				

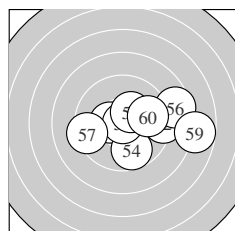

Serie 6:	10.4 *	9.2 →	10.2 *	9.7 ↓	10.9 *
	8.5 →	9.3 ←	10.4 *	7.8 →	9.8 →
beste Teiler	3.6 (55.)	140.0 (51.)	149.8 (58.)		
Trefferlage	1.94 mm rechts, 0.07 mm tief				
Streuwert	2.63, horizontal: 3.47, vertikal: 1.32				

ISSF AR Men – Wertung – Männer

StandNr: 110

Mattle, Michael #221

StartNr: 10

9. Dezember 2018 9:47

Liechtenstein

Unterschrift des Schützen

Meyton Elektronik

Ergebnis: **621.4** (592)
 Serien: 104.5 104.1 105.5 101.8 102.6 102.9
 Zähler: 52 8 0 0 0 0 0 0 0
 Innenzehner: 46
 weiteste: 441 (43), 338 (33), 324 (59)
 beste Teiler 1.0 (36.) 52.2 (28.) 55.8 (23.)
 Trefferlage 0.48 mm rechts, 0.07 mm hoch
 Streuwert 1.17, horizontal: 1.17, vertikal: 1.17

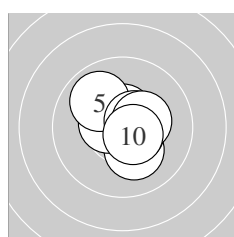
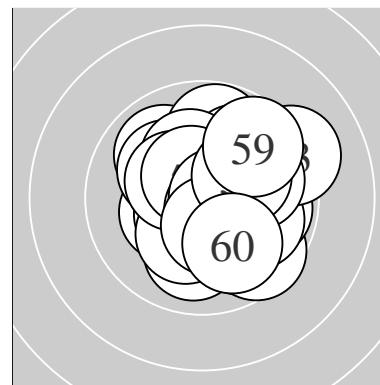

Serie 1:
 10.6 * 10.6 * 10.2 * 10.5 * 9.9 ↘
 10.6 * 10.5 * 10.6 * 10.4 * 10.6 *
 beste Teiler 82.2 (1.) 95.4 (10.) 96.6 (6.)
 Trefferlage 0.26 mm rechts, 0.25 mm hoch
 Streuwert 1.01, horizontal: 1.04, vertikal: 0.97

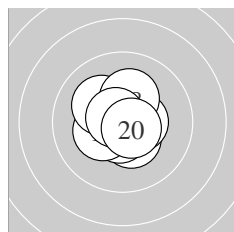

Serie 2:
 10.4 * 10.4 * 10.6 * 10.3 * 10.5 *
 10.3 * 10.1 ↘ 10.2 * 10.7 * 10.6 *
 beste Teiler 62.1 (19.) 79.0 (20.) 84.8 (13.)
 Trefferlage 0.19 mm links, 0.26 mm hoch
 Streuwert 1.01, horizontal: 0.99, vertikal: 1.04

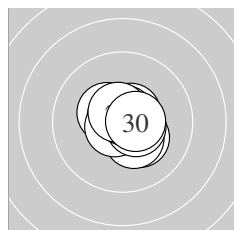

Serie 3:
 10.3 * 10.4 * 10.7 * 10.6 * 10.4 *
 10.7 * 10.5 * 10.7 * 10.6 * 10.6 *
 beste Teiler 52.2 (28.) 55.8 (23.) 68.6 (26.)
 Trefferlage 0.23 mm rechts, 0.00 mm
 Streuwert 0.78, horizontal: 0.82, vertikal: 0.74

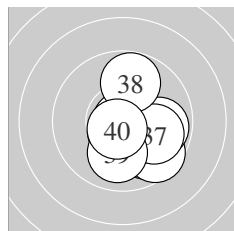

Serie 4:
 10.6 * 9.9 ↘ 9.6 ↘ 10.5 * 9.9 →
 10.9 * 9.9 ↘ 9.8 ↑ 10.0 ↓ 10.7 *
 beste Teiler 1.0 (36.) 72.6 (40.) 88.5 (31.)
 Trefferlage 0.95 mm rechts, 0.74 mm tief
 Streuwert 1.40, horizontal: 1.26, vertikal: 1.52

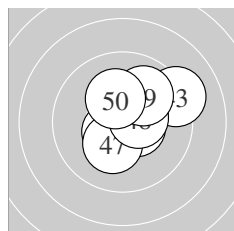

Serie 5:
 10.5 * 10.5 * 9.2 ↗ 10.4 * 10.6 *
 10.5 * 10.2 * 10.5 * 10.0 ↗ 10.2 *
 beste Teiler 78.7 (45.) 104.4 (46.) 109.0 (42.)
 Trefferlage 0.76 mm rechts, 0.46 mm hoch
 Streuwert 1.33, horizontal: 1.42, vertikal: 1.23

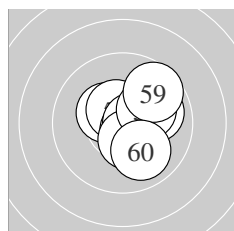

Serie 6:
 10.4 * 10.4 * 10.5 * 10.0 → 10.7 *
 10.7 * 10.4 * 10.1 ↗ 9.7 ↗ 10.0 ↘
 beste Teiler 75.0 (56.) 75.6 (55.) 110.4 (53.)
 Trefferlage 0.92 mm rechts, 0.23 mm hoch
 Streuwert 1.21, horizontal: 1.16, vertikal: 1.25

Meyton Elektronik

ISSF AR Men – Wertung – Männer

StandNr: 111

Höllwarth, Michael #102

StartNr: 11

9. Dezember 2018 9:45

AUT

Unterschrift des Schützen

Meyton Elektronik

Ergebnis: **617.4** (589)
 Serien: 103.7 102.5 103.5 102.9 102.1 102.7
 Zähler: 49 11 0 0 0 0 0 0 0
 Innenzehner: 35
 weiteste: 333 (45), 333 (57), 324 (52)
 beste Teiler 17.2 (46.) 28.6 (2.) 28.6 (24.)
 Trefferlage 0.03 mm rechts, 0.37 mm hoch
 Streuwert 1.32, horizontal: 1.30, vertikal: 1.34

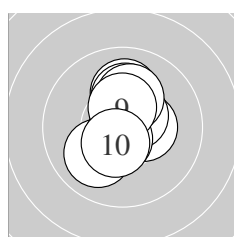
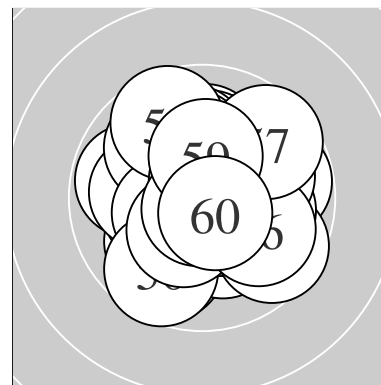

Serie 1:
 10.1 ↑ 10.8 * 10.0 ↙ 10.2 * 10.4 *
 10.5 * 10.2 * 10.6 * 10.4 * 10.5 *
 beste Teiler 28.6 (2.) 81.9 (8.) 107.4 (6.)
 Trefferlage 0.04 mm rechts, 0.43 mm hoch
 Streuwert 1.13, horizontal: 0.79, vertikal: 1.40

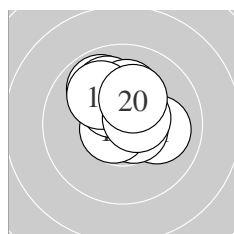

Serie 2:
 10.0 → 10.6 * 10.7 * 9.9 ↘ 10.4 *
 10.0 ↘ 10.1 ↑ 10.0 ↘ 10.6 * 10.2 *
 beste Teiler 65.7 (13.) 80.6 (12.) 99.9 (19.)
 Trefferlage 0.02 mm links, 1.08 mm hoch
 Streuwert 1.16, horizontal: 1.19, vertikal: 1.12

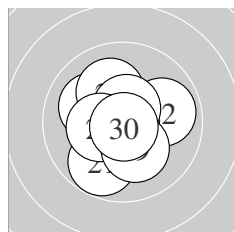

Serie 3:
 9.8 ↙ 9.9 → 10.1 ↘ 10.8 * 10.1 ↘
 10.8 * 10.6 * 10.4 * 10.2 * 10.8 *
 beste Teiler 28.6 (24.) 31.0 (26.) 32.0 (30.)
 Trefferlage 0.16 mm links, 0.10 mm tief
 Streuwert 1.32, horizontal: 1.31, vertikal: 1.33

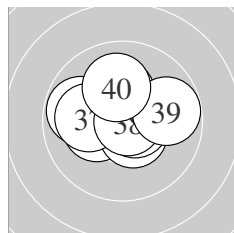

Serie 4:
 10.7 * 10.3 * 10.5 * 10.2 * 9.8 ←
 10.6 * 10.1 ← 10.8 * 9.8 → 10.1 ↑
 beste Teiler 36.1 (38.) 67.2 (31.) 83.7 (36.)
 Trefferlage 0.19 mm links, 0.36 mm hoch
 Streuwert 1.37, horizontal: 1.66, vertikal: 0.99

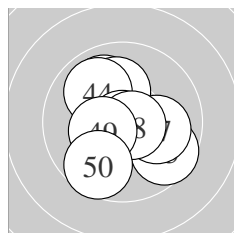

Serie 5:
 10.8 * 10.0 ↘ 10.1 ↑ 9.9 ↘ 9.6 ↘
 10.9 * 10.0 → 10.7 * 10.4 * 9.7 ↙
 beste Teiler 17.2 (46.) 29.0 (41.) 63.5 (48.)
 Trefferlage 0.03 mm links, 0.01 mm tief
 Streuwert 1.61, horizontal: 1.55, vertikal: 1.66

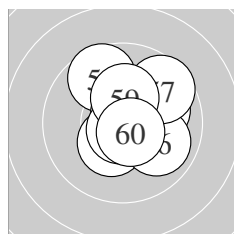

Serie 6:
 10.7 * 9.7 ↘ 10.7 * 10.0 → 10.4 *
 9.9 ↘ 9.6 ↗ 10.8 * 10.3 * 10.6 *
 beste Teiler 46.1 (58.) 63.3 (51.) 68.6 (53.)
 Trefferlage 0.61 mm rechts, 0.45 mm hoch
 Streuwert 1.39, horizontal: 1.31, vertikal: 1.46

Meyton Elektronik

ISSF AR Men – Wertung – **Männer**

StandNr: 112

Kostenzer, Thomas #18

StartNr: 12

9. Dezember 2018 9:47

T – SG Münster

Unterschrift des Schützen

Meyton Elektronik

Ergebnis:	626.2	(597) ^{QF}						
Serien:	104.8	105.0	103.5	104.0	105.1	103.8		
Zähler:	57	3	0	0	0	0	0	0
Innenzehner:	51							
weiteste:	309 (31), 271 (27), 262 (51)							
beste Teiler	4.2 (10.)	16.7 (45.)	21.2 (15.)					
Trefferlage	0.03 mm links, 0.11 mm hoch							
Streuwert	1.04, horizontal: 0.95, vertikal: 1.11							

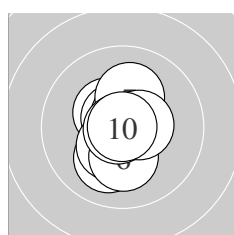
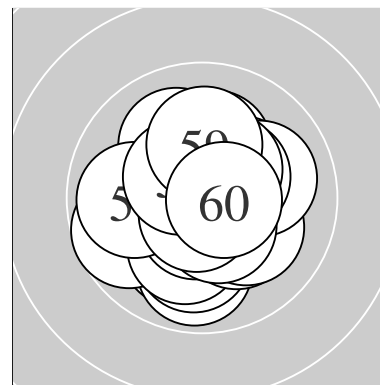

Serie 1:

10.4 *	10.7 *	10.6 *	10.1 ✓	10.4 *
10.2 *	10.2 *	10.8 *	10.5 *	10.9 *
beste Teiler	4.2 (10.)	32.6 (8.)	75.0 (2.)	
Trefferlage	0.16 mm links, 0.08 mm tief			
Streuwert	1.01, horizontal: 0.65, vertikal: 1.27			

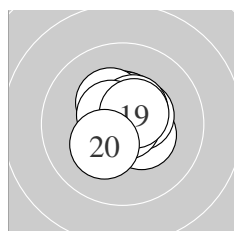

Serie 2:

10.5 *	10.4 *	10.5 *	10.5 *	10.9 *
10.3 *	10.5 *	10.6 *	10.5 *	10.3 *
beste Teiler	21.2 (15.)	93.8 (18.)	101.1 (19.)	
Trefferlage	0.14 mm rechts, 0.44 mm hoch			
Streuwert	0.85, horizontal: 0.82, vertikal: 0.87			

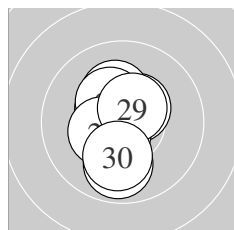

Serie 3:

10.4 *	10.6 *	10.5 *	10.6 *	10.2 *
10.3 *	9.9 ↓	10.4 *	10.5 *	10.1 ↓
beste Teiler	89.5 (24.)	91.2 (22.)	110.9 (29.)	
Trefferlage	0.26 mm links, 0.02 mm hoch			
Streuwert	1.18, horizontal: 0.68, vertikal: 1.53			

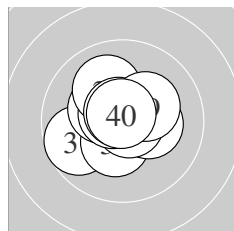

Serie 4:

9.7 ←	10.4 *	10.3 *	10.3 *	10.8 *
10.6 *	10.1 ↖	10.7 *	10.3 *	10.8 *
beste Teiler	44.9 (35.)	48.8 (40.)	63.9 (38.)	
Trefferlage	0.30 mm links, 0.23 mm hoch			
Streuwert	1.18, horizontal: 1.32, vertikal: 1.01			

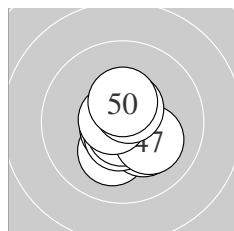

Serie 5:

10.2 *	10.7 *	10.2 *	10.6 *	10.9 *
10.7 *	10.1 ↘	10.7 *	10.6 *	10.4 *
beste Teiler	16.7 (45.)	60.2 (46.)	63.7 (48.)	
Trefferlage	0.14 mm rechts, 0.40 mm tief			
Streuwert	0.90, horizontal: 0.81, vertikal: 0.98			

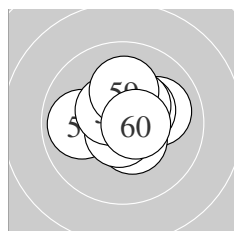

Serie 6:

9.9 ←	10.0 →	10.4 *	10.5 *	10.7 *
10.7 *	10.5 *	10.4 *	10.1 ↑	10.6 *
beste Teiler	65.4 (55.)	69.0 (56.)	85.3 (60.)	
Trefferlage	0.22 mm rechts, 0.44 mm hoch			
Streuwert	1.12, horizontal: 1.30, vertikal: 0.91			

ISSF AR Men – Wertung – Männer

StandNr: 113

Pickl, Bernhard #228

StartNr: 13

9. Dezember 2018 9:35

AUT

QF – Schütze hat sich fürs Finale qualifiziert

Unterschrift des Schützen

Meyton Elektronik

Ergebnis:	625.6	(595) ^{QF}
Serien:	104.7	105.8 105.3 103.7 103.6 102.5
Zähler:	55	5 0 0 0 0 0 0 0 0
Innenzehner:	51	
weiteste:	276	(55), 276 (60), 274 (51)
beste Teiler	7.8	(8.) 23.4 (15.) 33.5 (48.)
Trefferlage	0.09	mm rechts, 0.01 mm tief
Streuwert	1.05,	horizontal: 1.13, vertikal: 0.96

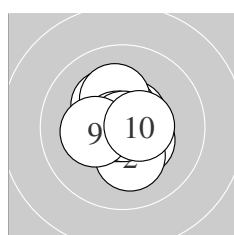
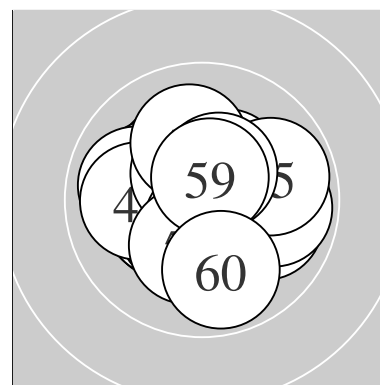

Serie 1:	10.4 *	10.2 *	10.6 *	10.6 *	10.3 *
	10.2 *	10.8 *	10.9 *	10.2 *	10.5 *
beste Teiler	7.8	(8.) 35.3	(7.) 91.4	(3.)	
Trefferlage	0.04 mm links, 0.20 mm hoch				
Streuwert	0.99, horizontal: 0.90, vertikal: 1.07				

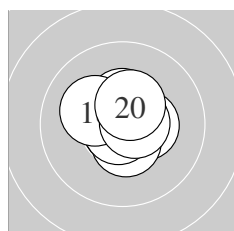

Serie 2:	10.4 *	10.8 *	10.4 *	10.8 *	10.9 *
	10.5 *	10.8 *	10.2 *	10.6 *	10.4 *
beste Teiler	23.4	(15.) 41.7	(12.) 42.0	(17.)	
Trefferlage	0.06 mm rechts, 0.21 mm hoch				
Streuwert	0.78, horizontal: 0.81, vertikal: 0.75				

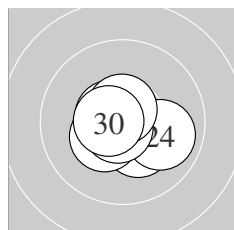

Serie 3:	10.6 *	10.7 *	10.3 *	9.9 →	10.6 *
	10.4 *	10.8 *	10.8 *	10.6 *	10.6 *
beste Teiler	48.1	(27.) 48.2	(28.) 67.4	(22.)	
Trefferlage	0.07 mm links, 0.27 mm tief				
Streuwert	0.89, horizontal: 1.07, vertikal: 0.67				

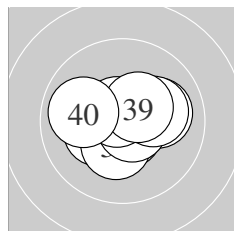

Serie 4:	10.3 *	10.6 *	10.0 →	10.7 *	10.3 *
	10.7 *	10.1 →	10.7 *	10.4 *	9.9 ←
beste Teiler	68.2	(34.) 68.2	(38.) 70.8	(36.)	
Trefferlage	0.17 mm rechts, 0.04 mm tief				
Streuwert	1.17, horizontal: 1.45, vertikal: 0.78				

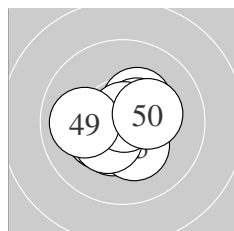

Serie 5:	10.3 *	10.4 *	10.3 *	10.3 *	10.3 *
	10.5 *	10.4 *	10.8 *	10.0 ←	10.3 *
beste Teiler	33.5	(48.) 106.8	(46.) 132.3	(42.)	
Trefferlage	0.25 mm links, 0.26 mm tief				
Streuwert	1.12, horizontal: 1.30, vertikal: 0.90				

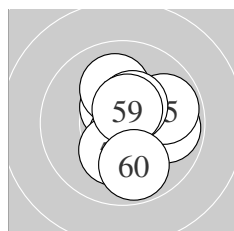

Serie 6:	9.9 →	10.5 *	10.5 *	10.6 *	9.8 →
	10.2 *	10.1 ↑	10.5 *	10.6 *	9.8 ↓
beste Teiler	90.0	(54.) 92.0	(59.) 112.2	(53.)	
Trefferlage	0.66 mm rechts, 0.08 mm hoch				
Streuwert	1.35, horizontal: 1.20, vertikal: 1.48				

Meyton Elektronik

ISSF AR Men – Wertung – Männer

StandNr: 114

Sampson, Dane #224

StartNr: 14

9. Dezember 2018 9:45

AUS

QF – Schütze hat sich fürs Finale qualifiziert

Unterschrift des Schützen

Meyton Elektronik

ISSF AR Men – Wertung – Männer

StandNr: 115

Lamplmaier, Gottfried #313

StartNr: 15

9. Dezember 2018 10:15

T – SG Walchsee

Ergebnis: **0.0** (0)_{DNS}
Serien:
Zähler: 0 0 0 0 0 0 0 0 0 0
Innenzehner: 0
weiteste:
~~beste Teiler~~ – Schütze ist nicht zum Wettkampf angetreten
Trefferlage 0.00 mm , 0.00 mm
Streuwert
Unterschrift des Schützen

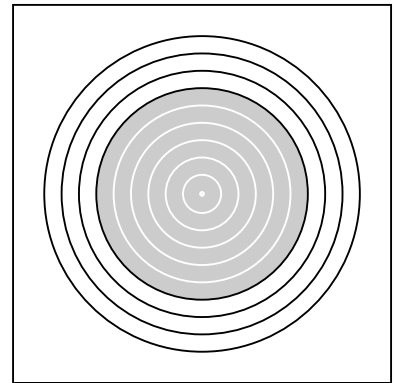

Meyton Elektronik

Ergebnis:	611.4	(586)							
Serien:	100.6	100.8	102.1	101.3	104.0	102.6			
Zähler:	46	14	0	0	0	0	0	0	0
Innenzehner:	38								
weiteste:	496 (7), 432 (13), 409 (31)								
beste Teiler	26.4 (60.) 42.0 (45.) 42.1 (17.)								
Trefferlage	0.20 mm rechts, 0.08 mm tief								
Streuwert	1.52, horizontal: 1.64, vertikal: 1.39								

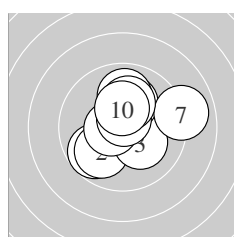
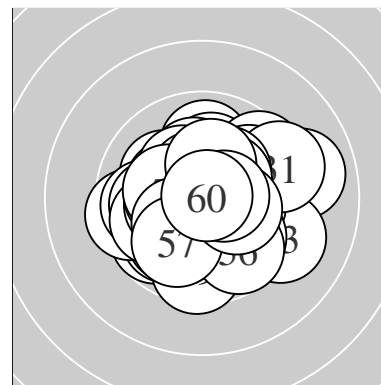

Serie 1:

9.7 ↙	9.9 ↙	10.2 *	10.1 ↑	10.6 *
9.9 ↑	9.0 →	10.7 *	10.2 *	10.3 *
beste Teiler	67.8 (8.) 94.7 (5.) 155.0 (10.)			
Trefferlage	0.26 mm rechts, 0.46 mm hoch			
Streuwert	1.83, horizontal: 1.95, vertikal: 1.69			

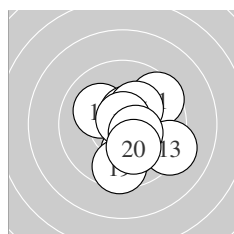

Serie 2:

9.6 ↗	10.1 ↖	9.2 ↘	10.6 *	10.3 *
10.1 ↓	10.8 *	10.4 *	9.6 ↓	10.1 ↘
beste Teiler	42.1 (17.) 95.6 (14.) 127.8 (18.)			
Trefferlage	0.85 mm rechts, 0.44 mm tief			
Streuwert	1.72, horizontal: 1.58, vertikal: 1.84			

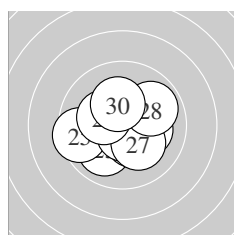

Serie 3:

10.2 *	10.7 *	10.0 ↙	10.4 *	9.5 ←
10.7 *	10.2 *	9.9 ↗	10.3 *	10.2 *
beste Teiler	67.5 (22.) 74.6 (26.) 148.6 (24.)			
Trefferlage	0.02 mm links, 0.34 mm tief			
Streuwert	1.52, horizontal: 1.78, vertikal: 1.21			

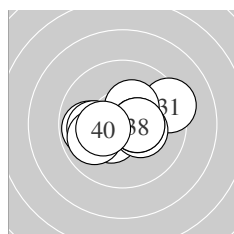

Serie 4:

9.3 →	10.3 *	10.4 *	10.3 *	9.8 ←
10.0 ←	10.5 *	10.5 *	9.9 ←	10.3 *
beste Teiler	120.4 (37.) 122.3 (38.) 133.6 (33.)			
Trefferlage	0.15 mm links, 0.08 mm tief			
Streuwert	1.64, horizontal: 2.15, vertikal: 0.88			

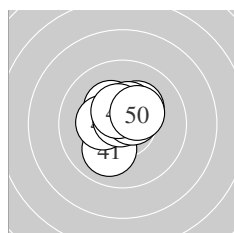

Serie 5:

10.0 ↙	10.4 *	10.3 *	10.3 *	10.8 *
10.3 *	10.6 *	10.4 *	10.5 *	10.4 *
beste Teiler	42.0 (45.) 93.7 (47.) 111.9 (49.)			
Trefferlage	0.01 mm rechts, 0.58 mm hoch			
Streuwert	1.01, horizontal: 1.01, vertikal: 1.01			

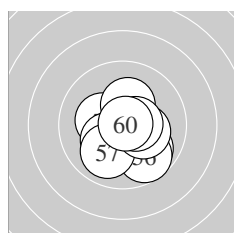

Serie 6:

10.6 *	10.3 *	10.3 *	9.9 ↘	10.3 *
9.7 ↘	10.0 ↙	10.2 *	10.5 *	10.8 *
beste Teiler	26.4 (60.) 77.1 (51.) 107.3 (59.)			
Trefferlage	0.25 mm rechts, 0.66 mm tief			
Streuwert	1.33, horizontal: 1.36, vertikal: 1.30			

Meyton Elektronik

ISSF AR Men – Wertung – Männer

StandNr: 116

Fölzer, Karl-Heinz #307

StartNr: 16

9. Dezember 2018 9:33

ST-Brucker SV

Unterschrift des Schützen

Meyton Elektronik

Ergebnis: **622.5** (594)
 Serien: 104.5 103.8 104.0 102.4 102.9 104.9
 Zähler: 54 6 0 0 0 0 0 0 0 0
 Innenzehner: 44
 weiteste: 402 (28), 366 (41), 309 (31)
 beste Teiler 8.5 (32.) 26.4 (24.) 44.0 (53.)
 Trefferlage 0.18 mm rechts, 0.00 mm
 Streuwert 1.17, horizontal: 1.23, vertikal: 1.11

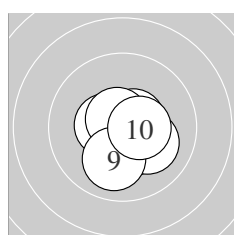
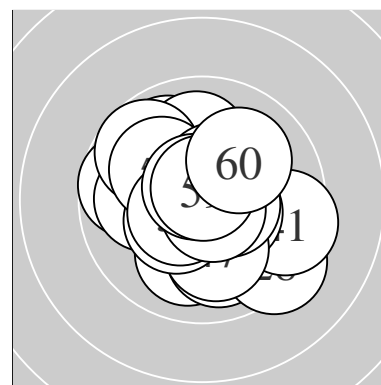

Serie 1:
 10.7 * 10.7 * 10.5 * 10.3 * 10.4 *
 10.6 * 10.1 ↘ 10.7 * 10.0 ↓ 10.5 *
 beste Teiler 53.8 (1.) 62.2 (2.) 69.0 (8.)
 Trefferlage 0.33 mm rechts, 0.36 mm tief
 Streuwert 0.96, horizontal: 0.97, vertikal: 0.95

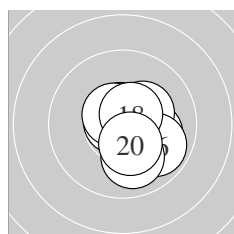

Serie 2:
 10.7 * 10.1 ↘ 10.5 * 10.7 * 10.3 *
 9.9 ↘ 10.6 * 10.6 * 10.0 ↓ 10.4 *
 beste Teiler 54.8 (14.) 72.2 (11.) 91.2 (17.)
 Trefferlage 0.73 mm rechts, 0.33 mm tief
 Streuwert 1.06, horizontal: 1.00, vertikal: 1.11

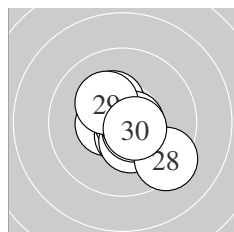

Serie 3:
 10.5 * 10.3 * 10.6 * 10.8 * 10.4 *
 10.6 * 10.7 * 9.3 ↘ 10.2 * 10.6 *
 beste Teiler 26.4 (24.) 69.1 (27.) 97.2 (23.)
 Trefferlage 0.35 mm rechts, 0.34 mm tief
 Streuwert 1.21, horizontal: 1.22, vertikal: 1.19

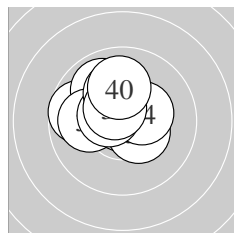

Serie 4:
 9.7 ← 10.9 * 10.4 * 10.4 * 9.9 ↖
 10.0 ← 10.5 * 10.1 ↑ 10.5 * 10.0 ↑
 beste Teiler 8.5 (32.) 106.6 (37.) 107.1 (39.)
 Trefferlage 0.66 mm links, 0.84 mm hoch
 Streuwert 1.22, horizontal: 1.38, vertikal: 1.02

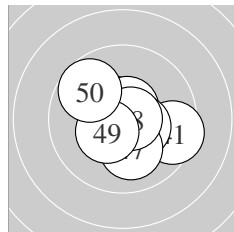

Serie 5:
 9.5 → 10.5 * 10.4 * 10.6 * 10.6 *
 10.4 * 10.1 ↓ 10.7 * 10.4 * 9.7 ↖
 beste Teiler 57.0 (48.) 77.1 (45.) 83.3 (44.)
 Trefferlage 0.16 mm rechts, 0.27 mm tief
 Streuwert 1.39, horizontal: 1.56, vertikal: 1.20

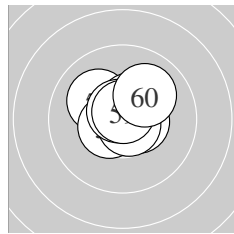

Serie 6:
 10.1 ↘ 10.4 * 10.8 * 10.5 * 10.5 *
 10.5 * 10.7 * 10.7 * 10.7 * 10.0 ↗
 beste Teiler 44.0 (53.) 51.3 (59.) 60.3 (57.)
 Trefferlage 0.22 mm rechts, 0.48 mm hoch
 Streuwert 0.88, horizontal: 0.99, vertikal: 0.75

Meyton Elektronik

ISSF AR Men – Wertung – Männer

StandNr: 117

Blamauer, Nikolaus #334

StartNr: 17

9. Dezember 2018 9:32

AUT

Unterschrift des Schützen

Meyton Elektronik

Ergebnis: **608.1** (581)
 Serien: 101.0 100.9 102.5 100.1 100.3 103.3
 Zähler: 41 19 0 0 0 0 0 0 0
 Innenzehner: 28
 weiteste: 456 (33), 408 (20), 404 (37)
 beste Teiler 38.0 (23.) 41.1 (38.) 53.4 (32.)
 Trefferlage 0.74 mm links, 0.86 mm hoch
 Streuwert 1.39, horizontal: 1.55, vertikal: 1.21

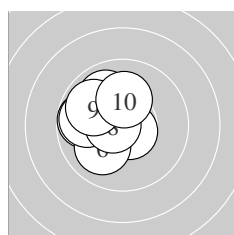
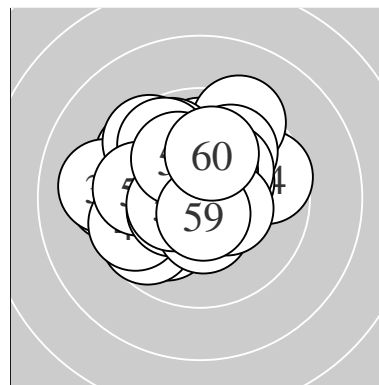

Serie 1:
 10.7 * 10.2 * 9.8 ← 10.0 ↖ 9.9 ↘
 10.0 ↙ 9.8 ← 10.6 * 9.9 ↖ 10.1 ↑
 beste Teiler 72.9 (1.) 78.0 (8.) 198.1 (2.)
 Trefferlage 1.44 mm links, 0.67 mm hoch
 Streuwert 1.19, horizontal: 1.18, vertikal: 1.20

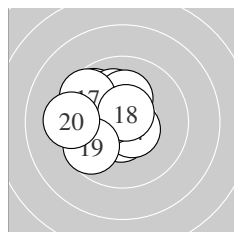

Serie 2:
 9.7 ↘ 10.6 * 10.1 ↗ 10.6 * 10.2 *
 10.5 * 9.6 ↘ 10.6 * 9.7 ↙ 9.3 ←
 beste Teiler 78.4 (18.) 94.8 (12.) 95.6 (14.)
 Trefferlage 1.22 mm links, 0.59 mm hoch
 Streuwert 1.51, horizontal: 1.60, vertikal: 1.41

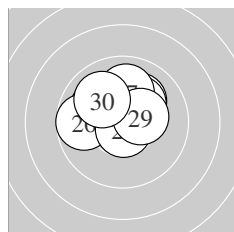

Serie 3:
 10.5 * 10.1 ↗ 10.8 * 10.2 * 10.1 ↘
 9.7 ← 10.0 ↑ 10.7 * 10.4 * 10.0 ↘
 beste Teiler 38.0 (23.) 56.5 (28.) 101.2 (21.)
 Trefferlage 0.30 mm links, 0.87 mm hoch
 Streuwert 1.27, horizontal: 1.51, vertikal: 0.99

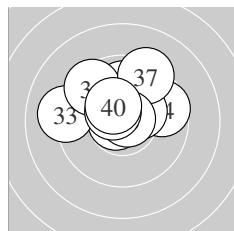

Serie 4:
 9.9 ↑ 10.7 * 9.1 ← 9.6 → 10.3 *
 9.5 ↘ 9.3 ↑ 10.8 * 10.5 * 10.4 *
 beste Teiler 41.1 (38.) 53.4 (32.) 106.7 (39.)
 Trefferlage 0.23 mm links, 1.32 mm hoch
 Streuwert 1.75, horizontal: 2.17, vertikal: 1.20

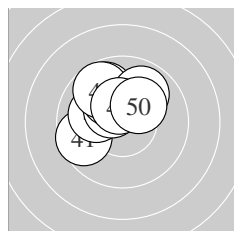

Serie 5:
 9.6 ← 10.1 ↗ 9.8 ↘ 10.1 ↖ 10.4 *
 10.1 ↘ 9.7 ↘ 9.9 ↗ 10.4 * 10.2 *
 beste Teiler 131.2 (49.) 131.7 (45.) 183.8 (50.)
 Trefferlage 0.85 mm links, 1.42 mm hoch
 Streuwert 1.28, horizontal: 1.40, vertikal: 1.14

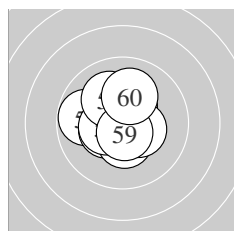

Serie 6:
 10.4 * 9.8 ← 10.4 * 10.4 * 10.4 *
 10.7 * 10.4 * 10.1 ↘ 10.6 * 10.1 ↑
 beste Teiler 75.1 (56.) 76.6 (59.) 130.4 (57.)
 Trefferlage 0.42 mm links, 0.28 mm hoch
 Streuwert 1.20, horizontal: 1.21, vertikal: 1.18

Meyton Elektronik

ISSF AR Men – Wertung – Männer

StandNr: 118

Walder, Markus #150

StartNr: 18

9. Dezember 2018 9:17

T – SSG Innervillgraten

Unterschrift des Schützen

Meyton Elektronik

Ergebnis:	619.5	(592)
Serien:	102.0	104.1 101.9 102.8 104.4 104.3
Zähler:	52	8 0 0 0 0 0 0 0 0
Innenzehner:	45	
weiteste:	343	(2), 331 (32), 320 (24)
beste Teiler	33.3	(16.) 47.6 (35.) 53.8 (54.)
Trefferlage	0.34 mm	rechts, 0.17 mm hoch
Streuwert	1.21,	horizontal: 1.18, vertikal: 1.24

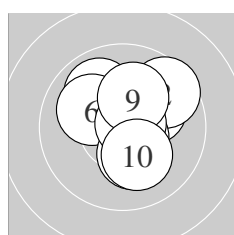
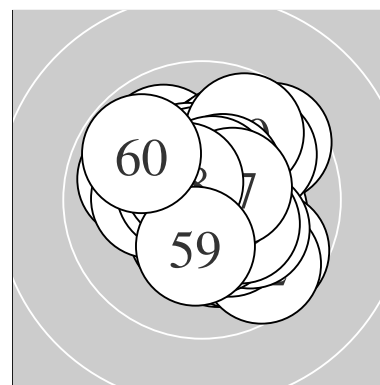

Serie 1:

10.1 ↗	9.6 ↗	10.4 *	9.9 ↘	10.6 *
10.1 ↖	10.2 *	10.7 *	10.2 *	10.2 *
beste Teiler	55.0 (8.)	91.2 (5.)	143.0 (3.)	
Trefferlage	0.44 mm rechts, 0.60 mm hoch			
Streuwert	1.42, horizontal: 1.35, vertikal: 1.49			

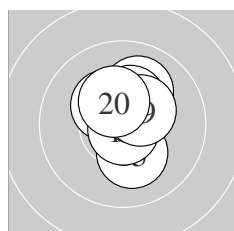

Serie 2:

10.3 *	10.0 ↗	10.7 *	10.6 *	10.2 *
10.8 *	10.5 *	10.3 *	10.4 *	10.3 *
beste Teiler	33.3 (16.)	60.1 (13.)	96.1 (14.)	
Trefferlage	0.34 mm rechts, 0.69 mm hoch			
Streuwert	0.91, horizontal: 0.67, vertikal: 1.09			

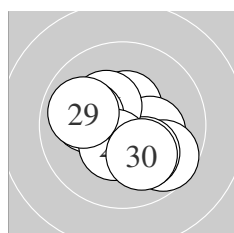

Serie 3:

10.5 *	10.6 *	10.2 *	9.7 ↘	10.1 ↘
10.3 *	10.1 ↖	10.4 *	9.9 ↖	10.1 ↘
beste Teiler	98.3 (22.)	120.2 (21.)	134.4 (28.)	
Trefferlage	0.01 mm rechts, 0.41 mm tief			
Streuwert	1.49, horizontal: 1.68, vertikal: 1.26			

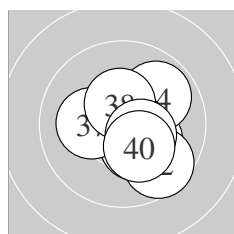

Serie 4:

10.2 *	9.6 ↘	10.3 *	9.9 ↗	10.8 *
10.7 *	10.2 *	10.4 *	10.4 *	10.3 *
beste Teiler	47.6 (35.)	65.7 (36.)	128.1 (38.)	
Trefferlage	0.66 mm rechts, 0.35 mm tief			
Streuwert	1.28, horizontal: 1.28, vertikal: 1.27			

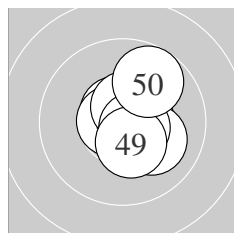

Serie 5:

10.5 *	10.5 *	10.6 *	10.6 *	10.1 ↘
10.7 *	10.6 *	10.6 *	10.4 *	9.8 ↗
beste Teiler	66.3 (46.)	76.8 (43.)	82.7 (48.)	
Trefferlage	0.63 mm rechts, 0.19 mm hoch			
Streuwert	0.96, horizontal: 0.78, vertikal: 1.11			

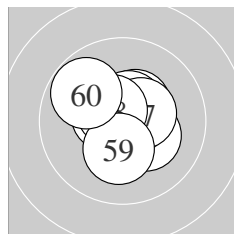

Serie 6:

10.7 *	10.4 *	10.6 *	10.7 *	10.3 *
10.5 *	10.5 *	10.6 *	10.2 *	9.8 ↘
beste Teiler	53.8 (54.)	63.5 (51.)	96.8 (58.)	
Trefferlage	0.03 mm links, 0.34 mm hoch			
Streuwert	1.06, horizontal: 1.12, vertikal: 0.99			

Meyton Elektronik

ISSF AR Men – Wertung – **Männer**

StandNr: 119

Olsson, Karl #306

StartNr: 19

9. Dezember 2018 9:41

SWE

Unterschrift des Schützen

Meyton Elektronik

Ergebnis: **623.2** (593)^{QF}
 Serien: 104.1 104.0 104.7 103.5 103.1 103.8
 Zähler: 53 7 0 0 0 0 0 0 0
 Innenzehner: 48
 weiteste: 367 (48), 341 (31), 322 (19)
 beste Teiler 11.3 (14.) 33.2 (57.) 33.9 (1.)
 Trefferlage 0.14 mm links, 0.05 mm tief
 Streuwert 1.15, horizontal: 1.43, vertikal: 0.79

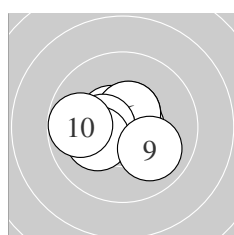
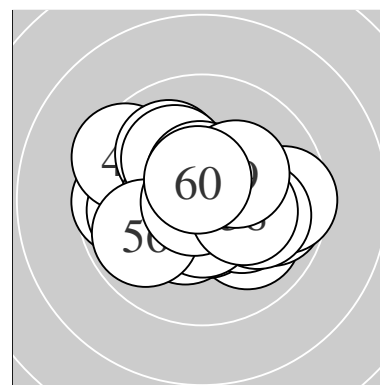

Serie 1:
 10.8 * 10.5 * 10.5 * 10.7 * 10.7 *
 10.5 * 10.4 * 10.2 * 10.0 ↘ 9.8 ←
 beste Teiler 33.9 (1.) 66.1 (4.) 70.2 (5.)
 Trefferlage 0.32 mm links, 0.01 mm hoch
 Streuwert 1.14, horizontal: 1.42, vertikal: 0.76

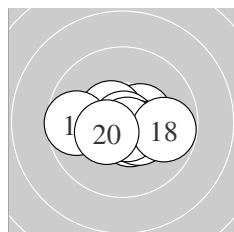

Serie 2:
 10.4 * 10.7 * 10.5 * 10.9 * 10.5 *
 10.4 * 10.7 * 9.8 → 9.7 ← 10.4 *
 beste Teiler 11.3 (14.) 60.2 (17.) 65.4 (12.)
 Trefferlage 0.15 mm rechts, 0.28 mm tief
 Streuwert 1.20, horizontal: 1.62, vertikal: 0.51

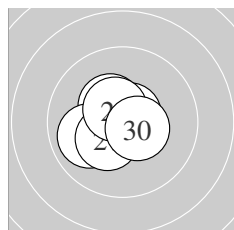

Serie 3:
 10.7 * 10.4 * 10.6 * 10.7 * 10.3 *
 10.0 ← 10.3 * 10.7 * 10.5 * 10.5 *
 beste Teiler 65.0 (21.) 67.9 (28.) 68.0 (24.)
 Trefferlage 0.50 mm links, 0.10 mm tief
 Streuwert 0.92, horizontal: 1.01, vertikal: 0.81

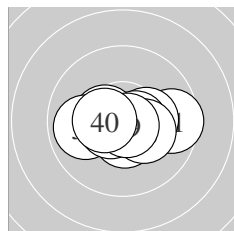

Serie 4:
 9.6 → 10.3 * 10.6 * 10.5 * 10.5 *
 9.9 ← 10.6 * 10.3 * 10.8 * 10.4 *
 beste Teiler 42.4 (39.) 90.0 (33.) 90.3 (37.)
 Trefferlage 0.20 mm rechts, 0.25 mm tief
 Streuwert 1.27, horizontal: 1.75, vertikal: 0.40

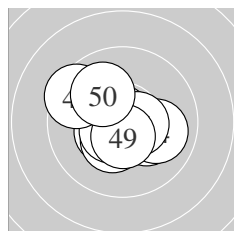

Serie 5:
 10.4 * 10.8 * 10.2 * 10.0 → 10.4 *
 10.6 * 10.6 * 9.5 ↘ 10.6 * 10.0 ↘
 beste Teiler 38.0 (42.) 99.6 (46.) 99.8 (47.)
 Trefferlage 0.24 mm links, 0.11 mm tief
 Streuwert 1.39, horizontal: 1.61, vertikal: 1.13

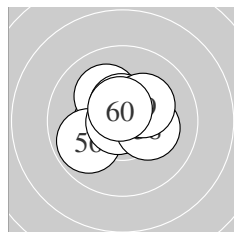

Serie 6:
 10.5 * 10.6 * 10.4 * 10.1 ↘ 10.5 *
 9.9 ← 10.8 * 10.2 * 10.2 * 10.6 *
 beste Teiler 33.2 (57.) 85.9 (60.) 100.4 (52.)
 Trefferlage 0.14 mm links, 0.39 mm hoch
 Streuwert 1.12, horizontal: 1.29, vertikal: 0.91

Meyton Elektronik

ISSF AR Men – Wertung – Männer

StandNr: 120

Zott, Georg #88

StartNr: 20

9. Dezember 2018 9:24

AUT

QF – Schütze hat sich fürs Finale qualifiziert

Unterschrift des Schützen

Meyton Elektronik

Ergebnis: **623.4** (597)^{QF}
 Serien: 103.6 103.7 102.5 104.3 104.9 104.4
 Zähler: 57 3 0 0 0 0 0 0 0 0
 Innenzehner: 49
 weiteste: 481 (21), 274 (9), 252 (57)
 beste Teiler 16.7 (49.) 37.3 (46.) 48.8 (42.)
 Trefferlage 0.05 mm links, 0.04 mm hoch
 Streuwert 1.14, horizontal: 1.40, vertikal: 0.80

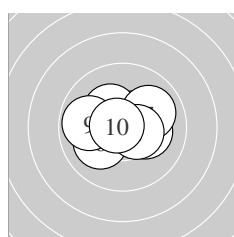
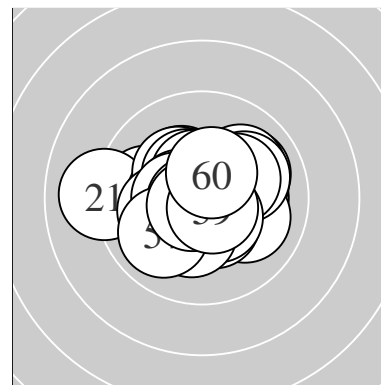

Serie 1:
 10.7 * 10.6 * 10.5 * 10.3 * 10.2 *
 10.1 ← 10.0 → 10.5 * 9.9 ← 10.8 *
 beste Teiler 49.7 (10.) 73.1 (1.) 88.5 (2.)
 Trefferlage 0.09 mm links, 0.28 mm hoch
 Streuwert 1.24, horizontal: 1.58, vertikal: 0.77

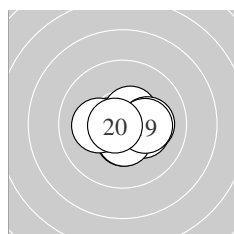

Serie 2:
 10.5 * 10.2 * 10.5 * 10.3 * 10.5 *
 10.5 * 10.2 * 10.1 → 10.2 * 10.7 *
 beste Teiler 64.1 (20.) 107.4 (13.) 107.4 (16.)
 Trefferlage 0.44 mm rechts, 0.26 mm tief
 Streuwert 1.06, horizontal: 1.37, vertikal: 0.60

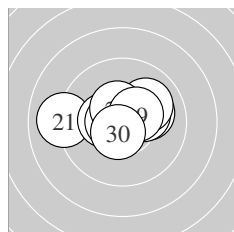

Serie 3:
 9.0 ← 10.1 → 10.4 * 10.2 * 10.6 *
 10.7 * 10.0 → 10.5 * 10.4 * 10.6 *
 beste Teiler 70.3 (26.) 85.0 (25.) 90.3 (30.)
 Trefferlage 0.08 mm links, 0.46 mm hoch
 Streuwert 1.52, horizontal: 2.06, vertikal: 0.62

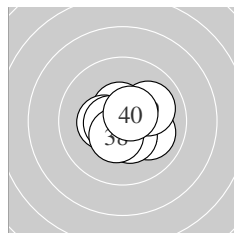

Serie 4:
 10.0 → 10.7 * 10.4 * 10.6 * 10.7 *
 10.3 * 10.6 * 10.4 * 10.0 → 10.6 *
 beste Teiler 61.6 (32.) 63.8 (35.) 89.8 (40.)
 Trefferlage 0.19 mm rechts, 0.20 mm tief
 Streuwert 1.03, horizontal: 1.20, vertikal: 0.84

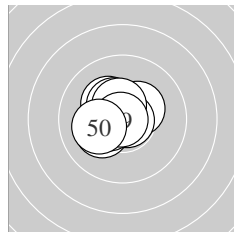

Serie 5:
 10.4 * 10.8 * 10.3 * 10.4 * 10.2 *
 10.8 * 10.5 * 10.5 * 10.9 * 10.1 ←
 beste Teiler 16.7 (49.) 37.3 (46.) 48.8 (42.)
 Trefferlage 0.57 mm links, 0.26 mm hoch
 Streuwert 0.88, horizontal: 0.95, vertikal: 0.80

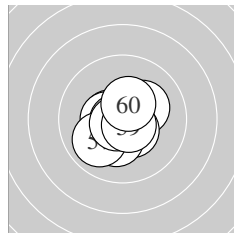

Serie 6:
 10.5 * 10.2 * 10.5 * 10.5 * 10.3 *
 10.7 * 9.9 ← 10.7 * 10.7 * 10.4 *
 beste Teiler 51.2 (56.) 60.6 (58.) 70.7 (59.)
 Trefferlage 0.23 mm links, 0.30 mm tief
 Streuwert 1.01, horizontal: 1.06, vertikal: 0.96

Meyton Elektronik

ISSF AR Men – Wertung – Männer

StandNr: 121

Hrckulak, David #226

StartNr: 21

9. Dezember 2018 9:42

CZE

QF – Schütze hat sich fürs Finale qualifiziert

Unterschrift des Schützen

Meyton Elektronik

Ergebnis: **620.8** (594)
 Serien: 102.3 105.0 103.1 103.1 104.7 102.6
 Zähler: 54 6 0 0 0 0 0 0 0 0
 Innenzehner: 48
 weiteste: 346 (36), 336 (7), 305 (47)
 beste Teiler 6.0 (49.) 34.6 (37.) 55.1 (43.)
 Trefferlage 0.11 mm links, 0.05 mm tief
 Streuwert 1.21, horizontal: 1.30, vertikal: 1.10

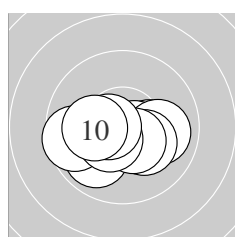
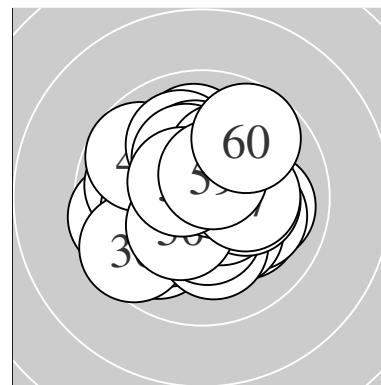

Serie 1:
 10.2 * 9.9 ↙ 10.6 * 10.0 → 10.2 *
 10.5 * 9.6 ← 10.5 * 10.6 * 10.2 *
 beste Teiler 90.8 (3.) 96.0 (9.) 118.2 (6.)
 Trefferlage 0.15 mm links, 0.66 mm tief
 Streuwert 1.38, horizontal: 1.87, vertikal: 0.56

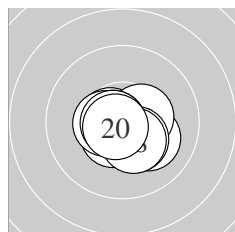

Serie 2:
 10.1 ↘ 10.6 * 10.4 * 10.7 * 10.5 *
 10.4 * 10.5 * 10.4 * 10.7 * 10.7 *
 beste Teiler 58.5 (20.) 65.3 (14.) 66.3 (19.)
 Trefferlage 0.01 mm rechts, 0.44 mm tief
 Streuwert 0.84, horizontal: 1.03, vertikal: 0.59

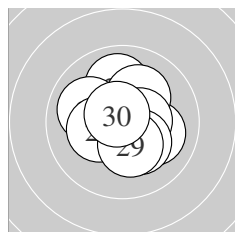

Serie 3:
 10.1 ↘ 10.7 * 10.0 ↑ 10.2 * 10.0 ↖
 10.5 * 10.3 * 10.3 * 10.3 * 10.7 *
 beste Teiler 66.6 (30.) 73.0 (22.) 116.4 (26.)
 Trefferlage 0.11 mm rechts, 0.22 mm hoch
 Streuwert 1.31, horizontal: 1.33, vertikal: 1.28

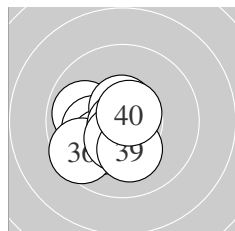

Serie 4:
 9.9 ← 10.2 * 10.4 * 10.2 * 10.6 *
 9.6 ↙ 10.8 * 10.5 * 10.2 * 10.7 *
 beste Teiler 34.6 (37.) 69.6 (40.) 90.2 (35.)
 Trefferlage 0.91 mm links, 0.64 mm tief
 Streuwert 1.13, horizontal: 1.20, vertikal: 1.05

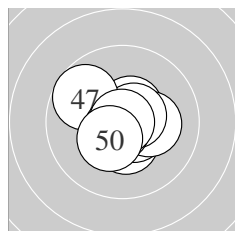

Serie 5:
 10.4 * 10.5 * 10.7 * 10.6 * 10.2 *
 10.6 * 9.7 ↘ 10.7 * 10.9 * 10.4 *
 beste Teiler 6.0 (49.) 55.1 (43.) 60.4 (48.)
 Trefferlage 0.01 mm links, 0.09 mm tief
 Streuwert 1.05, horizontal: 1.17, vertikal: 0.91

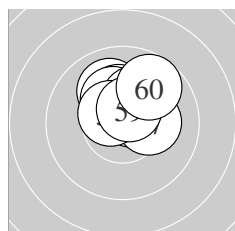

Serie 6:
 10.0 ↖ 10.2 * 10.4 * 10.6 * 10.3 *
 10.2 * 10.2 * 10.5 * 10.5 * 9.7 ↗
 beste Teiler 84.8 (54.) 105.2 (58.) 106.0 (59.)
 Trefferlage 0.27 mm rechts, 1.32 mm hoch
 Streuwert 0.88, horizontal: 1.00, vertikal: 0.75

Meyton Elektronik

ISSF AR Men – Wertung – Männer

StandNr: 122

Mathis, Thomas #223

StartNr: 22

9. Dezember 2018 9:26

AUT

Unterschrift des Schützen

Meyton Elektronik

Ergebnis: **601.5** (577)

Serien: 101.1 98.7 100.5 98.6 100.6 102.0

Zähler: 39 19 2 0 0 0 0 0 0 0

Innenzehner: 29

weiteste: 591 (19), 565 (16), 494 (8)

beste Teiler 63.0 (9.) 76.5 (11.) 83.1 (3.)

Trefferlage 0.17 mm rechts, 0.47 mm hoch

Streuwert 1.81, horizontal: 1.77, vertikal: 1.86

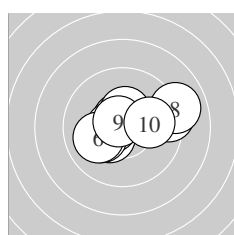
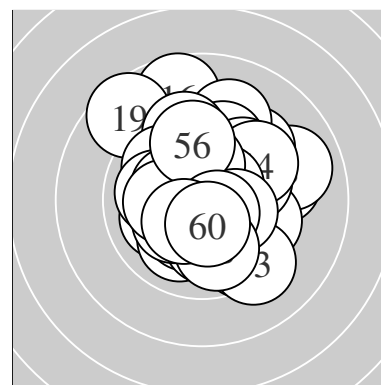

Serie 1:

9.3 →	10.4 *	10.6 *	10.6 *	10.1 ←
10.0 ←	10.4 *	9.0 →	10.7 *	10.0 →

beste Teiler 63.0 (9.) 83.1 (3.) 96.0 (4.)

Trefferlage 0.45 mm rechts, 0.29 mm hoch

Streuwert 1.83, horizontal: 2.41, vertikal: 0.95

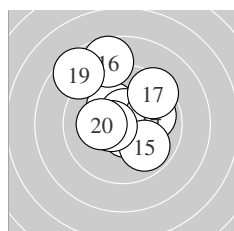

Serie 2:

10.6 *	10.2 *	10.6 *	9.9 →	9.9 ↘
8.7 ↑	9.4 ↗	10.6 *	8.6 ↖	10.2 *

beste Teiler 76.5 (11.) 89.6 (13.) 97.4 (18.)

Trefferlage 0.13 mm links, 1.30 mm hoch

Streuwert 2.20, horizontal: 2.08, vertikal: 2.32

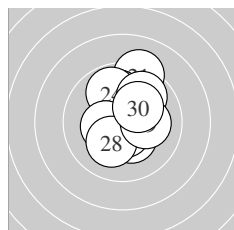

Serie 3:

9.2 ↑	10.0 ↑	10.3 *	9.8 ↑	10.6 *
10.3 *	9.8 ↗	10.2 *	10.1 →	10.2 *

beste Teiler 90.7 (25.) 152.5 (26.) 158.0 (23.)

Trefferlage 0.36 mm rechts, 0.82 mm hoch

Streuwert 1.66, horizontal: 1.27, vertikal: 1.98

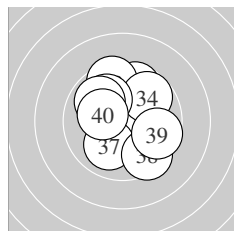

Serie 4:

9.7 ↑	9.5 ↑	10.4 *	9.7 ↗	10.0 ↖
9.9 ↖	10.0 ↙	9.5 ↘	9.7 →	10.2 *

beste Teiler 130.5 (33.) 185.6 (40.) 236.0 (35.)

Trefferlage 0.17 mm rechts, 0.78 mm hoch

Streuwert 2.01, horizontal: 1.86, vertikal: 2.16

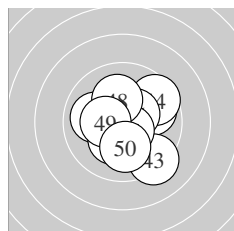

Serie 5:

9.9 →	10.0 ←	9.2 ↘	9.6 ↗	10.5 *
10.3 *	10.6 *	10.1 ↑	10.3 *	10.1 ↓

beste Teiler 90.8 (47.) 125.9 (45.) 151.0 (49.)

Trefferlage 0.47 mm rechts, 0.16 mm tief

Streuwert 1.79, horizontal: 1.82, vertikal: 1.75

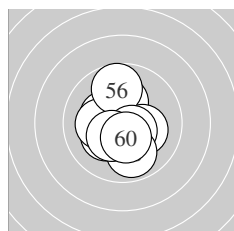

Serie 6:

10.2 *	10.3 *	10.2 *	10.2 *	10.2 *
9.7 ↑	10.5 *	9.9 ↓	10.4 *	10.4 *

beste Teiler 105.6 (57.) 131.2 (60.) 149.0 (59.)

Trefferlage 0.27 mm links, 0.20 mm tief

Streuwert 1.44, horizontal: 1.21, vertikal: 1.63

Meyton Elektronik

ISSF AR Men – Wertung – Männer

StandNr: 123

Heidegger, Daniel #312

StartNr: 23

9. Dezember 2018 9:36

SSV Wien

Unterschrift des Schützen

Meyton Elektronik

Ergebnis: **620.7** (590)
 Serien: 104.2 105.3 103.5 101.0 101.2 105.5
 Zähler: 51 8 1 0 0 0 0 0 0
 Innenzehner: 45
 weiteste: 628 (28), 369 (46), 361 (38)
 beste Teiler 2.2 (15.) 29.1 (60.) 44.3 (25.)
 Trefferlage 0.11 mm rechts, 0.14 mm tief
 Streuwert 1.32, horizontal: 1.46, vertikal: 1.15

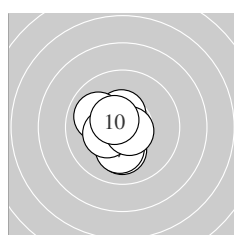
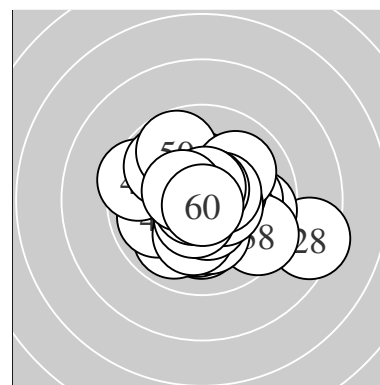

Serie 1:
 10.5 * 10.7 * 10.5 * 10.0 ↖ 10.6 *
 10.1 ↓ 10.2 * 10.3 * 10.7 * 10.6 *
 beste Teiler 55.5 (2.) 71.1 (9.) 99.9 (10.)
 Trefferlage 0.66 mm links, 0.33 mm tief
 Streuwert 0.97, horizontal: 0.80, vertikal: 1.11

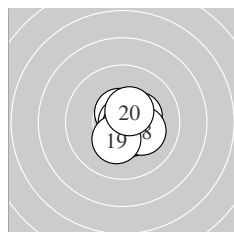

Serie 2:
 10.5 * 10.6 * 10.4 * 10.7 * 10.9 *
 10.4 * 10.8 * 10.2 * 10.3 * 10.5 *
 beste Teiler 2.2 (15.) 47.7 (17.) 67.9 (14.)
 Trefferlage 0.59 mm rechts, 0.15 mm tief
 Streuwert 0.80, horizontal: 0.75, vertikal: 0.84

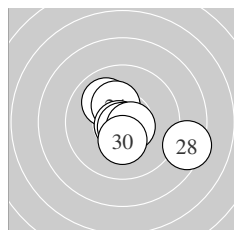

Serie 3:
 10.7 * 10.8 * 10.0 ↗ 10.3 * 10.8 *
 10.8 * 10.8 * 8.4 ↘ 10.6 * 10.3 *
 beste Teiler 44.3 (25.) 45.5 (27.) 45.6 (26.)
 Trefferlage 0.45 mm rechts, 0.29 mm tief
 Streuwert 1.66, horizontal: 2.02, vertikal: 1.21

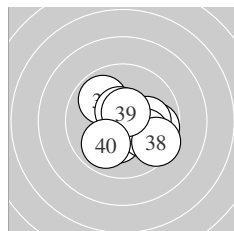

Serie 4:
 9.7 → 10.4 * 10.1 → 10.3 * 9.9 ↖
 10.0 ↘ 10.6 * 9.5 ↘ 10.6 * 9.9 ↗
 beste Teiler 85.0 (39.) 95.8 (37.) 135.6 (32.)
 Trefferlage 0.75 mm rechts, 0.44 mm tief
 Streuwert 1.58, horizontal: 1.79, vertikal: 1.34

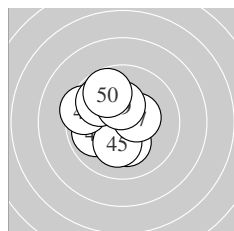

Serie 5:
 10.6 * 10.2 * 9.9 ↙ 10.6 * 10.2 *
 9.5 ↖ 10.4 * 9.8 ↖ 10.3 * 9.7 ↖
 beste Teiler 83.7 (41.) 94.3 (44.) 135.6 (47.)
 Trefferlage 0.77 mm links, 0.25 mm hoch
 Streuwert 1.56, horizontal: 1.55, vertikal: 1.58

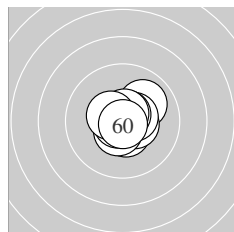

Serie 6:
 10.5 * 10.0 ↗ 10.5 * 10.5 * 10.7 *
 10.5 * 10.8 * 10.7 * 10.5 * 10.8 *
 beste Teiler 29.1 (60.) 49.2 (57.) 68.6 (55.)
 Trefferlage 0.28 mm rechts, 0.08 mm hoch
 Streuwert 0.83, horizontal: 0.86, vertikal: 0.80

Meyton Elektronik

ISSF AR Men – Wertung – **Männer**

StandNr: 124

Rumpler, Stefan #311

StartNr: 24

9. Dezember 2018 9:40

AUT

Unterschrift des Schützen

Meyton Elektronik

ISSF AR Men – Wertung – Männer

StandNr: 125

Insam, Fabian #158

StartNr: 25

9. Dezember 2018 10:15

T – SG Fügenberg

Ergebnis: **0.0** (0)_{DNS}
Serien:
Zähler: 0 0 0 0 0 0 0 0 0 0
Innenzehner: 0
weiteste:
beste Teiler – Schütze ist nicht zum Wettkampf angetreten
Trefferlage 0.00 mm , 0.00 mm
Streuwert
Unterschrift des Schützen

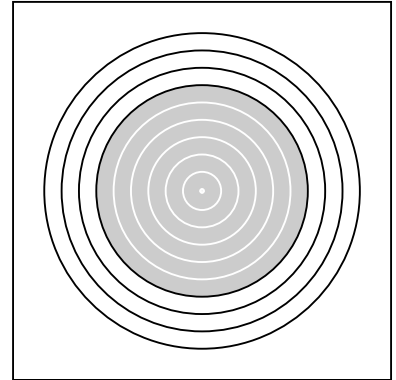

Meyton Elektronik

ISSF AR Men – Wertung – Männer

StartNr: 26

StandNr: 126

9. Dezember 2018 10:15

Aidel, Billel #310

DZA

Ergebnis: **0.0** (0)_{DNS}
Serien:
Zähler: 0 0 0 0 0 0 0 0 0 0
Innenzehner: 0
weiteste:
beste Teiler – Schütze ist nicht zum Wettkampf angetreten
Trefferlage 0.00 mm , 0.00 mm
Streuwert
Unterschrift des Schützen

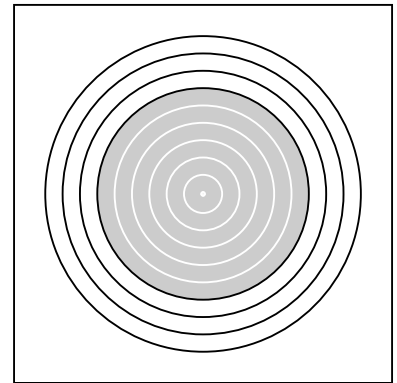

Ergebnis:	604.1	(577)
Serien:	98.6	100.8 100.7 100.1 103.4 100.5
Zähler:	40	17 3 0 0 0 0 0 0 0
Innenzehner:	31	
weiteste:	701	(31), 569 (23), 564 (5)
beste Teiler	59.6	(55.) 74.0 (21.) 80.4 (38.)
Trefferlage	0.68 mm	rechts, 0.06 mm hoch
Streuwert	1.76,	horizontal: 1.96, vertikal: 1.54

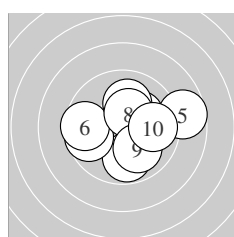
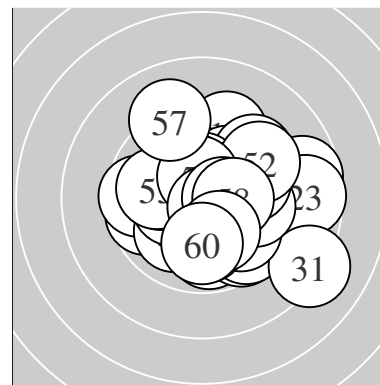

Serie 1:	9.8 ↓	10.3 *	10.2 *	9.7 ←	8.7 →
	9.6 ←	10.1 ↑	10.4 *	10.0 ↘	9.8 →
beste Teiler	140.7	(8.) 168.9 (2.)	187.0 (3.)		
Trefferlage	0.69 mm	rechts, 0.16 mm hoch			
Streuwert	2.16,	horizontal: 2.60, vertikal: 1.60			

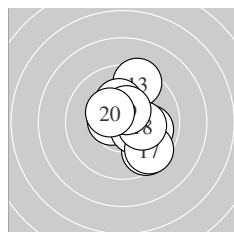

Serie 2:	10.6 *	9.6 ↘	9.4 ↑	10.2 *	9.9 →
	10.4 *	9.6 ↘	10.2 *	10.5 *	10.4 *
beste Teiler	100.8	(11.) 115.7 (19.)	129.1 (16.)		
Trefferlage	0.91 mm	rechts, 0.07 mm hoch			
Streuwert	1.66,	horizontal: 1.37, vertikal: 1.90			

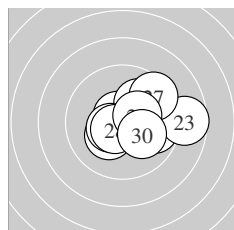

Serie 3:	10.7 *	9.8 →	8.7 →	10.1 ↗	10.3 *
	10.5 *	9.5 ↗	10.6 *	10.4 *	10.1 ↘
beste Teiler	74.0	(21.) 94.8 (28.)	122.1 (26.)		
Trefferlage	1.24 mm	rechts, 0.12 mm hoch			
Streuwert	1.77,	horizontal: 2.20, vertikal: 1.20			

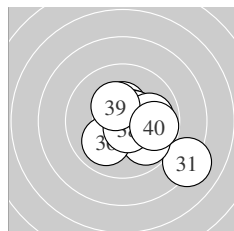

Serie 4:	8.1 ↘	9.8 ↘	10.4 *	10.6 *	10.5 *
	10.0 ↗	10.0 →	10.6 *	10.3 *	9.8 →
beste Teiler	80.4	(38.) 93.3 (34.)	114.6 (35.)		
Trefferlage	1.33 mm	rechts, 0.42 mm tief			
Streuwert	1.90,	horizontal: 2.13, vertikal: 1.64			

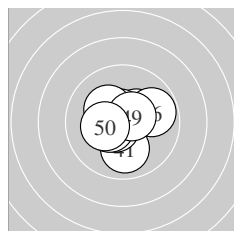

Serie 5:	10.0 ↓	10.4 *	10.6 *	10.4 *	10.4 *
	9.8 →	10.6 *	10.3 *	10.6 *	10.3 *
beste Teiler	82.5	(47.) 84.8 (43.)	97.9 (49.)		
Trefferlage	0.11 mm	links, 0.12 mm hoch			
Streuwert	1.24,	horizontal: 1.36, vertikal: 1.11			

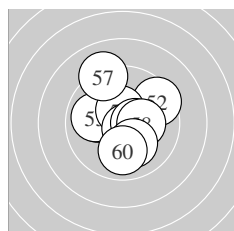

Serie 6:	10.0 ←	9.5 ↗	9.9 ←	10.5 *	10.7 *
	10.5 *	9.1 ↘	10.3 *	10.1 ↘	9.9 ↓
beste Teiler	59.6	(55.) 114.0 (56.)	120.2 (54.)		
Trefferlage	0.05 mm	rechts, 0.35 mm hoch			
Streuwert	1.86,	horizontal: 1.81, vertikal: 1.91			

ISSF AR Men – Wertung – **Männer**

StandNr: 127

Simo, Kornel #305

StartNr: 27

9. Dezember 2018 9:39

BHSE – HUN

Unterschrift des Schützen

Meyton Elektronik

Ergebnis:	611.9	(584)
Serien:	98.7	103.8 102.2 103.0 101.6 102.6
Zähler:	45	14 1 0 0 0 0 0 0 0
Innenzehner:	34	
weiteste:	540 (2), 455 (43), 421 (60)	
beste Teiler	6.0 (54.)	14.4 (50.) 17.0 (22.)
Trefferlage	0.03 mm rechts,	0.06 mm hoch
Streuwert	1.56,	horizontal: 1.84, vertikal: 1.21

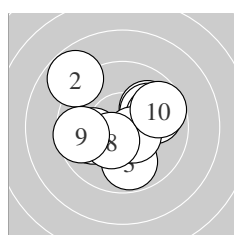
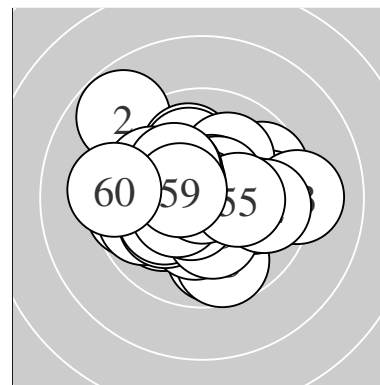

Serie 1:	10.0 ↗	8.8 ↖	9.8 ↓	10.0 ↗	9.9 →
	10.0 ←	10.5 *	10.4 *	9.6 ←	9.7 →
beste Teiler	104.6 (7.)	139.1 (8.)	238.9 (4.)		
Trefferlage	0.04 mm rechts, 0.31 mm hoch				
Streuwert	2.18, horizontal: 2.47, vertikal: 1.84				

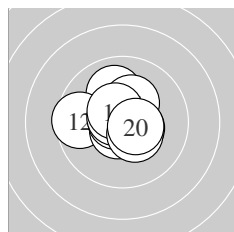

Serie 2:	10.0 ↑	9.6 ←	10.6 *	10.3 *	10.5 *
	10.7 *	10.7 *	10.5 *	10.4 *	10.5 *
beste Teiler	53.4 (16.)	71.8 (17.)	78.3 (13.)		
Trefferlage	0.23 mm links, 0.28 mm hoch				
Streuwert	1.20, horizontal: 1.35, vertikal: 1.02				

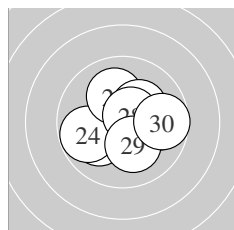

Serie 3:	10.7 *	10.9 *	10.1 ↙	9.8 ←	9.8 →
	10.1 ↑	10.3 *	10.6 *	10.2 *	9.7 →
beste Teiler	17.0 (22.)	73.5 (21.)	85.1 (28.)		
Trefferlage	0.40 mm rechts, 0.05 mm tief				
Streuwert	1.54, horizontal: 1.84, vertikal: 1.14				

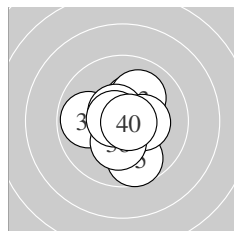

Serie 4:	9.9 ←	10.3 *	10.1 ↗	10.3 *	9.7 ↓
	10.6 *	10.3 *	10.3 *	10.7 *	10.8 *
beste Teiler	50.0 (40.)	67.4 (39.)	87.6 (36.)		
Trefferlage	0.06 mm rechts, 0.22 mm tief				
Streuwert	1.37, horizontal: 1.24, vertikal: 1.48				

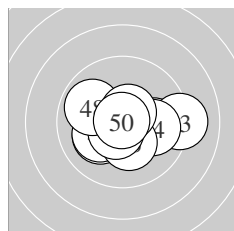

Serie 5:	10.1 ↙	10.0 →	9.1 →	10.0 →	10.1 ↙
	10.3 *	10.6 *	9.9 ↖	10.6 *	10.9 *
beste Teiler	14.4 (50.)	89.1 (49.)	90.2 (47.)		
Trefferlage	0.38 mm rechts, 0.30 mm tief				
Streuwert	1.68, horizontal: 2.21, vertikal: 0.86				

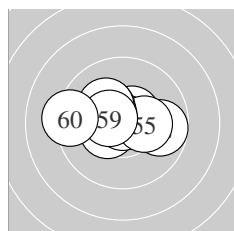

Serie 6:	10.5 *	9.8 →	10.4 *	10.9 *	10.3 *
	10.4 *	10.3 *	10.2 *	10.5 *	9.3 ←
beste Teiler	6.0 (54.)	101.8 (51.)	112.2 (59.)		
Trefferlage	0.47 mm links, 0.37 mm hoch				
Streuwert	1.47, horizontal: 1.97, vertikal: 0.64				

Meyton Elektronik

ISSF AR Men – Wertung – Männer

StandNr: 128

Ranzani, Riccardo #260

StartNr: 119

9. Dezember 2018 9:22

ITA TSN Roma

Unterschrift des Schützen

Meyton Elektronik