

Ergebnis: **623.5** (596)
 Serien: 104.9 101.9 104.2 104.2 104.6 103.7
 Zähler: 56 4 0 0 0 0 0 0 0
 Innenzehner: 50
 weiteste: 328 (11), 305 (16), 291 (13)
 beste Teiler 47.2 (1.) 51.9 (53.) 52.4 (56.)
 Trefferlage 0.00 mm , 0.04 mm hoch
 Streuwert 1.10, horizontal: 1.16, vertikal: 1.04

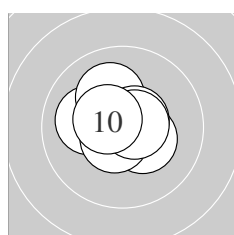

Serie 1:
 10.8 * 10.6 * 10.1 ← 10.4 * 10.6 *
 10.6 * 10.1 ↖ 10.6 * 10.6 * 10.5 *
 beste Teiler 47.2 (1.) 76.2 (6.) 78.8 (9.)
 Trefferlage 0.20 mm links, 0.32 mm hoch
 Streuwert 0.91, horizontal: 1.04, vertikal: 0.76

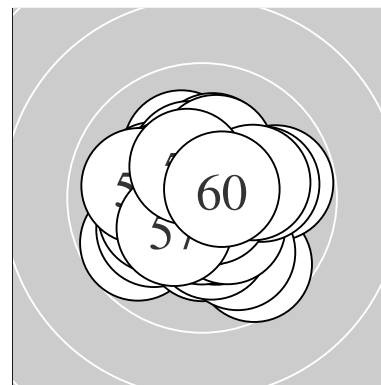
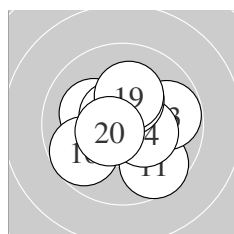

Serie 2:
 9.6 ↘ 10.5 * 9.8 → 10.4 * 10.2 *
 9.7 ↙ 10.6 * 10.3 * 10.2 * 10.6 *
 beste Teiler 79.9 (17.) 95.7 (20.) 118.0 (12.)
 Trefferlage 0.22 mm rechts, 0.05 mm hoch
 Streuwert 1.55, horizontal: 1.69, vertikal: 1.40

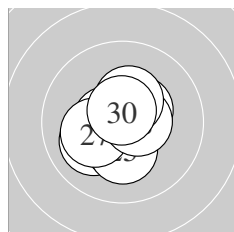

Serie 3:
 10.4 * 10.7 * 10.1 ↙ 10.4 * 10.2 *
 10.6 * 10.2 * 10.6 * 10.4 * 10.6 *
 beste Teiler 55.5 (22.) 76.2 (30.) 98.0 (28.)
 Trefferlage 0.30 mm links, 0.19 mm tief
 Streuwert 1.03, horizontal: 1.01, vertikal: 1.05

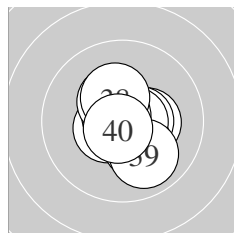

Serie 4:
 10.5 * 10.3 * 10.5 * 10.2 * 10.7 *
 10.7 * 10.4 * 10.3 * 9.9 ↘ 10.7 *
 beste Teiler 53.2 (36.) 57.4 (40.) 71.1 (35.)
 Trefferlage 0.27 mm rechts, 0.16 mm tief
 Streuwert 1.03, horizontal: 0.95, vertikal: 1.11

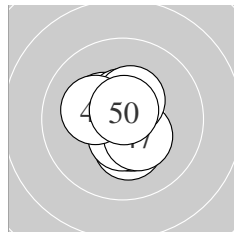

Serie 5:
 10.3 * 10.7 * 10.4 * 10.5 * 10.5 *
 10.5 * 10.4 * 10.4 * 10.2 * 10.7 *
 beste Teiler 55.5 (42.) 58.6 (50.) 102.3 (46.)
 Trefferlage 0.07 mm links, 0.14 mm tief
 Streuwert 0.97, horizontal: 0.84, vertikal: 1.08

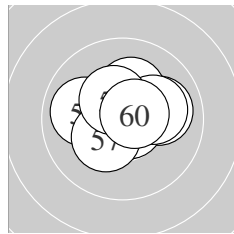

Serie 6:
 10.7 * 10.0 ← 10.7 * 10.0 → 10.2 *
 10.7 * 10.3 * 10.1 → 10.4 * 10.6 *
 beste Teiler 51.9 (53.) 52.4 (56.) 73.4 (51.)
 Trefferlage 0.13 mm rechts, 0.35 mm hoch
 Streuwert 1.16, horizontal: 1.41, vertikal: 0.85

Meyton Elektronik

ISSF AR Men – Wertung – **Männer**

StandNr: 148

Babuta, Arjun #70811265

StartNr: 46

21. Januar 2019 9:56

India

Unterschrift des Schützen

Meyton Elektronik

Ergebnis:	601.7	(570)
Serien:	101.8	100.2 99.0 100.0 100.3 100.4
Zähler:	32 27 0 1 0 0 0 0 0 0	
Innenzehner:	24	
weiteste:	760 (16), 468 (18), 440 (54)	
beste Teiler	12.1 (58.) 36.0 (11.) 36.4 (34.)	
Trefferlage	0.17 mm links, 0.21 mm hoch	
Streuwert	1.89, horizontal: 2.11, vertikal: 1.65	

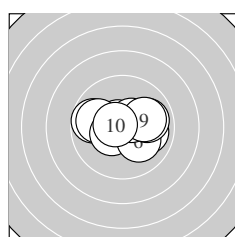
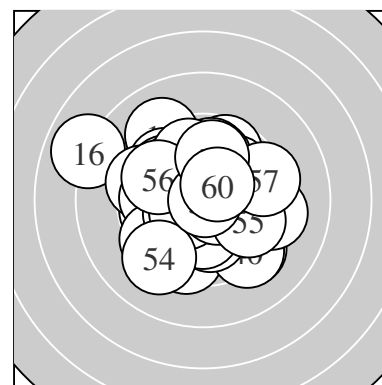

Serie 1:	10.0 →	10.7 *	9.7 ←	9.9 ←	10.4 *
	10.1 ↘	10.5 *	9.9 →	10.0 →	10.6 *
beste Teiler	71.5 (2.)	79.3 (10.)	111.8 (7.)		
Trefferlage	0.18 mm rechts, 0.18 mm hoch				
Streuwert	1.52, horizontal: 2.03, vertikal: 0.72				

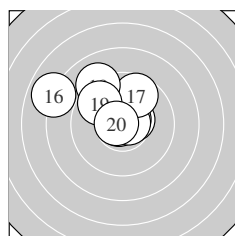

Serie 2:	10.8 *	10.5 *	10.5 *	10.6 *	10.7 *
	7.9 ←	9.7 ↑	9.1 ↘	9.7 ↘	10.7 *
beste Teiler	36.0 (11.)	59.4 (15.)	63.5 (20.)		
Trefferlage	0.99 mm links, 1.40 mm hoch				
Streuwert	2.03, horizontal: 2.48, vertikal: 1.46				

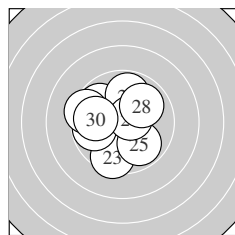

Serie 3:	10.4 *	9.8 ↘	9.5 ↓	9.8 ↑	9.9 ↘
	9.8 ←	10.6 *	9.9 ↗	9.4 ←	9.9 ←
beste Teiler	89.8 (27.)	140.9 (21.)	255.8 (28.)		
Trefferlage	0.88 mm links, 0.24 mm hoch				
Streuwert	1.95, horizontal: 2.01, vertikal: 1.88				

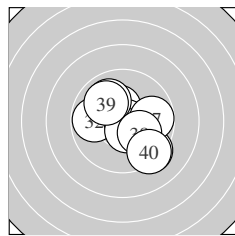

Serie 4:	9.3 ↘	9.8 ←	10.4 *	10.8 *	10.5 *
	10.0 ↘	9.8 →	10.1 ↘	10.0 ↘	9.3 ↘
beste Teiler	36.4 (34.)	106.1 (35.)	145.0 (33.)		
Trefferlage	0.46 mm rechts, 0.26 mm tief				
Streuwert	1.94, horizontal: 2.06, vertikal: 1.81				

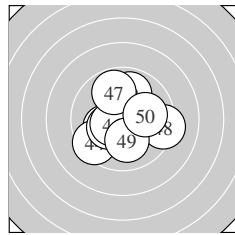

Serie 5:	10.7 *	9.9 ↑	10.2 *	9.5 ↗	10.3 *
	10.5 *	9.8 ↘	9.3 →	10.1 ↓	10.0 →
beste Teiler	54.7 (41.)	116.3 (46.)	163.1 (45.)		
Trefferlage	0.03 mm links, 0.11 mm tief				
Streuwert	1.89, horizontal: 2.05, vertikal: 1.72				

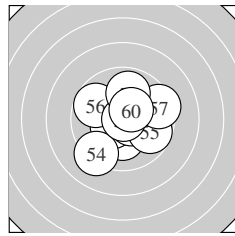

Serie 6:	10.2 *	10.4 *	10.6 *	9.2 ↗	9.7 →
	9.7 ↘	9.4 →	10.9 *	9.9 ↑	10.4 *
beste Teiler	12.1 (58.)	99.3 (53.)	128.0 (60.)		
Trefferlage	0.24 mm rechts, 0.17 mm tief				
Streuwert	1.93, horizontal: 2.05, vertikal: 1.80				

ISSF AR Men – Wertung – Männer

StandNr: 101

Heidegger, Daniel #312

StartNr: 47

21. Januar 2019 11:57

Wien

Unterschrift des Schützen

Meyton Elektronik

Ergebnis: **621.7** (597)
 Serien: 102.3 104.9 102.6 103.3 105.2 103.4
 Zähler: 57 3 0 0 0 0 0 0 0 0
 Innenzehner: 49
 weiteste: 284 (40), 283 (7), 259 (10)
 beste Teiler 26.2 (45.) 42.0 (55.) 45.1 (57.)
 Trefferlage 0.30 mm links, 0.18 mm hoch
 Streuwert 1.13, horizontal: 1.16, vertikal: 1.09

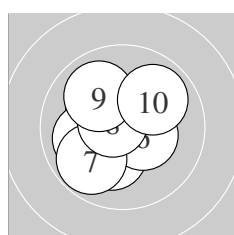
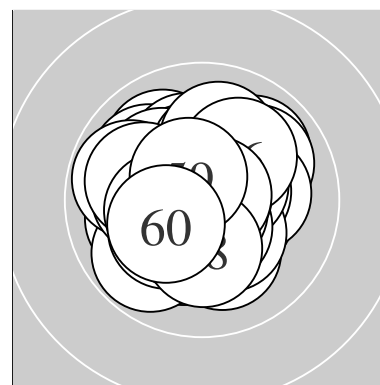

Serie 1:
 10.5 * 10.3 * 10.0 ← 10.5 * 10.2 *
 10.4 * 9.8 ↙ 10.7 * 10.0 ↘ 9.9 ↗
 beste Teiler 71.5 (8.) 103.5 (1.) 107.7 (4.)
 Trefferlage 0.44 mm links, 0.05 mm tief
 Streuwert 1.41, horizontal: 1.43, vertikal: 1.38

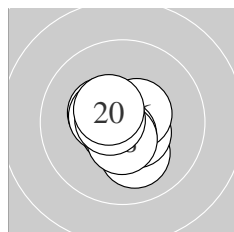

Serie 2:
 10.7 * 10.1 ↓ 10.5 * 10.4 * 10.5 *
 10.5 * 10.6 * 10.5 * 10.6 * 10.5 *
 beste Teiler 61.4 (11.) 80.3 (17.) 81.2 (19.)
 Trefferlage 0.22 mm links, 0.24 mm tief
 Streuwert 0.86, horizontal: 0.84, vertikal: 0.88

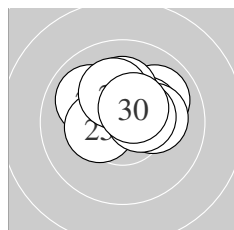

Serie 3:
 10.0 ↘ 10.0 ↗ 10.3 * 10.3 * 10.4 *
 10.2 * 10.2 * 10.2 * 10.5 * 10.5 *
 beste Teiler 113.4 (30.) 120.6 (29.) 149.6 (25.)
 Trefferlage 0.31 mm rechts, 1.01 mm hoch
 Streuwert 1.12, horizontal: 1.39, vertikal: 0.77

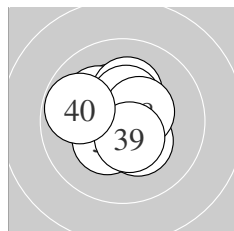

Serie 4:
 10.3 * 10.2 * 10.3 * 10.3 * 10.2 *
 10.8 * 10.4 * 10.5 * 10.5 * 9.8 ←
 beste Teiler 47.5 (36.) 112.0 (39.) 121.3 (38.)
 Trefferlage 0.29 mm links, 0.42 mm hoch
 Streuwert 1.17, horizontal: 1.19, vertikal: 1.16

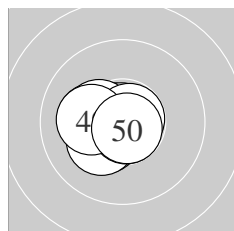

Serie 5:
 10.4 * 10.2 * 10.7 * 10.2 * 10.8 *
 10.8 * 10.3 * 10.8 * 10.2 * 10.8 *
 beste Teiler 26.2 (45.) 47.4 (46.) 47.8 (48.)
 Trefferlage 0.76 mm links, 0.14 mm tief
 Streuwert 0.77, horizontal: 0.93, vertikal: 0.57

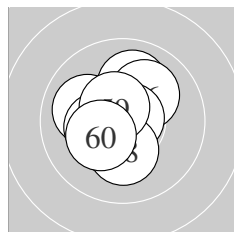

Serie 6:
 10.0 ↖ 10.3 * 10.4 * 10.0 ↑ 10.8 *
 10.1 ↗ 10.8 * 10.2 * 10.5 * 10.3 *
 beste Teiler 42.0 (55.) 45.1 (57.) 103.0 (59.)
 Trefferlage 0.43 mm links, 0.13 mm hoch
 Streuwert 1.19, horizontal: 1.09, vertikal: 1.29

Meyton Elektronik

ISSF AR Men – Wertung – **Männer**

StandNr: 102

Martz, Stephan #70811293

StartNr: 48

21. Januar 2019 11:56

SUI – ZH

Unterschrift des Schützen

Meyton Elektronik

Ergebnis: **623.1** (596)
 Serien: 103.8 104.4 103.5 103.4 103.9 104.1
 Zähler: 56 4 0 0 0 0 0 0 0
 Innenzehner: 47
 weiteste: 371 (5), 335 (14), 312 (56)
 beste Teiler 3.1 (41.) 20.0 (55.) 32.3 (38.)
 Trefferlage 0.45 mm rechts, 0.06 mm hoch
 Streuwert 1.11, horizontal: 1.14, vertikal: 1.07

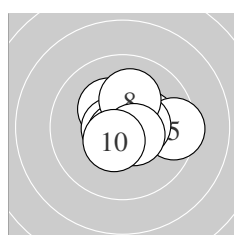
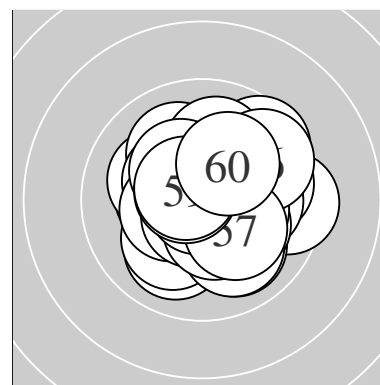

Serie 1:
 10.6 * 10.3 * 10.3 * 10.7 * 9.5 →
 10.7 * 10.5 * 10.1 † 10.6 * 10.5 *
 beste Teiler 58.5 (6.) 75.6 (4.) 82.3 (1.)
 Trefferlage 0.60 mm rechts, 0.15 mm hoch
 Streuwert 1.18, horizontal: 1.42, vertikal: 0.89

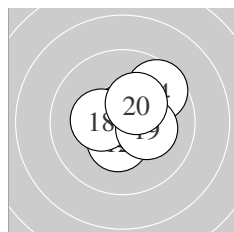

Serie 2:
 10.7 * 10.4 * 10.7 * 9.6 ↗ 10.7 *
 10.7 * 10.8 * 10.3 * 10.2 * 10.3 *
 beste Teiler 46.0 (17.) 58.2 (16.) 64.3 (15.)
 Trefferlage 0.50 mm rechts, 0.32 mm hoch
 Streuwert 1.06, horizontal: 1.10, vertikal: 1.01

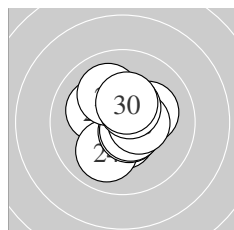

Serie 3:
 10.5 * 10.2 * 10.1 ↖ 10.0 ✓ 10.6 *
 10.6 * 10.1 ↘ 10.5 * 10.5 * 10.4 *
 beste Teiler 82.0 (26.) 82.6 (25.) 115.1 (21.)
 Trefferlage 0.08 mm rechts, 0.14 mm hoch
 Streuwert 1.20, horizontal: 1.13, vertikal: 1.27

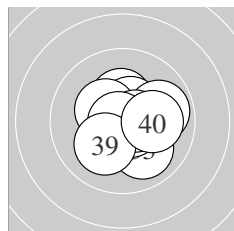

Serie 4:
 10.3 * 10.5 * 10.0 ↘ 10.4 * 9.9 →
 10.7 * 10.6 * 10.8 * 10.1 ✓ 10.1 →
 beste Teiler 32.3 (38.) 69.3 (36.) 92.0 (37.)
 Trefferlage 0.53 mm rechts, 0.00 mm
 Streuwert 1.22, horizontal: 1.31, vertikal: 1.12

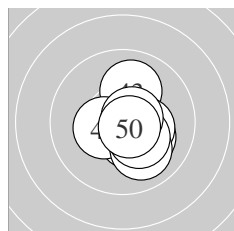

Serie 5:
 10.9 * 10.4 * 10.0 † 10.2 * 10.3 *
 10.4 * 10.0 ↘ 10.3 * 10.7 * 10.7 *
 beste Teiler 3.1 (41.) 60.2 (50.) 74.3 (49.)
 Trefferlage 0.66 mm rechts, 0.39 mm tief
 Streuwert 1.01, horizontal: 0.87, vertikal: 1.13

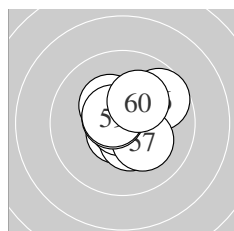

Serie 6:
 10.6 * 10.6 * 10.3 * 10.4 * 10.9 *
 9.7 ↗ 10.2 * 10.6 * 10.6 * 10.2 *
 beste Teiler 20.0 (55.) 79.1 (58.) 79.7 (51.)
 Trefferlage 0.36 mm rechts, 0.16 mm hoch
 Streuwert 1.12, horizontal: 1.15, vertikal: 1.10

ISSF AR Men – Wertung – Männer

StandNr: 103

Höllwarth, Michael #102

StartNr: 49

21. Januar 2019 11:49

AUT

Unterschrift des Schützen

Meyton Elektronik

Ergebnis: **624.5** (593)
 Serien: 104.8 103.6 103.2 103.5 104.1 105.3
 Zähler: 53 7 0 0 0 0 0 0 0
 Innenzehner: 49
 weiteste: 366 (44), 328 (42), 312 (39)
 beste Teiler 6.4 (23.) 16.1 (49.) 18.1 (4.)
 Trefferlage 0.01 mm links, 0.08 mm hoch
 Streuwert 1.13, horizontal: 1.23, vertikal: 1.03

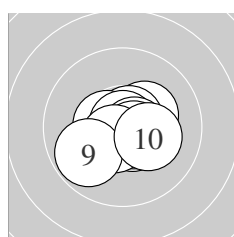
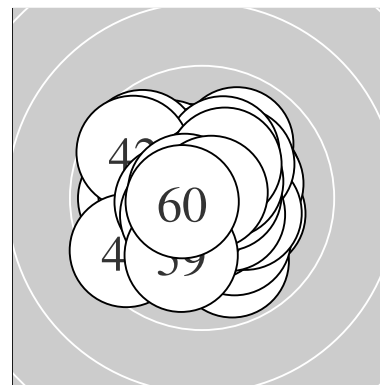

Serie 1:
 10.3 * 10.7 * 10.5 * 10.9 * 10.6 *
 10.6 * 10.6 * 10.6 * 9.8 ↙ 10.2 *
 beste Teiler 18.1 (4.) 65.9 (2.) 81.9 (6.)
 Trefferlage 0.19 mm rechts, 0.28 mm tief
 Streuwert 0.99, horizontal: 1.19, vertikal: 0.73

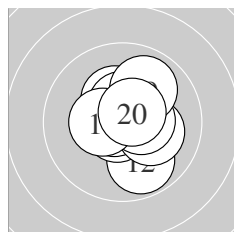

Serie 2:
 10.3 * 9.8 ↘ 10.7 * 10.7 * 10.2 *
 10.5 * 10.5 * 10.4 * 9.9 ↗ 10.6 *
 beste Teiler 54.5 (13.) 55.0 (14.) 91.2 (20.)
 Trefferlage 0.35 mm rechts, 0.19 mm hoch
 Streuwert 1.18, horizontal: 1.05, vertikal: 1.29

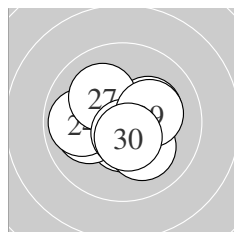

Serie 3:
 10.5 * 10.1 ← 10.9 * 9.9 ← 10.1 ↘
 10.2 * 10.1 ↘ 10.7 * 10.2 * 10.5 *
 beste Teiler 6.4 (23.) 73.5 (28.) 105.0 (21.)
 Trefferlage 0.09 mm links, 0.19 mm tief
 Streuwert 1.30, horizontal: 1.55, vertikal: 0.98

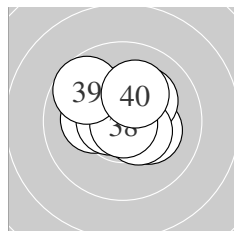

Serie 4:
 10.2 * 10.6 * 10.2 * 10.2 * 10.6 *
 10.4 * 10.5 * 10.9 * 9.7 ↘ 10.2 *
 beste Teiler 20.2 (38.) 76.2 (32.) 83.0 (35.)
 Trefferlage 0.05 mm rechts, 0.58 mm hoch
 Streuwert 1.19, horizontal: 1.36, vertikal: 1.00

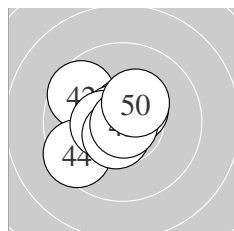

Serie 5:
 10.5 * 9.6 ↘ 10.7 * 9.5 ↙ 10.7 *
 10.8 * 10.5 * 10.6 * 10.9 * 10.3 *
 beste Teiler 16.1 (49.) 36.0 (46.) 54.2 (45.)
 Trefferlage 0.63 mm links, 0.15 mm hoch
 Streuwert 1.22, horizontal: 1.33, vertikal: 1.10

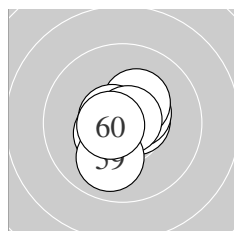

Serie 6:
 10.6 * 10.5 * 10.5 * 10.5 * 10.8 *
 10.3 * 10.7 * 10.8 * 10.0 ↓ 10.6 *
 beste Teiler 30.3 (55.) 42.1 (58.) 75.2 (57.)
 Trefferlage 0.05 mm rechts, 0.07 mm hoch
 Streuwert 0.90, horizontal: 0.81, vertikal: 0.99

Meyton Elektronik

ISSF AR Men – Wertung – Männer

StandNr: 105

Hrckulak, David #226

StartNr: 51

21. Januar 2019 11:54

CZE

Unterschrift des Schützen

Meyton Elektronik

Ergebnis:	625.5	(594) ^{QF}
Serien:	105.5	105.2 103.8 103.9 103.9 103.2
Zähler:	54	6 0 0 0 0 0 0 0 0
Innenzehner:	50	
weiteste:	307 (28),	299 (59), 275 (46)
beste Teiler	23.3 (14.)	37.3 (6.) 38.8 (20.)
Trefferlage	0.05 mm rechts, 0.22 mm hoch	
Streuwert	1.06, horizontal: 1.16, vertikal: 0.95	

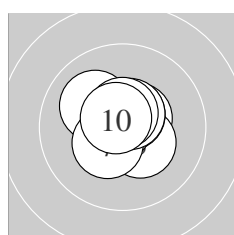
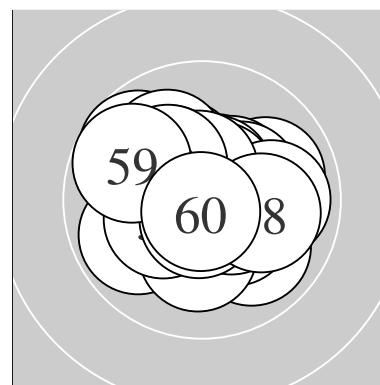

Serie 1:	10.5 *	10.8 *	10.4 *	10.6 *	10.1 ↘
	10.8 *	10.4 *	10.6 *	10.6 *	10.7 *
beste Teiler	37.3 (6.) 45.6 (2.) 70.8 (10.)				
Trefferlage	0.02 mm links, 0.29 mm hoch				
Streuwert	0.83, horizontal: 0.87, vertikal: 0.79				

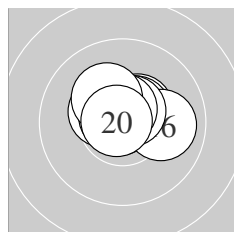

Serie 2:	10.4 *	10.5 *	10.7 *	10.9 *	10.5 *
	10.0 →	10.6 *	10.6 *	10.2 *	10.8 *
beste Teiler	23.3 (14.) 38.8 (20.) 66.4 (13.)				
Trefferlage	0.13 mm rechts, 0.56 mm hoch				
Streuwert	0.83, horizontal: 1.07, vertikal: 0.47				

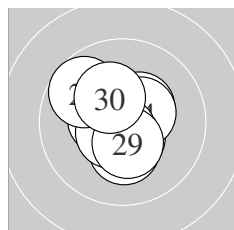

Serie 3:	10.5 *	10.5 *	10.4 *	10.4 *	10.7 *
	10.3 *	10.6 *	9.7 ↘	10.4 *	10.3 *
beste Teiler	63.1 (25.) 98.3 (27.) 106.5 (22.)				
Trefferlage	0.22 mm links, 0.01 mm tief				
Streuwert	1.16, horizontal: 1.09, vertikal: 1.23				

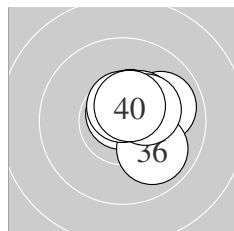

Serie 4:	10.5 *	10.8 *	10.5 *	10.5 *	9.9 →
	9.9 ↘	10.4 *	10.6 *	10.3 *	10.5 *
beste Teiler	46.6 (32.) 90.0 (38.) 105.1 (40.)				
Trefferlage	0.93 mm rechts, 0.53 mm hoch				
Streuwert	0.82, horizontal: 0.81, vertikal: 0.83				

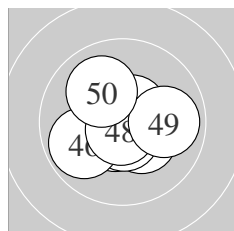

Serie 5:	10.3 *	10.6 *	10.6 *	10.5 *	10.7 *
	9.9 ↙	10.6 *	10.8 *	9.9 →	10.0 ↘
beste Teiler	49.0 (48.) 71.4 (45.) 85.5 (43.)				
Trefferlage	0.13 mm links, 0.07 mm tief				
Streuwert	1.22, horizontal: 1.39, vertikal: 1.01				

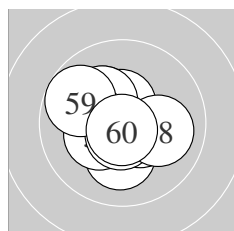

Serie 6:	10.2 *	10.3 *	10.5 *	10.7 *	10.2 *
	10.5 *	10.2 *	10.0 →	9.8 ↘	10.8 *
beste Teiler	44.2 (60.) 72.0 (54.) 113.7 (56.)				
Trefferlage	0.37 mm links, 0.03 mm hoch				
Streuwert	1.28, horizontal: 1.38, vertikal: 1.18				

ISSF AR Men – Wertung – Männer

StandNr: 106

Kamenskii, Sergei #70811295

StartNr: 52

21. Januar 2019 11:34

RUS

QF – Schütze hat sich fürs Finale qualifiziert

Unterschrift des Schützen

Meyton Elektronik

Ergebnis:	587.8	(562)
Serien:	97.9 97.3 100.9 95.1 98.6 98.0	
Zähler:	27 28 5 0 0 0 0 0 0	
Innenzehner:	21	
weiteste:	738 (33), 633 (46), 582 (19)	
beste Teiler	39.2 (28.) 60.2 (43.) 88.5 (1.)	
Trefferlage	0.41 mm rechts, 0.69 mm hoch	
Streuwert	2.26, horizontal: 2.46, vertikal: 2.04	

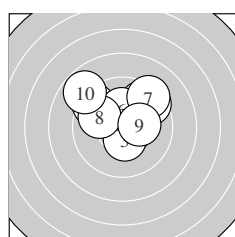
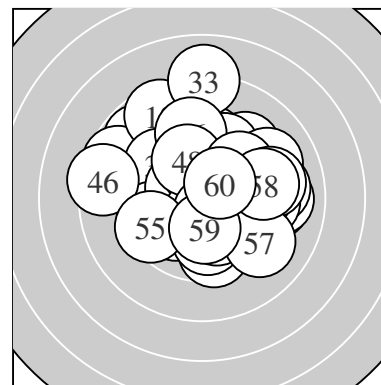

Serie 1:					
	10.6 *	9.4 ↘	10.4 *	9.5 ↗	9.6 ↗
	10.2 *	9.3 ↗	9.9 ↘	10.2 *	8.8 ↘
beste Teiler	88.5 (1.)	132.0 (3.)	178.0 (9.)		
Trefferlage	0.07 mm rechts, 1.56 mm hoch				
Streuwert	2.07, horizontal: 2.44, vertikal: 1.62				

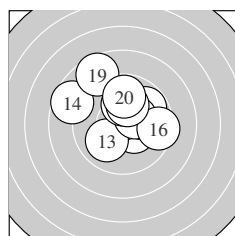

Serie 2:					
	10.4 *	9.8 ↗	10.0 ↙	8.7 ↖	10.4 *
	9.4 →	10.1 ↑	10.1 ↑	8.6 ↖	9.8 ↑
beste Teiler	144.7 (11.)	150.2 (15.)	204.4 (18.)		
Trefferlage	0.02 mm links, 1.38 mm hoch				
Streuwert	2.33, horizontal: 2.60, vertikal: 2.02				

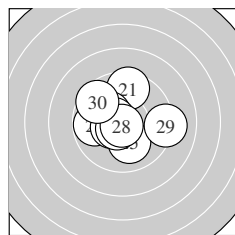

Serie 3:					
	9.5 ↑	10.3 *	9.8 ←	10.6 *	10.1 ↓
	10.5 *	10.6 *	10.8 *	9.1 →	9.6 ↘
beste Teiler	39.2 (28.)	89.2 (27.)	95.5 (24.)		
Trefferlage	0.39 mm links, 0.26 mm hoch				
Streuwert	1.86, horizontal: 2.10, vertikal: 1.59				

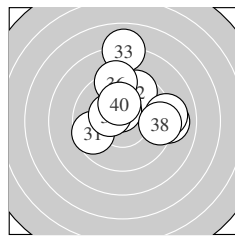

Serie 4:					
	9.6 ←	9.6 ↑	8.0 ↑	10.5 *	9.0 →
	9.3 ↑	9.1 →	9.4 →	10.4 *	10.2 *
beste Teiler	111.0 (34.)	147.5 (39.)	185.1 (40.)		
Trefferlage	0.90 mm rechts, 1.71 mm hoch				
Streuwert	2.61, horizontal: 2.68, vertikal: 2.54				

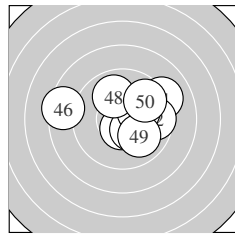

Serie 5:					
	9.1 ↗	9.6 →	10.7 *	10.6 *	10.4 *
	8.4 ←	10.2 *	9.9 ↖	10.0 ↘	9.7 ↗
beste Teiler	60.2 (43.)	98.0 (44.)	140.7 (45.)		
Trefferlage	0.71 mm rechts, 0.50 mm hoch				
Streuwert	2.28, horizontal: 2.88, vertikal: 1.44				

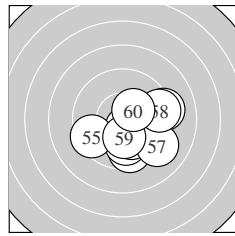

Serie 6:					
	9.2 →	10.6 *	9.6 ↓	9.9 ↓	9.5 ←
	10.1 ↓	9.1 ↘	9.4 →	10.2 *	10.4 *
beste Teiler	97.9 (52.)	146.2 (60.)	189.7 (59.)		
Trefferlage	1.22 mm rechts, 1.25 mm tief				
Streuwert	1.95, horizontal: 2.23, vertikal: 1.64				

Meyton Elektronik

ISSF AR Men – Wertung – **Männer**

StandNr: 107

Prakash, Nitesh #70811296

StartNr: 53

21. Januar 2019 11:22

IND

Unterschrift des Schützen

Meyton Elektronik

Ergebnis: **626.6** (597)^{QF}

Serien: 103.1 103.4 105.6 104.2 105.3 105.0

Zähler: 57 3 0 0 0 0 0 0 0 0

Innenzehner: 49

weiteste: 315 (39), 303 (17), 261 (26)

beste Teiler 25.0 (30.) 26.0 (51.) 36.4 (23.)

Trefferlage 0.25 mm links, 0.28 mm hoch

Streuwert 0.99, horizontal: 0.88, vertikal: 1.09

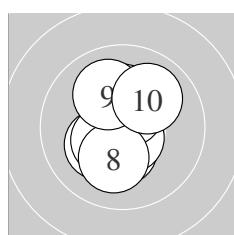
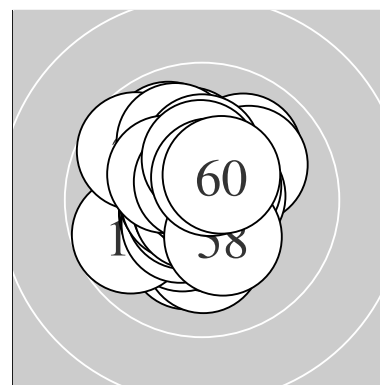

Serie 1:

10.2 *	10.4 *	10.7 *	10.6 *	10.2 *
10.4 *	10.5 *	10.1 ↓	10.0 ↖	10.0 ↗

beste Teiler 64.7 (3.) 78.0 (4.) 108.1 (7.)

Trefferlage 0.18 mm links, 0.13 mm hoch

Streuwert 1.23, horizontal: 0.88, vertikal: 1.50

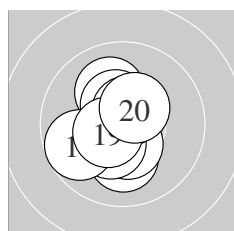

Serie 2:

10.8 *	10.1 ↓	10.4 *	10.4 *	10.1 ↖
10.4 *	9.7 ↖	10.6 *	10.5 *	10.4 *

beste Teiler 43.1 (11.) 86.6 (18.) 106.5 (19.)

Trefferlage 0.43 mm links, 0.17 mm tief

Streuwert 1.19, horizontal: 0.98, vertikal: 1.37

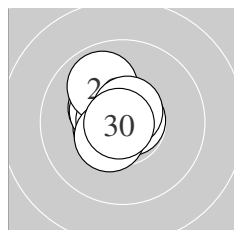

Serie 3:

10.3 *	10.6 *	10.8 *	10.4 *	10.7 *
9.9 ↖	10.8 *	10.5 *	10.7 *	10.9 *

beste Teiler 25.0 (30.) 36.4 (23.) 50.2 (27.)

Trefferlage 0.59 mm links, 0.35 mm hoch

Streuwert 0.76, horizontal: 0.63, vertikal: 0.86

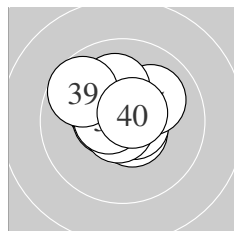

Serie 4:

10.6 *	10.4 *	10.7 *	10.6 *	10.1 ↗
10.1 ↖	10.8 *	10.6 *	9.7 ↖	10.6 *

beste Teiler 49.9 (37.) 73.7 (33.) 80.9 (40.)

Trefferlage 0.25 mm links, 0.54 mm hoch

Streuwert 1.10, horizontal: 1.23, vertikal: 0.95

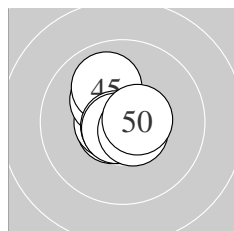

Serie 5:

10.6 *	10.6 *	10.2 *	10.6 *	10.0 ↖
10.8 *	10.6 *	10.7 *	10.6 *	10.6 *

beste Teiler 50.2 (46.) 54.4 (48.) 78.0 (41.)

Trefferlage 0.12 mm links, 0.20 mm hoch

Streuwert 0.86, horizontal: 0.83, vertikal: 0.89

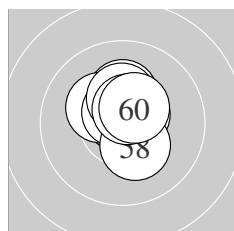

Serie 6:

10.8 *	10.8 *	10.2 *	10.6 *	10.3 *
10.6 *	10.3 *	10.3 *	10.6 *	10.5 *

beste Teiler 26.0 (51.) 48.3 (52.) 78.7 (56.)

Trefferlage 0.08 mm rechts, 0.64 mm hoch

Streuwert 0.78, horizontal: 0.66, vertikal: 0.89

ISSF AR Men – Wertung – Männer

StandNr: 108

Piasecki, Pierre-Edmond #70811297

StartNr: 54

21. Januar 2019 11:42

FRA

QF – Schütze hat sich fürs Finale qualifiziert

Unterschrift des Schützen

Meyton Elektronik

Ergebnis: **588.7** (563)

Serien: 98.4 97.2 97.2 97.1 100.7 98.1

Zähler: 28 27 5 0 0 0 0 0 0 0

Innenzehner: 18

weiteste: 591 (22), 564 (35), 548 (16)

beste Teiler 62.0 (19.) 75.1 (45.) 78.6 (28.)

Trefferlage 0.27 mm links, 0.11 mm tief

Streuwert 2.22, horizontal: 2.60, vertikal: 1.77

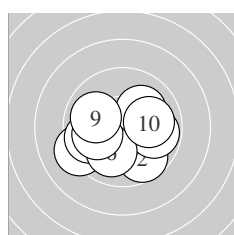
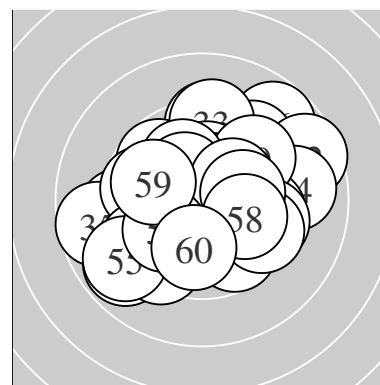

Serie 1:

10.0 ↙	9.7 ↘	9.8 →	9.2 ↙	9.7 ←
10.0 ↙	10.0 ←	10.1 ↗	9.9 ↖	10.0 →

beste Teiler 216.7 (8.) 229.5 (1.) 231.4 (7.)

Trefferlage 0.52 mm links, 0.78 mm tief

Streuwert 1.96, horizontal: 2.41, vertikal: 1.38

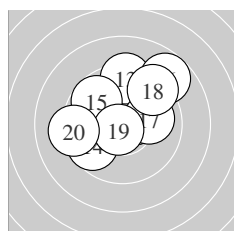

Serie 2:

10.0 ↗	10.5 *	9.3 ↑	9.7 ↙	9.7 ↘
8.8 ↗	10.0 →	9.3 ↗	10.7 *	9.2 ←

beste Teiler 62.0 (19.) 104.5 (12.) 238.0 (17.)

Trefferlage 0.22 mm rechts, 1.25 mm hoch

Streuwert 2.33, horizontal: 2.62, vertikal: 2.01

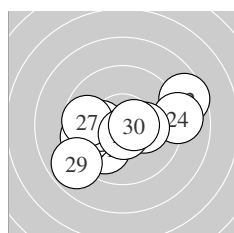

Serie 3:

9.9 ↙	8.6 →	9.6 ←	9.0 →	10.2 *
10.2 *	9.7 ←	10.6 *	8.8 ↙	10.6 *

beste Teiler 78.6 (28.) 100.0 (30.) 189.2 (26.)

Trefferlage 0.06 mm links, 0.42 mm tief

Streuwert 2.60, horizontal: 3.34, vertikal: 1.54

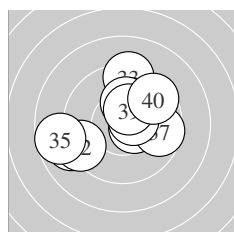

Serie 4:

9.0 ←	9.3 ←	9.3 ↑	10.5 *	8.7 ←
10.2 *	9.6 →	10.5 *	10.4 *	9.6 ↗

beste Teiler 102.5 (38.) 107.5 (34.) 140.6 (39.)

Trefferlage 0.44 mm links, 0.39 mm hoch

Streuwert 2.56, horizontal: 3.03, vertikal: 1.98

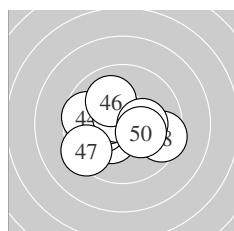

Serie 5:

10.3 *	10.2 *	10.4 *	9.7 ↖	10.7 *
10.0 ↘	9.4 ↙	9.5 →	10.3 *	10.2 *

beste Teiler 75.1 (45.) 144.2 (43.) 159.2 (41.)

Trefferlage 0.51 mm links, 0.19 mm tief

Streuwert 1.76, horizontal: 2.17, vertikal: 1.22

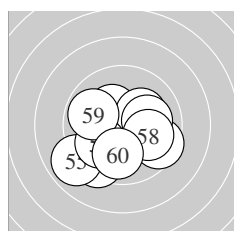

Serie 6:

9.4 ↙	9.5 ↘	10.3 *	10.2 *	8.9 ↙
9.9 ↙	10.1 →	10.0 →	9.9 ↖	9.9 ↓

beste Teiler 161.7 (53.) 190.0 (54.) 218.5 (57.)

Trefferlage 0.29 mm links, 0.93 mm tief

Streuwert 2.13, horizontal: 2.45, vertikal: 1.76

ISSF AR Men – Wertung – Männer

StandNr: 109

Muhammad, Fathir Bin Ahmad #70811195

StartNr: 55

21. Januar 2019 11:43

SGP

Unterschrift des Schützen

Meyton Elektronik

Ergebnis: **614.5** (587)
 Serien: 101.7 103.3 103.1 102.2 103.0 101.2
 Zähler: 47 13 0 0 0 0 0 0 0
 Innenzehner: 38
 weiteste: 486 (12), 390 (53), 361 (55)
 beste Teiler 33.8 (59.) 44.5 (35.) 50.1 (48.)
 Trefferlage 0.15 mm rechts, 0.00 mm
 Streuwert 1.43, horizontal: 1.54, vertikal: 1.31

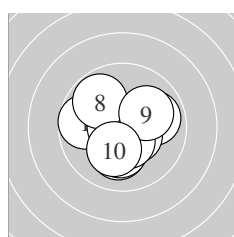
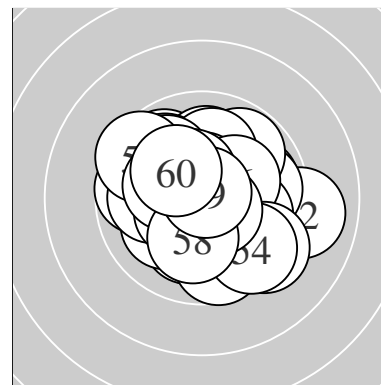

Serie 1:
 9.7 ← 9.9 → 10.5 * 10.7 * 10.1 ↓
 10.2 * 10.5 * 9.8 ↘ 10.1 ↗ 10.2 *
 beste Teiler 66.0 (4.) 123.1 (3.) 123.3 (7.)
 Trefferlage 0.09 mm links, 0.32 mm tief
 Streuwert 1.56, horizontal: 1.67, vertikal: 1.44

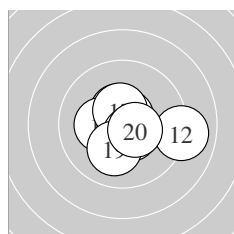

Serie 2:
 10.5 * 9.0 → 10.7 * 10.7 * 10.5 *
 10.3 * 10.5 * 10.5 * 10.1 ↓ 10.5 *
 beste Teiler 61.4 (13.) 66.6 (14.) 102.6 (18.)
 Trefferlage 0.27 mm rechts, 0.00 mm
 Streuwert 1.44, horizontal: 1.77, vertikal: 1.01

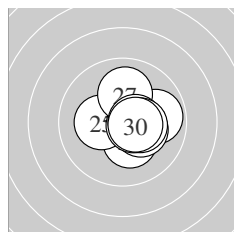

Serie 3:
 10.3 * 10.3 * 9.9 → 10.3 * 10.3 *
 10.6 * 10.0 ↑ 10.5 * 10.4 * 10.5 *
 beste Teiler 93.0 (26.) 105.0 (28.) 107.0 (30.)
 Trefferlage 0.91 mm rechts, 0.04 mm hoch
 Streuwert 1.06, horizontal: 1.14, vertikal: 0.98

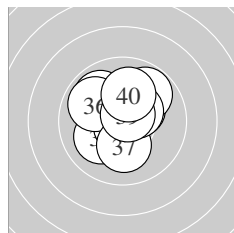

Serie 4:
 10.1 ↙ 10.3 * 9.9 ↘ 9.8 ↗ 10.8 *
 9.9 ↘ 10.2 * 10.4 * 10.7 * 10.1 ↑
 beste Teiler 44.5 (35.) 68.4 (39.) 138.0 (38.)
 Trefferlage 0.07 mm links, 0.63 mm hoch
 Streuwert 1.43, horizontal: 1.42, vertikal: 1.44

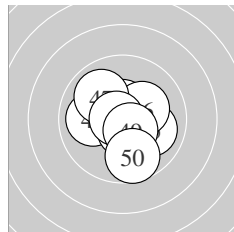

Serie 5:
 10.7 * 10.0 ← 10.6 * 10.6 * 10.0 →
 10.2 * 9.9 ↘ 10.8 * 10.5 * 9.7 ↓
 beste Teiler 50.1 (48.) 57.7 (41.) 93.3 (44.)
 Trefferlage 0.09 mm rechts, 0.14 mm tief
 Streuwert 1.38, horizontal: 1.40, vertikal: 1.36

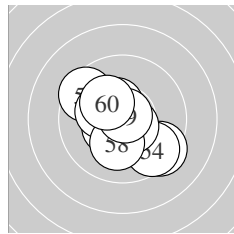

Serie 6:
 10.4 * 10.4 * 9.4 ↘ 9.6 ↘ 9.5 ↘
 10.6 * 10.2 * 10.1 ↓ 10.8 * 10.2 *
 beste Teiler 33.8 (59.) 93.0 (56.) 126.6 (51.)
 Trefferlage 0.16 mm links, 0.27 mm tief
 Streuwert 1.74, horizontal: 1.85, vertikal: 1.62

Meyton Elektronik

ISSF AR Men – Wertung – **Männer**

StandNr: 110

Köppel, Michael #70811298

StartNr: 56

21. Januar 2019 11:35

SUI – Sportschützen Sargans

Unterschrift des Schützen

Meyton Elektronik

Ergebnis: **627.2** (597)^{QF}
 Serien: 104.2 105.6 105.3 104.1 104.3 103.7
 Zähler: 57 3 0 0 0 0 0 0 0 0
 Innenzehner: 49
 weiteste: 401 (58), 323 (32), 286 (50)
 beste Teiler 6.4 (37.) 23.0 (47.) 39.0 (28.)
 Trefferlage 0.08 mm rechts, 0.19 mm hoch
 Streuwert 1.04, horizontal: 1.09, vertikal: 0.98

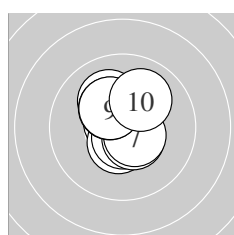
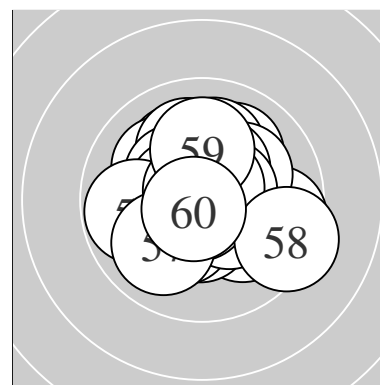

Serie 1:
 10.7 * 10.5 * 10.1 ↗ 10.7 * 10.5 *
 10.6 * 10.5 * 10.3 * 10.3 * 10.0 ↗
 beste Teiler 65.0 (1.) 75.0 (4.) 90.7 (6.)
 Trefferlage 0.02 mm links, 0.44 mm hoch
 Streuwert 1.02, horizontal: 0.83, vertikal: 1.18

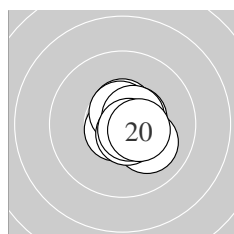

Serie 2:
 10.5 * 10.7 * 10.7 * 10.6 * 10.6 *
 10.1 ↘ 10.6 * 10.6 * 10.7 * 10.5 *
 beste Teiler 56.4 (12.) 60.9 (19.) 64.0 (13.)
 Trefferlage 0.49 mm rechts, 0.00 mm
 Streuwert 0.71, horizontal: 0.67, vertikal: 0.75

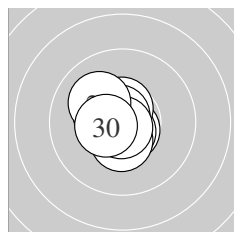

Serie 3:
 10.7 * 10.7 * 10.4 * 10.4 * 10.6 *
 10.7 * 10.4 * 10.8 * 10.1 ↗ 10.5 *
 beste Teiler 39.0 (28.) 51.3 (26.) 70.4 (22.)
 Trefferlage 0.53 mm links, 0.05 mm hoch
 Streuwert 0.79, horizontal: 0.74, vertikal: 0.83

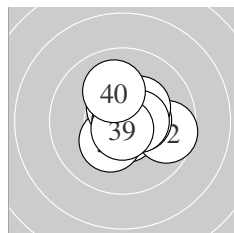

Serie 4:
 10.7 * 9.7 → 10.4 * 10.3 * 10.5 *
 10.3 * 10.9 * 10.5 * 10.7 * 10.1 ↗
 beste Teiler 6.4 (37.) 56.0 (39.) 75.9 (31.)
 Trefferlage 0.51 mm rechts, 0.07 mm hoch
 Streuwert 1.12, horizontal: 1.19, vertikal: 1.04

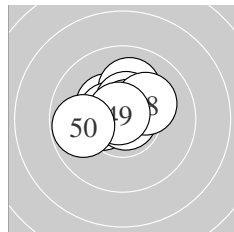

Serie 5:
 10.4 * 10.4 * 10.1 ↑ 10.5 * 10.5 *
 10.7 * 10.9 * 10.2 * 10.8 * 9.8 ←
 beste Teiler 23.0 (47.) 48.8 (49.) 68.0 (46.)
 Trefferlage 0.36 mm links, 0.63 mm hoch
 Streuwert 1.04, horizontal: 1.25, vertikal: 0.76

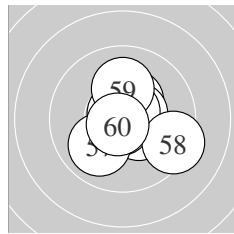

Serie 6:
 10.8 * 10.4 * 10.8 * 10.4 * 10.5 *
 10.7 * 10.0 ↗ 9.3 ↘ 10.1 ↑ 10.7 *
 beste Teiler 42.0 (53.) 50.8 (51.) 53.0 (60.)
 Trefferlage 0.44 mm rechts, 0.02 mm tief
 Streuwert 1.32, horizontal: 1.39, vertikal: 1.25

Meyton Elektronik

ISSF AR Men – Wertung – Männer

StandNr: 111

Okada, Naoya #70811299

StartNr: 57

21. Januar 2019 11:44

JPN

QF – Schütze hat sich fürs Finale qualifiziert

Unterschrift des Schützen

Meyton Elektronik

Ergebnis: **625.3** (594)
 Serien: 103.5 103.6 103.3 105.0 105.7 104.2
 Zähler: 54 6 0 0 0 0 0 0 0
 Innenzehner: 50
 weiteste: 363 (22), 314 (15), 308 (27)
 beste Teiler 22.6 (36.) 36.2 (14.) 42.1 (3.)
 Trefferlage 0.03 mm links, 0.09 mm hoch
 Streuwert 1.08, horizontal: 1.25, vertikal: 0.89

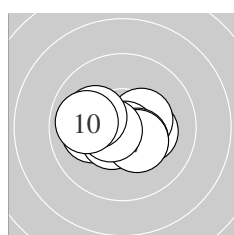
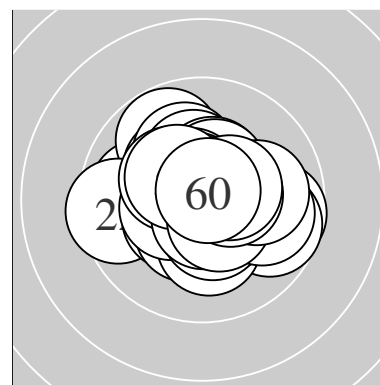

Serie 1:
 10.3 * 10.4 * 10.8 * 10.4 * 10.1 ←
 10.5 * 10.4 * 10.6 * 10.1 ↖ 9.9 ←
 beste Teiler 42.1 (3.) 87.0 (8.) 108.1 (6.)
 Trefferlage 0.29 mm links, 0.22 mm tief
 Streuwert 1.19, horizontal: 1.57, vertikal: 0.59

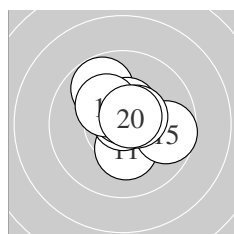

Serie 2:
 10.3 * 10.5 * 9.8 ↗ 10.8 * 9.7 →
 10.6 * 10.5 * 10.3 * 10.5 * 10.6 *
 beste Teiler 36.2 (14.) 78.4 (20.) 81.0 (16.)
 Trefferlage 0.26 mm rechts, 0.59 mm hoch
 Streuwert 1.19, horizontal: 1.23, vertikal: 1.14

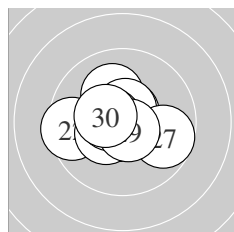

Serie 3:
 10.7 * 9.5 ← 10.6 * 10.1 ↗ 10.4 *
 10.6 * 9.7 ↘ 10.6 * 10.7 * 10.4 *
 beste Teiler 63.5 (21.) 71.0 (29.) 77.4 (23.)
 Trefferlage 0.40 mm links, 0.06 mm hoch
 Streuwert 1.33, horizontal: 1.65, vertikal: 0.92

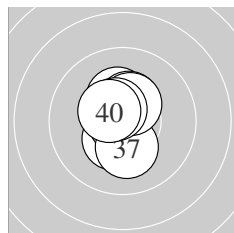

Serie 4:
 10.3 * 10.4 * 10.7 * 10.6 * 10.4 *
 10.9 * 10.2 * 10.4 * 10.6 * 10.5 *
 beste Teiler 22.6 (36.) 63.3 (33.) 91.9 (34.)
 Trefferlage 0.17 mm links, 0.21 mm hoch
 Streuwert 0.91, horizontal: 0.48, vertikal: 1.19

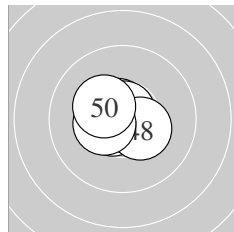

Serie 5:
 10.6 * 10.6 * 10.7 * 10.7 * 10.7 *
 10.5 * 10.8 * 10.4 * 10.4 * 10.3 *
 beste Teiler 47.6 (47.) 60.8 (44.) 66.0 (45.)
 Trefferlage 0.42 mm links, 0.07 mm hoch
 Streuwert 0.70, horizontal: 0.85, vertikal: 0.51

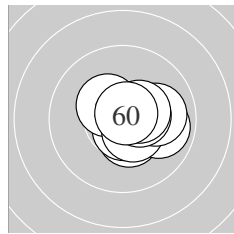

Serie 6:
 10.4 * 10.6 * 9.9 → 10.7 * 10.4 *
 10.5 * 10.0 → 10.5 * 10.4 * 10.8 *
 beste Teiler 47.7 (60.) 72.3 (54.) 92.6 (52.)
 Trefferlage 0.84 mm rechts, 0.15 mm tief
 Streuwert 0.91, horizontal: 1.07, vertikal: 0.72

Meyton Elektronik

ISSF AR Men – Wertung – Männer

StandNr: 112

Germond, Etienne #70811300

StartNr: 58

21. Januar 2019 11:57

FRA

Unterschrift des Schützen

Meyton Elektronik

Ergebnis:	627.8	(596) ^{QF}							
Serien:	104.4	105.6	104.4	104.0	105.1	104.3			
Zähler:	56	4	0	0	0	0	0	0	0
Innenzehner:	54								
weiteste:	284 (56), 273 (48), 260 (9)								
beste Teiler	38.8 (1.) 39.4 (41.) 43.9 (26.)								
Trefferlage	0.09 mm rechts, 0.19 mm tief								
Streuwert	0.96, horizontal: 0.91, vertikal: 1.02								

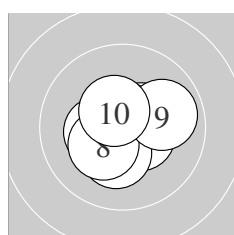
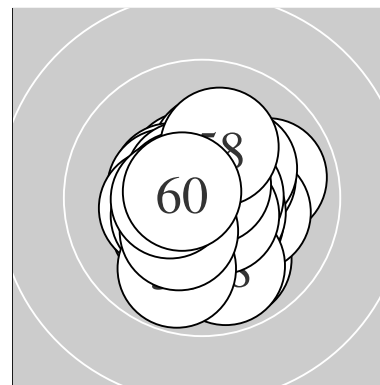

Serie 1:	10.8 *	10.7 *	10.4 *	10.3 *	10.7 *
	10.5 *	10.3 *	10.3 *	9.9 →	10.5 *
beste Teiler	38.8 (1.) 54.2 (2.) 60.8 (5.)				
Trefferlage	0.17 mm rechts, 0.13 mm tief				
Streuwert	1.04, horizontal: 1.20, vertikal: 0.86				

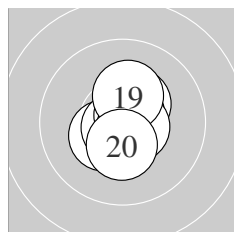

Serie 2:	10.6 *	10.4 *	10.8 *	10.7 *	10.4 *
	10.7 *	10.7 *	10.6 *	10.3 *	10.4 *
beste Teiler	50.9 (13.) 55.4 (14.) 61.5 (16.)				
Trefferlage	0.22 mm rechts, 0.06 mm hoch				
Streuwert	0.80, horizontal: 0.61, vertikal: 0.96				

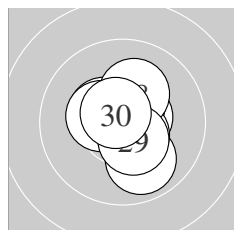

Serie 3:	10.4 *	10.4 *	9.9 ↓	10.6 *	10.5 *
	10.8 *	10.5 *	10.2 *	10.4 *	10.7 *
beste Teiler	43.9 (26.) 72.8 (30.) 98.3 (24.)				
Trefferlage	0.19 mm rechts, 0.08 mm hoch				
Streuwert	1.05, horizontal: 0.88, vertikal: 1.19				

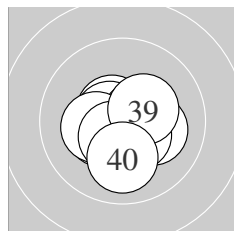

Serie 4:	10.6 *	10.6 *	10.5 *	10.2 *	10.5 *
	10.4 *	10.3 *	10.5 *	10.4 *	10.0 ↓
beste Teiler	85.3 (32.) 94.0 (31.) 102.7 (33.)				
Trefferlage	0.00 mm , 0.37 mm tief				
Streuwert	1.07, horizontal: 1.20, vertikal: 0.93				

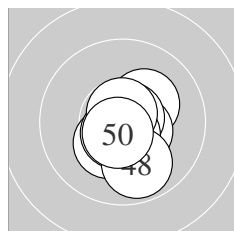

Serie 5:	10.8 *	10.2 *	10.3 *	10.5 *	10.8 *
	10.6 *	10.6 *	9.9 ↓	10.7 *	10.7 *
beste Teiler	39.4 (41.) 48.2 (45.) 55.2 (49.)				
Trefferlage	0.20 mm rechts, 0.51 mm tief				
Streuwert	0.88, horizontal: 0.70, vertikal: 1.03				

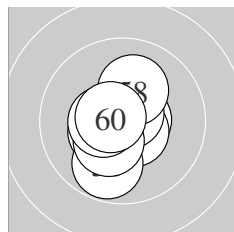

Serie 6:	10.6 *	10.7 *	10.6 *	10.7 *	10.4 *
	9.8 ↓	10.3 *	10.1 ↑	10.5 *	10.6 *
beste Teiler	61.4 (54.) 74.2 (52.) 79.6 (60.)				
Trefferlage	0.19 mm links, 0.31 mm tief				
Streuwert	1.05, horizontal: 0.88, vertikal: 1.20				

ISSF AR Men – Wertung – Männer

StandNr: 113

Zott, Georg #88

StartNr: 59

21. Januar 2019 11:30

AUT

QF – Schütze hat sich fürs Finale qualifiziert

Unterschrift des Schützen

Meyton Elektronik

Ergebnis: **618.6** (591)
 Serien: 103.4 102.6 103.5 104.6 103.0 101.5
 Zähler: 51 9 0 0 0 0 0 0 0
 Innenzehner: 46
 weiteste: 420 (15), 394 (58), 392 (51)
 beste Teiler 24.3 (33.) 48.2 (48.) 52.3 (43.)
 Trefferlage 0.13 mm rechts, 0.15 mm tief
 Streuwert 1.30, horizontal: 1.50, vertikal: 1.06

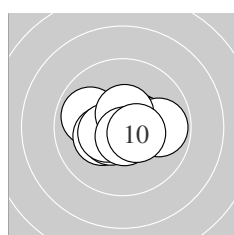
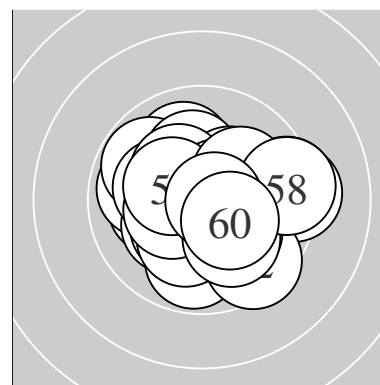

Serie 1:
 9.9 ↖ 10.3 * 10.5 * 10.4 * 10.5 *
 10.3 * 9.8 → 10.5 * 10.7 * 10.5 *
 beste Teiler 71.3 (9.) 103.0 (8.) 106.8 (5.)
 Trefferlage 0.05 mm rechts, 0.06 mm tief
 Streuwert 1.21, horizontal: 1.60, vertikal: 0.63

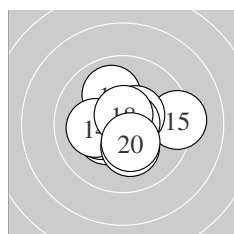

Serie 2:
 10.4 * 10.0 ↗ 10.3 * 10.1 ← 9.3 →
 10.5 * 10.7 * 10.7 * 10.2 * 10.4 *
 beste Teiler 61.4 (17.) 71.3 (18.) 120.4 (16.)
 Trefferlage 0.12 mm rechts, 0.06 mm tief
 Streuwert 1.50, horizontal: 1.78, vertikal: 1.16

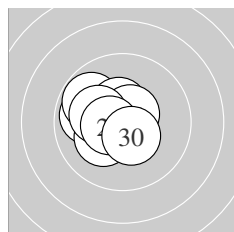

Serie 3:
 10.7 * 9.9 ↖ 9.8 ↖ 10.5 * 10.6 *
 10.2 * 10.6 * 10.2 * 10.5 * 10.5 *
 beste Teiler 52.4 (21.) 80.6 (25.) 84.1 (27.)
 Trefferlage 0.87 mm links, 0.25 mm hoch
 Streuwert 1.05, horizontal: 1.20, vertikal: 0.87

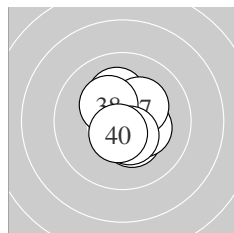

Serie 4:
 10.5 * 10.2 * 10.9 * 10.6 * 10.4 *
 10.3 * 10.3 * 10.3 * 10.5 * 10.6 *
 beste Teiler 24.3 (33.) 79.7 (34.) 99.9 (40.)
 Trefferlage 0.19 mm rechts, 0.22 mm hoch
 Streuwert 1.00, horizontal: 0.85, vertikal: 1.12

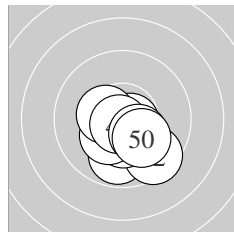

Serie 5:
 9.8 ↓ 9.5 ↘ 10.7 * 10.4 * 10.7 *
 10.3 * 10.4 * 10.8 * 10.3 * 10.1 ↘
 beste Teiler 48.2 (48.) 52.3 (43.) 63.0 (45.)
 Trefferlage 0.29 mm rechts, 1.15 mm tief
 Streuwert 1.08, horizontal: 1.13, vertikal: 1.03

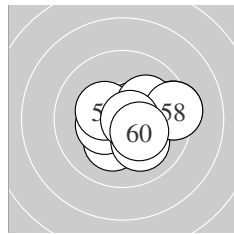

Serie 6:
 9.4 → 10.6 * 10.2 * 10.4 * 10.3 *
 10.1 ↘ 10.1 ↗ 9.4 → 10.7 * 10.3 *
 beste Teiler 56.3 (59.) 97.4 (52.) 144.5 (54.)
 Trefferlage 1.00 mm rechts, 0.13 mm tief
 Streuwert 1.52, horizontal: 1.89, vertikal: 1.05

Meyton Elektronik

ISSF AR Men – Wertung – Männer

StandNr: 114

Shimada, Atsushi #70811301

StartNr: 60

21. Januar 2019 11:57

JPN

Unterschrift des Schützen

Meyton Elektronik

Ergebnis:	620.1	(594)							
Serien:	104.0	102.9	102.1	103.1	104.3	103.7			
Zähler:	54	6	0	0	0	0	0	0	0
Innenzehner:	45								
weiteste:	328 (29), 305 (17), 263 (49)								
beste Teiler	48.6 (58.)	53.0 (50.)	59.5 (22.)						
Trefferlage	0.05 mm links, 0.50 mm hoch								
Streuwert	1.14, horizontal: 1.22, vertikal: 1.05								

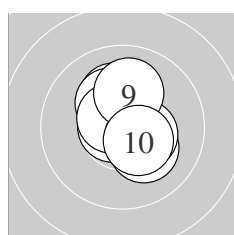
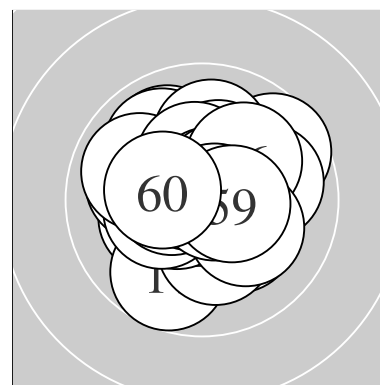

Serie 1:	10.6 *	10.5 *	10.2 *	10.3 *	10.7 *
	10.2 *	10.4 *	10.6 *	10.1 ↑	10.4 *
beste Teiler	63.0 (5.) 90.1 (8.) 92.0 (1.)				
Trefferlage	0.01 mm rechts, 0.50 mm hoch				
Streuwert	1.04, horizontal: 0.90, vertikal: 1.17				

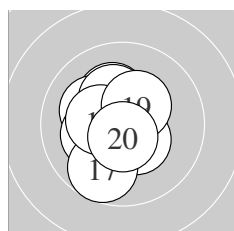

Serie 2:	10.6 *	10.2 *	10.1 ↖	10.3 *	10.4 *
	10.2 *	9.7 ↓	10.4 *	10.4 *	10.6 *
beste Teiler	81.0 (20.) 94.1 (11.) 131.1 (15.)				
Trefferlage	0.66 mm links, 0.04 mm hoch				
Streuwert	1.20, horizontal: 0.98, vertikal: 1.39				

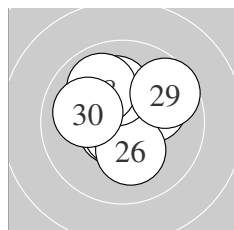

Serie 3:	10.1 ↖	10.7 *	10.1 ↗	10.7 *	10.7 *
	10.2 *	10.1 ↑	9.9 ↘	9.6 ↗	10.0 ↖
beste Teiler	59.5 (22.) 63.0 (25.) 75.4 (24.)				
Trefferlage	0.15 mm links, 0.68 mm hoch				
Streuwert	1.41, horizontal: 1.51, vertikal: 1.30				

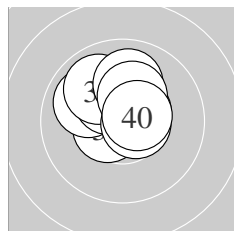

Serie 4:	10.5 *	10.4 *	10.5 *	10.0 ↖	10.3 *
	9.9 ↘	10.0 ↑	10.6 *	10.3 *	10.6 *
beste Teiler	86.4 (38.) 99.3 (40.) 104.3 (33.)				
Trefferlage	0.31 mm links, 0.95 mm hoch				
Streuwert	1.05, horizontal: 1.17, vertikal: 0.92				

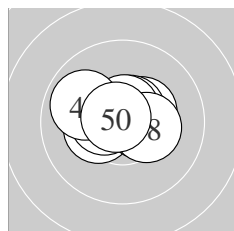

Serie 5:	10.3 *	10.5 *	10.5 *	10.4 *	10.5 *
	10.6 *	10.6 *	10.3 *	9.9 ↖	10.7 *
beste Teiler	53.0 (50.) 78.7 (47.) 88.5 (46.)				
Trefferlage	0.01 mm links, 0.35 mm hoch				
Streuwert	1.01, horizontal: 1.33, vertikal: 0.52				

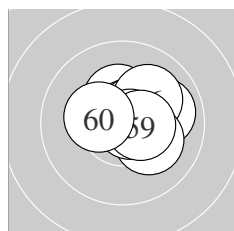

Serie 6:	10.3 *	10.7 *	10.3 *	10.6 *	9.9 →
	10.1 ↗	10.2 *	10.8 *	10.5 *	10.3 *
beste Teiler	48.6 (58.) 62.6 (52.) 96.8 (54.)				
Trefferlage	0.80 mm rechts, 0.47 mm hoch				
Streuwert	0.97, horizontal: 1.14, vertikal: 0.78				

Meyton Elektronik

ISSF AR Men – Wertung – Männer

StandNr: 115

Ivan, Roe #70811302

StartNr: 61

21. Januar 2019 11:50

USA

Unterschrift des Schützen

Meyton Elektronik

Ergebnis: **624.8** (596)
 Serien: 104.1 103.6 103.3 104.9 104.6 104.3
 Zähler: 56 4 0 0 0 0 0 0 0
 Innenzehner: 49
 weiteste: 288 (25), 281 (1), 281 (2)
 beste Teiler 16.4 (45.) 19.0 (5.) 41.6 (8.)
 Trefferlage 0.32 mm rechts, 0.06 mm hoch
 Streuwert 1.05, horizontal: 1.06, vertikal: 1.03

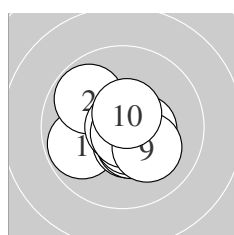
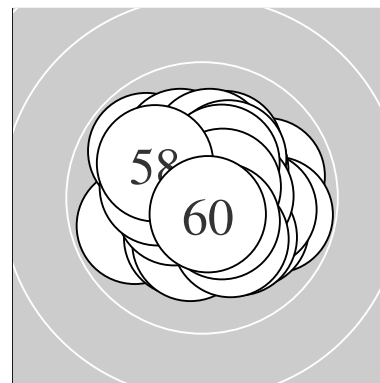

Serie 1:
 9.8 ↙ 9.8 ↘ 10.5 * 10.5 * 10.9 *
 10.5 * 10.6 * 10.8 * 10.1 ↘ 10.6 *
 beste Teiler 19.0 (5.) 41.6 (8.) 92.0 (10.)
 Trefferlage 0.03 mm links, 0.31 mm tief
 Streuwert 1.18, horizontal: 1.34, vertikal: 1.00

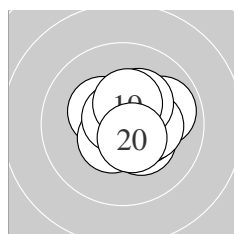

Serie 2:
 9.9 → 10.3 * 10.3 * 10.4 * 10.5 *
 10.3 * 10.7 * 10.3 * 10.4 * 10.5 *
 beste Teiler 55.1 (17.) 107.0 (20.) 112.2 (15.)
 Trefferlage 0.63 mm rechts, 0.14 mm hoch
 Streuwert 1.05, horizontal: 1.16, vertikal: 0.92

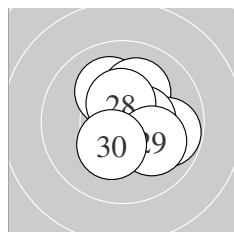

Serie 3:
 10.1 ↖ 10.1 ↗ 10.6 * 10.6 * 9.8 →
 10.7 * 10.5 * 10.5 * 10.1 ↘ 10.3 *
 beste Teiler 59.6 (26.) 81.1 (23.) 92.0 (24.)
 Trefferlage 0.57 mm rechts, 0.19 mm hoch
 Streuwert 1.20, horizontal: 1.15, vertikal: 1.25

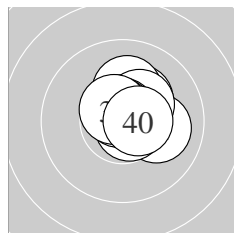

Serie 4:
 10.1 → 10.3 * 10.2 * 10.7 * 10.3 *
 10.7 * 10.7 * 10.7 * 10.6 * 10.6 *
 beste Teiler 54.3 (37.) 55.8 (36.) 59.2 (38.)
 Trefferlage 0.50 mm rechts, 0.62 mm hoch
 Streuwert 0.79, horizontal: 0.82, vertikal: 0.75

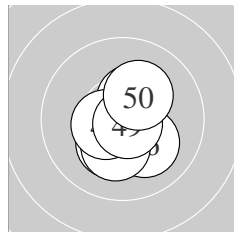

Serie 5:
 10.6 * 10.3 * 10.4 * 10.6 * 10.9 *
 10.1 ↘ 10.2 * 10.5 * 10.8 * 10.2 *
 beste Teiler 16.4 (45.) 43.8 (49.) 89.8 (41.)
 Trefferlage 0.16 mm rechts, 0.45 mm tief
 Streuwert 0.96, horizontal: 0.77, vertikal: 1.12

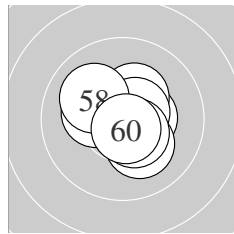

Serie 6:
 10.4 * 10.2 * 10.6 * 10.7 * 10.3 *
 10.3 * 10.6 * 10.0 ↘ 10.5 * 10.7 *
 beste Teiler 51.6 (54.) 66.7 (60.) 88.2 (53.)
 Trefferlage 0.09 mm rechts, 0.17 mm hoch
 Streuwert 1.04, horizontal: 1.10, vertikal: 0.96

Meyton Elektronik

ISSF AR Men – Wertung – Männer
StandNr: 116
Krishnaprasad, Tejas #70811303

StartNr: 62
21. Januar 2019 11:50
IND

Unterschrift des Schützen

Meyton Elektronik

Ergebnis: **623.3** (595)
 Serien: 103.7 103.4 105.5 103.0 104.8 102.9
 Zähler: 55 5 0 0 0 0 0 0 0 0
 Innenzehner: 50
 weiteste: 304 (54), 279 (6), 270 (59)
 beste Teiler 33.1 (52.) 36.1 (14.) 38.0 (2.)
 Trefferlage 0.00 mm , 0.33 mm hoch
 Streuwert 1.07, horizontal: 1.10, vertikal: 1.03

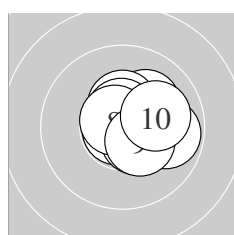
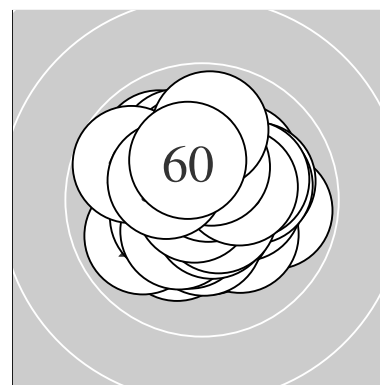

Serie 1:
 10.3 * 10.8 * 10.1 ↗ 10.4 * 10.5 *
 9.8 → 10.6 * 10.7 * 10.4 * 10.1 →
 beste Teiler 38.0 (2.) 66.6 (8.) 88.4 (7.)
 Trefferlage 0.87 mm rechts, 0.36 mm hoch
 Streuwert 0.99, horizontal: 1.10, vertikal: 0.87

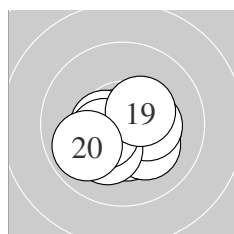

Serie 2:
 10.4 * 10.3 * 10.2 * 10.8 * 10.5 *
 10.3 * 10.2 * 10.4 * 10.4 * 9.9 ↙
 beste Teiler 36.1 (14.) 112.2 (15.) 132.8 (18.)
 Trefferlage 0.00 mm , 0.61 mm tief
 Streuwert 1.13, horizontal: 1.38, vertikal: 0.79

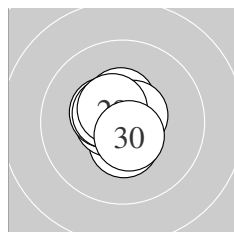

Serie 3:
 10.4 * 10.7 * 10.6 * 10.5 * 10.4 *
 10.7 * 10.6 * 10.5 * 10.5 * 10.6 *
 beste Teiler 51.0 (26.) 65.1 (22.) 77.9 (27.)
 Trefferlage 0.20 mm links, 0.23 mm hoch
 Streuwert 0.72, horizontal: 0.66, vertikal: 0.78

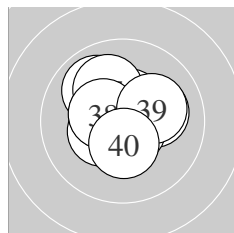

Serie 4:
 10.1 → 9.9 ↖ 10.5 * 10.4 * 10.7 *
 10.4 * 10.1 ↖ 10.4 * 10.1 → 10.4 *
 beste Teiler 73.5 (35.) 117.0 (33.) 129.8 (36.)
 Trefferlage 0.14 mm links, 0.47 mm hoch
 Streuwert 1.22, horizontal: 1.33, vertikal: 1.10

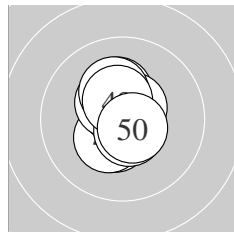

Serie 5:
 10.5 * 10.4 * 10.3 * 10.7 * 10.6 *
 10.4 * 10.6 * 10.2 * 10.5 * 10.6 *
 beste Teiler 65.7 (44.) 84.9 (50.) 87.6 (47.)
 Trefferlage 0.20 mm links, 0.33 mm hoch
 Streuwert 0.91, horizontal: 0.56, vertikal: 1.15

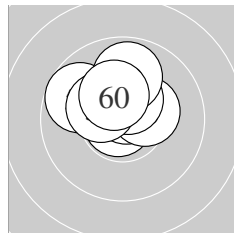

Serie 6:
 10.2 * 10.8 * 10.7 * 9.7 ↖ 10.3 *
 10.3 * 10.4 * 10.3 * 9.9 ↑ 10.3 *
 beste Teiler 33.1 (52.) 68.3 (53.) 131.0 (57.)
 Trefferlage 0.30 mm links, 1.18 mm hoch
 Streuwert 0.97, horizontal: 1.12, vertikal: 0.80

Meyton Elektronik

ISSF AR Men – Wertung – **Männer**

StandNr: 117

Baudouin, Brian #70811304

StartNr: 63

21. Januar 2019 11:45

FRA

Unterschrift des Schützen

Meyton Elektronik

Ergebnis: **620.3** (589)
 Serien: 104.4 103.7 102.6 102.5 103.9 103.2
 Zähler: 49 11 0 0 0 0 0 0 0
 Innenzehner: 43
 weiteste: 354 (31), 328 (54), 305 (15)
 beste Teiler 15.0 (51.) 16.1 (38.) 51.6 (29.)
 Trefferlage 0.11 mm links, 0.28 mm hoch
 Streuwert 1.22, horizontal: 1.30, vertikal: 1.13

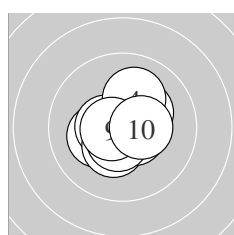
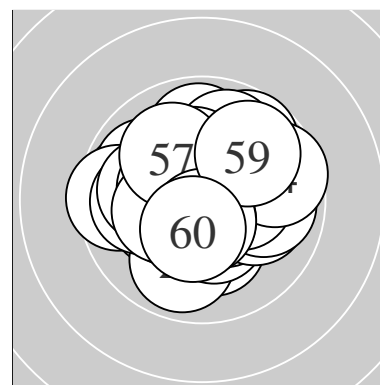

Serie 1:
 10.3 * 10.2 * 10.5 * 10.1 ↗ 10.4 *
 10.6 * 10.7 * 10.6 * 10.6 * 10.4 *
 beste Teiler 69.3 (7.) 78.0 (9.) 92.4 (6.)
 Trefferlage 0.07 mm links, 0.08 mm tief
 Streuwert 1.02, horizontal: 1.07, vertikal: 0.97

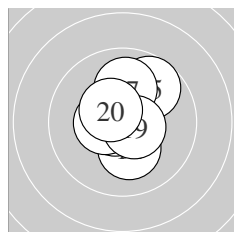

Serie 2:
 10.1 ↗ 10.2 * 10.7 * 10.7 * 9.7 ↗
 10.7 * 10.0 ↑ 10.5 * 10.6 * 10.5 *
 beste Teiler 53.7 (13.) 55.3 (16.) 70.8 (14.)
 Trefferlage 0.22 mm rechts, 0.62 mm hoch
 Streuwert 1.16, horizontal: 0.91, vertikal: 1.36

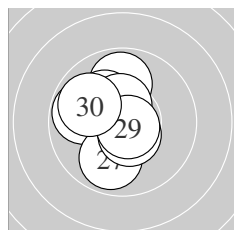

Serie 3:
 10.6 * 9.9 ↑ 10.6 * 9.8 ← 10.2 *
 10.5 * 9.9 ↓ 10.5 * 10.7 * 9.9 ↖
 beste Teiler 51.6 (29.) 88.4 (21.) 92.0 (23.)
 Trefferlage 0.81 mm links, 0.45 mm hoch
 Streuwert 1.27, horizontal: 1.07, vertikal: 1.44

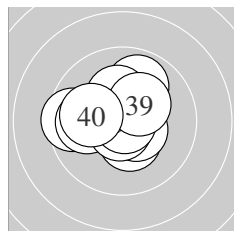

Serie 4:
 9.5 ← 9.9 ← 10.4 * 10.5 * 10.7 *
 9.9 ↗ 10.3 * 10.9 * 10.3 * 10.1 ←
 beste Teiler 16.1 (38.) 61.0 (35.) 113.7 (34.)
 Trefferlage 0.50 mm links, 0.32 mm hoch
 Streuwert 1.43, horizontal: 1.67, vertikal: 1.15

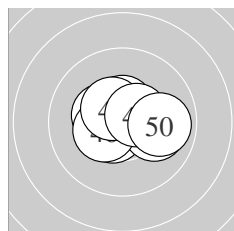

Serie 5:
 10.6 * 10.6 * 10.4 * 10.5 * 10.0 →
 10.4 * 10.5 * 10.5 * 10.5 * 9.9 →
 beste Teiler 96.2 (42.) 98.0 (41.) 104.5 (44.)
 Trefferlage 0.13 mm rechts, 0.29 mm hoch
 Streuwert 1.10, horizontal: 1.39, vertikal: 0.71

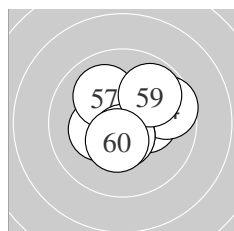

Serie 6:
 10.9 * 10.7 * 10.3 * 9.6 → 10.3 *
 10.6 * 10.0 ↘ 10.6 * 9.8 ↗ 10.4 *
 beste Teiler 15.0 (51.) 52.4 (52.) 86.1 (56.)
 Trefferlage 0.31 mm rechts, 0.10 mm hoch
 Streuwert 1.33, horizontal: 1.47, vertikal: 1.16

Meyton Elektronik

ISSF AR Men – Wertung – **Männer**

StandNr: 118

Cipro, Adam #70811305

StartNr: 64

21. Januar 2019 11:53

CZE

Unterschrift des Schützen

Meyton Elektronik

Ergebnis: **616.0** (590)
 Serien: 100.4 101.7 101.1 105.3 104.2 103.3
 Zähler: 50 10 0 0 0 0 0 0 0
 Innenzehner: 40
 weiteste: 406 (21), 373 (53), 342 (15)
 beste Teiler 12.8 (40.) 21.1 (54.) 30.1 (57.)
 Trefferlage 0.09 mm links, 0.03 mm hoch
 Streuwert 1.37, horizontal: 1.40, vertikal: 1.34

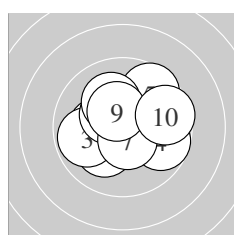
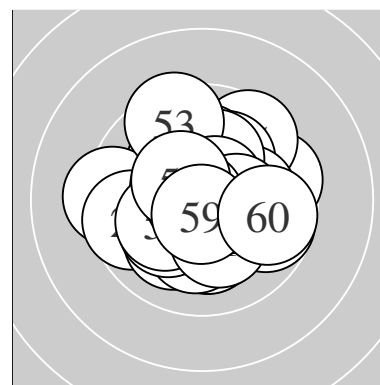

Serie 1:
 10.1 ↙ 10.2 * 9.8 ← 9.7 → 9.6 ↗
 10.4 * 10.5 * 10.1 ↘ 10.4 * 9.6 →
 beste Teiler 101.9 (7.) 126.8 (9.) 139.3 (6.)
 Trefferlage 0.03 mm rechts, 0.32 mm hoch
 Streuwert 1.74, horizontal: 2.03, vertikal: 1.38

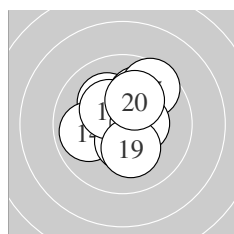

Serie 2:
 10.1 ↘ 10.0 ↗ 10.7 * 9.9 ← 9.6 ↗
 10.4 * 10.3 * 10.4 * 10.2 * 10.1 ↗
 beste Teiler 62.4 (13.) 129.6 (16.) 130.1 (18.)
 Trefferlage 0.10 mm rechts, 0.53 mm hoch
 Streuwert 1.47, horizontal: 1.39, vertikal: 1.55

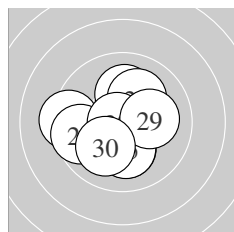

Serie 3:
 9.3 ← 9.6 ← 10.7 * 10.2 * 10.1 ↓
 10.1 ↑ 10.1 ↗ 10.8 * 10.1 → 10.1 ↘
 beste Teiler 42.0 (28.) 63.0 (23.) 200.9 (24.)
 Trefferlage 0.45 mm links, 0.24 mm tief
 Streuwert 1.69, horizontal: 1.89, vertikal: 1.46

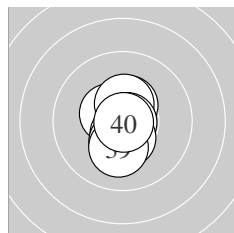

Serie 4:
 10.4 * 10.5 * 10.6 * 10.8 * 10.3 *
 10.4 * 10.8 * 10.4 * 10.2 * 10.9 *
 beste Teiler 12.8 (40.) 31.8 (34.) 35.4 (37.)
 Trefferlage 0.04 mm links, 0.26 mm tief
 Streuwert 0.86, horizontal: 0.43, vertikal: 1.13

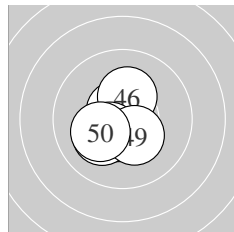

Serie 5:
 10.6 * 10.7 * 10.5 * 10.2 * 10.8 *
 10.3 * 10.4 * 10.2 * 10.3 * 10.2 *
 beste Teiler 46.0 (45.) 59.0 (42.) 79.0 (41.)
 Trefferlage 0.55 mm links, 0.52 mm tief
 Streuwert 0.90, horizontal: 0.85, vertikal: 0.96

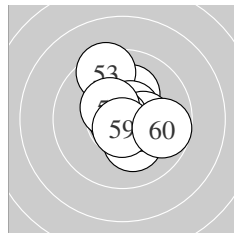

Serie 6:
 10.2 * 10.2 * 9.5 ↘ 10.9 * 10.6 *
 10.3 * 10.8 * 10.4 * 10.7 * 9.7 →
 beste Teiler 21.1 (54.) 30.1 (57.) 65.1 (59.)
 Trefferlage 0.36 mm rechts, 0.37 mm hoch
 Streuwert 1.36, horizontal: 1.24, vertikal: 1.47

Meyton Elektronik

ISSF AR Men – Wertung – Männer

StandNr: 119

Rylan, Kissel #70811258

StartNr: 65

21. Januar 2019 11:30

USA

Unterschrift des Schützen

Meyton Elektronik

Ergebnis: **624.0** (594)
 Serien: 104.1 104.9 104.0 103.1 104.2 103.7
 Zähler: 54 6 0 0 0 0 0 0 0 0
 Innenzehner: 49
 weiteste: 312 (40), 310 (34), 300 (27)
 beste Teiler 27.4 (28.) 30.0 (26.) 50.6 (52.)
 Trefferlage 0.07 mm rechts, 0.32 mm hoch
 Streuwert 1.08, horizontal: 1.11, vertikal: 1.05

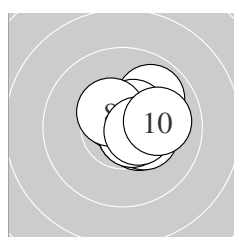
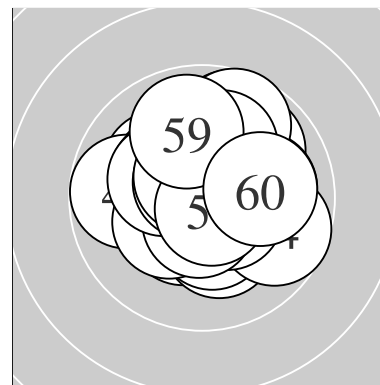

Serie 1:
 10.5 * 10.3 * 9.9 ↗ 10.6 * 10.7 *
 10.7 * 10.5 * 10.4 * 10.5 * 10.0 →
 beste Teiler 69.1 (5.) 73.7 (6.) 85.4 (4.)
 Trefferlage 0.83 mm rechts, 0.27 mm hoch
 Streuwert 0.89, horizontal: 0.93, vertikal: 0.84

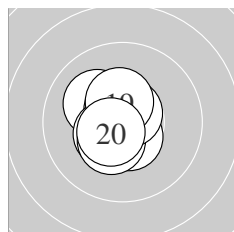

Serie 2:
 10.1 ↘ 10.7 * 10.6 * 10.4 * 10.5 *
 10.5 * 10.4 * 10.7 * 10.4 * 10.6 *
 beste Teiler 65.9 (12.) 70.1 (18.) 87.3 (13.)
 Trefferlage 0.47 mm links, 0.00 mm
 Streuwert 0.83, horizontal: 0.63, vertikal: 1.00

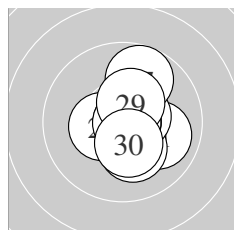

Serie 3:
 10.0 ↘ 10.2 * 10.5 * 10.7 * 10.4 *
 10.8 * 9.8 ↑ 10.8 * 10.4 * 10.4 *
 beste Teiler 27.4 (28.) 30.0 (26.) 66.7 (24.)
 Trefferlage 0.47 mm rechts, 0.03 mm tief
 Streuwert 1.15, horizontal: 0.95, vertikal: 1.31

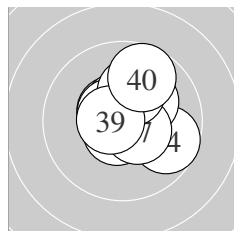

Serie 4:
 10.5 * 10.5 * 10.6 * 9.7 ↘ 10.6 *
 10.2 * 10.5 * 10.2 * 10.6 * 9.7 ↑
 beste Teiler 76.5 (35.) 79.3 (39.) 93.6 (33.)
 Trefferlage 0.42 mm rechts, 0.58 mm hoch
 Streuwert 1.24, horizontal: 1.22, vertikal: 1.25

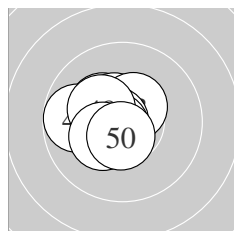

Serie 5:
 10.3 * 10.5 * 10.5 * 9.8 ← 10.7 *
 10.5 * 10.7 * 10.3 * 10.3 * 10.6 *
 beste Teiler 54.4 (45.) 59.5 (47.) 91.7 (50.)
 Trefferlage 0.92 mm links, 0.16 mm hoch
 Streuwert 0.88, horizontal: 0.97, vertikal: 0.78

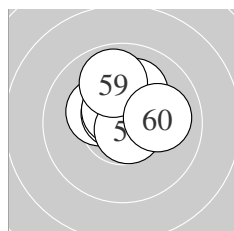

Serie 6:
 10.2 * 10.8 * 10.1 ↑ 10.5 * 10.3 *
 10.6 * 10.6 * 10.7 * 9.9 ↑ 10.0 →
 beste Teiler 50.6 (52.) 57.3 (58.) 79.0 (56.)
 Trefferlage 0.10 mm rechts, 0.94 mm hoch
 Streuwert 0.99, horizontal: 1.06, vertikal: 0.92

Meyton Elektronik

ISSF AR Men – Wertung – **Männer**

StandNr: 120

Mathis, Thomas #223

StartNr: 66

21. Januar 2019 11:32

AUT

Unterschrift des Schützen

Meyton Elektronik

Ergebnis:	620.1	(593)					
Serien:	102.0	103.2	104.6	103.8	104.6	101.9	
Zähler:	53	7	0	0	0	0	0
Innenzehner:	43						
weiteste:	362 (55), 344 (11), 320 (6)						
beste Teiler	15.0 (24.) 28.1 (56.) 44.2 (49.)						
Trefferlage	0.14 mm rechts, 0.22 mm hoch						
Streuwert	1.23, horizontal: 1.24, vertikal: 1.21						

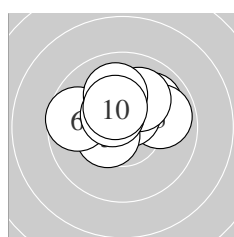
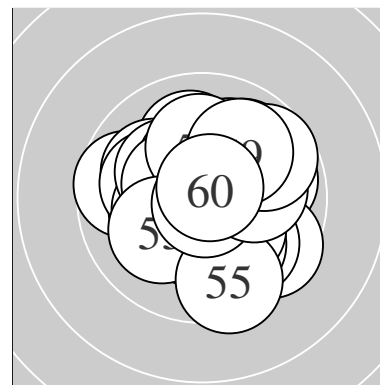

Serie 1:

10.0 ↗	10.3 *	9.9 →	10.6 *	10.5 *
9.7 ←	10.1 ↗	10.0 ↑	10.5 *	10.4 *
beste Teiler	96.1 (4.) 113.0 (9.) 119.0 (5.)			
Trefferlage	0.07 mm links, 1.10 mm hoch			
Streuwert	1.31, horizontal: 1.66, vertikal: 0.80			

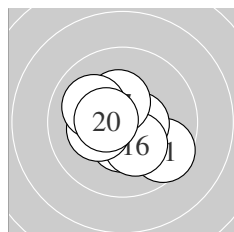

Serie 2:

9.6 ↘	10.6 *	10.5 *	10.6 *	10.5 *
10.2 *	10.4 *	10.3 *	10.0 ↖	10.5 *
beste Teiler	96.6 (12.) 96.9 (14.) 102.7 (13.)			
Trefferlage	0.00 mm , 0.40 mm tief			
Streuwert	1.28, horizontal: 1.45, vertikal: 1.09			

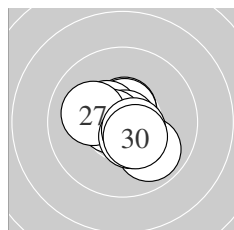

Serie 3:

10.6 *	10.6 *	10.4 *	10.9 *	9.9 ↘
10.6 *	10.1 ←	10.5 *	10.6 *	10.4 *
beste Teiler	15.0 (24.) 77.1 (26.) 81.2 (22.)			
Trefferlage	0.05 mm rechts, 0.14 mm tief			
Streuwert	1.03, horizontal: 1.12, vertikal: 0.94			

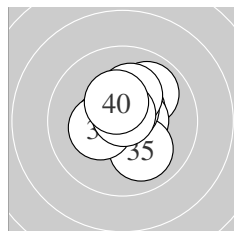

Serie 4:

10.5 *	9.9 ↗	10.5 *	10.6 *	10.0 ↘
10.6 *	10.2 *	10.3 *	10.8 *	10.4 *
beste Teiler	47.5 (39.) 89.5 (36.) 98.1 (34.)			
Trefferlage	0.25 mm rechts, 0.47 mm hoch			
Streuwert	1.10, horizontal: 1.04, vertikal: 1.16			

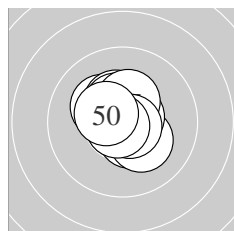

Serie 5:

10.5 *	10.2 *	10.2 *	10.4 *	10.6 *
10.4 *	10.4 *	10.7 *	10.8 *	10.4 *
beste Teiler	44.2 (49.) 58.3 (48.) 76.9 (45.)			
Trefferlage	0.05 mm links, 0.32 mm hoch			
Streuwert	0.92, horizontal: 0.86, vertikal: 0.98			

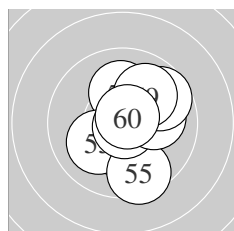

Serie 6:

10.3 *	10.1 ↑	10.1 ↙	10.6 *	9.5 ↓
10.8 *	10.1 →	9.7 ↗	10.0 ↗	10.7 *
beste Teiler	28.1 (56.) 54.2 (60.) 81.7 (54.)			
Trefferlage	0.65 mm rechts, 0.02 mm tief			
Streuwert	1.53, horizontal: 1.28, vertikal: 1.74			

Meyton Elektronik

ISSF AR Men – Wertung – **Männer**

StandNr: 121

Paynaud, Alexis #70811306

StartNr: 67

21. Januar 2019 11:47

FRA

Unterschrift des Schützen

Meyton Elektronik

Ergebnis:	599.6	(574)						
Serien:	101.0	99.6	98.1	101.7	99.0	100.2		
Zähler:	35	24	1	0	0	0	0	0
Innenzehner:	24							
weiteste:	536 (45), 467 (25), 452 (22)							
beste Teiler	53.8 (23.) 55.1 (2.) 64.9 (33.)							
Trefferlage	0.12 mm links, 0.00 mm							
Streuwert	1.90, horizontal: 1.85, vertikal: 1.96							

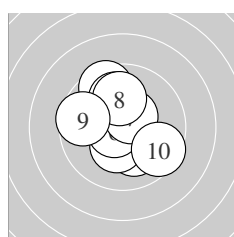
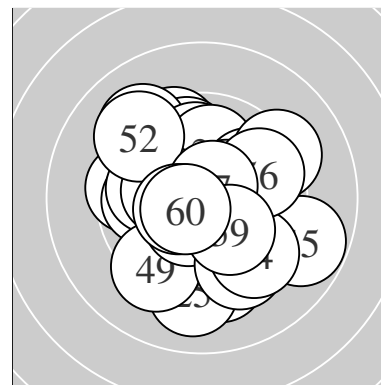

Serie 1:	10.1 ↘	10.7 *	9.5 ↗	10.0 ↑	10.3 *
	10.7 *	10.5 *	10.0 ↑	9.6 ←	9.6 ↘
beste Teiler	55.1 (2.) 73.5 (6.) 111.0 (7.)				
Trefferlage	0.22 mm links, 0.46 mm hoch				
Streuwert	1.74, horizontal: 1.62, vertikal: 1.84				

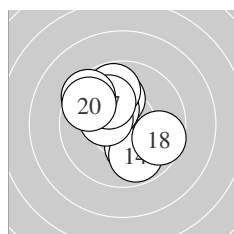

Serie 2:	10.2 *	10.1 ↑	10.3 *	9.8 ↘	10.4 *
	9.8 ↑	10.1 ↘	9.7 ↘	9.5 ↘	9.7 ↘
beste Teiler	144.5 (15.) 151.4 (13.) 199.6 (11.)				
Trefferlage	0.53 mm links, 0.67 mm hoch				
Streuwert	1.83, horizontal: 1.78, vertikal: 1.88				

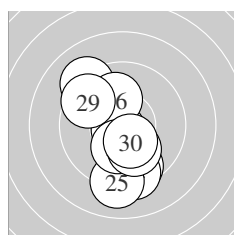

Serie 3:	9.5 ↘	9.1 ↘	10.7 *	9.3 ↘	9.1 ↓
	10.1 ↑	10.2 *	10.1 ↘	9.6 ↘	10.4 *
beste Teiler	53.8 (23.) 148.0 (30.) 183.1 (27.)				
Trefferlage	0.39 mm links, 0.99 mm tief				
Streuwert	2.21, horizontal: 1.48, vertikal: 2.76				

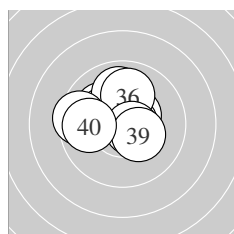

Serie 4:	10.5 *	10.1 ↘	10.7 *	10.3 *	9.9 ↑
	10.0 ↑	10.6 *	9.5 ←	10.3 *	9.8 ←
beste Teiler	64.9 (33.) 84.0 (37.) 121.4 (31.)				
Trefferlage	0.56 mm links, 0.70 mm hoch				
Streuwert	1.44, horizontal: 1.70, vertikal: 1.11				

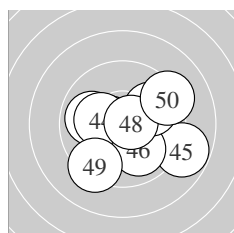

Serie 5:	9.9 ←	10.5 *	10.5 *	10.2 *	8.8 ↘
	10.0 ↘	9.9 ↗	10.7 *	9.3 ↗	9.2 ↗
beste Teiler	71.3 (48.) 104.0 (42.) 110.3 (43.)				
Trefferlage	0.52 mm rechts, 0.42 mm tief				
Streuwert	2.18, horizontal: 2.56, vertikal: 1.71				

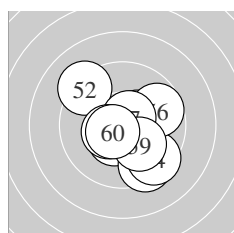

Serie 6:	10.4 *	9.2 ↘	9.4 ↘	9.4 ↘	10.4 *
	9.7 ↗	10.6 *	10.4 *	10.1 ↘	10.6 *
beste Teiler	79.3 (57.) 100.1 (60.) 131.5 (58.)				
Trefferlage	0.46 mm rechts, 0.43 mm tief				
Streuwert	1.90, horizontal: 1.90, vertikal: 1.90				

ISSF AR Men – Wertung – Männer

StandNr: 122

Manfred, Lim Cong Ying #70811187

StartNr: 68

21. Januar 2019 11:41

SGP

Unterschrift des Schützen

Meyton Elektronik

Ergebnis: **617.5** (589)
 Serien: 101.9 102.4 103.5 102.9 103.2 103.6
 Zähler: 49 11 0 0 0 0 0 0 0
 Innenzehner: 43
 weiteste: 484 (34), 425 (30), 377 (6)
 beste Teiler 17.8 (45.) 38.3 (23.) 42.5 (36.)
 Trefferlage 0.44 mm links, 0.15 mm tief
 Streuwert 1.32, horizontal: 1.34, vertikal: 1.31

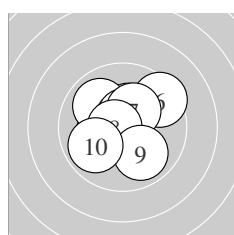
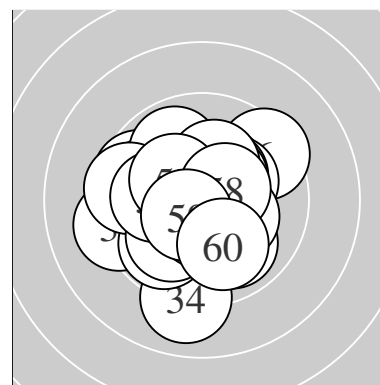

Serie 1:
 10.4 * 10.3 * 10.5 * 9.9 ↘ 10.6 *
 9.4 ↗ 10.3 * 10.7 * 9.9 ↘ 9.9 ↗
 beste Teiler 66.0 (8.) 94.5 (5.) 122.1 (3.)
 Trefferlage 0.14 mm links, 0.38 mm hoch
 Streuwert 1.55, horizontal: 1.66, vertikal: 1.42

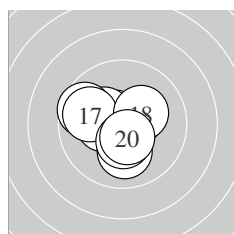

Serie 2:
 10.3 * 10.7 * 10.5 * 10.1 ↓ 10.3 *
 9.6 ↖ 9.8 ↖ 10.2 * 10.4 * 10.5 *
 beste Teiler 71.4 (12.) 113.5 (20.) 116.2 (13.)
 Trefferlage 0.61 mm links, 0.00 mm
 Streuwert 1.36, horizontal: 1.54, vertikal: 1.16

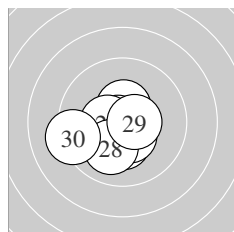

Serie 3:
 10.5 * 10.5 * 10.8 * 10.4 * 10.5 *
 10.3 * 10.5 * 10.1 ↓ 10.6 * 9.3 ↖
 beste Teiler 38.3 (23.) 97.0 (29.) 115.2 (21.)
 Trefferlage 0.52 mm links, 0.50 mm tief
 Streuwert 1.28, horizontal: 1.41, vertikal: 1.14

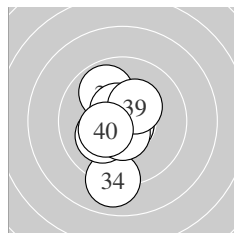

Serie 4:
 10.5 * 9.9 ↘ 10.8 * 9.0 ↓ 10.1 ↗
 10.8 * 10.6 * 10.6 * 10.3 * 10.3 *
 beste Teiler 42.5 (36.) 45.9 (33.) 97.0 (37.)
 Trefferlage 0.52 mm links, 0.46 mm tief
 Streuwert 1.45, horizontal: 0.83, vertikal: 1.88

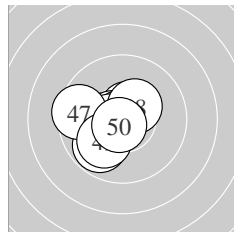

Serie 5:
 10.2 * 9.8 ↗ 10.6 * 10.6 * 10.9 *
 10.5 * 9.5 ↖ 10.4 * 10.0 ↗ 10.7 *
 beste Teiler 17.8 (45.) 56.4 (50.) 85.2 (44.)
 Trefferlage 0.95 mm links, 0.20 mm tief
 Streuwert 1.17, horizontal: 1.30, vertikal: 1.03

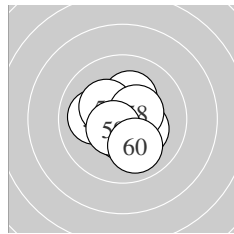

Serie 6:
 10.6 * 10.7 * 10.3 * 10.5 * 10.0 ←
 10.2 * 10.3 * 10.5 * 10.5 * 10.0 ↓
 beste Teiler 75.6 (52.) 86.4 (51.) 106.0 (59.)
 Trefferlage 0.10 mm rechts, 0.15 mm tief
 Streuwert 1.18, horizontal: 1.20, vertikal: 1.15

Meyton Elektronik

ISSF AR Men – Wertung – Männer

StandNr: 123

Matthew, Sanchez #70811269

StartNr: 69

21. Januar 2019 11:39

USA

Unterschrift des Schützen

Meyton Elektronik

Ergebnis:	590.5	(565)
Serien:	98.3 98.3 100.1 98.5 98.3 97.0	
Zähler:	28 30 1 1 0 0 0 0 0 0	
Innenzehner:	20	
weiteste:	806 (36), 535 (54), 469 (20)	
beste Teiler	57.0 (46.) 79.3 (55.) 90.6 (35.)	
Trefferlage	0.33 mm links, 0.43 mm hoch	
Streuwert	2.17, horizontal: 2.47, vertikal: 1.82	

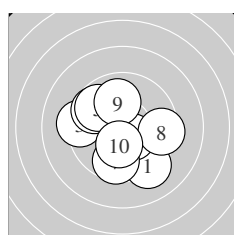
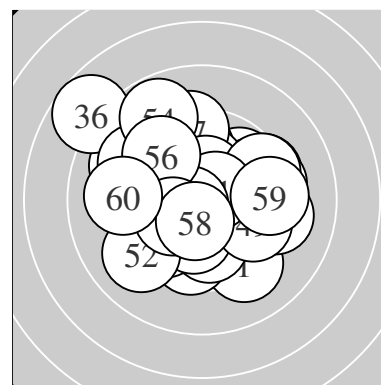

Serie 1:	9.2 ↘	10.5 *	9.3 ←	9.7 ↖	9.8 ↖
	10.4 *	9.6 ↓	9.5 →	10.0 ↑	10.3 *
beste Teiler	112.6 (2.)	132.9 (6.)	168.2 (10.)		
Trefferlage	0.32 mm links, 0.47 mm tief				
Streuwert	2.22, horizontal: 2.36, vertikal: 2.06				

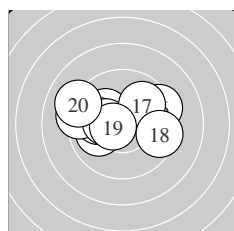

Serie 2:	10.2 *	10.0 ←	10.0 ←	9.3 ←	10.3 *
	9.4 →	9.9 ↗	9.5 →	10.6 *	9.1 ↖
beste Teiler	95.8 (19.)	163.1 (15.)	200.0 (11.)		
Trefferlage	0.82 mm links, 0.58 mm hoch				
Streuwert	2.15, horizontal: 2.86, vertikal: 1.06				

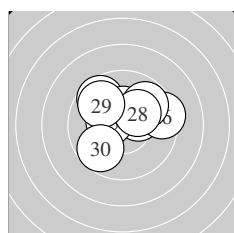

Serie 3:	10.5 *	9.6 ↖	10.4 *	10.3 *	10.4 *
	9.4 →	9.8 ↗	10.2 *	9.8 ↖	9.7 ↙
beste Teiler	106.0 (21.)	130.7 (25.)	148.1 (23.)		
Trefferlage	0.07 mm rechts, 0.96 mm hoch				
Streuwert	1.73, horizontal: 2.07, vertikal: 1.31				

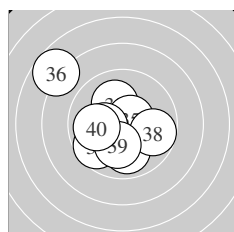

Serie 4:	10.5 *	9.7 ↙	10.1 ↑	9.9 ↓	10.6 *
	7.7 ↖	10.2 *	9.7 →	10.1 ↓	10.0 ←
beste Teiler	90.6 (35.)	115.0 (31.)	177.2 (37.)		
Trefferlage	0.93 mm links, 0.11 mm tief				
Streuwert	2.39, horizontal: 2.55, vertikal: 2.22				

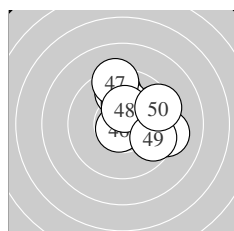

Serie 5:	9.7 →	9.8 ↑	10.1 ↑	9.2 →	10.0 →
	10.7 *	9.3 ↑	10.4 *	9.7 →	9.4 →
beste Teiler	57.0 (46.)	146.5 (48.)	201.9 (43.)		
Trefferlage	1.46 mm rechts, 1.14 mm hoch				
Streuwert	1.77, horizontal: 1.85, vertikal: 1.69				

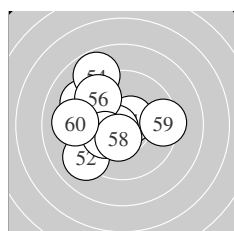

Serie 6:	10.6 *	9.1 ↙	9.2 ↖	8.8 ↖	10.6 *
	9.6 ↖	10.2 *	10.4 *	9.4 →	9.1 ←
beste Teiler	79.3 (55.)	93.4 (51.)	128.7 (58.)		
Trefferlage	1.48 mm links, 0.49 mm hoch				
Streuwert	2.35, horizontal: 2.50, vertikal: 2.20				

Meyton Elektronik

ISSF AR Men – Wertung – Männer

StandNr: 124

Mattle, Michael #221

StartNr: 70

21. Januar 2019 11:55

VLSV

Unterschrift des Schützen

Meyton Elektronik

Ergebnis:	627.4	(598) ^{QF}							
Serien:	103.4	104.8	105.6	105.0	104.2	104.4			
Zähler:	58	2	0	0	0	0	0	0	0
Innenzehner:	55								
weiteste:	319 (60), 258 (8), 219 (19)								
beste Teiler	37.1 (34.)	39.3 (30.)	40.3 (26.)						
Trefferlage	0.07 mm links, 0.10 mm hoch								
Streuwert	0.98, horizontal: 1.01, vertikal: 0.94								

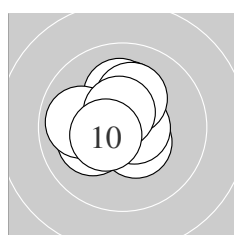
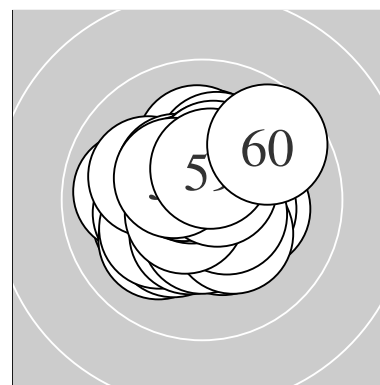

Serie 1:	10.5 *	10.2 *	10.2 *	10.5 *	10.1 ↑
	10.7 *	10.2 *	9.9 ←	10.6 *	10.5 *
beste Teiler	73.1 (6.) 95.3 (9.) 101.2 (1.)				
Trefferlage	0.38 mm links, 0.56 mm hoch				
Streuwert	1.12, horizontal: 1.13, vertikal: 1.12				

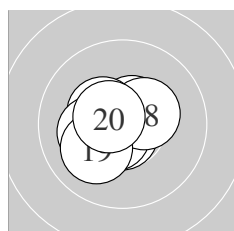

Serie 2:	10.7 *	10.5 *	10.7 *	10.6 *	10.4 *
	10.6 *	10.2 *	10.4 *	10.1 ✓	10.6 *
beste Teiler	61.1 (11.) 67.6 (13.) 84.6 (16.)				
Trefferlage	0.49 mm links, 0.05 mm tief				
Streuwert	0.91, horizontal: 1.02, vertikal: 0.79				

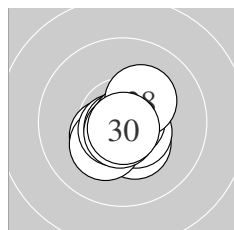

Serie 3:	10.3 *	10.5 *	10.4 *	10.3 *	10.7 *
	10.8 *	10.8 *	10.3 *	10.7 *	10.8 *
beste Teiler	39.3 (30.) 40.3 (26.) 41.7 (27.)				
Trefferlage	0.01 mm rechts, 0.46 mm tief				
Streuwert	0.77, horizontal: 0.77, vertikal: 0.77				

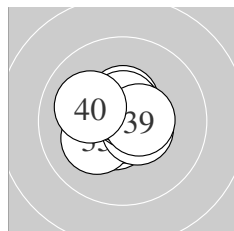

Serie 4:	10.5 *	10.6 *	10.5 *	10.8 *	10.2 *
	10.5 *	10.7 *	10.6 *	10.5 *	10.1 ↖
beste Teiler	37.1 (34.) 66.2 (37.) 89.0 (38.)				
Trefferlage	0.28 mm links, 0.08 mm hoch				
Streuwert	0.91, horizontal: 1.02, vertikal: 0.77				

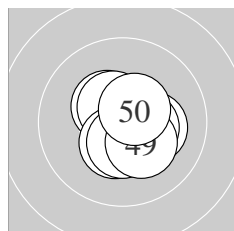

Serie 5:	10.4 *	10.5 *	10.7 *	10.4 *	10.2 *
	10.4 *	10.4 *	10.4 *	10.3 *	10.5 *
beste Teiler	71.0 (43.) 108.2 (50.) 110.1 (42.)				
Trefferlage	0.46 mm rechts, 0.28 mm tief				
Streuwert	0.92, horizontal: 0.94, vertikal: 0.90				

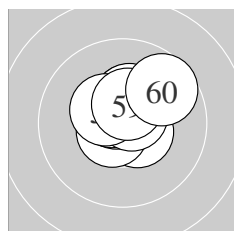

Serie 6:	10.5 *	10.6 *	10.7 *	10.6 *	10.4 *
	10.3 *	10.7 *	10.4 *	10.5 *	9.7 ↗
beste Teiler	72.7 (53.) 75.8 (57.) 81.8 (52.)				
Trefferlage	0.22 mm rechts, 0.77 mm hoch				
Streuwert	0.92, horizontal: 1.01, vertikal: 0.83				

Meyton Elektronik

ISSF AR Men – Wertung – **Männer**

StandNr: 125

Pickl, Bernhard #228

StartNr: 71

21. Januar 2019 11:35

AUT

QF – Schütze hat sich fürs Finale qualifiziert

Unterschrift des Schützen

Meyton Elektronik

Ergebnis: **621.2** (596)
 Serien: 102.9 104.4 103.9 102.8 103.6 103.6
 Zähler: 56 4 0 0 0 0 0 0 0
 Innenzehner: 46
 weiteste: 265 (13), 264 (30), 260 (45)
 beste Teiler 8.5 (15.) 10.6 (24.) 30.0 (56.)
 Trefferlage 0.19 mm links, 0.02 mm hoch
 Streuwert 1.15, horizontal: 1.24, vertikal: 1.05

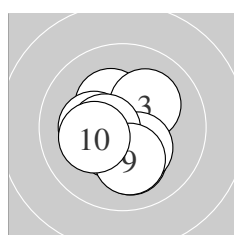
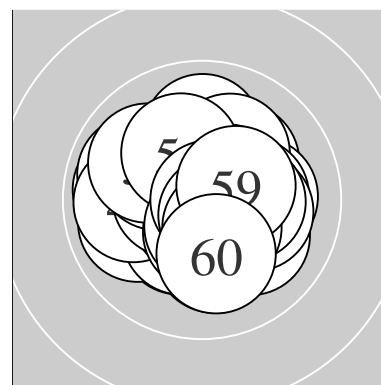

Serie 1:
 10.5 * 10.3 * 10.2 * 10.5 * 10.2 *
 10.1 ↓ 10.3 * 10.5 * 10.1 ↓ 10.2 *
 beste Teiler 101.7 (1.) 112.1 (8.) 116.7 (4.)
 Trefferlage 0.22 mm links, 0.50 mm tief
 Streuwert 1.18, horizontal: 1.14, vertikal: 1.22

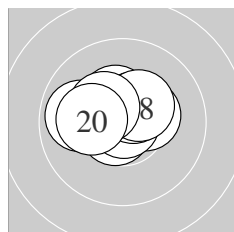

Serie 2:
 10.7 * 10.6 * 9.9 ← 10.4 * 10.9 *
 10.4 * 10.5 * 10.4 * 10.4 * 10.2 *
 beste Teiler 8.5 (15.) 66.4 (11.) 88.2 (12.)
 Trefferlage 0.34 mm links, 0.55 mm hoch
 Streuwert 0.99, horizontal: 1.28, vertikal: 0.56

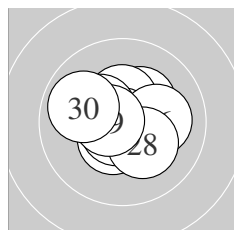

Serie 3:
 10.5 * 10.3 * 10.4 * 10.9 * 10.7 *
 10.1 → 10.3 * 10.2 * 10.6 * 9.9 ←
 beste Teiler 10.6 (24.) 63.2 (25.) 87.5 (29.)
 Trefferlage 0.13 mm links, 0.16 mm hoch
 Streuwert 1.16, horizontal: 1.35, vertikal: 0.92

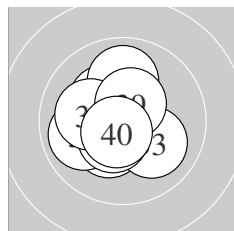

Serie 4:
 10.3 * 10.3 * 10.0 ↘ 10.0 ↑ 10.6 *
 9.9 ← 10.5 * 10.1 ← 10.5 * 10.6 *
 beste Teiler 78.7 (40.) 94.5 (35.) 116.6 (37.)
 Trefferlage 0.59 mm links, 0.03 mm hoch
 Streuwert 1.25, horizontal: 1.21, vertikal: 1.29

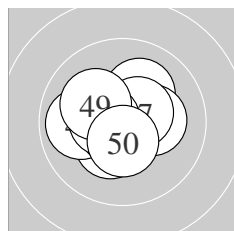

Serie 5:
 10.1 ↗ 10.3 * 10.2 * 10.8 * 9.9 ←
 10.7 * 10.5 * 10.5 * 10.1 ↘ 10.5 *
 beste Teiler 43.0 (44.) 66.6 (46.) 112.3 (47.)
 Trefferlage 0.28 mm links, 0.01 mm hoch
 Streuwert 1.17, horizontal: 1.34, vertikal: 0.96

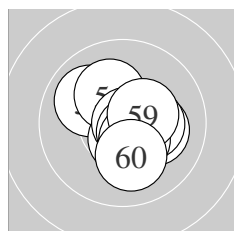

Serie 6:
 10.0 ↘ 10.2 * 10.3 * 10.2 * 10.6 *
 10.8 * 10.6 * 10.4 * 10.4 * 10.1 ↓
 beste Teiler 30.0 (56.) 82.7 (57.) 99.2 (55.)
 Trefferlage 0.42 mm rechts, 0.14 mm tief
 Streuwert 1.16, horizontal: 1.18, vertikal: 1.15

Meyton Elektronik

ISSF AR Men – Wertung – **Männer**

StandNr: 126

Lohbihler, Jan #70811307

StartNr: 72

21. Januar 2019 11:51

SUI

Unterschrift des Schützen

Meyton Elektronik

Ergebnis:	614.0	(585)
Serien:	103.0	102.6 101.8 101.8 101.8 103.0
Zähler:	45	15 0 0 0 0 0 0 0 0
Innenzehner:	40	
weiteste:	406 (1), 393 (48), 384 (54)	
beste Teiler	40.4 (58.)	44.5 (15.) 45.9 (19.)
Trefferlage	0.25 mm links, 0.30 mm hoch	
Streuwert	1.41, horizontal: 1.56, vertikal: 1.23	

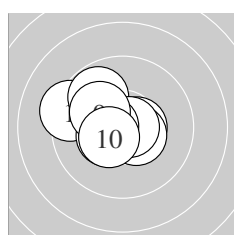
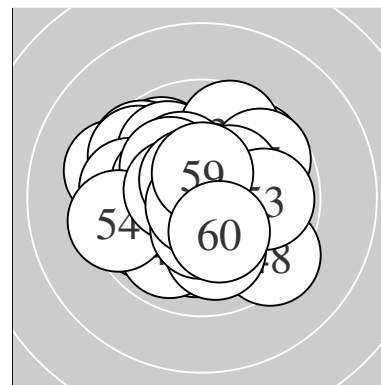

Serie 1:

9.3 ↖	9.8 ↘	10.6 *	10.5 *	10.5 *
10.4 *	10.8 *	10.5 *	10.1 ↖	10.5 *
beste Teiler	47.0 (7.) 93.9 (3.) 104.0 (4.)			
Trefferlage	0.72 mm links, 0.22 mm hoch			
Streuwert	1.31, horizontal: 1.58, vertikal: 0.98			

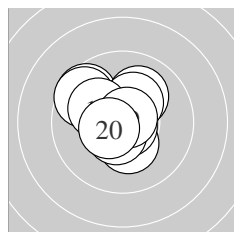

Serie 2:

10.3 *	9.6 ↘	10.1 ↗	10.3 *	10.8 *
10.5 *	9.6 ↘	10.1 ↖	10.8 *	10.5 *
beste Teiler	44.5 (15.) 45.9 (19.) 101.0 (16.)			
Trefferlage	0.57 mm links, 0.53 mm hoch			
Streuwert	1.37, horizontal: 1.43, vertikal: 1.30			

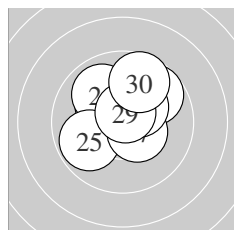

Serie 3:

10.3 *	10.5 *	10.5 *	9.9 ↘	9.8 ↖
9.7 ↗	10.4 *	10.3 *	10.7 *	9.7 ↗
beste Teiler	74.0 (29.) 107.5 (23.) 121.6 (22.)			
Trefferlage	0.09 mm links, 0.95 mm hoch			
Streuwert	1.39, horizontal: 1.50, vertikal: 1.27			

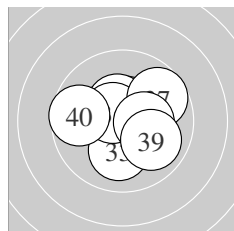

Serie 4:

10.4 *	10.2 *	10.1 ↓	10.5 *	10.4 *
10.6 *	9.7 ↗	10.3 *	9.9 ↘	9.7 ←
beste Teiler	93.7 (36.) 109.6 (34.) 129.3 (35.)			
Trefferlage	0.24 mm rechts, 0.24 mm hoch			
Streuwert	1.52, horizontal: 1.79, vertikal: 1.19			

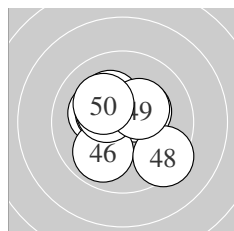

Serie 5:

10.2 *	10.3 *	10.4 *	10.5 *	10.2 *
9.9 ↙	10.4 *	9.4 ↘	10.3 *	10.2 *
beste Teiler	119.9 (44.) 138.4 (47.) 143.2 (43.)			
Trefferlage	0.14 mm links, 0.28 mm hoch			
Streuwert	1.53, horizontal: 1.64, vertikal: 1.43			

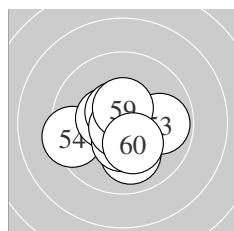

Serie 6:

10.7 *	10.0 ↓	9.9 →	9.4 ←	10.4 *
10.6 *	10.4 *	10.8 *	10.5 *	10.3 *
beste Teiler	40.4 (58.) 71.1 (51.) 97.3 (56.)			
Trefferlage	0.23 mm links, 0.38 mm tief			
Streuwert	1.39, horizontal: 1.63, vertikal: 1.10			

ISSF AR Men – Wertung – Männer

StandNr: 127

Harlacher, Renato #70811308

StartNr: 73

21. Januar 2019 11:54

SUI – ZH

Unterschrift des Schützen

Meyton Elektronik

Ergebnis:	630.4	(600) ^{QF}					
Serien:	104.9	105.0	105.5	105.1	105.9	104.0	
Zähler:	60	0	0	0	0	0	0
Innenzehner:	56						
weiteste:	248 (4), 211 (55), 206 (12)						
beste Teiler	11.1 (48.) 22.8 (43.) 36.8 (6.)						
Trefferlage	0.16 mm links, 0.19 mm hoch						
Streuwert	0.86, horizontal: 0.91, vertikal: 0.80						

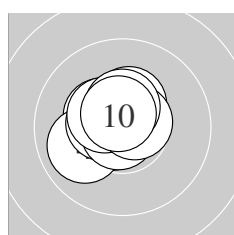
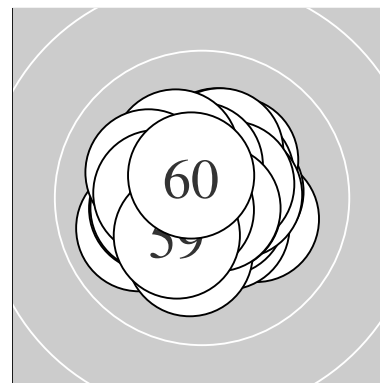

Serie 1:	10.7 *	10.4 *	10.4 *	10.0 ↙	10.5 *
	10.8 *	10.4 *	10.6 *	10.5 *	10.6 *
beste Teiler	36.8 (6.) 69.3 (1.) 78.3 (8.)				
Trefferlage	0.57 mm links, 0.36 mm hoch				
Streuwert	0.82, horizontal: 0.88, vertikal: 0.75				

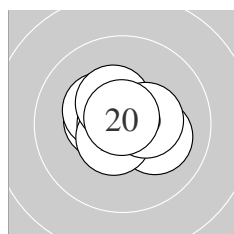

Serie 2:	10.6 *	10.1 ↘	10.4 *	10.6 *	10.3 *
	10.8 *	10.6 *	10.4 *	10.4 *	10.8 *
beste Teiler	39.4 (20.) 46.0 (16.) 87.5 (14.)				
Trefferlage	0.09 mm rechts, 0.16 mm hoch				
Streuwert	0.91, horizontal: 1.12, vertikal: 0.62				

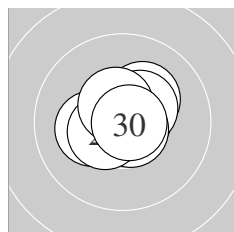

Serie 3:	10.7 *	10.7 *	10.2 *	10.4 *	10.8 *
	10.7 *	10.2 *	10.5 *	10.5 *	10.8 *
beste Teiler	39.2 (30.) 46.0 (25.) 60.0 (21.)				
Trefferlage	0.03 mm links, 0.26 mm hoch				
Streuwert	0.81, horizontal: 0.94, vertikal: 0.66				

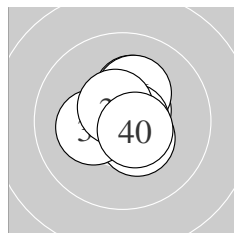

Serie 4:	10.8 *	10.7 *	10.6 *	10.3 *	10.4 *
	10.2 *	10.2 *	10.7 *	10.6 *	10.6 *
beste Teiler	42.5 (31.) 53.0 (38.) 53.7 (32.)				
Trefferlage	0.14 mm rechts, 0.33 mm hoch				
Streuwert	0.85, horizontal: 0.81, vertikal: 0.90				

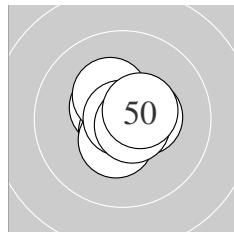

Serie 5:	10.4 *	10.5 *	10.9 *	10.6 *	10.4 *
	10.3 *	10.7 *	10.9 *	10.7 *	10.5 *
beste Teiler	11.1 (48.) 22.8 (43.) 63.9 (47.)				
Trefferlage	0.09 mm rechts, 0.03 mm hoch				
Streuwert	0.75, horizontal: 0.75, vertikal: 0.75				

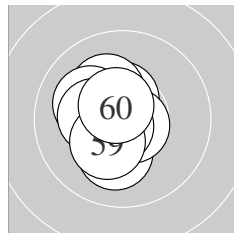

Serie 6:	10.5 *	10.1 ↓	10.5 *	10.2 *	10.1 ↘
	10.7 *	10.3 *	10.7 *	10.3 *	10.6 *
beste Teiler	58.7 (58.) 66.2 (56.) 89.0 (60.)				
Trefferlage	0.72 mm links, 0.01 mm hoch				
Streuwert	0.95, horizontal: 0.73, vertikal: 1.14				

ISSF AR Men – Wertung – Männer

StandNr: 128

Maslennikov, Vladimir #70811309

StartNr: 74

21. Januar 2019 11:28

RUS

QF – Schütze hat sich fürs Finale qualifiziert

Unterschrift des Schützen

Meyton Elektronik

Ergebnis: **625.2** (596)
 Serien: 103.5 105.3 104.9 104.9 103.8 102.8
 Zähler: 56 4 0 0 0 0 0 0 0 0
 Innenzehner: 48
 weiteste: 309 (36), 258 (55), 254 (46)
 beste Teiler 22.8 (47.) 27.2 (35.) 28.0 (16.)
 Trefferlage 0.02 mm links, 0.05 mm tief
 Streuwert 1.07, horizontal: 1.19, vertikal: 0.93

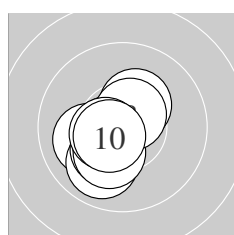
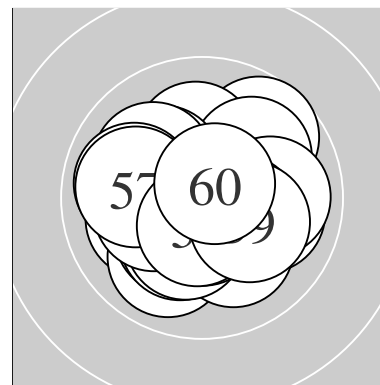

Serie 1:
 10.6 * 10.1 ← 9.9 ↗ 10.3 * 10.4 *
 10.3 * 10.2 * 10.6 * 10.5 * 10.6 *
 beste Teiler 84.1 (1.) 91.9 (8.) 98.7 (10.)
 Trefferlage 0.75 mm links, 0.58 mm tief
 Streuwert 0.95, horizontal: 0.83, vertikal: 1.06

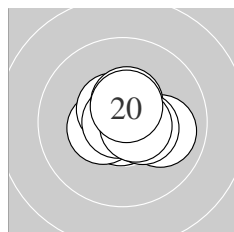

Serie 2:
 10.7 * 10.8 * 10.4 * 10.0 → 10.5 *
 10.8 * 10.5 * 10.4 * 10.6 * 10.6 *
 beste Teiler 28.0 (16.) 47.5 (12.) 51.1 (11.)
 Trefferlage 0.21 mm rechts, 0.09 mm hoch
 Streuwert 0.86, horizontal: 1.03, vertikal: 0.65

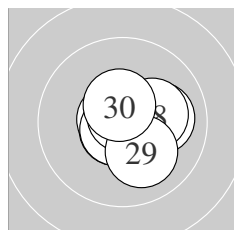

Serie 3:
 10.7 * 10.1 → 10.4 * 10.7 * 10.7 *
 10.7 * 10.8 * 10.2 * 10.1 ↘ 10.5 *
 beste Teiler 38.2 (27.) 60.2 (24.) 60.8 (26.)
 Trefferlage 0.56 mm rechts, 0.01 mm tief
 Streuwert 0.91, horizontal: 1.04, vertikal: 0.77

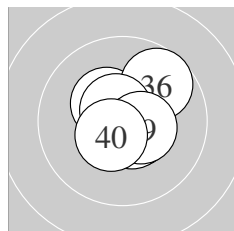

Serie 4:
 10.5 * 10.6 * 10.4 * 10.7 * 10.8 *
 9.7 ↗ 10.6 * 10.6 * 10.5 * 10.5 *
 beste Teiler 27.2 (35.) 72.1 (34.) 80.7 (37.)
 Trefferlage 0.30 mm rechts, 0.18 mm hoch
 Streuwert 0.97, horizontal: 0.94, vertikal: 1.01

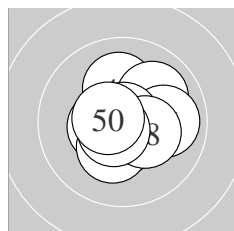

Serie 5:
 10.5 * 10.5 * 10.1 ↑ 10.3 * 10.0 ↗
 9.9 → 10.9 * 10.3 * 10.7 * 10.6 *
 beste Teiler 22.8 (47.) 75.6 (49.) 92.8 (50.)
 Trefferlage 0.22 mm rechts, 0.00 mm
 Streuwert 1.19, horizontal: 1.26, vertikal: 1.11

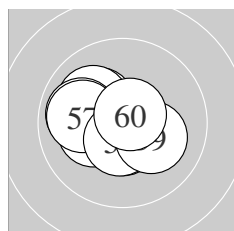

Serie 6:
 10.2 * 10.2 * 10.5 * 10.1 ↘ 9.9 ←
 10.5 * 10.0 ← 10.5 * 10.2 * 10.7 *
 beste Teiler 70.8 (60.) 102.0 (56.) 105.5 (58.)
 Trefferlage 0.69 mm links, 0.00 mm
 Streuwert 1.25, horizontal: 1.52, vertikal: 0.90

Meyton Elektronik

ISSF AR Men – Wertung – Männer

StandNr: 129

Strepfl, Martin #350

StartNr: 75

21. Januar 2019 11:56

AUT

Unterschrift des Schützen

Meyton Elektronik

Ergebnis: **622.2** (597)
 Serien: 104.5 103.2 104.1 102.8 103.8 103.8
 Zähler: 57 3 0 0 0 0 0 0 0 0
 Innenzehner: 44
 weiteste: 280 (42), 268 (16), 261 (32)
 beste Teiler 8.0 (34.) 9.8 (50.) 36.6 (57.)
 Trefferlage 0.13 mm links, 0.17 mm hoch
 Streuwert 1.15, horizontal: 1.36, vertikal: 0.89

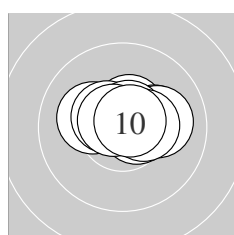
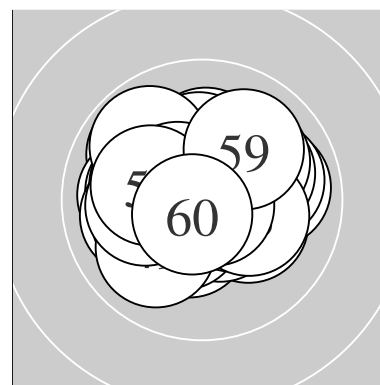

Serie 1:
 10.5 * 10.2 * 10.2 * 10.6 * 10.5 *
 10.1 → 10.6 * 10.7 * 10.4 * 10.7 *
 beste Teiler 60.3 (10.) 71.4 (8.) 76.5 (7.)
 Trefferlage 0.41 mm rechts, 0.45 mm hoch
 Streuwert 0.92, horizontal: 1.27, vertikal: 0.30

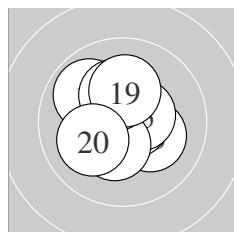

Serie 2:
 10.5 * 10.4 * 10.2 * 10.7 * 10.5 *
 9.9 ↘ 10.4 * 10.3 * 10.2 * 10.1 ←
 beste Teiler 66.0 (14.) 114.2 (15.) 115.1 (11.)
 Trefferlage 0.07 mm links, 0.09 mm hoch
 Streuwert 1.29, horizontal: 1.29, vertikal: 1.28

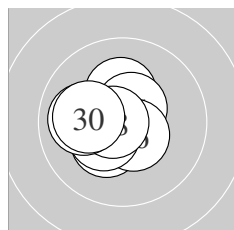

Serie 3:
 10.6 * 10.2 * 10.7 * 10.3 * 10.6 *
 10.5 * 10.4 * 10.7 * 10.0 ← 10.1 ←
 beste Teiler 61.0 (28.) 61.5 (23.) 98.0 (21.)
 Trefferlage 0.62 mm links, 0.07 mm hoch
 Streuwert 1.00, horizontal: 1.06, vertikal: 0.93

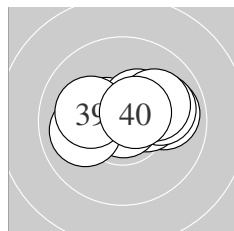

Serie 4:
 10.5 * 9.9 → 10.3 * 10.9 * 10.0 ←
 10.4 * 10.0 → 10.1 → 10.1 ← 10.6 *
 beste Teiler 8.0 (34.) 96.5 (40.) 112.3 (31.)
 Trefferlage 0.48 mm rechts, 0.44 mm hoch
 Streuwert 1.28, horizontal: 1.75, vertikal: 0.48

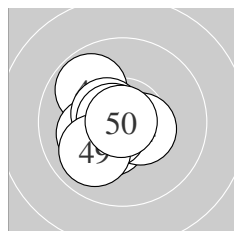

Serie 5:
 10.3 * 9.8 ↘ 10.4 * 10.5 * 10.1 ←
 10.5 * 10.6 * 10.7 * 10.0 ↙ 10.9 *
 beste Teiler 9.8 (50.) 65.9 (48.) 96.6 (47.)
 Trefferlage 0.88 mm links, 0.32 mm tief
 Streuwert 1.00, horizontal: 0.92, vertikal: 1.07

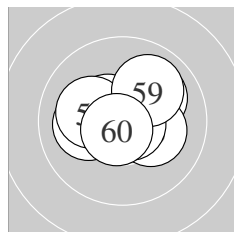

Serie 6:
 10.0 ↗ 10.5 * 10.2 * 10.8 * 10.1 ←
 10.5 * 10.8 * 10.2 * 10.0 ↗ 10.7 *
 beste Teiler 36.6 (57.) 49.6 (54.) 65.4 (60.)
 Trefferlage 0.11 mm links, 0.28 mm hoch
 Streuwert 1.19, horizontal: 1.46, vertikal: 0.84

Meyton Elektronik

ISSF AR Men – Wertung – Männer

StandNr: 130

Nymbursky, Petr #234

StartNr: 76

21. Januar 2019 11:51

CZE

Unterschrift des Schützen

Meyton Elektronik

Ergebnis:	619.5	(592)							
Serien:	102.6	102.8	104.6	104.6	101.9	103.0			
Zähler:	52	8	0	0	0	0	0	0	0
Innenzehner:	48								
weiteste:	384 (8), 354 (44), 340 (41)								
beste Teiler	5.8 (52.)	40.1 (29.)	42.4 (39.)						
Trefferlage	0.44 mm links, 0.52 mm hoch								
Streuwert	1.16, horizontal: 1.14, vertikal: 1.18								

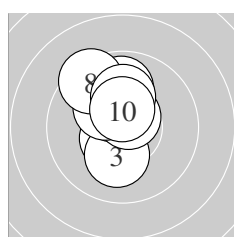
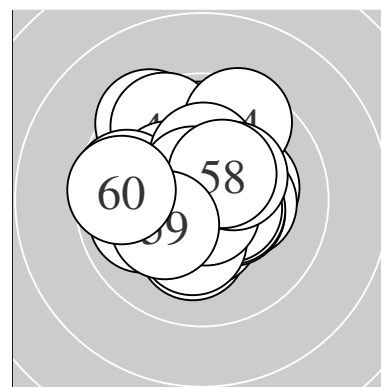

Serie 1:	10.8 *	10.5 *	10.2 *	10.4 *	9.9 ↑
	10.6 *	10.2 *	9.4 ↘	10.1 ↑	10.5 *
beste Teiler	43.5 (1.)	81.4 (6.)	106.0 (2.)		
Trefferlage	0.48 mm links, 1.01 mm hoch				
Streuwert	1.20, horizontal: 0.75, vertikal: 1.52				

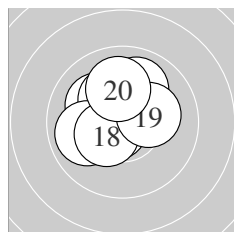

Serie 2:	10.0 ↗	10.1 ↖	10.6 *	10.2 *	9.9 ←
	10.7 *	10.7 *	10.4 *	10.2 *	10.0 ↑
beste Teiler	63.8 (17.)	69.0 (16.)	100.0 (13.)		
Trefferlage	0.49 mm links, 0.71 mm hoch				
Streuwert	1.18, horizontal: 1.22, vertikal: 1.13				

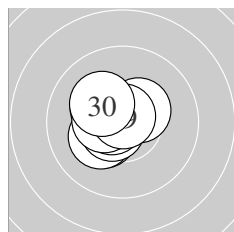

Serie 3:	10.7 *	10.3 *	10.2 *	10.3 *	10.4 *
	10.6 *	10.7 *	10.4 *	10.8 *	10.2 *
beste Teiler	40.1 (29.)	55.4 (21.)	74.0 (27.)		
Trefferlage	0.72 mm links, 0.17 mm hoch				
Streuwert	0.81, horizontal: 0.84, vertikal: 0.77				

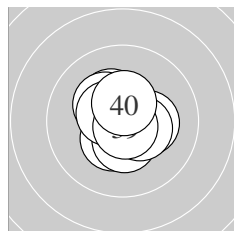

Serie 4:	10.4 *	10.3 *	10.3 *	10.7 *	10.4 *
	10.3 *	10.5 *	10.4 *	10.8 *	10.5 *
beste Teiler	42.4 (39.)	53.8 (34.)	110.5 (37.)		
Trefferlage	0.08 mm links, 0.10 mm hoch				
Streuwert	0.96, horizontal: 0.94, vertikal: 0.97				

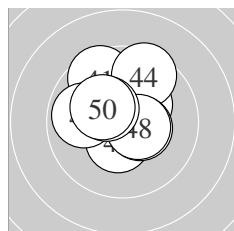

Serie 5:	9.6 ↘	10.6 *	10.3 *	9.5 ↗	10.4 *
	9.9 ←	10.4 *	10.5 *	10.4 *	10.3 *
beste Teiler	78.7 (42.)	112.2 (48.)	127.1 (47.)		
Trefferlage	0.21 mm links, 0.86 mm hoch				
Streuwert	1.43, horizontal: 1.43, vertikal: 1.42				

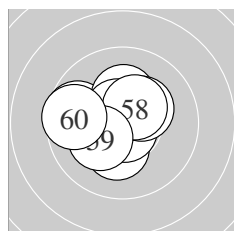

Serie 6:	10.3 *	10.9 *	10.8 *	9.7 ←	10.2 *
	10.3 *	10.6 *	10.4 *	10.2 *	9.6 ←
beste Teiler	5.8 (52.)	49.3 (53.)	88.1 (57.)		
Trefferlage	0.63 mm links, 0.25 mm hoch				
Streuwert	1.33, horizontal: 1.56, vertikal: 1.06				

Meyton Elektronik

ISSF AR Men – Wertung – **Männer**
StandNr: 131
Walder, Markus #150

StartNr: 77
21. Januar 2019 11:27

Unterschrift des Schützen

Meyton Elektronik

Ergebnis: **612.3** (587)
 Serien: 103.3 100.5 102.2 102.3 100.6 103.4
 Zähler: 47 13 0 0 0 0 0 0 0
 Innenzehner: 38
 weiteste: 499 (18), 425 (45), 371 (23)
 beste Teiler 34.0 (56.) 51.1 (60.) 58.0 (27.)
 Trefferlage 0.03 mm links, 0.15 mm hoch
 Streuwert 1.46, horizontal: 1.64, vertikal: 1.27

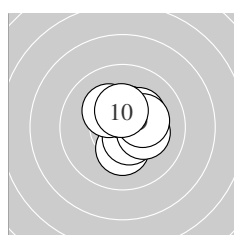
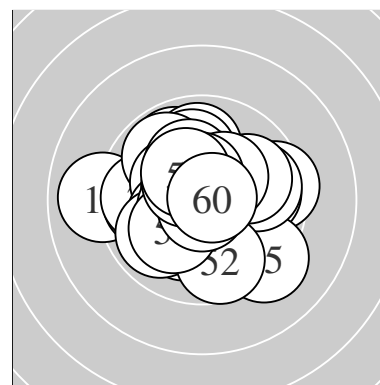

Serie 1:
 10.2 * 10.5 * 10.5 * 10.4 * 10.2 *
 10.4 * 10.3 * 10.2 * 10.2 * 10.4 *
 beste Teiler 106.3 (2.) 124.7 (3.) 127.7 (4.)
 Trefferlage 0.58 mm rechts, 0.45 mm hoch
 Streuwert 1.01, horizontal: 0.89, vertikal: 1.11

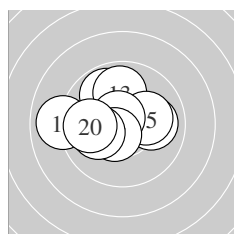

Serie 2:
 10.5 * 9.8 ↘ 9.9 ↑ 10.0 → 10.1 →
 10.7 * 10.5 * 9.0 ← 10.1 ← 9.9 ←
 beste Teiler 65.4 (16.) 109.2 (17.) 125.5 (11.)
 Trefferlage 0.92 mm links, 0.47 mm hoch
 Streuwert 1.73, horizontal: 2.15, vertikal: 1.17

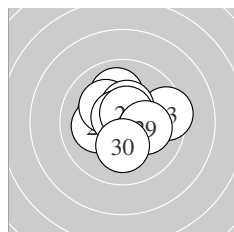

Serie 3:
 10.3 * 10.0 ↑ 9.5 → 10.1 ← 10.2 *
 10.4 * 10.7 * 10.6 * 10.2 * 10.2 *
 beste Teiler 58.0 (27.) 82.4 (28.) 130.3 (26.)
 Trefferlage 0.03 mm rechts, 0.47 mm hoch
 Streuwert 1.46, horizontal: 1.70, vertikal: 1.17

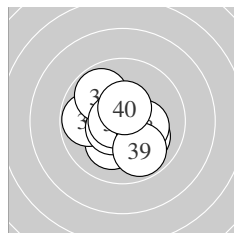

Serie 4:
 10.1 ↘ 10.1 ↙ 9.8 ← 10.7 * 10.5 *
 9.8 ↘ 10.7 * 10.3 * 9.8 ↘ 10.5 *
 beste Teiler 64.0 (37.) 66.5 (34.) 103.1 (35.)
 Trefferlage 0.25 mm links, 0.26 mm tief
 Streuwert 1.43, horizontal: 1.51, vertikal: 1.35

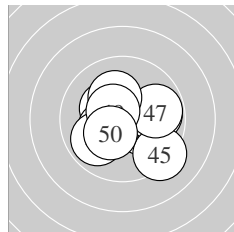

Serie 5:
 10.2 * 9.8 → 10.3 * 10.3 * 9.3 ↘
 9.9 ↙ 9.8 → 10.2 * 10.5 * 10.3 *
 beste Teiler 105.1 (49.) 154.4 (50.) 163.3 (43.)
 Trefferlage 0.28 mm rechts, 0.29 mm tief
 Streuwert 1.75, horizontal: 2.04, vertikal: 1.41

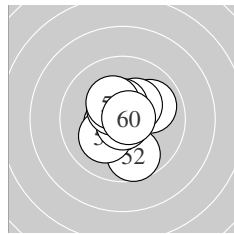

Serie 6:
 10.5 * 9.7 ↓ 10.1 ↙ 10.0 → 10.3 *
 10.8 * 10.5 * 10.5 * 10.3 * 10.7 *
 beste Teiler 34.0 (56.) 51.1 (60.) 107.9 (51.)
 Trefferlage 0.05 mm rechts, 0.06 mm hoch
 Streuwert 1.28, horizontal: 1.14, vertikal: 1.40

Meyton Elektronik

ISSF AR Men – Wertung – **Männer**

StandNr: 132

Tang, Hong An #70811166

StartNr: 78

21. Januar 2019 11:18

SGP

Unterschrift des Schützen

Meyton Elektronik

Ergebnis: **619.2** (593)
 Serien: 103.3 102.6 101.8 103.6 102.6 105.3
 Zähler: 53 7 0 0 0 0 0 0 0
 Innenzehner: 47
 weiteste: 377 (23), 303 (4), 298 (19)
 beste Teiler 6.0 (59.) 46.3 (39.) 46.8 (58.)
 Trefferlage 0.29 mm links, 0.24 mm hoch
 Streuwert 1.20, horizontal: 1.32, vertikal: 1.07

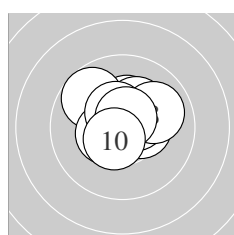
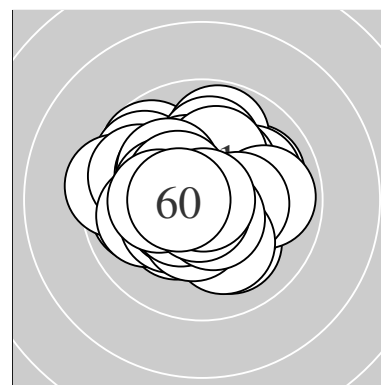

Serie 1:
 10.4 * 10.3 * 10.5 * 9.7 ↘ 10.3 *
 10.4 * 10.5 * 10.0 ↗ 10.7 * 10.5 *
 beste Teiler 72.1 (9.) 104.6 (10.) 110.1 (3.)
 Trefferlage 0.15 mm rechts, 0.70 mm hoch
 Streuwert 1.13, horizontal: 1.31, vertikal: 0.92

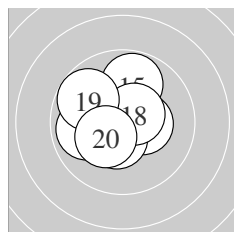

Serie 2:
 10.6 * 10.4 * 10.4 * 10.4 * 9.8 ↑
 10.5 * 9.9 ← 10.5 * 9.8 ↘ 10.3 *
 beste Teiler 76.6 (11.) 101.2 (18.) 122.4 (16.)
 Trefferlage 0.56 mm links, 0.33 mm hoch
 Streuwert 1.32, horizontal: 1.37, vertikal: 1.27

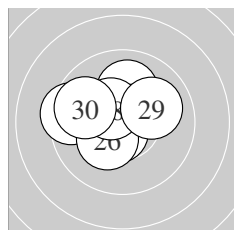

Serie 3:
 10.5 * 10.5 * 9.4 ← 10.6 * 10.3 *
 10.3 * 10.0 ↑ 10.4 * 10.0 ↗ 9.8 ←
 beste Teiler 81.4 (24.) 101.8 (22.) 106.5 (21.)
 Trefferlage 0.53 mm links, 0.53 mm hoch
 Streuwert 1.45, horizontal: 1.73, vertikal: 1.09

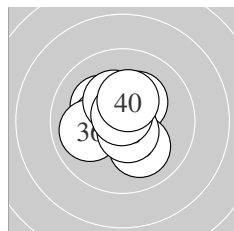

Serie 4:
 10.2 * 10.3 * 10.1 ↘ 10.4 * 10.6 *
 10.0 ← 10.3 * 10.6 * 10.8 * 10.3 *
 beste Teiler 46.3 (39.) 81.4 (35.) 86.3 (38.)
 Trefferlage 0.34 mm links, 0.32 mm hoch
 Streuwert 1.15, horizontal: 1.18, vertikal: 1.13

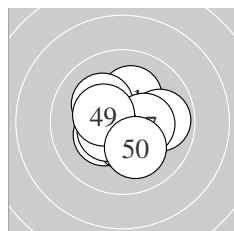

Serie 5:
 10.2 * 10.3 * 10.2 * 10.3 * 10.4 *
 9.9 → 10.3 * 10.5 * 10.4 * 10.1 ↘
 beste Teiler 122.2 (48.) 132.0 (45.) 147.1 (49.)
 Trefferlage 0.20 mm rechts, 0.20 mm tief
 Streuwert 1.32, horizontal: 1.46, vertikal: 1.17

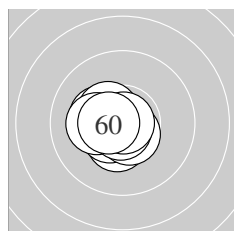

Serie 6:
 10.4 * 10.3 * 10.7 * 10.4 * 10.5 *
 10.6 * 10.2 * 10.8 * 10.9 * 10.5 *
 beste Teiler 6.0 (59.) 46.8 (58.) 61.2 (53.)
 Trefferlage 0.70 mm links, 0.21 mm tief
 Streuwert 0.68, horizontal: 0.74, vertikal: 0.60

Meyton Elektronik

ISSF AR Men – Wertung – Männer

StandNr: 133

Huber, Caspar #70811310

StartNr: 79

21. Januar 2019 11:46

SUI – ZH

Unterschrift des Schützen

Meyton Elektronik

Ergebnis:	621.8	(590)					
Serien:	103.0	103.8	104.0	102.7	103.6	104.7	
Zähler:	50	10	0	0	0	0	0
Innenzehner:	43						
weiteste:	416 (11), 301 (16), 290 (57)						
beste Teiler	11.6 (3.) 12.6 (56.) 19.7 (10.)						
Trefferlage	0.28 mm links, 0.28 mm hoch						
Streuwert	1.18, horizontal: 1.16, vertikal: 1.20						

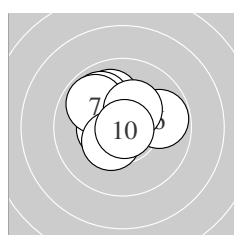
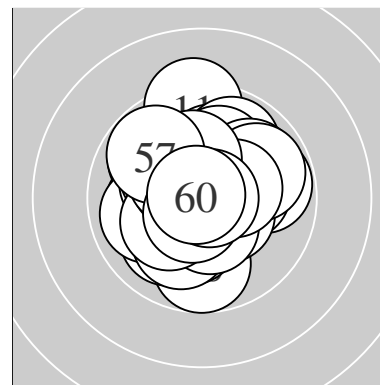

Serie 1:	10.5 *	10.0 ↘	10.9 *	10.4 *	9.9 ↘
	9.8 →	9.9 ↘	10.4 *	10.3 *	10.9 *
beste Teiler	11.6 (3.) 19.7 (10.) 106.6 (1.)				
Trefferlage	0.40 mm links, 0.71 mm hoch				
Streuwert	1.25, horizontal: 1.41, vertikal: 1.08				

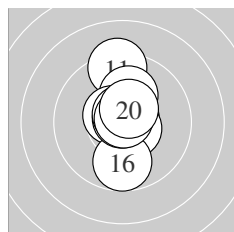

Serie 2:	9.3 ↑	10.7 *	10.1 ↑	10.6 *	10.6 *
	9.7 ↓	10.8 *	10.7 *	10.8 *	10.5 *
beste Teiler	27.6 (17.) 29.1 (19.) 59.4 (18.)				
Trefferlage	0.09 mm rechts, 0.57 mm hoch				
Streuwert	1.32, horizontal: 0.47, vertikal: 1.80				

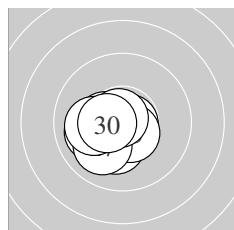

Serie 3:	10.0 ←	10.8 *	10.7 *	10.2 *	10.5 *
	10.4 *	10.0 ↙	10.1 ←	10.8 *	10.5 *
beste Teiler	41.7 (29.) 48.7 (22.) 73.0 (23.)				
Trefferlage	0.81 mm links, 0.59 mm tief				
Streuwert	0.88, horizontal: 1.02, vertikal: 0.71				

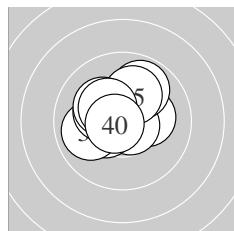

Serie 4:	10.2 *	10.7 *	10.4 *	9.9 ↗	10.1 ↗
	9.9 ←	10.3 *	10.2 *	10.3 *	10.7 *
beste Teiler	64.1 (40.) 66.7 (32.) 140.6 (33.)				
Trefferlage	0.40 mm links, 0.56 mm hoch				
Streuwert	1.26, horizontal: 1.43, vertikal: 1.06				

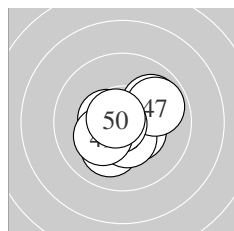

Serie 5:	10.1 ↘	9.9 ↗	10.7 *	10.4 *	10.4 *
	10.5 *	9.9 ↗	10.8 *	10.2 *	10.7 *
beste Teiler	41.7 (48.) 57.0 (43.) 59.4 (50.)				
Trefferlage	0.21 mm rechts, 0.20 mm tief				
Streuwert	1.22, horizontal: 1.37, vertikal: 1.05				

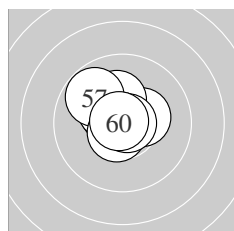

Serie 6:	10.4 *	10.4 *	10.3 *	10.5 *	10.2 *
	10.9 *	9.8 ↘	10.6 *	10.8 *	10.8 *
beste Teiler	12.6 (56.) 30.4 (60.) 34.0 (59.)				
Trefferlage	0.39 mm links, 0.62 mm hoch				
Streuwert	0.90, horizontal: 0.95, vertikal: 0.84				

Meyton Elektronik

ISSF AR Men – Wertung – **Männer**

StandNr: 134

Greuter, Sandro #70811311

StartNr: 80

21. Januar 2019 11:53

SUI – Sportschützen Sargans

Unterschrift des Schützen

Meyton Elektronik

Ergebnis:	587.9	(560)
Serien:	100.6	101.6 98.3 97.3 93.3 96.8
Zähler:	27 27 5 1 0 0 0 0 0 0	
Innenzehner:	23	
weiteste:	978 (42), 670 (37), 599 (51)	
beste Teiler	17.0 (4.) 50.2 (41.) 60.2 (38.)	
Trefferlage	0.44 mm rechts, 0.19 mm hoch	
Streuwert	2.42, horizontal: 2.95, vertikal: 1.73	

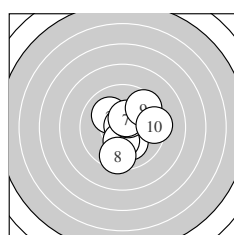
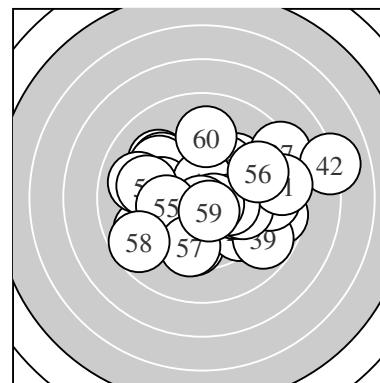

Serie 1:	10.1 ↘	10.1 ↖	9.7 ↗	10.9 *	10.3 *
	10.5 *	10.5 *	9.5 ↓	9.6 ↗	9.4 →
beste Teiler	17.0 (4.)	117.3 (7.)	118.0 (6.)		
Trefferlage	0.86 mm rechts, 0.12 mm hoch				
Streuwert	1.78, horizontal: 1.68, vertikal: 1.88				

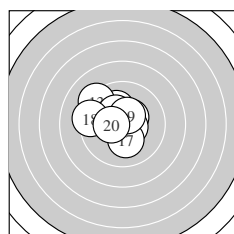

Serie 2:	10.1 ↖	10.6 *	9.2 ↖	10.4 *	10.3 *
	10.6 *	10.2 *	9.3 ←	10.5 *	10.4 *
beste Teiler	81.4 (12.)	93.9 (16.)	119.8 (19.)		
Trefferlage	0.80 mm links, 0.68 mm hoch				
Streuwert	1.50, horizontal: 1.68, vertikal: 1.28				

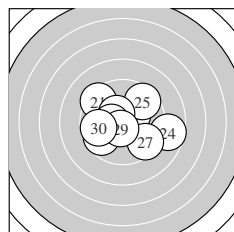

Serie 3:	9.4 ↖	9.7 ↖	10.4 *	8.7 →	9.5 ↗
	10.4 *	9.5 ↘	10.4 *	10.6 *	9.7 ←
beste Teiler	83.1 (29.)	128.2 (26.)	137.0 (28.)		
Trefferlage	0.11 mm rechts, 0.00 mm				
Streuwert	2.36, horizontal: 2.85, vertikal: 1.73				

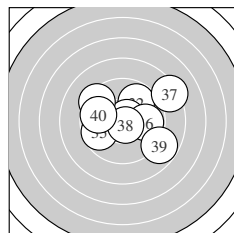

Serie 4:	10.4 *	9.8 ↗	10.7 *	9.4 ↖	9.7 ←
	9.8 →	8.3 ↗	10.7 *	8.8 ↘	9.7 ←
beste Teiler	60.2 (38.)	66.2 (33.)	132.2 (31.)		
Trefferlage	0.78 mm rechts, 0.47 mm hoch				
Streuwert	2.57, horizontal: 3.11, vertikal: 1.89				

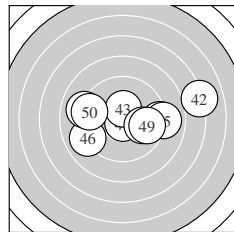

Serie 5:	10.8 *	7.0 →	10.5 *	9.1 →	9.0 →
	9.0 ←	9.9 →	9.0 ←	9.7 →	9.3 ←
beste Teiler	50.2 (41.)	125.3 (43.)	254.2 (47.)		
Trefferlage	1.14 mm rechts, 0.11 mm hoch				
Streuwert	3.42, horizontal: 4.65, vertikal: 1.37				

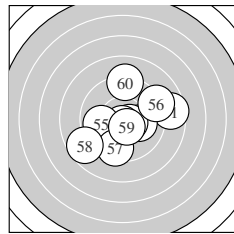

Serie 6:	8.6 →	10.1 →	10.6 *	10.7 *	9.9 ←
	9.1 ↗	9.5 ↓	8.7 ↖	10.5 *	9.1 ↑
beste Teiler	60.5 (54.)	97.0 (53.)	110.0 (59.)		
Trefferlage	0.54 mm rechts, 0.24 mm tief				
Streuwert	2.72, horizontal: 3.05, vertikal: 2.35				

Meyton Elektronik

ISSF AR Men – Wertung – Männer

StandNr: 135

Jaden, Neo Yu Zhen #70811176

StartNr: 81

21. Januar 2019 11:36

SGP

Unterschrift des Schützen

Meyton Elektronik

Ergebnis: **622.1** (595)
 Serien: 103.0 104.9 104.2 103.1 102.5 104.4
 Zähler: 55 5 0 0 0 0 0 0 0 0
 Innenzehner: 47
 weiteste: 476 (43), 459 (4), 285 (34)
 beste Teiler 6.7 (53.) 7.0 (51.) 19.6 (29.)
 Trefferlage 0.38 mm rechts, 0.40 mm hoch
 Streuwert 1.15, horizontal: 1.37, vertikal: 0.88

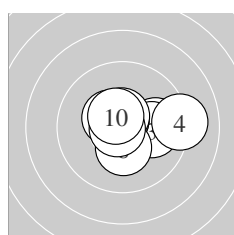
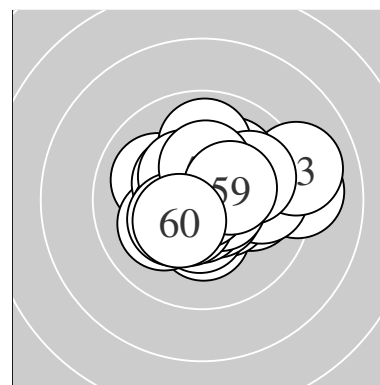

Serie 1:
 9.9 → 10.4 * 10.0 → 9.1 → 10.7 *
 10.7 * 10.6 * 10.3 * 10.8 * 10.5 *
 beste Teiler 44.6 (9.) 54.1 (6.) 63.1 (5.)
 Trefferlage 0.72 mm rechts, 0.22 mm hoch
 Streuwert 1.39, horizontal: 1.81, vertikal: 0.76

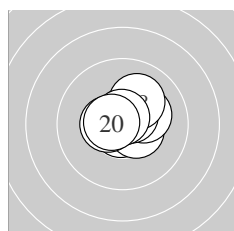

Serie 2:
 10.8 * 10.5 * 10.5 * 10.3 * 10.6 *
 10.2 * 10.6 * 10.1 ↗ 10.7 * 10.6 *
 beste Teiler 44.9 (11.) 54.5 (19.) 87.3 (15.)
 Trefferlage 0.38 mm rechts, 0.50 mm hoch
 Streuwert 0.84, horizontal: 0.95, vertikal: 0.71

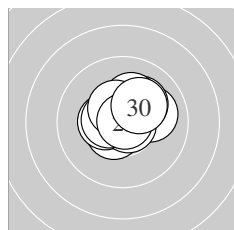

Serie 3:
 10.5 * 10.0 → 10.2 * 10.2 * 10.4 *
 10.8 * 10.5 * 10.5 * 10.9 * 10.2 *
 beste Teiler 19.6 (29.) 49.6 (26.) 101.8 (21.)
 Trefferlage 0.25 mm rechts, 0.55 mm hoch
 Streuwert 1.01, horizontal: 1.17, vertikal: 0.81

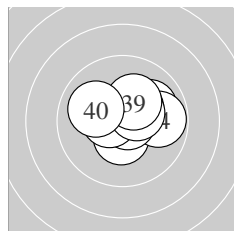

Serie 4:
 10.4 * 10.6 * 10.0 ↗ 9.8 → 10.8 *
 10.4 * 10.5 * 10.4 * 10.2 * 10.0 ↖
 beste Teiler 41.3 (35.) 93.3 (32.) 105.6 (37.)
 Trefferlage 0.57 mm rechts, 0.49 mm hoch
 Streuwert 1.16, horizontal: 1.44, vertikal: 0.79

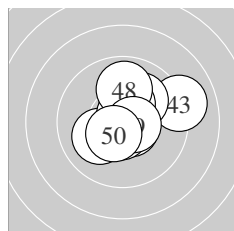

Serie 5:
 10.1 ↙ 10.6 * 9.0 → 10.6 * 10.1 ↗
 10.4 * 10.7 * 9.9 ↑ 10.6 * 10.5 *
 beste Teiler 61.1 (47.) 80.0 (44.) 82.9 (42.)
 Trefferlage 0.54 mm rechts, 0.42 mm hoch
 Streuwert 1.50, horizontal: 1.65, vertikal: 1.32

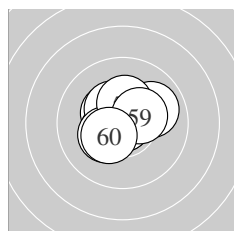

Serie 6:
 10.9 * 10.0 → 10.9 * 10.4 * 10.4 *
 10.4 * 10.3 * 10.3 * 10.4 * 10.4 *
 beste Teiler 6.7 (53.) 7.0 (51.) 128.7 (55.)
 Trefferlage 0.16 mm links, 0.25 mm hoch
 Streuwert 1.07, horizontal: 1.20, vertikal: 0.91

Meyton Elektronik

ISSF AR Men – Wertung – Männer

StandNr: 136

Dempster, Christenson #70811312

StartNr: 82

21. Januar 2019 11:55

USA

Unterschrift des Schützen

Meyton Elektronik

Ergebnis:	621.5	(594)							
Serien:	102.1	104.6	103.6	104.7	102.5	104.0			
Zähler:	54	6	0	0	0	0	0	0	0
Innenzehner:	47								
weiteste:	346 (44),	298 (58),	283 (42)						
beste Teiler	4.1 (12.)	42.1 (52.)	49.6 (14.)						
Trefferlage	0.27 mm rechts, 0.50 mm hoch								
Streuwert	1.11, horizontal: 1.25, vertikal: 0.94								

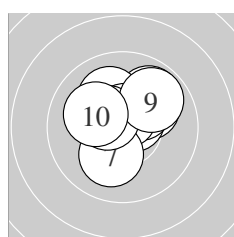
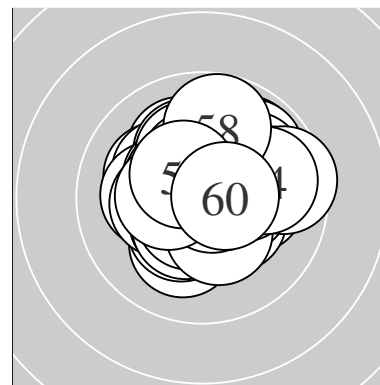

Serie 1:	10.1 ↗	10.6 *	10.2 *	9.9 ↗	10.1 ↘
	10.6 *	10.1 ↙	10.5 *	9.9 ↗	10.1 ↘
beste Teiler	80.4 (6.) 88.6 (2.) 123.4 (8.)				
Trefferlage	0.29 mm rechts, 0.95 mm hoch				
Streuwert	1.27, horizontal: 1.39, vertikal: 1.14				

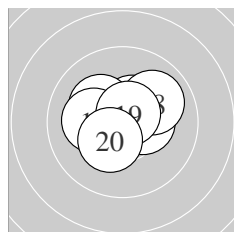

Serie 2:	10.6 *	10.9 *	10.5 *	10.8 *	10.4 *
	10.2 *	10.2 *	10.0 ↗	10.7 *	10.3 *
beste Teiler	4.1 (12.) 49.6 (14.) 71.5 (19.)				
Trefferlage	0.09 mm links, 0.32 mm hoch				
Streuwert	1.04, horizontal: 1.26, vertikal: 0.76				

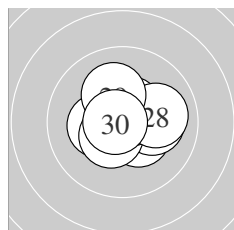

Serie 3:	10.3 *	10.5 *	10.4 *	10.2 *	10.1 →
	10.5 *	10.7 *	10.0 →	10.2 *	10.7 *
beste Teiler	52.0 (30.) 75.1 (27.) 106.0 (22.)				
Trefferlage	0.48 mm rechts, 0.18 mm hoch				
Streuwert	1.13, horizontal: 1.36, vertikal: 0.84				

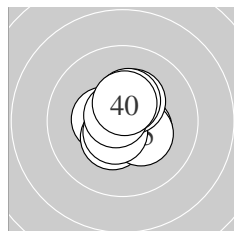

Serie 4:	10.4 *	10.7 *	10.4 *	10.4 *	10.3 *
	10.6 *	10.3 *	10.7 *	10.4 *	10.5 *
beste Teiler	54.1 (32.) 60.3 (38.) 90.6 (36.)				
Trefferlage	0.13 mm rechts, 0.13 mm hoch				
Streuwert	0.91, horizontal: 0.86, vertikal: 0.96				

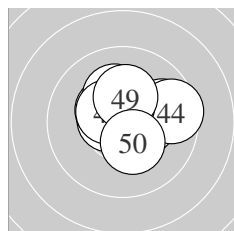

Serie 5:	10.6 *	9.8 →	10.4 *	9.6 →	10.4 *
	10.2 *	10.5 *	10.5 *	10.2 *	10.3 *
beste Teiler	94.3 (41.) 119.0 (47.) 123.4 (48.)				
Trefferlage	0.49 mm rechts, 0.64 mm hoch				
Streuwert	1.30, horizontal: 1.58, vertikal: 0.93				

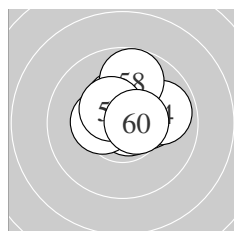

Serie 6:	10.4 *	10.8 *	10.3 *	9.9 →	10.6 *
	10.7 *	10.4 *	9.8 ↑	10.5 *	10.6 *
beste Teiler	42.1 (52.) 74.0 (56.) 81.0 (55.)				
Trefferlage	0.32 mm rechts, 0.78 mm hoch				
Streuwert	1.05, horizontal: 1.20, vertikal: 0.88				

Meyton Elektronik

ISSF AR Men – Wertung – Männer

StandNr: 137

Akhil, Sheoran #70811313

StartNr: 83

21. Januar 2019 11:53

India

Unterschrift des Schützen

Meyton Elektronik

Ergebnis: **614.5** (590)
 Serien: 100.9 103.0 103.4 103.0 101.7 102.5
 Zähler: 50 10 0 0 0 0 0 0 0
 Innenzehner: 41
 weiteste: 359 (45), 332 (39), 327 (6)
 beste Teiler 43.7 (21.) 49.7 (38.) 55.5 (23.)
 Trefferlage 0.41 mm rechts, 0.22 mm hoch
 Streuwert 1.33, horizontal: 1.44, vertikal: 1.21

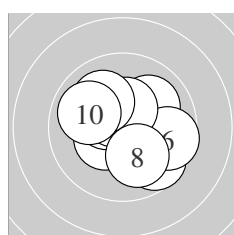
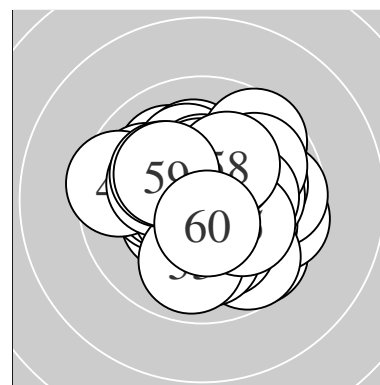

Serie 1:
 10.4 * 10.4 * 10.0 ↗ 10.5 * 9.7 ↘
 9.6 → 10.4 * 10.0 ↘ 10.0 ↖ 9.9 ↖
 beste Teiler 104.6 (4.) 130.0 (2.) 131.2 (7.)
 Trefferlage 0.18 mm rechts, 0.12 mm hoch
 Streuwert 1.65, horizontal: 1.83, vertikal: 1.46

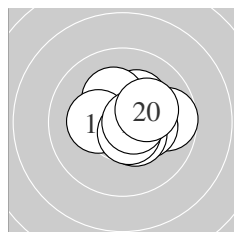

Serie 2:
 10.3 * 10.3 * 9.7 → 10.2 * 10.3 *
 10.3 * 10.5 * 10.6 * 10.6 * 10.2 *
 beste Teiler 78.0 (19.) 87.9 (18.) 124.4 (17.)
 Trefferlage 0.65 mm rechts, 0.37 mm hoch
 Streuwert 1.18, horizontal: 1.38, vertikal: 0.93

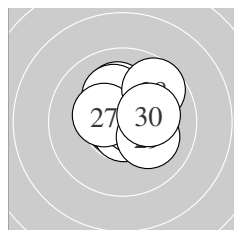

Serie 3:
 10.8 * 10.1 ↑ 10.7 * 10.6 * 10.6 *
 10.2 * 10.4 * 9.7 ↗ 10.1 ↘ 10.2 *
 beste Teiler 43.7 (21.) 55.5 (23.) 78.1 (25.)
 Trefferlage 0.47 mm rechts, 0.59 mm hoch
 Streuwert 1.16, horizontal: 1.20, vertikal: 1.12

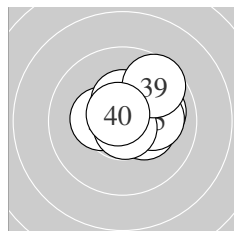

Serie 4:
 10.3 * 10.0 → 10.4 * 10.3 * 10.1 →
 10.4 * 10.4 * 10.8 * 9.6 ↗ 10.7 *
 beste Teiler 49.7 (38.) 59.0 (40.) 129.2 (33.)
 Trefferlage 0.92 mm rechts, 0.45 mm hoch
 Streuwert 1.11, horizontal: 1.26, vertikal: 0.92

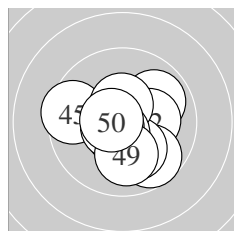

Serie 5:
 9.9 ↗ 10.2 * 9.7 ↘ 10.1 ↘ 9.5 ←
 10.5 * 10.6 * 10.6 * 10.0 ↓ 10.6 *
 beste Teiler 80.0 (50.) 81.3 (48.) 85.2 (47.)
 Trefferlage 0.17 mm rechts, 0.40 mm tief
 Streuwert 1.57, horizontal: 1.72, vertikal: 1.40

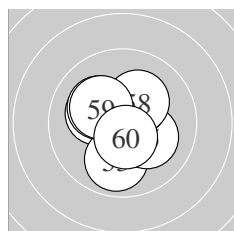

Serie 6:
 10.5 * 10.2 * 9.9 ↓ 10.3 * 10.2 *
 10.3 * 10.2 * 10.2 * 10.2 * 10.5 *
 beste Teiler 102.3 (60.) 123.0 (51.) 157.8 (56.)
 Trefferlage 0.05 mm rechts, 0.19 mm hoch
 Streuwert 1.35, horizontal: 1.32, vertikal: 1.38

Meyton Elektronik

ISSF AR Men – Wertung – **Männer**

StandNr: 138

Rositer, Jack #70811314

StartNr: 84

21. Januar 2019 11:52

AUS

Unterschrift des Schützen

Meyton Elektronik

Ergebnis: **625.1** (596)
 Serien: 101.3 105.7 105.2 103.3 104.6 105.0
 Zähler: 56 4 0 0 0 0 0 0 0
 Innenzehner: 46
 weiteste: 434 (1), 326 (2), 263 (53)
 beste Teiler 10.7 (8.) 14.0 (16.) 14.2 (15.)
 Trefferlage 0.50 mm rechts, 0.06 mm hoch
 Streuwert 1.05, horizontal: 1.14, vertikal: 0.95

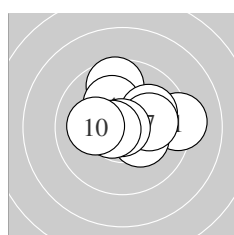
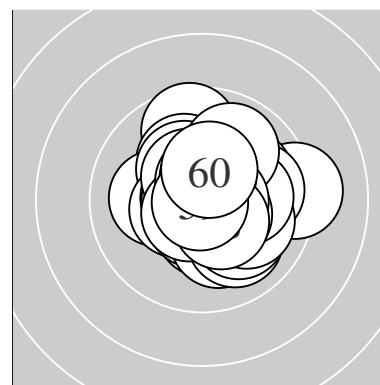

Serie 1:
 9.2 → 9.6 ↑ 10.3 * 10.2 * 10.3 *
 10.0 ↗ 10.1 → 10.9 * 10.6 * 10.1 ←
 beste Teiler 10.7 (8.) 83.5 (9.) 162.0 (5.)
 Trefferlage 0.44 mm rechts, 0.74 mm hoch
 Streuwert 1.60, horizontal: 1.94, vertikal: 1.18

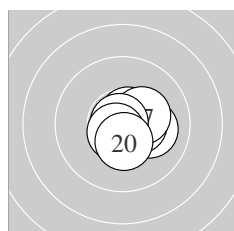

Serie 2:
 10.1 → 10.6 * 10.5 * 10.6 * 10.9 *
 10.9 * 10.3 * 10.8 * 10.6 * 10.4 *
 beste Teiler 14.0 (16.) 14.2 (15.) 29.0 (18.)
 Trefferlage 0.39 mm rechts, 0.13 mm tief
 Streuwert 0.77, horizontal: 0.89, vertikal: 0.62

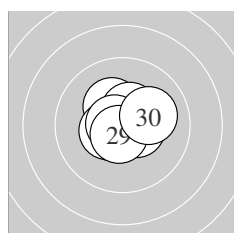

Serie 3:
 10.6 * 10.5 * 10.8 * 10.3 * 10.5 *
 10.6 * 10.5 * 10.7 * 10.6 * 10.1 →
 beste Teiler 41.9 (23.) 63.7 (28.) 77.2 (29.)
 Trefferlage 0.12 mm links, 0.11 mm hoch
 Streuwert 0.88, horizontal: 1.01, vertikal: 0.73

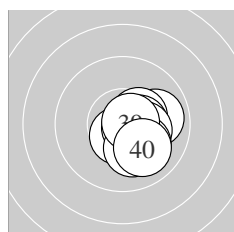

Serie 4:
 9.9 → 10.6 * 10.4 * 10.4 * 10.3 *
 10.7 * 10.1 ↘ 10.2 * 10.7 * 10.0 ↘
 beste Teiler 63.5 (39.) 67.5 (36.) 96.7 (32.)
 Trefferlage 1.13 mm rechts, 0.56 mm tief
 Streuwert 0.85, horizontal: 0.77, vertikal: 0.92

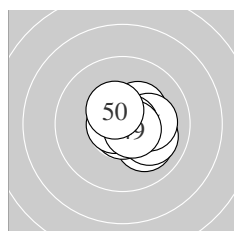

Serie 5:
 10.8 * 10.1 ↘ 10.0 ↘ 10.3 * 10.1 →
 10.8 * 10.7 * 10.7 * 10.6 * 10.5 *
 beste Teiler 34.1 (41.) 49.0 (46.) 52.0 (47.)
 Trefferlage 0.68 mm rechts, 0.08 mm tief
 Streuwert 0.92, horizontal: 1.04, vertikal: 0.80

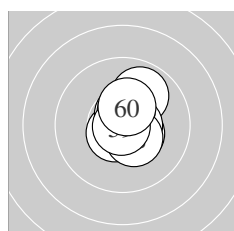

Serie 6:
 10.6 * 10.6 * 9.9 ↗ 10.5 * 10.6 *
 10.6 * 10.5 * 10.4 * 10.9 * 10.4 *
 beste Teiler 14.8 (59.) 78.1 (51.) 85.2 (55.)
 Trefferlage 0.48 mm rechts, 0.30 mm hoch
 Streuwert 0.85, horizontal: 0.59, vertikal: 1.04

Meyton Elektronik

ISSF AR Men – Wertung – Männer

StandNr: 139

Matsumoto, Takayuki #70811315

StartNr: 85

21. Januar 2019 11:45

JPN

Unterschrift des Schützen

Meyton Elektronik

Ergebnis: **593.7** (567)

Serien: 99.2 98.2 96.9 99.9 101.4 98.1

Zähler: 32 23 5 0 0 0 0 0 0 0

Innenzehner: 21

weiteste: 704 (29), 599 (12), 521 (33)

beste Teiler 48.0 (49.) 58.9 (34.) 78.6 (35.)

Trefferlage 0.61 mm rechts, 0.23 mm hoch

Streuwert 2.09, horizontal: 2.38, vertikal: 1.77

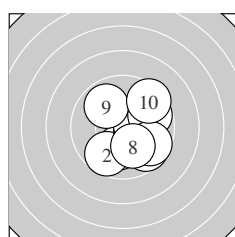
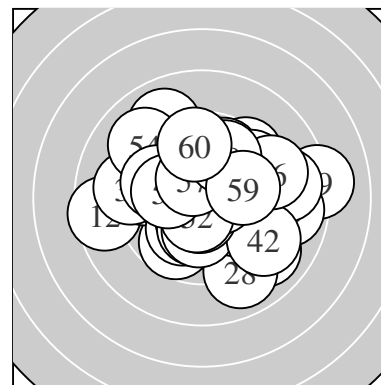

Serie 1:

10.1 ↓	9.7 ↙	10.4 *	9.7 ↘	10.4 *
9.7 →	9.7 ↘	10.1 ↓	9.9 ↖	9.5 ↗

beste Teiler 133.4 (5.) 144.8 (3.) 212.6 (1.)

Trefferlage 1.05 mm rechts, 0.47 mm tief

Streuwert 1.84, horizontal: 1.72, vertikal: 1.95

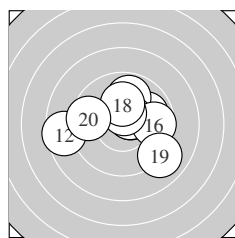

Serie 2:

9.9 →	8.6 ←	10.5 *	9.8 ↑	10.5 *
9.7 →	10.5 *	10.1 ↑	9.0 ↘	9.6 ←

beste Teiler 101.2 (15.) 105.2 (13.) 109.3 (17.)

Trefferlage 0.22 mm rechts, 0.46 mm hoch

Streuwert 2.38, horizontal: 2.95, vertikal: 1.62

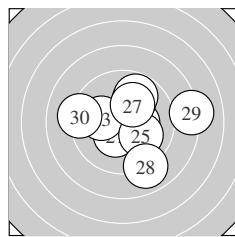

Serie 3:

10.4 *	10.3 *	10.1 ←	10.0 ↗	10.0 ↘
9.8 ↗	10.1 ↗	8.9 ↘	8.1 →	9.2 ←

beste Teiler 149.0 (21.) 152.1 (22.) 202.4 (27.)

Trefferlage 0.89 mm rechts, 0.14 mm hoch

Streuwert 2.57, horizontal: 2.98, vertikal: 2.08

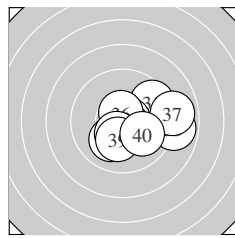

Serie 4:

9.5 ↗	10.1 ↙	8.9 →	10.7 *	10.6 *
10.6 *	8.9 →	10.4 *	10.2 *	10.0 ↘

beste Teiler 58.9 (34.) 78.6 (35.) 86.8 (36.)

Trefferlage 1.38 mm rechts, 0.38 mm tief

Streuwert 1.87, horizontal: 2.32, vertikal: 1.26

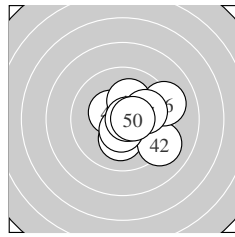

Serie 5:

10.2 *	9.2 ↘	10.4 *	10.4 *	10.2 *
9.2 →	10.0 →	10.5 *	10.8 *	10.5 *

beste Teiler 48.0 (49.) 103.0 (50.) 110.8 (48.)

Trefferlage 1.13 mm rechts, 0.04 mm hoch

Streuwert 1.61, horizontal: 1.74, vertikal: 1.47

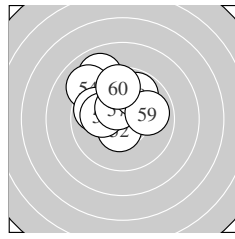

Serie 6:

9.0 ↖	10.5 *	9.9 ↖	9.1 ↖	9.8 ↖
10.1 ←	10.4 *	9.8 ↑	9.9 →	9.6 ↑

beste Teiler 110.7 (52.) 128.3 (57.) 210.8 (56.)

Trefferlage 1.03 mm links, 1.63 mm hoch

Streuwert 1.77, horizontal: 1.89, vertikal: 1.65

Meyton Elektronik

ISSF AR Men – Wertung – Männer

StandNr: 140

Shjinbat, Erdembileg #70811316

StartNr: 86

21. Januar 2019 11:24

SUI – ZH

Unterschrift des Schützen

Meyton Elektronik

Ergebnis:	617.7	(591)							
Serien:	101.2	103.5	103.9	102.4	104.0	102.7			
Zähler:	51	9	0	0	0	0	0	0	0
Innenzehner:	38								
weiteste:	381 (9),	332 (13),	330 (51)						
beste Teiler	10.0 (16.)	19.2 (24.)	20.0 (25.)						
Trefferlage	0.34 mm rechts, 0.18 mm hoch								
Streuwert	1.29, horizontal: 1.47, vertikal: 1.06								

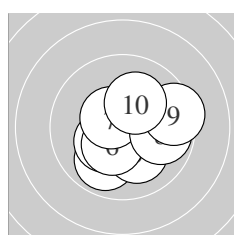
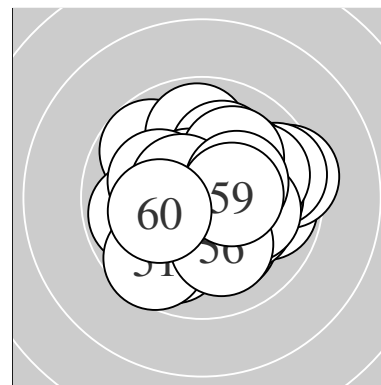

Serie 1:

10.0 →	9.9 ↘	10.1 ↘	10.3 *	10.6 *
10.4 *	10.5 *	9.8 →	9.4 →	10.2 *
beste Teiler	87.2 (5.)	108.0 (7.)	143.5 (6.)	
Trefferlage	0.59 mm rechts, 0.24 mm tief			
Streuwert	1.60, horizontal: 1.83, vertikal: 1.32			

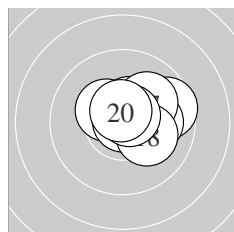

Serie 2:

10.4 *	10.5 *	9.6 →	10.4 *	10.1 →
10.9 *	10.1 ↗	10.2 *	10.7 *	10.6 *
beste Teiler	10.0 (16.)	68.5 (19.)	83.0 (20.)	
Trefferlage	0.98 mm rechts, 0.45 mm hoch			
Streuwert	1.03, horizontal: 1.28, vertikal: 0.71			

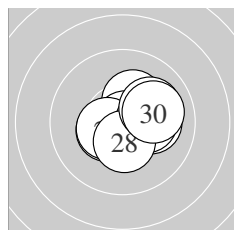

Serie 3:

10.4 *	10.3 *	10.1 →	10.9 *	10.9 *
10.5 *	10.3 *	10.4 *	10.1 ↗	10.0 →
beste Teiler	19.2 (24.)	20.0 (25.)	119.6 (26.)	
Trefferlage	0.69 mm rechts, 0.07 mm hoch			
Streuwert	1.07, horizontal: 1.25, vertikal: 0.84			

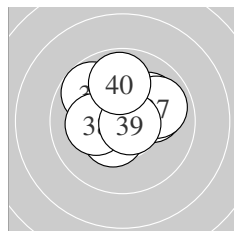

Serie 4:

10.6 *	10.4 *	10.1 ↗	10.7 *	10.1 →
9.8 ↘	9.9 →	10.2 *	10.7 *	9.9 ↑
beste Teiler	51.6 (34.)	55.3 (39.)	82.3 (31.)	
Trefferlage	0.15 mm rechts, 0.75 mm hoch			
Streuwert	1.37, horizontal: 1.59, vertikal: 1.11			

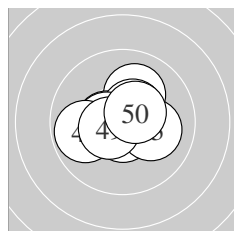

Serie 5:

10.7 *	10.8 *	10.1 →	10.1 ↗	10.5 *
10.5 *	10.5 *	9.8 ←	10.5 *	10.5 *
beste Teiler	50.6 (42.)	67.0 (41.)	104.6 (49.)	
Trefferlage	0.08 mm links, 0.12 mm hoch			
Streuwert	1.14, horizontal: 1.38, vertikal: 0.84			

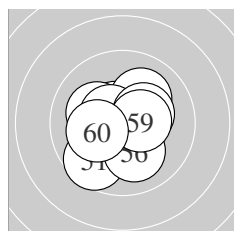

Serie 6:

9.6 ↘	10.6 *	10.7 *	10.1 ↗	10.2 *
10.1 ↘	10.5 *	10.3 *	10.4 *	10.2 *
beste Teiler	51.8 (53.)	93.8 (52.)	102.2 (57.)	
Trefferlage	0.24 mm links, 0.01 mm tief			
Streuwert	1.37, horizontal: 1.41, vertikal: 1.34			

ISSF AR Men – Wertung – **Männer**

StandNr: 141

Dürr, Christoph #70811317

StartNr: 87

21. Januar 2019 11:51

SUI

Unterschrift des Schützen

Meyton Elektronik

Ergebnis:	625.5	(596) ^{QF}					
Serien:	105.3	104.3	104.2	104.4	104.4	102.9	
Zähler:	56	4	0	0	0	0	0
Innenzehner:	53						
weiteste:	479 (54), 324 (47), 269 (60)						
beste Teiler	25.1 (26.) 28.0 (41.) 33.6 (9.)						
Trefferlage	0.13 mm links, 0.28 mm hoch						
Streuwert	1.06, horizontal: 1.17, vertikal: 0.93						

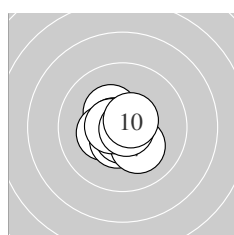
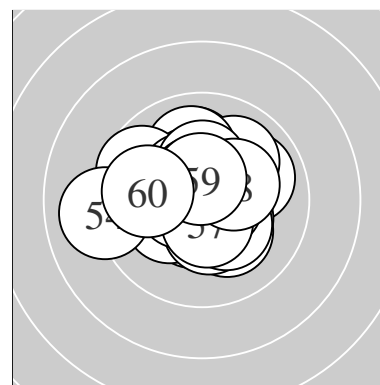

Serie 1:	10.3 *	10.3 *	10.7 *	10.5 *	10.6 *
	10.7 *	10.2 *	10.6 *	10.8 *	10.6 *
beste Teiler	33.6 (9.) 71.5 (3.) 72.1 (6.)				
Trefferlage	0.19 mm links, 0.26 mm tief				
Streuwert	0.83, horizontal: 0.85, vertikal: 0.81				

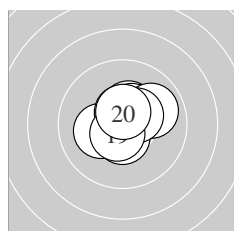

Serie 2:	10.7 *	10.4 *	10.2 *	10.4 *	9.9 ↗
	10.5 *	10.4 *	10.6 *	10.6 *	10.6 *
beste Teiler	62.2 (11.) 88.1 (19.) 95.1 (18.)				
Trefferlage	0.27 mm rechts, 0.42 mm hoch				
Streuwert	0.96, horizontal: 1.05, vertikal: 0.87				

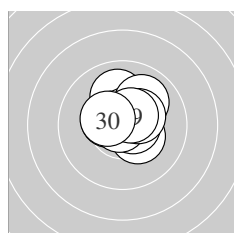

Serie 3:	10.0 ↑	10.5 *	10.6 *	10.3 *	10.6 *
	10.9 *	10.0 ↗	10.4 *	10.5 *	10.4 *
beste Teiler	25.1 (26.) 84.4 (25.) 86.6 (23.)				
Trefferlage	0.27 mm rechts, 0.65 mm hoch				
Streuwert	0.97, horizontal: 1.00, vertikal: 0.93				

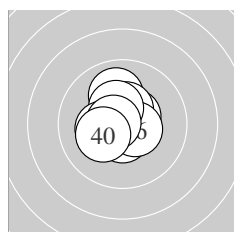

Serie 4:	10.6 *	10.7 *	10.0 ↑	10.5 *	10.5 *
	10.5 *	10.4 *	10.3 *	10.7 *	10.2 *
beste Teiler	68.7 (32.) 75.8 (39.) 92.0 (31.)				
Trefferlage	0.24 mm links, 0.35 mm hoch				
Streuwert	0.99, horizontal: 0.93, vertikal: 1.05				

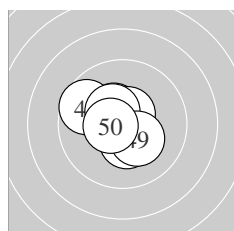

Serie 5:	10.8 *	10.4 *	10.6 *	10.4 *	10.6 *
	10.6 *	9.7 ↖	10.4 *	10.3 *	10.6 *
beste Teiler	28.0 (41.) 86.0 (43.) 90.3 (45.)				
Trefferlage	0.45 mm links, 0.24 mm hoch				
Streuwert	1.05, horizontal: 1.13, vertikal: 0.96				

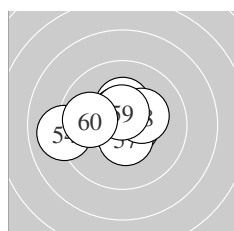

Serie 6:	10.5 *	10.3 *	10.6 *	9.0 ←	10.7 *
	10.6 *	10.5 *	10.3 *	10.5 *	9.9 ←
beste Teiler	74.7 (55.) 85.0 (56.) 92.3 (53.)				
Trefferlage	0.49 mm links, 0.31 mm hoch				
Streuwert	1.45, horizontal: 1.84, vertikal: 0.92				

ISSF AR Men – Wertung – Männer

StandNr: 142

Timothy, Sherry #70811318

StartNr: 88

21. Januar 2019 11:49

USA

QF – Schütze hat sich fürs Finale qualifiziert

Unterschrift des Schützen

Meyton Elektronik

Ergebnis:	623.7	(594)							
Serien:	103.1	104.4	104.0	103.3	104.5	104.4			
Zähler:	54	6	0	0	0	0	0	0	0
Innenzehner:	52								
weiteste:	435 (5),	308 (34),	297 (22)						
beste Teiler	8.0 (47.)	22.3 (37.)	33.9 (30.)						
Trefferlage	0.39 mm rechts, 0.04 mm hoch								
Streuwert	1.08, horizontal: 1.19, vertikal: 0.96								

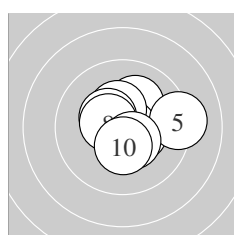
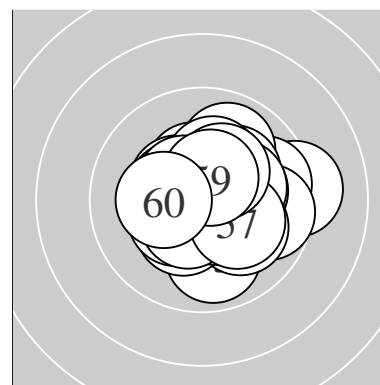

Serie 1:					
	10.4 *	10.1 ↗	10.8 *	10.5 *	9.2 →
	10.4 *	10.4 *	10.5 *	10.4 *	10.4 *
beste Teiler	38.1 (3.) 110.0 (4.) 116.3 (8.)				
Trefferlage	0.45 mm rechts, 0.28 mm hoch				
Streuwert	1.34, horizontal: 1.59, vertikal: 1.03				

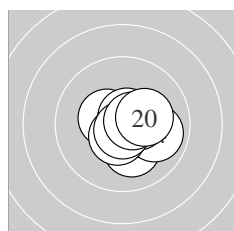

Serie 2:					
	10.6 *	10.2 *	10.4 *	9.9 →	10.5 *
	10.5 *	10.7 *	10.8 *	10.6 *	10.2 *
beste Teiler	46.0 (18.) 64.4 (17.) 80.9 (19.)				
Trefferlage	0.63 mm rechts, 0.24 mm tief				
Streuwert	0.93, horizontal: 1.05, vertikal: 0.80				

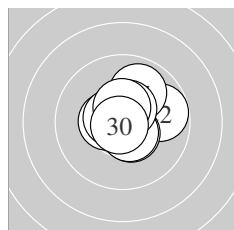

Serie 3:					
	10.3 *	9.8 →	10.5 *	10.6 *	10.5 *
	10.6 *	9.9 ↗	10.5 *	10.5 *	10.8 *
beste Teiler	33.9 (30.) 90.0 (26.) 98.1 (24.)				
Trefferlage	0.46 mm rechts, 0.45 mm hoch				
Streuwert	1.08, horizontal: 1.18, vertikal: 0.97				

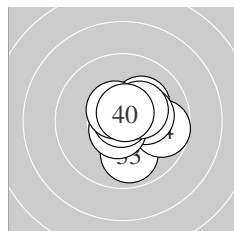

Serie 4:					
	10.3 *	10.2 *	9.9 ↓	9.7 →	10.2 *
	10.6 *	10.9 *	10.3 *	10.5 *	10.7 *
beste Teiler	22.3 (37.) 68.0 (40.) 78.3 (36.)				
Trefferlage	0.85 mm rechts, 0.03 mm tief				
Streuwert	1.13, horizontal: 1.13, vertikal: 1.14				

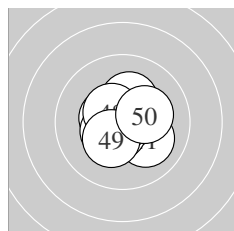

Serie 5:					
	10.1 ↘	10.7 *	10.6 *	10.5 *	10.3 *
	10.4 *	10.9 *	10.5 *	10.3 *	10.2 *
beste Teiler	8.0 (47.) 68.7 (42.) 80.5 (43.)				
Trefferlage	0.09 mm links, 0.02 mm tief				
Streuwert	1.03, horizontal: 1.09, vertikal: 0.95				

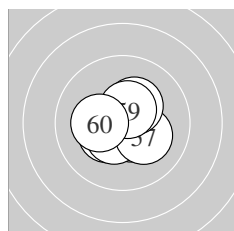

Serie 6:					
	10.6 *	10.6 *	10.5 *	10.4 *	10.6 *
	10.5 *	10.2 *	10.3 *	10.5 *	10.2 *
beste Teiler	77.0 (55.) 80.0 (51.) 81.8 (52.)				
Trefferlage	0.05 mm rechts, 0.17 mm tief				
Streuwert	0.97, horizontal: 1.04, vertikal: 0.89				

ISSF AR Men – Wertung – Männer

StandNr: 143

Blamauer, Nikolaus #334

StartNr: 89

21. Januar 2019 11:32

AUT

Unterschrift des Schützen

Meyton Elektronik

Ergebnis: **626.5** (600)^{QF}
 Serien: 106.0 104.8 103.8 104.9 103.6 103.4
 Zähler: 60 0 0 0 0 0 0 0 0
 Innenzehner: 52
 weiteste: 236 (30), 236 (51), 234 (27)
 beste Teiler 10.8 (4.) 34.3 (39.) 43.0 (11.)
 Trefferlage 0.01 mm rechts, 0.12 mm hoch
 Streuwert 0.99, horizontal: 1.09, vertikal: 0.89

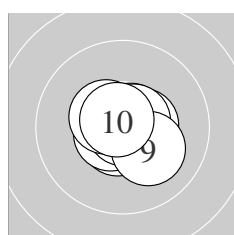
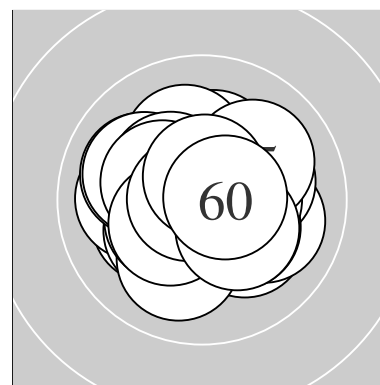

Serie 1:
 10.7 * 10.6 * 10.6 * 10.9 * 10.5 *
 10.7 * 10.7 * 10.5 * 10.1 ↘ 10.7 *
 beste Teiler 10.8 (4.) 57.0 (10.) 58.0 (1.)
 Trefferlage 0.21 mm rechts, 0.05 mm tief
 Streuwert 0.71, horizontal: 0.82, vertikal: 0.60

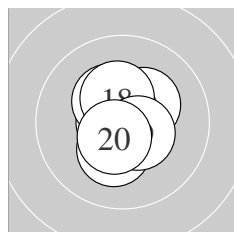

Serie 2:
 10.8 * 10.5 * 10.3 * 10.3 * 10.7 *
 10.4 * 10.4 * 10.4 * 10.5 * 10.5 *
 beste Teiler 43.0 (11.) 57.0 (15.) 101.0 (12.)
 Trefferlage 0.15 mm links, 0.09 mm hoch
 Streuwert 0.93, horizontal: 0.69, vertikal: 1.13

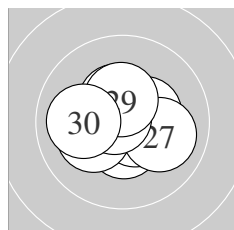

Serie 3:
 10.6 * 10.4 * 10.5 * 10.4 * 10.6 *
 10.2 * 10.0 ↘ 10.7 * 10.4 * 10.0 ←
 beste Teiler 56.9 (28.) 88.8 (25.) 95.1 (21.)
 Trefferlage 0.07 mm links, 0.12 mm hoch
 Streuwert 1.15, horizontal: 1.34, vertikal: 0.90

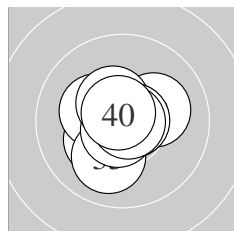

Serie 4:
 10.3 * 10.2 * 10.3 * 10.7 * 10.0 ↘
 10.7 * 10.5 * 10.7 * 10.8 * 10.7 *
 beste Teiler 34.3 (39.) 56.3 (40.) 57.1 (34.)
 Trefferlage 0.15 mm links, 0.09 mm tief
 Streuwert 0.99, horizontal: 1.03, vertikal: 0.96

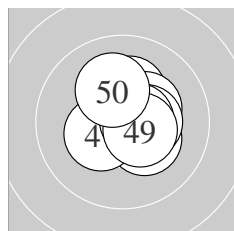

Serie 5:
 10.2 * 10.4 * 10.4 * 10.3 * 10.3 *
 10.4 * 10.4 * 10.6 * 10.5 * 10.1 ↑
 beste Teiler 85.7 (48.) 115.9 (49.) 127.2 (42.)
 Trefferlage 0.69 mm rechts, 0.26 mm hoch
 Streuwert 0.95, horizontal: 0.94, vertikal: 0.97

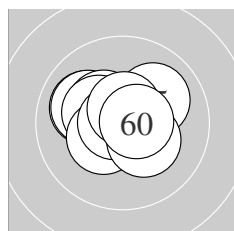

Serie 6:
 10.0 ↖ 10.0 ↖ 10.4 * 10.3 * 10.0 ↗
 10.4 * 10.8 * 10.6 * 10.3 * 10.6 *
 beste Teiler 48.0 (57.) 84.4 (60.) 85.5 (58.)
 Trefferlage 0.44 mm links, 0.39 mm hoch
 Streuwert 1.15, horizontal: 1.41, vertikal: 0.81

Meyton Elektronik

ISSF AR Men – Wertung – Männer

StandNr: 144

Sampson, Dane #224

StartNr: 90

21. Januar 2019 11:49

AUS

QF – Schütze hat sich fürs Finale qualifiziert

Unterschrift des Schützen

Meyton Elektronik

Ergebnis: **624.4** (593)
 Serien: 103.9 102.8 106.1 103.6 103.7 104.3
 Zähler: 53 7 0 0 0 0 0 0 0 0
 Innenzehner: 50
 weiteste: 368 (50), 340 (31), 308 (13)
 beste Teiler 21.0 (43.) 31.4 (26.) 34.1 (5.)
 Trefferlage 0.31 mm rechts, 0.07 mm hoch
 Streuwert 1.11, horizontal: 1.26, vertikal: 0.94

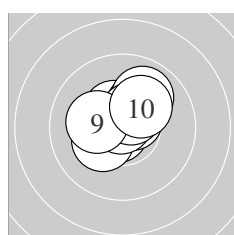
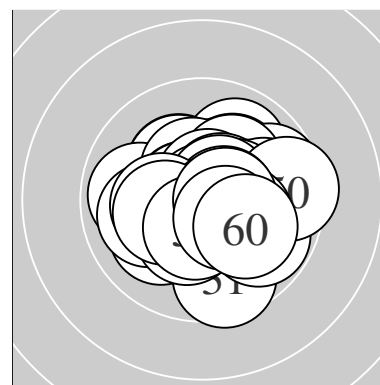

Serie 1:
 10.4 * 10.8 * 10.6 * 10.3 * 10.8 *
 10.2 * 9.9 ↗ 10.5 * 10.2 * 10.2 *
 beste Teiler 34.1 (5.) 49.2 (2.) 86.4 (3.)
 Trefferlage 0.06 mm rechts, 0.72 mm hoch
 Streuwert 1.03, horizontal: 1.13, vertikal: 0.91

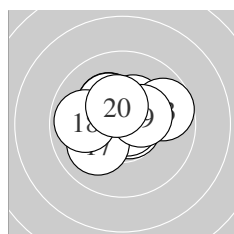

Serie 2:
 10.2 * 10.4 * 9.7 → 10.7 * 10.8 *
 10.3 * 10.0 ↙ 9.9 ← 10.4 * 10.4 *
 beste Teiler 35.2 (15.) 54.5 (14.) 136.3 (20.)
 Trefferlage 0.10 mm links, 0.56 mm hoch
 Streuwert 1.32, horizontal: 1.62, vertikal: 0.93

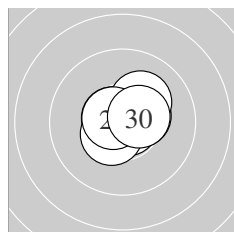

Serie 3:
 10.8 * 10.8 * 10.8 * 10.4 * 10.6 *
 10.8 * 10.2 * 10.5 * 10.7 * 10.5 *
 beste Teiler 31.4 (26.) 38.1 (21.) 38.9 (22.)
 Trefferlage 0.19 mm rechts, 0.29 mm hoch
 Streuwert 0.70, horizontal: 0.81, vertikal: 0.57

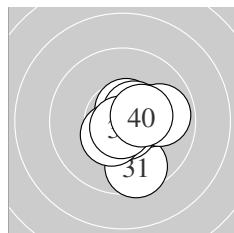

Serie 4:
 9.6 ↓ 10.6 * 10.5 * 10.2 * 10.5 *
 10.7 * 10.4 * 9.9 → 10.8 * 10.4 *
 beste Teiler 46.5 (39.) 58.6 (36.) 84.7 (32.)
 Trefferlage 0.81 mm rechts, 0.22 mm tief
 Streuwert 1.11, horizontal: 0.99, vertikal: 1.21

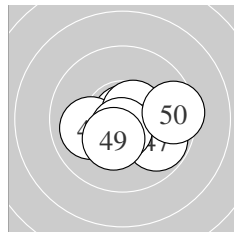

Serie 5:
 10.6 * 10.6 * 10.9 * 10.0 ← 10.7 *
 10.6 * 9.8 ↘ 10.7 * 10.3 * 9.5 →
 beste Teiler 21.0 (43.) 60.0 (45.) 71.5 (48.)
 Trefferlage 0.59 mm rechts, 0.35 mm tief
 Streuwert 1.26, horizontal: 1.63, vertikal: 0.73

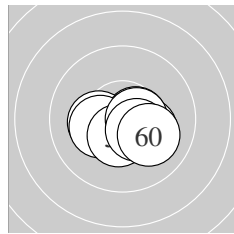

Serie 6:
 10.6 * 10.6 * 10.3 * 10.7 * 10.3 *
 10.2 * 10.5 * 10.6 * 10.4 * 10.1 ↘
 beste Teiler 73.4 (54.) 82.0 (51.) 94.2 (52.)
 Trefferlage 0.35 mm rechts, 0.55 mm tief
 Streuwert 0.94, horizontal: 1.25, vertikal: 0.45

Meyton Elektronik

ISSF AR Men – Wertung – Männer

StandNr: 145

Schmir, Alexander #232

StartNr: 91

21. Januar 2019 11:55

AUT

Unterschrift des Schützen

Meyton Elektronik

Ergebnis: **621.8** (594)
 Serien: 104.8 104.1 103.5 103.4 102.7 103.3
 Zähler: 54 6 0 0 0 0 0 0 0
 Innenzehner: 44
 weiteste: 315 (12), 315 (44), 311 (46)
 beste Teiler 3.0 (4.) 9.0 (34.) 31.0 (48.)
 Trefferlage 0.13 mm rechts, 0.01 mm hoch
 Streuwert 1.18, horizontal: 1.24, vertikal: 1.11

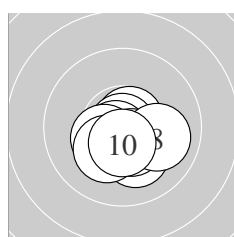
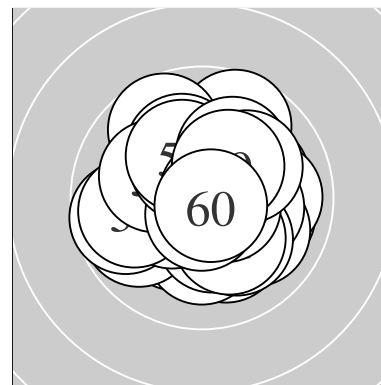

Serie 1:
 10.7 * 10.7 * 10.2 * 10.9 * 10.7 *
 10.5 * 10.4 * 10.0 → 10.2 * 10.5 *
 beste Teiler 3.0 (4.) 65.0 (2.) 66.4 (5.)
 Trefferlage 0.20 mm rechts, 0.70 mm tief
 Streuwert 0.86, horizontal: 1.01, vertikal: 0.66

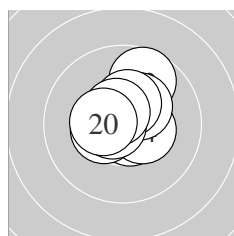

Serie 2:
 10.7 * 9.7 ↗ 10.5 * 10.4 * 10.3 *
 10.4 * 10.4 * 10.7 * 10.6 * 10.4 *
 beste Teiler 67.3 (18.) 73.5 (11.) 90.3 (19.)
 Trefferlage 0.10 mm rechts, 0.60 mm hoch
 Streuwert 1.02, horizontal: 0.98, vertikal: 1.07

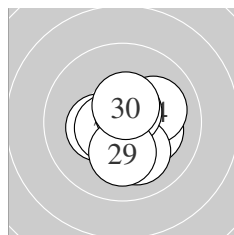

Serie 3:
 10.4 * 10.2 * 10.3 * 10.1 → 10.7 *
 10.5 * 10.1 ↘ 10.6 * 10.1 ↓ 10.5 *
 beste Teiler 65.1 (25.) 77.8 (28.) 103.6 (26.)
 Trefferlage 0.43 mm rechts, 0.32 mm tief
 Streuwert 1.10, horizontal: 1.15, vertikal: 1.05

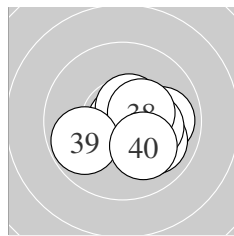

Serie 4:
 10.8 * 9.9 → 10.7 * 10.9 * 10.0 ↘
 10.2 * 10.6 * 10.4 * 9.8 ← 10.1 ↘
 beste Teiler 9.0 (34.) 49.0 (31.) 70.8 (33.)
 Trefferlage 0.77 mm rechts, 0.34 mm tief
 Streuwert 1.18, horizontal: 1.44, vertikal: 0.85

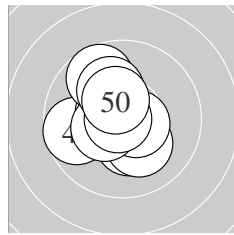

Serie 5:
 10.3 * 10.2 * 10.6 * 9.7 ← 10.5 *
 9.7 ↘ 10.4 * 10.8 * 10.1 ↗ 10.4 *
 beste Teiler 31.0 (48.) 95.5 (43.) 103.0 (45.)
 Trefferlage 0.58 mm links, 0.15 mm hoch
 Streuwert 1.34, horizontal: 1.23, vertikal: 1.44

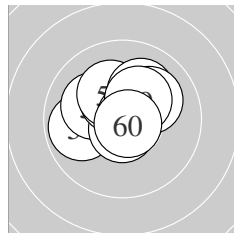

Serie 6:
 9.9 ← 10.1 ↖ 10.7 * 10.4 * 10.2 *
 10.7 * 10.1 ↗ 10.1 ↗ 10.3 * 10.8 *
 beste Teiler 46.7 (60.) 57.2 (56.) 66.0 (53.)
 Trefferlage 0.11 mm links, 0.68 mm hoch
 Streuwert 1.19, horizontal: 1.41, vertikal: 0.93

Meyton Elektronik

ISSF AR Men – Wertung – Männer

StandNr: 146

Driagin, Aleksandr #70811319

StartNr: 92

21. Januar 2019 11:49

RUS

Unterschrift des Schützen

Meyton Elektronik

Ergebnis: **611.2** (583)
 Serien: 103.1 101.2 104.0 102.5 99.7 100.7
 Zähler: 43 17 0 0 0 0 0 0 0 0
 Innenzehner: 38
 weiteste: 427 (49), 401 (57), 396 (40)
 beste Teiler 38.6 (50.) 43.8 (43.) 58.1 (23.)
 Trefferlage 0.28 mm links, 0.03 mm tief
 Streuwert 1.55, horizontal: 1.91, vertikal: 1.07

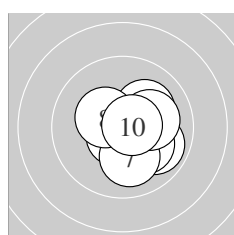
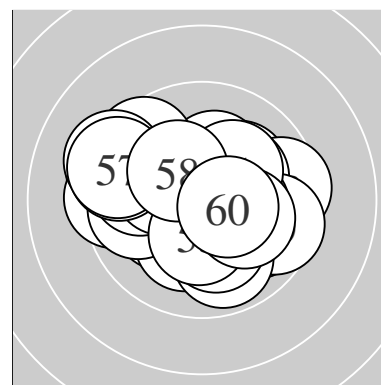

Serie 1:
 10.7 * 10.1 ↗ 10.4 * 10.6 * 9.9 ↘
 10.1 ↘ 10.1 ↓ 10.4 * 10.1 → 10.7 *
 beste Teiler 61.8 (1.) 71.5 (10.) 78.8 (4.)
 Trefferlage 0.80 mm rechts, 0.34 mm tief
 Streuwert 1.12, horizontal: 1.13, vertikal: 1.12

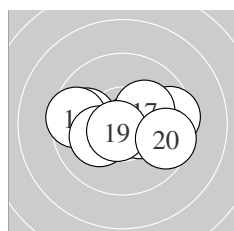

Serie 2:
 10.7 * 9.9 ← 9.5 → 10.4 * 10.4 *
 9.6 ← 10.2 * 10.2 * 10.7 * 9.6 →
 beste Teiler 58.9 (11.) 66.0 (19.) 128.1 (14.)
 Trefferlage 0.31 mm rechts, 0.04 mm tief
 Streuwert 1.73, horizontal: 2.36, vertikal: 0.67

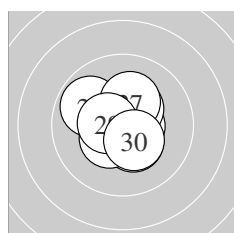

Serie 3:
 10.5 * 10.6 * 10.7 * 10.4 * 10.4 *
 9.9 ↖ 10.2 * 10.4 * 10.5 * 10.4 *
 beste Teiler 58.1 (23.) 90.3 (22.) 111.8 (29.)
 Trefferlage 0.18 mm links, 0.01 mm tief
 Streuwert 1.11, horizontal: 1.13, vertikal: 1.09

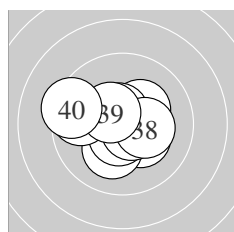

Serie 4:
 10.3 * 10.3 * 10.2 * 10.6 * 10.6 *
 9.7 ← 10.6 * 10.3 * 10.5 * 9.4 ←
 beste Teiler 78.4 (37.) 85.4 (35.) 89.8 (34.)
 Trefferlage 0.41 mm links, 0.01 mm hoch
 Streuwert 1.49, horizontal: 1.83, vertikal: 1.03

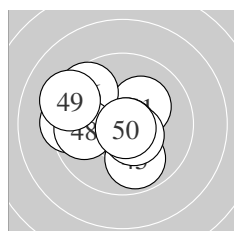

Serie 5:
 10.2 * 9.5 ← 10.8 * 9.4 ← 9.9 ↓
 9.6 ↖ 10.5 * 9.8 ← 9.2 ↖ 10.8 *
 beste Teiler 38.6 (50.) 43.8 (43.) 117.3 (47.)
 Trefferlage 1.31 mm links, 0.12 mm hoch
 Streuwert 1.85, horizontal: 2.22, vertikal: 1.40

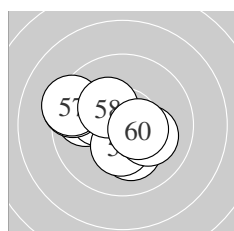

Serie 6:
 10.6 * 9.8 ← 10.2 * 10.2 * 10.3 *
 9.4 ↖ 9.3 ↖ 10.3 * 10.1 → 10.5 *
 beste Teiler 79.2 (51.) 119.1 (60.) 154.5 (55.)
 Trefferlage 0.89 mm links, 0.03 mm hoch
 Streuwert 1.67, horizontal: 2.03, vertikal: 1.22

Meyton Elektronik

ISSF AR Men – Wertung – Männer

StandNr: 147

Manpat, Rakesh #70811320

StartNr: 93

21. Januar 2019 11:52

IND

Unterschrift des Schützen

Meyton Elektronik

Ergebnis:	622.2	(597)					
Serien:	103.4	104.3	104.9	103.8	103.4	102.4	
Zähler:	57	3	0	0	0	0	0
Innenzehner:	48						
weiteste:	322 (54), 273 (49), 260 (19)						
beste Teiler	44.0 (31.) 47.6 (24.) 49.0 (29.)						
Trefferlage	0.19 mm rechts, 0.39 mm hoch						
Streuwert	1.09, horizontal: 1.06, vertikal: 1.11						

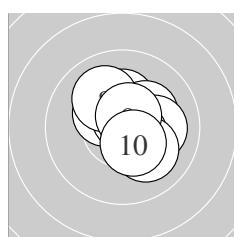
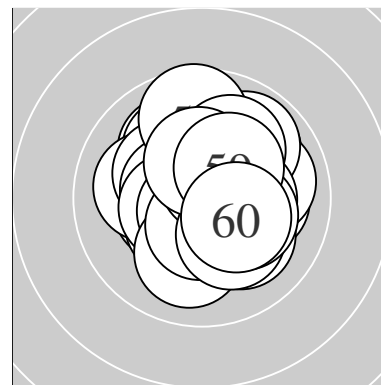

Serie 1:					
	10.3 *	10.2 *	10.1 →	10.4 *	10.7 *
	10.6 *	10.1 ↘	10.0 ↖	10.6 *	10.4 *
beste Teiler	65.7 (5.) 86.7 (9.) 94.3 (6.)				
Trefferlage	0.49 mm rechts, 0.37 mm hoch				
Streuwert	1.12, horizontal: 1.11, vertikal: 1.13				

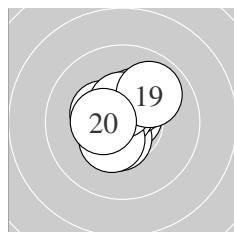

Serie 2:					
	10.4 *	10.7 *	10.5 *	10.3 *	10.5 *
	10.7 *	10.4 *	10.5 *	9.9 ↗	10.4 *
beste Teiler	58.8 (12.) 60.4 (16.) 110.1 (13.)				
Trefferlage	0.20 mm links, 0.38 mm hoch				
Streuwert	1.00, horizontal: 1.01, vertikal: 0.98				

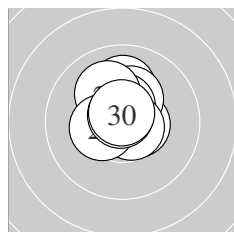

Serie 3:					
	10.0 ↑	10.6 *	10.3 *	10.8 *	10.5 *
	10.7 *	10.1 ↖	10.4 *	10.8 *	10.7 *
beste Teiler	47.6 (24.) 49.0 (29.) 63.3 (30.)				
Trefferlage	0.08 mm links, 0.74 mm hoch				
Streuwert	0.84, horizontal: 0.72, vertikal: 0.94				

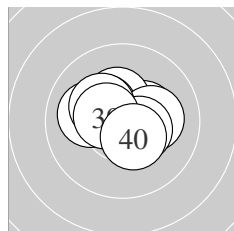

Serie 4:					
	10.8 *	10.4 *	10.4 *	10.3 *	10.1 ←
	10.2 *	10.4 *	10.3 *	10.5 *	10.4 *
beste Teiler	44.0 (31.) 115.1 (39.) 127.0 (37.)				
Trefferlage	0.11 mm links, 0.36 mm hoch				
Streuwert	1.10, horizontal: 1.38, vertikal: 0.73				

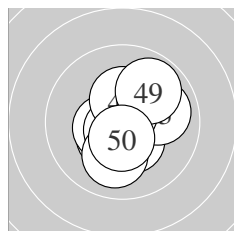

Serie 5:					
	10.4 *	10.4 *	10.0 →	10.5 *	10.7 *
	10.7 *	10.0 ↓	10.3 *	9.9 ↗	10.5 *
beste Teiler	63.7 (45.) 67.0 (46.) 110.2 (50.)				
Trefferlage	0.18 mm rechts, 0.15 mm tief				
Streuwert	1.25, horizontal: 1.13, vertikal: 1.35				

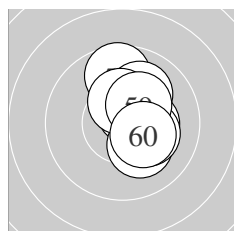

Serie 6:					
	10.6 *	10.4 *	10.3 *	9.7 ↑	10.2 *
	10.0 ↗	10.2 *	10.4 *	10.3 *	10.3 *
beste Teiler	93.4 (51.) 136.0 (52.) 146.5 (58.)				
Trefferlage	0.87 mm rechts, 0.67 mm hoch				
Streuwert	1.13, horizontal: 0.70, vertikal: 1.44				

Meyton Elektronik

ISSF AR Men – Wertung – Männer

StandNr: 148

Eberlberger, Florian #308

StartNr: 94

21. Januar 2019 11:42

OÖ – Bad Goisern

Unterschrift des Schützen

Meyton Elektronik

Ergebnis: **603.3** (576)

Serien: 99.6 99.4 99.6 100.1 101.7 102.9

Zähler: 37 22 1 0 0 0 0 0 0 0

Innenzehner: 26

weiteste: 525 (30), 466 (31), 430 (17)

beste Teiler 14.8 (51.) 56.3 (44.) 57.3 (60.)

Trefferlage 0.01 mm rechts, 0.00 mm

Streuwert 1.81, horizontal: 2.04, vertikal: 1.54

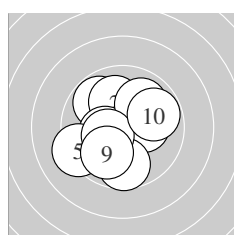
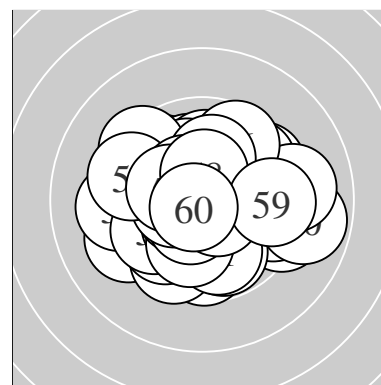

Serie 1:

9.8 ↘	10.1 ↑	10.3 *	10.3 *	9.3 ↙
10.0 ↗	9.7 ↓	10.4 *	9.9 ↘	9.8 ↗

beste Teiler 145.4 (8.) 156.2 (3.) 175.2 (4.)

Trefferlage 0.44 mm links, 0.11 mm tief

Streuwert 1.94, horizontal: 1.96, vertikal: 1.91

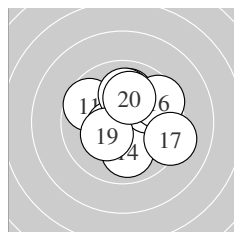

Serie 2:

9.7 ↘	10.0 ↑	10.6 *	10.0 ↓	9.9 ↗
9.6 ↗	9.2 ↘	10.0 ↑	10.3 *	10.1 ↑

beste Teiler 94.8 (13.) 169.6 (19.) 214.7 (20.)

Trefferlage 0.58 mm rechts, 0.59 mm hoch

Streuwert 1.91, horizontal: 2.06, vertikal: 1.76

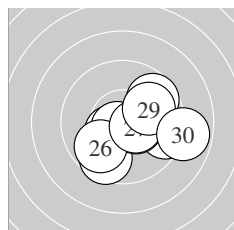

Serie 3:

9.5 →	10.4 *	9.6 ↘	10.7 *	10.5 *
9.8 ↘	10.5 *	9.7 ↗	10.0 ↗	8.9 →

beste Teiler 67.9 (24.) 117.3 (27.) 123.4 (25.)

Trefferlage 1.10 mm rechts, 0.61 mm tief

Streuwert 1.92, horizontal: 2.32, vertikal: 1.40

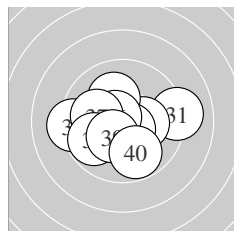

Serie 4:

9.1 →	10.3 *	10.1 ↘	9.3 ↙	10.6 *
10.7 *	10.1 ↙	9.8 ↙	10.3 *	9.8 ↓

beste Teiler 72.5 (36.) 88.2 (35.) 154.4 (39.)

Trefferlage 0.30 mm links, 0.33 mm tief

Streuwert 1.97, horizontal: 2.47, vertikal: 1.29

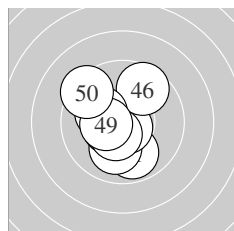

Serie 5:

9.9 ↓	10.0 ↓	10.5 *	10.7 *	10.5 *
9.6 ↗	10.5 *	10.2 *	10.4 *	9.4 ↙

beste Teiler 56.3 (44.) 112.2 (43.) 119.0 (47.)

Trefferlage 0.67 mm links, 0.13 mm tief

Streuwert 1.58, horizontal: 1.36, vertikal: 1.77

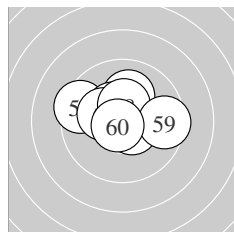

Serie 6:

10.9 *	9.4 ↙	10.7 *	10.1 ↑	10.4 *
10.5 *	10.3 *	10.4 *	9.5 →	10.7 *

beste Teiler 14.8 (51.) 57.3 (60.) 66.8 (53.)

Trefferlage 0.16 mm links, 0.56 mm hoch

Streuwert 1.43, horizontal: 1.82, vertikal: 0.87

Meyton Elektronik

ISSF AR Men – Wertung – Männer

StandNr: 148

Insam, Fabian #158

StartNr: 142

21. Januar 2019 13:50

T – SG Fügenberg

Unterschrift des Schützen

Meyton Elektronik