

Ergebnis:	615.0	(589)
Serien:	104.1	103.2 103.0 100.6 101.9 102.2
Zähler:	49	11 0 0 0 0 0 0 0 0
Innenzehner:	41	
weiteste:	406 (32), 391 (50), 345 (43)	
beste Teiler	5.0 (40.)	30.4 (3.) 41.0 (49.)
Trefferlage	0.02 mm links, 0.02 mm tief	
Streuwert	1.40, horizontal: 1.59, vertikal: 1.19	

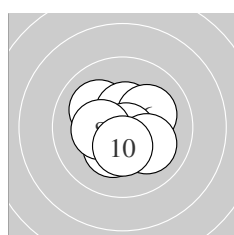

Serie 1:	10.7 *	10.1 ↖	10.8 *	10.5 *	10.3 *
	10.1 ↗	10.8 *	10.3 *	10.1 ↘	10.4 *
beste Teiler	30.4 (3.) 50.2 (7.) 51.7 (1.)				
Trefferlage	0.04 mm links, 0.09 mm tief				
Streuwert	1.13, horizontal: 1.20, vertikal: 1.06				

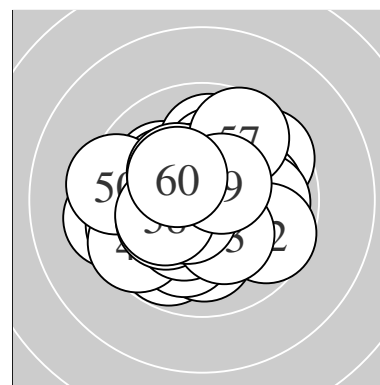
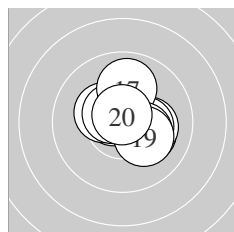

Serie 2:	10.6 *	10.2 *	10.3 *	10.2 *	10.5 *
	10.3 *	9.9 ↑	10.3 *	10.2 *	10.7 *
beste Teiler	55.2 (20.) 83.2 (11.) 101.5 (15.)				
Trefferlage	0.57 mm rechts, 0.16 mm hoch				
Streuwert	1.15, horizontal: 1.24, vertikal: 1.06				

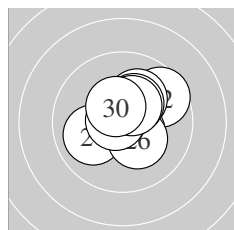

Serie 3:	10.7 *	9.6 ↗	10.1 ↗	10.0 ↖	10.5 *
	10.3 *	10.7 *	10.3 *	10.4 *	10.4 *
beste Teiler	54.5 (27.) 65.4 (21.) 115.8 (25.)				
Trefferlage	0.47 mm rechts, 0.49 mm hoch				
Streuwert	1.24, horizontal: 1.32, vertikal: 1.15				

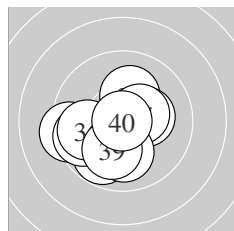

Serie 4:	9.8 ↙	9.3 ←	10.2 *	9.7 ↖	10.3 *
	9.9 ←	10.4 *	10.0 ↓	10.1 ↙	10.9 *
beste Teiler	5.0 (40.) 137.2 (37.) 171.0 (35.)				
Trefferlage	0.83 mm links, 0.67 mm tief				
Streuwert	1.67, horizontal: 1.89, vertikal: 1.41				

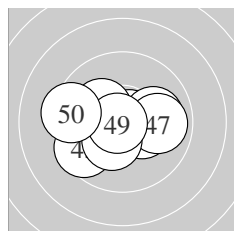

Serie 5:	10.7 *	10.3 *	9.6 ↖	10.2 *	10.0 →
	10.7 *	9.9 →	10.3 *	10.8 *	9.4 ←
beste Teiler	41.0 (49.) 53.7 (41.) 69.1 (46.)				
Trefferlage	0.32 mm links, 0.20 mm tief				
Streuwert	1.62, horizontal: 2.11, vertikal: 0.89				

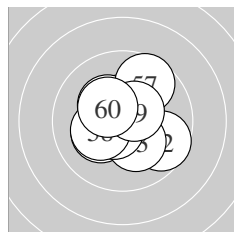

Serie 6:	10.2 *	9.7 ↘	10.2 *	10.6 *	10.5 *
	10.3 *	9.7 ↗	10.2 *	10.5 *	10.3 *
beste Teiler	89.1 (54.) 113.5 (59.) 123.3 (55.)				
Trefferlage	0.01 mm links, 0.17 mm hoch				
Streuwert	1.48, horizontal: 1.54, vertikal: 1.42				

Meyton Elektronik

ISSF AR Men – Wertung – **Männer**

StandNr: 121

Dufaux, Gilles #334

StartNr: 21

23. Januar 2018 9:31

SUI

Unterschrift des Schützen

Meyton Elektronik

Ergebnis: **621.7** (592)
 Serien: 102.7 105.2 104.6 102.5 102.9 103.8
 Zähler: 52 8 0 0 0 0 0 0 0
 Innenzehner: 45
 weiteste: 432 (48), 356 (3), 353 (37)
 beste Teiler 13.0 (30.) 33.1 (17.) 34.9 (33.)
 Trefferlage 0.40 mm rechts, 0.18 mm hoch
 Streuwert 1.20, horizontal: 1.36, vertikal: 1.01

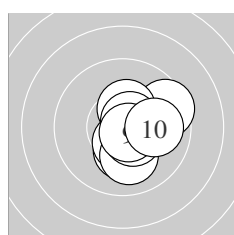
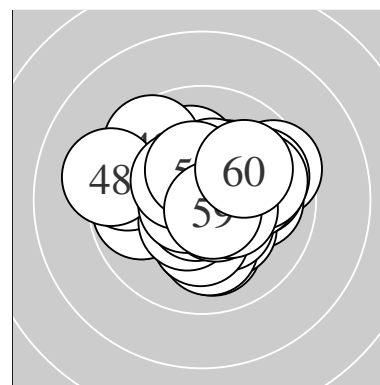

Serie 1:
 10.1 → 10.2 * 9.5 → 10.4 * 10.5 *
 10.1 ↓ 10.7 * 10.5 * 10.7 * 10.0 →
 beste Teiler 60.8 (9.) 73.7 (7.) 109.6 (8.)
 Trefferlage 1.03 mm rechts, 0.23 mm tief
 Streuwert 1.20, horizontal: 1.15, vertikal: 1.25

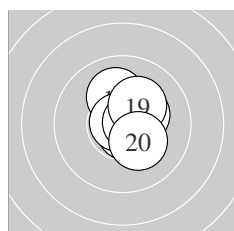

Serie 2:
 10.7 * 10.8 * 10.6 * 10.7 * 10.3 *
 10.1 ↑ 10.8 * 10.7 * 10.2 * 10.3 *
 beste Teiler 33.1 (17.) 48.3 (12.) 59.0 (11.)
 Trefferlage 0.52 mm rechts, 0.40 mm hoch
 Streuwert 0.79, horizontal: 0.63, vertikal: 0.93

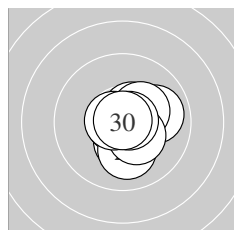

Serie 3:
 10.5 * 9.9 → 10.4 * 10.3 * 10.7 *
 10.1 ↓ 10.4 * 10.7 * 10.7 * 10.9 *
 beste Teiler 13.0 (30.) 51.1 (28.) 54.3 (25.)
 Trefferlage 0.52 mm rechts, 0.20 mm tief
 Streuwert 0.98, horizontal: 0.94, vertikal: 1.01

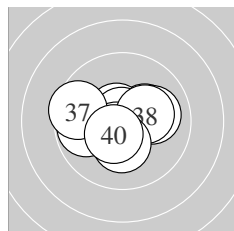

Serie 4:
 10.2 * 10.6 * 10.8 * 10.6 * 10.0 →
 9.8 ← 9.5 ← 10.2 * 10.3 * 10.5 *
 beste Teiler 34.9 (33.) 81.0 (32.) 92.4 (34.)
 Trefferlage 0.23 mm links, 0.05 mm tief
 Streuwert 1.45, horizontal: 1.85, vertikal: 0.88

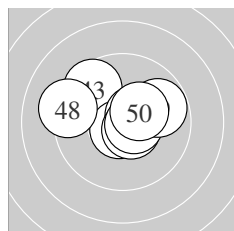

Serie 5:
 10.8 * 10.8 * 9.6 ↘ 10.7 * 10.5 *
 10.6 * 10.6 * 9.2 ← 9.8 → 10.3 *
 beste Teiler 39.5 (42.) 46.6 (41.) 62.1 (44.)
 Trefferlage 0.03 mm rechts, 0.51 mm hoch
 Streuwert 1.53, horizontal: 1.94, vertikal: 0.94

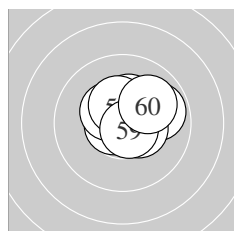

Serie 6:
 10.7 * 10.4 * 10.4 * 9.9 → 10.6 *
 10.3 * 10.4 * 10.4 * 10.7 * 10.0 →
 beste Teiler 67.9 (59.) 71.5 (51.) 99.2 (55.)
 Trefferlage 0.56 mm rechts, 0.71 mm hoch
 Streuwert 0.98, horizontal: 1.14, vertikal: 0.79

Meyton Elektronik

ISSF AR Men – Wertung – **Männer**

StandNr: 123

Mathis, Thomas #335

StartNr: 23

23. Januar 2018 9:35

AUT

Unterschrift des Schützen

Meyton Elektronik

Ergebnis:	629.9	(598) ^{QF}							
Serien:	105.1	104.2	105.8	104.0	106.1	104.7			
Zähler:	58	2	0	0	0	0	0	0	0
Innenzehner:	53								
weiteste:	299 (11), 269 (29), 243 (35)								
beste Teiler	17.4 (28.) 31.0 (45.) 34.1 (6.)								
Trefferlage	0.05 mm rechts, 0.10 mm hoch								
Streuwert	0.92, horizontal: 0.89, vertikal: 0.95								

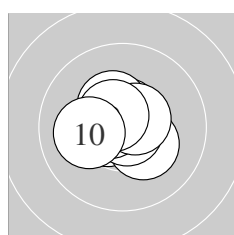
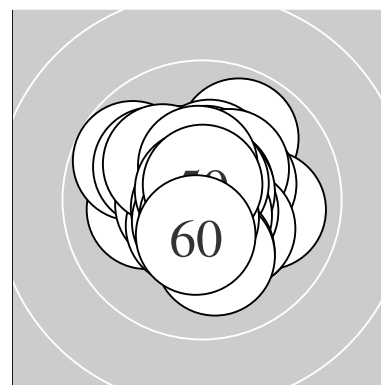

Serie 1:	10.5 *	10.6 *	10.6 *	10.3 *	10.4 *
	10.8 *	10.6 *	10.6 *	10.6 *	10.1 ←
beste Teiler	34.1 (6.) 84.7 (3.) 85.7 (7.)				
Trefferlage	0.29 mm links, 0.28 mm hoch				
Streuwert	0.86, horizontal: 0.97, vertikal: 0.73				

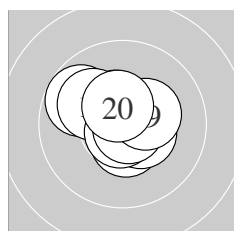

Serie 2:	9.8 ↘	10.6 *	10.5 *	10.5 *	10.4 *
	10.1 ↘	10.7 *	10.8 *	10.3 *	10.5 *
beste Teiler	42.7 (18.) 52.2 (17.) 77.6 (12.)				
Trefferlage	0.25 mm links, 0.39 mm hoch				
Streuwert	1.08, horizontal: 1.23, vertikal: 0.90				

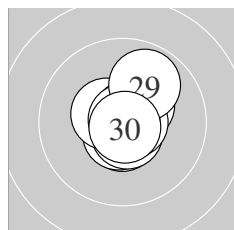

Serie 3:	10.6 *	10.6 *	10.4 *	10.7 *	10.5 *
	10.7 *	10.7 *	10.9 *	9.9 ↗	10.8 *
beste Teiler	17.4 (28.) 34.9 (30.) 59.3 (26.)				
Trefferlage	0.26 mm rechts, 0.18 mm hoch				
Streuwert	0.83, horizontal: 0.66, vertikal: 0.97				

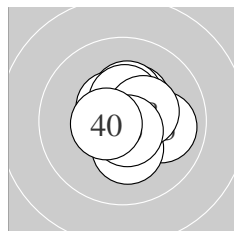

Serie 4:	10.4 *	10.5 *	10.3 *	10.5 *	10.0 →
	10.4 *	10.3 *	10.4 *	10.7 *	10.5 *
beste Teiler	67.9 (39.) 103.5 (40.) 110.6 (34.)				
Trefferlage	0.49 mm rechts, 0.25 mm hoch				
Streuwert	1.01, horizontal: 0.99, vertikal: 1.03				

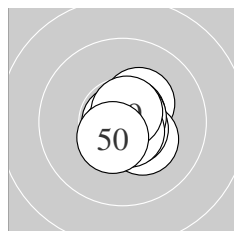

Serie 5:	10.3 *	10.7 *	10.3 *	10.7 *	10.8 *
	10.7 *	10.7 *	10.7 *	10.7 *	10.5 *
beste Teiler	31.0 (45.) 57.9 (46.) 65.1 (42.)				
Trefferlage	0.32 mm rechts, 0.11 mm tief				
Streuwert	0.68, horizontal: 0.60, vertikal: 0.75				

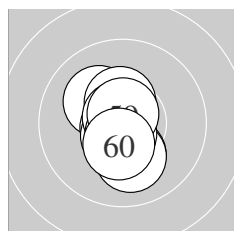

Serie 6:	10.2 *	10.1 ↓	10.7 *	10.1 ↓	10.6 *
	10.4 *	10.8 *	10.7 *	10.7 *	10.4 *
beste Teiler	46.4 (57.) 53.0 (53.) 58.0 (59.)				
Trefferlage	0.21 mm links, 0.35 mm tief				
Streuwert	0.96, horizontal: 0.55, vertikal: 1.24				

ISSF AR Men – Wertung – Männer

StandNr: 124

Kamenskii, Sergei #282

StartNr: 24

23. Januar 2018 9:28

RUS

QF – Schütze hat sich fürs Finale qualifiziert

Unterschrift des Schützen

Meyton Elektronik

Ergebnis: **620.3** (589)
 Serien: 105.1 102.3 101.7 104.9 103.9 102.4
 Zähler: 49 11 0 0 0 0 0 0 0
 Innenzehner: 44
 weiteste: 325 (29), 310 (21), 307 (55)
 beste Teiler 5.0 (17.) 10.2 (53.) 26.9 (33.)
 Trefferlage 0.20 mm links, 0.16 mm tief
 Streuwert 1.23, horizontal: 1.47, vertikal: 0.93

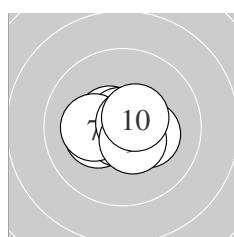
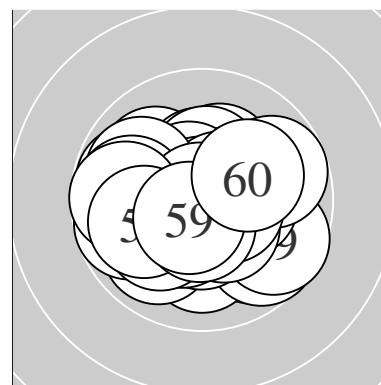

Serie 1:
 10.6 * 10.4 * 10.3 * 10.8 * 10.3 *
 10.8 * 10.2 * 10.7 * 10.5 * 10.5 *
 beste Teiler 43.3 (6.) 45.1 (4.) 51.9 (8.)
 Trefferlage 0.01 mm rechts, 0.07 mm tief
 Streuwert 0.91, horizontal: 1.19, vertikal: 0.51

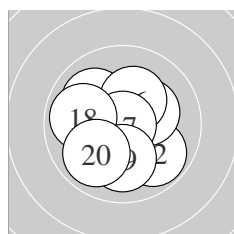

Serie 2:
 10.7 * 9.8 ↘ 10.5 * 10.3 * 10.0 ↘
 10.3 * 10.9 * 9.9 ← 10.0 ↓ 9.9 ↙
 beste Teiler 5.0 (17.) 54.2 (11.) 122.0 (13.)
 Trefferlage 0.23 mm links, 0.10 mm tief
 Streuwert 1.49, horizontal: 1.49, vertikal: 1.48

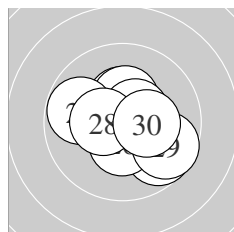

Serie 3:
 9.7 ↘ 10.2 * 10.4 * 10.3 * 10.5 *
 10.4 * 9.8 ← 10.4 * 9.7 ↘ 10.3 *
 beste Teiler 106.4 (25.) 129.0 (28.) 134.0 (26.)
 Trefferlage 0.52 mm rechts, 0.14 mm tief
 Streuwert 1.50, horizontal: 1.71, vertikal: 1.25

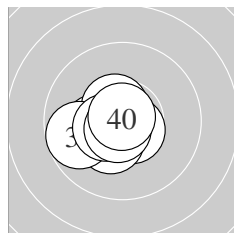

Serie 4:
 10.2 * 10.6 * 10.8 * 10.5 * 10.7 *
 10.4 * 9.7 ← 10.5 * 10.7 * 10.8 *
 beste Teiler 26.9 (33.) 29.6 (40.) 53.5 (35.)
 Trefferlage 0.75 mm links, 0.32 mm tief
 Streuwert 0.82, horizontal: 0.97, vertikal: 0.62

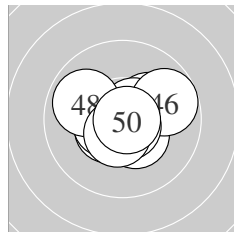

Serie 5:
 10.2 * 10.5 * 10.5 * 10.4 * 10.6 *
 9.8 → 10.7 * 9.9 ↖ 10.5 * 10.8 *
 beste Teiler 28.8 (50.) 57.6 (47.) 90.1 (45.)
 Trefferlage 0.19 mm rechts, 0.00 mm
 Streuwert 1.21, horizontal: 1.49, vertikal: 0.83

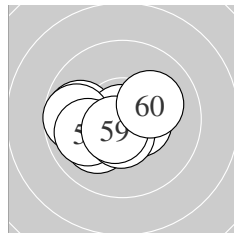

Serie 6:
 10.2 * 9.8 ← 10.9 * 10.1 ↙ 9.7 ←
 10.0 ← 10.5 * 10.5 * 10.6 * 10.1 →
 beste Teiler 10.2 (53.) 88.2 (59.) 104.4 (58.)
 Trefferlage 0.96 mm links, 0.32 mm tief
 Streuwert 1.27, horizontal: 1.65, vertikal: 0.71

Meyton Elektronik

ISSF AR Men – Wertung – **Männer**
StandNr: 125
Zott, Georg #281

StartNr: 25
23. Januar 2018 9:32
AUT

Unterschrift des Schützen

Meyton Elektronik

Ergebnis:	623.0	(596)							
Serien:	103.5	104.2	103.4	103.4	104.0	104.5			
Zähler:	56	4	0	0	0	0	0	0	0
Innenzehner:	49								
weiteste:	323 (4),	312 (30),	301 (38)						
beste Teiler	34.7 (60.)	39.2 (19.)	41.1 (11.)						
Trefferlage	0.23 mm rechts, 0.16 mm hoch								
Streuwert	1.11, horizontal: 1.14, vertikal: 1.07								

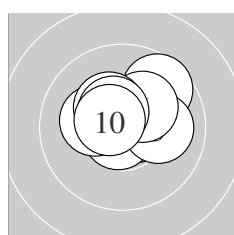
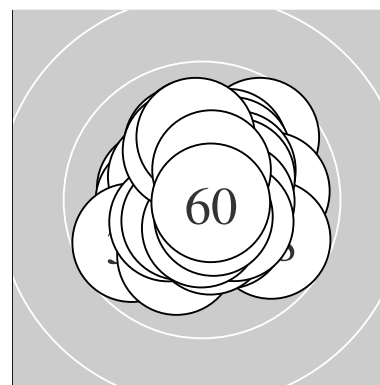

Serie 1:	10.5 *	10.6 *	10.7 *	9.7 ↗	10.1 →
	10.2 *	10.2 *	10.4 *	10.5 *	10.6 *
beste Teiler	52.1 (3.) 80.0 (2.) 93.5 (10.)				
Trefferlage	0.31 mm rechts, 0.66 mm hoch				
Streuwert	1.13, horizontal: 1.37, vertikal: 0.82				

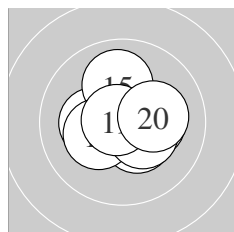

Serie 2:	10.8 *	10.4 *	10.8 *	10.2 *	10.0 ↑
	10.3 *	10.3 *	10.4 *	10.8 *	10.2 *
beste Teiler	39.2 (19.) 41.1 (11.) 43.5 (13.)				
Trefferlage	0.16 mm rechts, 0.05 mm hoch				
Streuwert	1.12, horizontal: 1.28, vertikal: 0.93				

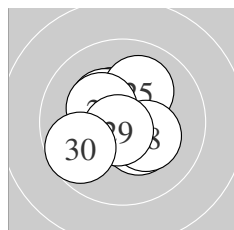

Serie 3:	10.5 *	10.4 *	10.3 *	10.7 *	10.1 ↗
	10.4 *	10.3 *	10.3 *	10.7 *	9.7 ↙
beste Teiler	60.0 (29.) 60.6 (24.) 123.4 (21.)				
Trefferlage	0.14 mm links, 0.01 mm tief				
Streuwert	1.26, horizontal: 1.33, vertikal: 1.19				

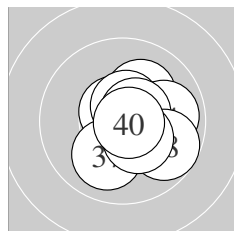

Serie 4:	10.2 *	10.6 *	10.6 *	9.9 →	10.6 *
	10.6 *	10.0 ↙	9.7 ↘	10.4 *	10.8 *
beste Teiler	41.4 (40.) 76.4 (32.) 79.3 (33.)				
Trefferlage	0.77 mm rechts, 0.01 mm tief				
Streuwert	1.17, horizontal: 1.16, vertikal: 1.18				

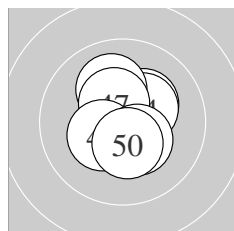

Serie 5:	10.7 *	10.6 *	10.3 *	10.3 *	10.5 *
	10.1 ↑	10.4 *	10.3 *	10.4 *	10.4 *
beste Teiler	67.2 (41.) 84.0 (42.) 101.2 (45.)				
Trefferlage	0.16 mm rechts, 0.19 mm hoch				
Streuwert	1.05, horizontal: 0.93, vertikal: 1.15				

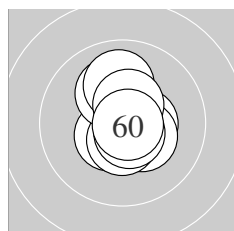

Serie 6:	10.7 *	10.4 *	10.5 *	10.4 *	10.5 *
	10.1 ↑	10.0 ↑	10.5 *	10.6 *	10.8 *
beste Teiler	34.7 (60.) 68.8 (51.) 76.2 (59.)				
Trefferlage	0.14 mm rechts, 0.13 mm hoch				
Streuwert	1.01, horizontal: 0.72, vertikal: 1.23				

Meyton Elektronik

ISSF AR Men – Wertung – Männer

StandNr: 126

Fetisov, Vladislav #287

StartNr: 26

23. Januar 2018 9:46

RUS

Unterschrift des Schützen

Meyton Elektronik

Ergebnis: **628.9** (598)^{QF}
 Serien: 105.6 105.2 104.3 105.2 103.2 105.4
 Zähler: 58 2 0 0 0 0 0 0 0
 Innenzehner: 52
 weiteste: 275 (28), 252 (50), 248 (58)
 beste Teiler 10.0 (33.) 13.4 (37.) 34.2 (59.)
 Trefferlage 0.00 mm , 0.12 mm hoch
 Streuwert 0.94, horizontal: 0.99, vertikal: 0.89

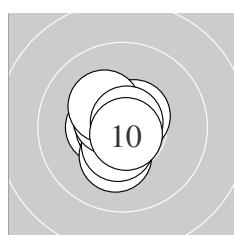
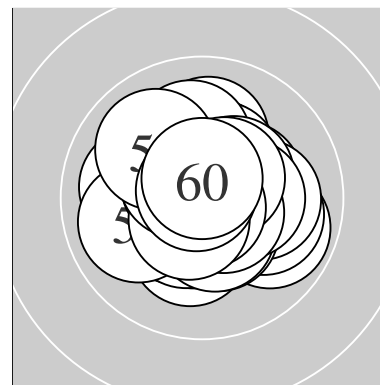

Serie 1:
 10.7 * 10.4 * 10.7 * 10.2 * 10.5 *
 10.6 * 10.6 * 10.3 * 10.8 * 10.8 *
 beste Teiler 39.0 (9.) 46.9 (10.) 66.1 (3.)
 Trefferlage 0.32 mm links, 0.01 mm hoch
 Streuwert 0.80, horizontal: 0.66, vertikal: 0.92

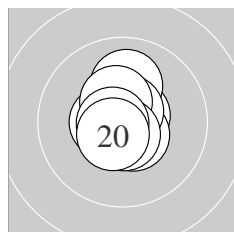

Serie 2:
 10.6 * 10.0 ↑ 10.5 * 10.6 * 10.7 *
 10.5 * 10.4 * 10.6 * 10.7 * 10.6 *
 beste Teiler 62.5 (19.) 73.9 (15.) 76.5 (18.)
 Trefferlage 0.15 mm links, 0.22 mm hoch
 Streuwert 0.82, horizontal: 0.63, vertikal: 0.97

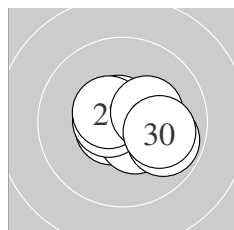

Serie 3:
 10.6 * 10.7 * 10.5 * 10.5 * 10.7 *
 10.6 * 10.5 * 9.9 ↘ 10.3 * 10.0 ↘
 beste Teiler 60.8 (22.) 69.6 (25.) 78.8 (21.)
 Trefferlage 0.57 mm rechts, 0.11 mm tief
 Streuwert 1.01, horizontal: 1.25, vertikal: 0.68

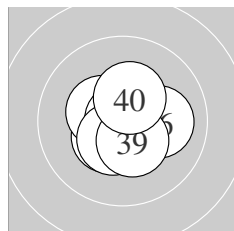

Serie 4:
 10.4 * 10.7 * 10.9 * 10.5 * 10.4 *
 10.1 → 10.9 * 10.5 * 10.4 * 10.4 *
 beste Teiler 10.0 (33.) 13.4 (37.) 57.4 (32.)
 Trefferlage 0.15 mm rechts, 0.14 mm tief
 Streuwert 0.92, horizontal: 0.98, vertikal: 0.85

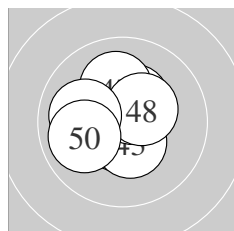

Serie 5:
 10.5 * 10.6 * 10.4 * 10.4 * 10.5 *
 10.4 * 10.1 ↑ 10.4 * 10.0 ← 9.9 ←
 beste Teiler 86.3 (42.) 103.2 (41.) 106.0 (45.)
 Trefferlage 0.19 mm links, 0.47 mm hoch
 Streuwert 1.18, horizontal: 1.25, vertikal: 1.11

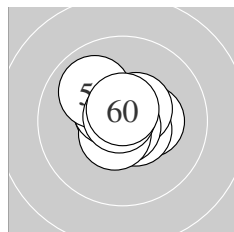

Serie 6:
 10.6 * 10.3 * 10.6 * 10.5 * 10.8 *
 10.6 * 10.5 * 10.0 ↘ 10.8 * 10.7 *
 beste Teiler 34.2 (59.) 37.9 (55.) 72.0 (60.)
 Trefferlage 0.06 mm links, 0.31 mm hoch
 Streuwert 0.87, horizontal: 0.96, vertikal: 0.77

Meyton Elektronik

ISSF AR Men – Wertung – **Männer**

StandNr: 127

Pickl, Bernhard #333

StartNr: 27

23. Januar 2018 9:44

AUT

QF – Schütze hat sich fürs Finale qualifiziert

Unterschrift des Schützen

Meyton Elektronik

Ergebnis: **625.1** (596)^{QF}
 Serien: 103.1 103.8 105.3 104.1 104.7 104.1
 Zähler: 56 4 0 0 0 0 0 0 0
 Innenzehner: 49
 weiteste: 410 (39), 327 (7), 262 (14)
 beste Teiler 14.5 (5.) 19.4 (13.) 25.0 (35.)
 Trefferlage 0.30 mm links, 0.09 mm hoch
 Streuwert 1.08, horizontal: 1.16, vertikal: 0.99

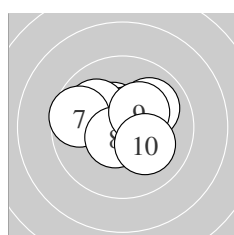
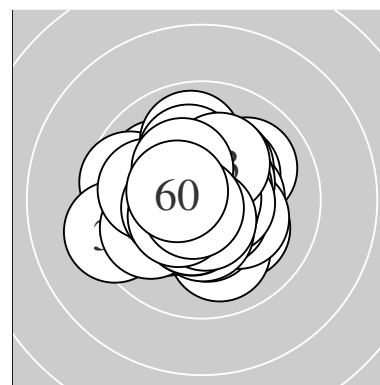

Serie 1:
 10.4 * 10.7 * 10.5 * 10.0 ↗ 10.9 *
 10.0 ↖ 9.6 ← 10.6 * 10.3 * 10.1 ↘
 beste Teiler 14.5 (5.) 73.2 (2.) 92.4 (8.)
 Trefferlage 0.23 mm links, 0.48 mm hoch
 Streuwert 1.30, horizontal: 1.60, vertikal: 0.90

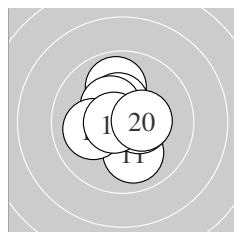

Serie 2:
 10.0 ↓ 10.5 * 10.9 * 9.9 ↑ 10.4 *
 10.4 * 10.1 ← 10.5 * 10.7 * 10.4 *
 beste Teiler 19.4 (13.) 64.1 (19.) 111.3 (12.)
 Trefferlage 0.16 mm links, 0.33 mm hoch
 Streuwert 1.19, horizontal: 1.08, vertikal: 1.28

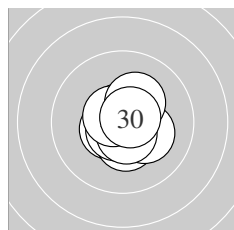

Serie 3:
 10.7 * 10.5 * 10.4 * 10.6 * 10.2 *
 10.6 * 10.7 * 10.6 * 10.3 * 10.7 *
 beste Teiler 63.6 (27.) 66.0 (30.) 70.8 (21.)
 Trefferlage 0.20 mm rechts, 0.11 mm tief
 Streuwert 0.82, horizontal: 0.78, vertikal: 0.85

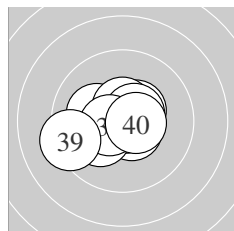

Serie 4:
 10.5 * 10.6 * 10.2 * 10.6 * 10.9 *
 10.2 * 10.6 * 10.6 * 9.3 ← 10.6 *
 beste Teiler 25.0 (35.) 95.4 (32.) 98.9 (40.)
 Trefferlage 0.46 mm links, 0.09 mm tief
 Streuwert 1.27, horizontal: 1.60, vertikal: 0.81

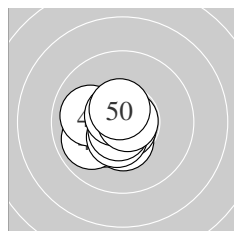

Serie 5:
 10.4 * 10.3 * 9.9 ↙ 10.0 ← 10.8 *
 10.5 * 10.7 * 10.7 * 10.8 * 10.6 *
 beste Teiler 37.6 (49.) 48.3 (45.) 67.9 (47.)
 Trefferlage 0.67 mm links, 0.38 mm tief
 Streuwert 0.91, horizontal: 0.98, vertikal: 0.83

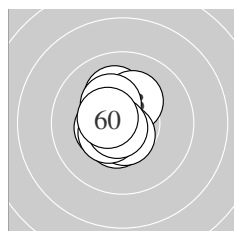

Serie 6:
 10.4 * 10.1 ↑ 10.2 * 10.5 * 10.4 *
 10.6 * 10.3 * 10.4 * 10.7 * 10.5 *
 beste Teiler 53.8 (59.) 89.2 (56.) 116.2 (54.)
 Trefferlage 0.47 mm links, 0.32 mm hoch
 Streuwert 0.93, horizontal: 0.66, vertikal: 1.15

Meyton Elektronik

ISSF AR Men – Wertung – Männer
StandNr: 128
Moldoveanu, Alin George #270

StartNr: 28
23. Januar 2018 9:33
ROM

QF – Schütze hat sich fürs Finale qualifiziert

Unterschrift des Schützen

Meyton Elektronik

Ergebnis:	627.9	(596) ^{QF}			
Serien:	104.0	105.0	106.0	103.4	104.8 104.7
Zähler:	56	4	0	0	0 0 0 0 0
Innenzehner:	54				
weiteste:	418	(33), 366	(44), 310	(2)	
beste Teiler	5.3	(46.)	7.2	(30.)	26.8 (34.)
Trefferlage	0.48	mm rechts,	0.00	mm	
Streuwert	0.97,	horizontal: 1.07,	vertikal: 0.86		

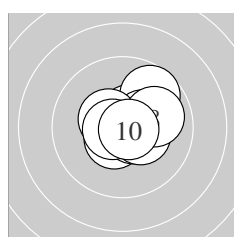
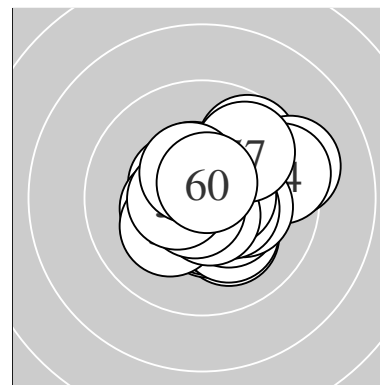

Serie 1:	10.5 *	9.7 ↗	10.3 *	10.5 *	10.6 *
	10.5 *	10.4 *	10.0 →	10.7 *	10.8 *
beste Teiler	48.1	(10.)	75.7	(9.)	93.2 (5.)
Trefferlage	0.65	mm rechts,	0.29	mm hoch	
Streuwert	1.07,	horizontal: 1.18,	vertikal: 0.95		

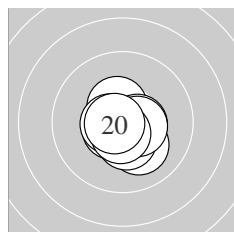

Serie 2:	10.5 *	10.5 *	10.6 *	10.1 ↘	10.6 *
	10.5 *	10.4 *	10.5 *	10.6 *	10.7 *
beste Teiler	61.0	(20.)	85.3	(19.)	93.0 (15.)
Trefferlage	0.11	mm rechts,	0.49	mm tief	
Streuwert	0.80,	horizontal: 0.81,	vertikal: 0.78		

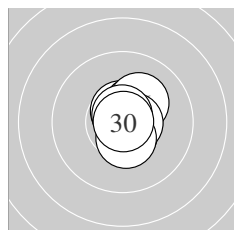

Serie 3:	10.6 *	10.4 *	10.8 *	10.6 *	10.7 *
	10.2 *	10.6 *	10.5 *	10.7 *	10.9 *
beste Teiler	7.2	(30.)	47.0	(23.)	52.1 (29.)
Trefferlage	0.40	mm rechts,	0.21	mm hoch	
Streuwert	0.66,	horizontal: 0.44,	vertikal: 0.83		

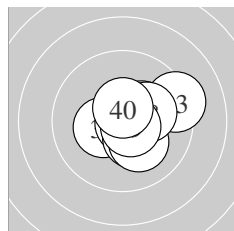

Serie 4:	10.4 *	10.5 *	9.3 →	10.8 *	10.4 *
	10.3 *	10.2 *	10.2 *	10.7 *	10.6 *
beste Teiler	26.8	(34.)	72.6	(39.)	98.0 (40.)
Trefferlage	0.94	mm rechts,	0.00	mm	
Streuwert	1.19,	horizontal: 1.38,	vertikal: 0.96		

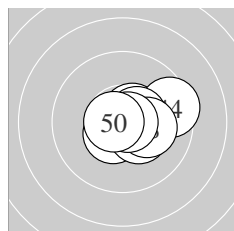

Serie 5:	10.7 *	10.6 *	10.5 *	9.5 →	10.5 *
	10.9 *	10.4 *	10.2 *	10.8 *	10.7 *
beste Teiler	5.3	(46.)	39.0	(49.)	54.0 (41.)
Trefferlage	0.70	mm rechts,	0.04	mm tief	
Streuwert	1.01,	horizontal: 1.29,	vertikal: 0.63		

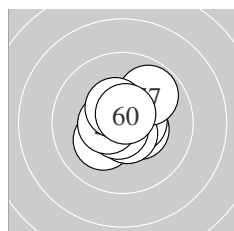

Serie 6:	10.4 *	10.5 *	10.2 *	10.6 *	10.8 *
	10.7 *	9.8 ↗	10.5 *	10.5 *	10.7 *
beste Teiler	43.1	(55.)	54.6	(56.)	71.4 (60.)
Trefferlage	0.10	mm rechts,	0.06	mm hoch	
Streuwert	1.02,	horizontal: 1.06,	vertikal: 0.98		

Meyton Elektronik

ISSF AR Men – Wertung – Männer

StandNr: 129

Panchenko, Evgenii #284

StartNr: 29

23. Januar 2018 9:48

RUS

QF – Schütze hat sich fürs Finale qualifiziert

Unterschrift des Schützen

Meyton Elektronik

Ergebnis:	627.9	(597) ^{QF}							
Serien:	105.6	103.3	105.0	104.3	106.3	103.4			
Zähler:	57	3	0	0	0	0	0	0	0
Innenzehner:	53								
weiteste:	295 (22), 271 (19), 271 (51)								
beste Teiler	11.0 (28.)	18.0 (1.)	32.0 (10.)						
Trefferlage	0.05 mm rechts, 0.04 mm tief								
Streuwert	0.97, horizontal: 1.03, vertikal: 0.92								

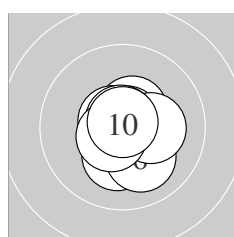
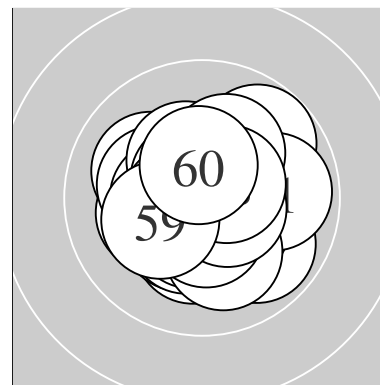

Serie 1:	10.9 *	10.5 *	10.2 *	10.8 *	10.7 *
	10.1 ↘	10.2 *	10.8 *	10.6 *	10.8 *
beste Teiler	18.0 (1.) 32.0 (10.) 43.6 (8.)				
Trefferlage	0.20 mm rechts, 0.19 mm tief				
Streuwert	0.87, horizontal: 0.78, vertikal: 0.96				

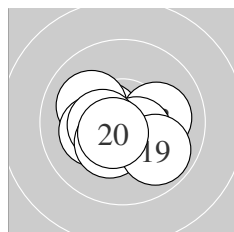

Serie 2:	10.7 *	10.5 *	10.1 →	10.1 ↖	10.2 *
	10.5 *	10.4 *	10.3 *	9.9 ↘	10.6 *
beste Teiler	51.6 (11.) 92.0 (20.) 109.6 (16.)				
Trefferlage	0.29 mm links, 0.36 mm tief				
Streuwert	1.20, horizontal: 1.49, vertikal: 0.81				

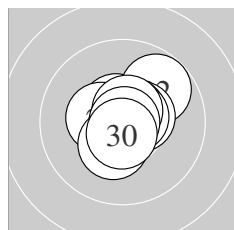

Serie 3:	10.6 *	9.8 ↗	10.5 *	10.6 *	10.4 *
	10.6 *	10.6 *	10.9 *	10.3 *	10.7 *
beste Teiler	11.0 (28.) 73.2 (30.) 76.4 (24.)				
Trefferlage	0.23 mm rechts, 0.30 mm hoch				
Streuwert	0.94, horizontal: 0.96, vertikal: 0.93				

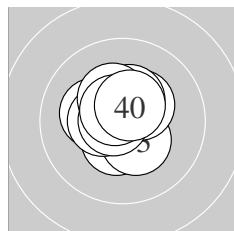

Serie 4:	10.4 *	10.2 *	10.4 *	10.4 *	10.4 *
	10.4 *	10.7 *	10.3 *	10.6 *	10.5 *
beste Teiler	58.1 (37.) 84.0 (39.) 109.1 (40.)				
Trefferlage	0.23 mm links, 0.36 mm hoch				
Streuwert	0.93, horizontal: 0.91, vertikal: 0.95				

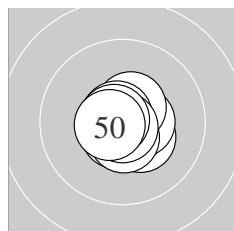

Serie 5:	10.4 *	10.5 *	10.6 *	10.8 *	10.6 *
	10.5 *	10.8 *	10.8 *	10.7 *	10.6 *
beste Teiler	34.0 (48.) 50.0 (44.) 50.9 (47.)				
Trefferlage	0.02 mm rechts, 0.16 mm tief				
Streuwert	0.65, horizontal: 0.68, vertikal: 0.61				

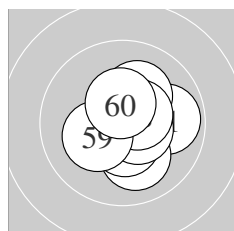

Serie 6:	9.9 →	10.4 *	10.1 ↘	10.6 *	10.5 *
	10.5 *	10.2 *	10.5 *	10.2 *	10.5 *
beste Teiler	83.4 (54.) 104.1 (56.) 107.9 (58.)				
Trefferlage	0.41 mm rechts, 0.19 mm tief				
Streuwert	1.17, horizontal: 1.20, vertikal: 1.13				

Meyton Elektronik

ISSF AR Men – Wertung – **Männer**

StandNr: 130

Loretan, Pascal #288

StartNr: 30

23. Januar 2018 9:51

SUI

QF – Schütze hat sich fürs Finale qualifiziert

Unterschrift des Schützen

Meyton Elektronik

Ergebnis: **624.2** (598)
 Serien: 104.0 104.0 103.8 103.6 104.6 104.2
 Zähler: 58 2 0 0 0 0 0 0 0
 Innenzehner: 52
 weiteste: 290 (9), 287 (38), 250 (15)
 beste Teiler 8.6 (11.) 46.5 (54.) 56.2 (5.)
 Trefferlage 0.20 mm rechts, 0.06 mm hoch
 Streuwert 1.04, horizontal: 1.07, vertikal: 1.02

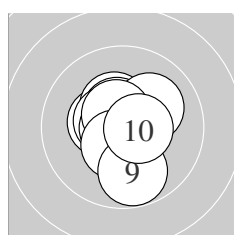
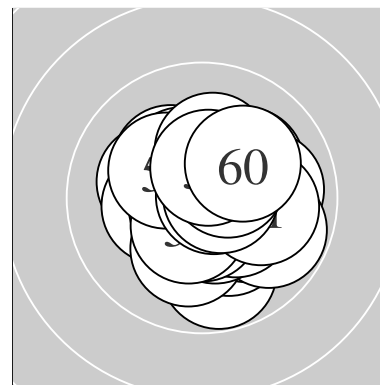

Serie 1:
 10.4 * 10.4 * 10.5 * 10.5 * 10.7 *
 10.1 ↗ 10.6 * 10.5 * 9.8 ↓ 10.5 *
 beste Teiler 56.2 (5.) 91.6 (7.) 102.3 (10.)
 Trefferlage 0.12 mm links, 0.10 mm hoch
 Streuwert 1.12, horizontal: 0.95, vertikal: 1.27

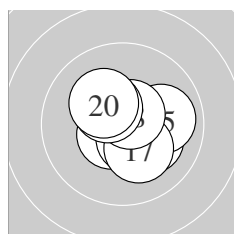

Serie 2:
 10.9 * 10.6 * 10.4 * 10.2 * 10.0 →
 10.5 * 10.2 * 10.6 * 10.4 * 10.2 *
 beste Teiler 8.6 (11.) 80.4 (18.) 97.6 (12.)
 Trefferlage 0.46 mm rechts, 0.08 mm tief
 Streuwert 1.09, horizontal: 1.21, vertikal: 0.94

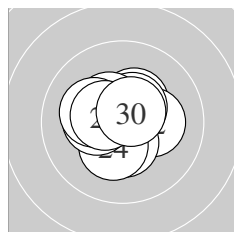

Serie 3:
 10.4 * 10.2 * 10.4 * 10.3 * 10.3 *
 10.5 * 10.4 * 10.2 * 10.5 * 10.6 *
 beste Teiler 86.8 (30.) 114.8 (26.) 121.8 (29.)
 Trefferlage 0.22 mm links, 0.22 mm hoch
 Streuwert 1.07, horizontal: 1.18, vertikal: 0.95

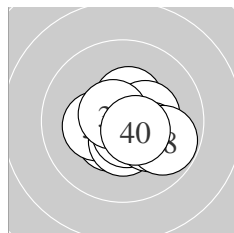

Serie 4:
 10.4 * 10.4 * 10.3 * 10.4 * 10.4 *
 10.6 * 10.1 ↘ 9.8 ↘ 10.7 * 10.5 *
 beste Teiler 75.4 (39.) 80.6 (36.) 102.4 (40.)
 Trefferlage 0.42 mm rechts, 0.41 mm tief
 Streuwert 1.09, horizontal: 1.28, vertikal: 0.85

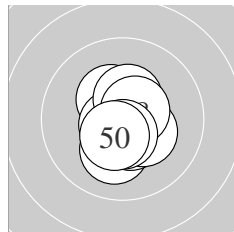

Serie 5:
 10.1 ↓ 10.5 * 10.5 * 10.3 * 10.4 *
 10.7 * 10.4 * 10.6 * 10.6 * 10.5 *
 beste Teiler 69.6 (46.) 95.9 (48.) 99.0 (49.)
 Trefferlage 0.05 mm rechts, 0.20 mm tief
 Streuwert 0.96, horizontal: 0.68, vertikal: 1.17

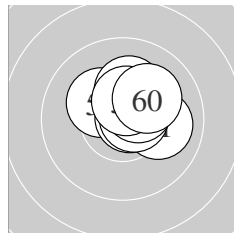

Serie 6:
 10.0 → 10.6 * 10.3 * 10.8 * 10.5 *
 10.7 * 10.2 * 10.5 * 10.5 * 10.1 ↗
 beste Teiler 46.5 (54.) 73.8 (56.) 100.6 (52.)
 Trefferlage 0.66 mm rechts, 0.75 mm hoch
 Streuwert 0.82, horizontal: 0.95, vertikal: 0.66

Meyton Elektronik

ISSF AR Men – Wertung – Männer

StandNr: 131

Driagin, Aleksandr #294

StartNr: 31

23. Januar 2018 9:37

RUS

Unterschrift des Schützen

Meyton Elektronik

Ergebnis:	616.1	(588)							
Serien:	103.5	103.8	100.8	103.3	102.1	102.6			
Zähler:	48	12	0	0	0	0	0	0	0
Innenzehner:	36								
weiteste:	363 (40), 332 (26), 319 (42)								
beste Teiler	14.5 (13.)	19.8 (35.)	29.8 (36.)						
Trefferlage	0.27 mm links, 0.20 mm tief								
Streuwert	1.35, horizontal: 1.43, vertikal: 1.27								

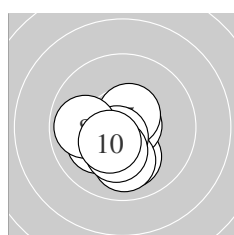
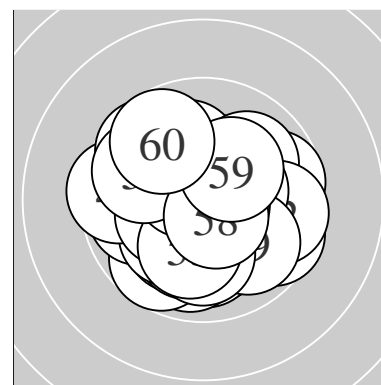

Serie 1:	10.1 ↓	10.7 *	10.8 *	10.0 ↓	10.6 *
	10.1 ↙	10.6 *	9.9 ←	10.3 *	10.4 *
beste Teiler	42.1 (3.) 58.2 (2.) 82.8 (7.)				
Trefferlage	0.49 mm links, 0.80 mm tief				
Streuwert	1.06, horizontal: 1.06, vertikal: 1.06				

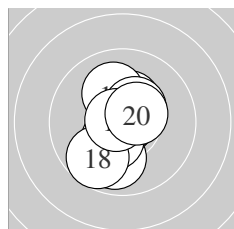

Serie 2:	10.3 *	9.9 ↓	10.9 *	10.8 *	10.1 ↗
	10.4 *	10.4 *	9.7 ↘	10.8 *	10.5 *
beste Teiler	14.5 (13.) 45.8 (14.) 48.3 (19.)				
Trefferlage	0.15 mm links, 0.08 mm tief				
Streuwert	1.26, horizontal: 0.85, vertikal: 1.56				

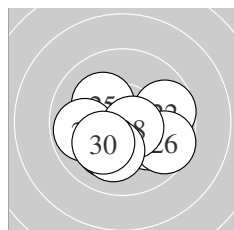

Serie 3:	10.1 ↘	9.7 →	10.5 *	10.1 ↙	10.2 *
	9.6 ↘	9.8 ←	10.6 *	10.1 ↓	10.1 ↙
beste Teiler	80.1 (28.) 114.0 (23.) 193.1 (25.)				
Trefferlage	0.06 mm rechts, 0.76 mm tief				
Streuwert	1.59, horizontal: 1.98, vertikal: 1.08				

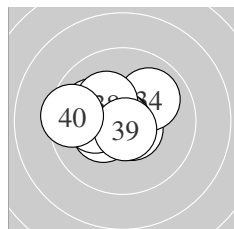

Serie 4:	10.3 *	10.0 ↖	10.6 *	10.0 ↗	10.9 *
	10.8 *	10.2 *	10.3 *	10.7 *	9.5 ←
beste Teiler	19.8 (35.) 29.8 (36.) 61.9 (39.)				
Trefferlage	0.80 mm links, 0.19 mm hoch				
Streuwert	1.25, horizontal: 1.58, vertikal: 0.80				

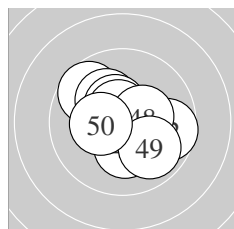

Serie 5:	10.7 *	9.7 →	9.7 ↘	10.2 *	10.4 *
	10.6 *	10.2 *	10.4 *	9.9 ↘	10.3 *
beste Teiler	67.1 (41.) 83.5 (46.) 126.6 (45.)				
Trefferlage	0.14 mm rechts, 0.17 mm hoch				
Streuwert	1.51, horizontal: 1.69, vertikal: 1.31				

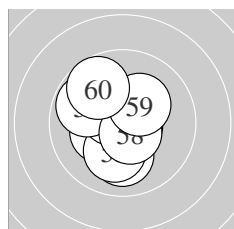

Serie 6:	10.3 *	10.0 ↓	10.1 ↓	10.7 *	10.6 *
	10.6 *	9.8 ↖	10.6 *	10.2 *	9.7 ↘
beste Teiler	64.8 (54.) 87.9 (56.) 89.6 (58.)				
Trefferlage	0.41 mm links, 0.05 mm hoch				
Streuwert	1.37, horizontal: 1.22, vertikal: 1.51				

ISSF AR Men – Wertung – **Männer**

StandNr: 132

Wind, Jelle #292

StartNr: 32

23. Januar 2018 9:49

NED

Unterschrift des Schützen

Meyton Elektronik

Ergebnis: **615.4** (591)
 Serien: 102.4 101.8 101.9 102.3 103.2 103.8
 Zähler: 51 9 0 0 0 0 0 0 0
 Innenzehner: 38
 weiteste: 413 (15), 363 (42), 336 (38)
 beste Teiler 63.9 (56.) 64.0 (20.) 66.7 (37.)
 Trefferlage 0.20 mm links, 0.08 mm hoch
 Streuwert 1.37, horizontal: 1.56, vertikal: 1.14

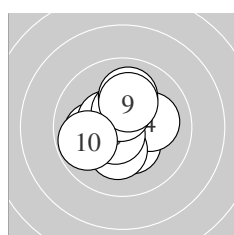
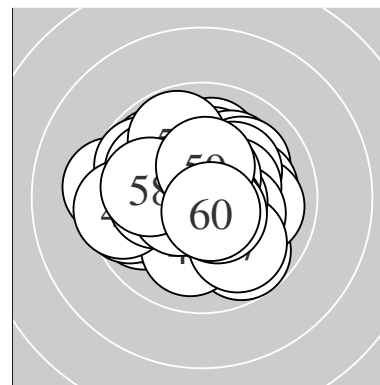

Serie 1:
 10.4 * 10.1 ← 10.4 * 10.1 → 10.3 *
 10.6 * 10.5 * 10.0 † 10.2 * 9.8 ←
 beste Teiler 77.7 (6.) 117.7 (7.) 129.8 (3.)
 Trefferlage 0.35 mm links, 0.13 mm hoch
 Streuwert 1.38, horizontal: 1.40, vertikal: 1.36

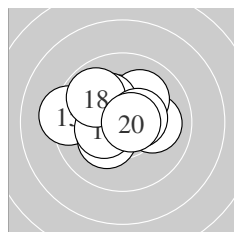

Serie 2:
 10.4 * 10.0 → 10.1 ↗ 10.2 * 9.3 ←
 10.3 * 10.4 * 9.9 ↘ 10.5 * 10.7 *
 beste Teiler 64.0 (20.) 120.0 (19.) 138.6 (11.)
 Trefferlage 0.48 mm links, 0.53 mm hoch
 Streuwert 1.52, horizontal: 1.88, vertikal: 1.05

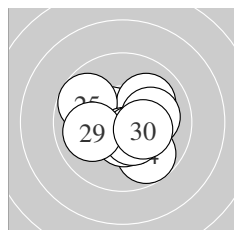

Serie 3:
 10.6 * 10.5 * 10.0 ↗ 9.8 ↘ 9.7 ↘
 10.5 * 10.4 * 10.1 → 10.0 ← 10.3 *
 beste Teiler 99.2 (21.) 101.5 (22.) 114.4 (26.)
 Trefferlage 0.14 mm rechts, 0.27 mm tief
 Streuwert 1.50, horizontal: 1.74, vertikal: 1.21

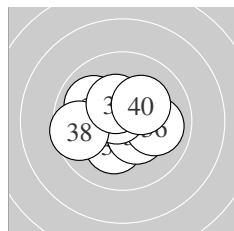

Serie 4:
 10.2 * 10.4 * 10.0 ↘ 10.4 * 10.4 *
 10.0 → 10.7 * 9.6 ← 10.4 * 10.2 *
 beste Teiler 66.7 (37.) 132.1 (32.) 140.0 (39.)
 Trefferlage 0.00 mm, 0.17 mm hoch
 Streuwert 1.46, horizontal: 1.76, vertikal: 1.08

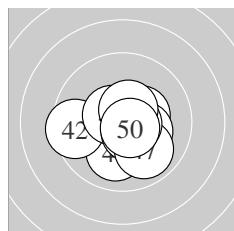

Serie 5:
 10.0 ↓ 9.5 ← 10.6 * 10.4 * 10.3 *
 10.6 * 9.9 ↘ 10.7 * 10.5 * 10.7 *
 beste Teiler 71.8 (50.) 74.5 (48.) 95.9 (43.)
 Trefferlage 0.19 mm rechts, 0.49 mm tief
 Streuwert 1.32, horizontal: 1.56, vertikal: 1.04

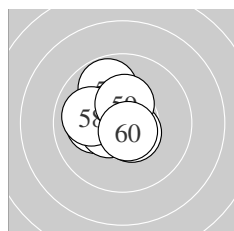

Serie 6:
 10.5 * 10.1 ← 10.5 * 9.8 † 10.5 *
 10.7 * 10.6 * 10.0 ← 10.4 * 10.7 *
 beste Teiler 63.9 (56.) 73.7 (60.) 99.3 (57.)
 Trefferlage 0.70 mm links, 0.41 mm hoch
 Streuwert 1.03, horizontal: 1.02, vertikal: 1.04

Meyton Elektronik

ISSF AR Men – Wertung – Männer

StandNr: 133

Rositer, Jack #277

StartNr: 33

23. Januar 2018 9:44

AUS

Unterschrift des Schützen

Meyton Elektronik

Ergebnis: **623.4** (593)
 Serien: 103.9 103.1 103.6 106.0 104.1 102.7
 Zähler: 53 7 0 0 0 0 0 0 0
 Innenzehner: 47
 weiteste: 361 (26), 327 (24), 312 (41)
 beste Teiler 8.0 (49.) 19.4 (8.) 29.0 (55.)
 Trefferlage 0.04 mm rechts, 0.12 mm hoch
 Streuwert 1.15, horizontal: 1.28, vertikal: 0.99

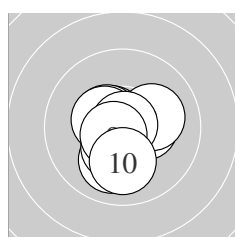
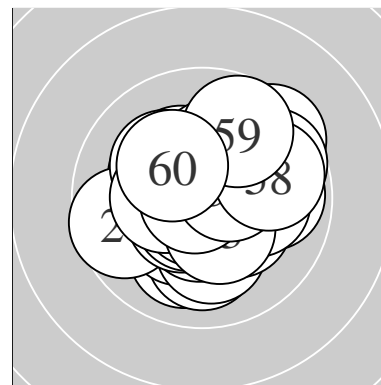

Serie 1:
 10.4 * 10.1 → 10.6 * 10.0 ↓ 10.4 *
 10.5 * 10.4 * 10.9 * 10.6 * 10.0 ↓
 beste Teiler 19.4 (8.) 80.1 (9.) 91.6 (3.)
 Trefferlage 0.13 mm links, 0.38 mm tief
 Streuwert 1.11, horizontal: 1.06, vertikal: 1.16

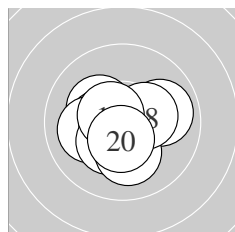

Serie 2:
 10.2 * 10.4 * 10.1 ← 10.7 * 9.9 →
 10.3 * 10.1 ↓ 10.3 * 10.6 * 10.5 *
 beste Teiler 71.1 (14.) 92.7 (19.) 113.5 (20.)
 Trefferlage 0.32 mm links, 0.24 mm tief
 Streuwert 1.22, horizontal: 1.43, vertikal: 0.96

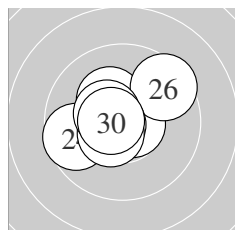

Serie 3:
 10.6 * 10.3 * 10.6 * 9.6 ← 10.7 *
 9.5 ↗ 10.7 * 10.5 * 10.5 * 10.6 *
 beste Teiler 64.5 (25.) 70.0 (27.) 78.4 (30.)
 Trefferlage 0.55 mm links, 0.22 mm hoch
 Streuwert 1.26, horizontal: 1.48, vertikal: 1.00

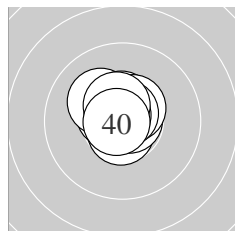

Serie 4:
 10.7 * 10.6 * 10.2 * 10.8 * 10.5 *
 10.5 * 10.7 * 10.7 * 10.5 * 10.8 *
 beste Teiler 41.4 (40.) 44.9 (34.) 52.4 (38.)
 Trefferlage 0.24 mm links, 0.50 mm hoch
 Streuwert 0.62, horizontal: 0.62, vertikal: 0.62

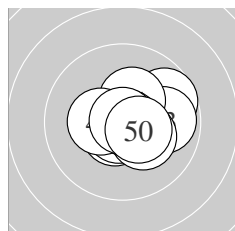

Serie 5:
 9.7 ↗ 10.6 * 9.9 → 10.3 * 10.7 *
 10.3 * 10.8 * 10.4 * 10.9 * 10.5 *
 beste Teiler 8.0 (49.) 33.9 (47.) 58.5 (45.)
 Trefferlage 0.66 mm rechts, 0.02 mm hoch
 Streuwert 1.12, horizontal: 1.37, vertikal: 0.81

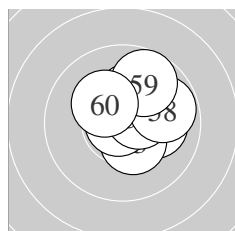

Serie 6:
 10.7 * 10.1 → 10.4 * 10.3 * 10.8 *
 10.2 * 10.5 * 9.8 → 9.7 ↑ 10.2 *
 beste Teiler 29.0 (55.) 54.4 (51.) 119.5 (57.)
 Trefferlage 0.88 mm rechts, 0.62 mm hoch
 Streuwert 1.13, horizontal: 1.14, vertikal: 1.13

Meyton Elektronik

ISSF AR Men – Wertung – Männer

StandNr: 134

Strepfl, Martin #296

StartNr: 34

23. Januar 2018 10:00

AUT

Unterschrift des Schützen

Meyton Elektronik

Ergebnis: **621.5** (591)
 Serien: 102.6 104.4 103.8 103.2 105.2 102.3
 Zähler: 51 9 0 0 0 0 0 0 0 0
 Innenzehner: 47
 weiteste: 453 (39), 321 (25), 320 (5)
 beste Teiler 20.6 (49.) 25.8 (19.) 39.3 (32.)
 Trefferlage 0.02 mm links, 0.12 mm hoch
 Streuwert 1.21, horizontal: 1.42, vertikal: 0.95

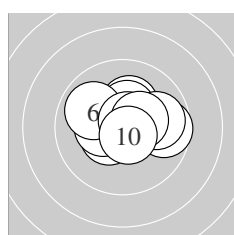
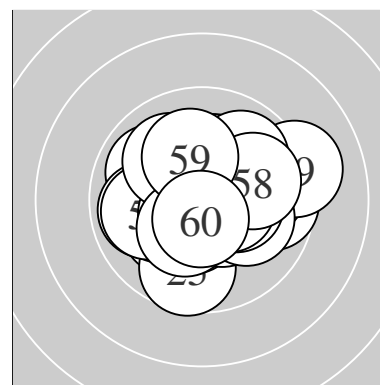

Serie 1:
 10.4 * 10.2 * 10.3 * 10.4 * 9.7 →
 9.9 ↖ 10.7 * 9.9 → 10.4 * 10.7 *
 beste Teiler 61.6 (7.) 75.4 (10.) 126.4 (1.)
 Trefferlage 0.39 mm rechts, 0.45 mm hoch
 Streuwert 1.35, horizontal: 1.71, vertikal: 0.83

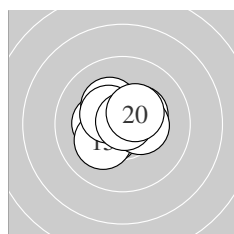

Serie 2:
 10.3 * 10.5 * 10.4 * 10.6 * 10.2 *
 10.4 * 10.3 * 10.4 * 10.9 * 10.4 *
 beste Teiler 25.8 (19.) 95.1 (14.) 119.0 (12.)
 Trefferlage 0.30 mm links, 0.26 mm hoch
 Streuwert 1.00, horizontal: 1.16, vertikal: 0.81

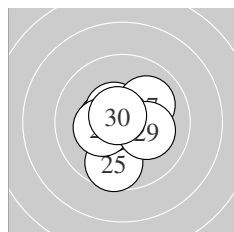

Serie 3:
 10.5 * 10.8 * 10.5 * 10.5 * 9.7 ↓
 10.6 * 10.0 ↗ 10.3 * 10.2 * 10.7 *
 beste Teiler 47.4 (22.) 63.4 (30.) 96.3 (26.)
 Trefferlage 0.21 mm links, 0.25 mm tief
 Streuwert 1.21, horizontal: 1.21, vertikal: 1.22

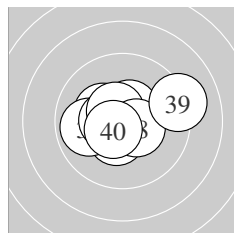

Serie 4:
 10.3 * 10.8 * 10.4 * 10.5 * 9.9 ←
 10.5 * 10.6 * 10.5 * 9.1 → 10.6 *
 beste Teiler 39.3 (32.) 95.2 (37.) 97.7 (40.)
 Trefferlage 0.07 mm links, 0.10 mm hoch
 Streuwert 1.45, horizontal: 1.87, vertikal: 0.84

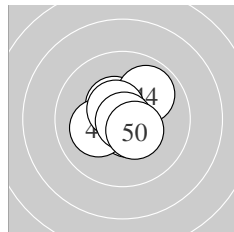

Serie 5:
 10.7 * 10.7 * 10.5 * 9.9 ↗ 10.7 *
 10.6 * 10.2 * 10.6 * 10.9 * 10.4 *
 beste Teiler 20.6 (49.) 53.4 (45.) 57.0 (41.)
 Trefferlage 0.08 mm links, 0.19 mm hoch
 Streuwert 0.95, horizontal: 1.00, vertikal: 0.89

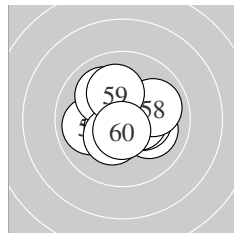

Serie 6:
 9.9 ← 10.1 → 10.3 * 10.6 * 10.0 ↘
 10.5 * 10.3 * 9.9 → 10.1 ↑ 10.6 *
 beste Teiler 89.2 (60.) 97.7 (54.) 122.4 (56.)
 Trefferlage 0.11 mm rechts, 0.00 mm
 Streuwert 1.40, horizontal: 1.61, vertikal: 1.15

Meyton Elektronik

ISSF AR Men – Wertung – Männer

StandNr: 135

Nymbursky, Petr #271

StartNr: 35

23. Januar 2018 9:58

CZE

Unterschrift des Schützen

Meyton Elektronik

Ergebnis: **620.0** (594)
 Serien: 103.4 103.5 104.7 103.6 102.0 102.8
 Zähler: 54 6 0 0 0 0 0 0 0 0
 Innenzehner: 45
 weiteste: 414 (52), 287 (17), 281 (34)
 beste Teiler 16.6 (15.) 17.0 (35.) 37.1 (57.)
 Trefferlage 0.37 mm rechts, 0.06 mm hoch
 Streuwert 1.19, horizontal: 1.38, vertikal: 0.98

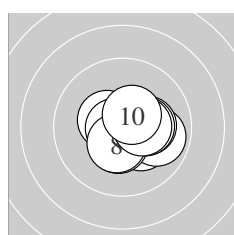
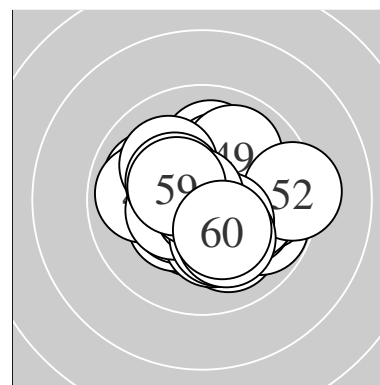

Serie 1:
 10.2 * 9.9 → 10.2 * 10.4 * 10.4 *
 10.7 * 10.3 * 10.4 * 10.4 * 10.5 *
 beste Teiler 59.3 (6.) 117.2 (10.) 130.3 (8.)
 Trefferlage 0.71 mm rechts, 0.26 mm tief
 Streuwert 1.05, horizontal: 1.27, vertikal: 0.77

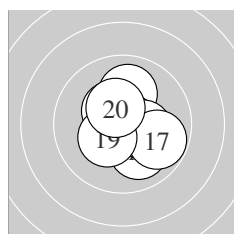

Serie 2:
 10.0 † 10.7 * 10.7 * 10.0 ↘ 10.9 *
 10.3 * 9.8 ↘ 10.4 * 10.3 * 10.4 *
 beste Teiler 16.6 (15.) 52.9 (12.) 53.0 (13.)
 Trefferlage 0.36 mm rechts, 0.04 mm tief
 Streuwert 1.22, horizontal: 1.16, vertikal: 1.27

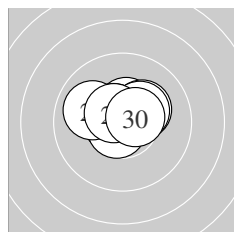

Serie 3:
 10.5 * 10.2 * 10.6 * 10.7 * 10.6 *
 10.7 * 10.0 ← 10.3 * 10.6 * 10.5 *
 beste Teiler 66.6 (26.) 71.2 (24.) 78.0 (25.)
 Trefferlage 0.15 mm links, 0.50 mm hoch
 Streuwert 0.90, horizontal: 1.16, vertikal: 0.53

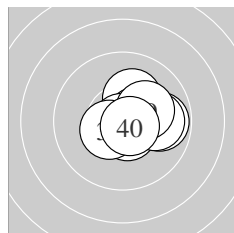

Serie 4:
 10.6 * 10.2 * 10.5 * 9.8 → 10.9 *
 10.5 * 10.2 * 10.0 → 10.2 * 10.7 *
 beste Teiler 17.0 (35.) 66.8 (40.) 85.4 (31.)
 Trefferlage 1.03 mm rechts, 0.14 mm hoch
 Streuwert 0.99, horizontal: 1.17, vertikal: 0.75

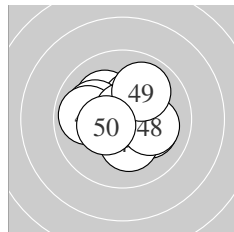

Serie 5:
 10.1 ↘ 10.2 * 10.4 * 10.2 * 10.1 ↖
 9.9 ← 10.7 * 10.1 → 9.9 ↗ 10.4 *
 beste Teiler 53.9 (47.) 133.8 (50.) 150.2 (43.)
 Trefferlage 0.06 mm links, 0.29 mm hoch
 Streuwert 1.45, horizontal: 1.68, vertikal: 1.17

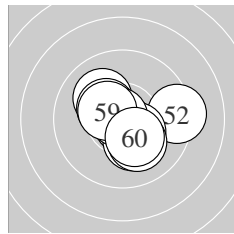

Serie 6:
 10.8 * 9.3 → 10.1 ↖ 10.4 * 10.2 *
 10.4 * 10.8 * 10.1 ↘ 10.4 * 10.3 *
 beste Teiler 37.1 (57.) 39.8 (51.) 131.5 (59.)
 Trefferlage 0.37 mm rechts, 0.25 mm tief
 Streuwert 1.43, horizontal: 1.66, vertikal: 1.15

Meyton Elektronik

ISSF AR Men – Wertung – Männer

StandNr: 136

Färber, Lars #279

StartNr: 36

23. Januar 2018 9:59

SUI

Unterschrift des Schützen

Meyton Elektronik

Ergebnis: **617.8** (590)
 Serien: 102.0 101.0 105.3 102.7 103.6 103.2
 Zähler: 50 10 0 0 0 0 0 0 0
 Innenzehner: 43
 weiteste: 342 (12), 326 (19), 285 (6)
 beste Teiler 17.0 (23.) 26.9 (33.) 38.6 (44.)
 Trefferlage 0.04 mm links, 0.10 mm tief
 Streuwert 1.28, horizontal: 1.47, vertikal: 1.06

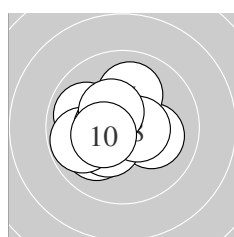
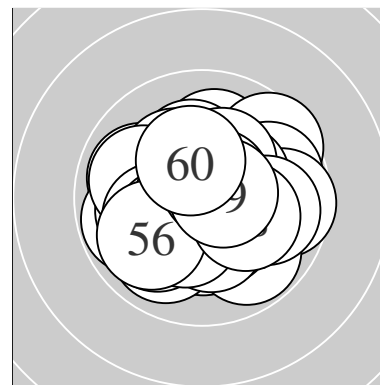

Serie 1:
 9.9 ↖ 10.1 → 10.1 ↙ 10.3 * 10.0 ↑
 9.8 ← 10.5 * 10.5 * 10.4 * 10.4 *
 beste Teiler 102.8 (8.) 110.0 (7.) 130.8 (9.)
 Trefferlage 0.76 mm links, 0.05 mm tief
 Streuwert 1.33, horizontal: 1.51, vertikal: 1.13

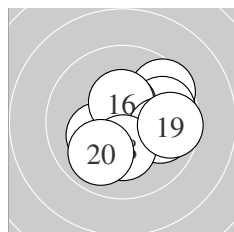

Serie 2:
 10.8 * 9.6 ↗ 10.2 * 9.8 → 10.5 *
 10.4 * 9.9 → 10.3 * 9.6 → 9.9 ↙
 beste Teiler 50.3 (11.) 114.2 (15.) 135.2 (16.)
 Trefferlage 0.81 mm rechts, 0.05 mm tief
 Streuwert 1.62, horizontal: 1.83, vertikal: 1.37

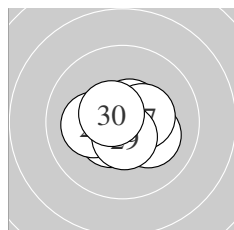

Serie 3:
 10.6 * 10.7 * 10.9 * 10.5 * 10.2 *
 10.7 * 10.4 * 10.2 * 10.5 * 10.6 *
 beste Teiler 17.0 (23.) 57.7 (22.) 71.1 (26.)
 Trefferlage 0.09 mm rechts, 0.20 mm tief
 Streuwert 0.89, horizontal: 1.08, vertikal: 0.64

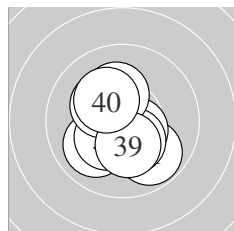

Serie 4:
 9.8 ↘ 10.0 ↙ 10.8 * 10.5 * 10.3 *
 10.3 * 10.3 * 10.2 * 10.3 * 10.2 *
 beste Teiler 26.9 (33.) 106.0 (34.) 151.6 (36.)
 Trefferlage 0.18 mm links, 0.43 mm tief
 Streuwert 1.29, horizontal: 1.16, vertikal: 1.41

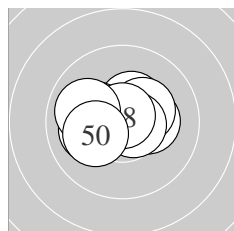

Serie 5:
 10.3 * 10.4 * 10.1 ← 10.8 * 10.3 *
 10.6 * 10.2 * 10.8 * 10.0 ← 10.1 ←
 beste Teiler 38.6 (44.) 43.0 (48.) 77.3 (46.)
 Trefferlage 0.39 mm links, 0.26 mm hoch
 Streuwert 1.17, horizontal: 1.54, vertikal: 0.62

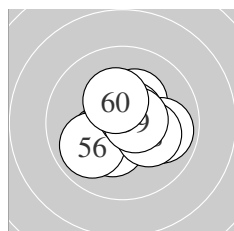

Serie 6:
 10.3 * 10.3 * 9.9 → 10.8 * 10.3 *
 9.9 ↙ 10.6 * 10.2 * 10.6 * 10.3 *
 beste Teiler 48.5 (54.) 82.0 (57.) 89.4 (59.)
 Trefferlage 0.15 mm rechts, 0.14 mm tief
 Streuwert 1.28, horizontal: 1.44, vertikal: 1.10

Meyton Elektronik

ISSF AR Men – Wertung – Männer

StandNr: 137

Sokolov, Aleksandr #285

StartNr: 37

23. Januar 2018 9:40

RUS

Unterschrift des Schützen

Meyton Elektronik

Ergebnis: **602.9** (578)
 Serien: 102.6 101.0 103.3 98.4 97.2 100.4
 Zähler: 40 18 2 0 0 0 0 0 0
 Innenzehner: 28
 weiteste: 597 (11), 510 (42), 413 (41)
 beste Teiler 29.0 (21.) 78.7 (22.) 79.3 (55.)
 Trefferlage 0.15 mm rechts, 0.68 mm tief
 Streuwert 1.72, horizontal: 1.87, vertikal: 1.55

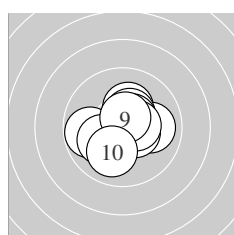
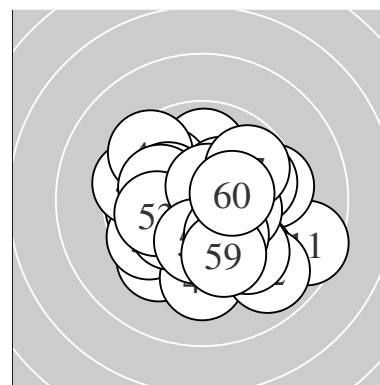

Serie 1:
 10.2 * 10.0 → 9.8 ← 10.4 * 10.5 *
 10.5 * 10.1 ↙ 10.5 * 10.6 * 10.0 ↘
 beste Teiler 89.2 (9.) 105.4 (6.) 116.9 (8.)
 Trefferlage 0.12 mm rechts, 0.04 mm hoch
 Streuwert 1.37, horizontal: 1.56, vertikal: 1.15

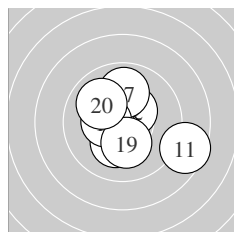

Serie 2:
 8.6 ↘ 10.4 * 10.4 * 10.4 * 10.2 *
 10.5 * 9.9 ↑ 10.4 * 10.2 * 10.0 ↘
 beste Teiler 124.4 (16.) 126.4 (13.) 129.1 (12.)
 Trefferlage 0.00 mm , 0.16 mm tief
 Streuwert 1.88, horizontal: 2.12, vertikal: 1.60

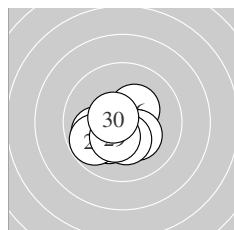

Serie 3:
 10.8 * 10.6 * 10.2 * 10.0 ← 9.8 ←
 10.3 * 10.3 * 10.3 * 10.4 * 10.6 *
 beste Teiler 29.0 (21.) 78.7 (22.) 92.1 (30.)
 Trefferlage 0.43 mm links, 0.62 mm tief
 Streuwert 1.14, horizontal: 1.31, vertikal: 0.94

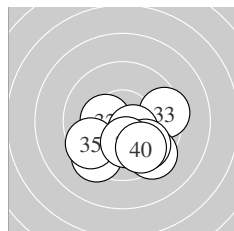

Serie 4:
 9.9 ↘ 10.4 * 9.4 → 9.4 ↗ 9.6 ←
 9.4 ↘ 10.5 * 9.8 ↘ 10.2 * 9.8 ↘
 beste Teiler 122.5 (37.) 150.4 (32.) 189.2 (39.)
 Trefferlage 0.63 mm rechts, 1.62 mm tief
 Streuwert 1.78, horizontal: 2.18, vertikal: 1.25

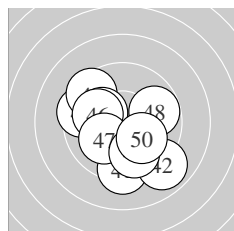

Serie 5:
 9.3 ↓ 8.9 ↘ 9.5 ← 9.5 ↘ 10.2 *
 10.0 ← 10.1 ↗ 9.8 → 9.8 ↓ 10.1 ↘
 beste Teiler 197.3 (45.) 218.8 (47.) 220.7 (50.)
 Trefferlage 0.29 mm links, 0.76 mm tief
 Streuwert 2.35, horizontal: 2.45, vertikal: 2.25

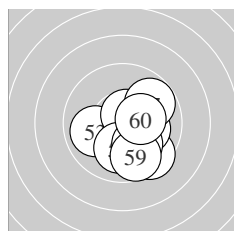

Serie 6:
 9.5 ↘ 10.2 * 10.0 ← 10.1 → 10.6 *
 10.1 ↓ 9.8 ↗ 10.1 ↘ 9.7 ↓ 10.3 *
 beste Teiler 79.3 (55.) 162.8 (60.) 183.1 (52.)
 Trefferlage 0.90 mm rechts, 0.98 mm tief
 Streuwert 1.51, horizontal: 1.46, vertikal: 1.55

Meyton Elektronik

ISSF AR Men – Wertung – **Männer**

StandNr: 138

Hoberg, Alex #177

StartNr: 38

23. Januar 2018 9:44

Australien

Unterschrift des Schützen

Meyton Elektronik

Ergebnis: **621.9** (594)
 Serien: 102.7 102.8 103.6 104.3 104.0 104.5
 Zähler: 54 6 0 0 0 0 0 0 0
 Innenzehner: 44
 weiteste: 301 (12), 284 (23), 282 (5)
 beste Teiler 12.5 (24.) 18.3 (14.) 36.3 (59.)
 Trefferlage 0.31 mm rechts, 0.17 mm tief
 Streuwert 1.14, horizontal: 1.19, vertikal: 1.09

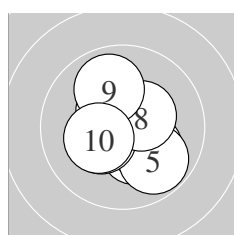
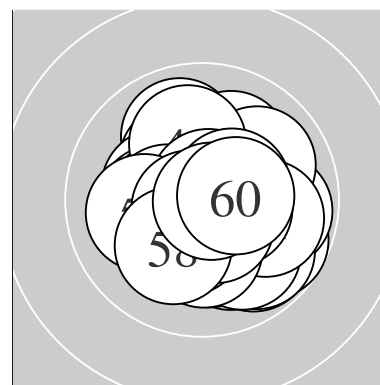

Serie 1:
 10.8 * 10.4 * 10.3 * 10.1 ↘ 9.8 ↘
 10.3 * 10.4 * 10.4 * 9.9 ↑ 10.3 *
 beste Teiler 41.1 (1.) 127.6 (7.) 139.0 (8.)
 Trefferlage 0.15 mm rechts, 0.36 mm tief
 Streuwert 1.31, horizontal: 1.26, vertikal: 1.36

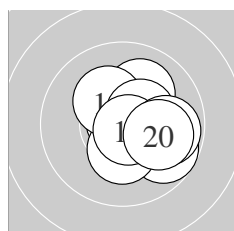

Serie 2:
 10.6 * 9.7 ↘ 10.1 ↗ 10.9 * 10.3 *
 10.3 * 10.4 * 10.7 * 9.8 → 10.0 →
 beste Teiler 18.3 (14.) 51.6 (18.) 94.4 (11.)
 Trefferlage 0.91 mm rechts, 0.05 mm hoch
 Streuwert 1.24, horizontal: 1.28, vertikal: 1.19

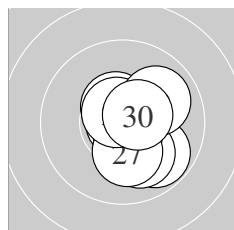

Serie 3:
 10.5 * 10.3 * 9.8 ↘ 10.9 * 10.0 ↘
 10.7 * 10.2 * 10.7 * 10.0 ↗ 10.5 *
 beste Teiler 12.5 (24.) 70.7 (26.) 72.7 (28.)
 Trefferlage 0.69 mm rechts, 0.44 mm tief
 Streuwert 1.11, horizontal: 0.92, vertikal: 1.28

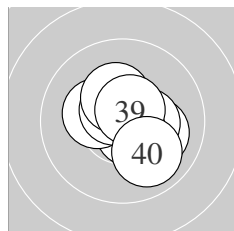

Serie 4:
 10.1 ↘ 10.7 * 10.4 * 10.7 * 10.6 *
 10.3 * 10.6 * 10.3 * 10.6 * 10.0 ↘
 beste Teiler 63.0 (34.) 66.4 (32.) 82.6 (35.)
 Trefferlage 0.23 mm rechts, 0.06 mm hoch
 Streuwert 1.07, horizontal: 1.16, vertikal: 0.97

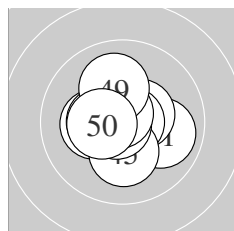

Serie 5:
 9.9 → 10.2 * 10.5 * 10.8 * 10.2 *
 10.8 * 10.4 * 10.7 * 10.1 ↑ 10.4 *
 beste Teiler 42.0 (46.) 43.0 (44.) 61.7 (48.)
 Trefferlage 0.16 mm links, 0.02 mm hoch
 Streuwert 1.14, horizontal: 1.26, vertikal: 1.01

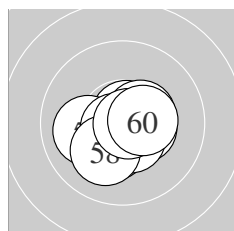

Serie 6:
 10.7 * 10.3 * 10.5 * 10.0 ← 10.5 *
 10.7 * 10.5 * 10.1 ↘ 10.8 * 10.4 *
 beste Teiler 36.3 (59.) 52.7 (51.) 57.8 (56.)
 Trefferlage 0.04 mm rechts, 0.41 mm tief
 Streuwert 0.96, horizontal: 1.13, vertikal: 0.76

Meyton Elektronik

ISSF AR Men – Wertung – Männer

StandNr: 139

Entrichel, Ales #289

StartNr: 39

23. Januar 2018 9:50

CZE

Unterschrift des Schützen

Meyton Elektronik

Ergebnis:	622.6	(596)
Serien:	104.3	104.9 104.2 104.4 101.7 103.1
Zähler:	56	4 0 0 0 0 0 0 0 0
Innenzehner:	46	
weiteste:	422	(60), 307 (7), 298 (41)
beste Teiler	9.4	(45.) 35.8 (31.) 41.7 (1.)
Trefferlage	0.13 mm	links, 0.44 mm hoch
Streuwert	1.13,	horizontal: 1.11, vertikal: 1.16

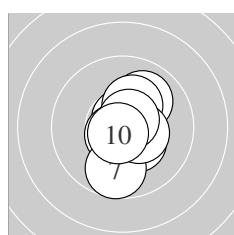
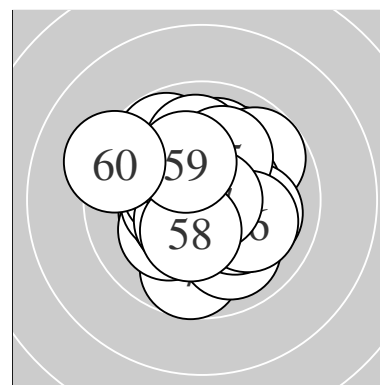

Serie 1:	10.8 *	10.4 *	10.0 ↗	10.7 *	10.6 *
	10.3 *	9.7 ↓	10.4 *	10.7 *	10.7 *
beste Teiler	41.7	(1.) 56.4	(10.) 59.2	(4.)	
Trefferlage	0.33 mm	rechts, 0.12 mm	tief		
Streuwert	1.13,	horizontal: 0.74,	vertikal: 1.41		

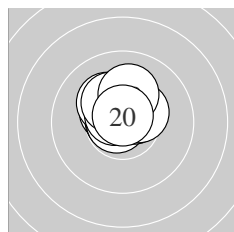

Serie 2:	10.5 *	10.7 *	10.8 *	10.2 *	10.6 *
	10.5 *	10.3 *	10.4 *	10.1 ↑	10.8 *
beste Teiler	44.1	(13.) 49.0	(20.) 54.3	(12.)	
Trefferlage	0.20 mm	links, 0.81 mm	hoch		
Streuwert	0.72,	horizontal: 0.78,	vertikal: 0.64		

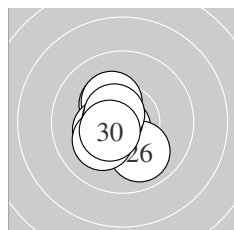

Serie 3:	10.5 *	10.3 *	10.3 *	10.8 *	10.3 *
	10.0 ↘	10.7 *	10.2 *	10.6 *	10.5 *
beste Teiler	44.7	(24.) 75.9	(27.) 84.2	(29.)	
Trefferlage	0.67 mm	links, 0.08 mm	tief		
Streuwert	0.98,	horizontal: 0.77,	vertikal: 1.16		

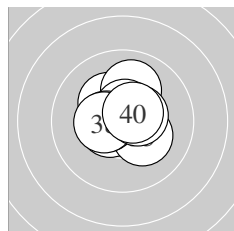

Serie 4:	10.8 *	10.5 *	10.3 *	10.0 ↑	10.2 *
	10.6 *	10.5 *	10.4 *	10.5 *	10.6 *
beste Teiler	35.8	(31.) 85.7	(36.) 98.0	(40.)	
Trefferlage	0.02 mm	links, 0.35 mm	hoch		
Streuwert	1.00,	horizontal: 1.03,	vertikal: 0.97		

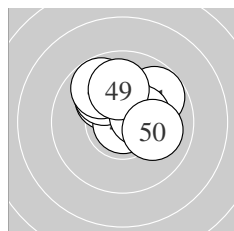

Serie 5:	9.8 ↗	10.3 *	10.4 *	10.1 ↘	10.9 *
	10.0 ↘	9.8 ↘	10.4 *	10.0 ↑	10.0 →
beste Teiler	9.4	(45.) 128.4	(43.) 135.1	(48.)	
Trefferlage	0.12 mm	rechts, 1.31 mm	hoch		
Streuwert	1.24,	horizontal: 1.41,	vertikal: 1.04		

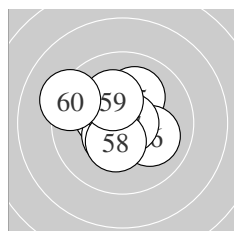

Serie 6:	10.4 *	10.5 *	10.6 *	10.7 *	10.1 ↗
	10.1 ↘	10.8 *	10.4 *	10.2 *	9.3 ↖
beste Teiler	43.0	(57.) 72.2	(54.) 97.9	(53.)	
Trefferlage	0.36 mm	links, 0.38 mm	hoch		
Streuwert	1.39,	horizontal: 1.57,	vertikal: 1.18		

Meyton Elektronik

ISSF AR Men – Wertung – Männer

StandNr: 140

Mohamad, Irwan Bin Abdul Rahman #280

StartNr: 40

23. Januar 2018 9:41

SGP

Unterschrift des Schützen

Meyton Elektronik

Ergebnis: **606.0** (581)
 Serien: 99.9 101.8 102.3 100.5 100.2 101.3
 Zähler: 41 19 0 0 0 0 0 0 0
 Innenzehner: 28
 weiteste: 450 (13), 425 (42), 382 (6)
 beste Teiler 24.5 (4.) 58.2 (24.) 62.5 (25.)
 Trefferlage 0.06 mm rechts, 0.22 mm hoch
 Streuwert 1.66, horizontal: 1.98, vertikal: 1.25

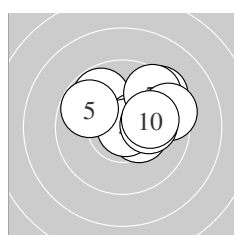
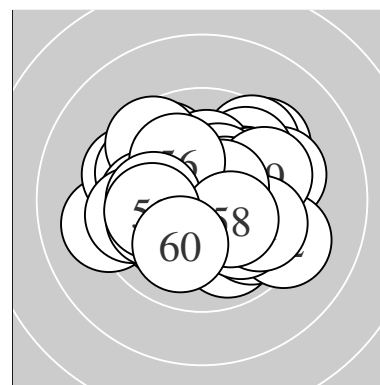

Serie 1:
 10.4 * 9.8 ↘ 10.5 * 10.9 * 9.8 ↘
 9.4 ↗ 9.5 ↗ 9.4 → 10.1 → 10.1 →
 beste Teiler 24.5 (4.) 104.2 (3.) 138.1 (1.)
 Trefferlage 1.11 mm rechts, 1.08 mm hoch
 Streuwert 1.61, horizontal: 1.97, vertikal: 1.14

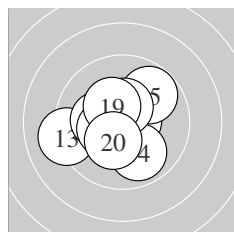

Serie 2:
 10.6 * 10.5 * 9.2 ← 9.9 ↘ 9.8 ↗
 10.2 * 10.5 * 10.4 * 10.4 * 10.3 *
 beste Teiler 80.3 (11.) 108.8 (12.) 119.8 (17.)
 Trefferlage 0.59 mm links, 0.01 mm tief
 Streuwert 1.60, horizontal: 1.80, vertikal: 1.36

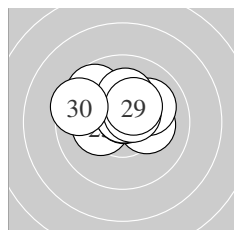

Serie 3:
 10.2 * 10.0 ↗ 10.3 * 10.7 * 10.7 *
 9.7 ↘ 10.2 * 10.6 * 10.4 * 9.5 ←
 beste Teiler 58.2 (24.) 62.5 (25.) 100.5 (28.)
 Trefferlage 0.14 mm links, 0.91 mm hoch
 Streuwert 1.37, horizontal: 1.75, vertikal: 0.84

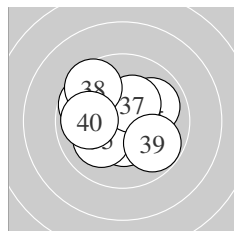

Serie 4:
 10.6 * 10.1 ↗ 10.4 * 10.0 → 10.1 ↗
 9.7 ↘ 10.3 * 9.6 ↘ 9.8 ↘ 9.9 ←
 beste Teiler 80.0 (31.) 130.3 (33.) 153.5 (37.)
 Trefferlage 0.13 mm links, 0.25 mm hoch
 Streuwert 1.75, horizontal: 2.03, vertikal: 1.43

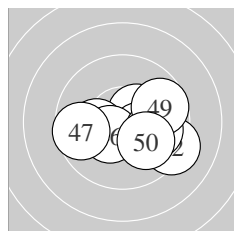

Serie 5:
 10.4 * 9.3 ↘ 10.4 * 10.4 * 10.1 ←
 10.4 * 9.6 ← 9.9 → 9.7 → 10.0 ↘
 beste Teiler 129.7 (43.) 137.1 (46.) 149.0 (44.)
 Trefferlage 0.86 mm rechts, 0.52 mm tief
 Streuwert 1.72, horizontal: 2.25, vertikal: 0.91

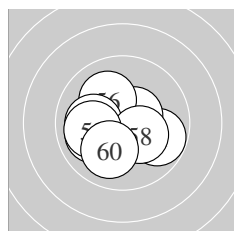

Serie 6:
 9.8 ↘ 10.0 ← 10.3 * 10.5 * 10.3 *
 10.1 ↘ 10.0 ← 10.3 * 10.0 ← 10.0 ↗
 beste Teiler 106.2 (54.) 155.5 (55.) 161.9 (58.)
 Trefferlage 0.73 mm links, 0.35 mm tief
 Streuwert 1.45, horizontal: 1.76, vertikal: 1.05

Meyton Elektronik

ISSF AR Men – Wertung – Männer

StandNr: 141

Alther, Christian #276

StartNr: 41

23. Januar 2018 9:57

SUI

Unterschrift des Schützen

Meyton Elektronik

Ergebnis: **624.5** (593)
 Serien: 104.6 103.1 104.7 103.3 104.1 104.7
 Zähler: 53 7 0 0 0 0 0 0 0 0
 Innenzehner: 50
 weiteste: 367 (37), 307 (7), 305 (14)
 beste Teiler 9.2 (6.) 9.4 (44.) 25.1 (55.)
 Trefferlage 0.38 mm links, 0.31 mm hoch
 Streuwert 1.07, horizontal: 1.31, vertikal: 0.77

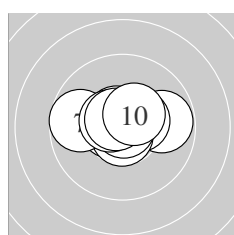
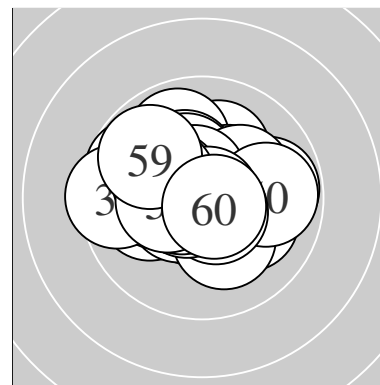

Serie 1:
 10.6 * 10.6 * 9.8 → 10.5 * 10.7 *
 10.9 * 9.7 ← 10.6 * 10.7 * 10.5 *
 beste Teiler 9.2 (6.) 56.1 (5.) 74.4 (9.)
 Trefferlage 0.08 mm links, 0.34 mm hoch
 Streuwert 1.12, horizontal: 1.53, vertikal: 0.42

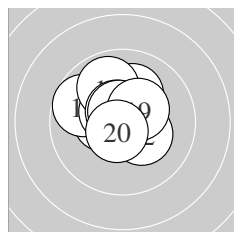

Serie 2:
 10.4 * 10.3 * 10.1 ↑ 9.7 ↖ 10.5 *
 9.9 ↘ 10.6 * 10.6 * 10.4 * 10.6 *
 beste Teiler 77.6 (20.) 81.5 (18.) 89.5 (17.)
 Trefferlage 0.40 mm links, 0.74 mm hoch
 Streuwert 1.15, horizontal: 1.25, vertikal: 1.04

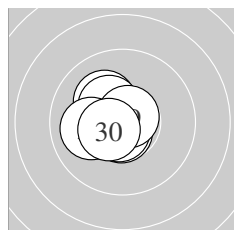

Serie 3:
 10.5 * 10.2 * 10.2 * 10.8 * 10.4 *
 10.7 * 10.0 ← 10.7 * 10.7 * 10.5 *
 beste Teiler 50.9 (24.) 54.4 (29.) 66.3 (28.)
 Trefferlage 0.82 mm links, 0.13 mm hoch
 Streuwert 0.80, horizontal: 0.81, vertikal: 0.78

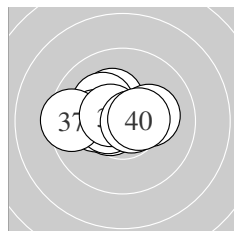

Serie 4:
 10.3 * 10.2 * 10.6 * 10.2 * 10.5 *
 10.2 * 9.5 ← 10.6 * 10.7 * 10.5 *
 beste Teiler 64.1 (39.) 93.1 (33.) 96.1 (38.)
 Trefferlage 0.68 mm links, 0.34 mm hoch
 Streuwert 1.21, horizontal: 1.60, vertikal: 0.60

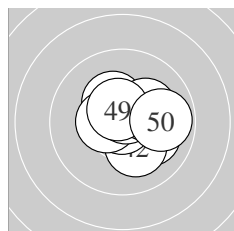

Serie 5:
 10.1 ↗ 10.2 * 10.8 * 10.9 * 10.3 *
 10.5 * 10.7 * 10.2 * 10.6 * 9.8 →
 beste Teiler 9.4 (44.) 34.8 (43.) 71.5 (47.)
 Trefferlage 0.50 mm rechts, 0.15 mm hoch
 Streuwert 1.11, horizontal: 1.27, vertikal: 0.92

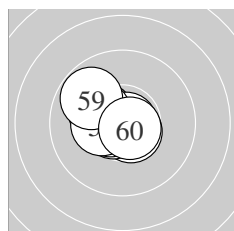

Serie 6:
 10.5 * 10.6 * 10.7 * 10.3 * 10.9 *
 10.6 * 10.2 * 10.4 * 9.8 ↖ 10.7 *
 beste Teiler 25.1 (55.) 64.4 (60.) 74.2 (53.)
 Trefferlage 0.81 mm links, 0.15 mm hoch
 Streuwert 0.86, horizontal: 0.98, vertikal: 0.71

ISSF AR Men – Wertung – Männer

StandNr: 142

Firmapaz, Facundo #146

StartNr: 42

23. Januar 2018 9:35

ARG

Unterschrift des Schützen

Meyton Elektronik

Ergebnis: **631.6** (598)^{QF}
 Serien: 104.0 105.3 106.2 106.1 105.5 104.5
 Zähler: 58 2 0 0 0 0 0 0 0 0
 Innenzehner: 57
 weiteste: 295 (43), 270 (10), 228 (52)
 beste Teiler 34.1 (49.) 35.3 (41.) 41.6 (29.)
 Trefferlage 0.16 mm rechts, 0.09 mm hoch
 Streuwert 0.83, horizontal: 0.84, vertikal: 0.83

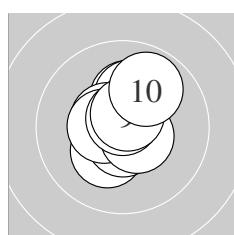
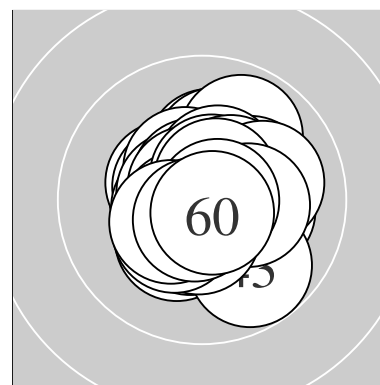

Serie 1:
 10.2 * 10.2 * 10.3 * 10.6 * 10.5 *
 10.5 * 10.5 * 10.7 * 10.6 * 9.9 ↗
 beste Teiler 53.0 (8.) 77.0 (4.) 85.0 (9.)
 Trefferlage 0.04 mm rechts, 0.50 mm hoch
 Streuwert 1.04, horizontal: 0.83, vertikal: 1.22

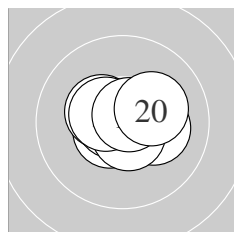

Serie 2:
 10.6 * 10.2 * 10.6 * 10.8 * 10.4 *
 10.7 * 10.6 * 10.5 * 10.7 * 10.2 *
 beste Teiler 49.2 (14.) 57.1 (16.) 59.5 (19.)
 Trefferlage 0.03 mm rechts, 0.15 mm hoch
 Streuwert 0.87, horizontal: 1.12, vertikal: 0.52

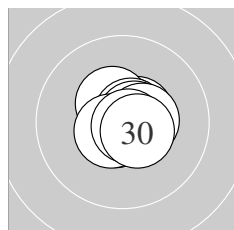

Serie 3:
 10.6 * 10.7 * 10.4 * 10.7 * 10.7 *
 10.7 * 10.6 * 10.5 * 10.8 * 10.5 *
 beste Teiler 41.6 (29.) 62.9 (22.) 63.0 (24.)
 Trefferlage 0.32 mm rechts, 0.10 mm hoch
 Streuwert 0.61, horizontal: 0.66, vertikal: 0.56

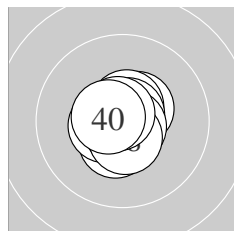

Serie 4:
 10.5 * 10.6 * 10.4 * 10.5 * 10.8 *
 10.7 * 10.7 * 10.6 * 10.7 * 10.6 *
 beste Teiler 48.4 (35.) 52.6 (37.) 53.5 (39.)
 Trefferlage 0.07 mm links, 0.06 mm tief
 Streuwert 0.66, horizontal: 0.60, vertikal: 0.72

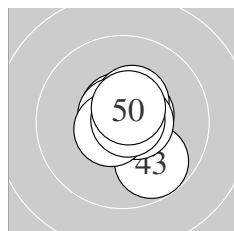

Serie 5:
 10.8 * 10.6 * 9.8 ↘ 10.6 * 10.4 *
 10.6 * 10.7 * 10.6 * 10.8 * 10.6 *
 beste Teiler 34.1 (49.) 35.3 (41.) 64.3 (47.)
 Trefferlage 0.28 mm rechts, 0.09 mm hoch
 Streuwert 0.88, horizontal: 0.76, vertikal: 0.99

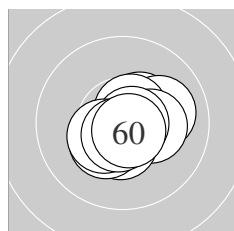

Serie 6:
 10.4 * 10.0 → 10.6 * 10.3 * 10.7 *
 10.5 * 10.3 * 10.4 * 10.6 * 10.7 *
 beste Teiler 56.0 (55.) 59.8 (60.) 76.8 (59.)
 Trefferlage 0.38 mm rechts, 0.23 mm tief
 Streuwert 0.93, horizontal: 1.07, vertikal: 0.76

Meyton Elektronik

ISSF AR Men – Wertung – Männer

StandNr: 143

Maslennikov, Vladimir #291

StartNr: 43

23. Januar 2018 9:33

RUS

QF – Schütze hat sich fürs Finale qualifiziert

Unterschrift des Schützen

Meyton Elektronik

Ergebnis: **620.9** (593)
 Serien: 103.6 103.8 104.2 103.4 103.4 102.5
 Zähler: 53 7 0 0 0 0 0 0 0
 Innenzehner: 48
 weiteste: 311 (49), 307 (33), 296 (42)
 beste Teiler 35.9 (26.) 45.1 (40.) 49.5 (50.)
 Trefferlage 0.18 mm rechts, 0.13 mm hoch
 Streuwert 1.18, horizontal: 1.35, vertikal: 0.97

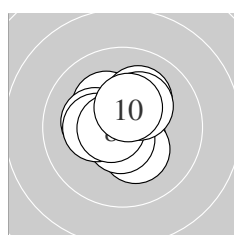
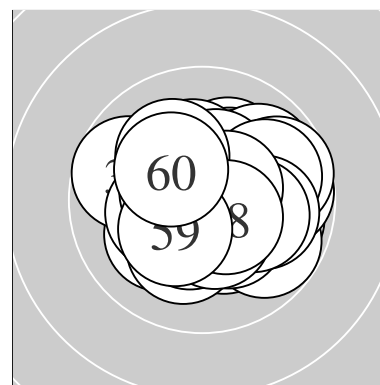

Serie 1:
 10.2 * 10.6 * 10.3 * 10.2 * 10.1 ↗
 10.6 * 10.3 * 10.7 * 10.2 * 10.4 *
 beste Teiler 75.3 (8.) 81.0 (6.) 89.3 (2.)
 Trefferlage 0.15 mm links, 0.32 mm hoch
 Streuwert 1.11, horizontal: 1.11, vertikal: 1.11

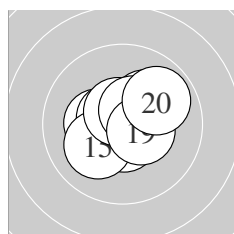

Serie 2:
 10.3 * 10.6 * 10.2 * 10.6 * 10.1 ↗
 10.6 * 10.6 * 10.5 * 10.4 * 9.9 ↗
 beste Teiler 87.0 (17.) 88.5 (12.) 90.5 (14.)
 Trefferlage 0.17 mm rechts, 0.32 mm hoch
 Streuwert 1.13, horizontal: 1.28, vertikal: 0.96

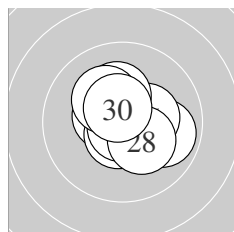

Serie 3:
 10.7 * 9.9 → 10.5 * 10.6 * 10.3 *
 10.8 * 10.3 * 10.3 * 10.2 * 10.6 *
 beste Teiler 35.9 (26.) 57.4 (21.) 86.0 (24.)
 Trefferlage 0.19 mm rechts, 0.23 mm hoch
 Streuwert 1.09, horizontal: 1.19, vertikal: 0.98

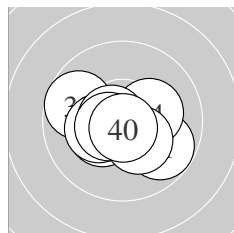

Serie 4:
 9.8 ↘ 10.7 * 9.7 ↖ 10.2 * 10.3 *
 10.3 * 10.7 * 10.6 * 10.3 * 10.8 *
 beste Teiler 45.1 (40.) 71.7 (32.) 72.8 (37.)
 Trefferlage 0.28 mm links, 0.32 mm tief
 Streuwert 1.28, horizontal: 1.63, vertikal: 0.79

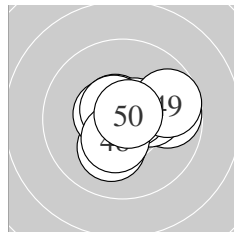

Serie 5:
 10.6 * 9.8 → 10.2 * 10.2 * 10.6 *
 10.5 * 10.6 * 10.4 * 9.7 → 10.8 *
 beste Teiler 49.5 (50.) 84.0 (41.) 84.9 (47.)
 Trefferlage 0.54 mm rechts, 0.10 mm hoch
 Streuwert 1.25, horizontal: 1.51, vertikal: 0.92

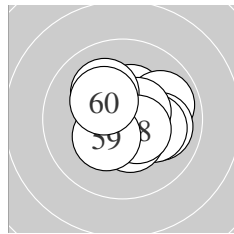

Serie 6:
 10.4 * 9.9 → 10.0 → 10.1 → 10.5 *
 10.1 ↘ 10.4 * 10.5 * 10.3 * 10.3 *
 beste Teiler 105.5 (55.) 116.0 (58.) 135.5 (57.)
 Trefferlage 0.63 mm rechts, 0.14 mm hoch
 Streuwert 1.27, horizontal: 1.42, vertikal: 1.11

Meyton Elektronik

ISSF AR Men – Wertung – **Männer**

StandNr: 144

Cipro, Adam #266

StartNr: 44

23. Januar 2018 9:36

CZE

Unterschrift des Schützen

Meyton Elektronik

Ergebnis:	609.3	(579)
Serien:	99.7	102.0 98.8 103.2 101.5 104.1
Zähler:	41	17 2 0 0 0 0 0 0 0
Innenzehner:	33	
weiteste:	614 (4), 612 (25), 479 (17)	
beste Teiler	25.3 (56.)	45.2 (45.) 54.0 (37.)
Trefferlage	0.02 mm rechts, 0.22 mm hoch	
Streuwert	1.70, horizontal: 2.19, vertikal: 1.00	

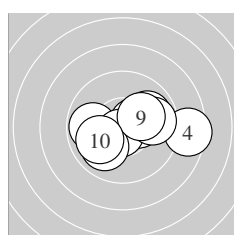
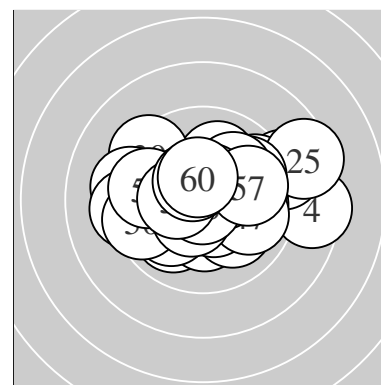

Serie 1:	10.5 *	9.9 ↗	10.3 *	8.5 →	9.8 ←
	10.7 *	10.0 ↙	9.8 →	10.2 *	10.0 ↙
beste Teiler	62.2 (6.) 115.9 (1.) 151.7 (3.)				
Trefferlage	0.86 mm rechts, 0.05 mm tief				
Streuwert	2.01, horizontal: 2.68, vertikal: 0.95				

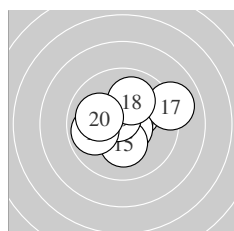

Serie 2:	10.3 *	10.6 *	10.7 *	10.7 *	10.2 *
	10.6 *	9.0 →	10.0 ↑	9.9 ←	10.0 ←
beste Teiler	68.5 (14.) 68.8 (13.) 78.8 (16.)				
Trefferlage	0.30 mm rechts, 0.45 mm hoch				
Streuwert	1.60, horizontal: 1.95, vertikal: 1.15				

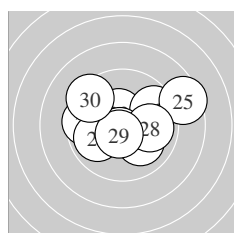

Serie 3:	9.6 ←	10.5 *	9.7 ↗	10.0 ↘	8.5 →
	10.7 *	9.9 ↙	9.9 →	10.6 *	9.4 ↘
beste Teiler	65.7 (26.) 90.2 (29.) 122.7 (22.)				
Trefferlage	0.29 mm rechts, 0.33 mm hoch				
Streuwert	2.30, horizontal: 2.91, vertikal: 1.45				

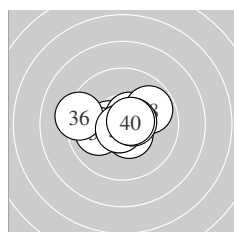

Serie 4:	10.5 *	10.4 *	10.7 *	10.0 ←	10.6 *
	9.3 ←	10.7 *	9.8 ↗	10.6 *	10.6 *
beste Teiler	54.0 (37.) 56.0 (33.) 78.4 (40.)				
Trefferlage	0.29 mm links, 0.06 mm hoch				
Streuwert	1.41, horizontal: 1.86, vertikal: 0.73				

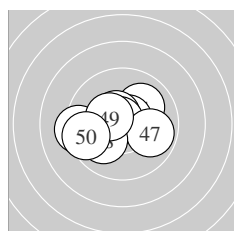

Serie 5:	10.0 ↗	9.3 ←	10.7 *	10.5 *	10.8 *
	10.4 *	9.9 →	10.0 ↙	10.4 *	9.5 ←
beste Teiler	45.2 (45.) 70.0 (43.) 107.0 (44.)				
Trefferlage	0.80 mm links, 0.04 mm hoch				
Streuwert	1.63, horizontal: 2.08, vertikal: 0.97				

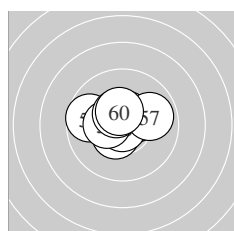

Serie 6:	10.7 *	10.5 *	10.5 *	9.7 ←	10.6 *
	10.9 *	9.9 →	10.4 *	10.5 *	10.4 *
beste Teiler	25.3 (56.) 68.0 (51.) 99.5 (55.)				
Trefferlage	0.21 mm links, 0.48 mm hoch				
Streuwert	1.15, horizontal: 1.49, vertikal: 0.67				

Meyton Elektronik

ISSF AR Men – Wertung – Männer

StandNr: 147

Insam, Fabian #297

StartNr: 45

23. Januar 2018 9:58

AUT

Unterschrift des Schützen

Meyton Elektronik

Ergebnis: **626.7** (597)^{QF}
 Serien: 103.7 105.4 105.5 103.6 103.3 105.2
 Zähler: 57 3 0 0 0 0 0 0 0 0
 Innenzehner: 47
 weiteste: 269 (35), 260 (9), 257 (17)
 beste Teiler 9.0 (20.) 19.0 (22.) 19.6 (15.)
 Trefferlage 0.03 mm links, 0.36 mm hoch
 Streuwert 0.99, horizontal: 1.02, vertikal: 0.96

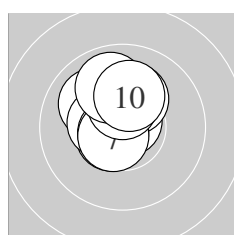
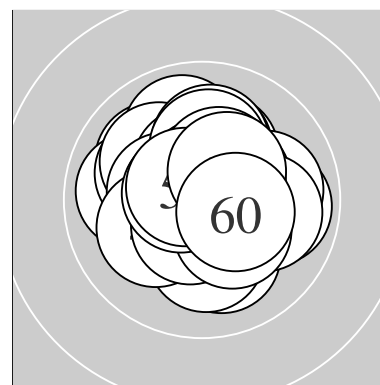

Serie 1:
 10.0 ↘ 10.6 * 10.4 * 10.8 * 10.2 *
 10.7 * 10.6 * 10.4 * 9.9 ↑ 10.1 ↑
 beste Teiler 47.1 (4.) 70.4 (6.) 81.3 (7.)
 Trefferlage 0.44 mm links, 0.84 mm hoch
 Streuwert 0.97, horizontal: 0.78, vertikal: 1.13

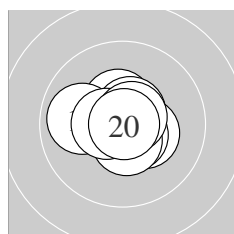

Serie 2:
 10.4 * 10.6 * 10.5 * 10.4 * 10.9 *
 10.6 * 9.9 ← 10.5 * 10.7 * 10.9 *
 beste Teiler 9.0 (20.) 19.6 (15.) 72.6 (19.)
 Trefferlage 0.04 mm links, 0.07 mm hoch
 Streuwert 0.90, horizontal: 1.08, vertikal: 0.68

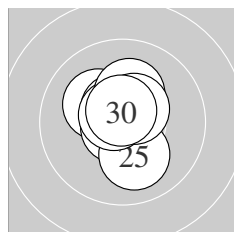

Serie 3:
 10.9 * 10.9 * 10.2 * 10.7 * 10.1 ↓
 10.6 * 10.7 * 10.2 * 10.5 * 10.7 *
 beste Teiler 19.0 (22.) 25.0 (21.) 53.9 (24.)
 Trefferlage 0.11 mm links, 0.37 mm hoch
 Streuwert 0.87, horizontal: 0.68, vertikal: 1.03

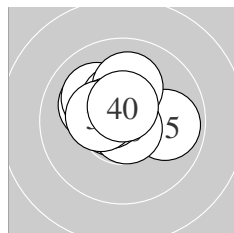

Serie 4:
 10.1 ↘ 10.1 ↘ 10.7 * 10.4 * 9.9 →
 10.7 * 10.1 ↑ 10.6 * 10.4 * 10.6 *
 beste Teiler 52.8 (36.) 66.1 (33.) 93.0 (40.)
 Trefferlage 0.34 mm links, 0.69 mm hoch
 Streuwert 1.09, horizontal: 1.31, vertikal: 0.81

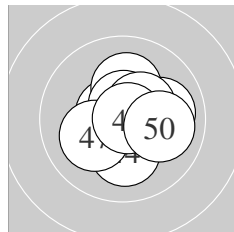

Serie 5:
 10.0 → 10.5 * 10.6 * 10.1 ↓ 10.2 *
 10.6 * 10.1 ← 10.4 * 10.8 * 10.0 →
 beste Teiler 33.3 (49.) 81.0 (43.) 83.2 (46.)
 Trefferlage 0.47 mm rechts, 0.00 mm
 Streuwert 1.19, horizontal: 1.26, vertikal: 1.12

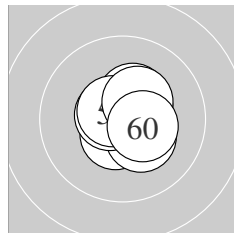

Serie 6:
 10.7 * 10.5 * 10.8 * 10.3 * 10.5 *
 10.6 * 10.4 * 10.6 * 10.4 * 10.4 *
 beste Teiler 37.0 (53.) 58.4 (51.) 80.6 (58.)
 Trefferlage 0.25 mm rechts, 0.21 mm hoch
 Streuwert 0.81, horizontal: 0.81, vertikal: 0.81

Meyton Elektronik

ISSF AR Men – Wertung – Männer

StandNr: 102

Schmir, Alexander #286

StartNr: 46

23. Januar 2018 11:44

AUT

QF – Schütze hat sich fürs Finale qualifiziert

Unterschrift des Schützen

Meyton Elektronik

Ergebnis: **617.8** (593)
 Serien: 102.3 103.1 103.3 104.5 102.1 102.5
 Zähler: 53 7 0 0 0 0 0 0 0
 Innenzehner: 40
 weiteste: 414 (2), 394 (58), 304 (59)
 beste Teiler 6.3 (60.) 46.5 (54.) 58.3 (1.)
 Trefferlage 0.06 mm rechts, 0.01 mm tief
 Streuwert 1.30, horizontal: 1.58, vertikal: 0.95

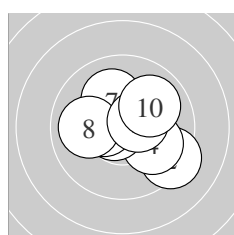
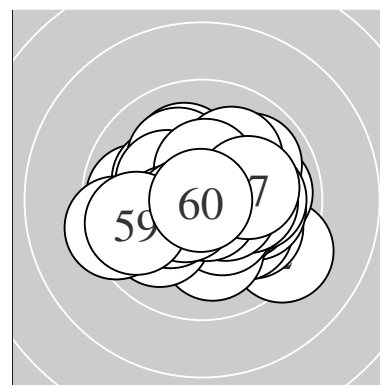

Serie 1:
 10.7 * 9.3 ↘ 10.6 * 10.0 ↘ 10.7 *
 10.4 * 10.1 ↖ 10.0 ← 10.5 * 10.0 ↗
 beste Teiler 58.3 (1.) 62.6 (5.) 98.1 (3.)
 Trefferlage 0.51 mm rechts, 0.06 mm hoch
 Streuwert 1.53, horizontal: 1.81, vertikal: 1.20

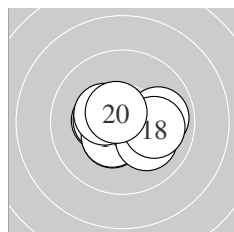

Serie 2:
 10.4 * 10.4 * 10.4 * 10.5 * 9.9 →
 10.4 * 10.1 ↘ 10.0 → 10.4 * 10.6 *
 beste Teiler 85.1 (20.) 101.2 (14.) 128.0 (16.)
 Trefferlage 0.04 mm links, 0.16 mm tief
 Streuwert 1.24, horizontal: 1.59, vertikal: 0.73

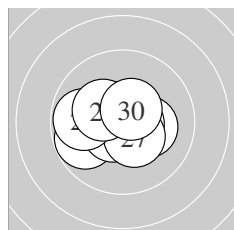

Serie 3:
 10.6 * 9.8 ← 10.5 * 10.2 * 10.6 *
 10.6 * 10.4 * 9.8 ← 10.3 * 10.5 *
 beste Teiler 78.9 (26.) 87.3 (21.) 95.4 (25.)
 Trefferlage 0.36 mm links, 0.01 mm tief
 Streuwert 1.24, horizontal: 1.58, vertikal: 0.78

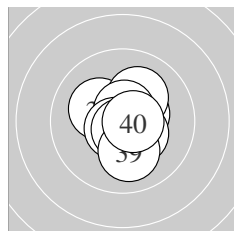

Serie 4:
 10.4 * 10.2 * 10.1 ↗ 10.7 * 10.7 *
 10.4 * 10.6 * 10.7 * 10.1 ↓ 10.6 *
 beste Teiler 59.1 (38.) 65.8 (35.) 73.9 (34.)
 Trefferlage 0.29 mm rechts, 0.06 mm tief
 Streuwert 0.99, horizontal: 0.89, vertikal: 1.09

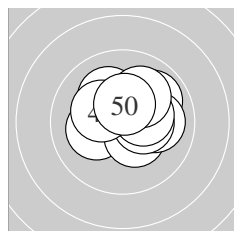

Serie 5:
 10.2 * 10.4 * 9.9 ↗ 10.1 ↖ 10.0 →
 10.4 * 10.3 * 10.3 * 10.1 ↗ 10.4 *
 beste Teiler 129.7 (50.) 136.8 (42.) 150.1 (46.)
 Trefferlage 0.52 mm rechts, 0.61 mm hoch
 Streuwert 1.29, horizontal: 1.53, vertikal: 1.00

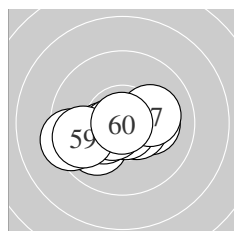

Serie 6:
 10.2 * 10.5 * 10.0 ↖ 10.8 * 10.3 *
 10.6 * 10.1 → 9.4 ← 9.7 ← 10.9 *
 beste Teiler 6.3 (60.) 46.5 (54.) 87.6 (56.)
 Trefferlage 0.54 mm links, 0.53 mm tief
 Streuwert 1.44, horizontal: 1.94, vertikal: 0.62

Meyton Elektronik

ISSF AR Men – Wertung – **Männer**

StandNr: 103

Kostenzer, Thomas #269

StartNr: 47

23. Januar 2018 11:45

T – SG Münster

Unterschrift des Schützen

Meyton Elektronik

Ergebnis: **619.2** (591)
 Serien: 102.9 104.5 104.2 103.2 102.5 101.9
 Zähler: 51 9 0 0 0 0 0 0 0 0
 Innenzehner: 43
 weiteste: 315 (33), 314 (44), 296 (57)
 beste Teiler 16.2 (11.) 17.2 (32.) 29.0 (8.)
 Trefferlage 0.02 mm links, 0.06 mm hoch
 Streuwert 1.24, horizontal: 1.40, vertikal: 1.07

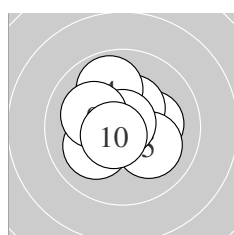
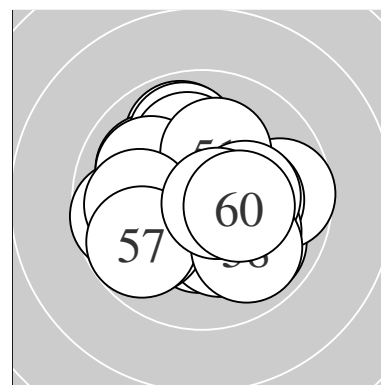

Serie 1:
 10.5 * 10.2 * 10.4 * 9.9 ↑ 10.1 ↘
 10.2 * 10.1 ↙ 10.8 * 10.1 ↖ 10.6 *
 beste Teiler 29.0 (8.) 80.7 (10.) 115.4 (1.)
 Trefferlage 0.22 mm links, 0.39 mm hoch
 Streuwert 1.30, horizontal: 1.42, vertikal: 1.17

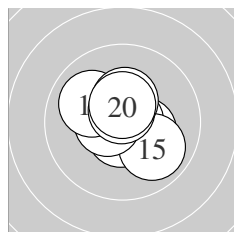

Serie 2:
 10.9 * 10.4 * 10.7 * 10.6 * 9.9 ↘
 10.5 * 10.0 ↘ 10.6 * 10.4 * 10.5 *
 beste Teiler 16.2 (11.) 52.1 (13.) 79.3 (18.)
 Trefferlage 0.08 mm rechts, 0.15 mm hoch
 Streuwert 1.07, horizontal: 1.12, vertikal: 1.00

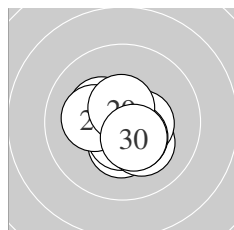

Serie 3:
 10.3 * 10.6 * 10.2 * 10.5 * 10.7 *
 10.3 * 10.2 * 10.4 * 10.6 * 10.4 *
 beste Teiler 51.4 (25.) 96.4 (29.) 100.6 (22.)
 Trefferlage 0.03 mm rechts, 0.35 mm tief
 Streuwert 1.00, horizontal: 1.05, vertikal: 0.94

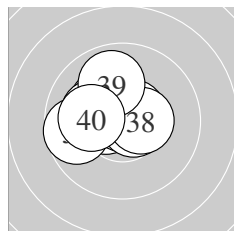

Serie 4:
 10.5 * 10.9 * 9.7 ← 10.6 * 10.2 *
 10.2 * 10.6 * 10.5 * 9.9 ↑ 10.1 ←
 beste Teiler 17.2 (32.) 76.1 (34.) 85.1 (37.)
 Trefferlage 0.76 mm links, 0.43 mm hoch
 Streuwert 1.17, horizontal: 1.41, vertikal: 0.87

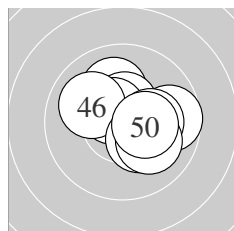

Serie 5:
 10.1 ↑ 10.7 * 10.5 * 9.7 → 10.6 *
 10.0 ↘ 10.3 * 10.2 * 10.1 ↘ 10.3 *
 beste Teiler 60.7 (42.) 100.5 (45.) 113.8 (43.)
 Trefferlage 0.64 mm rechts, 0.33 mm hoch
 Streuwert 1.31, horizontal: 1.53, vertikal: 1.05

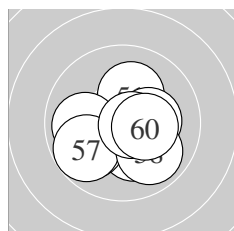

Serie 6:
 10.2 * 10.2 * 10.7 * 10.3 * 9.9 ↙
 9.9 ← 9.8 ↙ 9.9 ↘ 10.7 * 10.3 *
 beste Teiler 62.5 (59.) 66.4 (53.) 152.0 (60.)
 Trefferlage 0.05 mm rechts, 0.55 mm tief
 Streuwert 1.47, horizontal: 1.73, vertikal: 1.16

Meyton Elektronik

ISSF AR Men – Wertung – Männer

StandNr: 104

Zach, Michael #290

StartNr: 48

23. Januar 2018 11:39

VSB

Unterschrift des Schützen

Meyton Elektronik

Ergebnis:	610.2	(582)						
Serien:	102.6	102.2	101.4	99.8	100.3	103.9		
Zähler:	42	18	0	0	0	0	0	0
Innenzehner:	34							
weiteste:	398 (40), 384 (15), 371 (7)							
beste Teiler	34.0 (36.) 48.7 (5.) 50.0 (11.)							
Trefferlage	0.02 mm links, 0.17 mm hoch							
Streuwert	1.55, horizontal: 1.49, vertikal: 1.61							

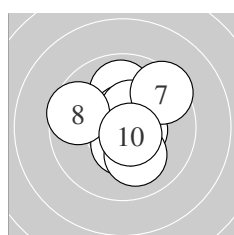
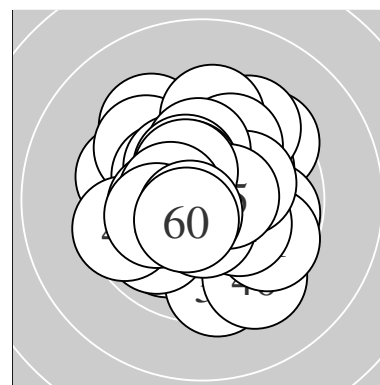

Serie 1:	9.9 ↑	10.6 *	10.5 *	10.6 *	10.8 *
	10.4 *	9.5 ↗	9.6 ↖	10.1 ↓	10.6 *
beste Teiler	48.7 (5.) 77.1 (10.) 79.2 (4.)				
Trefferlage	0.30 mm rechts, 0.41 mm hoch				
Streuwert	1.47, horizontal: 1.48, vertikal: 1.47				

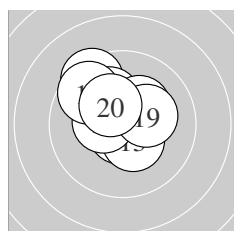

Serie 2:	10.8 *	10.7 *	10.4 *	10.4 *	9.4 ↘
	10.1 ↖	9.6 ↖	10.3 *	10.2 *	10.3 *
beste Teiler	50.0 (11.) 63.8 (12.) 136.4 (13.)				
Trefferlage	0.43 mm links, 0.93 mm hoch				
Streuwert	1.34, horizontal: 1.38, vertikal: 1.31				

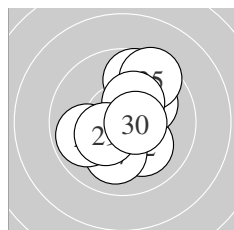

Serie 3:	9.7 ↑	10.1 ↘	10.1 ↗	10.7 *	9.5 ↗
	10.3 *	10.1 ↓	9.9 ↖	10.4 *	10.6 *
beste Teiler	59.0 (24.) 92.1 (30.) 148.4 (29.)				
Trefferlage	0.30 mm rechts, 0.26 mm hoch				
Streuwert	1.65, horizontal: 1.42, vertikal: 1.85				

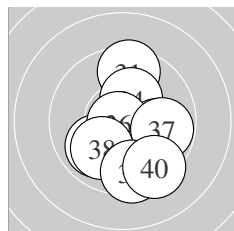

Serie 4:	9.5 ↑	9.9 ↖	10.7 *	10.3 *	9.9 →
	10.8 *	9.8 →	10.0 ↖	9.5 ↓	9.4 ↓
beste Teiler	34.0 (36.) 73.7 (33.) 168.4 (34.)				
Trefferlage	0.53 mm rechts, 0.75 mm tief				
Streuwert	1.89, horizontal: 1.61, vertikal: 2.14				

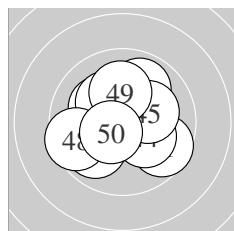

Serie 5:	9.6 ↘	9.9 ↗	10.2 *	10.2 *	10.2 *
	10.2 *	9.9 ↖	9.5 ↖	10.1 ↑	10.5 *
beste Teiler	110.5 (50.) 180.6 (46.) 189.7 (44.)				
Trefferlage	0.15 mm links, 0.11 mm hoch				
Streuwert	1.78, horizontal: 1.96, vertikal: 1.58				

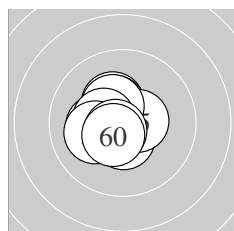

Serie 6:	10.3 *	10.5 *	10.4 *	10.2 *	10.5 *
	10.4 *	10.4 *	10.1 ↖	10.6 *	10.5 *
beste Teiler	76.4 (59.) 107.0 (55.) 109.0 (60.)				
Trefferlage	0.71 mm links, 0.07 mm hoch				
Streuwert	0.90, horizontal: 0.88, vertikal: 0.92				

Meyton Elektronik

ISSF AR Men – Wertung – **Männer**

StandNr: 105

Walder, Markus #338

StartNr: 49

23. Januar 2018 11:34

AUT

Unterschrift des Schützen

Meyton Elektronik

Ergebnis: **621.1** (595)
 Serien: 103.3 103.1 103.4 103.6 103.7 104.0
 Zähler: 55 5 0 0 0 0 0 0 0 0
 Innenzehner: 45
 weiteste: 306 (1), 301 (20), 273 (23)
 beste Teiler 8.0 (18.) 41.4 (43.) 53.9 (46.)
 Trefferlage 0.00 mm , 0.12 mm tief
 Streuwert 1.17, horizontal: 1.27, vertikal: 1.06

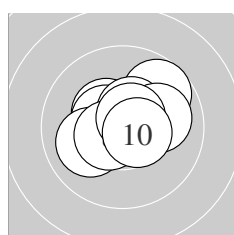
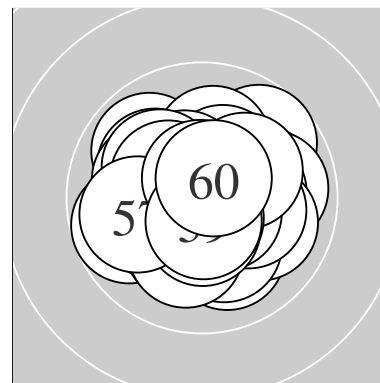

Serie 1:
 9.7 ↗ 10.4 * 10.5 * 10.5 * 10.5 *
 10.0 → 10.0 ← 10.5 * 10.6 * 10.6 *
 beste Teiler 80.0 (9.) 100.3 (10.) 103.0 (8.)
 Trefferlage 0.24 mm rechts, 0.37 mm hoch
 Streuwert 1.21, horizontal: 1.46, vertikal: 0.90

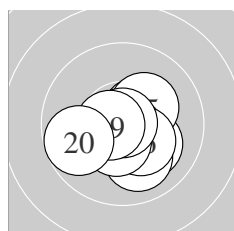

Serie 2:
 10.5 * 10.2 * 10.1 ↘ 10.0 ↘ 10.3 *
 10.3 * 10.5 * 10.9 * 10.6 * 9.7 ←
 beste Teiler 8.0 (18.) 81.3 (19.) 118.5 (17.)
 Trefferlage 0.31 mm rechts, 0.64 mm tief
 Streuwert 1.22, horizontal: 1.36, vertikal: 1.06

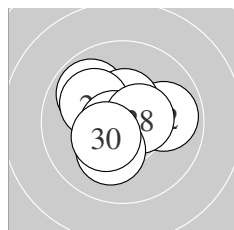

Serie 3:
 10.6 * 9.9 → 9.9 ↖ 10.5 * 10.1 ↖
 10.6 * 10.7 * 10.5 * 10.2 * 10.4 *
 beste Teiler 59.2 (27.) 80.0 (26.) 87.6 (21.)
 Trefferlage 0.35 mm links, 0.05 mm hoch
 Streuwert 1.26, horizontal: 1.38, vertikal: 1.12

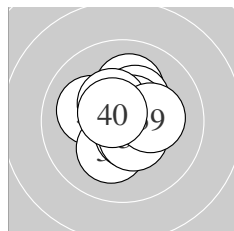

Serie 4:
 10.1 ↑ 10.1 ↖ 10.3 * 10.6 * 10.4 *
 10.2 * 10.6 * 10.5 * 10.2 * 10.6 *
 beste Teiler 85.2 (40.) 91.8 (34.) 92.6 (37.)
 Trefferlage 0.06 mm rechts, 0.32 mm hoch
 Streuwert 1.13, horizontal: 1.08, vertikal: 1.18

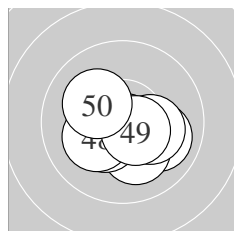

Serie 5:
 10.0 ↘ 10.5 * 10.8 * 10.2 * 10.2 *
 10.7 * 10.4 * 10.2 * 10.6 * 10.1 ↖
 beste Teiler 41.4 (43.) 53.9 (46.) 100.4 (49.)
 Trefferlage 0.10 mm rechts, 0.64 mm tief
 Streuwert 1.10, horizontal: 1.35, vertikal: 0.78

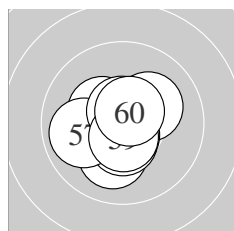

Serie 6:
 10.1 ↓ 10.5 * 10.2 * 10.4 * 10.5 *
 10.6 * 9.9 ← 10.6 * 10.6 * 10.6 *
 beste Teiler 77.4 (58.) 79.2 (56.) 88.3 (60.)
 Trefferlage 0.33 mm links, 0.23 mm tief
 Streuwert 1.08, horizontal: 1.13, vertikal: 1.03

Meyton Elektronik

ISSF AR Men – Wertung – **Männer**

StandNr: 106

Hrckulak, David #293

StartNr: 50

23. Januar 2018 11:49

CZE

Unterschrift des Schützen

Meyton Elektronik

Ergebnis:	624.9	(597)
Serien:	103.3	105.1 103.1 105.2 104.0 104.2
Zähler:	57	3 0 0 0 0 0 0 0 0
Innenzehner:	51	
weiteste:	431	(8), 341 (27), 261 (60)
beste Teiler	8.0	(11.) 26.8 (43.) 28.6 (58.)
Trefferlage	0.19 mm	rechts, 0.18 mm hoch
Streuwert	1.08,	horizontal: 1.00, vertikal: 1.16

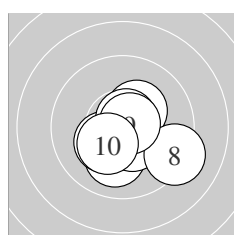
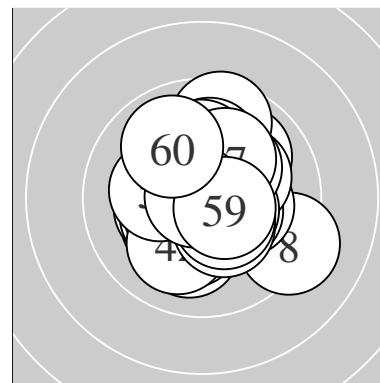

Serie 1:	10.6 *	10.1 ↓	10.3 *	10.3 *	10.7 *
	10.6 *	10.5 *	9.2 ↘	10.7 *	10.3 *
beste Teiler	58.5 (9.) 62.6 (5.) 77.0 (6.)				
Trefferlage	0.45 mm rechts, 0.63 mm tief				
Streuwert	1.27, horizontal: 1.44, vertikal: 1.09				

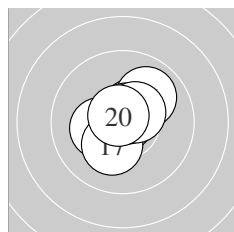

Serie 2:	10.9 *	10.5 *	10.8 *	10.3 *	10.5 *
	10.0 ↗	10.2 *	10.7 *	10.5 *	10.7 *
beste Teiler	8.0 (11.) 29.6 (13.) 57.1 (20.)				
Trefferlage	0.13 mm rechts, 0.34 mm hoch				
Streuwert	0.94, horizontal: 0.95, vertikal: 0.93				

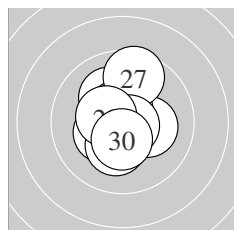

Serie 3:	10.1 ↖	10.6 *	10.3 *	10.2 *	10.2 *
	10.6 *	9.6 ↑	10.7 *	10.4 *	10.4 *
beste Teiler	52.3 (28.) 90.8 (22.) 91.0 (26.)				
Trefferlage	0.13 mm links, 0.29 mm hoch				
Streuwert	1.27, horizontal: 0.98, vertikal: 1.50				

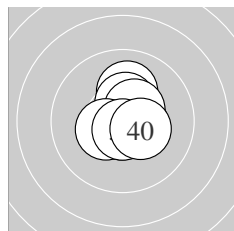

Serie 4:	10.5 *	10.7 *	10.7 *	10.1 ↑	10.4 *
	10.8 *	10.5 *	10.4 *	10.7 *	10.4 *
beste Teiler	48.6 (36.) 60.6 (33.) 61.4 (32.)				
Trefferlage	0.28 mm rechts, 0.18 mm hoch				
Streuwert	0.86, horizontal: 0.72, vertikal: 0.98				

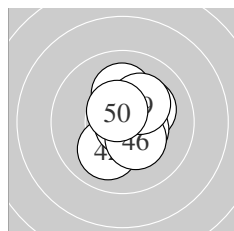

Serie 5:	10.7 *	10.1 ↓	10.8 *	10.2 *	10.5 *
	10.3 *	10.5 *	10.1 ↑	10.2 *	10.6 *
beste Teiler	26.8 (43.) 75.9 (41.) 90.3 (50.)				
Trefferlage	0.41 mm rechts, 0.28 mm hoch				
Streuwert	1.07, horizontal: 0.86, vertikal: 1.25				

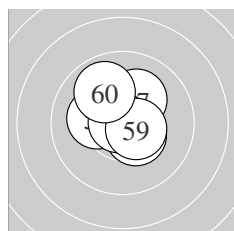

Serie 6:	10.4 *	10.5 *	10.5 *	10.2 *	10.5 *
	10.7 *	10.2 *	10.8 *	10.5 *	9.9 ↖
beste Teiler	28.6 (58.) 70.4 (56.) 108.3 (59.)				
Trefferlage	0.00 mm, 0.62 mm hoch				
Streuwert	1.01, horizontal: 1.05, vertikal: 0.96				

ISSF AR Men – Wertung – Männer

StandNr: 107

Ishchenko, Evgenii #275

StartNr: 51

23. Januar 2018 11:49

RUS

Unterschrift des Schützen

Meyton Elektronik

Ergebnis:	622.0	(594)							
Serien:	103.4	102.8	104.4	104.4	104.4	102.6			
Zähler:	54	6	0	0	0	0	0	0	0
Innenzehner:	50								
weiteste:	386 (59), 340 (53), 335 (7)								
beste Teiler	24.0 (52.)	30.0 (28.)	39.8 (4.)						
Trefferlage	0.16 mm links, 0.02 mm tief								
Streuwert	1.18, horizontal: 1.24, vertikal: 1.13								

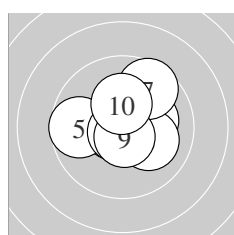
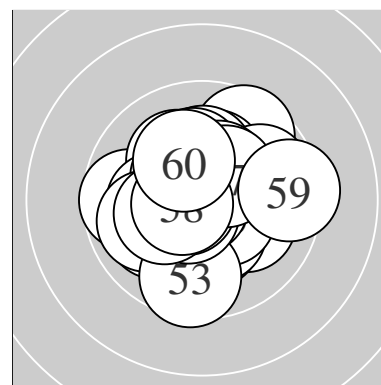

Serie 1:	10.5 *	10.2 *	10.7 *	10.8 *	9.7 ←
	10.1 ↘	9.6 ↗	10.8 *	10.7 *	10.3 *
beste Teiler	39.8 (4.) 48.7 (8.) 70.0 (3.)				
Trefferlage	0.27 mm rechts, 0.23 mm hoch				
Streuwert	1.38, horizontal: 1.56, vertikal: 1.17				

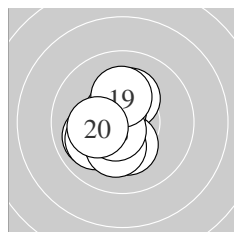

Serie 2:	10.2 *	10.5 *	10.0 ↙	10.3 *	10.6 *
	10.0 ↙	10.2 *	10.6 *	10.2 *	10.2 *
beste Teiler	79.5 (18.) 90.9 (15.) 121.3 (12.)				
Trefferlage	0.68 mm links, 0.35 mm tief				
Streuwert	1.18, horizontal: 0.98, vertikal: 1.35				

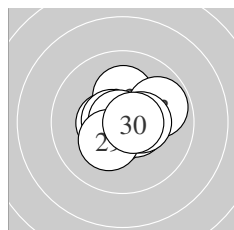

Serie 3:	10.5 *	10.2 *	9.8 ↘	10.6 *	10.6 *
	10.6 *	10.4 *	10.8 *	10.3 *	10.6 *
beste Teiler	30.0 (28.) 78.1 (30.) 80.4 (26.)				
Trefferlage	0.19 mm rechts, 0.06 mm hoch				
Streuwert	1.05, horizontal: 1.19, vertikal: 0.90				

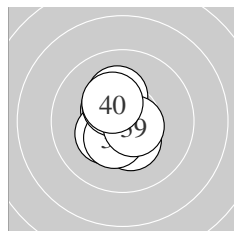

Serie 4:	10.2 *	10.5 *	10.6 *	10.3 *	10.3 *
	10.8 *	10.4 *	10.4 *	10.6 *	10.3 *
beste Teiler	46.5 (36.) 89.0 (39.) 98.0 (33.)				
Trefferlage	0.29 mm links, 0.02 mm tief				
Streuwert	0.96, horizontal: 0.67, vertikal: 1.18				

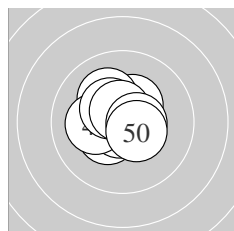

Serie 5:	10.4 *	10.5 *	10.4 *	10.1 ↖	10.8 *
	10.2 *	10.4 *	10.6 *	10.5 *	10.5 *
beste Teiler	45.6 (45.) 84.4 (48.) 102.3 (49.)				
Trefferlage	0.18 mm links, 0.22 mm hoch				
Streuwert	0.99, horizontal: 1.08, vertikal: 0.90				

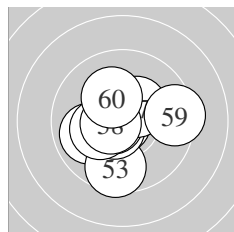

Serie 6:	9.9 ↙	10.9 *	9.6 ↓	10.6 *	10.7 *
	10.3 *	10.4 *	10.6 *	9.4 →	10.2 *
beste Teiler	24.0 (52.) 74.4 (55.) 82.0 (54.)				
Trefferlage	0.28 mm links, 0.27 mm tief				
Streuwert	1.54, horizontal: 1.70, vertikal: 1.35				

Meyton Elektronik

ISSF AR Men – Wertung – **Männer**

StandNr: 108

Blamauer, Nikolaus #341

StartNr: 52

23. Januar 2018 11:27

OÖ – ASKÖ Bad Goisern

Unterschrift des Schützen

Meyton Elektronik

Ergebnis: **617.5** (591)
 Serien: 104.1 102.8 102.2 103.4 103.3 101.7
 Zähler: 51 9 0 0 0 0 0 0 0 0
 Innenzehner: 41
 weiteste: 375 (60), 341 (59), 318 (6)
 beste Teiler 28.1 (31.) 37.8 (29.) 38.3 (49.)
 Trefferlage 0.36 mm rechts, 0.09 mm hoch
 Streuwert 1.27, horizontal: 1.37, vertikal: 1.16

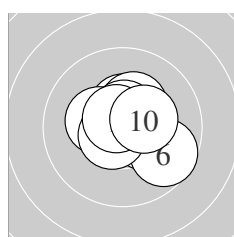
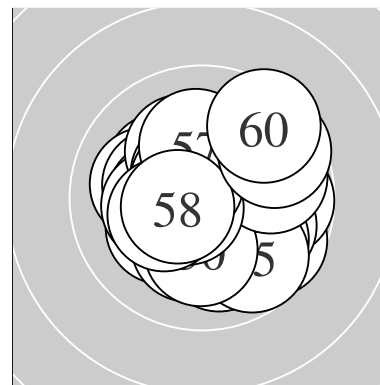

Serie 1:
 10.3 * 10.4 * 10.3 * 10.3 * 10.6 *
 9.7 ↘ 10.8 * 10.6 * 10.7 * 10.4 *
 beste Teiler 48.0 (7.) 69.4 (9.) 86.4 (5.)
 Trefferlage 0.33 mm rechts, 0.22 mm hoch
 Streuwert 1.11, horizontal: 1.26, vertikal: 0.95

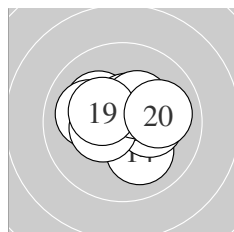

Serie 2:
 10.2 * 10.0 ← 10.7 * 10.1 ↘ 10.2 *
 10.5 * 10.4 * 10.4 * 10.3 * 10.0 →
 beste Teiler 64.6 (13.) 101.6 (16.) 134.4 (17.)
 Trefferlage 0.04 mm links, 0.23 mm hoch
 Streuwert 1.29, horizontal: 1.57, vertikal: 0.94

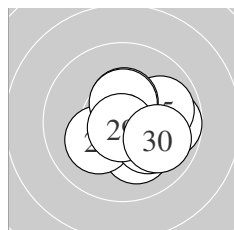

Serie 3:
 9.8 → 10.1 ↘ 10.6 * 10.2 * 9.9 →
 10.1 ↘ 10.4 * 10.4 * 10.8 * 9.9 ↘
 beste Teiler 37.8 (29.) 86.2 (23.) 126.0 (28.)
 Trefferlage 0.94 mm rechts, 0.17 mm tief
 Streuwert 1.28, horizontal: 1.41, vertikal: 1.13

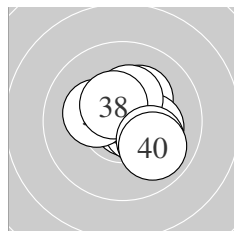

Serie 4:
 10.8 * 10.2 * 10.5 * 10.2 * 10.7 *
 10.3 * 10.2 * 10.5 * 10.1 ↘ 9.9 ↘
 beste Teiler 28.1 (31.) 75.0 (35.) 105.1 (33.)
 Trefferlage 0.60 mm rechts, 0.14 mm hoch
 Streuwert 1.13, horizontal: 1.18, vertikal: 1.08

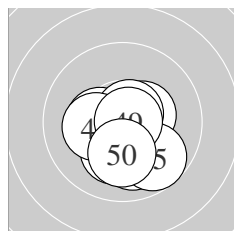

Serie 5:
 10.4 * 10.0 ↘ 10.4 * 10.8 * 9.7 ↘
 10.2 * 10.7 * 10.2 * 10.8 * 10.1 ↓
 beste Teiler 38.3 (49.) 44.1 (44.) 71.0 (47.)
 Trefferlage 0.08 mm rechts, 0.80 mm tief
 Streuwert 1.16, horizontal: 1.15, vertikal: 1.16

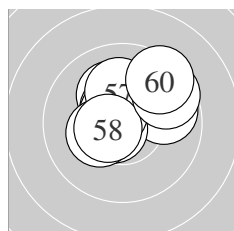

Serie 6:
 10.1 ↖ 10.5 * 9.8 → 10.7 * 10.6 *
 10.3 * 10.1 ↑ 10.5 * 9.6 → 9.5 ↗
 beste Teiler 72.1 (54.) 88.5 (55.) 103.1 (58.)
 Trefferlage 0.27 mm rechts, 0.96 mm hoch
 Streuwert 1.46, horizontal: 1.69, vertikal: 1.19

Meyton Elektronik

ISSF AR Men – Wertung – **Männer**

StandNr: 109

Rumpler, Stefan #274

StartNr: 53

23. Januar 2018 11:47

AUT

Unterschrift des Schützen

Meyton Elektronik

Ergebnis:	625.4	(596) ^{QF}							
Serien:	105.0	104.4	104.3	104.6	104.7	102.4			
Zähler:	56	4	0	0	0	0	0	0	0
Innenzehner:	47								
weiteste:	301 (17), 297 (56), 263 (49)								
beste Teiler	19.7 (5.) 20.3 (11.) 21.4 (26.)								
Trefferlage	0.01 mm rechts, 0.20 mm hoch								
Streuwert	1.06, horizontal: 1.13, vertikal: 0.99								

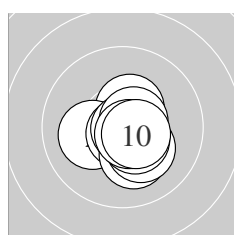
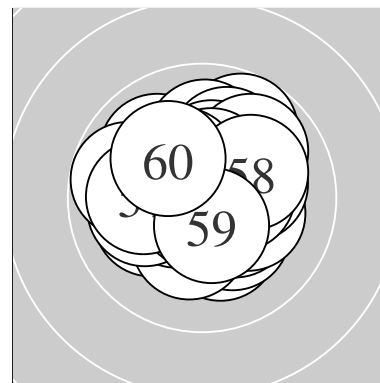

Serie 1:	10.4 *	10.1 ←	10.8 *	10.2 *	10.9 *
	10.6 *	10.2 *	10.5 *	10.7 *	10.6 *
beste Teiler	19.7 (5.) 43.3 (3.) 61.5 (9.)				
Trefferlage	0.32 mm rechts, 0.42 mm tief				
Streuwert	0.86, horizontal: 0.88, vertikal: 0.83				

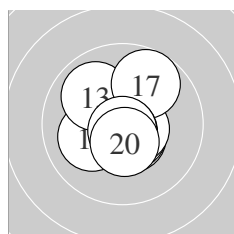

Serie 2:	10.9 *	10.1 ←	9.9 ↖	10.5 *	10.6 *
	10.6 *	9.7 ↗	10.8 *	10.8 *	10.5 *
beste Teiler	20.3 (11.) 44.0 (19.) 49.0 (18.)				
Trefferlage	0.01 mm rechts, 0.03 mm tief				
Streuwert	1.17, horizontal: 1.09, vertikal: 1.24				

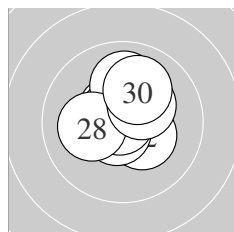

Serie 3:	10.7 *	10.3 *	10.7 *	10.6 *	10.7 *
	10.9 *	10.0 ↑	10.1 ←	10.3 *	10.0 ↗
beste Teiler	21.4 (26.) 53.1 (21.) 68.7 (23.)				
Trefferlage	0.02 mm links, 0.46 mm hoch				
Streuwert	1.06, horizontal: 1.00, vertikal: 1.12				

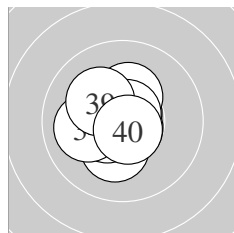

Serie 4:	10.2 *	10.7 *	10.5 *	10.0 ←	10.7 *
	10.6 *	10.3 *	10.7 *	10.2 *	10.7 *
beste Teiler	52.8 (38.) 58.1 (35.) 61.0 (32.)				
Trefferlage	0.33 mm links, 0.10 mm hoch				
Streuwert	0.97, horizontal: 0.93, vertikal: 1.00				

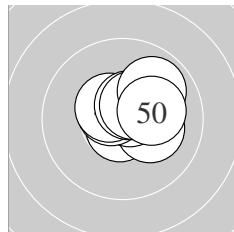

Serie 5:	10.8 *	10.7 *	10.2 *	10.7 *	10.6 *
	10.5 *	10.6 *	10.5 *	9.9 ↗	10.2 *
beste Teiler	45.0 (41.) 56.6 (42.) 64.3 (44.)				
Trefferlage	0.54 mm rechts, 0.51 mm hoch				
Streuwert	0.88, horizontal: 1.04, vertikal: 0.70				

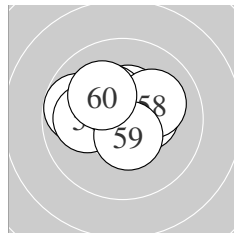

Serie 6:	10.4 *	10.2 *	10.4 *	10.5 *	10.4 *
	9.8 ←	10.0 ←	10.1 ↗	10.5 *	10.1 ↖
beste Teiler	102.0 (54.) 114.1 (59.) 130.7 (51.)				
Trefferlage	0.43 mm links, 0.60 mm hoch				
Streuwert	1.28, horizontal: 1.64, vertikal: 0.77				

Meyton Elektronik

ISSF AR Men – Wertung – **Männer**

StandNr: 110

Sampson, Dane #337

StartNr: 54

23. Januar 2018 11:47

AUS

QF – Schütze hat sich fürs Finale qualifiziert

Unterschrift des Schützen

Meyton Elektronik

Ergebnis:	622.4	(594)							
Serien:	103.5	104.4	104.2	103.3	103.5	103.5			
Zähler:	54	6	0	0	0	0	0	0	0
Innenzehner:	49								
weiteste:	307 (10), 288 (35), 268 (49)								
beste Teiler	9.2 (13.)	49.8 (15.)	55.4 (11.)						
Trefferlage	0.09 mm rechts, 0.08 mm tief								
Streuwert	1.12, horizontal: 1.08, vertikal: 1.16								

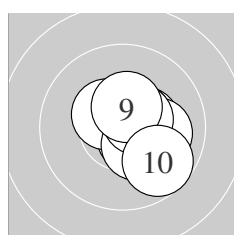
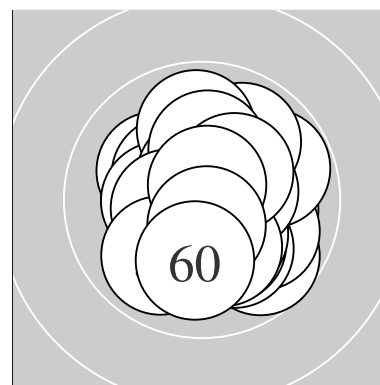

Serie 1:	10.5 *	10.6 *	10.4 *	10.4 *	10.1 →
	10.5 *	10.4 *	10.5 *	10.4 *	9.7 ↘
beste Teiler	86.9 (2.) 104.8 (6.) 107.7 (8.)				
Trefferlage	0.84 mm rechts, 0.02 mm hoch				
Streuwert	1.02, horizontal: 0.96, vertikal: 1.08				

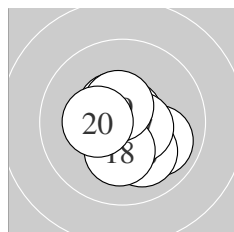

Serie 2:	10.7 *	9.9 ↘	10.9 *	10.5 *	10.8 *
	10.1 ↘	10.5 *	10.2 *	10.5 *	10.3 *
beste Teiler	9.2 (13.) 49.8 (15.) 55.4 (11.)				
Trefferlage	0.19 mm rechts, 0.33 mm tief				
Streuwert	1.04, horizontal: 1.06, vertikal: 1.01				

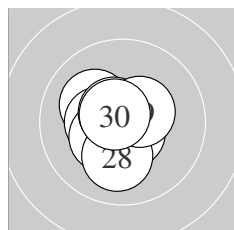

Serie 3:	10.6 *	10.4 *	10.1 ↖	10.5 *	10.4 *
	10.4 *	10.6 *	10.1 ↓	10.4 *	10.7 *
beste Teiler	69.3 (30.) 79.6 (21.) 82.0 (27.)				
Trefferlage	0.66 mm links, 0.09 mm tief				
Streuwert	0.92, horizontal: 0.89, vertikal: 0.94				

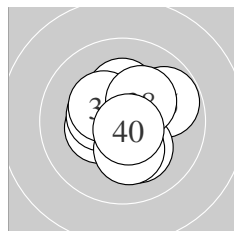

Serie 4:	10.7 *	10.4 *	10.3 *	10.4 *	9.8 →
	10.3 *	10.2 *	10.3 *	10.2 *	10.7 *
beste Teiler	64.6 (40.) 74.0 (31.) 136.5 (34.)				
Trefferlage	0.12 mm rechts, 0.03 mm hoch				
Streuwert	1.26, horizontal: 1.27, vertikal: 1.24				

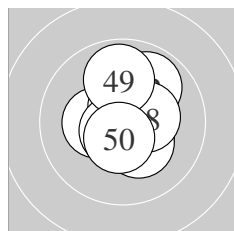

Serie 5:	10.4 *	9.9 ↗	10.5 *	10.3 *	10.6 *
	10.7 *	10.3 *	10.4 *	9.9 ↑	10.5 *
beste Teiler	75.0 (46.) 98.1 (45.) 102.3 (50.)				
Trefferlage	0.12 mm rechts, 0.23 mm hoch				
Streuwert	1.22, horizontal: 1.08, vertikal: 1.35				

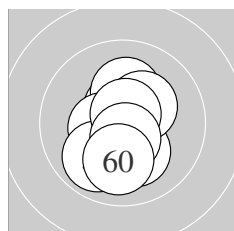

Serie 6:	10.6 *	10.6 *	10.2 *	10.2 *	10.3 *
	10.4 *	9.9 ↙	10.7 *	10.6 *	10.0 ↓
beste Teiler	60.0 (58.) 90.0 (51.) 94.8 (52.)				
Trefferlage	0.03 mm links, 0.38 mm tief				
Streuwert	1.19, horizontal: 0.85, vertikal: 1.46				

ISSF AR Men – Wertung – Männer

StandNr: 111

Höllwarth, Michael #278

StartNr: 55

23. Januar 2018 11:44

AUT

Unterschrift des Schützen

Meyton Elektronik

Ergebnis: **621.1** (591)
 Serien: 103.0 103.8 103.4 104.9 104.1 101.9
 Zähler: 51 9 0 0 0 0 0 0 0 0
 Innenzehner: 40
 weiteste: 347 (58), 307 (55), 300 (4)
 beste Teiler 25.3 (28.) 27.0 (34.) 34.0 (24.)
 Trefferlage 0.00 mm , 0.29 mm hoch
 Streuwert 1.22, horizontal: 1.25, vertikal: 1.18

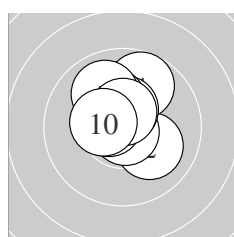
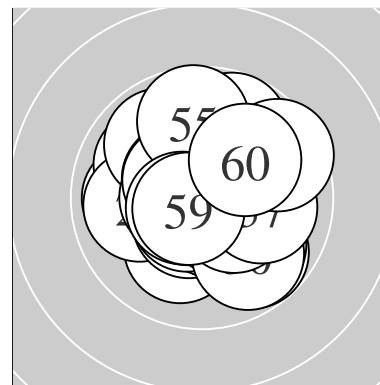

Serie 1:
 10.1 ↗ 10.1 ↘ 10.8 * 9.8 ↗ 10.5 *
 10.2 * 10.0 ↖ 10.6 * 10.5 * 10.4 *
 beste Teiler 35.5 (3.) 96.4 (8.) 101.0 (9.)
 Trefferlage 0.14 mm links, 1.00 mm hoch
 Streuwert 1.14, horizontal: 1.02, vertikal: 1.25

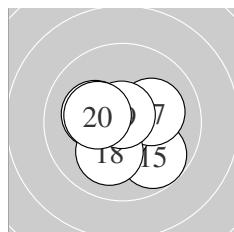

Serie 2:
 10.7 * 10.6 * 10.5 * 10.2 * 9.8 ↘
 10.7 * 10.1 → 10.1 ↓ 10.8 * 10.3 *
 beste Teiler 49.4 (19.) 61.1 (11.) 61.4 (16.)
 Trefferlage 0.08 mm links, 0.25 mm tief
 Streuwert 1.21, horizontal: 1.35, vertikal: 1.05

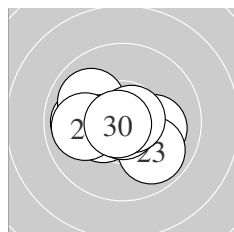

Serie 3:
 10.1 → 9.9 ← 9.9 ↘ 10.8 * 10.0 ↖
 10.4 * 9.9 ← 10.9 * 10.7 * 10.8 *
 beste Teiler 25.3 (28.) 34.0 (24.) 34.5 (30.)
 Trefferlage 0.38 mm links, 0.18 mm tief
 Streuwert 1.32, horizontal: 1.69, vertikal: 0.78

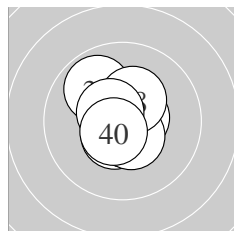

Serie 4:
 10.6 * 9.9 ↖ 10.6 * 10.8 * 10.5 *
 10.6 * 10.5 * 10.3 * 10.5 * 10.6 *
 beste Teiler 27.0 (34.) 87.2 (31.) 87.5 (36.)
 Trefferlage 0.15 mm links, 0.19 mm hoch
 Streuwert 0.94, horizontal: 0.79, vertikal: 1.07

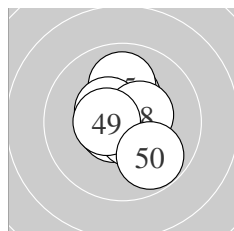

Serie 5:
 10.6 * 10.7 * 10.6 * 10.3 * 10.0 ↑
 10.5 * 10.6 * 10.5 * 10.5 * 9.8 ↘
 beste Teiler 73.6 (42.) 88.2 (41.) 90.7 (43.)
 Trefferlage 0.03 mm links, 0.23 mm hoch
 Streuwert 1.15, horizontal: 0.99, vertikal: 1.29

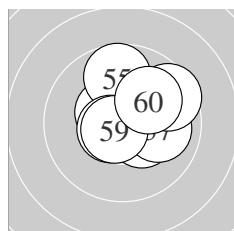

Serie 6:
 10.5 * 10.4 * 10.3 * 10.1 ↑ 9.7 ↑
 10.6 * 10.0 → 9.6 ↗ 10.7 * 10.0 ↗
 beste Teiler 69.0 (59.) 89.4 (56.) 117.8 (51.)
 Trefferlage 0.75 mm rechts, 0.78 mm hoch
 Streuwert 1.35, horizontal: 1.42, vertikal: 1.28

ISSF AR Men – Wertung – Männer

StandNr: 112

Golovkov, Andrei #273

StartNr: 56

23. Januar 2018 11:39

RUS

Unterschrift des Schützen

Meyton Elektronik

Ergebnis: **620.2** (594)
 Serien: 102.2 105.0 104.8 102.3 102.2 103.7
 Zähler: 54 6 0 0 0 0 0 0 0 0
 Innenzehner: 41
 weiteste: 306 (6), 286 (53), 268 (57)
 beste Teiler 15.0 (27.) 18.1 (25.) 30.8 (54.)
 Trefferlage 0.00 mm , 0.02 mm tief
 Streuwert 1.22, horizontal: 1.34, vertikal: 1.09

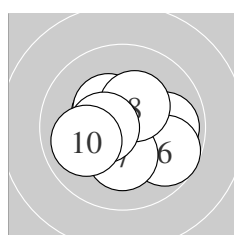
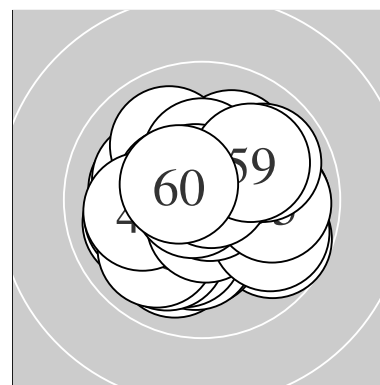

Serie 1:
 10.4 * 10.4 * 10.1 → 9.9 → 10.7 *
 9.7 ↘ 10.2 * 10.3 * 10.5 * 10.0 ←
 beste Teiler 65.9 (5.) 118.0 (9.) 128.2 (1.)
 Trefferlage 0.32 mm rechts, 0.05 mm tief
 Streuwert 1.43, horizontal: 1.72, vertikal: 1.05

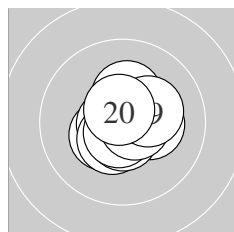

Serie 2:
 10.4 * 10.3 * 10.7 * 10.5 * 10.6 *
 10.3 * 10.7 * 10.6 * 10.3 * 10.6 *
 beste Teiler 68.3 (17.) 69.0 (13.) 78.4 (18.)
 Trefferlage 0.14 mm rechts, 0.06 mm tief
 Streuwert 0.91, horizontal: 0.95, vertikal: 0.86

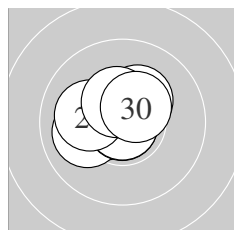

Serie 3:
 10.7 * 10.3 * 10.6 * 10.0 ← 10.9 *
 10.5 * 10.9 * 10.1 ← 10.4 * 10.4 *
 beste Teiler 15.0 (27.) 18.1 (25.) 59.0 (21.)
 Trefferlage 0.31 mm links, 0.43 mm hoch
 Streuwert 0.93, horizontal: 1.12, vertikal: 0.69

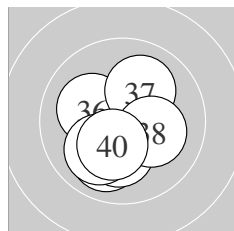

Serie 4:
 10.5 * 10.4 * 10.0 ↙ 10.2 * 10.5 *
 10.1 ↖ 10.1 ↗ 10.2 * 10.0 ↘ 10.3 *
 beste Teiler 104.6 (31.) 117.2 (35.) 141.4 (32.)
 Trefferlage 0.52 mm links, 0.65 mm tief
 Streuwert 1.25, horizontal: 1.15, vertikal: 1.35

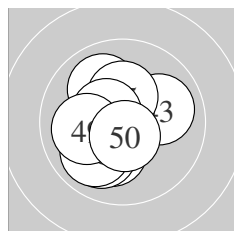

Serie 5:
 10.7 * 10.2 * 10.0 → 10.0 ↖ 10.3 *
 10.0 ↙ 10.5 * 9.9 ↙ 10.0 ← 10.6 *
 beste Teiler 55.5 (41.) 90.0 (50.) 114.4 (47.)
 Trefferlage 0.56 mm links, 0.14 mm tief
 Streuwert 1.38, horizontal: 1.30, vertikal: 1.47

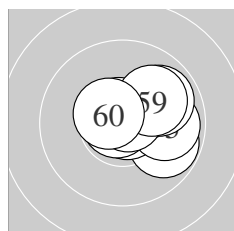

Serie 6:
 10.7 * 10.6 * 9.8 ↘ 10.8 * 9.9 →
 10.8 * 9.9 ↗ 10.7 * 10.0 ↗ 10.5 *
 beste Teiler 30.8 (54.) 35.2 (56.) 54.6 (58.)
 Trefferlage 0.91 mm rechts, 0.35 mm hoch
 Streuwert 1.08, horizontal: 1.31, vertikal: 0.77

Meyton Elektronik

ISSF AR Men – Wertung – Männer

StandNr: 113

Rumpler, Gernot #268

StartNr: 57

23. Januar 2018 11:29

AUT

Unterschrift des Schützen

Meyton Elektronik

Ergebnis: **619.7** (594)
 Serien: 103.3 102.8 102.0 103.8 103.8 104.0
 Zähler: 54 6 0 0 0 0 0 0 0 0
 Innenzehner: 46
 weiteste: 431 (23), 290 (29), 285 (32)
 beste Teiler 37.4 (46.) 38.0 (14.) 46.0 (43.)
 Trefferlage 0.20 mm links, 0.02 mm hoch
 Streuwert 1.22, horizontal: 1.40, vertikal: 1.01

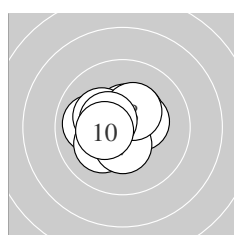
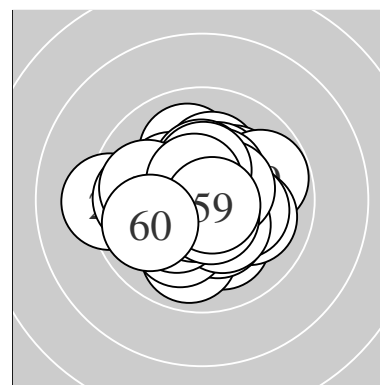

Serie 1:
 10.4 * 10.4 * 10.5 * 10.0 ← 10.2 *
 10.1 ↙ 10.4 * 10.4 * 10.5 * 10.4 *
 beste Teiler 111.1 (3.) 123.9 (9.) 136.0 (7.)
 Trefferlage 0.48 mm links, 0.24 mm hoch
 Streuwert 1.14, horizontal: 1.30, vertikal: 0.94

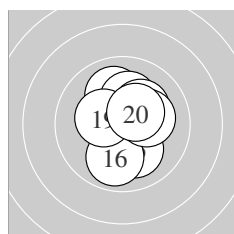

Serie 2:
 10.0 ↑ 10.7 * 10.2 * 10.8 * 10.1 ↓
 9.9 ↓ 10.2 * 10.2 * 10.3 * 10.4 *
 beste Teiler 38.0 (14.) 71.0 (12.) 136.6 (20.)
 Trefferlage 0.19 mm rechts, 0.23 mm hoch
 Streuwert 1.33, horizontal: 1.08, vertikal: 1.54

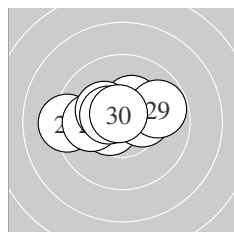

Serie 3:
 10.4 * 10.3 * 9.2 ← 10.5 * 10.0 ←
 10.3 * 10.3 * 10.5 * 9.8 → 10.7 *
 beste Teiler 72.4 (30.) 105.6 (24.) 122.0 (28.)
 Trefferlage 0.44 mm links, 0.52 mm hoch
 Streuwert 1.51, horizontal: 2.07, vertikal: 0.55

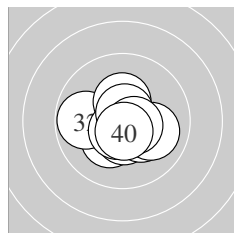

Serie 4:
 10.3 * 9.8 ← 10.5 * 10.4 * 10.3 *
 10.6 * 10.0 → 10.7 * 10.6 * 10.6 *
 beste Teiler 65.9 (38.) 79.7 (40.) 83.7 (36.)
 Trefferlage 0.05 mm rechts, 0.39 mm tief
 Streuwert 1.16, horizontal: 1.37, vertikal: 0.89

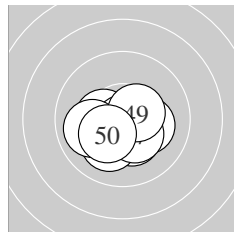

Serie 5:
 10.2 * 10.3 * 10.8 * 10.1 ↘ 10.4 *
 10.8 * 10.4 * 10.0 ← 10.5 * 10.3 *
 beste Teiler 37.4 (46.) 46.0 (43.) 116.3 (49.)
 Trefferlage 0.13 mm links, 0.70 mm tief
 Streuwert 1.06, horizontal: 1.32, vertikal: 0.70

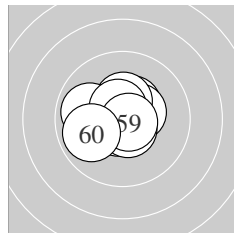

Serie 6:
 10.4 * 10.4 * 10.4 * 10.4 * 9.9 ←
 10.7 * 10.6 * 10.6 * 10.7 * 9.9 ←
 beste Teiler 53.2 (59.) 72.9 (56.) 85.9 (57.)
 Trefferlage 0.42 mm links, 0.21 mm hoch
 Streuwert 1.09, horizontal: 1.29, vertikal: 0.84

Meyton Elektronik

ISSF AR Men – Wertung – Männer

StandNr: 114

Lochbihler, Jan #267

StartNr: 58

23. Januar 2018 11:30

SUI

Unterschrift des Schützen

Meyton Elektronik

Ergebnis:	596.6	(569)
Serien:	100.3	100.1 97.5 98.5 99.9 100.3
Zähler:	35	19 6 0 0 0 0 0 0 0
Innenzehner:	26	
weiteste:	683	(48), 678 (22), 634 (25)
beste Teiler	42.4	(36.) 47.0 (7.) 48.2 (50.)
Trefferlage	0.13 mm	rechts, 0.37 mm hoch
Streuwert	2.13,	horizontal: 2.62, vertikal: 1.48

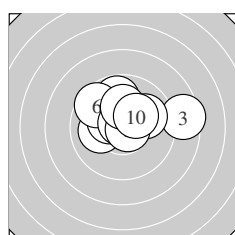
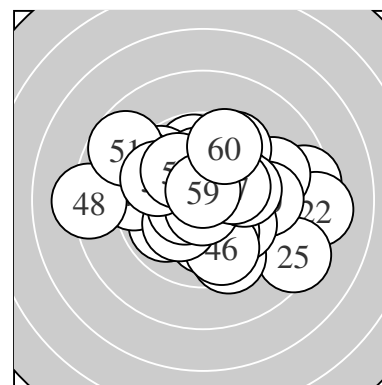

Serie 1:

9.8 ↑	10.1 ←	8.5 →	10.4 *	10.0 ↗
9.6 ↘	10.8 *	10.7 *	10.1 ↑	10.3 *

beste Teiler 47.0 (7.) 54.7 (8.) 143.2 (4.)
 Trefferlage 0.32 mm rechts, 1.07 mm hoch
 Streuwert 1.91, horizontal: 2.49, vertikal: 1.04

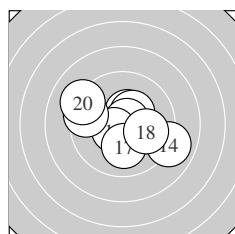

Serie 2:

10.6 *	10.4 *	10.4 *	8.9 ↘	10.7 *
10.5 *	10.1 ↓	10.0 →	9.4 ←	9.1 ↘

beste Teiler 52.8 (15.) 96.7 (11.) 104.2 (16.)
 Trefferlage 0.05 mm links, 0.00 mm
 Streuwert 2.07, horizontal: 2.56, vertikal: 1.42

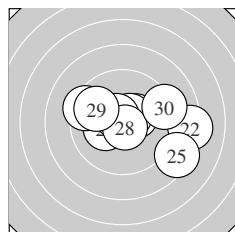

Serie 3:

10.2 *	8.2 →	9.4 ↘	10.4 *	8.4 ↘
10.6 *	10.6 *	10.7 *	9.8 ↘	9.2 →

beste Teiler 58.6 (28.) 85.5 (27.) 93.5 (26.)
 Trefferlage 0.99 mm rechts, 0.10 mm hoch
 Streuwert 2.66, horizontal: 3.48, vertikal: 1.45

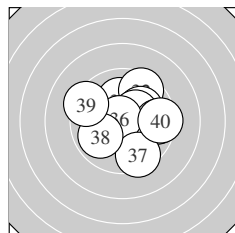

Serie 4:

10.1 ↑	9.5 ↗	10.1 ↗	10.3 *	9.6 →
10.8 *	9.5 ↓	9.9 ↖	9.3 ↘	9.4 →

beste Teiler 42.4 (36.) 155.0 (34.) 212.2 (31.)
 Trefferlage 0.72 mm rechts, 0.44 mm hoch
 Streuwert 2.12, horizontal: 2.36, vertikal: 1.84

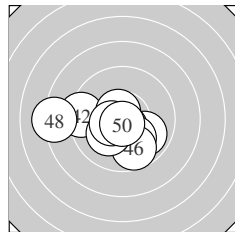

Serie 5:

9.9 ↘	9.3 ←	10.6 *	10.6 *	10.1 ↓
9.7 ↓	10.2 *	8.2 ←	10.5 *	10.8 *

beste Teiler 48.2 (50.) 84.2 (44.) 84.9 (43.)
 Trefferlage 0.93 mm links, 0.82 mm tief
 Streuwert 2.06, horizontal: 2.70, vertikal: 1.10

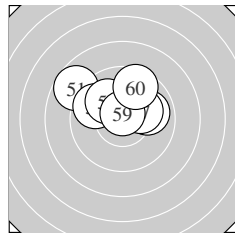

Serie 6:

8.7 ↘	10.6 *	9.9 →	10.5 *	9.8 ↘
10.3 *	10.2 *	10.0 ↘	10.7 *	9.6 ↑

beste Teiler 57.0 (59.) 81.1 (52.) 106.2 (54.)
 Trefferlage 0.27 mm links, 1.44 mm hoch
 Streuwert 1.68, horizontal: 2.17, vertikal: 0.96

ISSF AR Men – Wertung – Männer

StandNr: 115

Mattle, Michael #336

StartNr: 59

23. Januar 2018 11:44

VLSV

Unterschrift des Schützen

Meyton Elektronik

Ergebnis: **617.3** (587)
 Serien: 103.2 104.2 103.6 103.5 100.6 102.2
 Zähler: 47 13 0 0 0 0 0 0 0
 Innenzehner: 42
 weiteste: 382 (46), 361 (52), 304 (51)
 beste Teiler 10.6 (36.) 16.2 (2.) 21.2 (21.)
 Trefferlage 0.18 mm rechts, 0.23 mm hoch
 Streuwert 1.32, horizontal: 1.45, vertikal: 1.17

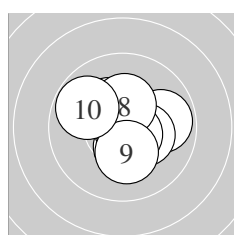
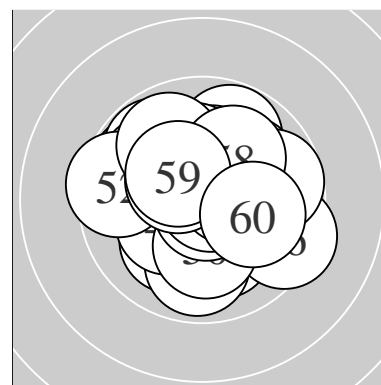

Serie 1:
 10.4 * 10.9 * 10.5 * 9.9 → 10.3 *
 10.3 * 10.6 * 10.3 * 10.2 * 9.8 ↖
 beste Teiler 16.2 (2.) 77.9 (7.) 118.1 (3.)
 Trefferlage 0.31 mm rechts, 0.09 mm hoch
 Streuwert 1.28, horizontal: 1.40, vertikal: 1.14

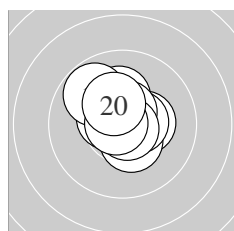

Serie 2:
 10.3 * 10.5 * 10.2 * 9.8 ↖ 10.4 *
 10.5 * 10.6 * 10.8 * 10.8 * 10.3 *
 beste Teiler 45.3 (19.) 45.9 (18.) 89.2 (17.)
 Trefferlage 0.06 mm links, 0.55 mm hoch
 Streuwert 1.02, horizontal: 1.02, vertikal: 1.02

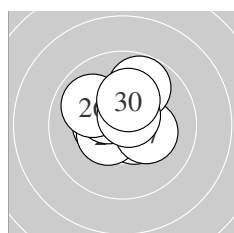

Serie 3:
 10.9 * 10.6 * 10.4 * 10.5 * 10.4 *
 9.9 ↖ 10.3 * 9.8 ↗ 10.6 * 10.2 *
 beste Teiler 21.2 (21.) 80.1 (29.) 98.4 (22.)
 Trefferlage 0.07 mm links, 0.57 mm hoch
 Streuwert 1.17, horizontal: 1.23, vertikal: 1.10

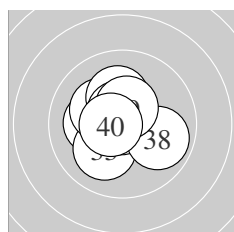

Serie 4:
 10.3 * 10.2 * 10.1 ↙ 10.2 * 10.2 *
 10.9 * 10.6 * 9.9 ↘ 10.5 * 10.6 *
 beste Teiler 10.6 (36.) 84.1 (40.) 87.9 (37.)
 Trefferlage 0.39 mm links, 0.37 mm hoch
 Streuwert 1.18, horizontal: 1.23, vertikal: 1.13

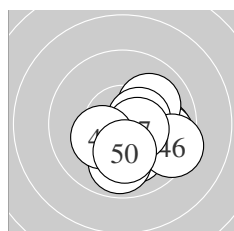

Serie 5:
 10.1 ↘ 9.9 → 9.8 → 10.0 ↗ 10.5 *
 9.4 → 10.5 * 9.9 ↓ 10.3 * 10.2 *
 beste Teiler 111.0 (47.) 121.1 (45.) 171.9 (49.)
 Trefferlage 1.23 mm rechts, 0.89 mm tief
 Streuwert 1.37, horizontal: 1.52, vertikal: 1.20

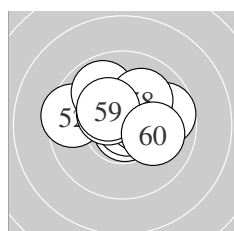

Serie 6:
 9.7 → 9.5 ← 10.8 * 10.8 * 10.5 *
 10.4 * 9.9 ↖ 10.1 ↗ 10.4 * 10.1 →
 beste Teiler 36.2 (54.) 38.0 (53.) 124.3 (55.)
 Trefferlage 0.11 mm rechts, 0.69 mm hoch
 Streuwert 1.50, horizontal: 1.92, vertikal: 0.90

ISSF AR Men – Wertung – Männer

StandNr: 116

Eberlberger, Florian #339

StartNr: 60

23. Januar 2018 11:45

OÖ – ASKÖ Bad Goisern

Unterschrift des Schützen

Meyton Elektronik

Ergebnis: **608.0** (582)
 Serien: 100.2 101.9 102.3 100.8 103.5 99.3
 Zähler: 42 18 0 0 0 0 0 0 0
 Innenzehner: 32
 weiteste: 459 (38), 417 (1), 358 (52)
 beste Teiler 50.9 (32.) 56.3 (41.) 56.8 (28.)
 Trefferlage 0.01 mm links, 0.32 mm hoch
 Streuwert 1.59, horizontal: 1.79, vertikal: 1.36

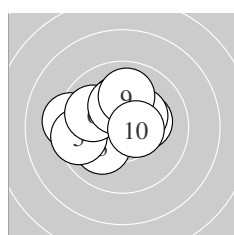
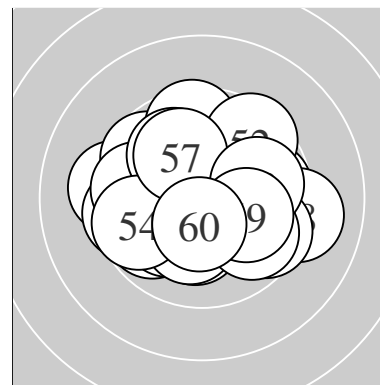

Serie 1:
 9.3 ← 10.2 * 10.1 ↙ 10.2 * 9.5 ←
 9.9 ↘ 10.3 * 10.2 * 10.0 ↑ 10.5 *
 beste Teiler 107.0 (10.) 162.2 (7.) 176.8 (8.)
 Trefferlage 0.80 mm links, 0.65 mm hoch
 Streuwert 1.68, horizontal: 2.04, vertikal: 1.21

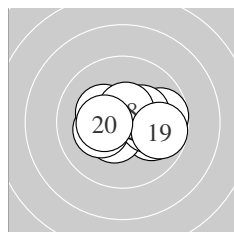

Serie 2:
 10.0 → 10.5 * 10.2 * 9.7 → 10.1 →
 10.3 * 10.3 * 10.6 * 9.8 → 10.4 *
 beste Teiler 96.3 (18.) 119.2 (12.) 145.2 (20.)
 Trefferlage 0.67 mm rechts, 0.04 mm tief
 Streuwert 1.44, horizontal: 1.90, vertikal: 0.72

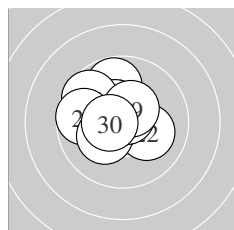

Serie 3:
 9.8 ↑ 10.1 → 10.4 * 10.7 * 9.7 ↘
 9.7 ← 10.2 * 10.7 * 10.5 * 10.5 *
 beste Teiler 56.8 (28.) 70.3 (24.) 103.1 (30.)
 Trefferlage 0.72 mm links, 0.58 mm hoch
 Streuwert 1.35, horizontal: 1.48, vertikal: 1.20

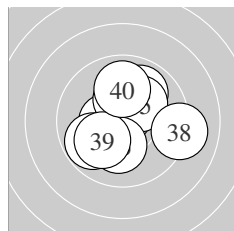

Serie 4:
 10.5 * 10.8 * 10.3 * 9.9 ↗ 10.2 *
 10.2 * 9.8 ↙ 9.1 → 10.1 ↙ 9.9 ↑
 beste Teiler 50.9 (32.) 125.1 (31.) 173.3 (33.)
 Trefferlage 0.16 mm rechts, 0.24 mm hoch
 Streuwert 1.81, horizontal: 1.94, vertikal: 1.67

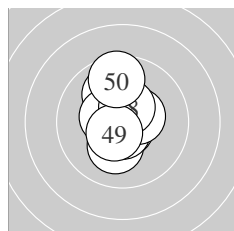

Serie 5:
 10.7 * 10.4 * 10.0 ↘ 10.2 * 10.7 *
 10.4 * 10.5 * 10.5 * 10.5 * 9.6 ↑
 beste Teiler 56.3 (41.) 72.0 (45.) 107.6 (49.)
 Trefferlage 0.21 mm links, 0.51 mm hoch
 Streuwert 1.22, horizontal: 0.71, vertikal: 1.58

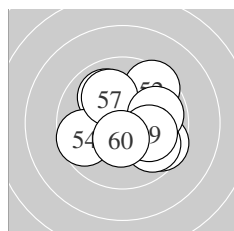

Serie 6:
 9.6 → 9.5 ↗ 10.0 ↘ 9.7 ← 9.8 ↘
 10.4 * 10.0 ↘ 9.9 → 10.0 → 10.4 *
 beste Teiler 126.6 (60.) 148.0 (56.) 226.3 (59.)
 Trefferlage 0.82 mm rechts, 0.02 mm hoch
 Streuwert 1.89, horizontal: 2.07, vertikal: 1.69

Meyton Elektronik

ISSF AR Men – Wertung – Männer

StandNr: 117

Karlon, Alexander #340

StartNr: 61

23. Januar 2018 11:31

ST – Kapfenberger SV

Unterschrift des Schützen

Meyton Elektronik

Ergebnis: **621.9** (596)
 Serien: 105.0 102.5 103.7 104.4 104.1 102.2
 Zähler: 56 4 0 0 0 0 0 0 0
 Innenzehner: 45
 weiteste: 366 (31), 324 (18), 271 (49)
 beste Teiler 12.0 (42.) 37.0 (6.) 45.8 (4.)
 Trefferlage 0.09 mm rechts, 0.06 mm tief
 Streuwert 1.18, horizontal: 1.33, vertikal: 1.01

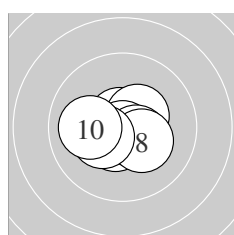
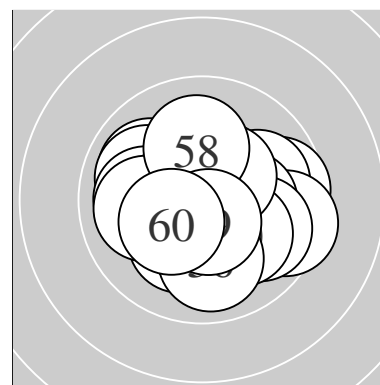

Serie 1:
 10.7 * 10.7 * 10.4 * 10.8 * 10.5 *
 10.8 * 10.5 * 10.3 * 10.3 * 10.0 ←
 beste Teiler 37.0 (6.) 45.8 (4.) 60.1 (1.)
 Trefferlage 0.13 mm links, 0.33 mm tief
 Streuwert 0.90, horizontal: 1.13, vertikal: 0.60

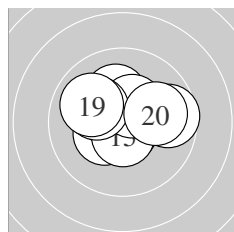

Serie 2:
 10.4 * 10.7 * 10.2 * 10.4 * 10.6 *
 10.4 * 10.1 ↖ 9.7 → 10.0 ↖ 10.0 →
 beste Teiler 66.7 (12.) 91.0 (15.) 131.8 (16.)
 Trefferlage 0.04 mm links, 0.46 mm hoch
 Streuwert 1.40, horizontal: 1.75, vertikal: 0.94

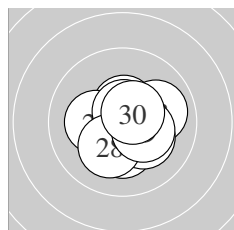

Serie 3:
 10.8 * 10.5 * 10.0 → 10.3 * 10.2 *
 10.6 * 10.2 * 10.2 * 10.3 * 10.6 *
 beste Teiler 47.8 (21.) 76.5 (26.) 99.0 (30.)
 Trefferlage 0.35 mm rechts, 0.13 mm tief
 Streuwert 1.14, horizontal: 1.22, vertikal: 1.06

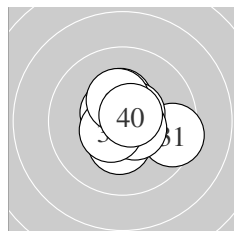

Serie 4:
 9.5 → 10.8 * 10.4 * 10.6 * 10.3 *
 10.6 * 10.6 * 10.5 * 10.4 * 10.7 *
 beste Teiler 48.8 (32.) 70.2 (40.) 93.0 (34.)
 Trefferlage 0.39 mm rechts, 0.07 mm hoch
 Streuwert 1.14, horizontal: 1.26, vertikal: 1.01

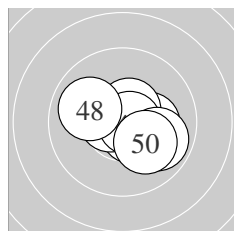

Serie 5:
 10.4 * 10.9 * 10.6 * 10.2 * 10.6 *
 10.6 * 10.8 * 10.0 ↖ 9.9 ↘ 10.1 ↘
 beste Teiler 12.0 (42.) 50.6 (47.) 87.9 (45.)
 Trefferlage 0.52 mm rechts, 0.22 mm tief
 Streuwert 1.13, horizontal: 1.38, vertikal: 0.79

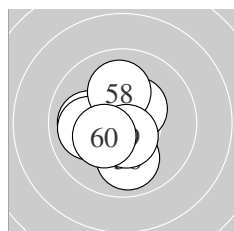

Serie 6:
 10.0 ← 10.5 * 10.3 * 10.4 * 10.1 ↓
 9.9 ↓ 10.0 ← 10.1 ↑ 10.6 * 10.3 *
 beste Teiler 97.8 (59.) 110.7 (52.) 136.6 (54.)
 Trefferlage 0.54 mm links, 0.19 mm tief
 Streuwert 1.35, horizontal: 1.17, vertikal: 1.51

Meyton Elektronik

ISSF AR Men – Wertung – Männer

StandNr: 118

Kozeniesky, Lucas #295

StartNr: 62

23. Januar 2018 11:21

USA

Unterschrift des Schützen

Meyton Elektronik

Ergebnis:	612.4	(582)
Serien:	100.9	103.9 101.2 102.0 101.7 102.7
Zähler:	43	16 1 0 0 0 0 0 0 0
Innenzehner:	35	
weiteste:	555 (24),	385 (32), 340 (25)
beste Teiler	14.8 (57.)	29.6 (11.) 48.1 (55.)
Trefferlage	0.25 mm links, 0.28 mm hoch	
Streuwert	1.49, horizontal: 1.70, vertikal: 1.25	

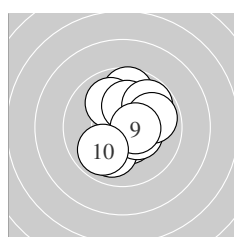
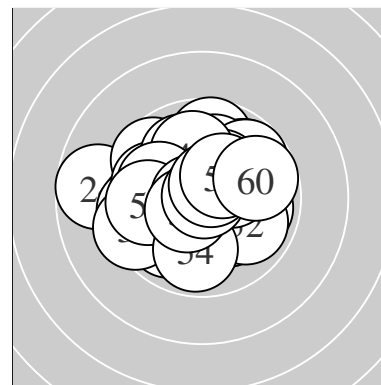

Serie 1:	9.7 ↑	10.5 *	10.0 ↘	10.0 ↓	10.2 *
	10.4 *	9.8 ↗	9.9 →	10.5 *	9.9 ↙
beste Teiler	113.4 (9.) 115.1 (2.) 144.0 (6.)				
Trefferlage	0.48 mm rechts, 0.39 mm hoch				
Streuwert	1.64, horizontal: 1.40, vertikal: 1.84				

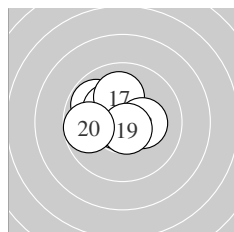

Serie 2:	10.8 *	10.8 *	9.8 ↖	10.7 *	10.7 *
	10.3 *	10.1 ↑	10.3 *	10.7 *	9.7 ←
beste Teiler	29.6 (11.) 50.9 (12.) 59.6 (14.)				
Trefferlage	0.49 mm links, 0.42 mm hoch				
Streuwert	1.18, horizontal: 1.40, vertikal: 0.92				

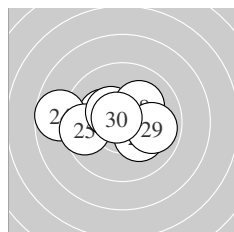

Serie 3:	10.7 *	10.2 *	10.2 *	8.7 ←	9.6 ←
	10.7 *	10.4 *	10.1 ↗	9.9 →	10.7 *
beste Teiler	64.0 (26.) 66.4 (30.) 74.9 (21.)				
Trefferlage	0.61 mm links, 0.23 mm hoch				
Streuwert	1.81, horizontal: 2.44, vertikal: 0.80				

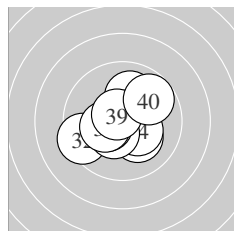

Serie 4:	10.6 *	9.4 ←	10.2 *	10.3 *	10.4 *
	10.0 ↑	10.4 *	10.3 *	10.6 *	9.8 ↗
beste Teiler	76.5 (39.) 95.4 (31.) 132.0 (35.)				
Trefferlage	0.26 mm links, 0.18 mm tief				
Streuwert	1.53, horizontal: 1.72, vertikal: 1.32				

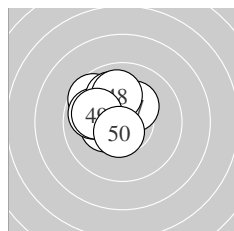

Serie 5:	10.7 *	10.3 *	10.3 *	9.6 ↖	9.9 ←
	10.0 ↘	10.3 *	10.0 ↑	10.0 ↖	10.6 *
beste Teiler	75.1 (41.) 92.6 (50.) 155.2 (43.)				
Trefferlage	1.00 mm links, 0.97 mm hoch				
Streuwert	1.18, horizontal: 1.24, vertikal: 1.12				

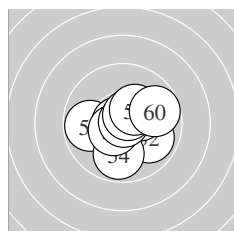

Serie 6:	9.8 ←	9.9 ↖	10.3 *	9.9 ↓	10.8 *
	10.5 *	10.9 *	10.6 *	10.3 *	9.7 →
beste Teiler	14.8 (57.) 48.1 (55.) 84.8 (58.)				
Trefferlage	0.38 mm rechts, 0.11 mm tief				
Streuwert	1.45, horizontal: 1.66, vertikal: 1.19				

Meyton Elektronik

ISSF AR Men – Wertung – **Männer**

StandNr: 146

Davis, Michael #164

StartNr: 142

23. Januar 2018 9:57

AUS

Unterschrift des Schützen

Meyton Elektronik

Ergebnis:	612.4	(582)
Serien:	100.9	103.9 101.2 102.0 101.7 102.7
Zähler:	43	16 1 0 0 0 0 0 0 0
Innenzehner:	35	
weiteste:	555	(24), 385 (32), 340 (25)
beste Teiler	14.8	(57.) 29.6 (11.) 48.1 (55.)
Trefferlage	0.25 mm	links, 0.28 mm hoch
Streuwert	1.49,	horizontal: 1.70, vertikal: 1.25

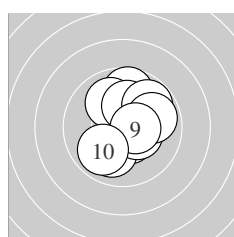
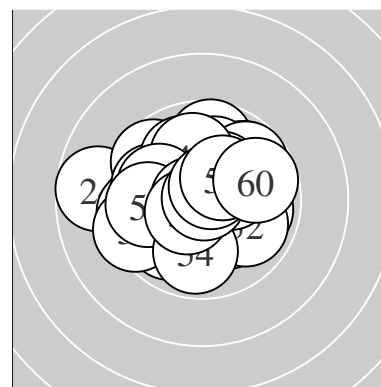

Serie 1:	9.7 ↑	10.5 *	10.0 ↘	10.0 ↓	10.2 *
	10.4 *	9.8 ↗	9.9 →	10.5 *	9.9 ↙
beste Teiler	113.4	(9.) 115.1 (2.)	144.0 (6.)		
Trefferlage	0.48 mm	rechts, 0.39 mm hoch			
Streuwert	1.64,	horizontal: 1.40, vertikal: 1.84			

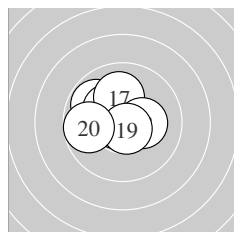

Serie 2:	10.8 *	10.8 *	9.8 ↖	10.7 *	10.7 *
	10.3 *	10.1 ↑	10.3 *	10.7 *	9.7 ←
beste Teiler	29.6	(11.) 50.9 (12.)	59.6 (14.)		
Trefferlage	0.49 mm	links, 0.42 mm hoch			
Streuwert	1.18,	horizontal: 1.40, vertikal: 0.92			

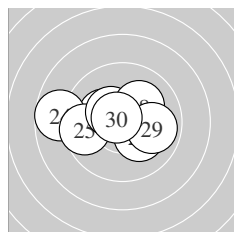

Serie 3:	10.7 *	10.2 *	10.2 *	8.7 ←	9.6 ←
	10.7 *	10.4 *	10.1 ↗	9.9 →	10.7 *
beste Teiler	64.0	(26.) 66.4 (30.)	74.9 (21.)		
Trefferlage	0.61 mm	links, 0.23 mm hoch			
Streuwert	1.81,	horizontal: 2.44, vertikal: 0.80			

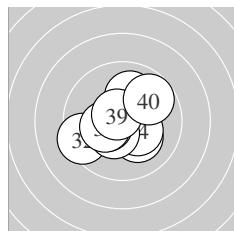

Serie 4:	10.6 *	9.4 ←	10.2 *	10.3 *	10.4 *
	10.0 ↑	10.4 *	10.3 *	10.6 *	9.8 ↗
beste Teiler	76.5	(39.) 95.4 (31.)	132.0 (35.)		
Trefferlage	0.26 mm	links, 0.18 mm tief			
Streuwert	1.53,	horizontal: 1.72, vertikal: 1.32			

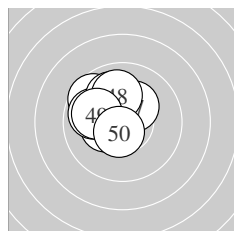

Serie 5:	10.7 *	10.3 *	10.3 *	9.6 ↖	9.9 ←
	10.0 ↘	10.3 *	10.0 ↑	10.0 ↖	10.6 *
beste Teiler	75.1	(41.) 92.6 (50.)	155.2 (43.)		
Trefferlage	1.00 mm	links, 0.97 mm hoch			
Streuwert	1.18,	horizontal: 1.24, vertikal: 1.12			

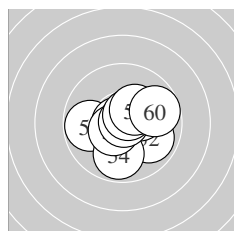

Serie 6:	9.8 ←	9.9 ↘	10.3 *	9.9 ↓	10.8 *
	10.5 *	10.9 *	10.6 *	10.3 *	9.7 →
beste Teiler	14.8	(57.) 48.1 (55.)	84.8 (58.)		
Trefferlage	0.38 mm	rechts, 0.11 mm tief			
Streuwert	1.45,	horizontal: 1.66, vertikal: 1.19			

ISSF AR Men – Wertung – **Männer**

StandNr: 146

Davis, Michael #164

StartNr: 142

23. Januar 2018 9:57

AUS

Unterschrift des Schützen

Meyton Elektronik