

Ergebnis: **602.9** (576)  
 Serien: 97.6 102.9 99.7 103.9 100.3 98.5  
 Zähler: 39 18 3 0 0 0 0 0 0  
 Innenzehner: 33  
 weiteste: 697 (56), 608 (5), 531 (9)  
 beste Teiler 34.0 (48.) 55.1 (37.) 57.8 (41.)  
 Trefferlage 0.69 mm links, 0.07 mm tief  
 Streuwert 1.85, horizontal: 2.18, vertikal: 1.44

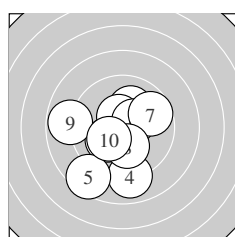

Serie 1:  
 10.2 \* 10.1 ↗ 10.5 \* 9.0 ↓ 8.5 ↘  
 10.4 \* 9.7 → 10.2 \* 8.8 ← 10.2 \*  
 beste Teiler 112.6 (3.) 129.2 (6.) 180.1 (10.)  
 Trefferlage 0.60 mm links, 0.88 mm tief  
 Streuwert 2.43, horizontal: 2.39, vertikal: 2.48

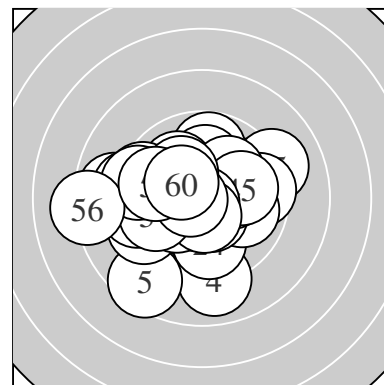
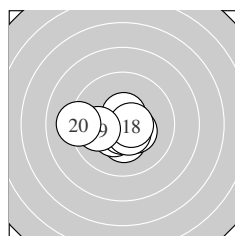

Serie 2:  
 10.3 \* 10.4 \* 10.4 \* 10.4 \* 10.6 \*  
 10.6 \* 10.5 \* 10.6 \* 9.9 ← 9.2 ←  
 beste Teiler 80.1 (15.) 87.5 (18.) 94.6 (16.)  
 Trefferlage 0.62 mm links, 0.50 mm tief  
 Streuwert 1.33, horizontal: 1.74, vertikal: 0.70

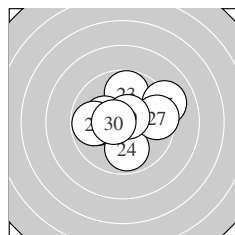

Serie 3:  
 9.9 ← 10.1 ↗ 9.8 ↑ 9.9 ↓ 9.1 ↘  
 10.2 \* 9.6 → 9.8 ← 10.7 \* 10.6 \*  
 beste Teiler 72.8 (29.) 90.0 (30.) 185.1 (26.)  
 Trefferlage 0.25 mm rechts, 0.44 mm hoch  
 Streuwert 1.98, horizontal: 2.39, vertikal: 1.47

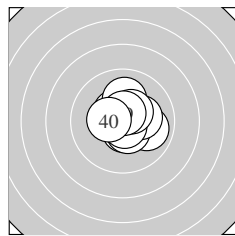

Serie 4:  
 10.5 \* 10.1 ↑ 10.6 \* 9.9 → 10.5 \*  
 10.2 \* 10.7 \* 10.4 \* 10.6 \* 10.4 \*  
 beste Teiler 55.1 (37.) 79.7 (39.) 94.0 (33.)  
 Trefferlage 0.41 mm rechts, 0.21 mm hoch  
 Streuwert 1.06, horizontal: 1.10, vertikal: 1.03

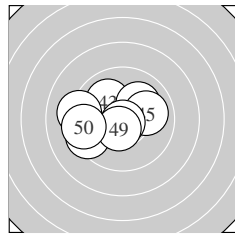

Serie 5:  
 10.7 \* 10.2 \* 10.0 ↘ 10.1 ↗ 10.0 →  
 9.4 ← 9.2 ← 10.8 \* 10.5 \* 9.4 ←  
 beste Teiler 34.0 (48.) 57.8 (41.) 104.1 (49.)  
 Trefferlage 1.16 mm links, 0.13 mm hoch  
 Streuwert 1.80, horizontal: 2.27, vertikal: 1.17

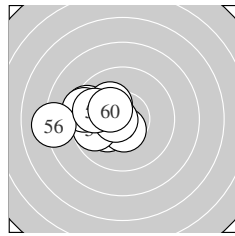

Serie 6:  
 10.2 \* 9.4 ← 10.5 \* 9.8 ← 9.4 ←  
 8.2 ← 10.2 \* 10.7 \* 9.8 ← 10.3 \*  
 beste Teiler 70.7 (58.) 108.9 (53.) 155.8 (60.)  
 Trefferlage 2.46 mm links, 0.15 mm hoch  
 Streuwert 1.61, horizontal: 2.04, vertikal: 1.02

Meyton Elektronik

**ISSF AR Men – Wertung – Männer**

StandNr: 123

**Insam, Fabian** #70418009

**StartNr: 23**

3. Dezember 2017 9:41

T – SG Fügenberg

---

\_\_\_\_\_  
Unterschrift des Schützen

Meyton Elektronik

Ergebnis: **626.1** (598)<sup>QF</sup>  
 Serien: 105.3 103.5 105.3 103.7 103.0 105.3  
 Zähler: 58 2 0 0 0 0 0 0 0  
 Innenzehner: 47  
 weiteste: 324 (38), 276 (48), 250 (18)  
 beste Teiler 22.4 (54.) 24.0 (41.) 27.5 (1.)  
 Trefferlage 0.00 mm , 0.20 mm hoch  
 Streuwert 1.05, horizontal: 0.99, vertikal: 1.11

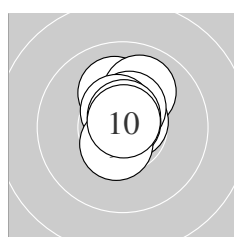
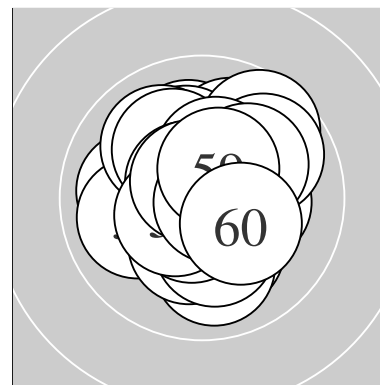

Serie 1:  
 10.8 \*                      10.1 ↑                      10.0 ↗                      10.7 \*                      10.4 \*  
 10.8 \*                      10.5 \*                      10.7 \*                      10.5 \*                      10.8 \*  
 beste Teiler 27.5 (1.) 30.6 (6.) 36.6 (10.)  
 Trefferlage 0.12 mm rechts, 0.73 mm hoch  
 Streuwert 0.75, horizontal: 0.47, vertikal: 0.95

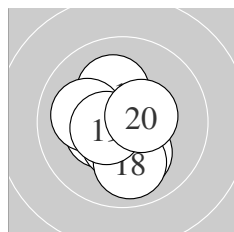

Serie 2:  
 10.2 \*                      10.4 \*                      10.6 \*                      10.5 \*                      10.6 \*  
 10.1 ←                      10.1 ↓                      10.0 ↓                      10.5 \*                      10.5 \*  
 beste Teiler 89.0 (15.) 96.7 (13.) 105.3 (19.)  
 Trefferlage 0.30 mm links, 0.55 mm tief  
 Streuwert 1.13, horizontal: 1.01, vertikal: 1.24

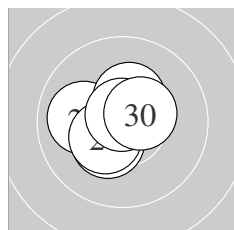

Serie 3:  
 10.7 \*                      10.4 \*                      10.7 \*                      10.8 \*                      10.6 \*  
 10.0 ←                      10.4 \*                      10.4 \*                      10.8 \*                      10.5 \*  
 beste Teiler 43.9 (24.) 45.3 (29.) 53.6 (23.)  
 Trefferlage 0.29 mm links, 0.21 mm hoch  
 Streuwert 0.89, horizontal: 1.00, vertikal: 0.76

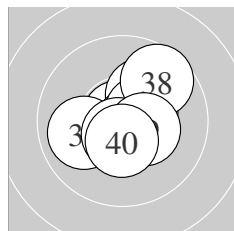

Serie 4:  
 10.5 \*                      10.8 \*                      10.1 ↗                      10.0 ←                      10.7 \*  
 10.4 \*                      10.6 \*                      9.7 ↗                      10.4 \*                      10.5 \*  
 beste Teiler 34.6 (32.) 57.2 (35.) 86.0 (37.)  
 Trefferlage 0.22 mm rechts, 0.07 mm hoch  
 Streuwert 1.25, horizontal: 1.32, vertikal: 1.17

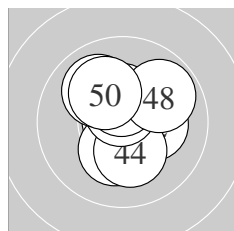

Serie 5:  
 10.9 \*                      10.2 \*                      10.3 \*                      10.2 \*                      10.4 \*  
 10.7 \*                      10.4 \*                      9.8 ↗                      10.0 ↘                      10.1 ↘  
 beste Teiler 24.0 (41.) 75.8 (46.) 128.7 (45.)  
 Trefferlage 0.08 mm rechts, 0.51 mm hoch  
 Streuwert 1.27, horizontal: 1.16, vertikal: 1.36

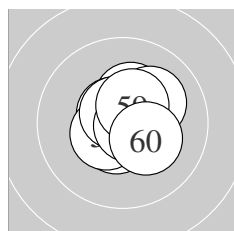

Serie 6:  
 10.6 \*                      10.3 \*                      10.6 \*                      10.9 \*                      10.5 \*  
 10.7 \*                      10.1 ↗                      10.8 \*                      10.5 \*                      10.3 \*  
 beste Teiler 22.4 (54.) 48.7 (58.) 74.3 (56.)  
 Trefferlage 0.22 mm rechts, 0.25 mm hoch  
 Streuwert 0.88, horizontal: 0.87, vertikal: 0.89

Meyton Elektronik

**ISSF AR Men – Wertung – Männer**

StandNr: 124

**Baudouin, Brian** #70804692

**StartNr: 24**

3. Dezember 2017 9:32

FRA

---

QF – Schütze hat sich fürs Finale qualifiziert

---

Unterschrift des Schützen

Meyton Elektronik

Ergebnis:	<b>623.8</b>	(595) <sup>QF</sup>							
Serien:	103.4	103.6	105.9	105.0	102.4	103.5			
Zähler:	55	5	0	0	0	0	0	0	0
Innenzehner:	51								
weiteste:	327 (13), 314 (14), 310 (46)								
beste Teiler	20.0 (17.) 40.1 (19.) 44.5 (24.)								
Trefferlage	0.45 mm links, 0.51 mm hoch								
Streuwert	1.00, horizontal: 1.03, vertikal: 0.96								

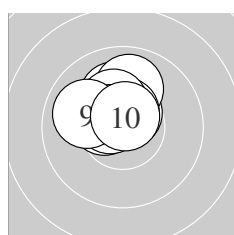
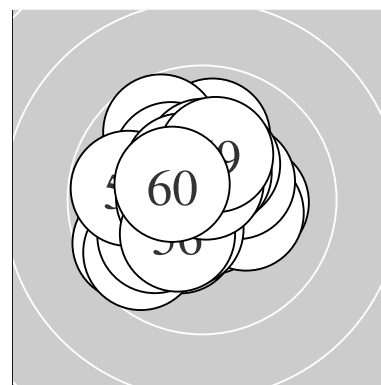

Serie 1:	10.1 ↑	10.4 *	10.6 *	9.9 ↑	10.6 *
	10.2 *	10.3 *	10.6 *	10.0 ↖	10.7 *
beste Teiler	72.7 (10.) 96.2 (8.) 98.6 (3.)				
Trefferlage	0.59 mm links, 1.14 mm hoch				
Streuwert	0.79, horizontal: 0.90, vertikal: 0.66				

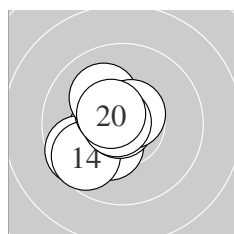

Serie 2:	10.5 *	10.3 *	9.6 ↙	9.7 ↙	10.5 *
	10.1 ↘	10.9 *	10.6 *	10.8 *	10.6 *
beste Teiler	20.0 (17.) 40.1 (19.) 84.5 (18.)				
Trefferlage	1.01 mm links, 0.12 mm tief				
Streuwert	1.11, horizontal: 0.99, vertikal: 1.22				

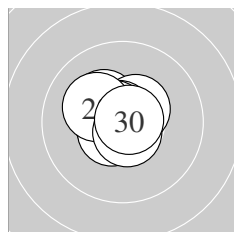

Serie 3:	10.3 *	10.5 *	10.6 *	10.8 *	10.7 *
	10.7 *	10.6 *	10.2 *	10.7 *	10.8 *
beste Teiler	44.5 (24.) 44.5 (30.) 51.4 (25.)				
Trefferlage	0.39 mm links, 0.30 mm hoch				
Streuwert	0.70, horizontal: 0.77, vertikal: 0.63				

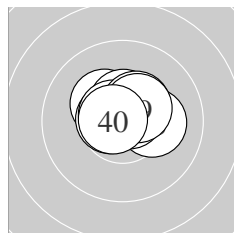

Serie 4:	10.3 *	10.5 *	10.2 *	10.5 *	10.6 *
	10.7 *	10.7 *	10.4 *	10.4 *	10.7 *
beste Teiler	62.2 (36.) 63.9 (40.) 75.7 (37.)				
Trefferlage	0.16 mm rechts, 0.59 mm hoch				
Streuwert	0.76, horizontal: 0.97, vertikal: 0.46				

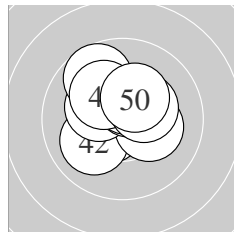

Serie 5:	10.5 *	10.0 ↙	10.2 *	10.3 *	10.5 *
	9.7 ↘	10.4 *	10.2 *	10.3 *	10.3 *
beste Teiler	105.4 (41.) 116.0 (45.) 127.5 (47.)				
Trefferlage	0.24 mm links, 0.69 mm hoch				
Streuwert	1.26, horizontal: 1.32, vertikal: 1.20				

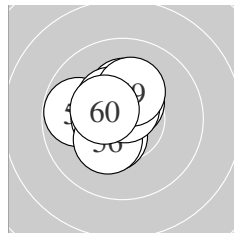

Serie 6:	10.4 *	10.5 *	9.8 ←	10.5 *	10.3 *
	10.3 *	10.4 *	10.7 *	10.2 *	10.4 *
beste Teiler	71.8 (58.) 111.1 (54.) 116.8 (52.)				
Trefferlage	0.63 mm links, 0.50 mm hoch				
Streuwert	1.04, horizontal: 1.02, vertikal: 1.06				

**ISSF AR Men – Wertung – Männer**

StandNr: 125

**Simon, Weithaler** #70817570

**StartNr: 25**

3. Dezember 2017 9:40

ITA

---

QF – Schütze hat sich fürs Finale qualifiziert

---

Unterschrift des Schützen

Meyton Elektronik

Ergebnis:	<b>612.9</b>	(587)							
Serien:	102.0	101.6	101.9	101.2	104.3	101.9			
Zähler:	47	13	0	0	0	0	0	0	0
Innenzehner:	35								
weiteste:	471	(3), 417	(34), 362	(14)					
beste Teiler	5.0	(1.) 59.6	(23.) 64.2	(43.)					
Trefferlage	0.50	mm rechts,	0.12	mm hoch					
Streuwert	1.44,	horizontal: 1.73,	vertikal: 1.07						

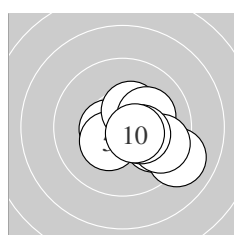
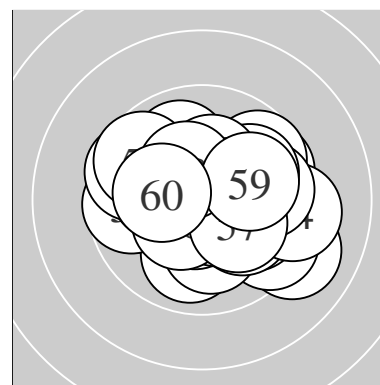

Serie 1:					
	10.9 *	9.9 ↘	9.1 ↘	10.5 *	10.4 *
	10.4 *	10.2 *	9.7 ↘	10.4 *	10.5 *
beste Teiler	5.0	(1.) 105.0	(10.) 107.9	(4.)	
Trefferlage	1.19	mm rechts,	0.48	mm tief	
Streuwert	1.40,	horizontal: 1.68,	vertikal: 1.04		

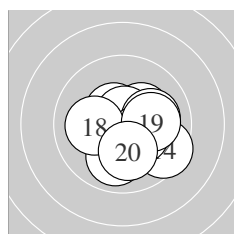

Serie 2:					
	10.5 *	10.3 *	10.7 *	9.5 ↘	10.1 →
	9.9 ↓	10.3 *	10.1 ←	10.1 →	10.1 ↓
beste Teiler	66.4	(13.) 112.2	(11.) 151.0	(17.)	
Trefferlage	0.73	mm rechts,	0.41	mm tief	
Streuwert	1.45,	horizontal: 1.59,	vertikal: 1.28		

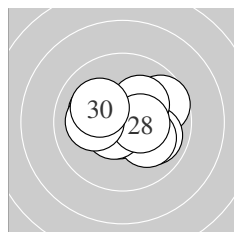

Serie 3:					
	9.7 ↗	9.9 ↘	10.7 *	10.1 ↘	10.2 *
	10.1 ↖	10.6 *	10.4 *	10.1 ←	10.1 ↖
beste Teiler	59.6	(23.) 87.8	(27.) 135.3	(28.)	
Trefferlage	0.30	mm rechts,	0.11	mm hoch	
Streuwert	1.49,	horizontal: 1.87,	vertikal: 0.96		

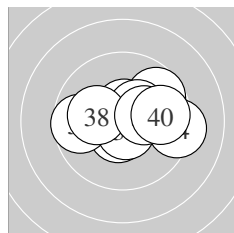

Serie 4:					
	10.6 *	9.7 ↗	10.6 *	9.3 →	10.7 *
	9.7 ←	10.4 *	10.1 ←	10.3 *	9.8 →
beste Teiler	73.0	(35.) 95.7	(33.) 97.7	(31.)	
Trefferlage	0.71	mm rechts,	0.26	mm hoch	
Streuwert	1.70,	horizontal: 2.24,	vertikal: 0.86		

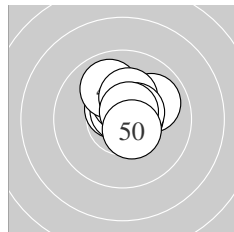

Serie 5:					
	10.0 ↗	10.6 *	10.7 *	10.4 *	10.0 ↖
	10.3 *	10.6 *	10.5 *	10.7 *	10.5 *
beste Teiler	64.2	(43.) 75.2	(49.) 86.7	(47.)	
Trefferlage	0.36	mm rechts,	0.82	mm hoch	
Streuwert	0.88,	horizontal: 0.91,	vertikal: 0.86		

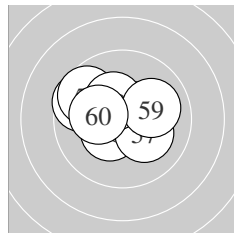

Serie 6:					
	9.6 ↖	10.7 *	10.4 *	10.4 *	9.7 ↖
	10.4 *	10.2 *	10.3 *	10.0 →	10.2 *
beste Teiler	74.7	(52.) 135.7	(56.) 144.5	(54.)	
Trefferlage	0.30	mm links,	0.44	mm hoch	
Streuwert	1.51,	horizontal: 1.89,	vertikal: 0.98		

Meyton Elektronik

**ISSF AR Men – Wertung – Männer**

StandNr: 126

**Rumpler, Stefan** #112

**StartNr: 26**

3. Dezember 2017 9:43

ÖSB

---

\_\_\_\_\_  
Unterschrift des Schützen

Meyton Elektronik



Ergebnis: **615.5** (587)  
 Serien: 104.1 103.6 103.3 99.2 104.1 101.2  
 Zähler: 48 11 1 0 0 0 0 0 0 0  
 Innenzehner: 41  
 weiteste: 505 (39), 436 (12), 390 (34)  
 beste Teiler 22.3 (43.) 34.4 (17.) 46.8 (7.)  
 Trefferlage 0.34 mm rechts, 0.29 mm tief  
 Streuwert 1.39, horizontal: 1.58, vertikal: 1.18

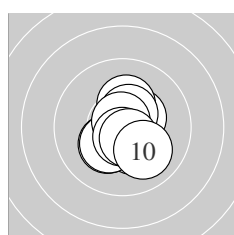
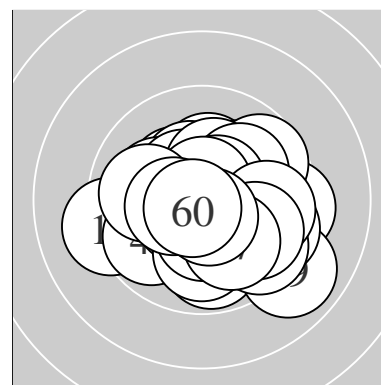

Serie 1:  
 10.3 \* 10.4 \* 10.2 \* 10.3 \* 10.5 \*  
 10.3 \* 10.8 \* 10.7 \* 10.6 \* 10.0 ↘  
 beste Teiler 46.8 (7.) 73.1 (8.) 95.7 (9.)  
 Trefferlage 0.22 mm rechts, 0.32 mm tief  
 Streuwert 1.05, horizontal: 0.86, vertikal: 1.21

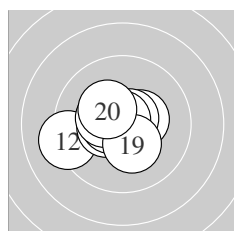

Serie 2:  
 10.5 \* 9.2 ← 10.4 \* 10.6 \* 10.4 \*  
 10.7 \* 10.8 \* 10.4 \* 10.3 \* 10.3 \*  
 beste Teiler 34.4 (17.) 69.4 (16.) 94.0 (14.)  
 Trefferlage 0.75 mm links, 0.01 mm tief  
 Streuwert 1.23, horizontal: 1.54, vertikal: 0.80

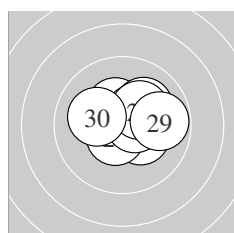

Serie 3:  
 10.6 \* 10.4 \* 10.3 \* 10.5 \* 10.1 ↗  
 10.6 \* 10.6 \* 10.3 \* 9.8 → 10.1 ←  
 beste Teiler 86.0 (21.) 93.9 (27.) 100.4 (26.)  
 Trefferlage 0.62 mm rechts, 0.50 mm hoch  
 Streuwert 1.12, horizontal: 1.36, vertikal: 0.81

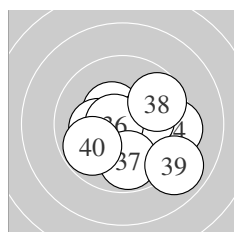

Serie 4:  
 10.4 \* 10.2 \* 10.1 ↓ 9.4 → 10.2 \*  
 10.7 \* 9.8 ↓ 9.7 ↗ 8.9 ↘ 9.8 ↙  
 beste Teiler 63.1 (36.) 129.1 (31.) 176.7 (35.)  
 Trefferlage 0.78 mm rechts, 0.72 mm tief  
 Streuwert 1.96, horizontal: 2.25, vertikal: 1.61

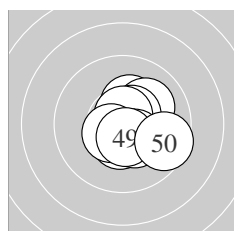

Serie 5:  
 10.3 \* 10.5 \* 10.9 \* 10.1 ↗ 10.6 \*  
 10.7 \* 10.5 \* 10.4 \* 10.5 \* 9.6 ↘  
 beste Teiler 22.3 (43.) 66.2 (46.) 100.4 (45.)  
 Trefferlage 0.64 mm rechts, 0.12 mm tief  
 Streuwert 1.11, horizontal: 1.13, vertikal: 1.09

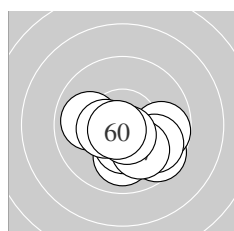

Serie 6:  
 10.0 ↓ 9.6 ↘ 9.8 → 10.4 \* 9.9 ←  
 9.8 ↘ 10.0 ↓ 10.6 \* 10.4 \* 10.7 \*  
 beste Teiler 58.1 (60.) 83.7 (58.) 134.1 (59.)  
 Trefferlage 0.55 mm rechts, 1.08 mm tief  
 Streuwert 1.41, horizontal: 1.79, vertikal: 0.90

Meyton Elektronik

**ISSF AR Men** – Wertung – **Männer**

StandNr: 127

**Patka, Hannes** #318

**StartNr: 27**

3. Dezember 2017 9:44

T – SG Mieming

---

\_\_\_\_\_  
Unterschrift des Schützen

Meyton Elektronik

Ergebnis: **621.8** (594)  
 Serien: 102.7 104.1 103.9 103.9 103.8 103.4  
 Zähler: 54 6 0 0 0 0 0 0 0  
 Innenzehner: 48  
 weiteste: 433 (8), 371 (17), 310 (1)  
 beste Teiler 10.6 (55.) 27.0 (14.) 31.3 (35.)  
 Trefferlage 0.42 mm rechts, 0.23 mm tief  
 Streuwert 1.16, horizontal: 1.21, vertikal: 1.10

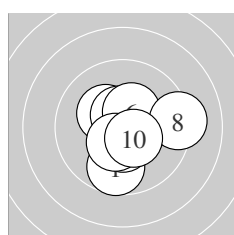
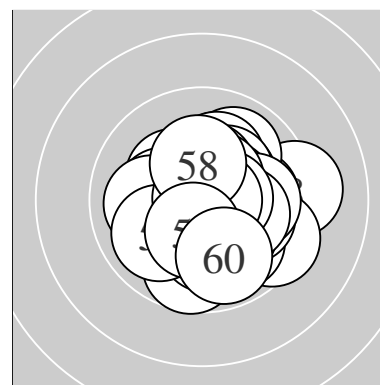

Serie 1:  
 9.7 ↓                      10.4 \*                      10.3 \*                      10.7 \*                      10.6 \*  
 10.4 \*                      10.5 \*                      9.2 →                      10.4 \*                      10.5 \*  
 beste Teiler 74.5 (4.) 98.4 (5.) 120.9 (10.)  
 Trefferlage 0.43 mm rechts, 0.34 mm tief  
 Streuwert 1.45, horizontal: 1.56, vertikal: 1.34

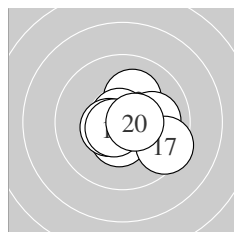

Serie 2:  
 10.6 \*                      10.2 \*                      10.0 →                      10.8 \*                      10.8 \*  
 10.5 \*                      9.5 ↘                      10.5 \*                      10.6 \*                      10.6 \*  
 beste Teiler 27.0 (14.) 44.9 (15.) 80.7 (19.)  
 Trefferlage 0.46 mm rechts, 0.20 mm tief  
 Streuwert 1.20, horizontal: 1.39, vertikal: 0.97

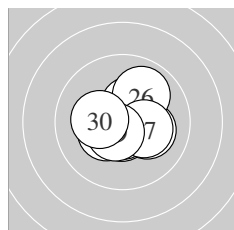

Serie 3:  
 10.2 \*                      10.4 \*                      10.6 \*                      10.6 \*                      10.7 \*  
 9.9 ↗                      10.3 \*                      10.4 \*                      10.6 \*                      10.2 \*  
 beste Teiler 65.0 (25.) 80.1 (24.) 95.2 (29.)  
 Trefferlage 0.28 mm rechts, 0.09 mm tief  
 Streuwert 1.13, horizontal: 1.24, vertikal: 1.00

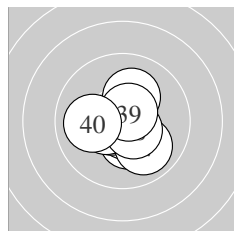

Serie 4:  
 10.3 \*                      10.6 \*                      10.6 \*                      10.2 \*                      10.8 \*  
 10.4 \*                      9.9 ↘                      10.5 \*                      10.6 \*                      10.0 ←  
 beste Teiler 31.3 (35.) 77.4 (32.) 83.4 (39.)  
 Trefferlage 0.00 mm , 0.33 mm tief  
 Streuwert 1.11, horizontal: 1.16, vertikal: 1.06

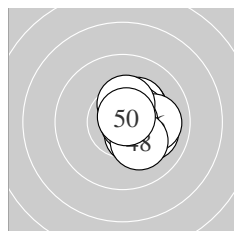

Serie 5:  
 10.3 \*                      10.1 →                      10.3 \*                      10.4 \*                      10.5 \*  
 10.0 →                      10.8 \*                      10.2 \*                      10.4 \*                      10.8 \*  
 beste Teiler 50.0 (47.) 50.2 (50.) 123.4 (45.)  
 Trefferlage 1.10 mm rechts, 0.14 mm hoch  
 Streuwert 0.85, horizontal: 0.70, vertikal: 0.97

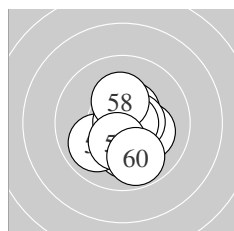

Serie 6:  
 10.1 ↓                      10.2 \*                      10.0 ↙                      10.5 \*                      10.9 \*  
 10.5 \*                      10.7 \*                      10.3 \*                      10.4 \*                      9.8 ↓  
 beste Teiler 10.6 (55.) 55.0 (57.) 106.3 (56.)  
 Trefferlage 0.27 mm rechts, 0.55 mm tief  
 Streuwert 1.21, horizontal: 1.04, vertikal: 1.36

Meyton Elektronik

**ISSF AR Men – Wertung – Männer**

StandNr: 128

**Rumpler, Gernot #265**

**StartNr: 28**

3. Dezember 2017 9:33

ÖSB

---

Unterschrift des Schützen

Meyton Elektronik

Ergebnis:	<b>627.8</b>	(599) <sup>QF</sup>							
Serien:	104.2	103.6	105.3	104.7	105.4	104.6			
Zähler:	59	1	0	0	0	0	0	0	0
Innenzehner:	56								
weiteste:	283 (20), 236 (7), 219 (17)								
beste Teiler	6.0 (44.)	16.0 (47.)	41.8 (15.)						
Trefferlage	0.20 mm rechts, 0.10 mm hoch								
Streuwert	0.95, horizontal: 0.93, vertikal: 0.97								

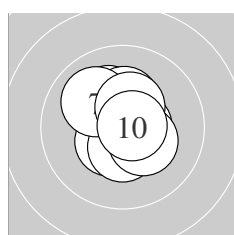
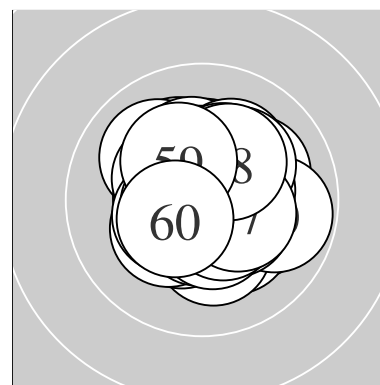

Serie 1:	10.2 *	10.3 *	10.6 *	10.8 *	10.5 *
	10.4 *	10.0 ↖	10.4 *	10.3 *	10.7 *
beste Teiler	43.8 (4.) 61.6 (10.) 93.0 (3.)				
Trefferlage	0.03 mm rechts, 0.35 mm hoch				
Streuwert	1.05, horizontal: 0.93, vertikal: 1.15				

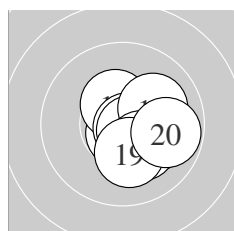

Serie 2:	10.7 *	10.1 →	10.6 *	10.4 *	10.8 *
	10.7 *	10.1 →	10.2 *	10.2 *	9.8 →
beste Teiler	41.8 (15.) 58.2 (11.) 69.6 (16.)				
Trefferlage	0.95 mm rechts, 0.34 mm tief				
Streuwert	0.99, horizontal: 1.03, vertikal: 0.95				

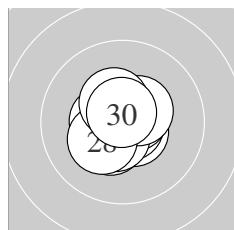

Serie 3:	10.6 *	10.4 *	10.8 *	10.6 *	10.5 *
	10.5 *	10.5 *	10.3 *	10.4 *	10.7 *
beste Teiler	46.1 (23.) 62.3 (30.) 81.8 (24.)				
Trefferlage	0.15 mm links, 0.09 mm tief				
Streuwert	0.83, horizontal: 0.83, vertikal: 0.84				

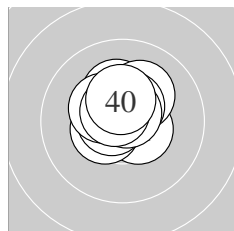

Serie 4:	10.5 *	10.5 *	10.2 *	10.2 *	10.7 *
	10.5 *	10.4 *	10.7 *	10.6 *	10.4 *
beste Teiler	58.1 (38.) 69.0 (35.) 79.6 (39.)				
Trefferlage	0.12 mm links, 0.66 mm hoch				
Streuwert	0.81, horizontal: 0.82, vertikal: 0.81				

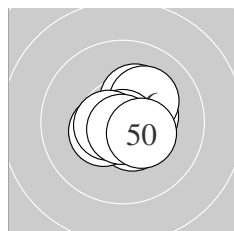

Serie 5:	10.5 *	10.4 *	10.4 *	10.9 *	10.3 *
	10.2 *	10.9 *	10.6 *	10.8 *	10.4 *
beste Teiler	6.0 (44.) 16.0 (47.) 47.3 (49.)				
Trefferlage	0.31 mm rechts, 0.01 mm hoch				
Streuwert	0.87, horizontal: 0.91, vertikal: 0.82				

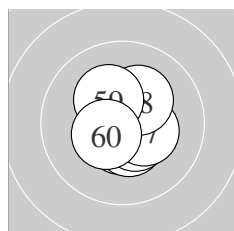

Serie 6:	10.5 *	10.5 *	10.7 *	10.4 *	10.5 *
	10.7 *	10.4 *	10.2 *	10.3 *	10.4 *
beste Teiler	57.8 (53.) 74.6 (56.) 106.6 (51.)				
Trefferlage	0.17 mm rechts, 0.04 mm hoch				
Streuwert	0.95, horizontal: 0.82, vertikal: 1.06				

**ISSF AR Men – Wertung – Männer**

StandNr: 129

**Monnier, Jérémy** #70817558

**StartNr: 29**

3. Dezember 2017 9:44

FRA

---

QF – Schütze hat sich fürs Finale qualifiziert

---

Unterschrift des Schützen

Meyton Elektronik

Ergebnis:	<b>604.7</b>	(580)
Serien:	102.5	98.2 99.1 101.3 102.7 100.9
Zähler:	40	20 0 0 0 0 0 0 0 0
Innenzehner:	28	
weiteste:	484 (17), 474 (20), 460 (22)	
beste Teiler	44.4 (37.) 47.2 (57.) 66.6 (50.)	
Trefferlage	0.30 mm links, 0.49 mm hoch	
Streuwert	1.70, horizontal: 1.94, vertikal: 1.41	

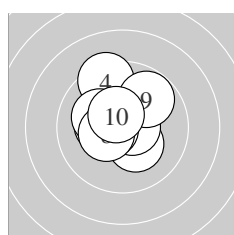
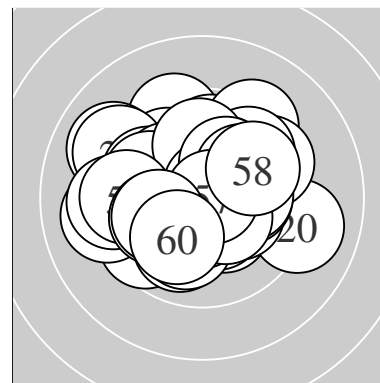

Serie 1:	10.3 *	10.5 *	10.3 *	9.4 ↗	10.6 *
	10.1 ↘	10.6 *	10.4 *	9.8 ↗	10.5 *
beste Teiler	77.0 (5.) 99.2 (7.) 101.2 (2.)				
Trefferlage	0.45 mm links, 0.67 mm hoch				
Streuwert	1.35, horizontal: 1.26, vertikal: 1.43				

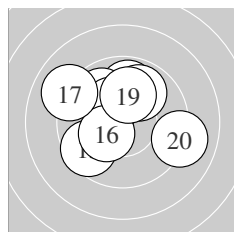

Serie 2:	9.9 ↑	10.1 ↘	9.6 ↙	9.9 ↘	10.3 *
	10.3 *	9.0 ↘	9.9 ↑	10.1 ↑	9.1 →
beste Teiler	157.0 (16.) 161.1 (15.) 213.4 (12.)				
Trefferlage	0.53 mm links, 1.03 mm hoch				
Streuwert	2.11, horizontal: 2.40, vertikal: 1.77				

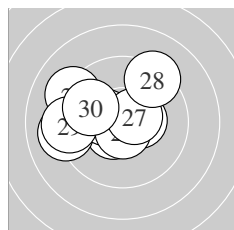

Serie 3:	10.5 *	9.1 ←	10.4 *	9.1 ↘	10.4 *
	10.7 *	10.5 *	9.3 ↗	9.3 ←	9.8 ↘
beste Teiler	69.0 (26.) 103.2 (21.) 104.6 (27.)				
Trefferlage	1.27 mm links, 0.52 mm hoch				
Streuwert	2.00, horizontal: 2.47, vertikal: 1.38				

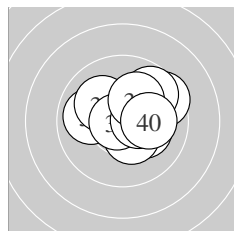

Serie 4:	9.9 ↙	9.5 ↗	9.7 ↗	10.2 *	10.4 *
	10.1 ↘	10.8 *	10.4 *	10.2 *	10.1 →
beste Teiler	44.4 (37.) 127.1 (38.) 139.4 (35.)				
Trefferlage	0.76 mm rechts, 0.53 mm hoch				
Streuwert	1.49, horizontal: 1.78, vertikal: 1.12				

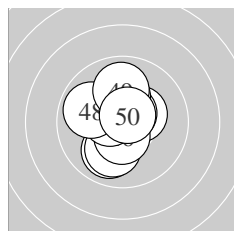

Serie 5:	10.0 ↘	10.4 *	10.0 ↘	10.6 *	10.2 *
	10.5 *	10.5 *	9.9 ↘	9.9 ↑	10.7 *
beste Teiler	66.6 (50.) 86.2 (44.) 105.6 (47.)				
Trefferlage	0.33 mm links, 0.21 mm hoch				
Streuwert	1.35, horizontal: 1.06, vertikal: 1.60				

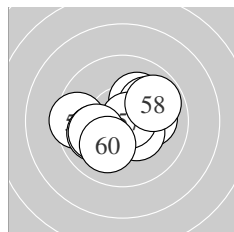

Serie 6:	10.2 *	10.0 ↗	10.1 →	10.4 *	9.5 ←
	10.0 ↙	10.8 *	9.8 ↗	10.0 ↙	10.1 ↘
beste Teiler	47.2 (57.) 144.9 (54.) 199.7 (51.)				
Trefferlage	0.00 mm, 0.00 mm				
Streuwert	1.72, horizontal: 2.12, vertikal: 1.18				

**ISSF AR Men** – Wertung – **Männer**

StandNr: 130

**Simo, Kornél** #70817556

**StartNr: 30**

3. Dezember 2017 9:38

HUN – BHSE

---

\_\_\_\_\_  
Unterschrift des Schützen

Meyton Elektronik



Ergebnis:	<b>624.7</b>	(596) <sup>QF</sup>							
Serien:	102.2	103.7	104.2	104.6	106.0	104.0			
Zähler:	56	4	0	0	0	0	0	0	0
Innenzehner:	49								
weiteste:	439 (4), 303 (12), 266 (27)								
beste Teiler	6.4 (25.) 23.5 (49.) 25.0 (45.)								
Trefferlage	0.12 mm rechts, 0.08 mm tief								
Streuwert	1.10, horizontal: 1.28, vertikal: 0.88								

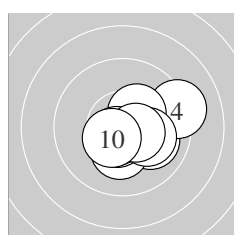
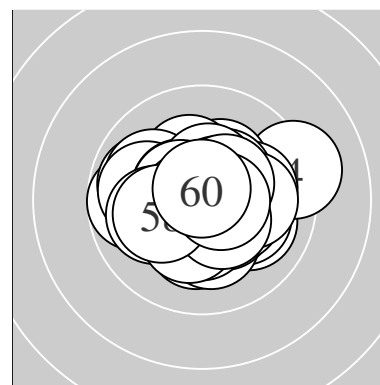

Serie 1:	10.1 →	10.0 ↘	10.3 *	9.2 →	10.6 *
	10.3 *	10.1 ↘	10.6 *	10.5 *	10.5 *
beste Teiler	81.2 (8.) 93.0 (5.) 108.4 (9.)				
Trefferlage	1.03 mm rechts, 0.33 mm tief				
Streuwert	1.31, horizontal: 1.57, vertikal: 0.98				

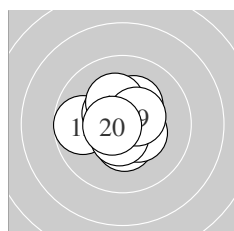

Serie 2:	10.4 *	9.7 ←	10.4 *	10.3 *	10.4 *
	10.6 *	10.5 *	10.3 *	10.5 *	10.6 *
beste Teiler	80.8 (20.) 97.0 (16.) 118.1 (17.)				
Trefferlage	0.22 mm links, 0.27 mm hoch				
Streuwert	1.15, horizontal: 1.23, vertikal: 1.07				

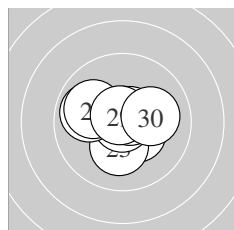

Serie 3:	10.5 *	10.4 *	10.2 *	10.8 *	10.9 *
	10.7 *	9.9 ←	10.0 ↖	10.7 *	10.1 →
beste Teiler	6.4 (25.) 49.8 (24.) 56.4 (29.)				
Trefferlage	0.08 mm links, 0.01 mm hoch				
Streuwert	1.19, horizontal: 1.42, vertikal: 0.89				

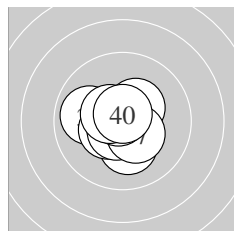

Serie 4:	10.2 *	9.9 ←	10.4 *	10.7 *	10.6 *
	10.4 *	10.4 *	10.8 *	10.5 *	10.7 *
beste Teiler	46.6 (38.) 55.0 (40.) 70.5 (34.)				
Trefferlage	0.23 mm links, 0.12 mm tief				
Streuwert	1.01, horizontal: 1.11, vertikal: 0.89				

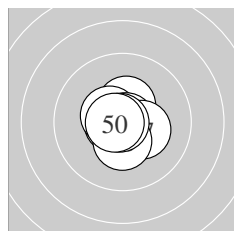

Serie 5:	10.4 *	10.6 *	10.7 *	10.5 *	10.9 *
	10.6 *	10.3 *	10.4 *	10.9 *	10.7 *
beste Teiler	23.5 (49.) 25.0 (45.) 60.2 (50.)				
Trefferlage	0.06 mm rechts, 0.18 mm tief				
Streuwert	0.73, horizontal: 0.73, vertikal: 0.74				

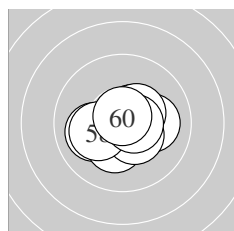

Serie 6:	10.0 ←	10.6 *	10.3 *	10.7 *	10.1 →
	10.4 *	10.4 *	10.2 *	10.6 *	10.7 *
beste Teiler	52.0 (60.) 63.0 (54.) 87.1 (59.)				
Trefferlage	0.15 mm rechts, 0.15 mm tief				
Streuwert	1.10, horizontal: 1.35, vertikal: 0.77				

Meyton Elektronik

**ISSF AR Men – Wertung – Männer**

StandNr: 131

**Piasecki, Pierre Edmond** #70817552

**StartNr: 31**

3. Dezember 2017 9:34

FRA

---

QF – Schütze hat sich fürs Finale qualifiziert

---

Unterschrift des Schützen

Meyton Elektronik

Ergebnis: **615.3** (586)  
 Serien: 102.9 100.7 102.8 100.5 103.2 105.2  
 Zähler: 47 12 1 0 0 0 0 0 0  
 Innenzehner: 41  
 weiteste: 505 (33), 352 (15), 325 (31)  
 beste Teiler 14.3 (60.) 50.1 (43.) 50.2 (45.)  
 Trefferlage 0.12 mm rechts, 0.46 mm hoch  
 Streuwert 1.36, horizontal: 1.40, vertikal: 1.33

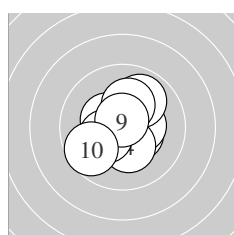
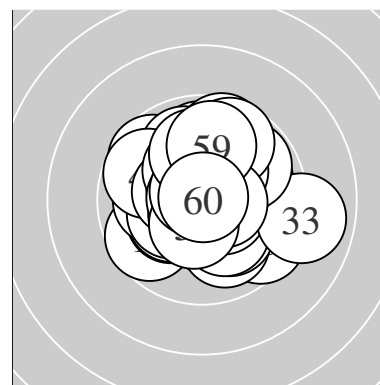

Serie 1:  
 10.6 \* 10.4 \* 10.4 \* 10.3 \* 10.4 \*  
 10.3 \* 9.9 ↗ 10.2 \* 10.7 \* 9.7 ↙  
 beste Teiler 59.4 (9.) 98.8 (1.) 131.4 (2.)  
 Trefferlage 0.00 mm , 0.02 mm tief  
 Streuwert 1.35, horizontal: 1.36, vertikal: 1.34

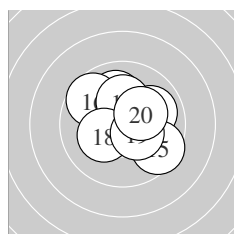

Serie 2:  
 10.5 \* 10.1 ↖ 9.9 ↘ 10.0 ↗ 9.5 ↘  
 9.7 ↘ 10.2 \* 10.2 \* 10.4 \* 10.2 \*  
 beste Teiler 125.5 (11.) 143.2 (19.) 176.1 (20.)  
 Trefferlage 0.15 mm rechts, 0.66 mm hoch  
 Streuwert 1.62, horizontal: 1.77, vertikal: 1.45

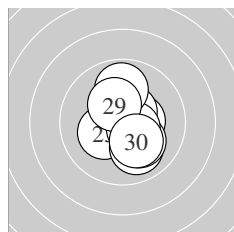

Serie 3:  
 10.6 \* 10.4 \* 10.3 \* 10.0 ↘ 10.1 ↘  
 10.5 \* 10.5 \* 9.9 ↑ 10.3 \* 10.2 \*  
 beste Teiler 94.2 (21.) 103.5 (27.) 108.0 (26.)  
 Trefferlage 0.36 mm rechts, 0.08 mm tief  
 Streuwert 1.30, horizontal: 1.01, vertikal: 1.54

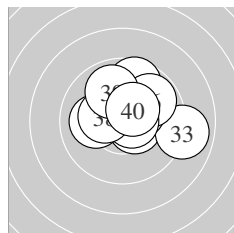

Serie 4:  
 9.7 ↗ 10.5 \* 8.9 → 10.3 \* 10.1 ←  
 9.8 ↗ 10.6 \* 10.3 \* 9.9 ↗ 10.4 \*  
 beste Teiler 77.0 (37.) 113.1 (32.) 129.0 (40.)  
 Trefferlage 0.75 mm rechts, 0.79 mm hoch  
 Streuwert 1.70, horizontal: 2.03, vertikal: 1.29

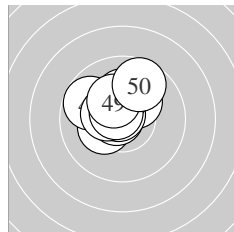

Serie 5:  
 10.3 \* 9.8 ↘ 10.8 \* 10.2 \* 10.8 \*  
 10.4 \* 10.2 \* 10.7 \* 10.3 \* 9.7 ↗  
 beste Teiler 50.1 (43.) 50.2 (45.) 75.6 (48.)  
 Trefferlage 0.51 mm links, 0.97 mm hoch  
 Streuwert 1.12, horizontal: 1.19, vertikal: 1.04

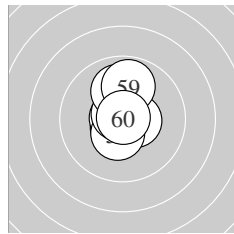

Serie 6:  
 10.8 \* 10.7 \* 10.6 \* 10.7 \* 10.5 \*  
 10.4 \* 10.7 \* 10.0 ↑ 9.9 ↑ 10.9 \*  
 beste Teiler 14.3 (60.) 50.9 (51.) 54.5 (54.)  
 Trefferlage 0.03 mm links, 0.44 mm hoch  
 Streuwert 0.93, horizontal: 0.52, vertikal: 1.21

Meyton Elektronik

**ISSF AR Men – Wertung – Männer**

StandNr: 132

**Walder, Markus #99**

**StartNr: 32**

3. Dezember 2017 9:22

ÖSB

---

\_\_\_\_\_  
Unterschrift des Schützen

Meyton Elektronik

Ergebnis:	<b>616.9</b>	(593)						
Serien:	103.2	102.4	103.2	103.7	102.1	102.3		
Zähler:	53	7	0	0	0	0	0	0
Innenzehner:	45							
weiteste:	475 (19), 385 (38), 372 (42)							
beste Teiler	12.8 (35.)	65.1 (1.)	67.2 (36.)					
Trefferlage	0.18 mm rechts, 0.13 mm hoch							
Streuwert	1.34, horizontal: 1.54, vertikal: 1.11							

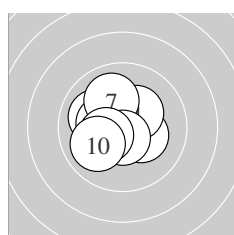
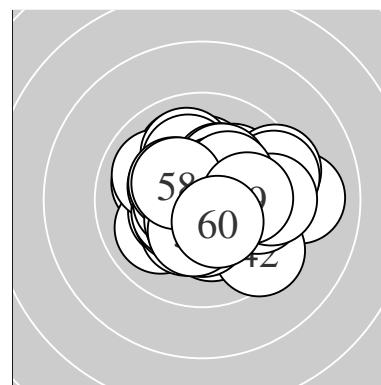

Serie 1:	10.7 *	10.3 *	10.6 *	10.3 *	10.0 ↖
	10.3 *	10.0 ↗	10.6 *	10.4 *	10.0 ↘
beste Teiler	65.1 (1.)	85.4 (3.)	86.0 (8.)		
Trefferlage	0.54 mm links, 0.13 mm hoch				
Streuwert	1.20, horizontal: 1.31, vertikal: 1.07				

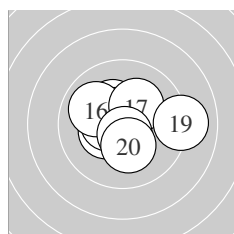

Serie 2:	10.5 *	10.4 *	10.3 *	10.6 *	10.5 *
	10.0 ↖	10.2 *	10.6 *	9.1 →	10.2 *
beste Teiler	82.5 (18.)	98.4 (14.)	119.1 (15.)		
Trefferlage	0.05 mm links, 0.27 mm hoch				
Streuwert	1.56, horizontal: 1.94, vertikal: 1.06				

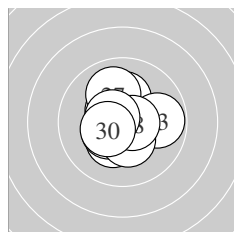

Serie 3:	10.3 *	10.2 *	9.8 →	10.5 *	10.4 *
	10.4 *	10.0 ↗	10.6 *	10.6 *	10.4 *
beste Teiler	79.3 (28.)	92.1 (29.)	124.7 (24.)		
Trefferlage	0.13 mm links, 0.13 mm hoch				
Streuwert	1.26, horizontal: 1.24, vertikal: 1.27				

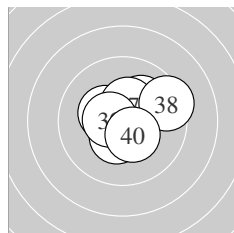

Serie 4:	10.4 *	10.6 *	10.3 *	10.1 ↗	10.9 *
	10.7 *	10.4 *	9.4 ↗	10.5 *	10.4 *
beste Teiler	12.8 (35.)	67.2 (36.)	81.8 (32.)		
Trefferlage	0.31 mm rechts, 0.26 mm hoch				
Streuwert	1.24, horizontal: 1.45, vertikal: 1.00				

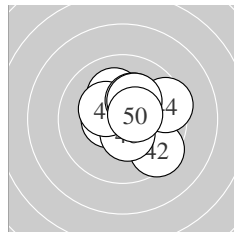

Serie 5:	10.1 ↗	9.5 ↘	10.7 *	9.5 →	10.5 *
	10.5 *	10.3 *	10.3 *	10.2 *	10.5 *
beste Teiler	74.6 (43.)	108.5 (50.)	113.4 (45.)		
Trefferlage	0.66 mm rechts, 0.28 mm hoch				
Streuwert	1.48, horizontal: 1.57, vertikal: 1.39				

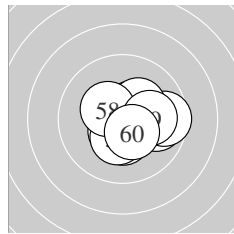

Serie 6:	10.5 *	10.3 *	9.9 →	10.5 *	10.3 *
	9.6 →	10.3 *	10.4 *	10.1 →	10.4 *
beste Teiler	108.8 (54.)	113.8 (51.)	131.2 (60.)		
Trefferlage	0.88 mm rechts, 0.25 mm tief				
Streuwert	1.27, horizontal: 1.51, vertikal: 0.99				

Meyton Elektronik

**ISSF AR Men – Wertung – Männer**

StandNr: 133

**Anrain, Julian** #70804301

**StartNr: 33**

3. Dezember 2017 9:38

T – SG Münster

---

\_\_\_\_\_  
Unterschrift des Schützen

Meyton Elektronik

Ergebnis:	<b>623.8</b>	(595) <sup>QF</sup>						
Serien:	104.0	104.6	105.9	103.1	102.3	103.9		
Zähler:	55	5	0	0	0	0	0	0
Innenzehner:	52							
weiteste:	313 (41), 274 (18), 271 (9)							
beste Teiler	38.4 (29.)	42.3 (23.)	49.2 (6.)					
Trefferlage	0.20 mm rechts, 0.57 mm hoch							
Streuwert	1.01, horizontal: 1.09, vertikal: 0.93							

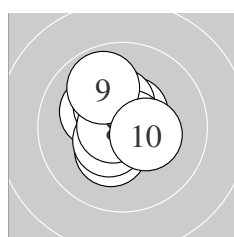
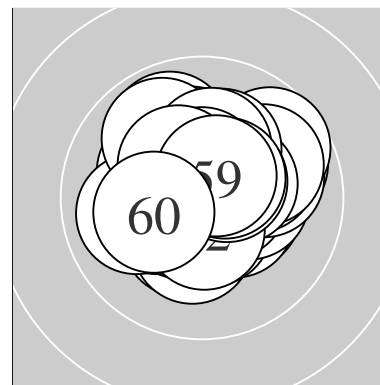

Serie 1:	10.2 *	10.3 *	10.3 *	10.5 *	10.4 *
	10.8 *	10.5 *	10.7 *	9.9 ↗	10.4 *
beste Teiler	49.2 (6.)	59.0 (8.)	104.0 (4.)		
Trefferlage	0.35 mm links, 0.43 mm hoch				
Streuwert	1.06, horizontal: 0.93, vertikal: 1.17				

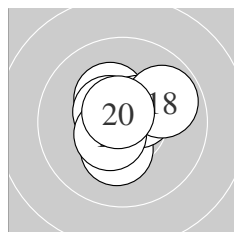

Serie 2:	10.7 *	10.6 *	10.6 *	10.3 *	10.5 *
	10.3 *	10.5 *	9.9 ↗	10.5 *	10.7 *
beste Teiler	59.0 (11.)	67.1 (20.)	79.2 (12.)		
Trefferlage	0.09 mm rechts, 0.40 mm hoch				
Streuwert	0.98, horizontal: 1.03, vertikal: 0.93				

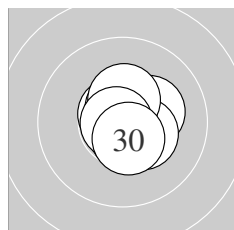

Serie 3:	10.7 *	10.7 *	10.8 *	10.3 *	10.7 *
	10.4 *	10.6 *	10.4 *	10.8 *	10.5 *
beste Teiler	38.4 (29.)	42.3 (23.)	53.8 (22.)		
Trefferlage	0.26 mm rechts, 0.08 mm hoch				
Streuwert	0.73, horizontal: 0.67, vertikal: 0.79				

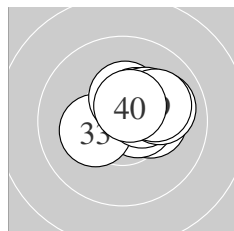

Serie 4:	10.3 *	10.6 *	10.2 *	10.4 *	10.4 *
	10.4 *	10.2 *	10.0 ↗	10.1 ↗	10.5 *
beste Teiler	94.0 (32.)	104.6 (40.)	133.2 (36.)		
Trefferlage	0.93 mm rechts, 0.62 mm hoch				
Streuwert	0.92, horizontal: 1.13, vertikal: 0.64				

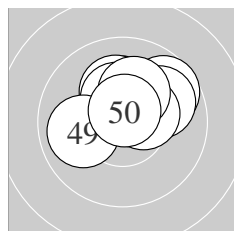

Serie 5:	9.7 ↗	10.6 *	9.9 ↗	10.2 *	10.2 *
	10.4 *	10.4 *	10.2 *	10.0 ←	10.7 *
beste Teiler	72.0 (50.)	90.0 (42.)	140.3 (47.)		
Trefferlage	0.41 mm rechts, 1.14 mm hoch				
Streuwert	1.16, horizontal: 1.43, vertikal: 0.80				

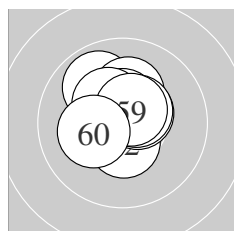

Serie 6:	9.9 ↗	10.5 *	10.2 *	10.5 *	10.6 *
	10.5 *	10.5 *	10.4 *	10.6 *	10.2 *
beste Teiler	92.2 (55.)	97.0 (59.)	110.3 (54.)		
Trefferlage	0.10 mm links, 0.76 mm hoch				
Streuwert	0.98, horizontal: 0.96, vertikal: 1.00				

Meyton Elektronik

**ISSF AR Men – Wertung – Männer**

StandNr: 134

**Strepfl, Martin #260**

**StartNr: 34**

3. Dezember 2017 9:36

ÖSB

---

QF – Schütze hat sich fürs Finale qualifiziert

---

Unterschrift des Schützen

Meyton Elektronik



Ergebnis: **621.4** (590)  
 Serien: 102.6 104.6 102.3 104.4 103.6 103.9  
 Zähler: 50 10 0 0 0 0 0 0 0  
 Innenzehner: 45  
 weiteste: 343 (21), 334 (7), 303 (42)  
 beste Teiler 6.7 (48.) 12.2 (35.) 44.4 (5.)  
 Trefferlage 0.12 mm links, 0.04 mm hoch  
 Streuwert 1.20, horizontal: 1.24, vertikal: 1.17

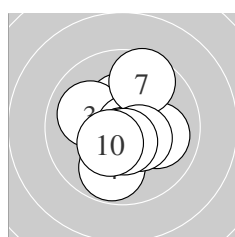
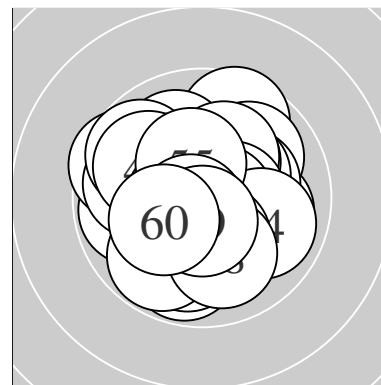

Serie 1:  
 10.4 \* 10.0 → 10.0 ↖ 9.8 ↓ 10.8 \*  
 10.6 \* 9.6 ↑ 10.4 \* 10.6 \* 10.4 \*  
 beste Teiler 44.4 (5.) 91.1 (6.) 98.7 (9.)  
 Trefferlage 0.14 mm rechts, 0.16 mm tief  
 Streuwert 1.44, horizontal: 1.26, vertikal: 1.60

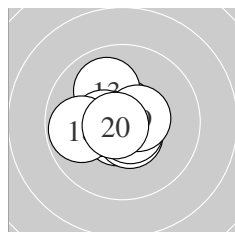

Serie 2:  
 10.7 \* 10.7 \* 10.0 ↖ 10.6 \* 10.4 \*  
 10.6 \* 10.6 \* 9.8 ← 10.5 \* 10.7 \*  
 beste Teiler 54.1 (20.) 62.6 (11.) 64.1 (12.)  
 Trefferlage 0.44 mm links, 0.01 mm hoch  
 Streuwert 0.99, horizontal: 1.10, vertikal: 0.87

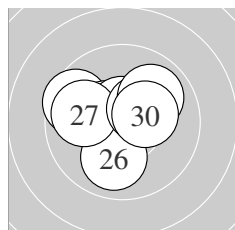

Serie 3:  
 9.6 ↖ 10.6 \* 10.5 \* 10.5 \* 10.6 \*  
 10.0 ↓ 9.9 ← 10.4 \* 9.9 ↗ 10.3 \*  
 beste Teiler 81.5 (22.) 84.3 (25.) 107.2 (24.)  
 Trefferlage 0.21 mm links, 0.56 mm hoch  
 Streuwert 1.42, horizontal: 1.69, vertikal: 1.09

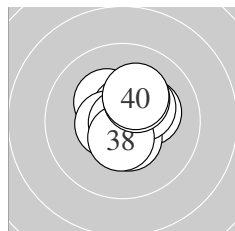

Serie 4:  
 10.2 \* 10.3 \* 10.7 \* 10.5 \* 10.9 \*  
 10.5 \* 10.3 \* 10.5 \* 10.3 \* 10.2 \*  
 beste Teiler 12.2 (35.) 72.5 (33.) 101.0 (34.)  
 Trefferlage 0.32 mm rechts, 0.40 mm hoch  
 Streuwert 0.97, horizontal: 0.93, vertikal: 1.01

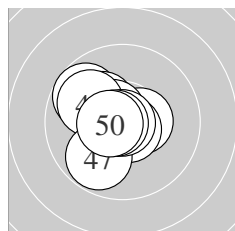

Serie 5:  
 10.5 \* 9.7 ↖ 10.2 \* 10.7 \* 10.6 \*  
 9.9 ↖ 9.8 ↗ 10.9 \* 10.7 \* 10.6 \*  
 beste Teiler 6.7 (48.) 51.6 (49.) 62.0 (44.)  
 Trefferlage 0.82 mm links, 0.18 mm hoch  
 Streuwert 1.14, horizontal: 1.14, vertikal: 1.15

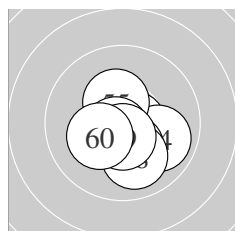

Serie 6:  
 10.4 \* 10.7 \* 10.7 \* 9.9 → 10.4 \*  
 10.3 \* 10.7 \* 10.0 ↓ 10.6 \* 10.2 \*  
 beste Teiler 60.8 (53.) 66.4 (57.) 68.4 (52.)  
 Trefferlage 0.24 mm rechts, 0.73 mm tief  
 Streuwert 1.02, horizontal: 1.06, vertikal: 0.97

Meyton Elektronik

**ISSF AR Men – Wertung – Männer**

StandNr: 135

**Raynaud, Alexis** #70817557

**StartNr: 35**

3. Dezember 2017 9:17

FRA

---

\_\_\_\_\_  
Unterschrift des Schützen

Meyton Elektronik

Ergebnis:	<b>625.8</b>	(596) <sup>QF</sup>							
Serien:	104.8	104.1	104.5	105.7	103.9	102.8			
Zähler:	56	4	0	0	0	0	0	0	0
Innenzehner:	54								
weiteste:	385 (60), 364 (51), 296 (42)								
beste Teiler	11.0 (39.) 14.3 (40.) 16.1 (43.)								
Trefferlage	0.00 mm , 0.00 mm								
Streuwert	1.07, horizontal: 1.12, vertikal: 1.01								

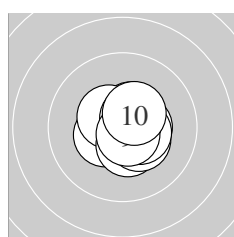
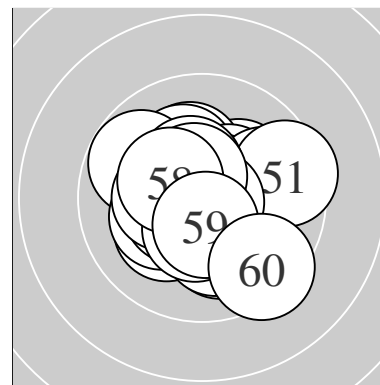

Serie 1:	10.5 *	10.4 *	10.5 *	10.4 *	10.4 *
	10.4 *	10.5 *	10.6 *	10.7 *	10.4 *
beste Teiler	62.8 (9.) 89.8 (8.) 111.8 (1.)				
Trefferlage	0.42 mm rechts, 0.02 mm tief				
Streuwert	0.83, horizontal: 0.86, vertikal: 0.80				

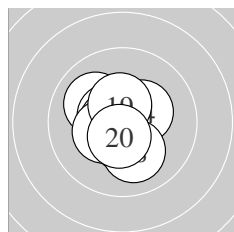

Serie 2:	10.0 ↖	10.8 *	10.4 *	10.3 *	10.5 *
	10.6 *	10.4 *	10.1 ↓	10.5 *	10.5 *
beste Teiler	48.7 (12.) 81.0 (16.) 102.8 (20.)				
Trefferlage	0.35 mm links, 0.15 mm tief				
Streuwert	1.03, horizontal: 0.96, vertikal: 1.10				

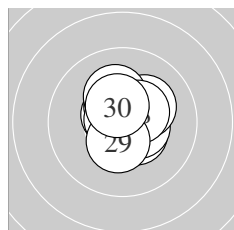

Serie 3:	10.5 *	10.6 *	10.5 *	10.5 *	10.2 *
	10.7 *	10.2 *	10.4 *	10.4 *	10.5 *
beste Teiler	51.6 (26.) 87.2 (22.) 115.5 (23.)				
Trefferlage	0.17 mm rechts, 0.41 mm hoch				
Streuwert	0.92, horizontal: 0.87, vertikal: 0.98				

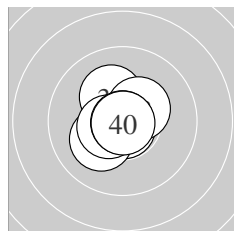

Serie 4:	10.4 *	10.7 *	10.7 *	10.8 *	10.2 *
	10.2 *	10.5 *	10.4 *	10.9 *	10.9 *
beste Teiler	11.0 (39.) 14.3 (40.) 41.7 (34.)				
Trefferlage	0.30 mm links, 0.14 mm hoch				
Streuwert	0.82, horizontal: 0.75, vertikal: 0.88				

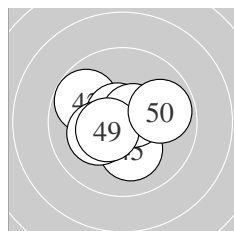

Serie 5:	10.4 *	9.8 ↖	10.9 *	10.7 *	10.2 *
	10.7 *	10.6 *	10.2 *	10.5 *	9.9 →
beste Teiler	16.1 (43.) 62.4 (46.) 64.0 (44.)				
Trefferlage	0.09 mm links, 0.16 mm tief				
Streuwert	1.26, horizontal: 1.45, vertikal: 1.03				

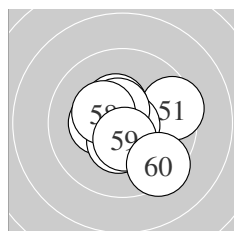

Serie 6:	9.5 →	10.8 *	10.4 *	10.6 *	10.6 *
	10.3 *	10.4 *	10.3 *	10.5 *	9.4 ↘
beste Teiler	41.6 (52.) 97.4 (54.) 98.0 (55.)				
Trefferlage	0.20 mm rechts, 0.24 mm tief				
Streuwert	1.47, horizontal: 1.61, vertikal: 1.31				

**ISSF AR Men – Wertung – Männer**

StandNr: 136

**Höllwarth, Michael #30**

**StartNr: 36**

3. Dezember 2017 9:35

ÖSB

---

QF – Schütze hat sich fürs Finale qualifiziert

---

Unterschrift des Schützen

Meyton Elektronik

Ergebnis:	<b>625.8</b>	(594) <sup>QF</sup>							
Serien:	103.7	105.5	104.5	103.9	104.4	103.8			
Zähler:	54	6	0	0	0	0	0	0	0
Innenzehner:	49								
weiteste:	312 (54), 282 (55), 272 (36)								
beste Teiler	10.0 (26.)	12.7 (56.)	30.8 (57.)						
Trefferlage	0.10 mm rechts,	0.00 mm							
Streuwert	1.06, horizontal: 1.07, vertikal: 1.06								

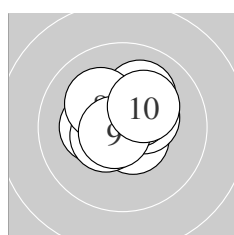
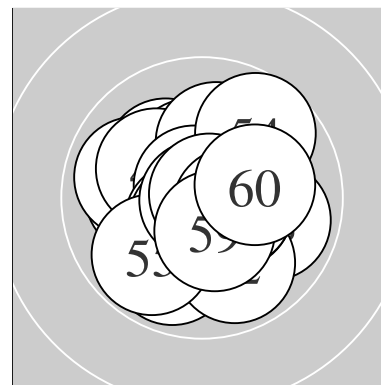

Serie 1:

10.6 *	10.3 *	10.3 *	10.4 *	10.1 ↗
10.5 *	10.4 *	10.2 *	10.7 *	10.2 *
beste Teiler	59.3 (9.)	94.0 (1.)	116.2 (6.)	
Trefferlage	0.14 mm rechts, 0.59 mm hoch			
Streuwert	1.05, horizontal: 1.17, vertikal: 0.92			

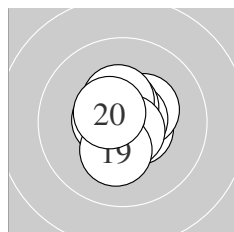

Serie 2:

10.6 *	10.4 *	10.7 *	10.6 *	10.4 *
10.7 *	10.7 *	10.6 *	10.2 *	10.6 *
beste Teiler	59.1 (13.)	64.6 (16.)	65.2 (17.)	
Trefferlage	0.04 mm rechts, 0.06 mm hoch			
Streuwert	0.82, horizontal: 0.72, vertikal: 0.91			

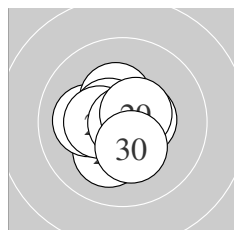

Serie 3:

10.2 *	10.1 ←	10.3 *	10.6 *	10.4 *
10.9 *	10.6 *	10.5 *	10.6 *	10.3 *
beste Teiler	10.0 (26.)	96.7 (24.)	97.6 (29.)	
Trefferlage	0.21 mm links, 0.06 mm tief			
Streuwert	1.03, horizontal: 1.10, vertikal: 0.96			

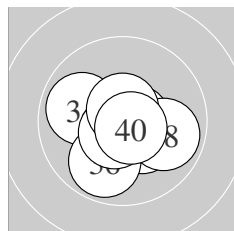

Serie 4:

10.6 *	10.7 *	10.6 *	9.9 ↖	10.3 *
9.9 ↙	10.6 *	9.9 ↘	10.7 *	10.7 *
beste Teiler	66.7 (40.)	73.0 (32.)	73.0 (39.)	
Trefferlage	0.06 mm rechts, 0.51 mm tief			
Streuwert	1.18, horizontal: 1.39, vertikal: 0.93			

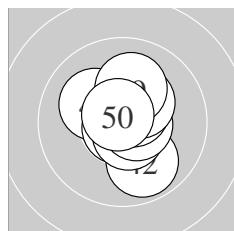

Serie 5:

10.7 *	9.9 ↘	10.1 ↖	10.8 *	10.6 *
10.6 *	10.6 *	10.3 *	10.1 ↑	10.7 *
beste Teiler	45.6 (44.)	54.0 (50.)	61.6 (41.)	
Trefferlage	0.19 mm rechts, 0.23 mm hoch			
Streuwert	1.08, horizontal: 0.88, vertikal: 1.24			

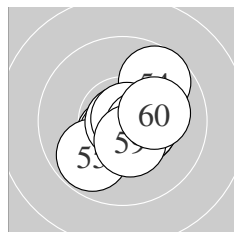

Serie 6:

10.5 *	10.5 *	10.6 *	9.7 ↗	9.8 ↙
10.9 *	10.8 *	10.5 *	10.4 *	10.1 →
beste Teiler	12.7 (56.)	30.8 (57.)	100.7 (53.)	
Trefferlage	0.38 mm rechts, 0.28 mm tief			
Streuwert	1.21, horizontal: 1.22, vertikal: 1.20			

**ISSF AR Men – Wertung – Männer**

StandNr: 138

**Mathis, Thomas** #266

**StartNr: 38**

3. Dezember 2017 9:16

ÖSB

---

QF – Schütze hat sich fürs Finale qualifiziert

---

Unterschrift des Schützen

Meyton Elektronik

Ergebnis:	<b>584.6</b>	(560)
Serien:	98.8 95.8 99.9 97.7 97.0 95.4	
Zähler:	25 30 5 0 0 0 0 0 0 0	
Innenzehner:	15	
weiteste:	645 (58), 641 (12), 627 (46)	
beste Teiler	40.8 (3.) 85.0 (30.) 86.8 (40.)	
Trefferlage	0.83 mm links, 1.00 mm hoch	
Streuwert	2.20, horizontal: 2.59, vertikal: 1.71	

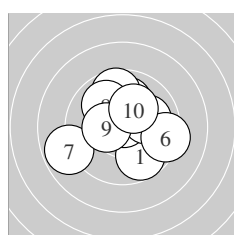
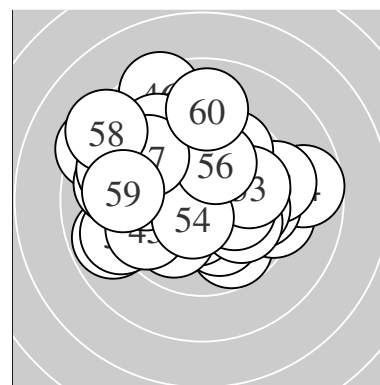

Serie 1:					
	9.7 ↘	10.0 ↑	10.8 *	10.0 →	9.7 ↑
	9.3 →	8.8 ←	9.9 ↘	10.4 *	10.2 *
beste Teiler	40.8 (3.) 146.0 (9.) 195.8 (10.)				
Trefferlage	0.08 mm rechts, 0.46 mm hoch				
Streuwert	2.17, horizontal: 2.41, vertikal: 1.90				

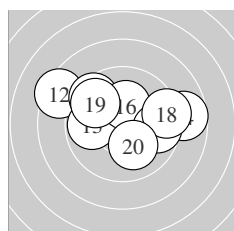

Serie 2:					
	10.3 *	8.4 ↖	9.8 ←	8.7 →	9.5 ↘
	10.3 *	9.7 →	9.3 →	9.7 ↖	10.1 ↘
beste Teiler	153.1 (11.) 175.4 (16.) 213.7 (20.)				
Trefferlage	0.17 mm rechts, 0.84 mm hoch				
Streuwert	2.72, horizontal: 3.56, vertikal: 1.44				

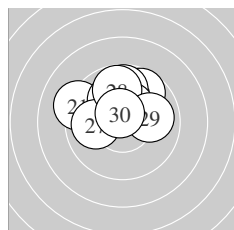

Serie 3:					
	9.2 ↖	9.7 ↗	10.4 *	10.1 ↖	9.8 ↑
	10.3 *	10.0 ←	9.8 ↑	10.0 →	10.6 *
beste Teiler	85.0 (30.) 144.0 (23.) 153.0 (26.)				
Trefferlage	0.40 mm links, 1.58 mm hoch				
Streuwert	1.52, horizontal: 1.87, vertikal: 1.07				

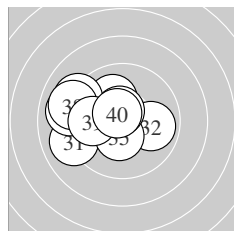

Serie 4:					
	9.0 ←	9.9 →	10.1 ↖	9.0 ←	10.4 *
	10.6 *	9.1 ↖	9.1 ↖	9.9 ←	10.6 *
beste Teiler	86.8 (40.) 97.5 (36.) 139.2 (35.)				
Trefferlage	1.99 mm links, 0.44 mm hoch				
Streuwert	1.99, horizontal: 2.48, vertikal: 1.34				

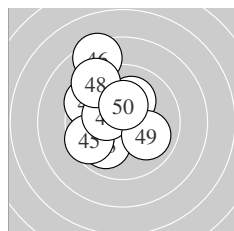

Serie 5:					
	9.7 ↖	10.1 ↗	9.9 ↙	9.5 ↖	9.6 ←
	8.4 ↖	10.3 *	9.2 ↖	10.0 →	10.3 *
beste Teiler	154.1 (50.) 157.6 (47.) 207.6 (42.)				
Trefferlage	1.35 mm links, 1.17 mm hoch				
Streuwert	2.12, horizontal: 1.79, vertikal: 2.41				

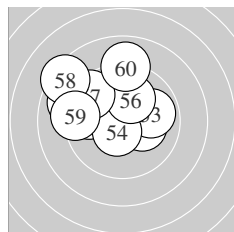

Serie 6:					
	9.7 ↖	10.2 *	9.9 →	10.5 *	9.0 ↖
	10.1 ↑	9.4 ↖	8.4 ↖	9.2 ←	9.0 ↑
beste Teiler	108.7 (54.) 185.8 (52.) 215.1 (56.)				
Trefferlage	1.53 mm links, 1.51 mm hoch				
Streuwert	2.40, horizontal: 2.84, vertikal: 1.85				

Meyton Elektronik

**ISSF AR Men – Wertung – Männer**

StandNr: 139

**Tipotsch, Michael** #70817571

**StartNr: 39**

3. Dezember 2017 9:31

T – SG Mayerhofen

---

Unterschrift des Schützen

---

Meyton Elektronik



Ergebnis: **620.3** (591)  
 Serien: 104.1 104.2 102.8 103.8 102.9 102.5  
 Zähler: 51 9 0 0 0 0 0 0 0 0  
 Innenzehner: 46  
 weiteste: 374 (29), 324 (45), 320 (51)  
 beste Teiler 19.6 (8.) 22.0 (11.) 47.5 (1.)  
 Trefferlage 0.04 mm links, 0.08 mm hoch  
 Streuwert 1.24, horizontal: 1.20, vertikal: 1.27

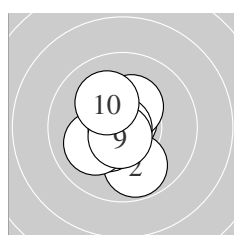
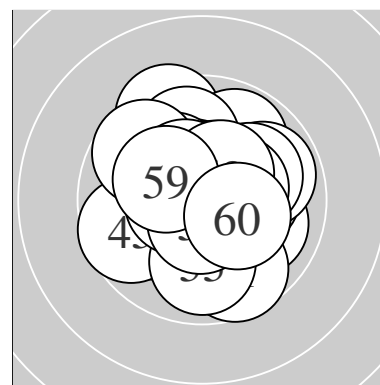

Serie 1:  
 10.8 \* 9.8 ↓ 10.4 \* 10.6 \* 10.4 \*  
 10.3 \* 10.1 ↙ 10.9 \* 10.7 \* 10.1 ↘  
 beste Teiler 19.6 (8.) 47.5 (1.) 67.4 (9.)  
 Trefferlage 0.41 mm links, 0.16 mm tief  
 Streuwert 1.12, horizontal: 0.88, vertikal: 1.31

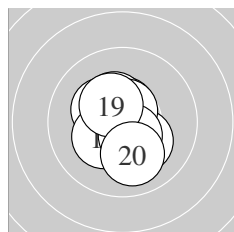

Serie 2:  
 10.9 \* 10.3 \* 10.3 \* 10.6 \* 10.4 \*  
 10.2 \* 10.6 \* 10.5 \* 10.4 \* 10.0 ↓  
 beste Teiler 22.0 (11.) 81.7 (17.) 94.1 (14.)  
 Trefferlage 0.10 mm links, 0.04 mm tief  
 Streuwert 1.08, horizontal: 0.89, vertikal: 1.25

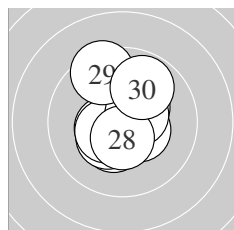

Serie 3:  
 10.4 \* 10.4 \* 10.4 \* 10.5 \* 10.4 \*  
 10.4 \* 10.5 \* 10.5 \* 9.5 ↗ 9.8 ↖  
 beste Teiler 110.0 (28.) 112.2 (27.) 122.4 (24.)  
 Trefferlage 0.07 mm links, 0.24 mm hoch  
 Streuwert 1.39, horizontal: 1.12, vertikal: 1.62

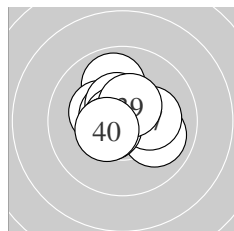

Serie 4:  
 9.9 ↑ 10.3 \* 10.6 \* 10.5 \* 10.8 \*  
 10.0 ↘ 10.2 \* 10.5 \* 10.5 \* 10.5 \*  
 beste Teiler 50.9 (35.) 92.1 (33.) 102.9 (38.)  
 Trefferlage 0.12 mm links, 0.41 mm hoch  
 Streuwert 1.16, horizontal: 1.27, vertikal: 1.02

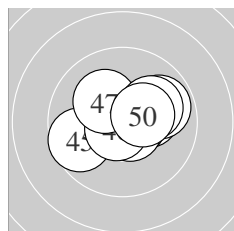

Serie 5:  
 10.2 \* 10.6 \* 10.4 \* 10.7 \* 9.7 ↙  
 10.7 \* 10.2 \* 9.9 ↗ 10.1 ↗ 10.4 \*  
 beste Teiler 63.0 (46.) 72.8 (44.) 84.0 (42.)  
 Trefferlage 0.56 mm rechts, 0.27 mm hoch  
 Streuwert 1.33, horizontal: 1.68, vertikal: 0.84

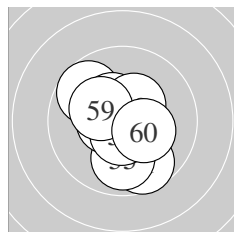

Serie 6:  
 9.7 ↓ 9.7 ↘ 10.7 \* 10.4 \* 9.9 ↓  
 10.5 \* 10.6 \* 10.4 \* 10.3 \* 10.3 \*  
 beste Teiler 71.0 (53.) 87.2 (57.) 101.3 (56.)  
 Trefferlage 0.13 mm links, 0.18 mm tief  
 Streuwert 1.45, horizontal: 1.28, vertikal: 1.61

Meyton Elektronik

**ISSF AR Men – Wertung – Männer**

StandNr: 140

**Kostenzer, Thomas** #70804294

**StartNr: 40**

3. Dezember 2017 9:34

T – SG Münster

---

\_\_\_\_\_  
Unterschrift des Schützen

Meyton Elektronik

Ergebnis: **596.5** (570)  
 Serien: 97.7 103.2 96.2 99.1 99.8 100.5  
 0.0  
 Zähler: 33 24 3 0 0 0 0 0 0 0  
 Innenzehner: 25  
 weiteste: 645 (51), 595 (28), 547 (7)  
 beste Teiler 39.2 (57.) 50.4 (17.) 71.5 (13.)  
 Trefferlage 0.08 mm links, 0.65 mm hoch  
 Streuwert 2.04, horizontal: 2.43, vertikal: 1.56

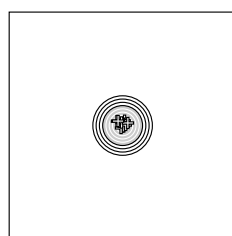
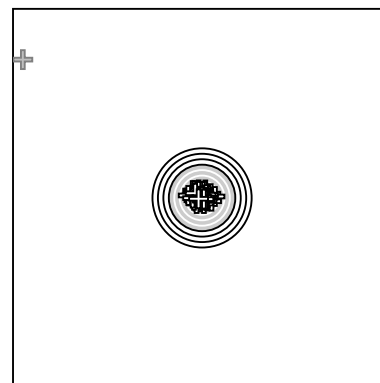

Serie 1:  
 9.4 ↗ 10.7 \* 10.1 ↙ 10.0 ↗ 10.5 \*  
 10.0 → 8.8 ↘ 10.0 ↕ 9.2 ↗ 9.0 ↘  
 beste Teiler 75.3 (2.) 111.5 (5.) 215.7 (3.)  
 Trefferlage 0.12 mm rechts, 1.33 mm hoch  
 Streuwert 2.30, horizontal: 2.62, vertikal: 1.94

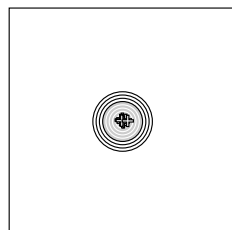

Serie 2:  
 10.4 \* 10.1 ↑ 10.7 \* 9.9 ↗ 10.6 \*  
 10.5 \* 10.8 \* 10.2 \* 10.6 \* 9.4 →  
 beste Teiler 50.4 (17.) 71.5 (13.) 80.6 (15.)  
 Trefferlage 0.41 mm rechts, 0.63 mm hoch  
 Streuwert 1.31, horizontal: 1.64, vertikal: 0.87

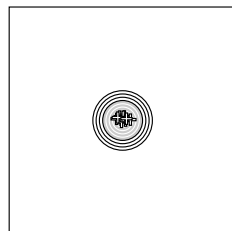

Serie 3:  
 9.6 ↗ 9.4 ↘ 10.4 \* 10.4 \* 9.8 ↑  
 10.0 → 9.1 ← 8.6 → 9.2 ↘ 9.7 →  
 beste Teiler 132.0 (23.) 136.0 (24.) 229.1 (26.)  
 Trefferlage 0.04 mm rechts, 1.41 mm hoch  
 Streuwert 2.48, horizontal: 3.20, vertikal: 1.42

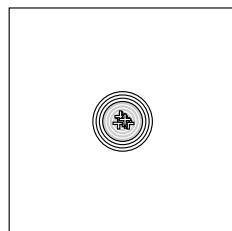

Serie 4:  
 10.0 ↘ 9.1 ↘ 9.9 → 9.7 ↑ 10.5 \*  
 10.3 \* 9.6 ← 9.3 ↘ 10.7 \* 10.0 →  
 beste Teiler 72.4 (39.) 111.8 (35.) 166.6 (36.)  
 Trefferlage 0.81 mm rechts, 0.69 mm hoch  
 Streuwert 1.96, horizontal: 2.15, vertikal: 1.76

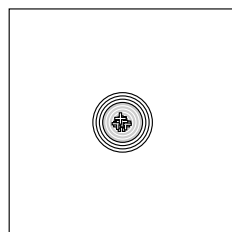

Serie 5:  
 9.9 ↓ 10.3 \* 10.5 \* 10.2 \* 9.5 ←  
 9.9 ↘ 9.9 ← 9.4 ← 10.6 \* 9.6 ↑  
 beste Teiler 81.5 (49.) 114.3 (43.) 174.8 (42.)  
 Trefferlage 0.63 mm links, 0.30 mm tief  
 Streuwert 1.90, horizontal: 2.10, vertikal: 1.68

Meyton Elektronik

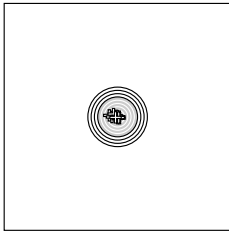

Serie 6:  
 8.4 ←                      10.5 \*                      10.4 \*                      9.2 ←                      9.4 ↗  
 10.3 \*                      10.8 \*                      10.6 \*                      10.6 \*                      10.3 \*  
 beste Teiler              39.2 (57.) 99.6 (58.) 99.8 (59.)  
 Trefferlage              1.26 mm links, 0.16 mm hoch  
 Streuwert                1.97, horizontal: 2.60, vertikal: 0.99

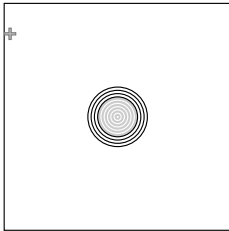

Serie 7:  
 0.0+  
AST.NSC  
 beste Teiler  
 Trefferlage              0.00 mm , 0.00 mm  
 Streuwert                0.00, horizontal: 0.00, vertikal: 0.00

AST                      – Treffer wurde nach Ende der Schießzeit abgegeben  
 NSC                      – Treffer wurde vermessen, geht aber nicht in die Wertung ein

Unterschrift des Schützen

Ergebnis: **625.0** (595)<sup>QF</sup>  
 Serien: 103.8 104.5 104.9 104.9 102.3 104.6  
 Zähler: 55 5 0 0 0 0 0 0 0 0  
 Innenzehner: 51  
 weiteste: 399 (6), 284 (11), 280 (41)  
 beste Teiler 5.3 (12.) 10.7 (57.) 18.1 (36.)  
 Trefferlage 0.17 mm links, 0.16 mm hoch  
 Streuwert 1.07, horizontal: 1.09, vertikal: 1.06

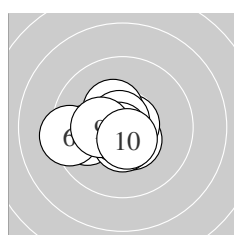
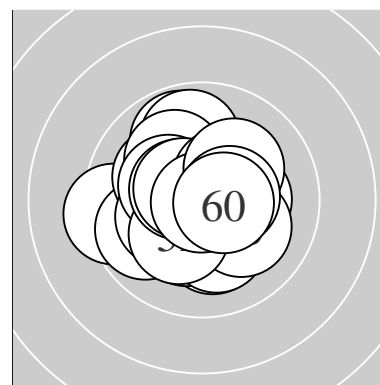

Serie 1:  
 9.9 ← 10.5 \* 10.5 \* 10.7 \* 10.4 \*  
 9.4 ← 10.7 \* 10.8 \* 10.3 \* 10.6 \*  
 beste Teiler 49.8 (8.) 53.4 (4.) 53.6 (7.)  
 Trefferlage 0.79 mm links, 0.25 mm tief  
 Streuwert 1.18, horizontal: 1.50, vertikal: 0.75

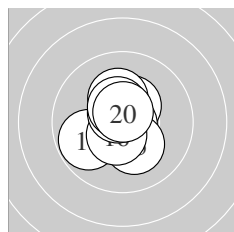

Serie 2:  
 9.8 ↙ 10.9 \* 10.4 \* 10.8 \* 10.2 \*  
 10.5 \* 10.2 \* 10.6 \* 10.5 \* 10.6 \*  
 beste Teiler 5.3 (12.) 36.2 (14.) 76.0 (20.)  
 Trefferlage 0.21 mm links, 0.15 mm hoch  
 Streuwert 1.05, horizontal: 0.93, vertikal: 1.16

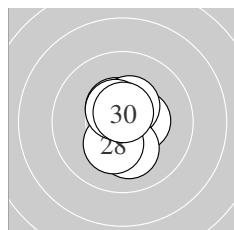

Serie 3:  
 10.8 \* 10.5 \* 10.4 \* 10.4 \* 10.7 \*  
 10.5 \* 10.1 ↓ 10.3 \* 10.5 \* 10.7 \*  
 beste Teiler 38.6 (21.) 57.9 (25.) 72.1 (30.)  
 Trefferlage 0.05 mm rechts, 0.00 mm  
 Streuwert 0.92, horizontal: 0.63, vertikal: 1.15

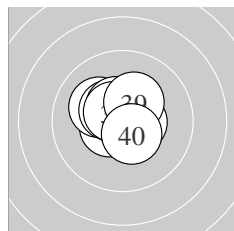

Serie 4:  
 10.5 \* 10.1 ↖ 10.6 \* 10.4 \* 10.5 \*  
 10.9 \* 10.5 \* 10.6 \* 10.3 \* 10.5 \*  
 beste Teiler 18.1 (36.) 84.8 (33.) 96.1 (38.)  
 Trefferlage 0.17 mm links, 0.43 mm hoch  
 Streuwert 0.85, horizontal: 0.95, vertikal: 0.74

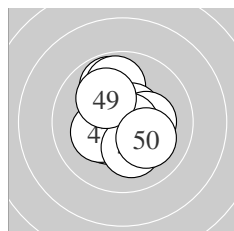

Serie 5:  
 9.8 ↗ 9.9 ↑ 10.4 \* 10.6 \* 10.2 \*  
 10.8 \* 10.2 \* 10.2 \* 10.1 ↘ 10.1 ↘  
 beste Teiler 44.9 (46.) 92.6 (44.) 138.4 (43.)  
 Trefferlage 0.01 mm links, 0.29 mm hoch  
 Streuwert 1.43, horizontal: 1.23, vertikal: 1.60

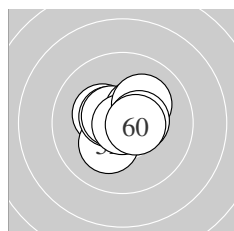

Serie 6:  
 10.3 \* 10.2 \* 10.5 \* 10.4 \* 10.6 \*  
 10.4 \* 10.9 \* 10.2 \* 10.5 \* 10.6 \*  
 beste Teiler 10.7 (57.) 96.5 (55.) 96.8 (60.)  
 Trefferlage 0.11 mm rechts, 0.34 mm hoch  
 Streuwert 0.98, horizontal: 1.12, vertikal: 0.81

Meyton Elektronik

**ISSF AR Men – Wertung – Männer**

StandNr: 142

**Schmir, Alexander #264**

**StartNr: 42**

3. Dezember 2017 9:39

ÖSB

---

QF – Schütze hat sich fürs Finale qualifiziert

---

Unterschrift des Schützen

Meyton Elektronik

Ergebnis: **605.8** (576)  
 Serien: 97.7 100.1 104.4 100.3 102.7 100.6  
 Zähler: 36 24 0 0 0 0 0 0 0  
 Innenzehner: 27  
 weiteste: 430 (4), 429 (11), 407 (9)  
 beste Teiler 37.3 (21.) 47.8 (1.) 64.9 (28.)  
 Trefferlage 0.24 mm rechts, 0.16 mm hoch  
 Streuwert 1.67, horizontal: 1.76, vertikal: 1.58

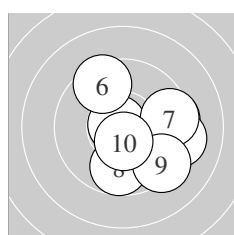
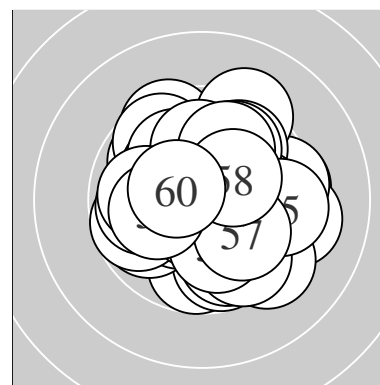

Serie 1:  
 10.8 \* 9.9 ↘ 9.5 → 9.2 → 9.8 ↘  
 9.5 ↖ 9.5 → 9.7 ↓ 9.3 ↘ 10.5 \*  
 beste Teiler 47.8 (1.) 109.2 (10.) 264.7 (2.)  
 Trefferlage 1.69 mm rechts, 0.58 mm tief  
 Streuwert 1.97, horizontal: 2.05, vertikal: 1.87

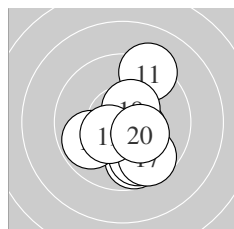

Serie 2:  
 9.2 ↗ 9.7 ↓ 10.5 \* 9.8 ↘ 9.8 ↖  
 10.3 \* 9.6 ↘ 10.5 \* 10.4 \* 10.3 \*  
 beste Teiler 120.7 (18.) 123.9 (13.) 138.7 (19.)  
 Trefferlage 0.67 mm rechts, 0.81 mm tief  
 Streuwert 1.72, horizontal: 1.37, vertikal: 2.01

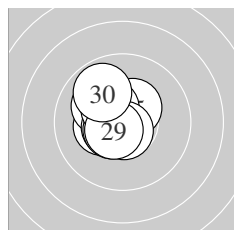

Serie 3:  
 10.8 \* 10.3 \* 10.1 ↖ 10.6 \* 10.4 \*  
 10.6 \* 10.4 \* 10.7 \* 10.6 \* 9.9 ↖  
 beste Teiler 37.3 (21.) 64.9 (28.) 89.9 (29.)  
 Trefferlage 0.72 mm links, 0.27 mm hoch  
 Streuwert 0.93, horizontal: 0.81, vertikal: 1.04

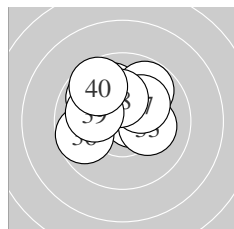

Serie 4:  
 10.0 ↖ 10.6 \* 10.2 \* 9.8 ↗ 9.8 ↖  
 9.7 ↖ 10.2 \* 10.2 \* 10.1 ↖ 9.7 ↖  
 beste Teiler 77.6 (32.) 177.0 (38.) 192.4 (37.)  
 Trefferlage 0.43 mm links, 1.15 mm hoch  
 Streuwert 1.55, horizontal: 1.80, vertikal: 1.25

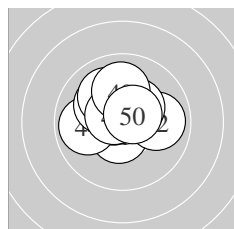

Serie 5:  
 10.6 \* 9.9 → 10.6 \* 9.9 ← 10.1 ↖  
 10.0 ↖ 10.4 \* 10.6 \* 10.0 ↑ 10.6 \*  
 beste Teiler 84.0 (43.) 84.0 (48.) 97.1 (41.)  
 Trefferlage 0.28 mm links, 0.72 mm hoch  
 Streuwert 1.26, horizontal: 1.47, vertikal: 1.00

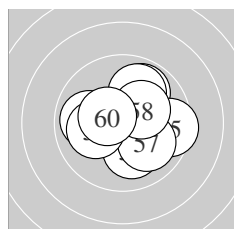

Serie 6:  
 9.9 ↗ 10.1 ↓ 10.5 \* 9.9 ↗ 9.5 →  
 9.9 ← 10.0 ↘ 10.3 \* 10.1 ← 10.4 \*  
 beste Teiler 120.8 (53.) 128.5 (60.) 175.6 (58.)  
 Trefferlage 0.53 mm rechts, 0.26 mm hoch  
 Streuwert 1.68, horizontal: 1.91, vertikal: 1.43

Meyton Elektronik

**ISSF AR Men – Wertung – Männer**

StandNr: 143

**Sohm, Jodok** #103

**StartNr: 43**

3. Dezember 2017 9:17

VBG

---

\_\_\_\_\_  
Unterschrift des Schützen

Meyton Elektronik



Ergebnis:	<b>623.0</b>	(598)							
Serien:	104.8	102.5	103.9	103.5	103.9	104.4			
Zähler:	58	2	0	0	0	0	0	0	0
Innenzehner:	50								
weiteste:	272 (13), 264 (22), 243 (42)								
beste Teiler	60.1 (16.) 62.3 (35.) 67.6 (36.)								
Trefferlage	0.07 mm links, 0.11 mm hoch								
Streuwert	1.10, horizontal: 1.04, vertikal: 1.14								

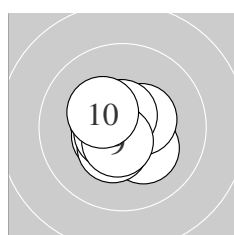
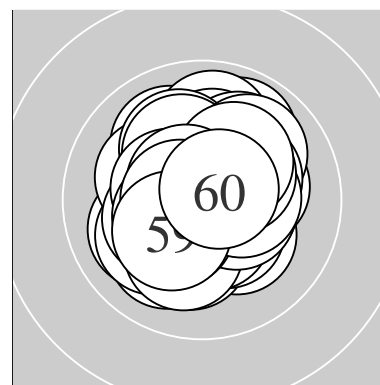

Serie 1:					
	10.5 *	10.5 *	10.2 *	10.5 *	10.4 *
	10.5 *	10.7 *	10.6 *	10.6 *	10.3 *
beste Teiler	74.3 (7.) 88.2 (8.) 93.6 (9.)				
Trefferlage	0.21 mm links, 0.26 mm tief				
Streuwert	0.88, horizontal: 0.91, vertikal: 0.85				

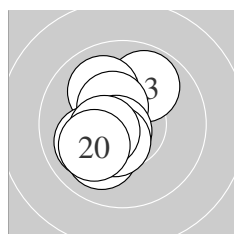

Serie 2:					
	10.3 *	10.0 ↙	9.9 ↗	10.0 ↘	10.5 *
	10.7 *	10.0 ↖	10.5 *	10.5 *	10.1 ↙
beste Teiler	60.1 (16.) 115.4 (18.) 124.1 (15.)				
Trefferlage	0.86 mm links, 0.21 mm tief				
Streuwert	1.25, horizontal: 0.94, vertikal: 1.51				

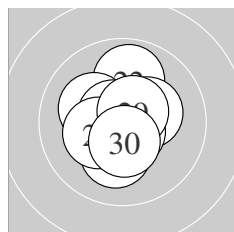

Serie 3:					
	10.5 *	9.9 ↑	10.2 *	10.3 *	10.7 *
	10.2 *	10.7 *	10.3 *	10.6 *	10.5 *
beste Teiler	71.2 (27.) 73.6 (25.) 92.6 (29.)				
Trefferlage	0.16 mm links, 0.17 mm hoch				
Streuwert	1.16, horizontal: 1.01, vertikal: 1.29				

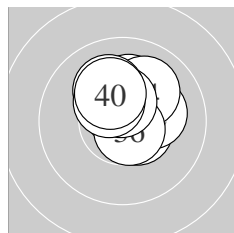

Serie 4:					
	10.5 *	10.2 *	10.2 *	10.0 ↗	10.7 *
	10.7 *	10.5 *	10.1 ↘	10.4 *	10.2 *
beste Teiler	62.3 (35.) 67.6 (36.) 105.6 (31.)				
Trefferlage	0.21 mm rechts, 0.99 mm hoch				
Streuwert	0.94, horizontal: 0.94, vertikal: 0.95				

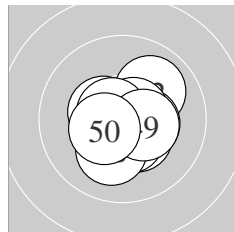

Serie 5:					
	10.4 *	10.0 ↗	10.5 *	10.4 *	10.6 *
	10.4 *	10.7 *	10.1 ↘	10.4 *	10.4 *
beste Teiler	74.2 (47.) 76.9 (45.) 122.0 (43.)				
Trefferlage	0.26 mm rechts, 0.25 mm tief				
Streuwert	1.06, horizontal: 1.10, vertikal: 1.03				

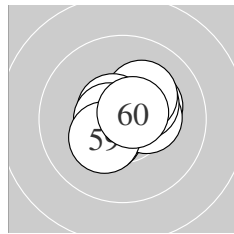

Serie 6:					
	10.3 *	10.7 *	10.4 *	10.4 *	10.3 *
	10.2 *	10.6 *	10.6 *	10.3 *	10.6 *
beste Teiler	69.3 (52.) 76.0 (60.) 83.0 (58.)				
Trefferlage	0.31 mm rechts, 0.24 mm hoch				
Streuwert	0.97, horizontal: 1.09, vertikal: 0.82				

Meyton Elektronik

**ISSF AR Men – Wertung – Männer**

StandNr: 144

**Entrichel, Alés** #70804305

**StartNr: 44**

3. Dezember 2017 9:25

CZE – Dukla Pilsen

---

\_\_\_\_\_  
Unterschrift des Schützen

Meyton Elektronik

Ergebnis:	<b>615.9</b>	(588)							
Serien:	99.6	103.9	103.5	103.1	103.3	102.5			
Zähler:	48	12	0	0	0	0	0	0	0
Innenzehner:	41								
weiteste:	465 (6), 416 (57), 413 (4)								
beste Teiler	46.5 (60.) 47.6 (16.) 55.4 (29.)								
Trefferlage	0.73 mm rechts, 0.29 mm hoch								
Streuwert	1.30, horizontal: 1.45, vertikal: 1.13								

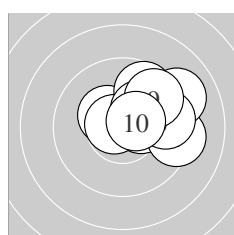
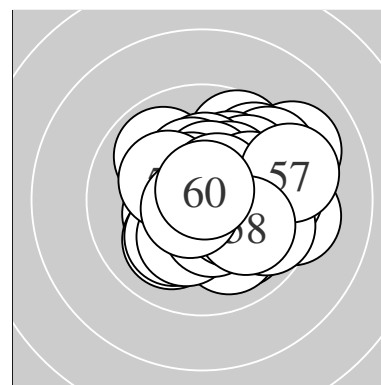

Serie 1:

10.4 *	10.4 *	9.7 ↗	9.3 →	10.7 *
9.1 ↗	9.6 →	10.2 *	9.7 ↗	10.5 *
beste Teiler	66.7 (5.)	110.0 (10.)	142.2 (2.)	
Trefferlage	1.73 mm rechts, 1.01 mm hoch			
Streuwert	1.48, horizontal: 1.78, vertikal: 1.09			

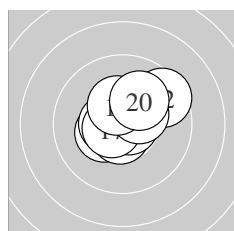

Serie 2:

10.7 *	9.5 ↗	10.3 *	10.6 *	10.5 *
10.8 *	10.6 *	10.4 *	10.4 *	10.1 ↗
beste Teiler	47.6 (16.)	57.5 (11.)	80.2 (14.)	
Trefferlage	0.15 mm rechts, 0.39 mm hoch			
Streuwert	1.19, horizontal: 1.35, vertikal: 1.01			

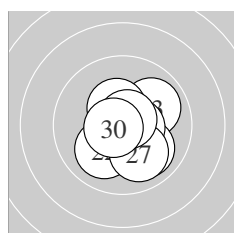

Serie 3:

10.5 *	10.0 ↙	9.9 ↗	10.0 ↘	10.7 *
10.6 *	10.0 ↘	10.4 *	10.7 *	10.7 *
beste Teiler	55.4 (29.)	70.2 (25.)	71.8 (30.)	
Trefferlage	0.57 mm rechts, 0.28 mm tief			
Streuwert	1.17, horizontal: 1.12, vertikal: 1.22			

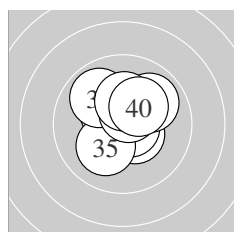

Serie 4:

10.5 *	10.5 *	10.7 *	10.4 *	10.1 ↙
9.9 ↘	10.6 *	9.9 ↗	10.3 *	10.2 *
beste Teiler	62.2 (33.)	96.1 (37.)	102.0 (31.)	
Trefferlage	0.22 mm rechts, 0.51 mm hoch			
Streuwert	1.21, horizontal: 1.20, vertikal: 1.23			

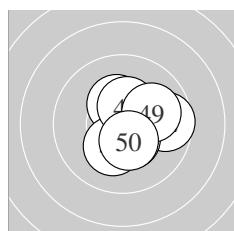

Serie 5:

10.7 *	9.7 →	10.3 *	10.6 *	10.6 *
10.4 *	10.2 *	10.4 *	10.0 →	10.4 *
beste Teiler	74.7 (41.)	82.6 (44.)	84.0 (45.)	
Trefferlage	0.73 mm rechts, 0.01 mm hoch			
Streuwert	1.15, horizontal: 1.17, vertikal: 1.12			

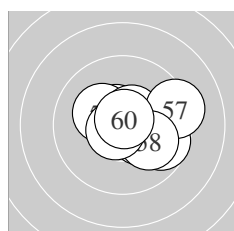

Serie 6:

10.3 *	10.6 *	10.2 *	10.4 *	10.5 *
9.7 ↘	9.3 →	10.0 ↘	10.7 *	10.8 *
beste Teiler	46.5 (60.)	66.6 (59.)	95.0 (52.)	
Trefferlage	0.97 mm rechts, 0.09 mm hoch			
Streuwert	1.35, horizontal: 1.69, vertikal: 0.90			

**ISSF AR Men** – Wertung – **Männer**

StandNr: 145

**Hári, Péter** #70817553

**StartNr: 45**

3. Dezember 2017 9:36

HUN – BHSE

---

Unterschrift des Schützen

---

Meyton Elektronik

Ergebnis: **619.2** (593)  
 Serien: 103.4 104.6 102.2 104.5 104.2 100.3  
 Zähler: 53 7 0 0 0 0 0 0 0  
 Innenzehner: 44  
 weiteste: 456 (58), 326 (27), 322 (25)  
 beste Teiler 10.2 (5.) 16.1 (14.) 17.0 (45.)  
 Trefferlage 0.06 mm rechts, 0.18 mm hoch  
 Streuwert 1.26, horizontal: 1.27, vertikal: 1.25

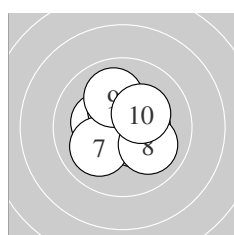
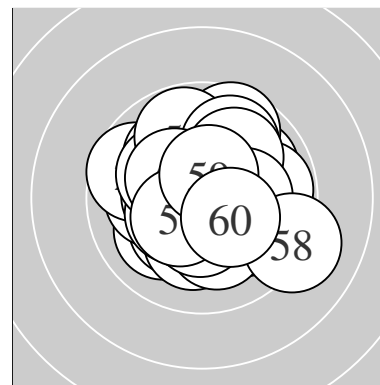

Serie 1:  
 10.3 \* 10.5 \* 10.4 \* 10.6 \* 10.9 \*  
 10.4 \* 10.0 ↙ 10.0 ↘ 10.0 ↑ 10.3 \*  
 beste Teiler 10.2 (5.) 79.1 (4.) 117.6 (2.)  
 Trefferlage 0.18 mm rechts, 0.10 mm hoch  
 Streuwert 1.23, horizontal: 1.29, vertikal: 1.17

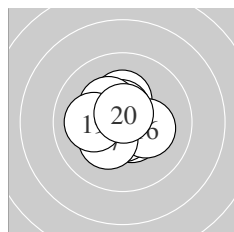

Serie 2:  
 10.5 \* 10.3 \* 10.6 \* 10.9 \* 10.7 \*  
 10.2 \* 10.3 \* 10.3 \* 10.1 ← 10.7 \*  
 beste Teiler 16.1 (14.) 66.4 (20.) 75.0 (15.)  
 Trefferlage 0.18 mm links, 0.13 mm hoch  
 Streuwert 1.03, horizontal: 1.07, vertikal: 0.98

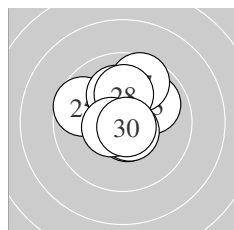

Serie 3:  
 10.2 \* 10.6 \* 9.9 ↗ 10.6 \* 9.7 ↖  
 10.1 ↑ 9.6 ↗ 10.1 ↑ 10.6 \* 10.8 \*  
 beste Teiler 47.0 (30.) 81.4 (22.) 87.2 (24.)  
 Trefferlage 0.08 mm links, 0.89 mm hoch  
 Streuwert 1.38, horizontal: 1.42, vertikal: 1.34

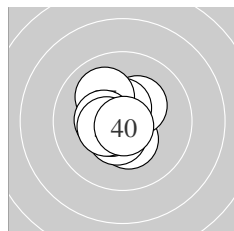

Serie 4:  
 10.4 \* 10.5 \* 10.3 \* 10.5 \* 10.6 \*  
 10.6 \* 10.0 ↘ 10.4 \* 10.4 \* 10.8 \*  
 beste Teiler 39.2 (40.) 93.0 (35.) 100.1 (36.)  
 Trefferlage 0.29 mm links, 0.13 mm hoch  
 Streuwert 0.97, horizontal: 0.89, vertikal: 1.05

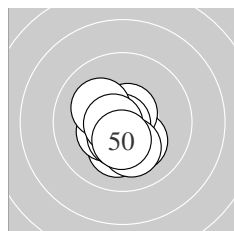

Serie 5:  
 10.2 \* 10.2 \* 10.4 \* 10.6 \* 10.9 \*  
 10.1 ↓ 10.5 \* 10.2 \* 10.7 \* 10.4 \*  
 beste Teiler 17.0 (45.) 72.1 (49.) 77.0 (44.)  
 Trefferlage 0.24 mm links, 0.69 mm tief  
 Streuwert 0.95, horizontal: 0.85, vertikal: 1.04

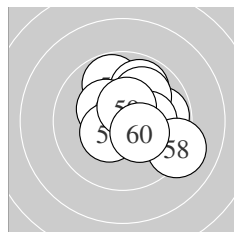

Serie 6:  
 9.8 → 9.8 ↑ 9.9 ↗ 10.0 ↗ 10.3 \*  
 10.4 \* 10.2 \* 9.1 ↘ 10.5 \* 10.3 \*  
 beste Teiler 110.4 (59.) 131.8 (56.) 154.6 (55.)  
 Trefferlage 1.00 mm rechts, 0.56 mm hoch  
 Streuwert 1.64, horizontal: 1.72, vertikal: 1.54

Meyton Elektronik

**ISSF AR Men** – Wertung – **Männer**

StandNr: 146

**Zott, Georg** #70804306

**StartNr: 46**

3. Dezember 2017 9:13

ÖSB

---

\_\_\_\_\_  
Unterschrift des Schützen

Meyton Elektronik

Ergebnis: **608.9** (585)  
 Serien: 103.1 100.9 101.8 102.5 100.1 100.5  
 Zähler: 45 15 0 0 0 0 0 0 0  
 Innenzehner: 29  
 weiteste: 435 (56), 420 (54), 391 (28)  
 beste Teiler 7.2 (34.) 8.5 (8.) 9.0 (33.)  
 Trefferlage 0.00 mm , 0.07 mm tief  
 Streuwert 1.58, horizontal: 1.69, vertikal: 1.47

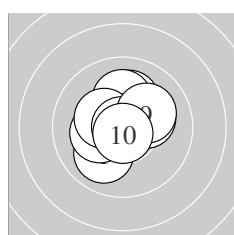
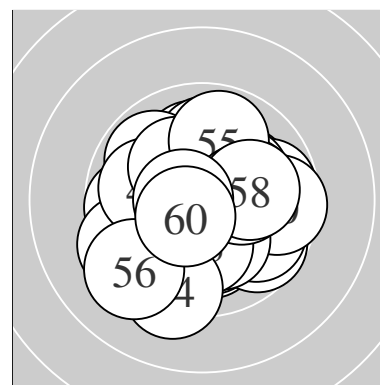

Serie 1:  
 10.0 ↘ 10.4 \* 10.1 ↑ 10.2 \* 10.1 ↑  
 10.2 \* 10.3 \* 10.9 \* 10.1 ↗ 10.8 \*  
 beste Teiler 8.5 (8.) 46.0 (10.) 139.6 (2.)  
 Trefferlage 0.04 mm rechts, 0.45 mm hoch  
 Streuwert 1.24, horizontal: 1.26, vertikal: 1.21

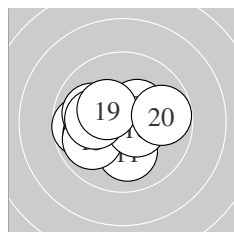

Serie 2:  
 10.1 ↓ 9.7 ← 10.0 ← 10.4 \* 9.9 ↙  
 10.5 \* 10.0 ← 10.1 ← 10.4 \* 9.8 →  
 beste Teiler 109.1 (16.) 143.8 (14.) 150.0 (19.)  
 Trefferlage 0.76 mm links, 0.16 mm tief  
 Streuwert 1.58, horizontal: 1.98, vertikal: 1.03

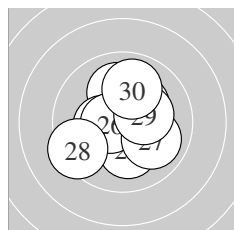

Serie 3:  
 10.1 ↑ 10.4 \* 10.2 \* 10.8 \* 10.1 ↓  
 10.6 \* 10.0 ↘ 9.4 ↙ 10.3 \* 9.9 ↑  
 beste Teiler 50.3 (24.) 92.4 (26.) 147.9 (22.)  
 Trefferlage 0.04 mm links, 0.05 mm hoch  
 Streuwert 1.61, horizontal: 1.63, vertikal: 1.59

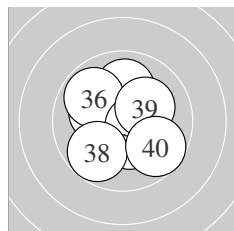

Serie 4:  
 10.0 ↑ 10.4 \* 10.9 \* 10.9 \* 10.2 \*  
 9.8 ↖ 10.6 \* 9.8 ↗ 10.2 \* 9.7 ↘  
 beste Teiler 7.2 (34.) 9.0 (33.) 99.3 (37.)  
 Trefferlage 0.00 mm , 0.00 mm  
 Streuwert 1.54, horizontal: 1.54, vertikal: 1.53

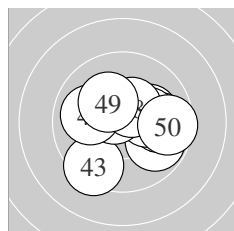

Serie 5:  
 10.1 → 9.8 ↘ 9.4 ↗ 9.8 → 10.2 \*  
 10.6 \* 10.0 ← 10.4 \* 10.2 \* 9.6 →  
 beste Teiler 84.8 (46.) 129.3 (48.) 184.0 (49.)  
 Trefferlage 0.68 mm rechts, 0.02 mm tief  
 Streuwert 1.79, horizontal: 2.11, vertikal: 1.38

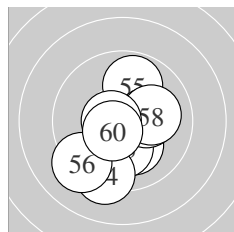

Serie 6:  
 10.4 \* 10.2 \* 10.1 ↓ 9.3 ↓ 9.9 ↑  
 9.2 ↗ 10.2 \* 10.1 → 10.6 \* 10.5 \*  
 beste Teiler 85.0 (59.) 105.3 (60.) 150.8 (51.)  
 Trefferlage 0.08 mm rechts, 0.74 mm tief  
 Streuwert 1.80, horizontal: 1.59, vertikal: 1.99

Meyton Elektronik

**ISSF AR Men – Wertung – Männer**

StandNr: 147

**Cipro, Adam** #70804300

**StartNr: 47**

3. Dezember 2017 9:21

CZE – Dukla Pilsen

---

\_\_\_\_\_  
Unterschrift des Schützen

Meyton Elektronik



Ergebnis:	<b>616.9</b>	(592)						
Serien:	104.2	103.6	102.9	103.2	101.1	101.9		
Zähler:	52	8	0	0	0	0	0	0
Innenzehner:	42							
weiteste:	369 (44), 363 (26), 329 (52)							
beste Teiler	31.0 (54.)	58.0 (6.)	58.7 (8.)					
Trefferlage	0.19 mm links, 0.26 mm hoch							
Streuwert	1.29, horizontal: 1.38, vertikal: 1.19							

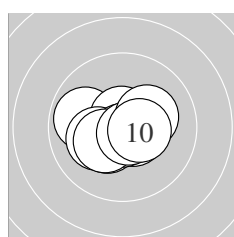
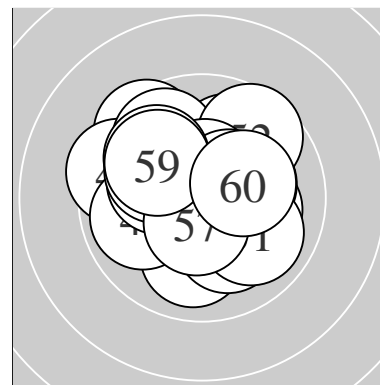

Serie 1:	9.9 ↖	10.6 *	10.7 *	10.2 *	10.4 *
	10.7 *	10.3 *	10.7 *	10.2 *	10.5 *
beste Teiler	58.0 (6.)	58.7 (8.)	65.4 (3.)		
Trefferlage	0.27 mm links, 0.25 mm tief				
Streuwert	1.08, horizontal: 1.37, vertikal: 0.68				

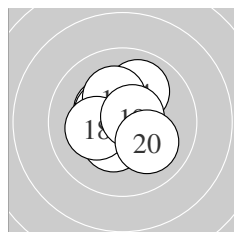

Serie 2:	10.4 *	10.7 *	10.6 *	10.0 ↗	10.4 *
	10.2 *	10.4 *	10.2 *	10.6 *	10.1 ↘
beste Teiler	60.9 (12.)	79.7 (19.)	94.9 (13.)		
Trefferlage	0.27 mm links, 0.31 mm hoch				
Streuwert	1.15, horizontal: 1.11, vertikal: 1.19				

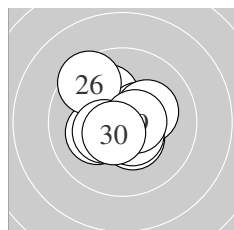

Serie 3:	10.4 *	10.1 ↖	10.2 *	10.4 *	10.2 *
	9.5 ↘	10.4 *	10.5 *	10.6 *	10.6 *
beste Teiler	88.0 (29.)	98.8 (30.)	108.7 (28.)		
Trefferlage	0.20 mm links, 0.18 mm hoch				
Streuwert	1.35, horizontal: 1.40, vertikal: 1.30				

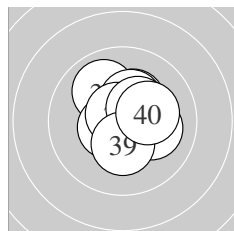

Serie 4:	10.3 *	10.0 ↖	10.4 *	10.1 →	10.5 *
	10.3 *	10.7 *	10.4 *	10.3 *	10.2 *
beste Teiler	62.6 (37.)	104.6 (35.)	140.4 (38.)		
Trefferlage	0.46 mm rechts, 0.51 mm hoch				
Streuwert	1.11, horizontal: 1.12, vertikal: 1.10				

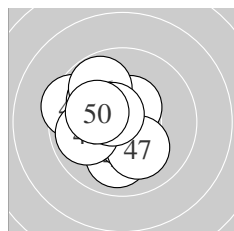

Serie 5:	10.0 ↓	10.5 *	10.5 *	9.5 ↖	10.0 ↖
	9.8 ↘	10.1 ↘	9.9 ↖	10.6 *	10.2 *
beste Teiler	90.6 (49.)	107.5 (42.)	116.7 (43.)		
Trefferlage	1.02 mm links, 0.13 mm hoch				
Streuwert	1.50, horizontal: 1.46, vertikal: 1.55				

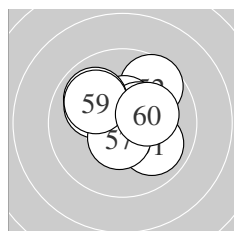

Serie 6:	9.9 ↘	9.6 ↗	10.5 *	10.8 *	10.4 *
	10.1 ↖	10.5 *	9.9 ↘	10.0 ↖	10.2 *
beste Teiler	31.0 (54.)	106.5 (57.)	110.6 (53.)		
Trefferlage	0.14 mm rechts, 0.69 mm hoch				
Streuwert	1.44, horizontal: 1.62, vertikal: 1.23				

Meyton Elektronik

**ISSF AR Men – Wertung – Männer**

StandNr: 148

**Zach, Michael** #70804295

**StartNr: 48**

3. Dezember 2017 9:39

VBG

---

\_\_\_\_\_  
Unterschrift des Schützen

Meyton Elektronik