

Ergebnis:	<b>595.6</b>	(566)
Serien:	102.4	101.1 99.5 94.5 100.7 97.4
Zaehler:	34	20 5 0 1 0 0 0 0 0
Innenzehner:	28	
weiteste:	1011 (29), 680 (36), 649 (56)	
beste Teiler	12.0 (17.)	59.3 (46.) 80.1 (20.)
Trefferlage	0.50 mm rechts,	0.07 mm hoch
Streuwert	2.20, horizontal:	2.66, vertikal: 1.62

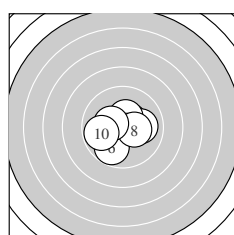

Serie 1:

10.4 *	10.3 *	10.5 *	10.0 →	10.6 *
9.8 ↘	10.4 *	10.3 *	10.3 *	9.8 ←
beste Teiler	91.6 (5.)	122.0 (3.)	134.4 (7.)	
Trefferlage	0.20 mm links, 0.24 mm tief			
Streuwert	1.38, horizontal: 1.55, vertikal: 1.18			

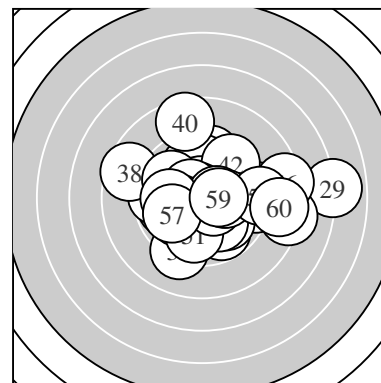
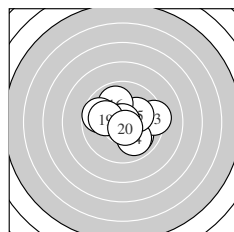

Serie 2:

10.0 ↘	10.5 *	9.3 →	9.9 ↘	10.2 *
9.9 ↗	10.9 *	9.7 ←	10.1 ←	10.6 *
beste Teiler	12.0 (17.)	80.1 (20.)	115.1 (12.)	
Trefferlage	0.43 mm rechts, 0.13 mm hoch			
Streuwert	1.73, horizontal: 2.06, vertikal: 1.31			

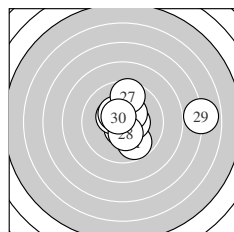

Serie 3:

9.8 ↘	10.4 *	10.6 *	10.4 *	10.4 *
10.4 *	9.6 ↑	10.4 *	6.9 →	10.6 *
beste Teiler	82.5 (23.)	89.4 (30.)	132.0 (22.)	
Trefferlage	1.20 mm rechts, 0.28 mm hoch			
Streuwert	2.57, horizontal: 3.25, vertikal: 1.62			

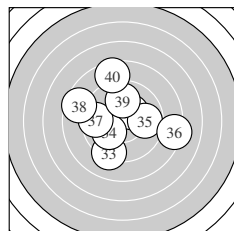

Serie 4:

10.3 *	10.3 *	9.2 ↘	10.1 ↗	9.8 →
8.2 →	9.6 ←	8.6 ←	9.9 ↑	8.5 ↑
beste Teiler	158.4 (32.)	162.6 (31.)	223.9 (34.)	
Trefferlage	0.31 mm links, 0.66 mm hoch			
Streuwert	3.07, horizontal: 3.40, vertikal: 2.70			

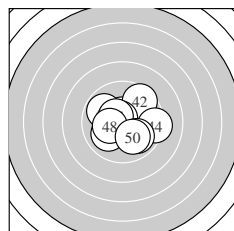

Serie 5:

10.6 *	9.6 ↗	9.8 ↘	9.3 →	10.0 ↗
10.7 *	10.5 *	10.3 *	9.9 ↘	10.0 ↘
beste Teiler	59.3 (46.)	97.8 (41.)	114.3 (47.)	
Trefferlage	0.23 mm rechts, 0.01 mm hoch			
Streuwert	1.82, horizontal: 2.09, vertikal: 1.50			

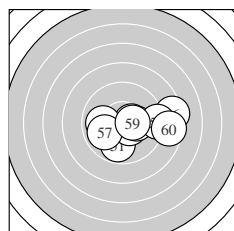

Serie 6:

9.8 ↓	10.5 *	10.5 *	10.2 *	9.9 ←
8.4 →	9.9 ←	9.2 →	10.4 *	8.6 →
beste Teiler	110.6 (52.)	114.9 (53.)	129.0 (59.)	
Trefferlage	1.64 mm rechts, 0.38 mm tief			
Streuwert	2.33, horizontal: 3.13, vertikal: 1.05			

Meyton Elektronik

**ISSF AR Men – Wertung – Junioren**

StandNr: 118

**Sommavilla, Manuel** #322

**StartNr: 14**

22. Januar 2017 9:59

SG Rettenberg Wattens

---

\_\_\_\_\_  
Unterschrift des Schuetzen

Meyton Elektronik

Ergebnis:	<b>590.9</b>	(568)
Serien:	96.6 98.1 100.6 97.8 100.0 97.8	
Zaehler:	31 26 3 0 0 0 0 0 0 0	
Innenzehner:	16	
weiteste:	680 (7), 583 (34), 582 (57)	
beste Teiler	9.0 (46.) 57.2 (48.) 92.4 (30.)	
Trefferlage	0.11 mm rechts, 0.50 mm hoch	
Streuwert	2.15, horizontal: 2.43, vertikal: 1.82	

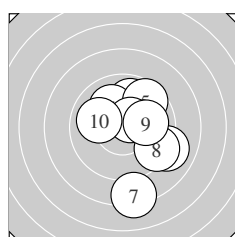
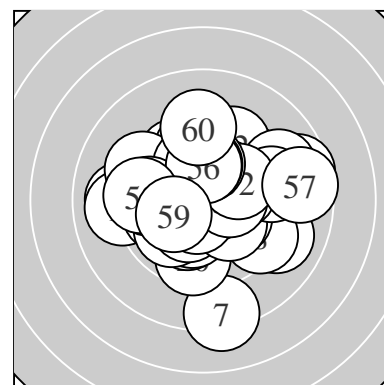

Serie 1:	9.0 ↘	9.9 ↑	9.9 ↗	10.1 ↖	9.6 ↗
	10.5 *	8.2 ↓	9.4 ↘	10.0 →	10.0 ←
beste Teiler	104.7 (6.)	224.2 (4.)	234.1 (9.)		
Trefferlage	1.32 mm rechts, 0.02 mm tief				
Streuwert	2.48, horizontal: 1.98, vertikal: 2.89				

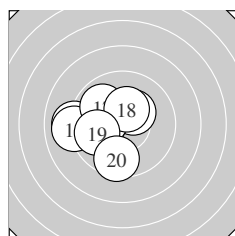

Serie 2:	9.7 ←	10.3 *	10.2 *	9.0 ←	10.2 *
	9.0 ←	9.9 ↘	10.3 *	9.9 ←	9.6 ↓
beste Teiler	152.3 (18.)	156.4 (12.)	177.1 (15.)		
Trefferlage	2.00 mm links, 0.04 mm tief				
Streuwert	1.72, horizontal: 1.95, vertikal: 1.46				

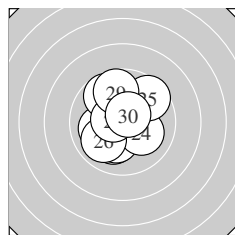

Serie 3:	10.1 ↓	10.2 *	10.1 ←	10.1 ↘	9.6 ↗
	9.9 ↗	9.7 ↖	10.6 *	9.7 ↑	10.6 *
beste Teiler	92.4 (30.)	95.8 (28.)	190.0 (22.)		
Trefferlage	0.38 mm links, 0.18 mm hoch				
Streuwert	1.74, horizontal: 1.55, vertikal: 1.91				

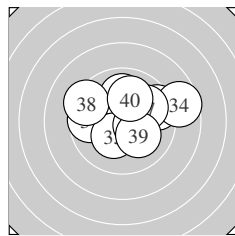

Serie 4:	9.7 ←	9.5 →	10.0 ↑	8.6 →	10.3 *
	10.4 *	9.9 →	9.3 ↖	10.1 ↘	10.0 ↑
beste Teiler	135.0 (36.)	169.6 (35.)	206.8 (39.)		
Trefferlage	0.70 mm rechts, 0.77 mm hoch				
Streuwert	2.24, horizontal: 2.82, vertikal: 1.44				

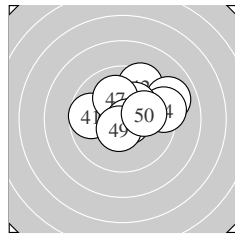

Serie 5:	9.7 ←	9.5 ↑	9.0 →	9.3 →	10.2 *
	10.9 *	10.1 ↖	10.7 *	10.5 *	10.1 →
beste Teiler	9.0 (46.)	57.2 (48.)	102.5 (49.)		
Trefferlage	0.97 mm rechts, 0.92 mm hoch				
Streuwert	1.84, horizontal: 2.27, vertikal: 1.27				

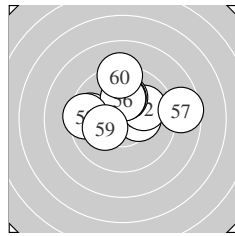

Serie 6:	10.3 *	10.0 →	10.1 ↑	10.1 ↑	9.7 ←
	10.1 ↑	8.6 →	9.5 ←	10.2 *	9.2 ↑
beste Teiler	158.0 (51.)	193.6 (59.)	203.0 (56.)		
Trefferlage	0.09 mm rechts, 1.23 mm hoch				
Streuwert	2.19, horizontal: 2.73, vertikal: 1.46				

Meyton Elektronik

**ISSF AR Men – Wertung – Junioren**

StandNr: 119

**Lüthi, Julius** #70804363

**StartNr: 15**

22. Januar 2017 9:40

T – SG Thierberg

---

\_\_\_\_\_  
Unterschrift des Schuetzen

Meyton Elektronik

Ergebnis:	<b>608.6</b>	(581)							
Serien:	102.7	101.0	102.1	98.1	103.1	101.6			
Zaehler:	45	13	1	0	1	0	0	0	0
Innenzehner:	37								
weiteste:	1248 (38), 510 (40), 447 (58)								
beste Teiler	3.0 (13.)	54.2 (37.)	59.9 (51.)						
Trefferlage	0.26 mm rechts, 0.08 mm hoch								
Streuwert	1.87, horizontal: 1.72, vertikal: 2.02								

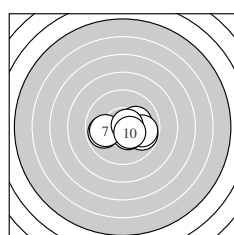
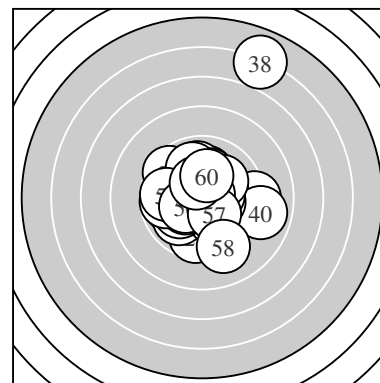

Serie 1:

10.7 *	9.8 →	10.5 *	10.5 *	9.9 ←
10.2 *	10.0 ←	9.9 →	10.7 *	10.5 *
beste Teiler	68.0 (1.)	70.2 (9.)	120.6 (3.)	
Trefferlage	0.64 mm rechts, 0.38 mm tief			
Streuwert	1.36, horizontal: 1.84, vertikal: 0.54			

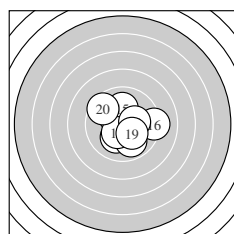

Serie 2:

10.1 ↓	10.3 *	10.9 *	9.9 ↓	10.1 ↑
9.2 →	10.4 *	10.3 *	10.2 *	9.6 ↘
beste Teiler	3.0 (13.)	140.1 (17.)	151.4 (12.)	
Trefferlage	0.30 mm rechts, 0.09 mm tief			
Streuwert	1.79, horizontal: 1.97, vertikal: 1.59			

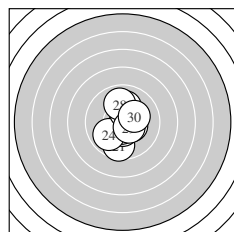

Serie 3:

9.6 ↓	10.5 *	10.6 *	9.9 ↙	10.4 *
10.1 ↑	10.4 *	9.9 ↑	10.5 *	10.2 *
beste Teiler	88.9 (23.)	116.2 (29.)	117.0 (22.)	
Trefferlage	0.16 mm rechts, 0.13 mm tief			
Streuwert	1.48, horizontal: 1.03, vertikal: 1.83			

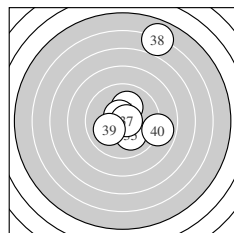

Serie 4:

10.1 ↑	10.5 *	10.6 *	10.5 *	10.1 ↓
10.6 *	10.7 *	6.0 ↑	10.1 ↙	8.9 →
beste Teiler	54.2 (37.)	83.5 (36.)	90.0 (33.)	
Trefferlage	0.82 mm rechts, 0.74 mm hoch			
Streuwert	3.23, horizontal: 2.33, vertikal: 3.93			

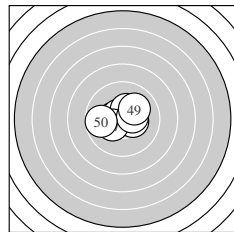

Serie 5:

10.5 *	10.3 *	10.4 *	10.4 *	10.6 *
10.4 *	10.3 *	10.4 *	10.1 ↗	9.7 ←
beste Teiler	82.3 (45.)	119.0 (41.)	132.4 (43.)	
Trefferlage	0.05 mm rechts, 0.43 mm hoch			
Streuwert	1.24, horizontal: 1.57, vertikal: 0.78			

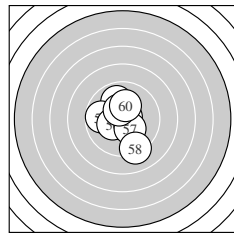

Serie 6:

10.7 *	9.9 ↑	10.2 *	10.7 *	9.7 ←
10.3 *	10.3 *	9.2 ↓	10.4 *	10.2 *
beste Teiler	59.9 (51.)	68.6 (54.)	135.1 (59.)	
Trefferlage	0.40 mm links, 0.08 mm tief			
Streuwert	1.66, horizontal: 1.44, vertikal: 1.85			

Meyton Elektronik

**ISSF AR Men – Wertung – Junioren**

StandNr: 120

**Sohm, Jodok** #103

**StartNr: 16**

22. Januar 2017 9:43

AUT

---

\_\_\_\_\_  
Unterschrift des Schuetzen

Meyton Elektronik

Ergebnis:	<b>620.1</b>	(592) <sup>QF</sup>							
Serien:	103.1	103.5	103.5	104.1	101.3	104.6			
Zaehler:	52	8	0	0	0	0	0	0	0
Innenzehner:	44								
weiteste:	374 (27), 337 (11), 302 (41)								
beste Teiler	42.1 (5.) 42.2 (36.) 45.0 (45.)								
Trefferlage	0.34 mm links, 0.38 mm tief								
Streuwert	1.18, horizontal: 1.24, vertikal: 1.11								

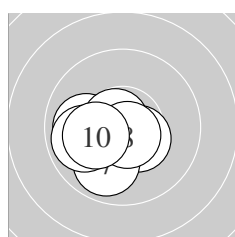
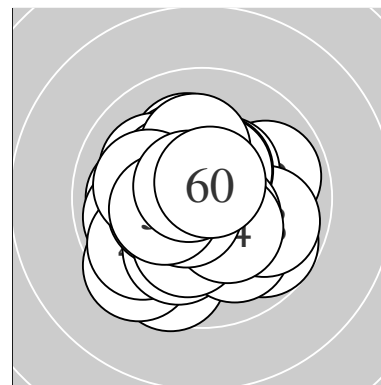

Serie 1:	10.2 *	10.0 ←	10.3 *	10.4 *	10.8 *
	10.7 *	9.9 ↙	10.7 *	9.9 ←	10.2 *
beste Teiler	42.1 (5.) 59.6 (6.) 61.0 (8.)				
Trefferlage	1.05 mm links, 0.59 mm tief				
Streuwert	1.00, horizontal: 1.18, vertikal: 0.78				

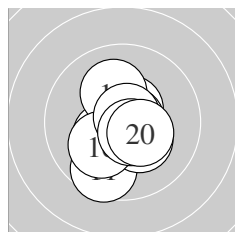

Serie 2:	9.6 ↘	10.4 *	10.5 *	10.1 ↑	10.3 *
	10.1 ↙	10.7 *	10.8 *	10.6 *	10.4 *
beste Teiler	45.6 (18.) 57.0 (17.) 88.7 (19.)				
Trefferlage	0.01 mm links, 0.47 mm tief				
Streuwert	1.22, horizontal: 0.99, vertikal: 1.41				

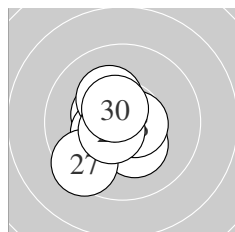

Serie 3:	10.4 *	10.6 *	10.4 *	10.4 *	10.3 *
	10.2 *	9.5 ↙	10.6 *	10.6 *	10.5 *
beste Teiler	83.1 (28.) 83.7 (22.) 92.2 (29.)				
Trefferlage	0.62 mm links, 0.39 mm tief				
Streuwert	1.15, horizontal: 1.08, vertikal: 1.21				

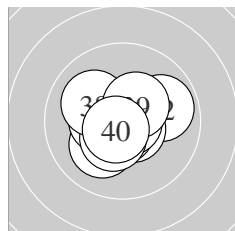

Serie 4:	10.1 ↙	9.9 →	10.4 *	10.6 *	10.7 *
	10.8 *	10.4 *	10.1 ↘	10.4 *	10.7 *
beste Teiler	42.2 (36.) 64.7 (35.) 73.2 (40.)				
Trefferlage	0.13 mm links, 0.13 mm tief				
Streuwert	1.15, horizontal: 1.32, vertikal: 0.93				

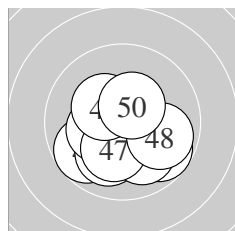

Serie 5:	9.7 ↙	10.0 ↘	9.7 ↘	10.0 ↘	10.8 *
	10.3 *	10.2 *	9.9 ↘	10.3 *	10.4 *
beste Teiler	45.0 (45.) 127.1 (50.) 157.6 (49.)				
Trefferlage	0.02 mm rechts, 0.82 mm tief				
Streuwert	1.49, horizontal: 1.68, vertikal: 1.27				

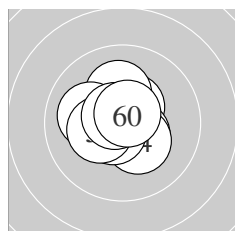

Serie 6:	10.7 *	10.5 *	10.5 *	10.3 *	10.2 *
	10.1 ←	10.6 *	10.3 *	10.7 *	10.7 *
beste Teiler	56.5 (51.) 70.6 (60.) 70.8 (59.)				
Trefferlage	0.26 mm links, 0.13 mm hoch				
Streuwert	1.00, horizontal: 1.03, vertikal: 0.96				

**ISSF AR Men – Wertung – Junioren**

StandNr: 121

**Abdul, Rahman Mohamad Irwan** #70804635

**StartNr: 17**

22. Januar 2017 9:33

Singapore

---

QF – Schütze hat sich fürs Finale qualifiziert

---

Unterschrift des Schuetzen

Meyton Elektronik



Ergebnis:	<b>615.0</b>	(589) <sup>QF</sup>							
Serien:	102.6	101.6	102.1	102.4	103.6	102.7			
Zaehler:	49	11	0	0	0	0	0	0	0
Innenzehner:	33								
weiteste:	467 (38), 311 (57), 300 (56)								
beste Teiler	21.0 (60.)	32.2 (6.)	41.2 (45.)						
Trefferlage	0.29 mm rechts, 0.23 mm hoch								
Streuwert	1.37, horizontal: 1.61, vertikal: 1.07								

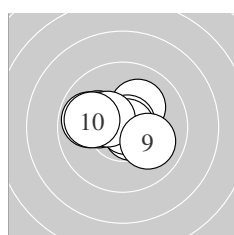
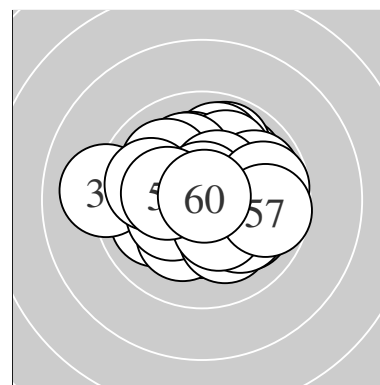

Serie 1:	10.6 *	9.9 ←	10.1 ↖	10.1 ↗	10.7 *
	10.8 *	10.1 ←	10.4 *	10.0 ↘	9.9 ←
beste Teiler	32.2 (6.)	51.6 (5.)	85.2 (1.)		
Trefferlage	0.56 mm links, 0.35 mm hoch				
Streuwert	1.31, horizontal: 1.69, vertikal: 0.74				

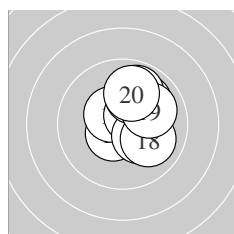

Serie 2:	10.5 *	10.5 *	10.5 *	10.0 ↗	10.3 *
	9.9 ↗	10.0 ↗	10.0 ↘	10.0 ↗	9.9 ↗
beste Teiler	101.1 (13.)	105.3 (11.)	119.0 (12.)		
Trefferlage	0.89 mm rechts, 0.87 mm hoch				
Streuwert	1.25, horizontal: 1.05, vertikal: 1.42				

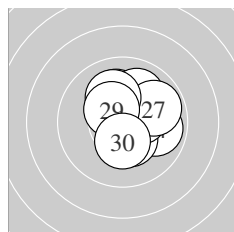

Serie 3:	10.6 *	10.1 ↗	10.0 ↗	9.9 →	10.4 *
	10.4 *	9.9 →	10.1 ↖	10.4 *	10.3 *
beste Teiler	82.9 (21.)	135.3 (29.)	148.2 (25.)		
Trefferlage	0.69 mm rechts, 0.51 mm hoch				
Streuwert	1.31, horizontal: 1.26, vertikal: 1.36				

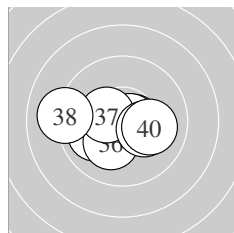

Serie 4:	10.4 *	10.6 *	10.0 ↖	10.7 *	10.7 *
	10.2 *	10.4 *	9.1 ←	10.2 *	10.1 →
beste Teiler	59.0 (35.)	67.0 (34.)	89.4 (32.)		
Trefferlage	0.17 mm links, 0.34 mm tief				
Streuwert	1.55, horizontal: 2.10, vertikal: 0.65				

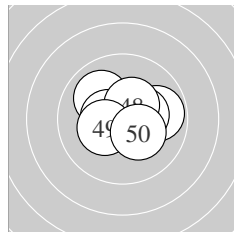

Serie 5:	10.0 ↘	9.8 →	10.6 *	10.6 *	10.8 *
	10.5 *	10.3 *	10.4 *	10.3 *	10.3 *
beste Teiler	41.2 (45.)	88.0 (44.)	97.9 (43.)		
Trefferlage	0.31 mm rechts, 0.24 mm hoch				
Streuwert	1.17, horizontal: 1.44, vertikal: 0.81				

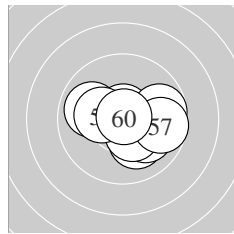

Serie 6:	10.8 *	10.1 ↘	10.1 ↘	10.4 *	10.7 *
	9.8 →	9.7 →	9.9 ←	10.3 *	10.9 *
beste Teiler	21.0 (60.)	48.8 (51.)	58.2 (55.)		
Trefferlage	0.61 mm rechts, 0.26 mm tief				
Streuwert	1.41, horizontal: 1.78, vertikal: 0.90				

Meyton Elektronik

**ISSF AR Men – Wertung – Junioren**

StandNr: 122

**Thum, Andreas** #86

**StartNr: 18**

22. Januar 2017 9:48

AUT

---

QF – Schütze hat sich fürs Finale qualifiziert

---

Unterschrift des Schuetzen

Meyton Elektronik

Ergebnis: **610.3** (582)

Serien: 101.1 102.7 102.5 102.0 100.6 101.4

Zaehler: 42 18 0 0 0 0 0 0 0 0

Innenzehner: 33

weiteste: 471 (21), 380 (3), 365 (45)

beste Teiler 26.4 (40.) 36.2 (2.) 59.0 (55.)

Trefferlage 0.45 mm links, 0.06 mm tief

Streuwert 1.53, horizontal: 1.81, vertikal: 1.20

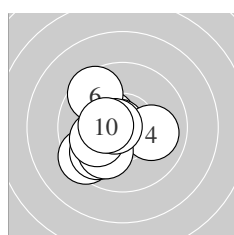
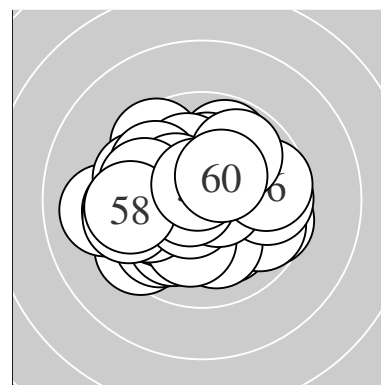

Serie 1:

10.4 *	10.8 *	9.4 ↙	10.0 →	9.8 ↙
9.6 ↘	10.0 ↙	10.0 ↙	10.7 *	10.4 *

beste Teiler 36.2 (2.) 66.3 (9.) 136.7 (10.)

Trefferlage 1.19 mm links, 0.40 mm tief

Streuwert 1.49, horizontal: 1.46, vertikal: 1.51

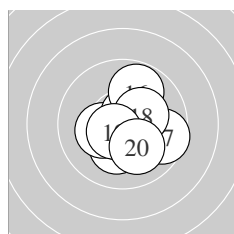

Serie 2:

10.5 *	10.2 *	10.3 *	10.7 *	10.6 *
9.8 ↗	9.6 →	10.3 *	10.6 *	10.1 ↘

beste Teiler 73.4 (14.) 89.6 (15.) 90.7 (19.)

Trefferlage 0.50 mm rechts, 0.13 mm tief

Streuwert 1.37, horizontal: 1.36, vertikal: 1.38

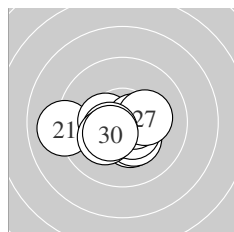

Serie 3:

9.1 ←	10.3 *	10.4 *	10.3 *	10.5 *
10.6 *	10.2 *	10.5 *	10.2 *	10.4 *

beste Teiler 89.1 (26.) 111.0 (25.) 122.1 (28.)

Trefferlage 0.45 mm links, 0.62 mm tief

Streuwert 1.40, horizontal: 1.88, vertikal: 0.63

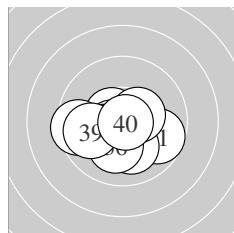

Serie 4:

9.7 →	10.6 *	10.1 ↓	10.6 *	10.3 *
10.1 ↓	10.4 *	9.5 ←	9.9 ←	10.8 *

beste Teiler 26.4 (40.) 98.4 (32.) 99.3 (34.)

Trefferlage 0.49 mm links, 0.71 mm tief

Streuwert 1.45, horizontal: 1.86, vertikal: 0.88

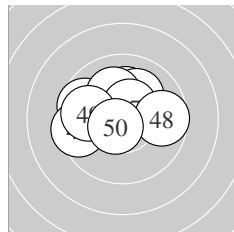

Serie 5:

10.5 *	9.7 ↖	10.1 ↑	10.1 ↗	9.5 ←
10.1 ↘	10.5 *	9.7 →	9.8 ←	10.6 *

beste Teiler 83.4 (50.) 114.0 (41.) 114.7 (47.)

Trefferlage 0.67 mm links, 0.69 mm hoch

Streuwert 1.65, horizontal: 2.08, vertikal: 1.05

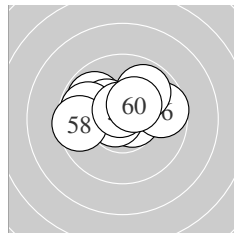

Serie 6:

10.6 *	9.8 ↘	10.3 *	9.8 ↖	10.7 *
9.7 →	9.9 ↗	9.6 ←	10.6 *	10.4 *

beste Teiler 59.0 (55.) 78.1 (59.) 79.1 (51.)

Trefferlage 0.41 mm links, 0.77 mm hoch

Streuwert 1.58, horizontal: 2.09, vertikal: 0.77

Meyton Elektronik

**ISSF AR Men – Wertung – Junioren**

StandNr: 123

**Alther, Christian** #70804631

**StartNr: 19**

22. Januar 2017 10:10

Switzerland

---

\_\_\_\_\_  
Unterschrift des Schuetzen

Meyton Elektronik

Ergebnis:	<b>602.5</b>	(574)
Serien:	101.3	101.8 99.9 98.9 100.6 100.0
Zaehler:	37	20 3 0 0 0 0 0 0 0
Innenzehner:	26	
weiteste:	597 (8), 555 (33), 508 (35)	
beste Teiler	29.6 (10.)	48.7 (43.) 61.4 (45.)
Trefferlage	0.35 mm links, 0.20 mm tief	
Streuwert	1.85, horizontal: 2.15, vertikal: 1.49	

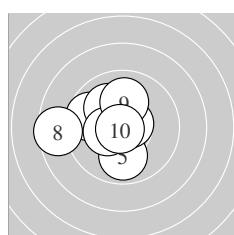
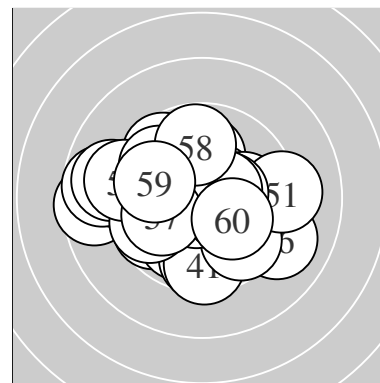

Serie 1:	10.6 *	9.7 ↖	10.1 ↗	10.5 *	9.9 ↓
	10.4 *	10.7 *	8.6 ↖	10.0 ↑	10.8 *
beste Teiler	29.6 (10.) 69.7 (7.) 81.2 (1.)				
Trefferlage	1.15 mm links, 0.14 mm hoch				
Streuwert	1.74, horizontal: 1.99, vertikal: 1.44				

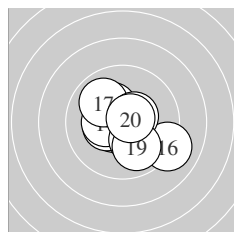

Serie 2:	10.6 *	10.3 *	10.4 *	10.3 *	10.2 *
	9.1 ↘	9.9 ↘	10.5 *	9.9 ↘	10.6 *
beste Teiler	81.3 (20.) 97.3 (11.) 118.9 (18.)				
Trefferlage	0.16 mm rechts, 0.29 mm tief				
Streuwert	1.64, horizontal: 1.84, vertikal: 1.41				

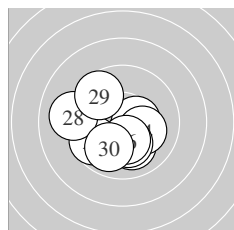

Serie 3:	10.5 *	10.0 ↓	10.5 *	10.2 *	10.1 ↓
	10.3 *	9.7 ↖	9.1 ↖	9.6 ↘	9.9 ↘
beste Teiler	123.7 (23.) 125.9 (21.) 166.1 (26.)				
Trefferlage	0.49 mm links, 0.81 mm tief				
Streuwert	1.81, horizontal: 2.06, vertikal: 1.50				

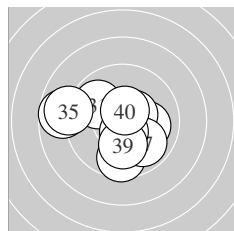

Serie 4:	9.9 ↘	10.1 →	8.7 ↖	9.6 ↓	8.9 ↖
	10.5 *	9.9 ↘	10.6 *	10.1 ↓	10.6 *
beste Teiler	99.2 (40.) 99.7 (38.) 116.6 (36.)				
Trefferlage	0.75 mm links, 0.41 mm tief				
Streuwert	2.22, horizontal: 2.67, vertikal: 1.64				

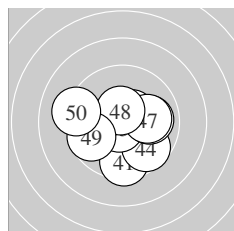

Serie 5:	9.5 ↓	10.5 *	10.8 *	9.7 ↘	10.7 *
	10.0 →	10.0 →	10.5 *	9.7 ↖	9.2 ↖
beste Teiler	48.7 (43.) 61.4 (45.) 107.8 (48.)				
Trefferlage	0.05 mm rechts, 0.42 mm tief				
Streuwert	1.91, horizontal: 2.20, vertikal: 1.56				

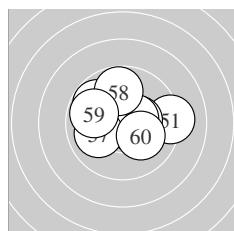

Serie 6:	9.2 →	10.4 *	10.4 *	10.0 ↘	10.5 *
	9.8 ↘	10.0 ↖	9.8 ↑	9.8 ↖	10.1 ↘
beste Teiler	115.5 (55.) 131.9 (53.) 144.3 (52.)				
Trefferlage	0.07 mm rechts, 0.57 mm hoch				
Streuwert	1.85, horizontal: 2.27, vertikal: 1.32				

Meyton Elektronik

**ISSF AR Men – Wertung – Junioren**

StandNr: 124

**Koota, Luukas** #70804644

**StartNr: 20**

22. Januar 2017 9:57

F – Esbo Skytteförening

---

\_\_\_\_\_  
Unterschrift des Schuetzen

Meyton Elektronik

Ergebnis:	<b>606.7</b>	(581)
Serien:	102.5	103.3 99.2 102.0 98.5 101.2
Zaehler:	41	19 0 0 0 0 0 0 0 0
Innenzehner:	30	
weiteste:	479 (23),	473 (22), 453 (47)
beste Teiler	25.9 (12.)	44.7 (6.) 45.8 (51.)
Trefferlage	0.17 mm rechts, 0.33 mm hoch	
Streuwert	1.68, horizontal: 1.92, vertikal: 1.40	

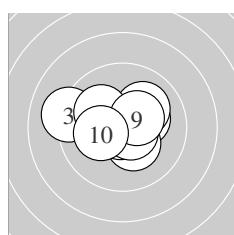
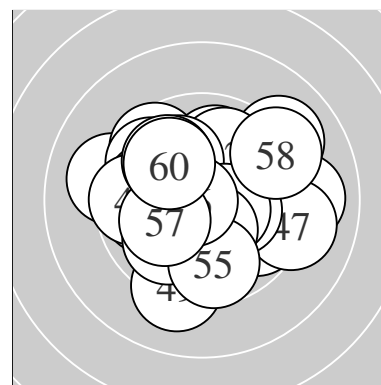

Serie 1:					
	10.2 *	10.1 ↗	9.1 ←	10.7 *	10.3 *
	10.8 *	10.1 ↘	10.6 *	10.4 *	10.2 *
beste Teiler	44.7 (6.) 53.3 (4.) 80.1 (8.)				
Trefferlage	0.26 mm links, 0.26 mm hoch				
Streuwert	1.51, horizontal: 1.93, vertikal: 0.91				

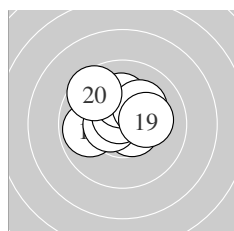

Serie 2:					
	10.4 *	10.9 *	9.9 ←	10.6 *	10.6 *
	10.7 *	10.2 *	10.2 *	10.2 *	9.6 ↘
beste Teiler	25.9 (12.) 70.7 (16.) 87.2 (14.)				
Trefferlage	0.12 mm links, 0.66 mm hoch				
Streuwert	1.30, horizontal: 1.54, vertikal: 1.00				

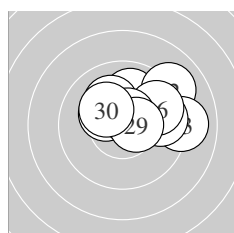

Serie 3:					
	10.0 ↑	9.1 ↗	9.0 →	10.3 *	9.7 →
	9.7 ↗	10.1 ↘	10.6 *	10.5 *	10.2 *
beste Teiler	89.4 (28.) 111.0 (29.) 165.5 (24.)				
Trefferlage	1.29 mm rechts, 1.21 mm hoch				
Streuwert	1.70, horizontal: 2.21, vertikal: 0.94				

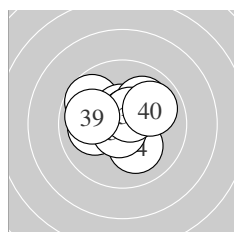

Serie 4:					
	9.7 ↘	10.5 *	10.0 ←	10.1 ↘	10.0 ↗
	10.6 *	10.7 *	10.6 *	9.9 ←	9.9 ↗
beste Teiler	58.6 (37.) 82.0 (36.) 98.2 (38.)				
Trefferlage	0.17 mm links, 0.52 mm hoch				
Streuwert	1.44, horizontal: 1.72, vertikal: 1.10				

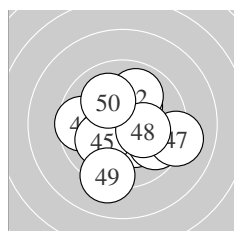

Serie 5:					
	10.2 *	9.9 ↑	9.6 ←	10.3 *	10.1 ←
	9.7 ↘	9.1 →	10.3 *	9.2 ↓	10.1 ↘
beste Teiler	165.4 (44.) 175.2 (48.) 179.7 (41.)				
Trefferlage	0.44 mm rechts, 0.43 mm tief				
Streuwert	2.12, horizontal: 2.29, vertikal: 1.95				

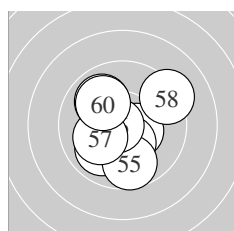

Serie 6:					
	10.8 *	10.5 *	9.9 ↗	10.3 *	9.7 ↓
	10.8 *	10.1 ←	9.2 ↗	9.9 ↘	10.0 ↘
beste Teiler	45.8 (51.) 49.1 (56.) 121.4 (52.)				
Trefferlage	0.13 mm links, 0.24 mm tief				
Streuwert	1.75, horizontal: 1.72, vertikal: 1.77				

Meyton Elektronik

**ISSF AR Men – Wertung – Junioren**

StandNr: 125

**Hoberg, Alex** #70804633

**StartNr: 21**

22. Januar 2017 9:47

Australia

---

\_\_\_\_\_  
Unterschrift des Schuetzen

Meyton Elektronik



Ergebnis: **612.9** (586)<sup>QF</sup>  
 Serien: 102.9 101.1 101.7 101.6 102.9 102.7  
 Zaehler: 46 14 0 0 0 0 0 0 0  
 Innenzehner: 42  
 weiteste: 474 (45), 431 (19), 391 (37)  
 beste Teiler 29.2 (22.) 36.0 (35.) 40.3 (53.)  
 Trefferlage 0.34 mm links, 0.39 mm tief  
 Streuwert 1.47, horizontal: 1.20, vertikal: 1.69

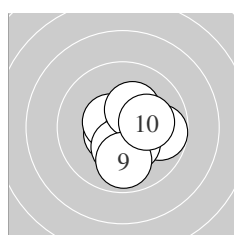
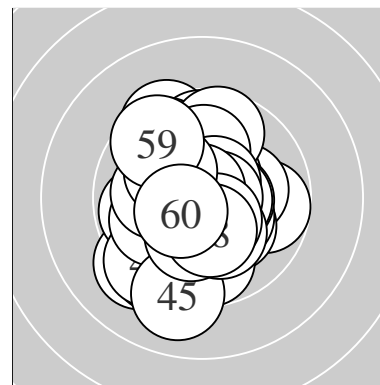

Serie 1:  
 10.5 \*                      10.6 \*                      10.5 \*                      9.8 →                      10.3 \*  
 10.5 \*                      10.3 \*                      10.3 \*                      9.9 ↓                      10.2 \*  
 beste Teiler 84.1 (2.) 103.7 (3.) 105.3 (1.)  
 Trefferlage 0.46 mm rechts, 0.46 mm tief  
 Streuwert 1.23, horizontal: 1.24, vertikal: 1.21

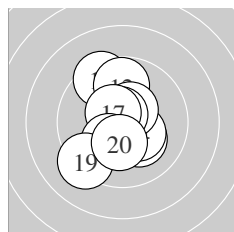

Serie 2:  
 9.4 ↖                      9.8 ↑                      10.2 \*                      10.3 \*                      10.5 \*  
 10.7 \*                      10.5 \*                      10.2 \*                      9.2 ✓                      10.3 \*  
 beste Teiler 64.8 (16.) 107.4 (17.) 115.4 (15.)  
 Trefferlage 0.39 mm links, 0.01 mm hoch  
 Streuwert 1.76, horizontal: 1.33, vertikal: 2.10

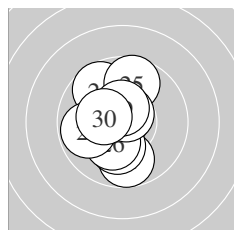

Serie 3:  
 9.8 ↓                      10.8 \*                      10.2 \*                      9.7 ↖                      9.7 ↑  
 10.2 \*                      10.7 \*                      9.8 ←                      10.5 \*                      10.3 \*  
 beste Teiler 29.2 (22.) 71.6 (27.) 112.5 (29.)  
 Trefferlage 0.60 mm links, 0.10 mm hoch  
 Streuwert 1.58, horizontal: 1.09, vertikal: 1.94

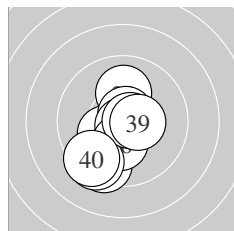

Serie 4:  
 9.4 ↓                      10.3 \*                      10.1 ↑                      10.7 \*                      10.8 \*  
 10.3 \*                      9.4 ✓                      10.7 \*                      10.5 \*                      9.4 ✓  
 beste Teiler 36.0 (35.) 58.6 (34.) 60.1 (38.)  
 Trefferlage 0.55 mm links, 1.01 mm tief  
 Streuwert 1.58, horizontal: 1.24, vertikal: 1.86

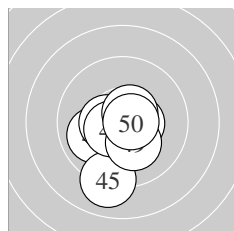

Serie 5:  
 10.3 \*                      10.0 ←                      10.5 \*                      10.4 \*                      9.1 ↓  
 10.6 \*                      10.5 \*                      10.6 \*                      10.2 \*                      10.7 \*  
 beste Teiler 67.0 (50.) 88.4 (46.) 93.2 (48.)  
 Trefferlage 0.21 mm links, 0.94 mm tief  
 Streuwert 1.31, horizontal: 1.13, vertikal: 1.47

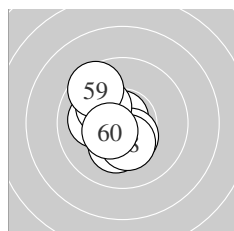

Serie 6:  
 10.1 ↖                      10.4 \*                      10.8 \*                      10.2 \*                      10.1 ←  
 10.5 \*                      10.2 \*                      10.3 \*                      9.6 ↖                      10.5 \*  
 beste Teiler 40.3 (53.) 120.4 (60.) 123.3 (56.)  
 Trefferlage 0.78 mm links, 0.04 mm tief  
 Streuwert 1.28, horizontal: 1.06, vertikal: 1.46

Meyton Elektronik

**ISSF AR Men – Wertung – Junioren**

StandNr: 126

**Hammermann, Marcel #80**

**StartNr: 22**

22. Januar 2017 10:07

VSB

---

QF – Schütze hat sich fürs Finale qualifiziert

---

Unterschrift des Schuetzen

Meyton Elektronik

Ergebnis:	<b>601.2</b>	(575)
Serien:	101.5	100.9 98.5 99.3 101.1 99.9
Zaehler:	37 21 2 0 0 0 0 0 0 0	
Innenzehner:	28	
weiteste:	701 (26), 520 (27), 474 (55)	
beste Teiler	45.7 (45.) 55.0 (1.) 90.1 (8.)	
Trefferlage	0.19 mm links, 0.40 mm hoch	
Streuwert	1.84, horizontal: 2.14, vertikal: 1.48	

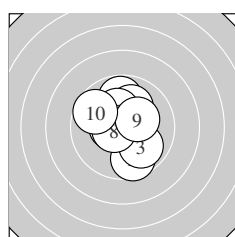
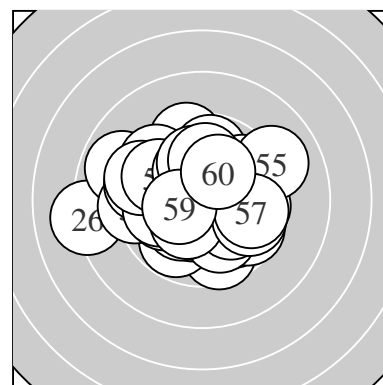

Serie 1:	10.7 *	9.6 ↘	9.9 ↘	10.5 *	9.8 ↑
	10.1 ↗	10.3 *	10.6 *	10.3 *	9.7 ↖
beste Teiler	55.0 (1.)	90.1 (8.)	116.0 (4.)		
Trefferlage	0.05 mm links, 0.40 mm hoch				
Streuwert	1.63, horizontal: 1.39, vertikal: 1.84				

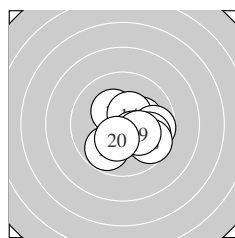

Serie 2:	9.8 ↙	10.2 *	10.3 *	10.5 *	10.4 *
	9.7 →	9.8 ↘	9.7 ↘	10.2 *	10.3 *
beste Teiler	123.4 (14.)	140.2 (15.)	158.0 (20.)		
Trefferlage	1.05 mm rechts, 0.60 mm tief				
Streuwert	1.44, horizontal: 1.64, vertikal: 1.21				

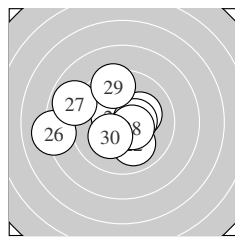

Serie 3:	10.1 ↖	10.0 ↘	10.5 *	10.2 *	10.5 *
	8.1 ←	8.9 ↖	10.5 *	9.5 ↑	10.2 *
beste Teiler	108.7 (28.)	110.4 (23.)	124.4 (25.)		
Trefferlage	1.10 mm links, 0.36 mm hoch				
Streuwert	2.34, horizontal: 2.80, vertikal: 1.76				

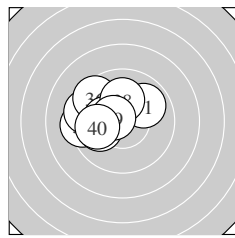

Serie 4:	9.9 ↗	9.3 ←	9.4 ↖	10.0 ←	10.3 *
	9.5 ↖	10.3 *	10.1 ↑	10.6 *	9.9 ←
beste Teiler	98.6 (39.)	155.1 (35.)	174.5 (37.)		
Trefferlage	1.74 mm links, 0.60 mm hoch				
Streuwert	1.50, horizontal: 1.81, vertikal: 1.10				

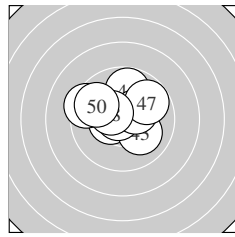

Serie 5:	10.1 ↗	10.5 *	10.1 ↘	9.8 ↑	10.8 *
	10.4 *	9.8 ↗	10.4 *	9.4 ↖	9.8 ↖
beste Teiler	45.7 (45.)	123.6 (42.)	132.0 (48.)		
Trefferlage	0.15 mm links, 0.85 mm hoch				
Streuwert	1.65, horizontal: 2.02, vertikal: 1.18				

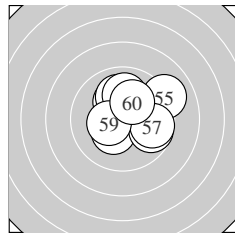

Serie 6:	10.3 *	9.7 ↘	10.2 *	10.3 *	9.1 →
	10.0 ↑	9.7 →	10.0 ↑	10.4 *	10.2 *
beste Teiler	143.2 (59.)	160.3 (51.)	168.9 (54.)		
Trefferlage	0.85 mm rechts, 0.81 mm hoch				
Streuwert	1.72, horizontal: 1.90, vertikal: 1.51				

Meyton Elektronik

**ISSF AR Men – Wertung – Junioren**

StandNr: 127

**Schöfbeck, Marcel** #102

**StartNr: 23**

22. Januar 2017 10:03

T – SG Walchsee

---

\_\_\_\_\_  
Unterschrift des Schuetzen

Meyton Elektronik

Ergebnis:	<b>608.4</b>	(582)							
Serien:	100.9	102.2	101.5	102.4	101.0	100.4			
Zaehler:	42	18	0	0	0	0	0	0	0
Innenzehner:	28								
weiteste:	457 (59), 429 (47), 371 (6)								
beste Teiler	17.0 (60.) 44.2 (8.) 56.2 (40.)								
Trefferlage	0.32 mm rechts, 0.35 mm hoch								
Streuwert	1.58, horizontal: 1.63, vertikal: 1.54								

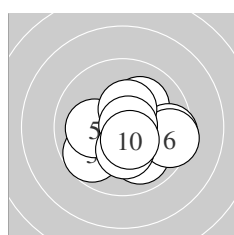
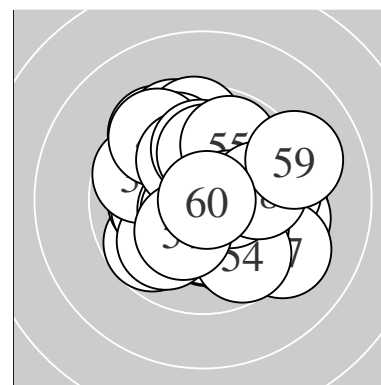

Serie 1:	10.0 ↘	10.1 ↗	9.7 ↙	9.5 →	10.1 ←
	9.5 →	10.4 *	10.8 *	10.3 *	10.5 *
beste Teiler	44.2 (8.) 111.5 (10.) 142.8 (7.)				
Trefferlage	0.68 mm rechts, 0.49 mm tief				
Streuwert	1.67, horizontal: 1.97, vertikal: 1.30				

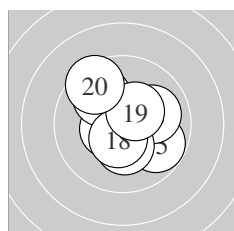

Serie 2:	10.7 *	10.5 *	10.6 *	9.9 ↖	9.8 ↗
	10.0 →	10.3 *	10.5 *	10.4 *	9.5 ↖
beste Teiler	67.1 (11.) 97.9 (13.) 111.0 (12.)				
Trefferlage	0.06 mm rechts, 0.10 mm hoch				
Streuwert	1.55, horizontal: 1.54, vertikal: 1.55				

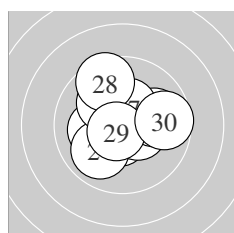

Serie 3:	10.6 *	10.5 *	10.1 ←	9.9 ↗	10.1 ↖
	10.0 →	10.4 *	9.5 ↖	10.7 *	9.7 →
beste Teiler	67.8 (29.) 94.3 (21.) 125.0 (22.)				
Trefferlage	0.01 mm rechts, 0.32 mm hoch				
Streuwert	1.64, horizontal: 1.77, vertikal: 1.49				

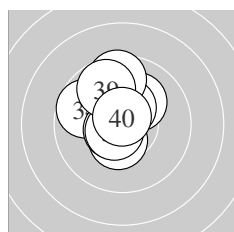

Serie 4:	10.1 ↗	10.4 *	10.5 *	9.7 ↖	10.4 *
	10.6 *	10.6 *	9.6 ↑	9.8 ↖	10.7 *
beste Teiler	56.2 (40.) 81.6 (37.) 88.1 (36.)				
Trefferlage	0.57 mm links, 0.91 mm hoch				
Streuwert	1.27, horizontal: 1.05, vertikal: 1.45				

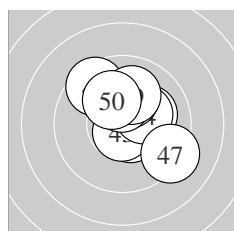

Serie 5:	10.6 *	10.1 →	10.7 *	10.3 *	9.5 ↖
	10.2 *	9.2 ↘	10.3 *	10.0 ↑	10.1 ↖
beste Teiler	60.2 (43.) 94.2 (41.) 162.1 (48.)				
Trefferlage	0.59 mm rechts, 0.83 mm hoch				
Streuwert	1.59, horizontal: 1.58, vertikal: 1.60				

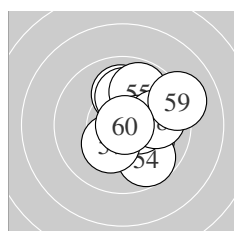

Serie 6:	10.1 ↘	10.0 ↑	10.1 ↑	9.7 ↘	9.8 ↗
	10.5 *	10.3 *	9.9 →	9.1 →	10.9 *
beste Teiler	17.0 (60.) 123.0 (56.) 169.4 (57.)				
Trefferlage	1.19 mm rechts, 0.42 mm hoch				
Streuwert	1.63, horizontal: 1.49, vertikal: 1.77				

Meyton Elektronik

**ISSF AR Men – Wertung – Junioren**

StandNr: 128

**Wadlegger, Stefan #98**

**StartNr: 24**

22. Januar 2017 9:38

AUT

---

\_\_\_\_\_  
Unterschrift des Schuetzen

Meyton Elektronik

Ergebnis:	<b>566.5</b>	(540)
Serien:	92.7 95.5 89.7 97.9 96.8 93.9	
Zaehler:	14 35 8 3 0 0 0 0 0 0	
Innenzehner:	10	
weiteste:	902 (24), 899 (27), 889 (3)	
beste Teiler	10.7 (31.) 41.9 (44.) 43.1 (28.)	
Trefferlage	1.22 mm rechts, 1.47 mm tief	
Streuwert	2.74, horizontal: 3.07, vertikal: 2.38	

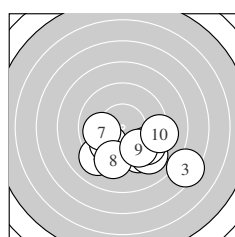
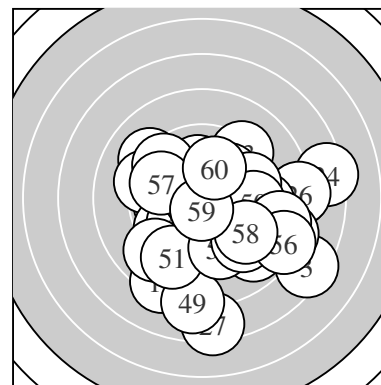

Serie 1:	9.5 ↘	9.1 ↘	7.4 ↘	9.1 ↙	9.5 ↘
	9.9 ↗	9.9 ←	9.4 ↓	9.7 ↘	9.2 →
beste Teiler	252.0 (7.)	259.5 (6.)	313.0 (9.)		
Trefferlage	1.34 mm rechts, 2.65 mm tief				
Streuwert	2.55, horizontal: 3.35, vertikal: 1.35				

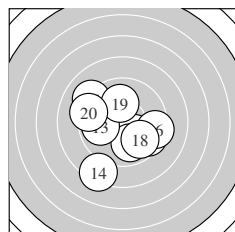

Serie 2:	10.2 *	9.9 ↘	9.9 ←	8.3 ↙	9.5 ↘
	9.4 →	9.1 ↖	9.8 ↘	10.1 ↑	9.3 ←
beste Teiler	190.2 (11.)	225.1 (19.)	259.9 (12.)		
Trefferlage	0.24 mm links, 0.88 mm tief				
Streuwert	2.72, horizontal: 2.90, vertikal: 2.53				

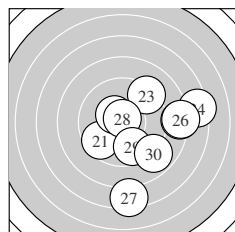

Serie 3:	9.6 ↗	10.4 *	9.2 ↗	7.3 →	8.2 →
	8.2 →	7.4 ↓	10.8 *	9.7 ↘	8.9 ↘
beste Teiler	43.1 (28.)	130.2 (22.)	312.3 (29.)		
Trefferlage	2.73 mm rechts, 1.09 mm tief				
Streuwert	3.64, horizontal: 3.78, vertikal: 3.49				

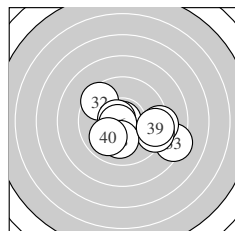

Serie 4:	10.9 *	9.5 ↖	8.3 ↘	9.2 →	10.6 *
	10.7 *	9.3 ↘	10.1 ↓	9.4 →	9.9 ↗
beste Teiler	10.7 (31.)	64.8 (36.)	76.8 (35.)		
Trefferlage	1.20 mm rechts, 0.67 mm tief				
Streuwert	2.37, horizontal: 3.03, vertikal: 1.43				

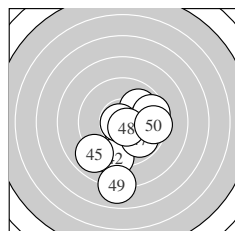

Serie 5:	10.4 *	9.2 ↓	10.0 ↗	10.8 *	9.0 ↗
	9.5 →	9.8 ↘	10.6 *	8.0 ↓	9.5 →
beste Teiler	41.9 (44.)	77.6 (48.)	136.4 (41.)		
Trefferlage	0.62 mm rechts, 1.69 mm tief				
Streuwert	2.46, horizontal: 2.14, vertikal: 2.74				

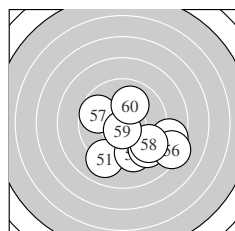

Serie 6:	9.1 ↙	8.6 →	9.5 ↘	9.4 ↓	9.3 ↘
	8.3 ↘	9.7 ←	9.4 ↘	10.6 *	10.0 ↑
beste Teiler	81.0 (59.)	230.4 (60.)	309.7 (57.)		
Trefferlage	1.67 mm rechts, 1.85 mm tief				
Streuwert	2.51, horizontal: 2.89, vertikal: 2.06				

**ISSF AR Men – Wertung – Junioren**

StandNr: 129

**Gruber, Robert jun.** #70804357

**StartNr: 25**

22. Januar 2017 9:31

SG Rettenberg Wattens

---

\_\_\_\_\_  
Unterschrift des Schuetzen

Meyton Elektronik



Ergebnis: **604.5** (578)

Serien: 100.6 100.5 101.8 100.0 101.3 100.3

Zaehler: 40 18 2 0 0 0 0 0 0 0

Innenzehner: 28

weiteste: 526 (50), 519 (15), 417 (55)

beste Teiler 60.0 (28.) 63.1 (46.) 65.3 (48.)

Trefferlage 0.26 mm links, 0.08 mm hoch

Streuwert 1.74, horizontal: 1.89, vertikal: 1.58

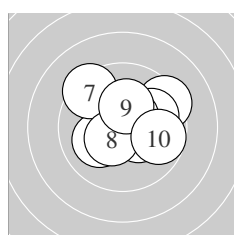
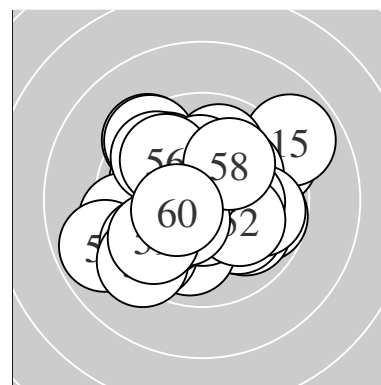

Serie 1:

10.5 *	9.4 ↗	9.9 ↗	10.4 *	10.5 *
10.1 ↙	9.4 ↘	10.4 *	10.3 *	9.7 ↘

beste Teiler 108.4 (5.) 117.2 (1.) 127.2 (8.)

Trefferlage 0.67 mm rechts, 0.48 mm hoch

Streuwert 1.73, horizontal: 2.01, vertikal: 1.39

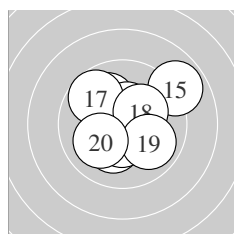

Serie 2:

10.0 ↘	10.6 *	10.2 *	10.4 *	8.9 ↗
10.5 *	9.7 ↘	10.2 *	9.9 ↘	10.1 ↙

beste Teiler 84.5 (12.) 125.0 (16.) 129.1 (14.)

Trefferlage 0.18 mm rechts, 0.41 mm hoch

Streuwert 1.86, horizontal: 1.98, vertikal: 1.73

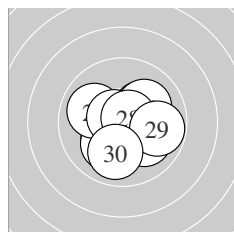

Serie 3:

10.2 *	10.2 *	10.1 ↙	10.0 ↖	10.1 ↘
10.1 ↗	10.6 *	10.7 *	9.8 ↗	10.0 ↓

beste Teiler 60.0 (28.) 79.7 (27.) 179.5 (21.)

Trefferlage 0.23 mm rechts, 0.34 mm tief

Streuwert 1.50, horizontal: 1.67, vertikal: 1.32

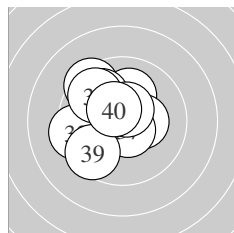

Serie 4:

10.1 ↑	9.4 ←	10.3 *	9.4 ↘	9.9 ↘
9.7 ↘	10.6 *	10.6 *	9.5 ↙	10.5 *

beste Teiler 84.3 (37.) 99.2 (38.) 119.6 (40.)

Trefferlage 1.06 mm links, 0.67 mm hoch

Streuwert 1.72, horizontal: 1.73, vertikal: 1.71

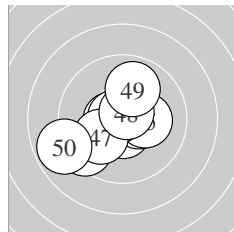

Serie 5:

10.6 *	9.4 ↙	10.6 *	10.4 *	10.2 *
10.7 *	10.0 ↙	10.7 *	9.9 ↑	8.8 ←

beste Teiler 63.1 (46.) 65.3 (48.) 98.1 (41.)

Trefferlage 0.68 mm links, 0.43 mm tief

Streuwert 1.76, horizontal: 2.04, vertikal: 1.43

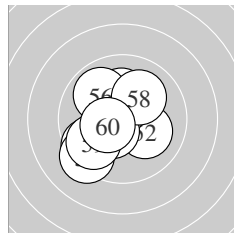

Serie 6:

9.5 ↙	10.1 ↘	10.7 *	10.2 *	9.3 ↙
9.9 ↘	10.4 *	10.1 ↑	9.7 ↙	10.4 *

beste Teiler 74.6 (53.) 132.4 (57.) 132.7 (60.)

Trefferlage 0.93 mm links, 0.32 mm tief

Streuwert 1.72, horizontal: 1.63, vertikal: 1.80

**ISSF AR Men – Wertung – Junioren**

StandNr: 130

**Friman,, Björn** #70804645

**StartNr: 26**

22. Januar 2017 10:11

F – Esbo Skytteförening

---

\_\_\_\_\_  
Unterschrift des Schuetzen

Meyton Elektronik

Ergebnis:	<b>580.7</b>	(552)
Serien:	97.8 96.8 96.6 97.7 98.9 92.9	
Zaehler:	22 29 8 1 0 0 0 0 0 0	
Innenzehner:	16	
weiteste:	876 (58), 724 (44), 629 (27)	
beste Teiler	15.8 (46.) 36.1 (55.) 62.6 (49.)	
Trefferlage	0.70 mm links, 0.46 mm hoch	
Streuwert	2.50, horizontal: 3.07, vertikal: 1.77	

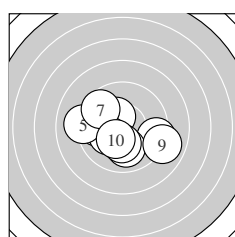
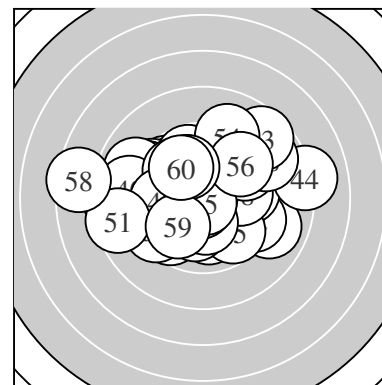

Serie 1:	9.8 ←	10.4 *	10.2 *	9.3 →	9.1 ←
	10.0 ↓	9.6 ↖	10.2 *	8.9 →	10.3 *
beste Teiler	143.5 (2.) 159.5 (10.) 189.2 (8.)				
Trefferlage	0.44 mm links, 0.60 mm tief				
Streuwert	2.29, horizontal: 2.88, vertikal: 1.48				

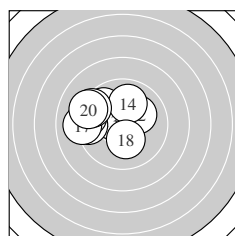

Serie 2:	9.8 ↖	10.1 ↗	10.4 *	10.0 ↑	9.4 ←
	9.3 ←	9.1 ←	10.2 *	9.3 ↖	9.2 ↖
beste Teiler	144.6 (13.) 180.8 (18.) 204.1 (12.)				
Trefferlage	2.11 mm links, 0.84 mm hoch				
Streuwert	1.87, horizontal: 2.32, vertikal: 1.26				

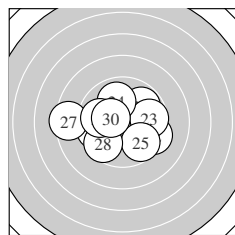

Serie 3:	9.8 ↗	9.4 →	9.7 →	10.0 ↑	9.7 ↘
	9.7 ←	8.4 ←	9.6 ↙	9.9 ←	10.4 *
beste Teiler	145.1 (30.) 250.2 (24.) 267.3 (29.)				
Trefferlage	0.54 mm links, 0.14 mm tief				
Streuwert	2.53, horizontal: 3.19, vertikal: 1.63				

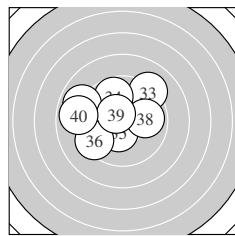

Serie 4:	10.7 *	10.2 *	9.1 ↗	9.7 ↑	10.4 *
	9.4 ↙	8.9 ↖	9.9 →	10.5 *	8.9 ←
beste Teiler	70.2 (31.) 112.5 (39.) 139.4 (35.)				
Trefferlage	1.21 mm links, 0.71 mm hoch				
Streuwert	2.26, horizontal: 2.69, vertikal: 1.74				

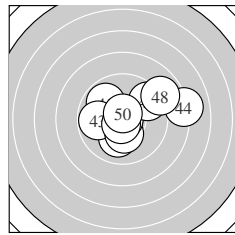

Serie 5:	9.9 ↖	10.1 ↓	9.8 ←	8.1 →	10.3 *
	10.9 *	9.5 ↗	8.9 ↗	10.7 *	10.7 *
beste Teiler	15.8 (46.) 62.6 (49.) 65.0 (50.)				
Trefferlage	0.91 mm rechts, 0.39 mm hoch				
Streuwert	2.43, horizontal: 3.02, vertikal: 1.63				

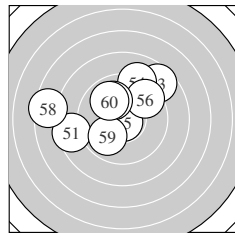

Serie 6:	8.5 ←	9.2 ↗	8.6 ↗	9.1 ↑	10.8 *
	9.5 ↗	10.0 ↖	7.4 ←	9.9 ↙	9.9 ↖
beste Teiler	36.1 (55.) 241.0 (57.) 260.6 (60.)				
Trefferlage	0.79 mm links, 1.60 mm hoch				
Streuwert	3.24, horizontal: 3.99, vertikal: 2.26				

Meyton Elektronik

**ISSF AR Men – Wertung – Junioren**

StandNr: 132

**Lintner, Stefan** #325

**StartNr: 28**

22. Januar 2017 10:10

T – SG Hötting

---

\_\_\_\_\_  
Unterschrift des Schuetzen

Meyton Elektronik

Ergebnis:	<b>608.7</b>	(585)						
Serien:	102.2	102.0	102.0	100.5	99.7	102.3		
Zaehler:	45	15	0	0	0	0	0	0
Innenzehner:	30							
weiteste:	446 (43), 414 (41), 391 (39)							
beste Teiler	50.6 (52.) 62.0 (1.) 73.8 (32.)							
Trefferlage	0.09 mm rechts, 0.28 mm hoch							
Streuwert	1.57, horizontal: 1.85, vertikal: 1.22							

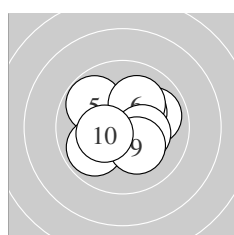
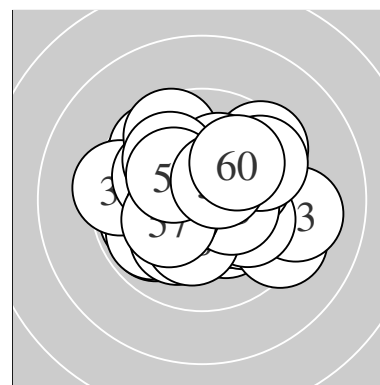

Serie 1:	10.7 *	10.6 *	9.9 ↗	10.3 *	9.8 ↘
	10.1 ↗	10.3 *	9.9 ↙	10.2 *	10.4 *
beste Teiler	62.0 (1.) 83.7 (2.) 150.8 (10.)				
Trefferlage	0.25 mm rechts, 0.24 mm hoch				
Streuwert	1.44, horizontal: 1.62, vertikal: 1.24				

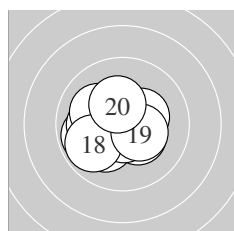

Serie 2:	10.1 ↙	10.3 *	10.6 *	9.9 ↖	10.1 ←
	10.1 ↘	10.3 *	9.9 ↗	10.4 *	10.3 *
beste Teiler	79.6 (13.) 148.0 (19.) 153.6 (12.)				
Trefferlage	0.66 mm links, 0.32 mm tief				
Streuwert	1.36, horizontal: 1.61, vertikal: 1.05				

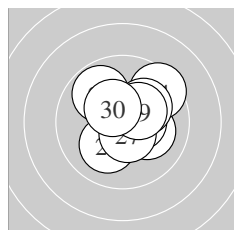

Serie 3:	10.6 *	10.1 ↙	10.1 ↘	9.5 ↗	10.5 *
	9.8 ↘	10.6 *	10.1 ↗	10.3 *	10.4 *
beste Teiler	88.6 (21.) 100.8 (27.) 122.0 (25.)				
Trefferlage	0.59 mm rechts, 0.51 mm hoch				
Streuwert	1.40, horizontal: 1.45, vertikal: 1.35				

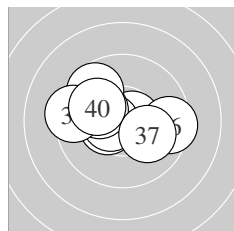

Serie 4:	10.5 *	10.7 *	10.6 *	9.8 ↘	10.2 *
	9.5 →	10.1 ↘	9.7 ↘	9.4 ←	10.0 ↘
beste Teiler	73.8 (32.) 94.8 (33.) 124.5 (31.)				
Trefferlage	0.81 mm links, 0.46 mm hoch				
Streuwert	1.76, horizontal: 2.27, vertikal: 1.02				

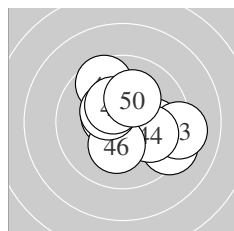

Serie 5:	9.3 ↘	10.0 →	9.2 →	10.0 ↘	10.5 *
	10.2 *	9.6 ↘	10.4 *	10.4 *	10.1 ↗
beste Teiler	110.8 (45.) 140.0 (48.) 150.4 (49.)				
Trefferlage	0.86 mm rechts, 0.17 mm hoch				
Streuwert	1.90, horizontal: 2.16, vertikal: 1.60				

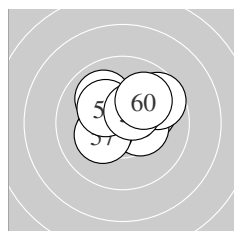

Serie 6:	10.1 ↗	10.8 *	10.4 *	9.7 ↗	10.0 ↘
	10.4 *	10.2 *	10.2 *	10.5 *	10.0 ↗
beste Teiler	50.6 (52.) 118.4 (59.) 143.0 (53.)				
Trefferlage	0.32 mm rechts, 0.64 mm hoch				
Streuwert	1.37, horizontal: 1.64, vertikal: 1.04				

Meyton Elektronik

**ISSF AR Men – Wertung – Junioren**

StandNr: 133

**Henchoz, Valentin** #70804634

**StartNr: 29**

22. Januar 2017 10:05

Switzerland

---

\_\_\_\_\_  
Unterschrift des Schuetzen

Meyton Elektronik

Ergebnis:	<b>609.2</b>	(583)
Serien:	102.7	101.3 100.9 103.0 101.6 99.7
Zaehler:	43	17 0 0 0 0 0 0 0 0
Innenzehner:	28	
weiteste:	451	(17), 373 (25), 358 (9)
beste Teiler	15.6	(31.) 39.4 (3.) 40.7 (36.)
Trefferlage	0.59	mm rechts, 0.32 mm tief
Streuwert	1.51,	horizontal: 1.70, vertikal: 1.28

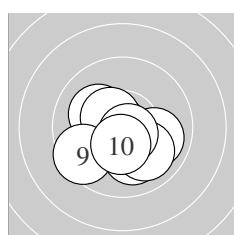
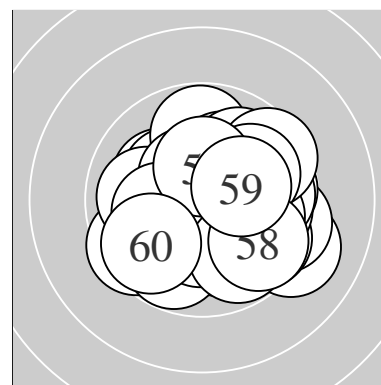

Serie 1:	10.0 ↘	10.6 *	10.8 *	10.1 ↖	10.1 ↓
	10.5 *	10.0 ↘	10.7 *	9.5 ↙	10.4 *
beste Teiler	39.4	(3.) 63.8 (8.)	87.6 (2.)		
Trefferlage	0.11	mm links, 0.75 mm tief			
Streuwert	1.34,	horizontal: 1.56, vertikal: 1.09			

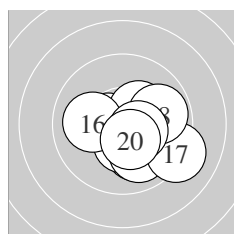

Serie 2:	10.5 *	10.1 ↓	10.3 *	10.4 *	10.0 ↓
	10.1 ←	9.1 ↘	9.9 →	10.5 *	10.4 *
beste Teiler	108.2	(11.) 125.3 (19.)	128.7 (20.)		
Trefferlage	0.84	mm rechts, 0.73 mm tief			
Streuwert	1.49,	horizontal: 1.75, vertikal: 1.19			

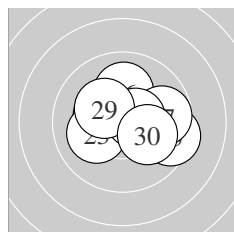

Serie 3:	10.2 *	10.3 *	10.1 ↙	9.9 →	9.5 →
	10.1 ↑	9.8 →	10.6 *	10.3 *	10.1 ↘
beste Teiler	100.2	(28.) 153.3 (22.)	170.6 (29.)		
Trefferlage	0.91	mm rechts, 0.09 mm hoch			
Streuwert	1.59,	horizontal: 1.99, vertikal: 1.03			

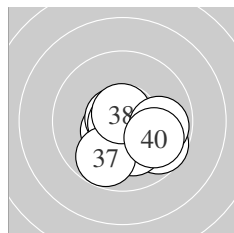

Serie 4:	10.9 *	10.5 *	9.7 ↘	10.7 *	10.1 ↓
	10.8 *	9.8 ↙	10.7 *	9.9 →	9.9 ↘
beste Teiler	15.6	(31.) 40.7 (36.)	55.5 (38.)		
Trefferlage	0.52	mm rechts, 0.81 mm tief			
Streuwert	1.30,	horizontal: 1.53, vertikal: 1.03			

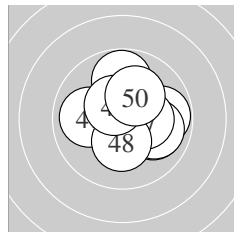

Serie 5:	10.0 ←	10.0 ↘	9.8 ↑	9.8 →	10.0 →
	10.7 *	10.3 *	10.3 *	10.5 *	10.2 *
beste Teiler	73.5	(46.) 119.8 (49.)	161.0 (47.)		
Trefferlage	0.72	mm rechts, 0.33 mm hoch			
Streuwert	1.48,	horizontal: 1.63, vertikal: 1.32			

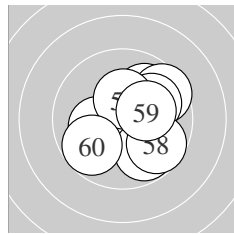

Serie 6:	9.9 ↗	10.2 *	10.2 *	9.6 ↗	10.0 →
	10.4 *	9.8 ↘	9.7 ↘	10.2 *	9.7 ↙
beste Teiler	150.1	(56.) 186.2 (59.)	190.2 (52.)		
Trefferlage	0.69	mm rechts, 0.06 mm tief			
Streuwert	1.82,	horizontal: 1.96, vertikal: 1.67			

Meyton Elektronik

**ISSF AR Men – Wertung – Junioren**

StandNr: 105

**Roope, Pohjoisaho** #70804639

**StartNr: 1**

22. Januar 2017 9:45

FIN

---

\_\_\_\_\_  
Unterschrift des Schuetzen

Meyton Elektronik



Ergebnis: **599.4** (570)

Serien: 97.7 101.7 100.4 102.8 98.6 98.2

Zaehler: 33 25 1 1 0 0 0 0 0 0

Innenzehner: 24

weiteste: 907 (1), 537 (58), 449 (6)

beste Teiler 8.5 (22.) 22.8 (8.) 40.0 (37.)

Trefferlage 0.44 mm links, 0.07 mm hoch

Streuwert 2.01, horizontal: 2.18, vertikal: 1.81

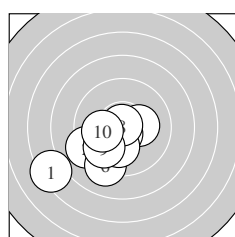
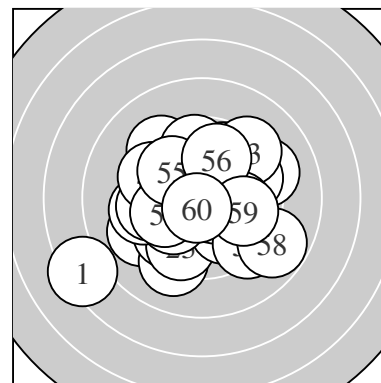

Serie 1:

7.3 ↙	9.2 ↙	10.3 *	10.1 ↙	10.7 *
9.2 ↓	10.1 ↓	10.9 *	9.8 ↘	10.1 ←

beste Teiler 22.8 (8.) 72.3 (5.) 175.8 (3.)

Trefferlage 1.84 mm links, 1.69 mm tief

Streuwert 2.19, horizontal: 2.59, vertikal: 1.70

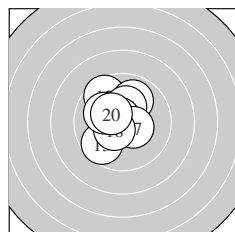

Serie 2:

10.1 ↘	9.6 ↘	9.7 ↘	9.9 ↗	10.3 *
10.7 *	10.4 *	10.5 *	10.1 ↘	10.4 *

beste Teiler 56.0 (16.) 119.6 (18.) 126.1 (17.)

Trefferlage 0.75 mm links, 0.68 mm hoch

Streuwert 1.41, horizontal: 1.25, vertikal: 1.55

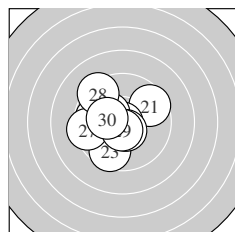

Serie 3:

9.6 ↗	10.9 *	9.6 ↓	10.3 *	9.8 ←
10.6 *	9.4 ←	9.3 ↘	10.6 *	10.3 *

beste Teiler 8.5 (22.) 86.2 (29.) 96.9 (26.)

Trefferlage 1.05 mm links, 0.10 mm hoch

Streuwert 1.81, horizontal: 1.94, vertikal: 1.68

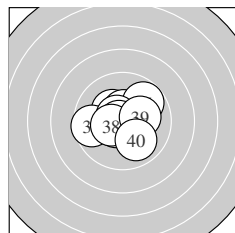

Serie 4:

10.3 *	10.5 *	9.6 ←	10.6 *	9.8 ↗
10.6 *	10.8 *	10.4 *	10.2 *	10.0 ↘

beste Teiler 40.0 (37.) 82.9 (36.) 93.5 (34.)

Trefferlage 0.17 mm links, 0.16 mm hoch

Streuwert 1.43, horizontal: 1.67, vertikal: 1.14

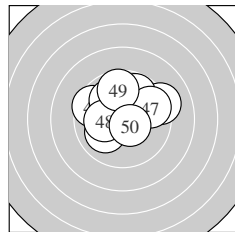

Serie 5:

9.6 ↘	9.2 ↗	9.9 ↑	9.8 ↗	10.0 ↙
10.0 ↘	9.7 ↗	10.2 *	9.7 ↑	10.5 *

beste Teiler 106.3 (50.) 195.0 (48.) 232.0 (45.)

Trefferlage 0.03 mm rechts, 1.23 mm hoch

Streuwert 1.95, horizontal: 2.30, vertikal: 1.52

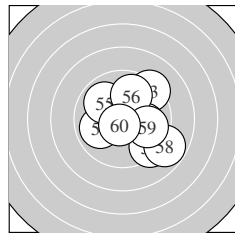

Serie 6:

10.6 *	9.9 ←	9.3 ↗	10.0 →	9.9 ↘
9.9 ↑	9.3 ↘	8.8 ↘	9.8 →	10.7 *

beste Teiler 73.3 (60.) 98.3 (51.) 238.5 (54.)

Trefferlage 1.13 mm rechts, 0.05 mm tief

Streuwert 2.20, horizontal: 2.31, vertikal: 2.08

**ISSF AR Men – Wertung – Junioren**

StandNr: 106

**Erler, Sebastian** #70804360

**StartNr: 2**

22. Januar 2017 9:55

SG Rettenberg Wattens

---

\_\_\_\_\_  
Unterschrift des Schuetzen

Meyton Elektronik

Ergebnis: **611.3** (583)

Serien: 102.3 103.6 103.5 101.6 98.8 101.5

Zaehler: 43 17 0 0 0 0 0 0 0 0

Innenzehner: 32

weiteste: 489 (41), 469 (19), 403 (54)

beste Teiler 34.0 (46.) 42.7 (22.) 49.0 (14.)

Trefferlage 0.84 mm links, 0.13 mm hoch

Streuwert 1.44, horizontal: 1.41, vertikal: 1.47

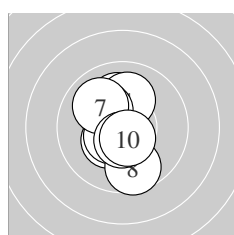
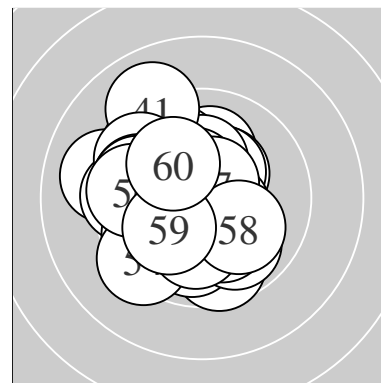

Serie 1:

10.1 ↑	10.4 *	10.3 *	10.1 ↑	10.2 *
10.5 *	10.0 ↘	9.6 ↓	10.5 *	10.6 *

beste Teiler 96.2 (10.) 102.1 (9.) 112.4 (6.)

Trefferlage 0.47 mm links, 0.18 mm hoch

Streuwert 1.40, horizontal: 0.85, vertikal: 1.79

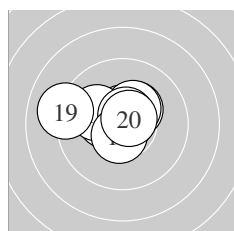

Serie 2:

10.3 *	10.4 *	10.6 *	10.8 *	10.4 *
10.1 ↘	10.6 *	10.6 *	9.1 ←	10.7 *

beste Teiler 49.0 (14.) 68.6 (20.) 76.5 (17.)

Trefferlage 0.53 mm links, 0.61 mm hoch

Streuwert 1.29, horizontal: 1.71, vertikal: 0.63

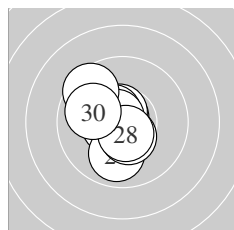

Serie 3:

10.5 *	10.8 *	10.6 *	9.9 ↓	10.5 *
10.5 *	10.7 *	10.6 *	9.5 ↘	9.9 ←

beste Teiler 42.7 (22.) 64.4 (27.) 84.4 (23.)

Trefferlage 0.74 mm links, 0.08 mm hoch

Streuwert 1.20, horizontal: 1.01, vertikal: 1.37

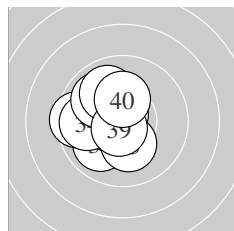

Serie 4:

10.0 ↙	10.6 *	9.5 ←	9.8 ←	10.2 *
10.7 *	9.9 ↘	9.9 ↘	10.7 *	10.3 *

beste Teiler 52.5 (36.) 63.0 (39.) 91.0 (32.)

Trefferlage 1.21 mm links, 0.17 mm hoch

Streuwert 1.36, horizontal: 1.31, vertikal: 1.40

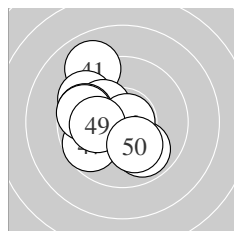

Serie 5:

9.0 ↘	9.6 ↘	10.2 *	9.7 ←	9.9 ↓
10.8 *	9.7 ↙	9.7 ←	10.1 ←	10.1 ↓

beste Teiler 34.0 (46.) 193.0 (43.) 202.9 (49.)

Trefferlage 1.46 mm links, 0.29 mm hoch

Streuwert 1.86, horizontal: 1.76, vertikal: 1.95

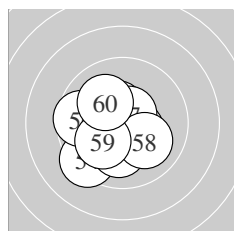

Serie 6:

10.5 *	10.6 *	10.5 *	9.3 ↙	10.1 ↓
9.6 ←	10.6 *	10.1 ↘	10.1 ↙	10.1 ↘

beste Teiler 82.2 (52.) 85.4 (57.) 115.8 (51.)

Trefferlage 0.64 mm links, 0.53 mm tief

Streuwert 1.55, horizontal: 1.63, vertikal: 1.48

Meyton Elektronik

**ISSF AR Men – Wertung – Junioren**

StandNr: 107

**Rossiter, Jack** #70804629

**StartNr: 3**

22. Januar 2017 9:49

Australia

---

\_\_\_\_\_  
Unterschrift des Schuetzen

Meyton Elektronik

Ergebnis: **616.5** (588)<sup>QF</sup>  
 Serien: 104.5 103.1 101.9 103.5 102.3 101.2  
 Zaehler: 48 12 0 0 0 0 0 0 0  
 Innenzehner: 41  
 weiteste: 432 (54), 406 (48), 365 (45)  
 beste Teiler 40.8 (59.) 42.1 (50.) 46.3 (4.)  
 Trefferlage 0.39 mm rechts, 0.08 mm hoch  
 Streuwert 1.36, horizontal: 1.58, vertikal: 1.09

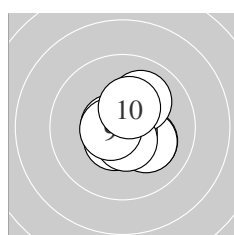
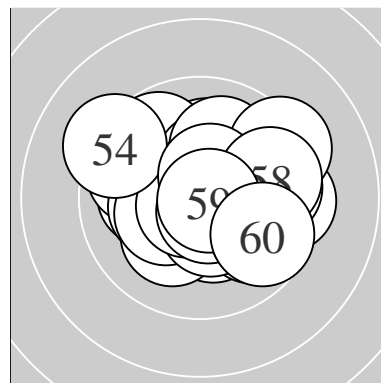

Serie 1:  
 10.2 \* 10.2 \* 10.5 \* 10.8 \* 10.6 \*  
 10.6 \* 10.0 ↗ 10.6 \* 10.6 \* 10.4 \*  
 beste Teiler 46.3 (4.) 79.0 (6.) 86.3 (9.)  
 Trefferlage 0.38 mm rechts, 0.02 mm tief  
 Streuwert 1.00, horizontal: 0.95, vertikal: 1.05

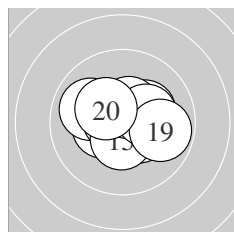

Serie 2:  
 10.4 \* 10.0 ↖ 10.4 \* 10.7 \* 10.5 \*  
 10.2 \* 10.5 \* 10.3 \* 9.8 → 10.3 \*  
 beste Teiler 64.5 (14.) 114.2 (17.) 120.3 (15.)  
 Trefferlage 0.19 mm rechts, 0.15 mm hoch  
 Streuwert 1.27, horizontal: 1.61, vertikal: 0.82

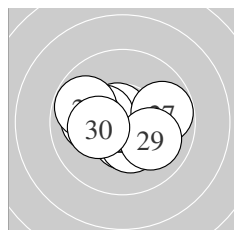

Serie 3:  
 10.7 \* 10.5 \* 10.1 ↘ 10.3 \* 10.4 \*  
 10.1 ← 9.8 → 9.8 ↖ 10.0 ↘ 10.2 \*  
 beste Teiler 69.3 (21.) 118.2 (22.) 148.6 (25.)  
 Trefferlage 0.12 mm links, 0.23 mm tief  
 Streuwert 1.50, horizontal: 1.90, vertikal: 0.94

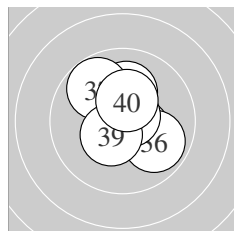

Serie 4:  
 10.4 \* 10.7 \* 10.4 \* 10.8 \* 10.1 ↑  
 9.9 ↘ 9.8 ↘ 10.7 \* 10.4 \* 10.3 \*  
 beste Teiler 50.9 (34.) 55.3 (32.) 60.0 (38.)  
 Trefferlage 0.16 mm rechts, 0.45 mm hoch  
 Streuwert 1.21, horizontal: 1.09, vertikal: 1.33

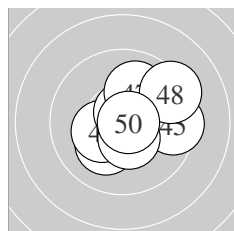

Serie 5:  
 10.2 \* 10.5 \* 10.3 \* 10.5 \* 9.5 →  
 10.7 \* 10.0 ↗ 9.3 ↗ 10.5 \* 10.8 \*  
 beste Teiler 42.1 (50.) 72.5 (46.) 109.6 (42.)  
 Trefferlage 0.76 mm rechts, 0.12 mm hoch  
 Streuwert 1.50, horizontal: 1.67, vertikal: 1.32

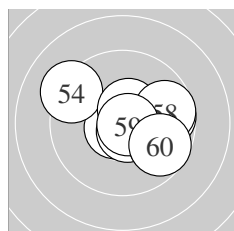

Serie 6:  
 10.7 \* 10.7 \* 9.7 ↘ 9.2 ↖ 10.5 \*  
 9.7 → 10.5 \* 9.7 → 10.8 \* 9.7 ↘  
 beste Teiler 40.8 (59.) 62.9 (51.) 68.6 (52.)  
 Trefferlage 0.95 mm rechts, 0.05 mm hoch  
 Streuwert 1.69, horizontal: 2.09, vertikal: 1.15

Meyton Elektronik

**ISSF AR Men – Wertung – Junioren**

StandNr: 108

**Friman,, Cristian** #70804640

**StartNr: 4**

22. Januar 2017 10:09

F – Esbo Skytteförening

---

QF – Schütze hat sich fürs Finale qualifiziert

---

Unterschrift des Schuetzen

Meyton Elektronik

Ergebnis: **607.5** (584)

Serien: 103.1 100.6 100.4 101.8 100.9 100.7

Zaehler: 45 14 1 0 0 0 0 0 0 0

Innenzehner: 31

weiteste: 611 (12), 433 (21), 416 (38)

beste Teiler 27.1 (14.) 41.0 (32.) 41.1 (25.)

Trefferlage 0.08 mm links, 0.31 mm hoch

Streuwert 1.65, horizontal: 1.67, vertikal: 1.62

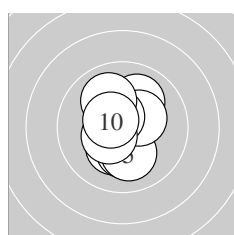
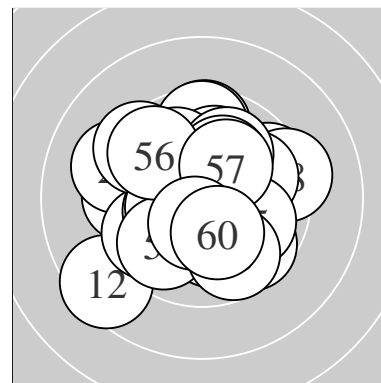

Serie 1:

10.0 ↗	10.3 *	10.2 *	10.6 *	10.1 ↓
10.4 *	10.6 *	10.4 *	10.0 ↘	10.5 *

beste Teiler 85.4 (4.) 96.7 (7.) 110.7 (10.)

Trefferlage 0.09 mm links, 0.08 mm hoch

Streuwert 1.26, horizontal: 0.91, vertikal: 1.54

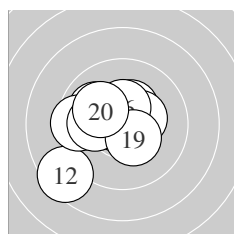

Serie 2:

10.0 ↘	8.5 ↙	10.4 *	10.8 *	10.4 *
10.4 *	9.5 ←	10.1 ←	10.4 *	10.1 ↘

beste Teiler 27.1 (14.) 133.0 (16.) 139.6 (19.)

Trefferlage 1.16 mm links, 0.04 mm hoch

Streuwert 1.82, horizontal: 1.99, vertikal: 1.63

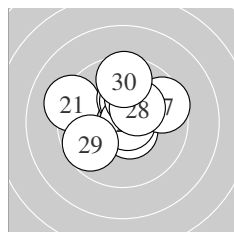

Serie 3:

9.2 ↘	10.2 *	10.3 *	10.6 *	10.8 *
10.1 ↗	9.6 →	10.3 *	9.7 ↙	9.6 ↑

beste Teiler 41.1 (25.) 91.6 (24.) 164.7 (28.)

Trefferlage 0.01 mm rechts, 1.05 mm hoch

Streuwert 1.75, horizontal: 2.00, vertikal: 1.47

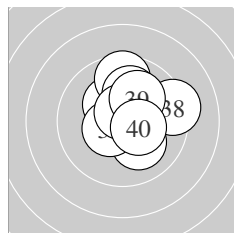

Serie 4:

10.3 *	10.8 *	9.6 ↑	10.1 ↘	10.0 ↑
10.5 *	10.7 *	9.3 →	10.1 ↗	10.4 *

beste Teiler 41.0 (32.) 73.1 (37.) 117.4 (36.)

Trefferlage 0.67 mm rechts, 0.78 mm hoch

Streuwert 1.47, horizontal: 1.44, vertikal: 1.50

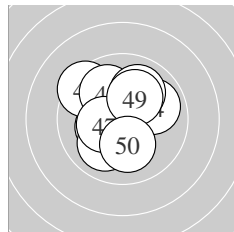

Serie 5:

10.3 *	10.0 ↙	10.7 *	9.9 →	9.4 ↘
10.0 ↘	10.3 *	10.0 ↗	10.2 *	10.1 ↓

beste Teiler 71.0 (43.) 152.4 (47.) 170.0 (41.)

Trefferlage 0.33 mm links, 0.49 mm hoch

Streuwert 1.66, horizontal: 1.64, vertikal: 1.67

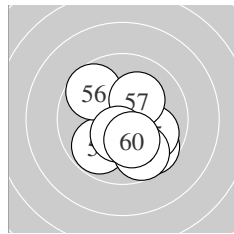

Serie 6:

9.7 ↘	10.7 *	10.4 *	9.8 ↙	9.9 ↘
9.7 ↘	10.2 *	9.7 ↘	10.4 *	10.2 *

beste Teiler 61.8 (52.) 126.1 (53.) 126.9 (59.)

Trefferlage 0.41 mm rechts, 0.56 mm tief

Streuwert 1.67, horizontal: 1.57, vertikal: 1.76

Meyton Elektronik

**ISSF AR Men – Wertung – Junioren**

StandNr: 109

**Karlon, Alexander** #101

**StartNr: 5**

22. Januar 2017 9:57

Kapfenberger SV

---

\_\_\_\_\_  
Unterschrift des Schuetzen

Meyton Elektronik



Ergebnis:	<b>611.8</b>	(585) <sup>QF</sup>						
Serien:	102.9	102.5	101.9	103.6	100.8	100.1		
Zaehler:	45	15	0	0	0	0	0	0
Innenzehner:	37							
weiteste:	404 (50), 362 (22), 355 (42)							
beste Teiler	25.0 (14.) 36.8 (29.) 53.2 (36.)							
Trefferlage	0.13 mm rechts, 0.42 mm hoch							
Streuwert	1.45, horizontal: 1.58, vertikal: 1.32							

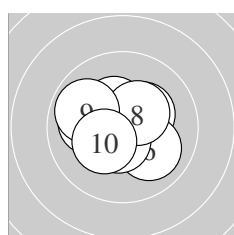
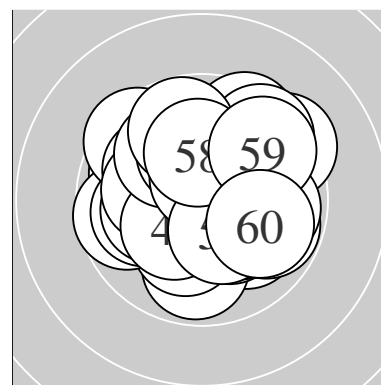

Serie 1:					
	10.3 *	10.6 *	10.4 *	10.4 *	10.0 ←
	10.0 ↘	10.6 *	10.4 *	9.9 ↖	10.3 *
beste Teiler	88.2 (2.) 98.0 (7.) 134.4 (3.)				
Trefferlage	0.47 mm links, 0.17 mm hoch				
Streuwert	1.26, horizontal: 1.48, vertikal: 0.98				

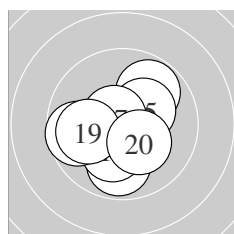

Serie 2:					
	9.9 ↓	9.8 ↗	10.2 *	10.9 *	10.3 *
	10.7 *	10.7 *	9.7 ←	10.0 ←	10.3 *
beste Teiler	25.0 (14.) 73.6 (17.) 75.0 (16.)				
Trefferlage	0.32 mm links, 0.33 mm tief				
Streuwert	1.50, horizontal: 1.58, vertikal: 1.41				

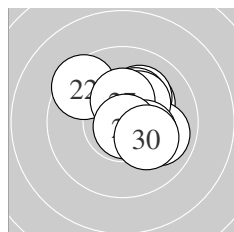

Serie 3:					
	10.2 *	9.5 ↖	10.1 ↗	9.9 →	10.2 *
	10.3 *	10.4 *	10.3 *	10.8 *	10.2 *
beste Teiler	36.8 (29.) 150.0 (27.) 166.8 (28.)				
Trefferlage	0.76 mm rechts, 0.68 mm hoch				
Streuwert	1.33, horizontal: 1.40, vertikal: 1.26				

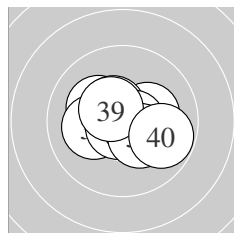

Serie 4:					
	10.6 *	10.2 *	10.2 *	10.1 ←	10.5 *
	10.7 *	10.7 *	10.3 *	10.5 *	9.8 →
beste Teiler	53.2 (36.) 71.5 (37.) 86.5 (31.)				
Trefferlage	0.02 mm rechts, 0.07 mm hoch				
Streuwert	1.19, horizontal: 1.50, vertikal: 0.77				

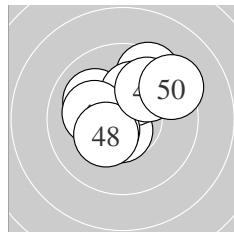

Serie 5:					
	10.4 *	9.5 ↗	10.6 *	10.0 ↖	10.2 *
	10.4 *	10.2 *	10.3 *	9.9 ↗	9.3 ↗
beste Teiler	80.4 (43.) 130.4 (46.) 133.7 (41.)				
Trefferlage	0.01 mm rechts, 0.75 mm hoch				
Streuwert	1.66, horizontal: 1.80, vertikal: 1.51				

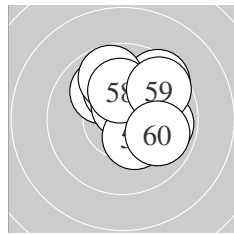

Serie 6:					
	10.0 ↖	10.1 ↑	9.9 →	10.6 *	9.5 ↗
	10.4 *	9.8 ↑	10.2 *	9.7 ↗	9.9 →
beste Teiler	91.1 (54.) 150.8 (56.) 197.8 (58.)				
Trefferlage	0.80 mm rechts, 1.17 mm hoch				
Streuwert	1.55, horizontal: 1.59, vertikal: 1.51				

Meyton Elektronik

**ISSF AR Men – Wertung – Junioren**

StandNr: 110

**Fankhauser, Thomas #88**

**StartNr: 6**

22. Januar 2017 9:43

T – SG Fügenberg

---

QF – Schütze hat sich fürs Finale qualifiziert

---

Unterschrift des Schuetzen

Meyton Elektronik

Ergebnis:	<b>611.5</b>	(586)					
Serien:	100.8	102.8	101.4	101.4	101.3	103.8	
Zaehler:	46	14	0	0	0	0	0
Innenzehner:	34						
weiteste:	393 (44), 389 (25), 384 (16)						
beste Teiler	23.3 (12.) 57.5 (29.) 66.0 (26.)						
Trefferlage	0.32 mm links, 0.19 mm hoch						
Streuwert	1.51, horizontal: 1.45, vertikal: 1.57						

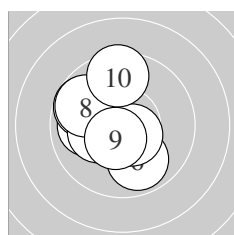
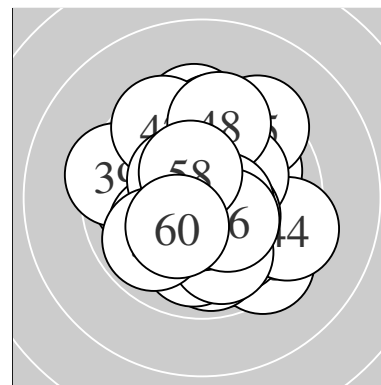

Serie 1:	10.0 ↖	10.0 ←	10.6 *	9.7 ↖	10.2 *
	9.9 ↓	10.6 *	9.8 ↖	10.5 *	9.5 ↑
beste Teiler	96.8 (3.) 96.9 (7.) 108.7 (9.)				
Trefferlage	1.18 mm links, 0.24 mm hoch				
Streuwert	1.53, horizontal: 1.39, vertikal: 1.66				

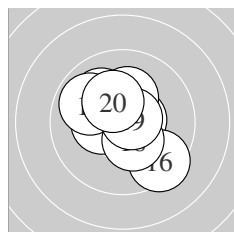

Serie 2:	10.0 ↖	10.9 *	10.4 *	10.6 *	10.2 *
	9.4 ↘	9.9 ↖	10.4 *	10.7 *	10.3 *
beste Teiler	23.3 (12.) 68.7 (19.) 96.5 (14.)				
Trefferlage	0.07 mm links, 0.27 mm hoch				
Streuwert	1.46, horizontal: 1.48, vertikal: 1.44				

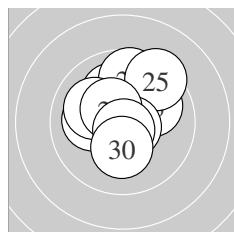

Serie 3:	10.1 ↖	9.7 ↑	10.0 ↗	10.1 ←	9.4 ↗
	10.7 *	10.1 ↖	10.4 *	10.7 *	10.2 *
beste Teiler	57.5 (29.) 66.0 (26.) 126.9 (28.)				
Trefferlage	0.01 mm links, 0.87 mm hoch				
Streuwert	1.56, horizontal: 1.52, vertikal: 1.59				

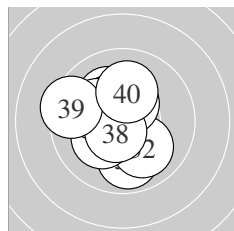

Serie 4:	9.9 ↓	10.0 ↘	10.2 *	10.4 *	10.2 *
	10.4 *	10.2 *	10.6 *	9.4 ↖	10.1 ↑
beste Teiler	90.1 (38.) 132.5 (34.) 142.5 (36.)				
Trefferlage	0.69 mm links, 0.15 mm hoch				
Streuwert	1.55, horizontal: 1.46, vertikal: 1.64				

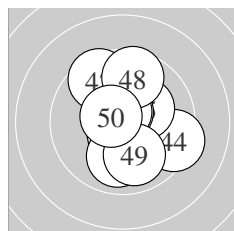

Serie 5:	10.6 *	9.6 ↖	10.0 ↓	9.4 ↗	10.2 *
	10.7 *	10.6 *	9.6 ↑	10.0 ↓	10.6 *
beste Teiler	74.0 (46.) 76.1 (47.) 91.7 (41.)				
Trefferlage	0.34 mm rechts, 0.21 mm hoch				
Streuwert	1.76, horizontal: 1.49, vertikal: 1.99				

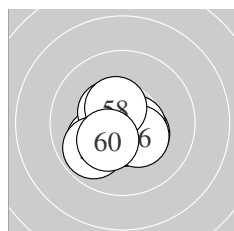

Serie 6:	10.6 *	10.1 ↗	10.6 *	10.4 *	10.6 *
	10.4 *	10.4 *	10.5 *	9.9 ↖	10.3 *
beste Teiler	87.1 (53.) 90.0 (51.) 92.7 (55.)				
Trefferlage	0.34 mm links, 0.61 mm tief				
Streuwert	1.05, horizontal: 1.17, vertikal: 0.91				

Meyton Elektronik

**ISSF AR Men – Wertung – Junioren**

StandNr: 111

**Chan, Emmanuel En Yue** #70804632

**StartNr: 7**

22. Januar 2017 9:59

Singapore

---

\_\_\_\_\_  
Unterschrift des Schuetzen

Meyton Elektronik

Ergebnis: **605.2** (578)

Serien: 101.4 100.9 101.0 99.3 101.6 101.0

Zaehler: 38 22 0 0 0 0 0 0 0 0

Innenzehner: 28

weiteste: 477 (37), 449 (29), 406 (34)

beste Teiler 29.4 (5.) 43.4 (43.) 57.7 (60.)

Trefferlage 0.33 mm links, 0.18 mm hoch

Streuwert 1.70, horizontal: 1.72, vertikal: 1.67

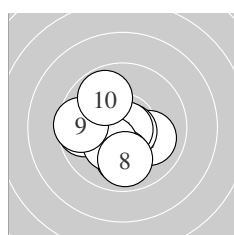
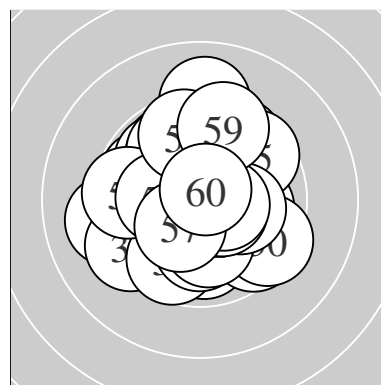

Serie 1:

9.7 ←	10.0 →	10.6 *	10.7 *	10.8 *
10.0 ↓	10.3 *	9.9 ↓	9.6 ←	9.8 ↘

beste Teiler 29.4 (5.) 65.5 (4.) 77.3 (3.)

Trefferlage 0.60 mm links, 0.61 mm tief

Streuwert 1.56, horizontal: 1.70, vertikal: 1.41

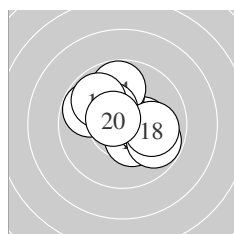

Serie 2:

10.4 *	10.3 *	10.0 ↑	9.8 ↑	10.3 *
9.8 ↖	9.8 ↘	10.0 →	9.9 ↘	10.6 *

beste Teiler 89.5 (20.) 144.8 (11.) 155.4 (15.)

Trefferlage 0.00 mm , 0.69 mm hoch

Streuwert 1.62, horizontal: 1.77, vertikal: 1.45

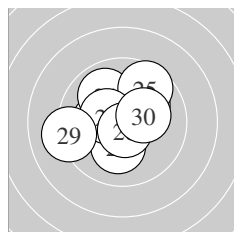

Serie 3:

10.1 ↗	10.5 *	10.2 *	9.9 ↘	9.6 ↗
10.2 *	10.4 *	10.7 *	9.2 ←	10.2 *

beste Teiler 67.7 (28.) 120.6 (22.) 136.7 (27.)

Trefferlage 0.50 mm links, 0.30 mm hoch

Streuwert 1.73, horizontal: 1.95, vertikal: 1.48

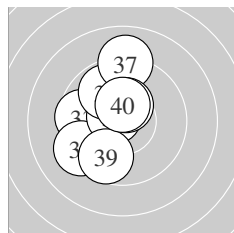

Serie 4:

10.3 *	10.1 ←	9.6 ←	9.3 ↖	10.6 *
9.9 ↘	9.0 ↑	10.4 *	9.7 ↓	10.4 *

beste Teiler 79.1 (35.) 132.7 (38.) 133.0 (40.)

Trefferlage 1.28 mm links, 0.55 mm hoch

Streuwert 1.82, horizontal: 1.32, vertikal: 2.21

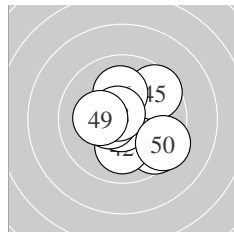

Serie 5:

9.6 ↘	10.1 ↓	10.8 *	10.6 *	9.6 ↗
10.1 ↑	10.5 *	10.7 *	10.2 *	9.4 ↘

beste Teiler 43.4 (43.) 59.4 (48.) 98.2 (44.)

Trefferlage 0.46 mm rechts, 0.13 mm tief

Streuwert 1.69, horizontal: 1.74, vertikal: 1.64

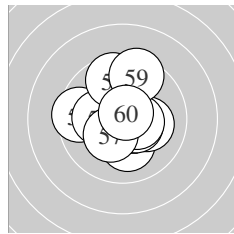

Serie 6:

9.5 ←	10.1 ↓	10.1 →	10.5 *	10.5 *
10.2 *	10.3 *	9.6 ↑	9.5 ↑	10.7 *

beste Teiler 57.7 (60.) 118.9 (54.) 119.4 (55.)

Trefferlage 0.11 mm links, 0.31 mm hoch

Streuwert 1.73, horizontal: 1.68, vertikal: 1.77

Meyton Elektronik

**ISSF AR Men – Wertung – Junioren**

StandNr: 112

**Riedo, Sven** #70804630

**StartNr: 8**

22. Januar 2017 10:08

Switzerland

---

\_\_\_\_\_  
Unterschrift des Schuetzen

Meyton Elektronik

Ergebnis:	<b>612.5</b>	(584) <sup>QF</sup>
Serien:	104.9	102.5 99.8 102.5 101.6 101.2
Zaehler:	45	14 1 0 0 0 0 0 0 0
Innenzehner:	39	
weiteste:	583	(27), 462 (15), 454 (28)
beste Teiler	7.0	(44.) 13.0 (3.) 37.0 (21.)
Trefferlage	0.08 mm	links, 0.11 mm hoch
Streuwert	1.59,	horizontal: 2.00, vertikal: 1.04

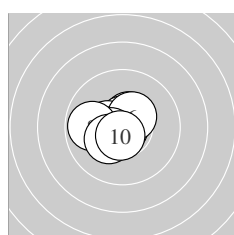
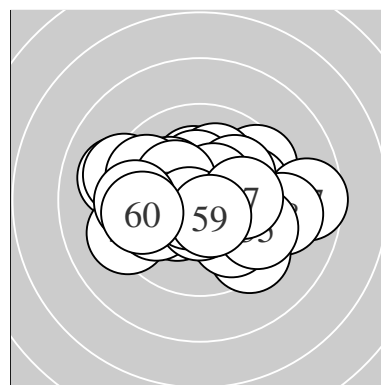

Serie 1:	10.5 *	10.7 *	10.9 *	10.4 *	10.8 *
	10.4 *	10.5 *	9.8 ←	10.3 *	10.6 *
beste Teiler	13.0	(3.) 37.7	(5.) 62.2	(2.)	
Trefferlage	0.54 mm	links, 0.02 mm	hoch		
Streuwert	0.90,	horizontal: 1.08,	vertikal: 0.69		

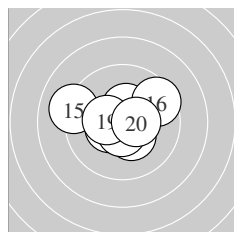

Serie 2:	10.5 *	10.4 *	10.4 *	10.7 *	9.1 ↖
	9.5 ↗	10.4 *	10.6 *	10.4 *	10.5 *
beste Teiler	64.5	(14.) 89.3	(18.) 115.8	(11.)	
Trefferlage	0.10 mm	links, 0.19 mm	hoch		
Streuwert	1.59,	horizontal: 1.99,	vertikal: 1.04		

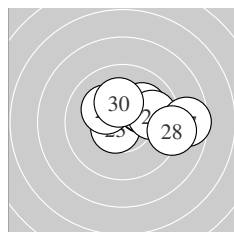

Serie 3:	10.8 *	10.3 *	10.6 *	10.1 ↗	10.1 ↗
	9.8 →	8.6 →	9.1 →	10.2 *	10.2 *
beste Teiler	37.0	(21.) 87.8	(23.) 172.2	(22.)	
Trefferlage	1.23 mm	rechts, 0.60 mm	hoch		
Streuwert	1.89,	horizontal: 2.52,	vertikal: 0.86		

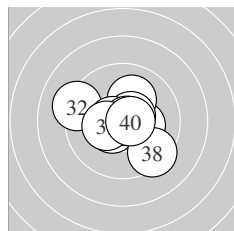

Serie 4:	10.3 *	9.2 ↖	10.1 ↗	10.6 *	10.5 *
	10.6 *	10.8 *	9.4 ↘	10.3 *	10.7 *
beste Teiler	40.0	(37.) 71.0	(40.) 86.9	(34.)	
Trefferlage	0.04 mm	links, 0.06 mm	tief		
Streuwert	1.63,	horizontal: 1.92,	vertikal: 1.28		

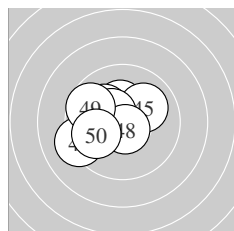

Serie 5:	9.2 ↖	10.4 *	10.3 *	10.9 *	10.0 ↗
	10.1 ↘	10.4 *	10.7 *	9.7 ↖	9.9 ↖
beste Teiler	7.0	(44.) 70.2	(48.) 128.0	(47.)	
Trefferlage	0.99 mm	links, 0.38 mm	hoch		
Streuwert	1.50,	horizontal: 1.75,	vertikal: 1.20		

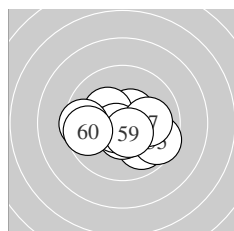

Serie 6:	10.5 *	9.9 ↘	10.3 *	10.5 *	9.6 ↘
	10.7 *	10.0 →	9.5 ←	10.5 *	9.7 ←
beste Teiler	74.8	(56.) 103.7	(59.) 106.0	(54.)	
Trefferlage	0.03 mm	links, 0.47 mm	tief		
Streuwert	1.70,	horizontal: 2.20,	vertikal: 0.97		

Meyton Elektronik

**ISSF AR Men – Wertung – Junioren**

StandNr: 113

**Clopatofsky, Daniel** #70804637

**StartNr: 9**

22. Januar 2017 10:06

Australia

---

QF – Schütze hat sich fürs Finale qualifiziert

---

Unterschrift des Schuetzen

Meyton Elektronik



Ergebnis:	<b>614.7</b>	(588) <sup>QF</sup>
Serien:	103.1 99.9	103.1 104.7 103.0 100.9
Zaehler:	48 12 0 0 0 0 0 0 0 0	
Innenzehner:	41	
weiteste:	397 (52), 363 (12), 360 (13)	
beste Teiler	33.1 (47.) 53.9 (40.) 61.2 (38.)	
Trefferlage	0.14 mm links, 0.39 mm hoch	
Streuwert	1.39, horizontal: 1.65, vertikal: 1.05	

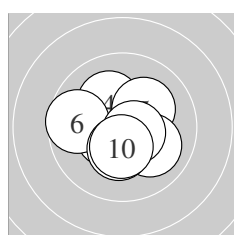
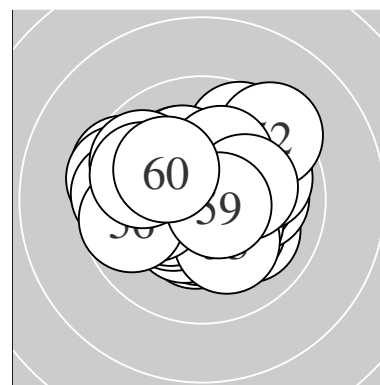

Serie 1:	10.5 *	10.5 *	10.7 *	10.2 *	10.2 *
	9.7 ←	10.0 ↘	10.6 *	10.3 *	10.4 *
beste Teiler	70.5 (3.)	87.6 (8.)	119.4 (1.)		
Trefferlage	0.25 mm links, 0.03 mm tief				
Streuwert	1.32, horizontal: 1.45, vertikal: 1.18				

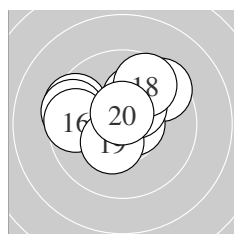

Serie 2:	9.5 ↖	9.5 ←	9.5 ↗	10.1 ↗	10.7 *
	9.6 ←	10.3 *	9.7 ↗	10.4 *	10.6 *
beste Teiler	75.0 (15.)	78.1 (20.)	146.9 (19.)		
Trefferlage	0.42 mm links, 1.03 mm hoch				
Streuwert	1.79, horizontal: 2.23, vertikal: 1.19				

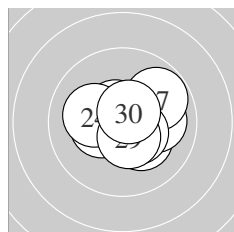

Serie 3:	10.6 *	10.2 *	10.4 *	10.1 ←	10.4 *
	10.0 →	9.8 ↗	10.5 *	10.5 *	10.6 *
beste Teiler	83.8 (30.)	89.8 (21.)	112.9 (29.)		
Trefferlage	0.52 mm rechts, 0.07 mm hoch				
Streuwert	1.22, horizontal: 1.47, vertikal: 0.89				

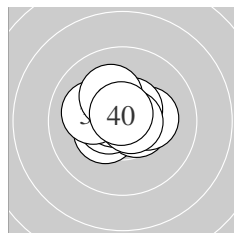

Serie 4:	10.4 *	10.5 *	10.6 *	10.3 *	10.5 *
	10.7 *	10.1 ←	10.7 *	10.2 *	10.7 *
beste Teiler	53.9 (40.)	61.2 (38.)	72.1 (36.)		
Trefferlage	0.19 mm links, 0.31 mm hoch				
Streuwert	0.96, horizontal: 1.16, vertikal: 0.70				

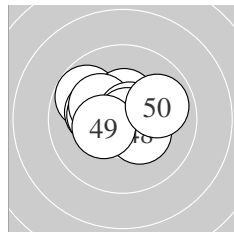

Serie 5:	9.8 ↖	10.2 *	10.3 *	10.4 *	10.2 *
	10.7 *	10.8 *	10.3 *	10.4 *	9.9 →
beste Teiler	33.1 (47.)	62.2 (46.)	132.4 (44.)		
Trefferlage	0.44 mm links, 0.43 mm hoch				
Streuwert	1.26, horizontal: 1.59, vertikal: 0.79				

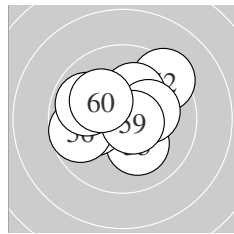

Serie 6:	10.4 *	9.4 ↗	10.1 ↘	10.2 *	10.1 ←
	9.7 ←	9.9 ↖	10.2 *	10.7 *	10.2 *
beste Teiler	73.6 (59.)	149.2 (51.)	189.8 (58.)		
Trefferlage	0.07 mm links, 0.52 mm hoch				
Streuwert	1.71, horizontal: 2.02, vertikal: 1.32				

Meyton Elektronik

**ISSF AR Men – Wertung – Junioren**

StandNr: 114

**Wyrsh, Fabio** #70804628

**StartNr: 10**

22. Januar 2017 9:52

Switzerland

---

QF – Schütze hat sich fürs Finale qualifiziert

---

Unterschrift des Schuetzen

Meyton Elektronik

Ergebnis:	<b>609.8</b>	(586)
Serien:	100.7	101.5 101.3 102.2 102.0 102.1
Zaehler:	46	14 0 0 0 0 0 0 0 0
Innenzehner:	32	
weiteste:	445 (3), 431 (24), 386 (8)	
beste Teiler	19.8 (6.)	38.3 (55.) 41.0 (47.)
Trefferlage	0.29 mm rechts, 0.24 mm hoch	
Streuwert	1.54, horizontal: 1.42, vertikal: 1.65	

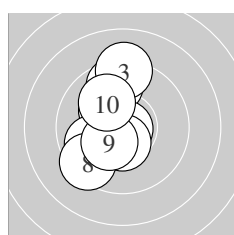
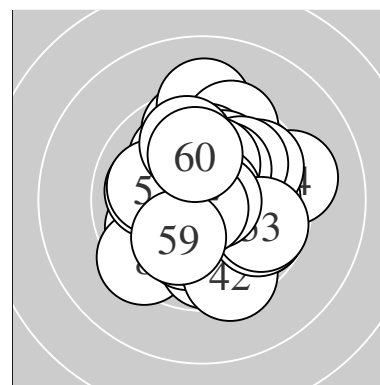

Serie 1:	9.6 ↑	10.2 *	9.2 ↑	10.7 *	9.9 ↙
	10.9 *	10.5 *	9.4 ↗	10.3 *	10.0 ↘
beste Teiler	19.8 (6.)	51.6 (4.)	121.0 (7.)		
Trefferlage	0.94 mm links, 0.43 mm hoch				
Streuwert	1.75, horizontal: 0.99, vertikal: 2.26				

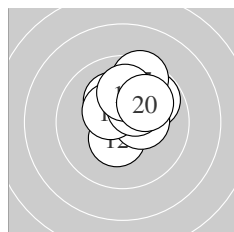

Serie 2:	10.5 *	10.4 *	9.8 ↗	10.4 *	10.2 *
	10.4 *	9.5 ↑	10.3 *	10.0 ↑	10.0 ↗
beste Teiler	122.3 (11.)	128.8 (16.)	134.7 (12.)		
Trefferlage	0.65 mm rechts, 1.25 mm hoch				
Streuwert	1.19, horizontal: 1.13, vertikal: 1.25				

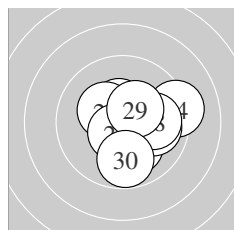

Serie 3:	10.5 *	10.3 *	10.4 *	9.2 →	10.1 ↓
	10.6 *	10.0 →	10.0 →	10.4 *	9.8 ↓
beste Teiler	95.7 (26.)	122.4 (21.)	136.7 (23.)		
Trefferlage	1.01 mm rechts, 0.08 mm tief				
Streuwert	1.53, horizontal: 1.64, vertikal: 1.41				

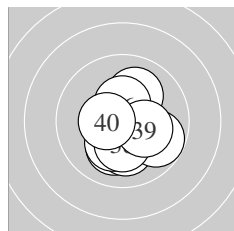

Serie 4:	10.1 ↓	10.1 ↑	10.1 ↓	10.2 *	10.6 *
	10.4 *	9.8 ↘	10.2 *	10.2 *	10.5 *
beste Teiler	87.7 (35.)	125.0 (40.)	132.0 (36.)		
Trefferlage	0.34 mm rechts, 0.68 mm tief				
Streuwert	1.31, horizontal: 1.18, vertikal: 1.42				

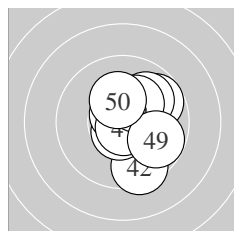

Serie 5:	9.7 ↗	9.5 ↓	10.6 *	10.0 ↗	10.7 *
	10.5 *	10.8 *	10.2 *	9.8 ↘	10.2 *
beste Teiler	41.0 (47.)	71.8 (45.)	80.0 (43.)		
Trefferlage	0.94 mm rechts, 0.09 mm hoch				
Streuwert	1.45, horizontal: 1.16, vertikal: 1.68				

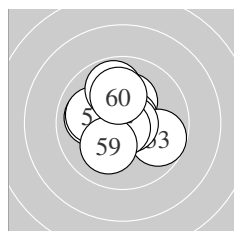

Serie 6:	10.2 *	10.7 *	9.7 ↘	10.7 *	10.8 *
	10.0 ←	10.0 ←	9.8 ↑	10.1 ↗	10.1 ↑
beste Teiler	38.3 (55.)	57.3 (54.)	63.1 (52.)		
Trefferlage	0.24 mm links, 0.45 mm hoch				
Streuwert	1.46, horizontal: 1.52, vertikal: 1.41				

**ISSF AR Men** – Wertung – **Junioren**

StandNr: 115

**Diem, Patrick** #81

**StartNr: 11**

22. Januar 2017 10:04

AUT

---

\_\_\_\_\_  
Unterschrift des Schuetzen

Meyton Elektronik

Ergebnis:	<b>619.7</b>	(594) <sup>QF</sup>							
Serien:	103.4	102.9	103.3	102.4	102.9	104.8			
Zaehler:	54	6	0	0	0	0	0	0	0
Innenzehner:	44								
weiteste:	381 (33), 357 (20), 331 (39)								
beste Teiler	9.8 (52.)	18.6 (32.)	42.0 (16.)						
Trefferlage	0.03 mm rechts, 0.09 mm hoch								
Streuwert	1.26, horizontal: 1.42, vertikal: 1.07								

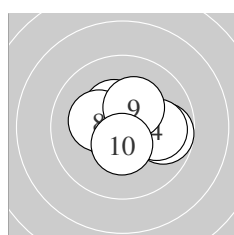
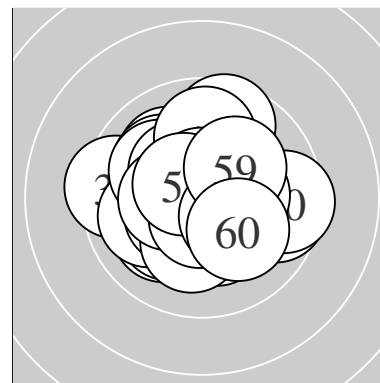

Serie 1:	10.1 →	9.8 →	10.6 *	10.0 →	10.8 *
	10.4 *	10.7 *	10.2 *	10.3 *	10.5 *
beste Teiler	50.4 (5.)	69.3 (7.)	81.1 (3.)		
Trefferlage	0.52 mm rechts, 0.15 mm hoch				
Streuwert	1.25, horizontal: 1.56, vertikal: 0.82				

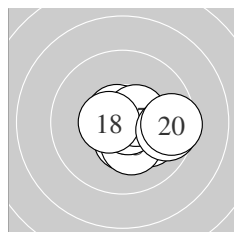

Serie 2:	10.1 ↘	10.4 *	10.7 *	10.4 *	10.3 *
	10.8 *	10.5 *	10.6 *	9.6 →	9.5 →
beste Teiler	42.0 (16.)	65.2 (13.)	99.0 (18.)		
Trefferlage	1.08 mm rechts, 0.38 mm tief				
Streuwert	1.16, horizontal: 1.47, vertikal: 0.72				

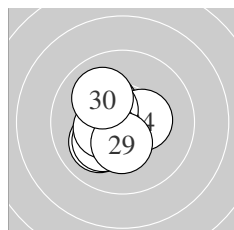

Serie 3:	10.3 *	10.7 *	10.5 *	10.4 *	10.1 ↙
	10.4 *	10.2 *	10.4 *	10.3 *	10.0 ↘
beste Teiler	60.2 (22.)	124.4 (23.)	140.8 (24.)		
Trefferlage	0.83 mm links, 0.15 mm tief				
Streuwert	1.05, horizontal: 0.92, vertikal: 1.17				

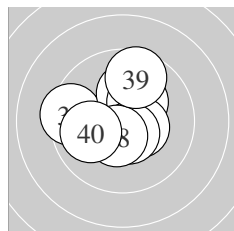

Serie 4:	10.7 *	10.9 *	9.4 ←	10.1 ↑	10.2 *
	10.4 *	10.6 *	10.5 *	9.6 ↑	10.0 ←
beste Teiler	18.6 (32.)	57.7 (31.)	100.1 (37.)		
Trefferlage	0.31 mm links, 0.40 mm hoch				
Streuwert	1.50, horizontal: 1.60, vertikal: 1.39				

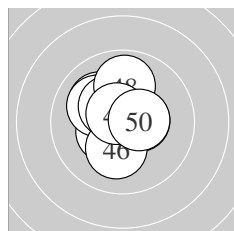

Serie 5:	10.1 ↘	10.5 *	10.4 *	10.2 *	10.1 ↘
	10.2 *	10.3 *	9.9 ↑	10.7 *	10.5 *
beste Teiler	74.6 (49.)	120.3 (42.)	120.9 (50.)		
Trefferlage	0.52 mm links, 0.59 mm hoch				
Streuwert	1.18, horizontal: 1.08, vertikal: 1.26				

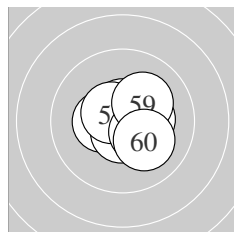

Serie 6:	10.6 *	10.9 *	10.7 *	10.3 *	10.4 *
	10.6 *	10.6 *	10.4 *	10.2 *	10.1 ↘
beste Teiler	9.8 (52.)	65.0 (53.)	82.6 (56.)		
Trefferlage	0.27 mm rechts, 0.02 mm tief				
Streuwert	0.97, horizontal: 1.11, vertikal: 0.82				

Meyton Elektronik

**ISSF AR Men – Wertung – Junioren**

StandNr: 117

**Will, Shaner** #70804641

**StartNr: 13**

22. Januar 2017 10:11

USA

---

QF – Schütze hat sich fürs Finale qualifiziert

---

Unterschrift des Schuetzen

Meyton Elektronik