

Ergebnis:	617.4	(588)							
Serien:	103.4	103.3	102.5	103.1	102.4	102.7			
Zaehler:	48	12	0	0	0	0	0	0	0
Innenzehner:	41								
weiteste:	385 (60), 346 (42), 323 (40)								
beste Teiler	48.5 (34.) 53.2 (17.) 54.5 (7.)								
Trefferlage	0.36 mm links, 0.25 mm tief								
Streuwert	1.28, horizontal: 1.34, vertikal: 1.22								

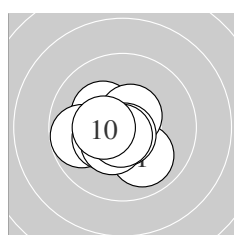

Serie 1:

10.0 ↘	10.2 *	10.3 *	10.6 *	9.8 ←
10.3 *	10.7 *	10.4 *	10.7 *	10.4 *
beste Teiler	54.5 (7.) 61.3 (9.) 98.4 (4.)			
Trefferlage	0.75 mm links, 0.36 mm tief			
Streuwert	1.10, horizontal: 1.26, vertikal: 0.91			

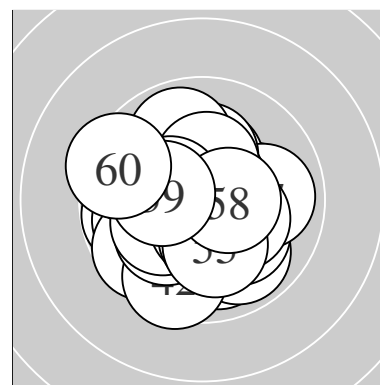
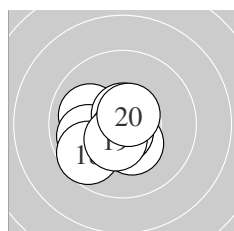

Serie 2:

10.2 *	10.3 *	10.0 ↖	10.7 *	9.9 ←
10.7 *	10.7 *	9.7 ↗	10.5 *	10.6 *
beste Teiler	53.2 (17.) 55.5 (14.) 68.0 (16.)			
Trefferlage	0.84 mm links, 0.53 mm tief			
Streuwert	1.10, horizontal: 1.25, vertikal: 0.93			

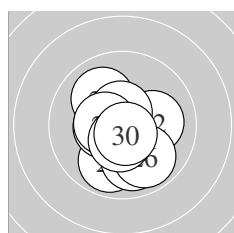

Serie 3:

9.9 ↙	10.1 →	10.0 ↘	10.6 *	9.9 ↓
9.9 ↘	10.4 *	10.5 *	10.5 *	10.7 *
beste Teiler	65.4 (30.) 90.0 (24.) 109.8 (29.)			
Trefferlage	0.06 mm links, 0.59 mm tief			
Streuwert	1.35, horizontal: 1.22, vertikal: 1.47			

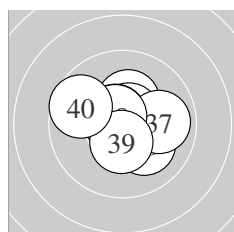

Serie 4:

10.3 *	10.1 →	10.6 *	10.8 *	10.6 *
10.1 ↘	9.9 →	10.6 *	10.4 *	9.7 ↖
beste Teiler	48.5 (34.) 77.1 (38.) 78.6 (35.)			
Trefferlage	0.25 mm rechts, 0.21 mm hoch			
Streuwert	1.32, horizontal: 1.60, vertikal: 0.97			

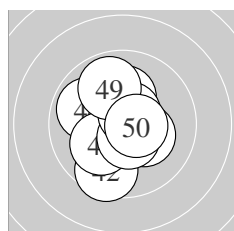

Serie 5:

10.7 *	9.6 ↙	10.3 *	9.9 ↖	10.1 ↙
10.2 *	10.5 *	10.6 *	9.9 ↗	10.6 *
beste Teiler	57.4 (41.) 89.8 (48.) 97.8 (50.)			
Trefferlage	0.22 mm links, 0.02 mm hoch			
Streuwert	1.49, horizontal: 1.24, vertikal: 1.71			

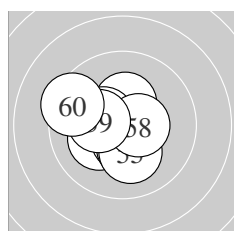

Serie 6:

10.6 *	10.2 *	10.5 *	10.3 *	10.2 *
10.3 *	10.4 *	10.5 *	10.3 *	9.4 ↖
beste Teiler	87.6 (51.) 104.0 (53.) 112.0 (58.)			
Trefferlage	0.56 mm links, 0.25 mm tief			
Streuwert	1.33, horizontal: 1.45, vertikal: 1.19			

ISSF AR Men – Wertung – **Männer**

StandNr: 104

Wind, Jelle #70804684

StartNr: 38

24. Januar 2017 11:55

Netherlands

Unterschrift des Schuetzen

Meyton Elektronik

Ergebnis:	620.3	(590)					
Serien:	104.4	103.0	103.0	102.4	104.6	102.9	
Zaehler:	50	10	0	0	0	0	0
Innenzehner:	45						
weiteste:	445 (58), 388 (52), 368 (33)						
beste Teiler	7.0 (55.) 9.2 (8.) 20.8 (34.)						
Trefferlage	0.36 mm links, 0.09 mm tief						
Streuwert	1.26, horizontal: 1.30, vertikal: 1.22						

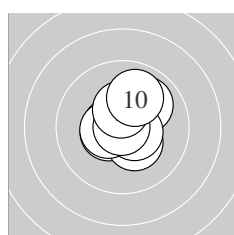
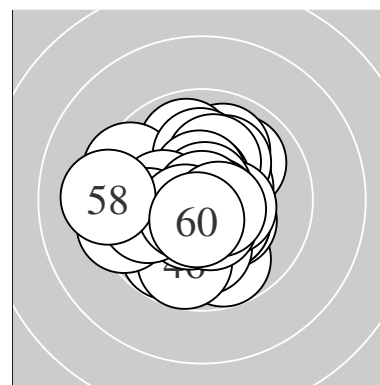

Serie 1:					
	10.0 ↗	10.5 *	10.7 *	10.3 *	10.6 *
	10.5 *	10.5 *	10.9 *	10.4 *	10.0 ↑
beste Teiler	9.2 (8.) 55.9 (3.) 90.3 (5.)				
Trefferlage	0.17 mm rechts, 0.31 mm hoch				
Streuwert	1.06, horizontal: 1.00, vertikal: 1.12				

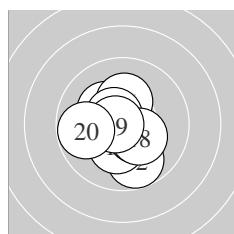

Serie 2:					
	10.6 *	9.8 ↓	10.3 *	10.4 *	10.3 *
	10.2 *	10.6 *	10.3 *	10.7 *	9.8 ←
beste Teiler	57.0 (19.) 91.0 (11.) 93.3 (17.)				
Trefferlage	0.29 mm links, 0.25 mm tief				
Streuwert	1.32, horizontal: 1.26, vertikal: 1.39				

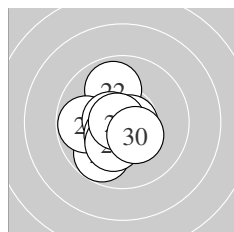

Serie 3:					
	10.3 *	9.9 ↑	10.7 *	9.8 ✓	9.8 ←
	10.6 *	10.5 *	10.2 *	10.8 *	10.4 *
beste Teiler	45.1 (29.) 55.9 (23.) 96.1 (26.)				
Trefferlage	0.75 mm links, 0.24 mm tief				
Streuwert	1.26, horizontal: 1.06, vertikal: 1.43				

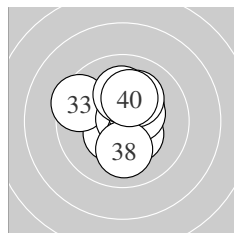

Serie 4:					
	10.3 *	10.4 *	9.5 ↖	10.9 *	10.4 *
	10.4 *	10.1 ↗	10.1 ↓	10.1 ↑	10.2 *
beste Teiler	20.8 (34.) 127.4 (36.) 129.5 (32.)				
Trefferlage	0.05 mm rechts, 0.48 mm hoch				
Streuwert	1.42, horizontal: 1.37, vertikal: 1.46				

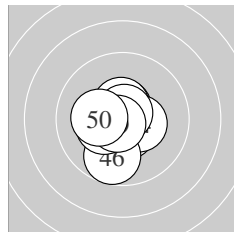

Serie 5:					
	10.6 *	10.5 *	10.6 *	10.4 *	10.8 *
	9.7 ↓	10.8 *	10.3 *	10.7 *	10.2 *
beste Teiler	37.2 (45.) 50.6 (47.) 55.9 (49.)				
Trefferlage	0.32 mm links, 0.25 mm tief				
Streuwert	1.01, horizontal: 0.89, vertikal: 1.12				

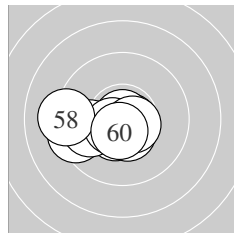

Serie 6:					
	10.7 *	9.4 ←	10.5 *	10.5 *	10.9 *
	9.9 ←	10.6 *	9.2 ←	10.6 *	10.6 *
beste Teiler	7.0 (55.) 57.7 (51.) 89.5 (59.)				
Trefferlage	1.06 mm links, 0.60 mm tief				
Streuwert	1.35, horizontal: 1.85, vertikal: 0.48				

Meyton Elektronik

ISSF AR Men – Wertung – Männer

StandNr: 105

Alammari, Misfer #70804686

StartNr: 39

24. Januar 2017 11:59

Kingdom of Saudi Arabia

Unterschrift des Schuetzen

Meyton Elektronik

Ergebnis:	620.6	(589)					
Serien:	103.6	103.6	102.5	104.3	104.3	102.3	
Zaehler:	49	11	0	0	0	0	0
Innenzehner:	45						
weiteste:	373 (52), 361 (26), 307 (12)						
beste Teiler	34.7 (28.) 35.8 (37.) 37.0 (49.)						
Trefferlage	0.09 mm rechts, 0.10 mm hoch						
Streuwert	1.24, horizontal: 1.22, vertikal: 1.26						

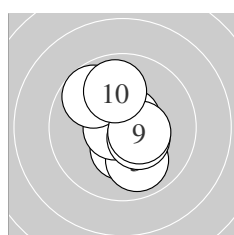
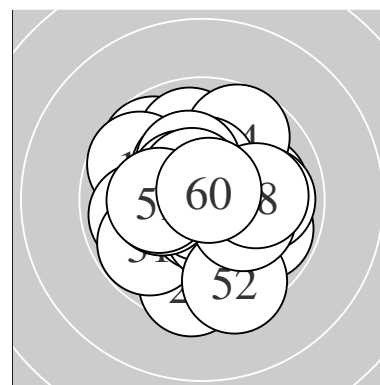

Serie 1:	10.8 *	10.7 *	10.3 *	10.7 *	9.9 ↘
	10.7 *	10.4 *	9.7 ↖	10.5 *	9.9 ↑
beste Teiler	48.0 (1.) 57.1 (2.) 57.7 (6.)				
Trefferlage	0.04 mm links, 0.05 mm hoch				
Streuwert	1.28, horizontal: 1.02, vertikal: 1.50				

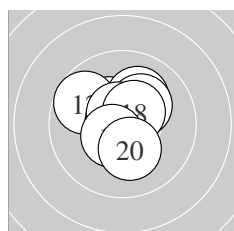

Serie 2:	10.4 *	9.7 ↖	10.1 ↗	10.2 *	10.8 *
	10.6 *	10.6 *	10.5 *	10.5 *	10.2 *
beste Teiler	46.6 (15.) 83.2 (16.) 97.0 (17.)				
Trefferlage	0.20 mm links, 0.42 mm hoch				
Streuwert	1.19, horizontal: 1.18, vertikal: 1.20				

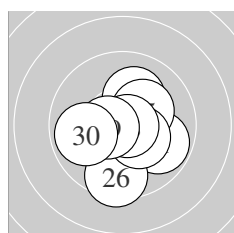

Serie 3:	9.8 ↘	10.7 *	10.1 ↗	10.5 *	10.3 *
	9.5 ↓	10.4 *	10.8 *	10.5 *	9.9 ←
beste Teiler	34.7 (28.) 65.0 (22.) 107.3 (29.)				
Trefferlage	0.21 mm rechts, 0.51 mm tief				
Streuwert	1.45, horizontal: 1.44, vertikal: 1.46				

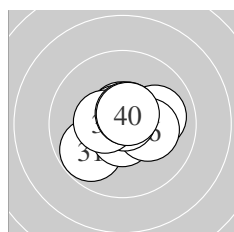

Serie 4:	9.8 ↙	10.6 *	10.6 *	10.7 *	10.0 →
	10.2 *	10.8 *	10.4 *	10.6 *	10.6 *
beste Teiler	35.8 (37.) 65.2 (34.) 76.7 (32.)				
Trefferlage	0.08 mm rechts, 0.07 mm hoch				
Streuwert	1.10, horizontal: 1.31, vertikal: 0.85				

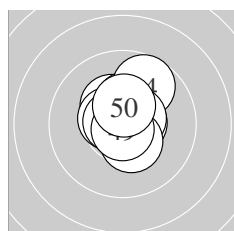

Serie 5:	10.3 *	10.5 *	10.3 *	9.7 ↗	10.6 *
	10.7 *	10.6 *	10.4 *	10.8 *	10.4 *
beste Teiler	37.0 (49.) 61.6 (46.) 93.4 (45.)				
Trefferlage	0.19 mm rechts, 0.62 mm hoch				
Streuwert	0.97, horizontal: 0.81, vertikal: 1.10				

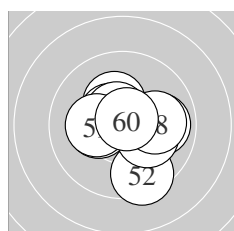

Serie 6:	9.9 →	9.5 ↘	10.3 *	10.2 *	10.5 *
	10.6 *	10.3 *	10.0 →	10.2 *	10.8 *
beste Teiler	50.2 (60.) 93.4 (56.) 112.8 (55.)				
Trefferlage	0.29 mm rechts, 0.06 mm tief				
Streuwert	1.50, horizontal: 1.63, vertikal: 1.36				

Meyton Elektronik

ISSF AR Men – Wertung – Männer

StandNr: 106

Eberlberger, Florian #251

StartNr: 40

24. Januar 2017 12:02

AUT

Unterschrift des Schuetzen

Meyton Elektronik

Ergebnis:	625.3	(596) ^{QF}							
Serien:	103.4	104.9	105.5	101.9	106.2	103.4			
Zaehler:	56	4	0	0	0	0	0	0	0
Innenzehner:	49								
weiteste:	421 (39), 287 (58), 260 (9)								
beste Teiler	30.4 (25.)	32.3 (49.)	46.7 (46.)						
Trefferlage	0.09 mm rechts, 0.24 mm hoch								
Streuwert	1.07, horizontal: 1.08, vertikal: 1.05								

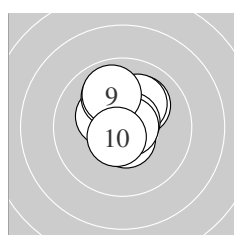
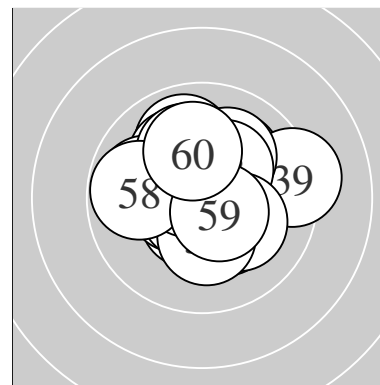

Serie 1:	10.3 *	10.1 ↗	10.1 ↗	10.3 *	10.6 *
	10.0 ↘	10.7 *	10.8 *	9.9 ↗	10.6 *
beste Teiler	49.2 (8.) 71.8 (7.) 85.7 (10.)				
Trefferlage	0.03 mm rechts, 0.96 mm hoch				
Streuwert	1.06, horizontal: 0.90, vertikal: 1.20				

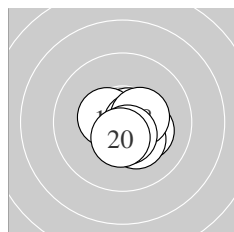

Serie 2:	10.7 *	10.5 *	10.7 *	10.2 *	10.5 *
	10.6 *	10.3 *	10.4 *	10.5 *	10.5 *
beste Teiler	53.9 (13.) 73.0 (11.) 80.2 (16.)				
Trefferlage	0.53 mm rechts, 0.40 mm tief				
Streuwert	0.75, horizontal: 0.83, vertikal: 0.65				

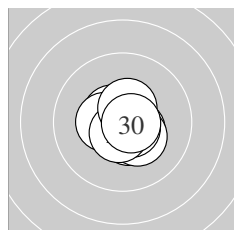

Serie 3:	10.5 *	10.5 *	10.6 *	10.4 *	10.8 *
	10.3 *	10.6 *	10.6 *	10.5 *	10.7 *
beste Teiler	30.4 (25.) 64.6 (30.) 76.0 (27.)				
Trefferlage	0.20 mm rechts, 0.26 mm tief				
Streuwert	0.74, horizontal: 0.78, vertikal: 0.69				

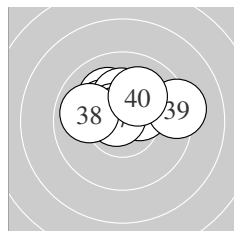

Serie 4:	10.1 ↘	10.3 *	10.3 *	10.4 *	10.2 *
	10.6 *	10.7 *	9.9 ←	9.3 →	10.1 ↗
beste Teiler	56.6 (37.) 91.3 (36.) 150.5 (34.)				
Trefferlage	0.00 mm , 1.12 mm hoch				
Streuwert	1.36, horizontal: 1.84, vertikal: 0.59				

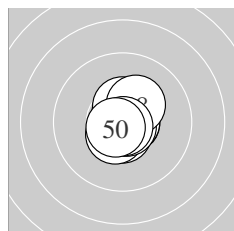

Serie 5:	10.6 *	10.6 *	10.7 *	10.7 *	10.5 *
	10.8 *	10.5 *	10.3 *	10.8 *	10.7 *
beste Teiler	32.3 (49.) 46.7 (46.) 57.0 (44.)				
Trefferlage	0.12 mm rechts, 0.03 mm hoch				
Streuwert	0.67, horizontal: 0.49, vertikal: 0.80				

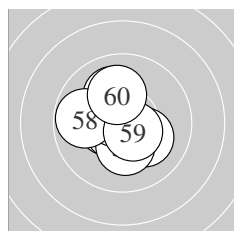

Serie 6:	10.5 *	10.7 *	10.6 *	10.2 *	10.3 *
	10.6 *	10.1 ↘	9.8 ←	10.5 *	10.1 ↗
beste Teiler	60.8 (52.) 76.4 (56.) 79.9 (53.)				
Trefferlage	0.35 mm links, 0.01 mm hoch				
Streuwert	1.23, horizontal: 1.20, vertikal: 1.26				

Meyton Elektronik

ISSF AR Men – Wertung – Männer

StandNr: 107

Ivan, Roe #70804682

StartNr: 41

24. Januar 2017 12:03

USA

QF – Schütze hat sich fürs Finale qualifiziert

Unterschrift des Schuetzen

Meyton Elektronik

Ergebnis: **607.9** (579)

Serien: 100.5 101.3 102.5 101.2 101.3 101.1

Zaehler: 40 19 1 0 0 0 0 0 0 0

Innenzehner: 34

weiteste: 525 (53), 499 (41), 457 (3)

beste Teiler 56.0 (51.) 57.0 (6.) 67.3 (46.)

Trefferlage 0.07 mm rechts, 0.34 mm tief

Streuwert 1.66, horizontal: 1.67, vertikal: 1.65

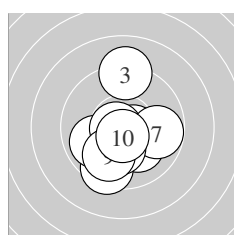
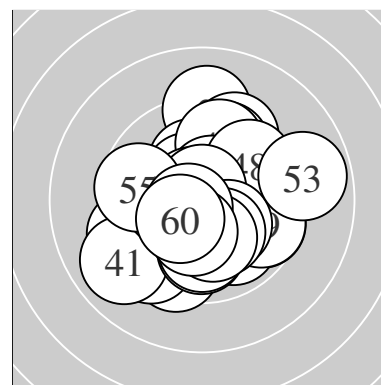

Serie 1:

10.1 ↘	9.5 ↓	9.1 ↑	10.6 *	9.9 ↙
10.7 *	9.8 →	10.2 *	9.9 ↓	10.7 *

beste Teiler 57.0 (6.) 75.0 (10.) 97.8 (4.)

Trefferlage 0.02 mm links, 0.74 mm tief

Streuwert 1.83, horizontal: 1.48, vertikal: 2.13

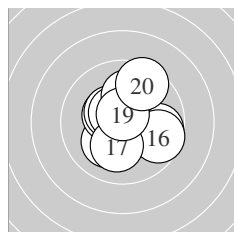

Serie 2:

10.1 ↙	10.4 *	9.8 →	10.4 *	10.5 *
9.7 →	10.1 ↓	10.1 ↑	10.7 *	9.5 ↗

beste Teiler 68.0 (19.) 103.0 (15.) 132.7 (14.)

Trefferlage 0.34 mm rechts, 0.29 mm hoch

Streuwert 1.65, horizontal: 1.64, vertikal: 1.67

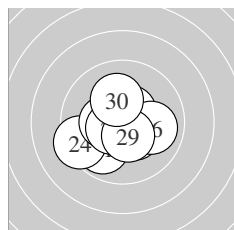

Serie 3:

9.9 ↙	10.7 *	10.5 *	9.4 ↙	10.4 *
10.0 →	10.4 *	10.5 *	10.5 *	10.2 *

beste Teiler 73.5 (22.) 101.5 (28.) 105.6 (23.)

Trefferlage 0.32 mm links, 0.35 mm tief

Streuwert 1.47, horizontal: 1.68, vertikal: 1.23

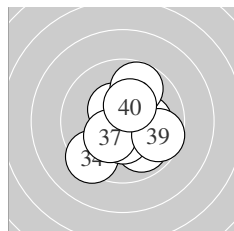

Serie 4:

10.2 *	10.5 *	10.6 *	9.4 ↙	9.9 ↘
10.4 *	10.3 *	9.8 ↑	9.7 →	10.4 *

beste Teiler 84.5 (33.) 122.4 (32.) 139.1 (36.)

Trefferlage 0.48 mm rechts, 0.42 mm tief

Streuwert 1.68, horizontal: 1.63, vertikal: 1.73

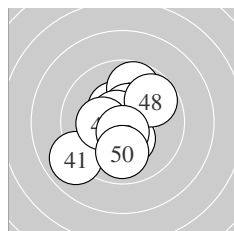

Serie 5:

9.0 ↙	10.4 *	9.8 ↑	10.4 *	10.5 *
10.7 *	10.3 *	9.7 ↗	10.6 *	9.9 ↓

beste Teiler 67.3 (46.) 85.0 (49.) 113.1 (45.)

Trefferlage 0.26 mm links, 0.06 mm tief

Streuwert 1.80, horizontal: 1.69, vertikal: 1.90

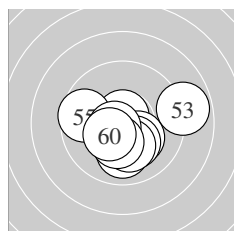

Serie 6:

10.7 *	10.2 *	8.9 →	10.0 ↓	9.6 ←
10.2 *	10.2 *	10.6 *	10.3 *	10.4 *

beste Teiler 56.0 (51.) 79.7 (58.) 146.7 (60.)

Trefferlage 0.24 mm rechts, 0.77 mm tief

Streuwert 1.74, horizontal: 2.13, vertikal: 1.23

ISSF AR Men – Wertung – Männer

StandNr: 108

Al, Juhaydili Abdulrahman Saad #70804678

StartNr: 42

24. Januar 2017 11:45

Kingdom of Saudi Arabia

Unterschrift des Schuetzen

Meyton Elektronik

Ergebnis: **616.0** (590)

Serien: 102.2 102.2 102.8 102.1 103.1 103.6

Zaehler: 50 10 0 0 0 0 0 0 0 0

Innenzehner: 37

weiteste: 341 (17), 338 (47), 319 (24)

beste Teiler 11.1 (57.) 39.8 (15.) 47.3 (53.)

Trefferlage 0.24 mm links, 0.21 mm tief

Streuwert 1.34, horizontal: 1.45, vertikal: 1.23

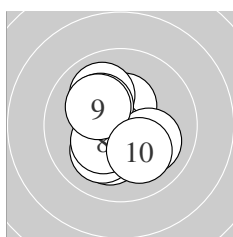
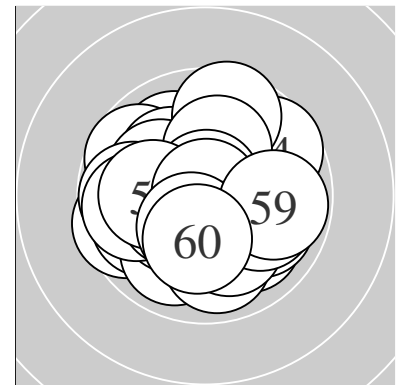

Serie 1:

10.4 *	10.2 *	10.6 *	10.0 ↖	10.2 *
10.1 ↙	10.1 ↘	10.3 *	10.2 *	10.1 ↘

beste Teiler 79.9 (3.) 133.9 (1.) 159.9 (8.)

Trefferlage 0.44 mm links, 0.20 mm tief

Streuwert 1.37, horizontal: 1.20, vertikal: 1.52

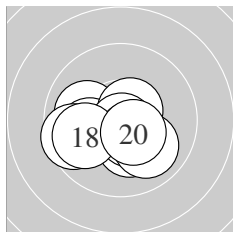

Serie 2:

10.0 ↖	10.1 ←	10.6 *	10.2 *	10.8 *
10.5 *	9.6 ←	9.9 ←	10.0 ↘	10.5 *

beste Teiler 39.8 (15.) 91.9 (13.) 120.1 (16.)

Trefferlage 0.54 mm links, 0.74 mm tief

Streuwert 1.37, horizontal: 1.77, vertikal: 0.79

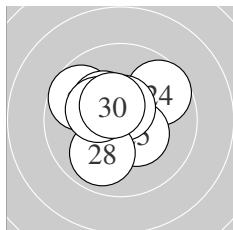

Serie 3:

10.8 *	10.6 *	9.7 ↖	9.7 ↗	10.4 *
10.6 *	10.3 *	9.9 ↙	10.3 *	10.5 *

beste Teiler 48.0 (21.) 84.1 (26.) 85.0 (22.)

Trefferlage 0.33 mm links, 0.46 mm hoch

Streuwert 1.37, horizontal: 1.50, vertikal: 1.23

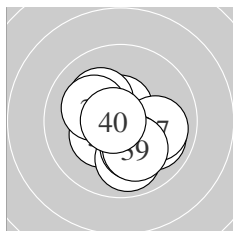

Serie 4:

10.6 *	10.3 *	10.2 *	10.1 ↖	10.0 ↘
9.9 ↓	10.0 →	10.2 *	10.1 ↘	10.7 *

beste Teiler 51.1 (40.) 90.0 (31.) 158.2 (32.)

Trefferlage 0.19 mm rechts, 0.55 mm tief

Streuwert 1.40, horizontal: 1.46, vertikal: 1.34

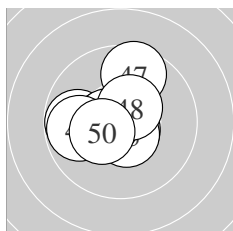

Serie 5:

10.6 *	9.8 ←	10.5 *	10.7 *	10.6 *
10.6 *	9.6 ↑	10.5 *	9.8 ←	10.4 *

beste Teiler 60.2 (44.) 76.6 (41.) 88.0 (46.)

Trefferlage 0.61 mm links, 0.12 mm hoch

Streuwert 1.32, horizontal: 1.42, vertikal: 1.22

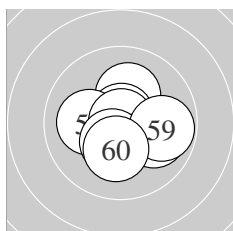

Serie 6:

10.2 *	10.0 →	10.8 *	10.5 *	10.7 *
10.1 ←	10.9 *	10.4 *	9.8 →	10.2 *

beste Teiler 11.1 (57.) 47.3 (53.) 70.1 (55.)

Trefferlage 0.27 mm rechts, 0.34 mm tief

Streuwert 1.23, horizontal: 1.40, vertikal: 1.04

Meyton Elektronik

ISSF AR Men – Wertung – **Männer**

StandNr: 109

Bryant, Wallizer #70804680

StartNr: 43

24. Januar 2017 12:04

USA

Unterschrift des Schuetzen

Meyton Elektronik

Ergebnis:	624.9	(597) ^{QF}							
Serien:	104.1	104.8	103.7	105.6	104.0	102.7			
Zaehler:	57	3	0	0	0	0	0	0	0
Innenzehner:	52								
weiteste:	334 (53), 305 (55), 254 (4)								
beste Teiler	2.2 (36.) 18.4 (25.) 18.4 (41.)								
Trefferlage	0.14 mm links, 0.04 mm hoch								
Streuwert	1.08, horizontal: 1.04, vertikal: 1.12								

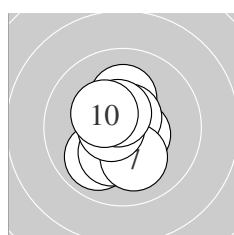
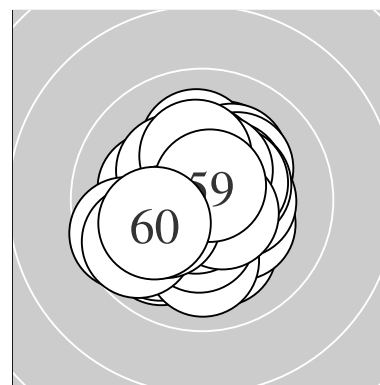

Serie 1:	10.5 *	10.2 *	10.9 *	9.9 ✓	10.7 *
	10.2 *	10.1 ↓	10.6 *	10.6 *	10.4 *
beste Teiler	19.1 (3.) 74.3 (5.) 76.1 (8.)				
Trefferlage	0.27 mm links, 0.17 mm tief				
Streuwert	1.12, horizontal: 0.83, vertikal: 1.35				

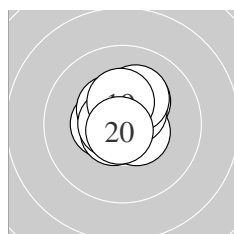

Serie 2:	10.2 *	10.5 *	10.5 *	10.5 *	10.4 *
	10.6 *	10.7 *	10.2 *	10.4 *	10.8 *
beste Teiler	46.9 (20.) 74.0 (17.) 77.2 (16.)				
Trefferlage	0.02 mm links, 0.51 mm hoch				
Streuwert	0.86, horizontal: 0.83, vertikal: 0.89				

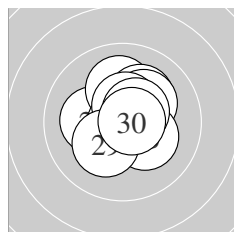

Serie 3:	10.2 *	10.1 ↑	10.2 *	10.2 *	10.9 *
	10.2 *	10.5 *	10.5 *	10.2 *	10.7 *
beste Teiler	18.4 (25.) 61.2 (30.) 110.6 (27.)				
Trefferlage	0.23 mm rechts, 0.45 mm hoch				
Streuwert	1.12, horizontal: 1.12, vertikal: 1.13				

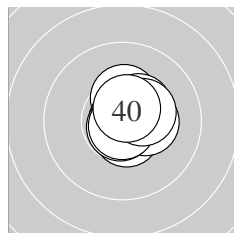

Serie 4:	10.5 *	10.3 *	10.6 *	10.3 *	10.4 *
	10.9 *	10.8 *	10.8 *	10.4 *	10.6 *
beste Teiler	2.2 (36.) 32.1 (38.) 44.0 (37.)				
Trefferlage	0.48 mm rechts, 0.32 mm hoch				
Streuwert	0.68, horizontal: 0.60, vertikal: 0.75				

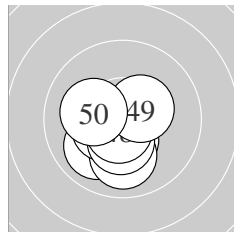

Serie 5:	10.9 *	10.4 *	10.0 ✓	10.0 ↓	10.6 *
	10.4 *	10.4 *	10.7 *	10.4 *	10.2 *
beste Teiler	18.4 (41.) 74.3 (48.) 96.6 (45.)				
Trefferlage	0.40 mm links, 0.81 mm tief				
Streuwert	0.96, horizontal: 0.94, vertikal: 0.98				

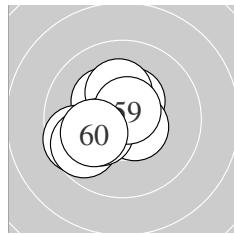

Serie 6:	10.8 *	10.3 *	9.6 ✓	10.4 *	9.7 ✓
	10.6 *	10.2 *	10.3 *	10.7 *	10.1 ✓
beste Teiler	42.3 (51.) 64.8 (59.) 97.6 (56.)				
Trefferlage	0.89 mm links, 0.02 mm tief				
Streuwert	1.28, horizontal: 1.35, vertikal: 1.20				

Meyton Elektronik

ISSF AR Men – Wertung – Männer

StandNr: 110

Strepfl, Martin #260

StartNr: 44

24. Januar 2017 12:06

AUT

QF – Schütze hat sich fürs Finale qualifiziert

Unterschrift des Schuetzen

Meyton Elektronik

Ergebnis:	606.0	(580)
Serien:	100.2 99.0 102.0 102.5 99.8 102.5	
Zähler:	41 18 1 0 0 0 0 0 0 0	
Innenzehner:	29	
weiteste:	595 (42), 493 (13), 469 (43)	
beste Teiler	39.0 (40.) 48.0 (37.) 58.5 (5.)	
Trefferlage	0.27 mm rechts, 0.05 mm hoch	
Streuwert	1.73, horizontal: 1.75, vertikal: 1.70	

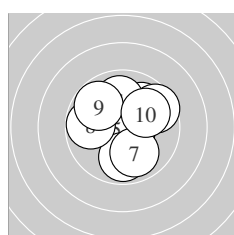
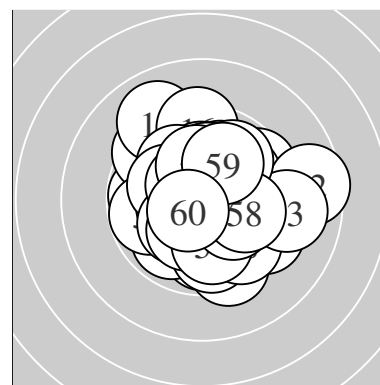

Serie 1:	10.6 *	9.9 ↗	9.6 ↗	10.0 ↑	10.7 *
	9.9 ↓	9.9 ↘	9.8 ←	9.8 ↖	10.0 ↗
beste Teiler	58.5 (5.)	81.9 (1.)	248.6 (4.)		
Trefferlage	0.27 mm rechts, 0.41 mm hoch				
Streuwert	1.83, horizontal: 1.86, vertikal: 1.80				

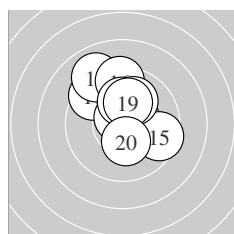

Serie 2:	9.4 ↖	10.7 *	9.0 ↖	10.5 *	9.5 →
	9.4 ↑	10.1 ↑	10.0 ↑	10.1 ↑	10.3 *
beste Teiler	71.8 (12.)	125.7 (14.)	160.0 (20.)		
Trefferlage	0.04 mm rechts, 1.54 mm hoch				
Streuwert	1.85, horizontal: 1.74, vertikal: 1.94				

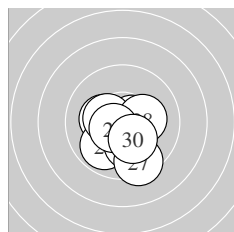

Serie 3:	10.2 *	9.9 ↙	10.4 *	10.6 *	10.4 *
	10.1 ↓	9.4 ↘	10.2 *	10.6 *	10.2 *
beste Teiler	87.8 (24.)	99.0 (29.)	134.9 (23.)		
Trefferlage	0.12 mm rechts, 0.89 mm tief				
Streuwert	1.37, horizontal: 1.39, vertikal: 1.36				

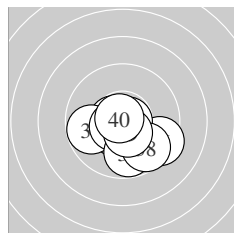

Serie 4:	10.6 *	10.5 *	9.8 ←	10.6 *	9.8 ↓
	9.4 ↘	10.8 *	9.7 ↘	10.5 *	10.8 *
beste Teiler	39.0 (40.)	48.0 (37.)	84.3 (31.)		
Trefferlage	0.15 mm rechts, 1.01 mm tief				
Streuwert	1.43, horizontal: 1.72, vertikal: 1.06				

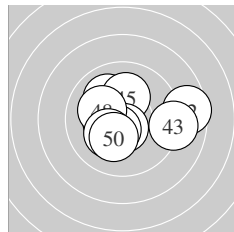

Serie 5:	10.0 ↖	8.6 →	9.1 →	10.4 *	10.1 ↑
	10.6 *	10.5 *	10.1 ↖	10.2 *	10.2 *
beste Teiler	82.8 (46.)	111.5 (47.)	143.1 (44.)		
Trefferlage	0.36 mm rechts, 0.02 mm tief				
Streuwert	2.12, horizontal: 2.69, vertikal: 1.31				

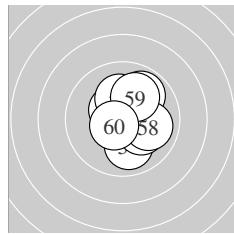

Serie 6:	10.0 ↓	10.5 *	10.5 *	10.6 *	10.2 *
	10.2 *	9.9 ↗	10.0 →	10.0 ↑	10.6 *
beste Teiler	85.4 (54.)	97.8 (60.)	105.3 (53.)		
Trefferlage	0.69 mm rechts, 0.27 mm hoch				
Streuwert	1.31, horizontal: 1.09, vertikal: 1.50				

ISSF AR Men – Wertung – **Männer**

StandNr: 111

Insam, Fabian #70804082

StartNr: 45

24. Januar 2017 11:57

T – SG Fügenberg

Unterschrift des Schuetzen

Meyton Elektronik

Ergebnis:	625.2	(596) ^{QF}							
Serien:	103.9	105.0	104.6	105.0	102.5	104.2			
Zaehler:	56	4	0	0	0	0	0	0	0
Innenzehner:	50								
weiteste:	304 (48), 295 (17), 277 (60)								
beste Teiler	22.0 (14.)	36.3 (7.)	52.5 (13.)						
Trefferlage	0.27 mm rechts, 0.04 mm tief								
Streuwert	1.04, horizontal: 0.96, vertikal: 1.11								

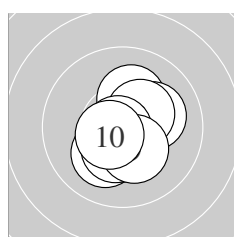
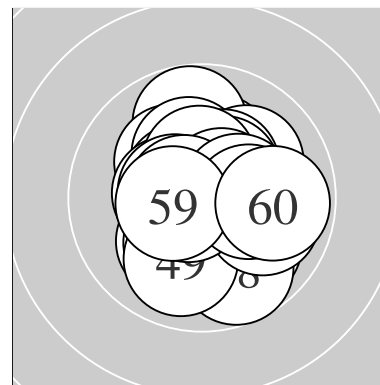

Serie 1:	10.2 *	10.1 →	10.4 *	10.1 ✓	10.6 *
	10.4 *	10.8 *	10.4 *	10.3 *	10.6 *
beste Teiler	36.3 (7.) 97.4 (5.) 98.6 (10.)				
Trefferlage	0.08 mm rechts, 0.37 mm tief				
Streuwert	1.09, horizontal: 0.99, vertikal: 1.18				

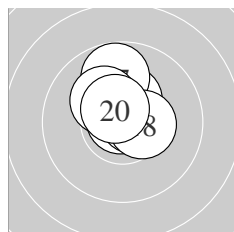

Serie 2:	10.6 *	10.7 *	10.7 *	10.9 *	10.7 *
	10.4 *	9.8 ↑	10.4 *	10.2 *	10.6 *
beste Teiler	22.0 (14.) 52.5 (13.) 64.0 (12.)				
Trefferlage	0.07 mm rechts, 0.85 mm hoch				
Streuwert	0.81, horizontal: 0.70, vertikal: 0.90				

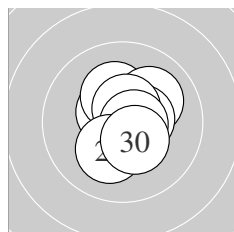

Serie 3:	10.5 *	10.7 *	10.2 *	10.1 ✓	10.7 *
	10.5 *	10.6 *	10.7 *	10.2 *	10.4 *
beste Teiler	54.2 (25.) 58.6 (22.) 74.3 (28.)				
Trefferlage	0.33 mm rechts, 0.10 mm hoch				
Streuwert	0.98, horizontal: 0.85, vertikal: 1.09				

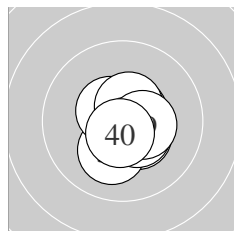

Serie 4:	10.4 *	10.7 *	10.1 ✓	10.6 *	10.7 *
	10.5 *	10.5 *	10.5 *	10.4 *	10.6 *
beste Teiler	57.4 (35.) 59.6 (32.) 80.8 (40.)				
Trefferlage	0.32 mm rechts, 0.24 mm tief				
Streuwert	0.81, horizontal: 0.71, vertikal: 0.90				

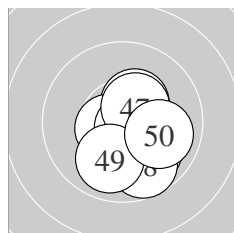

Serie 5:	10.2 *	10.0 ✘	10.4 *	10.6 *	10.6 *
	10.7 *	10.4 *	9.7 ✘	9.9 ✓	10.0 →
beste Teiler	54.4 (46.) 81.7 (44.) 97.5 (45.)				
Trefferlage	0.66 mm rechts, 0.78 mm tief				
Streuwert	1.21, horizontal: 1.02, vertikal: 1.38				

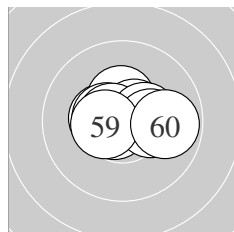

Serie 6:	10.4 *	10.4 *	10.7 *	10.6 *	10.5 *
	10.7 *	10.4 *	10.2 *	10.5 *	9.8 →
beste Teiler	59.4 (53.) 73.3 (56.) 90.4 (54.)				
Trefferlage	0.19 mm rechts, 0.19 mm hoch				
Streuwert	1.06, horizontal: 1.42, vertikal: 0.49				

Meyton Elektronik

ISSF AR Men – Wertung – Männer

StandNr: 112

Schmir, Alexander #264

StartNr: 46

24. Januar 2017 12:08

AUT

QF – Schütze hat sich fürs Finale qualifiziert

Unterschrift des Schuetzen

Meyton Elektronik

Ergebnis:	613.8	(582)
Serien:	100.3	103.6 100.7 102.8 102.8 103.6
Zaehler:	42	18 0 0 0 0 0 0 0 0
Innenzehner:	38	
weiteste:	357	(21), 335 (27), 333 (1)
beste Teiler	13.1	(20.) 30.2 (55.) 32.2 (31.)
Trefferlage	0.36 mm	links, 0.44 mm hoch
Streuwert	1.37,	horizontal: 1.61, vertikal: 1.09

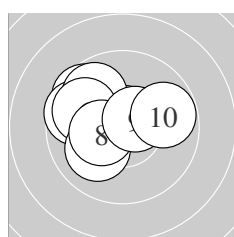
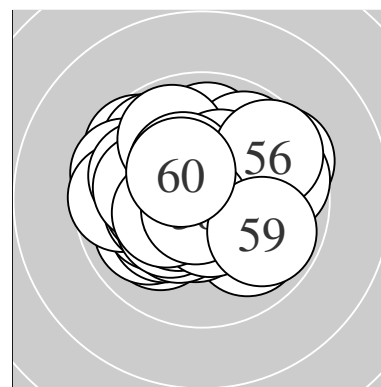

Serie 1:	9.6 ↘	10.0 ↘	10.7 *	9.6 ↖	9.8 ↖
	9.8 ↖	10.1 ↙	10.4 *	10.5 *	9.8 →
beste Teiler	62.0	(3.) 101.2 (9.)	148.2 (8.)		
Trefferlage	1.15 mm	links, 0.79 mm hoch			
Streuwert	1.52,	horizontal: 1.85, vertikal: 1.09			

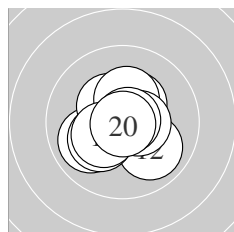

Serie 2:	10.4 *	9.9 ↘	9.9 ↙	10.2 *	10.4 *
	10.3 *	10.3 *	10.5 *	10.8 *	10.9 *
beste Teiler	13.1	(20.) 38.2 (19.)	107.2 (18.)		
Trefferlage	0.15 mm	links, 0.11 mm tief			
Streuwert	1.21,	horizontal: 1.28, vertikal: 1.13			

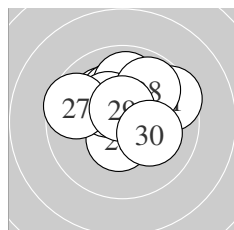

Serie 3:	9.5 →	10.1 ↘	10.5 *	10.2 *	9.9 ↑
	10.3 *	9.6 ↖	9.8 ↗	10.6 *	10.2 *
beste Teiler	92.0	(29.) 115.9 (23.)	156.3 (26.)		
Trefferlage	0.05 mm	rechts, 1.10 mm hoch			
Streuwert	1.54,	horizontal: 1.82, vertikal: 1.19			

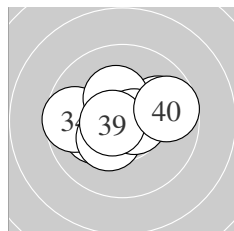

Serie 4:	10.8 *	10.2 *	9.9 →	9.6 ↖	10.6 *
	10.4 *	10.3 *	10.6 *	10.7 *	9.7 →
beste Teiler	32.2	(31.) 71.3 (39.)	78.2 (35.)		
Trefferlage	0.10 mm	links, 0.21 mm hoch			
Streuwert	1.43,	horizontal: 1.86, vertikal: 0.80			

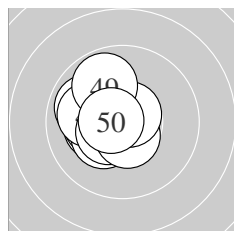

Serie 5:	9.9 ↖	10.2 *	10.2 *	10.3 *	10.0 ↖
	10.5 *	10.6 *	10.7 *	9.8 ↘	10.6 *
beste Teiler	66.8	(48.) 79.6 (50.)	97.7 (47.)		
Trefferlage	1.18 mm	links, 0.16 mm hoch			
Streuwert	1.01,	horizontal: 0.97, vertikal: 1.04			

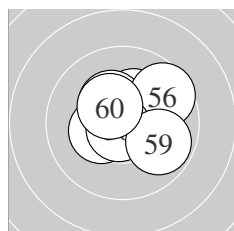

Serie 6:	10.3 *	10.6 *	10.3 *	10.7 *	10.8 *
	9.6 ↗	10.3 *	10.8 *	9.8 ↘	10.4 *
beste Teiler	30.2	(55.) 47.7 (58.)	63.5 (54.)		
Trefferlage	0.32 mm	rechts, 0.48 mm hoch			
Streuwert	1.21,	horizontal: 1.38, vertikal: 1.02			

Meyton Elektronik

ISSF AR Men – Wertung – **Männer**

StandNr: 113

Greuter, Sandro #70804296

StartNr: 47

24. Januar 2017 12:09

Switzerland

Unterschrift des Schuetzen

Meyton Elektronik

Ergebnis:	591.0	(565)
Serien:	99.0 99.4 94.8 100.5 101.5 95.8	
Zaehler:	28 29 3 0 0 0 0 0 0 0	
Innenzehner:	20	
weiteste:	626 (10), 620 (27), 504 (51)	
beste Teiler	43.8 (49.) 50.0 (37.) 52.7 (14.)	
Trefferlage	0.49 mm rechts, 0.51 mm hoch	
Streuwert	2.14, horizontal: 2.51, vertikal: 1.69	

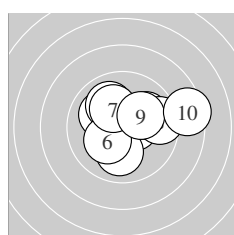
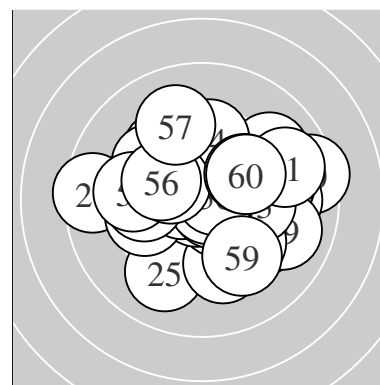

Serie 1:					
	10.1 ↖	10.5 *	10.0 ↓	10.0 →	10.0 ↘
	10.2 *	10.2 *	9.5 →	10.1 →	8.4 →
beste Teiler	112.0 (2.)	186.5 (6.)	195.8 (7.)		
Trefferlage	0.88 mm rechts, 0.57 mm hoch				
Streuwert	2.05, horizontal: 2.55, vertikal: 1.38				

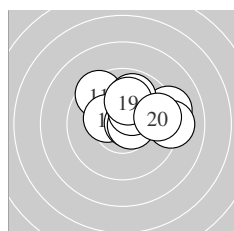

Serie 2:					
	9.5 ↖	10.3 *	9.2 →	10.7 *	10.6 *
	10.4 *	9.1 →	9.9 ↑	10.1 ↑	9.6 →
beste Teiler	52.7 (14.)	81.6 (15.)	147.2 (16.)		
Trefferlage	1.21 mm rechts, 1.11 mm hoch				
Streuwert	1.76, horizontal: 2.24, vertikal: 1.07				

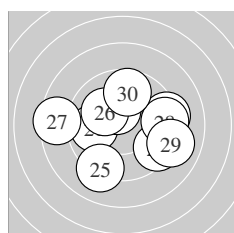

Serie 3:					
	9.9 ←	9.3 →	10.4 *	9.4 ↘	9.1 ↘
	10.1 ↖	8.5 ←	9.4 →	9.0 →	9.7 ↑
beste Teiler	145.9 (23.)	208.6 (26.)	269.2 (21.)		
Trefferlage	0.31 mm rechts, 0.07 mm tief				
Streuwert	2.93, horizontal: 3.60, vertikal: 2.05				

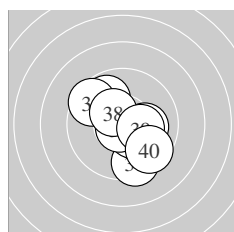

Serie 4:					
	9.4 ↓	10.2 *	10.4 *	10.1 →	9.8 ↘
	9.5 ↖	10.8 *	10.4 *	10.3 *	9.6 ↘
beste Teiler	50.0 (37.)	134.4 (33.)	139.4 (38.)		
Trefferlage	0.43 mm rechts, 0.38 mm tief				
Streuwert	1.80, horizontal: 1.75, vertikal: 1.86				

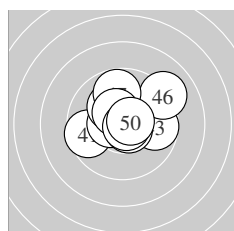

Serie 5:					
	9.6 ←	10.5 *	9.7 →	10.2 *	10.7 *
	9.1 →	9.8 ↑	10.5 *	10.8 *	10.6 *
beste Teiler	43.8 (49.)	74.5 (45.)	78.4 (50.)		
Trefferlage	0.19 mm rechts, 0.67 mm hoch				
Streuwert	1.74, horizontal: 2.06, vertikal: 1.34				

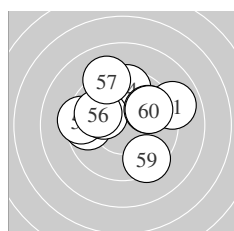

Serie 6:					
	8.9 →	9.6 ←	9.4 ←	9.6 ↑	10.2 *
	9.9 ↖	9.2 ↘	9.8 →	9.4 ↘	9.8 →
beste Teiler	199.9 (55.)	255.4 (56.)	280.2 (58.)		
Trefferlage	0.05 mm links, 1.16 mm hoch				
Streuwert	2.49, horizontal: 2.90, vertikal: 2.01				

ISSF AR Men – Wertung – **Männer**

StandNr: 114

Mattle, Michael #70804679

StartNr: 48

24. Januar 2017 11:57

VLSV

Unterschrift des Schuetzen

Meyton Elektronik

Ergebnis: **601.1** (574)
 Serien: 98.6 100.2 101.5 99.1 98.1 103.6
 Zaehler: 37 20 3 0 0 0 0 0 0 0
 Innenzehner: 32
 weiteste: 662 (41), 579 (26), 503 (1)
 beste Teiler 60.0 (59.) 68.0 (28.) 76.2 (56.)
 Trefferlage 0.38 mm rechts, 0.12 mm hoch
 Streuwert 1.91, horizontal: 2.23, vertikal: 1.51

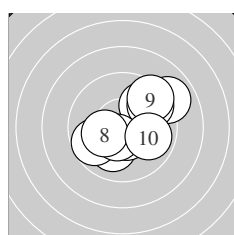
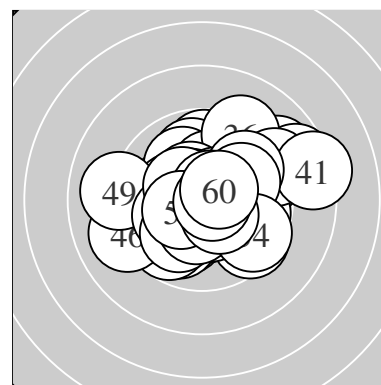

Serie 1:
 8.9 ↗ 10.1 ↘ 10.5 * 9.8 ↗ 9.6 ↗
 9.7 ↖ 10.5 * 10.2 * 9.4 ↗ 9.9 ↘
 beste Teiler 102.1 (3.) 112.2 (7.) 182.1 (8.)
 Trefferlage 0.85 mm rechts, 0.26 mm hoch
 Streuwert 2.09, horizontal: 2.28, vertikal: 1.88

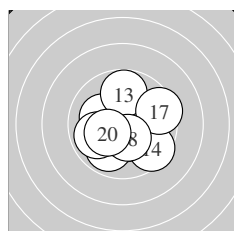

Serie 2:
 10.4 * 10.1 ↖ 9.8 ↑ 9.5 ↘ 10.4 *
 9.9 ↘ 9.5 ↗ 10.4 * 9.9 ↖ 10.3 *
 beste Teiler 140.2 (18.) 140.6 (15.) 148.3 (11.)
 Trefferlage 0.12 mm rechts, 0.48 mm tief
 Streuwert 1.83, horizontal: 1.99, vertikal: 1.65

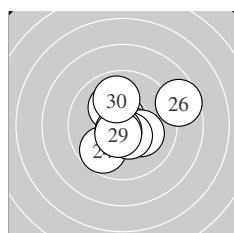

Serie 3:
 10.6 * 10.5 * 10.2 * 9.7 ↘ 10.5 *
 8.6 ↗ 10.2 * 10.7 * 10.6 * 9.9 ↑
 beste Teiler 68.0 (28.) 80.8 (21.) 94.8 (29.)
 Trefferlage 0.42 mm rechts, 0.09 mm hoch
 Streuwert 1.83, horizontal: 2.03, vertikal: 1.59

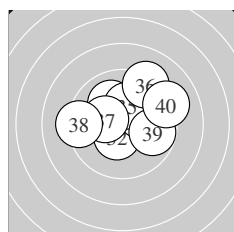

Serie 4:
 10.6 * 10.4 * 10.2 * 10.0 ↖ 10.2 *
 9.2 ↗ 10.3 * 9.3 ← 9.8 ↘ 9.1 ↗
 beste Teiler 81.2 (31.) 131.5 (32.) 173.2 (37.)
 Trefferlage 0.47 mm rechts, 0.85 mm hoch
 Streuwert 2.04, horizontal: 2.45, vertikal: 1.51

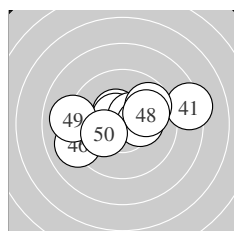

Serie 5:
 8.3 ↗ 10.4 * 10.6 * 10.5 * 9.7 ↗
 9.1 ↖ 10.3 * 10.0 ↗ 9.0 ← 10.2 *
 beste Teiler 97.6 (43.) 114.5 (44.) 129.1 (42.)
 Trefferlage 0.14 mm rechts, 0.49 mm hoch
 Streuwert 2.50, horizontal: 3.35, vertikal: 1.14

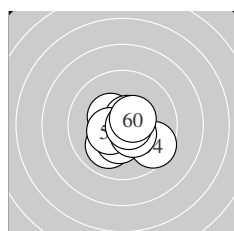

Serie 6:
 10.0 ↘ 10.6 * 10.4 * 9.6 ↘ 10.4 *
 10.6 * 10.4 * 10.4 * 10.7 * 10.5 *
 beste Teiler 60.0 (59.) 76.2 (56.) 86.8 (52.)
 Trefferlage 0.28 mm rechts, 0.47 mm tief
 Streuwert 1.19, horizontal: 1.32, vertikal: 1.03

Meyton Elektronik

ISSF AR Men – Wertung – **Männer**

StandNr: 115

Friman., Björn #70804645

StartNr: 49

24. Januar 2017 11:50

F – Esbo Skytteförening

Unterschrift des Schuetzen

Meyton Elektronik

Ergebnis:	620.0	(596)						
Serien:	102.9	103.8	103.9	103.4	102.0	104.0		
Zähler:	56	4	0	0	0	0	0	0
Innenzehner:	45							
weiteste:	331 (29), 329 (32), 264 (14)							
beste Teiler	44.5 (27.) 45.2 (13.) 46.2 (28.)							
Trefferlage	0.22 mm rechts, 0.07 mm hoch							
Streuwert	1.18, horizontal: 1.14, vertikal: 1.23							

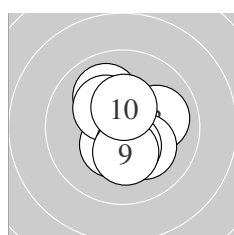
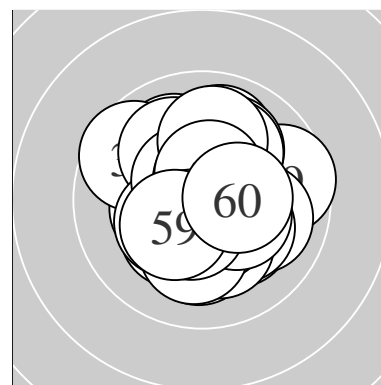

Serie 1:

10.5 *	10.4 *	10.0 →	10.4 *	10.0 ↘
10.3 *	10.2 *	10.4 *	10.3 *	10.4 *
beste Teiler	118.3 (1.) 132.8 (8.) 135.2 (10.)			
Trefferlage	0.23 mm rechts, 0.06 mm hoch			
Streuwert	1.27, horizontal: 1.11, vertikal: 1.41			

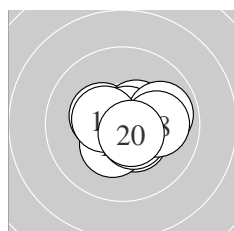

Serie 2:

10.4 *	10.5 *	10.8 *	9.9 →	10.4 *
10.3 *	10.5 *	10.0 →	10.4 *	10.6 *
beste Teiler	45.2 (13.) 85.6 (20.) 111.1 (17.)			
Trefferlage	0.49 mm rechts, 0.11 mm tief			
Streuwert	1.08, horizontal: 1.32, vertikal: 0.77			

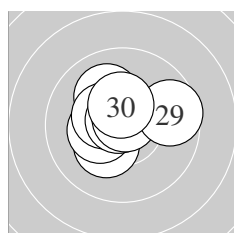

Serie 3:

10.3 *	10.3 *	10.1 ↘	10.7 *	10.4 *
10.5 *	10.8 *	10.8 *	9.6 →	10.4 *
beste Teiler	44.5 (27.) 46.2 (28.) 58.2 (24.)			
Trefferlage	0.21 mm links, 0.55 mm hoch			
Streuwert	1.14, horizontal: 1.34, vertikal: 0.90			

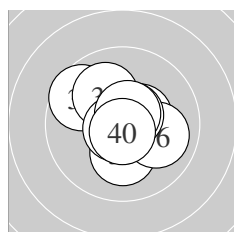

Serie 4:

10.5 *	9.6 ↘	10.5 *	10.0 ↘	10.2 *
10.0 →	10.6 *	10.7 *	10.6 *	10.7 *
beste Teiler	51.0 (40.) 54.9 (38.) 78.7 (39.)			
Trefferlage	0.06 mm rechts, 0.10 mm hoch			
Streuwert	1.30, horizontal: 1.36, vertikal: 1.23			

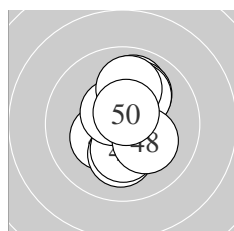

Serie 5:

10.3 *	9.9 ↑	10.1 ↓	10.3 *	10.0 ↗
10.5 *	10.1 ↗	10.2 *	10.0 ↑	10.6 *
beste Teiler	82.5 (50.) 101.6 (46.) 160.8 (41.)			
Trefferlage	0.30 mm rechts, 0.45 mm hoch			
Streuwert	1.39, horizontal: 0.87, vertikal: 1.76			

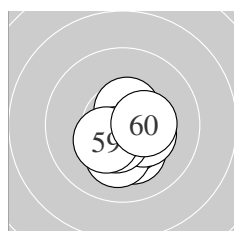

Serie 6:

10.2 *	10.5 *	10.6 *	10.5 *	10.1 ↓
10.5 *	10.3 *	10.5 *	10.4 *	10.4 *
beste Teiler	89.6 (53.) 104.4 (56.) 107.0 (52.)			
Trefferlage	0.44 mm rechts, 0.62 mm tief			
Streuwert	0.89, horizontal: 0.84, vertikal: 0.94			

Meyton Elektronik

ISSF AR Men – Wertung – Männer

StandNr: 116

Höllwarth, Michael #30

StartNr: 50

24. Januar 2017 12:04

AUT

Unterschrift des Schuetzen

Meyton Elektronik

Ergebnis:	620.6	(594)							
Serien:	103.9	103.3	102.5	104.1	104.9	101.9			
Zähler:	54	6	0	0	0	0	0	0	0
Innenzehner:	46								
weiteste:	437 (29), 322 (55), 321 (51)								
beste Teiler	7.2 (26.) 30.6 (46.) 36.6 (50.)								
Trefferlage	0.00 mm , 0.27 mm hoch								
Streuwert	1.22, horizontal: 1.36, vertikal: 1.07								

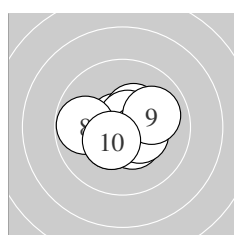
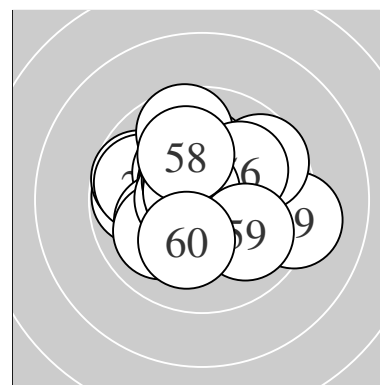

Serie 1:					
	10.7 *	10.4 *	10.6 *	10.4 *	10.7 *
	10.5 *	10.4 *	9.8 ←	10.0 →	10.4 *
beste Teiler	58.8 (1.) 72.4 (5.) 82.1 (3.)				
Trefferlage	0.13 mm rechts, 0.03 mm tief				
Streuwert	1.17, horizontal: 1.44, vertikal: 0.82				

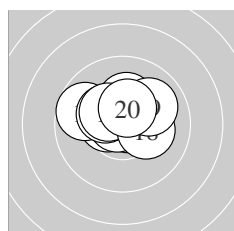

Serie 2:					
	10.5 *	10.8 *	10.8 *	10.2 *	9.7 ↖
	10.3 *	10.4 *	10.2 *	10.0 →	10.4 *
beste Teiler	42.1 (12.) 42.9 (13.) 114.4 (11.)				
Trefferlage	0.20 mm links, 0.68 mm hoch				
Streuwert	1.17, horizontal: 1.50, vertikal: 0.70				

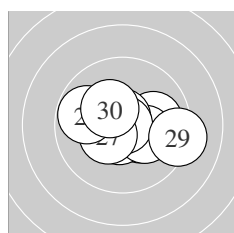

Serie 3:					
	10.4 *	10.0 →	10.6 *	10.2 *	10.7 *
	10.9 *	10.4 *	9.8 ←	9.2 →	10.3 *
beste Teiler	7.2 (26.) 58.4 (25.) 84.7 (23.)				
Trefferlage	0.45 mm rechts, 0.08 mm tief				
Streuwert	1.53, horizontal: 2.01, vertikal: 0.80				

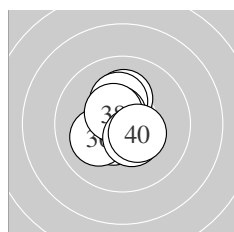

Serie 4:					
	10.6 *	10.2 *	10.5 *	10.5 *	10.2 *
	10.1 ↙	10.6 *	10.5 *	10.5 *	10.4 *
beste Teiler	80.0 (31.) 81.9 (37.) 101.8 (34.)				
Trefferlage	0.25 mm links, 0.04 mm hoch				
Streuwert	1.03, horizontal: 0.86, vertikal: 1.18				

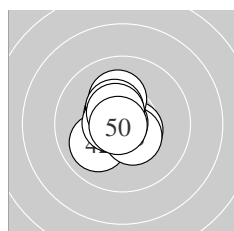

Serie 5:					
	10.6 *	10.0 ↙	10.5 *	10.5 *	10.2 *
	10.8 *	10.4 *	10.6 *	10.5 *	10.8 *
beste Teiler	30.6 (46.) 36.6 (50.) 89.2 (48.)				
Trefferlage	0.40 mm links, 0.19 mm hoch				
Streuwert	0.91, horizontal: 0.79, vertikal: 1.02				

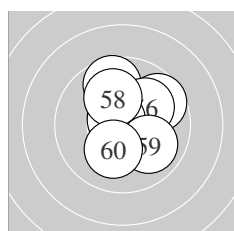

Serie 6:					
	9.7 →	10.6 *	10.5 *	10.3 *	9.7 ↑
	10.1 →	10.7 *	10.1 ↕	10.0 →	10.2 *
beste Teiler	63.2 (57.) 88.5 (52.) 107.7 (53.)				
Trefferlage	0.24 mm rechts, 0.86 mm hoch				
Streuwert	1.45, horizontal: 1.35, vertikal: 1.54				

Meyton Elektronik

ISSF AR Men – Wertung – Männer

StandNr: 117

Dürr, Christoph #70804309

StartNr: 51

24. Januar 2017 12:06

Switzerland

Unterschrift des Schuetzen

Meyton Elektronik

Ergebnis:	605.8	(583)						
Serien:	99.0	100.2	103.0	102.1	100.4	101.1		
Zaehler:	43	17	0	0	0	0	0	0
Innenzehner:	35							
weiteste:	477 (57), 474 (56), 443 (5)							
beste Teiler	32.3 (51.) 46.4 (25.) 72.8 (4.)							
Trefferlage	0.41 mm rechts, 0.08 mm tief							
Streuwert	1.72, horizontal: 1.86, vertikal: 1.56							

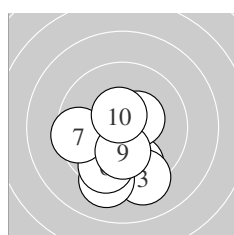
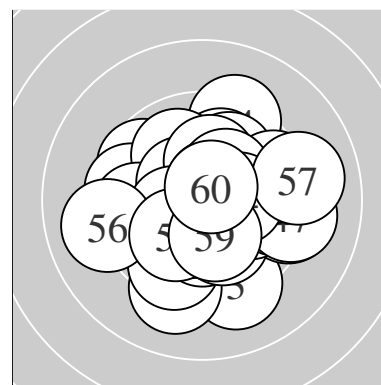

Serie 1:	10.0 ↘	9.7 ↘	9.2 ↘	10.7 *	9.2 ↘
	9.6 ↘	9.5 ←	10.4 *	10.2 *	10.5 *
beste Teiler	72.8 (4.) 101.9 (10.) 134.8 (8.)				
Trefferlage	0.43 mm links, 1.75 mm tief				
Streuwert	1.72, horizontal: 1.53, vertikal: 1.89				

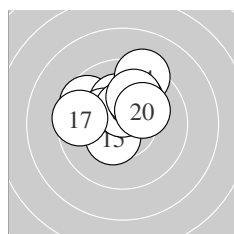

Serie 2:	9.6 ↖	10.2 *	10.3 *	9.3 ↗	10.4 *
	10.5 *	9.6 ←	10.1 ↗	10.0 ↗	10.2 *
beste Teiler	120.0 (16.) 130.0 (15.) 162.9 (13.)				
Trefferlage	0.38 mm links, 1.38 mm hoch				
Streuwert	1.55, horizontal: 1.78, vertikal: 1.26				

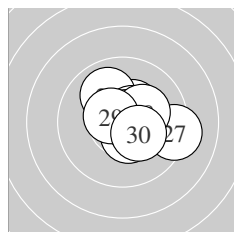

Serie 3:	10.4 *	10.0 ↖	10.5 *	10.5 *	10.8 *
	10.5 *	9.3 →	10.2 *	10.5 *	10.3 *
beste Teiler	46.4 (25.) 101.1 (23.) 105.5 (29.)				
Trefferlage	0.82 mm rechts, 0.25 mm hoch				
Streuwert	1.28, horizontal: 1.48, vertikal: 1.05				

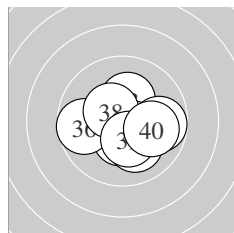

Serie 4:	10.4 *	10.4 *	10.3 *	10.6 *	10.1 ↘
	9.7 ←	9.8 →	10.5 *	10.3 *	10.0 →
beste Teiler	95.2 (34.) 125.3 (38.) 138.0 (31.)				
Trefferlage	0.50 mm rechts, 0.44 mm tief				
Streuwert	1.42, horizontal: 1.70, vertikal: 1.07				

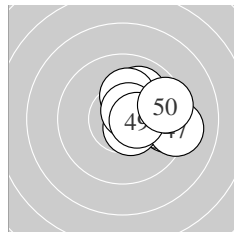

Serie 5:	10.4 *	10.0 ↗	9.5 →	9.9 →	10.6 *
	10.2 *	9.2 →	10.6 *	10.5 *	9.5 →
beste Teiler	83.2 (48.) 96.2 (45.) 116.4 (49.)				
Trefferlage	1.88 mm rechts, 0.47 mm hoch				
Streuwert	1.28, horizontal: 1.49, vertikal: 1.04				

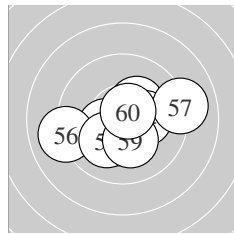

Serie 6:	10.8 *	10.3 *	10.3 *	10.3 *	10.4 *
	9.1 ←	9.0 →	10.1 ↘	10.2 *	10.6 *
beste Teiler	32.3 (51.) 76.8 (60.) 150.8 (55.)				
Trefferlage	0.11 mm rechts, 0.41 mm tief				
Streuwert	1.86, horizontal: 2.39, vertikal: 1.12				

Meyton Elektronik

ISSF AR Men – Wertung – **Männer**

StandNr: 118

Hoberg, Alex #70804633

StartNr: 52

24. Januar 2017 11:47

Australia

Unterschrift des Schuetzen

Meyton Elektronik

Ergebnis:	623.8	(594)							
Serien:	101.8	104.6	104.9	105.0	103.2	104.3			
Zaehler:	54	6	0	0	0	0	0	0	0
Innenzehner:	48								
weiteste:	332	(1), 290	(3), 282	(42)					
beste Teiler	22.8	(24.)	23.7	(31.)	36.1	(15.)			
Trefferlage	0.04	mm rechts,	0.17	mm tief					
Streuwert	1.12,	horizontal: 1.14,	vertikal: 1.10						

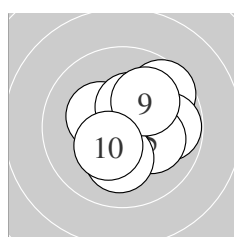
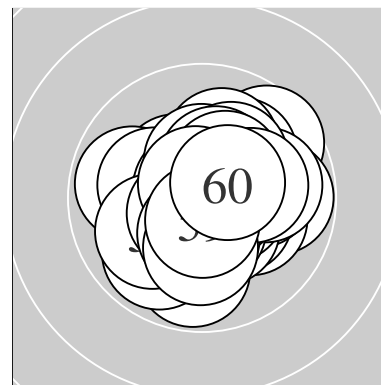

Serie 1:	9.6 ↗	10.4 *	9.8 →	10.7 *	10.1 ↘	
	10.3 *	10.4 *	10.1 ↓	10.1 ↗	10.3 *	
beste Teiler	54.0	(4.)	139.4	(7.)	147.5	(2.)
Trefferlage	0.80	mm rechts,	0.28	mm hoch		
Streuwert	1.39,	horizontal: 1.46,	vertikal: 1.31			

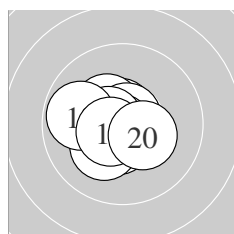

Serie 2:	10.6 *	10.5 *	10.4 *	10.7 *	10.8 *	
	10.6 *	10.2 *	9.8 ←	10.6 *	10.4 *	
beste Teiler	36.1	(15.)	51.1	(14.)	77.6	(11.)
Trefferlage	0.58	mm links,	0.09	mm tief		
Streuwert	0.94,	horizontal: 1.05,	vertikal: 0.82			

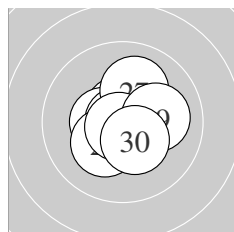

Serie 3:	10.5 *	10.6 *	10.5 *	10.9 *	10.7 *	
	10.3 *	10.1 ↗	10.8 *	10.1 →	10.4 *	
beste Teiler	22.8	(24.)	38.6	(28.)	69.6	(25.)
Trefferlage	0.06	mm rechts,	0.00	mm		
Streuwert	1.01,	horizontal: 1.03,	vertikal: 0.99			

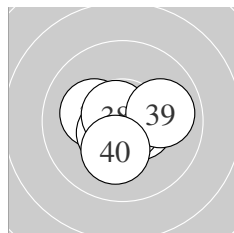

Serie 4:	10.9 *	10.5 *	10.5 *	10.8 *	10.8 *	
	10.2 *	10.5 *	10.7 *	9.9 →	10.2 *	
beste Teiler	23.7	(31.)	43.2	(34.)	47.5	(35.)
Trefferlage	0.06	mm links,	0.35	mm tief		
Streuwert	0.97,	horizontal: 1.15,	vertikal: 0.75			

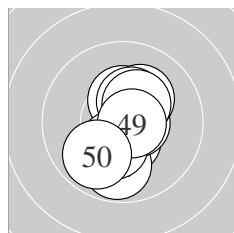

Serie 5:	10.5 *	9.8 ↓	10.6 *	10.4 *	10.2 *	
	10.4 *	10.4 *	10.3 *	10.7 *	9.9 ↙	
beste Teiler	60.6	(49.)	85.2	(43.)	120.0	(41.)
Trefferlage	0.16	mm rechts,	0.23	mm tief		
Streuwert	1.28,	horizontal: 0.85,	vertikal: 1.59			

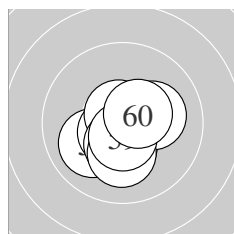

Serie 6:	10.0 ↙	10.4 *	10.7 *	10.6 *	10.7 *	
	10.4 *	10.2 *	10.2 *	10.6 *	10.5 *	
beste Teiler	61.7	(55.)	64.8	(53.)	88.0	(59.)
Trefferlage	0.08	mm links,	0.63	mm tief		
Streuwert	0.97,	horizontal: 1.01,	vertikal: 0.93			

ISSF AR Men – Wertung – Männer

StandNr: 119

Baudouin, Brian #70804692

StartNr: 53

24. Januar 2017 11:53

France

Unterschrift des Schuetzen

Meyton Elektronik

Ergebnis:	617.6	(592)					
Serien:	102.7	102.8	103.2	102.5	104.2	102.2	
Zaehler:	52	8	0	0	0	0	0
Innenzehner:	37						
weiteste:	392 (9), 349 (15), 324 (28)						
beste Teiler	11.1 (12.) 11.6 (24.) 42.4 (32.)						
Trefferlage	0.12 mm links, 0.29 mm hoch						
Streuwert	1.31, horizontal: 1.36, vertikal: 1.24						

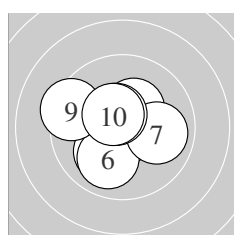
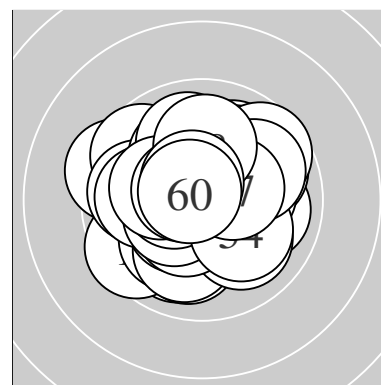

Serie 1:	10.7 *	10.3 *	10.5 *	10.1 ↙	10.7 *
	10.0 ↘	10.0 →	10.5 *	9.4 ↖	10.5 *
beste Teiler	63.3 (5.) 64.5 (1.) 104.6 (8.)				
Trefferlage	0.58 mm links, 0.04 mm tief				
Streuwert	1.41, horizontal: 1.57, vertikal: 1.23				

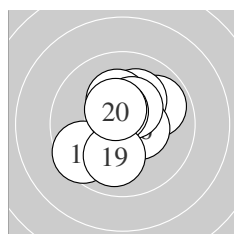

Serie 2:	9.9 ↗	10.9 *	10.2 *	10.2 *	9.6 ↘
	10.5 *	10.4 *	10.6 *	10.0 ↓	10.5 *
beste Teiler	11.1 (12.) 98.6 (18.) 117.6 (20.)				
Trefferlage	0.04 mm rechts, 0.32 mm hoch				
Streuwert	1.43, horizontal: 1.39, vertikal: 1.47				

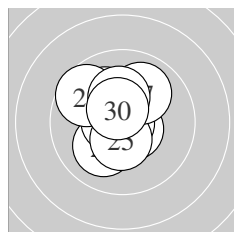

Serie 3:	10.6 *	10.1 ↙	10.6 *	10.9 *	10.5 *
	10.1 ↘	10.0 ↗	9.7 ↖	10.2 *	10.5 *
beste Teiler	11.6 (24.) 77.1 (23.) 87.6 (21.)				
Trefferlage	0.46 mm links, 0.50 mm hoch				
Streuwert	1.26, horizontal: 1.11, vertikal: 1.39				

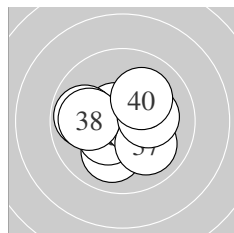

Serie 4:	10.0 ↓	10.8 *	10.6 *	9.8 ←	10.4 *
	10.6 *	10.0 ↘	10.0 ←	10.2 *	10.1 ↗
beste Teiler	42.4 (32.) 76.3 (33.) 84.2 (36.)				
Trefferlage	0.14 mm links, 0.21 mm tief				
Streuwert	1.40, horizontal: 1.64, vertikal: 1.11				

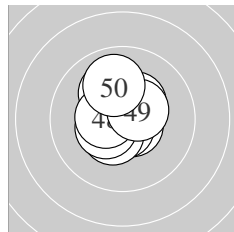

Serie 5:	10.8 *	10.1 ↘	10.4 *	10.6 *	10.7 *
	10.4 *	10.4 *	10.5 *	10.4 *	9.9 ↑
beste Teiler	44.5 (41.) 61.2 (45.) 84.0 (44.)				
Trefferlage	0.15 mm links, 0.33 mm hoch				
Streuwert	1.04, horizontal: 0.89, vertikal: 1.16				

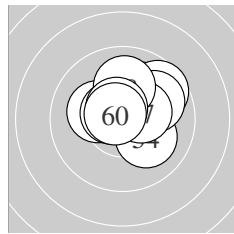

Serie 6:	10.2 *	10.0 ↗	9.7 ↗	10.1 ↘	10.6 *
	9.9 ↗	10.4 *	10.0 ↑	10.6 *	10.7 *
beste Teiler	65.4 (60.) 88.6 (59.) 93.4 (55.)				
Trefferlage	0.56 mm rechts, 0.87 mm hoch				
Streuwert	1.27, horizontal: 1.46, vertikal: 1.05				

Meyton Elektronik

ISSF AR Men – Wertung – Männer

StandNr: 120

Germond, Etienne #70804681

StartNr: 54

24. Januar 2017 12:07

France

Unterschrift des Schuetzen

Meyton Elektronik

Ergebnis:	614.0	(589)							
Serien:	102.9	103.7	100.9	102.9	100.8	102.8			
Zaehler:	49	11	0	0	0	0	0	0	0
Innenzehner:	37								
weiteste:	444 (56), 364 (8), 359 (22)								
beste Teiler	37.1 (12.)	40.5 (60.)	50.0 (59.)						
Trefferlage	0.08 mm links, 0.15 mm hoch								
Streuwert	1.45, horizontal: 1.57, vertikal: 1.32								

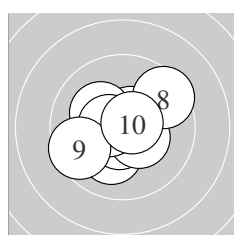
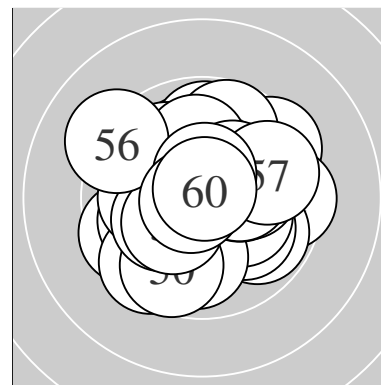

Serie 1:	10.1 ↘	10.6 *	10.6 *	10.6 *	10.2 *
	10.4 *	10.6 *	9.5 ↗	9.6 ↙	10.7 *
beste Teiler	75.1 (10.) 85.1 (4.) 89.2 (3.)				
Trefferlage	0.04 mm links, 0.07 mm tief				
Streuwert	1.47, horizontal: 1.69, vertikal: 1.22				

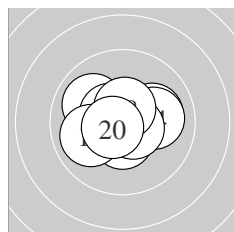

Serie 2:	10.0 ↖	10.8 *	10.1 →	10.1 →	10.5 *
	10.5 *	10.6 *	10.5 *	10.0 ↙	10.6 *
beste Teiler	37.1 (12.) 82.2 (20.) 88.1 (17.)				
Trefferlage	0.03 mm links, 0.08 mm hoch				
Streuwert	1.23, horizontal: 1.54, vertikal: 0.81				

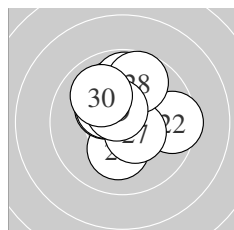

Serie 3:	10.0 ↑	9.5 →	10.2 *	10.3 *	10.3 *
	9.8 ↑	10.5 *	9.7 ↑	10.6 *	10.0 ↘
beste Teiler	97.5 (29.) 116.6 (27.) 154.9 (25.)				
Trefferlage	0.03 mm rechts, 1.00 mm hoch				
Streuwert	1.53, horizontal: 1.52, vertikal: 1.55				

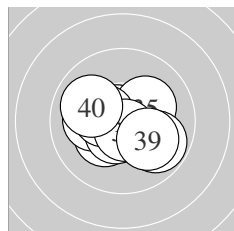

Serie 4:	10.7 *	10.3 *	10.1 ←	10.6 *	10.2 *
	10.4 *	9.8 ↘	10.7 *	10.1 ↖	10.0 ↖
beste Teiler	56.7 (31.) 68.1 (38.) 97.7 (34.)				
Trefferlage	0.18 mm links, 0.24 mm tief				
Streuwert	1.35, horizontal: 1.66, vertikal: 0.95				

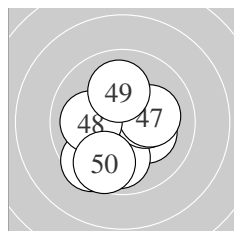

Serie 5:	10.2 *	10.4 *	10.5 *	9.5 ↘	9.9 ↓
	10.3 *	10.2 *	10.0 ←	10.1 ↑	9.7 ↘
beste Teiler	113.3 (43.) 141.4 (42.) 167.6 (46.)				
Trefferlage	0.12 mm links, 0.34 mm tief				
Streuwert	1.70, horizontal: 1.54, vertikal: 1.85				

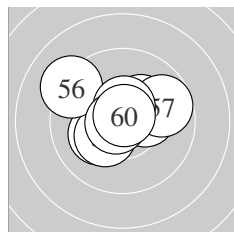

Serie 6:	10.2 *	10.3 *	10.3 *	10.7 *	10.3 *
	9.2 ↖	9.7 →	10.5 *	10.8 *	10.8 *
beste Teiler	40.5 (60.) 50.0 (59.) 69.2 (54.)				
Trefferlage	0.13 mm links, 0.49 mm hoch				
Streuwert	1.50, horizontal: 1.85, vertikal: 1.04				

Meyton Elektronik

ISSF AR Men – Wertung – Männer

StandNr: 121

Alanazi, Faiz #70804716

StartNr: 55

24. Januar 2017 11:58

Kingdom of Saudi Arabia

Unterschrift des Schuetzen

Meyton Elektronik

Ergebnis: **621.8** (593)
 Serien: 103.7 103.3 102.8 103.9 104.0 104.1
 Zaehler: 53 7 0 0 0 0 0 0 0 0
 Innenzehner: 48
 weiteste: 309 (57), 288 (19), 284 (18)
 beste Teiler 6.4 (54.) 28.4 (2.) 50.8 (15.)
 Trefferlage 0.05 mm rechts, 0.02 mm tief
 Streuwert 1.15, horizontal: 1.21, vertikal: 1.08

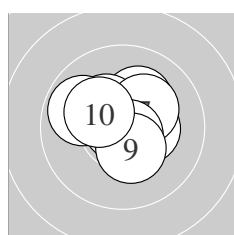
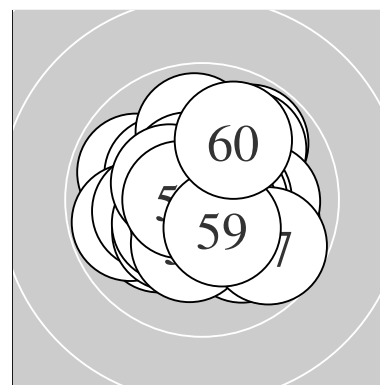

Serie 1:
 10.2 * 10.8 * 10.6 * 10.3 * 10.4 *
 9.9 ↖ 10.2 * 10.7 * 10.4 * 10.2 *
 beste Teiler 28.4 (2.) 58.8 (8.) 88.4 (3.)
 Trefferlage 0.01 mm links, 0.35 mm hoch
 Streuwert 1.16, horizontal: 1.31, vertikal: 0.98

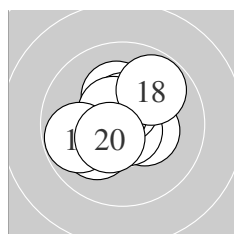

Serie 2:
 10.1 ↙ 10.2 * 10.6 * 10.4 * 10.8 *
 10.5 * 10.6 * 9.8 ↗ 9.8 ← 10.5 *
 beste Teiler 50.8 (15.) 90.1 (13.) 100.0 (17.)
 Trefferlage 0.34 mm links, 0.19 mm hoch
 Streuwert 1.28, horizontal: 1.35, vertikal: 1.19

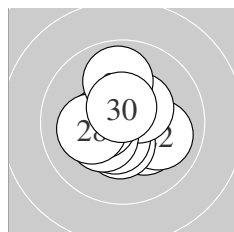

Serie 3:
 10.2 * 10.0 → 10.4 * 10.5 * 10.4 *
 10.3 * 10.4 * 10.1 ← 9.9 ↑ 10.6 *
 beste Teiler 95.2 (30.) 116.8 (24.) 135.2 (27.)
 Trefferlage 0.08 mm links, 0.13 mm tief
 Streuwert 1.29, horizontal: 1.32, vertikal: 1.27

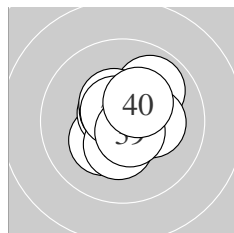

Serie 4:
 9.9 ↗ 10.3 * 10.6 * 10.6 * 10.3 *
 10.5 * 10.6 * 10.2 * 10.6 * 10.3 *
 beste Teiler 78.0 (37.) 82.6 (39.) 82.8 (33.)
 Trefferlage 0.13 mm rechts, 0.26 mm hoch
 Streuwert 1.09, horizontal: 1.06, vertikal: 1.11

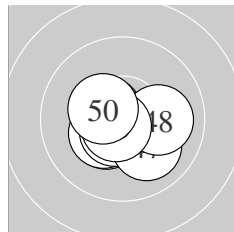

Serie 5:
 10.4 * 10.3 * 10.4 * 10.6 * 10.5 *
 10.7 * 10.0 ↘ 10.0 → 10.7 * 10.4 *
 beste Teiler 63.1 (49.) 72.3 (46.) 92.9 (44.)
 Trefferlage 0.02 mm rechts, 0.48 mm tief
 Streuwert 1.04, horizontal: 1.30, vertikal: 0.69

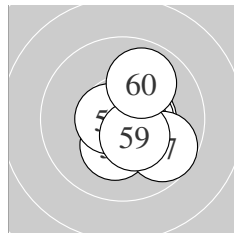

Serie 6:
 10.5 * 10.5 * 10.6 * 10.9 * 10.7 *
 10.3 * 9.7 ↘ 10.6 * 10.4 * 9.9 ↗
 beste Teiler 6.4 (54.) 57.6 (55.) 77.0 (53.)
 Trefferlage 0.59 mm rechts, 0.31 mm tief
 Streuwert 1.07, horizontal: 0.99, vertikal: 1.14

Meyton Elektronik

ISSF AR Men – Wertung – Männer

StandNr: 122

Rumpler, Gernot #265

StartNr: 56

24. Januar 2017 12:07

AUT

Unterschrift des Schuetzen

Meyton Elektronik

Ergebnis:	616.6	(588)							
Serien:	103.6	99.8	104.1	102.1	103.2	103.8			
Zaehler:	48	12	0	0	0	0	0	0	0
Innenzehner:	43								
weiteste:	415	(52), 401	(4), 384	(15)					
beste Teiler	12.2	(54.)	30.0	(53.)	52.0	(31.)			
Trefferlage	0.07	mm rechts,	0.23	mm hoch					
Streuwert	1.38,	horizontal: 1.59,	vertikal: 1.12						

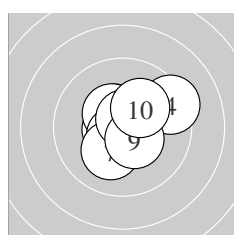
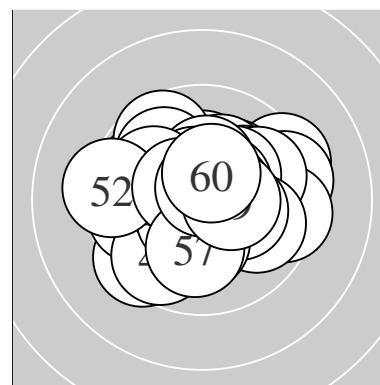

Serie 1:						
	10.5 *	10.6 *	10.7 *	9.3 ↗	10.4 *	
	10.6 *	10.2 *	10.7 *	10.4 *	10.2 *	
beste Teiler	52.7	(3.)	66.0	(8.)	81.2	(6.)
Trefferlage	0.24	mm rechts,	0.29	mm hoch		
Streuwert	1.28,	horizontal: 1.41,	vertikal: 1.12			

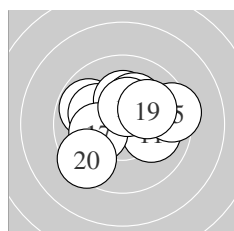

Serie 2:						
	10.0 ↘	9.8 ↖	10.1 ↖	10.2 *	9.4 ↗	
	10.2 *	10.2 *	10.4 *	10.1 ↗	9.4 ↘	
beste Teiler	136.1	(18.)	183.0	(14.)	186.0	(16.)
Trefferlage	0.00	mm ,	0.49	mm hoch		
Streuwert	1.85,	horizontal: 2.22,	vertikal: 1.38			

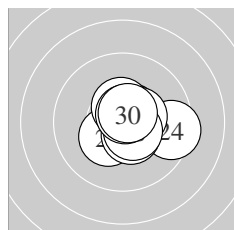

Serie 3:						
	10.3 *	10.6 *	10.4 *	9.5 ↘	10.5 *	
	10.5 *	10.5 *	10.5 *	10.7 *	10.6 *	
beste Teiler	62.9	(29.)	78.3	(30.)	91.5	(22.)
Trefferlage	0.75	mm rechts,	0.01	mm hoch		
Streuwert	1.04,	horizontal: 1.24,	vertikal: 0.80			

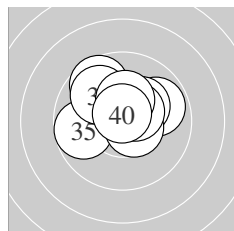

Serie 4:						
	10.7 *	9.9 ↗	9.6 ↖	10.2 *	9.7 ↖	
	10.6 *	10.5 *	9.9 ↖	10.3 *	10.7 *	
beste Teiler	52.0	(31.)	58.2	(40.)	99.8	(36.)
Trefferlage	0.01	mm links,	0.87	mm hoch		
Streuwert	1.40,	horizontal: 1.67,	vertikal: 1.07			

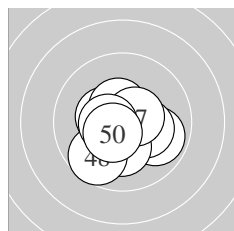

Serie 5:						
	9.9 ↘	10.3 *	10.4 *	10.7 *	10.2 *	
	10.5 *	10.5 *	9.7 ↘	10.5 *	10.5 *	
beste Teiler	53.0	(44.)	101.6	(47.)	111.0	(50.)
Trefferlage	0.07	mm links,	0.45	mm tief		
Streuwert	1.27,	horizontal: 1.38,	vertikal: 1.14			

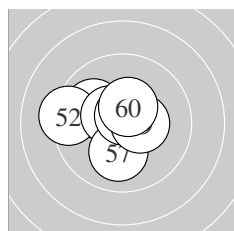

Serie 6:						
	10.0 ↖	9.3 ↖	10.8 *	10.9 *	10.7 *	
	10.5 *	10.1 ↓	10.7 *	10.4 *	10.4 *	
beste Teiler	12.2	(54.)	30.0	(53.)	57.0	(58.)
Trefferlage	0.46	mm links,	0.18	mm hoch		
Streuwert	1.32,	horizontal: 1.60,	vertikal: 0.95			

Meyton Elektronik

ISSF AR Men – Wertung – **Männer**

StandNr: 123

Bale, Dean #70804687

StartNr: 57

24. Januar 2017 12:01

GBR

Unterschrift des Schuetzen

Meyton Elektronik

Ergebnis:	623.8	(597) ^{QF}							
Serien:	103.5	103.7	103.7	103.6	104.6	104.7			
Zaehler:	57	3	0	0	0	0	0	0	0
Innenzehner:	46								
weiteste:	377 (35), 281 (32), 278 (11)								
beste Teiler	40.8 (34.) 47.8 (54.) 54.4 (27.)								
Trefferlage	0.23 mm rechts, 0.25 mm hoch								
Streuwert	1.08, horizontal: 1.18, vertikal: 0.97								

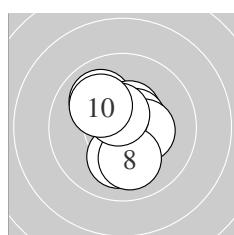
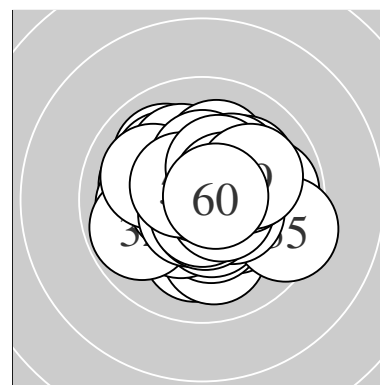

Serie 1:	10.7 *	10.0 ↖	10.5 *	10.6 *	10.5 *
	10.1 ↓	10.4 *	10.0 ↓	10.6 *	10.1 ↖
beste Teiler	67.6 (1.) 96.4 (9.) 99.1 (4.)				
Trefferlage	0.06 mm rechts, 0.11 mm hoch				
Streuwert	1.23, horizontal: 1.01, vertikal: 1.42				

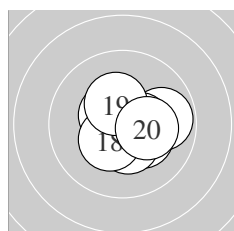

Serie 2:	9.8 →	10.3 *	10.6 *	10.5 *	10.6 *
	10.4 *	10.5 *	10.4 *	10.3 *	10.3 *
beste Teiler	83.5 (13.) 89.1 (15.) 110.4 (17.)				
Trefferlage	0.57 mm rechts, 0.06 mm tief				
Streuwert	1.07, horizontal: 1.22, vertikal: 0.89				

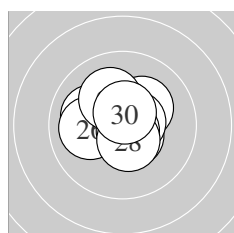

Serie 3:	10.2 *	10.5 *	10.5 *	10.6 *	10.0 ↖
	10.0 ←	10.7 *	10.5 *	10.1 ↖	10.6 *
beste Teiler	54.4 (27.) 85.6 (24.) 91.2 (30.)				
Trefferlage	0.17 mm links, 0.35 mm hoch				
Streuwert	1.10, horizontal: 1.24, vertikal: 0.94				

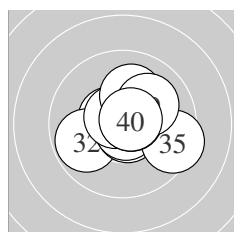

Serie 4:	10.6 *	9.8 ↖	10.7 *	10.8 *	9.4 →
	10.7 *	10.7 *	10.1 ↑	10.1 ↗	10.7 *
beste Teiler	40.8 (34.) 61.6 (33.) 65.8 (40.)				
Trefferlage	0.37 mm rechts, 0.16 mm hoch				
Streuwert	1.35, horizontal: 1.61, vertikal: 1.03				

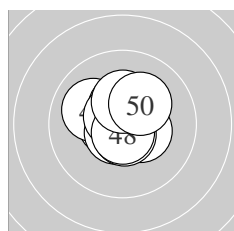

Serie 5:	10.6 *	10.0 ↖	10.6 *	10.4 *	10.5 *
	10.6 *	10.7 *	10.7 *	10.3 *	10.2 *
beste Teiler	61.0 (48.) 75.3 (47.) 76.3 (46.)				
Trefferlage	0.15 mm links, 0.33 mm hoch				
Streuwert	0.96, horizontal: 0.99, vertikal: 0.93				

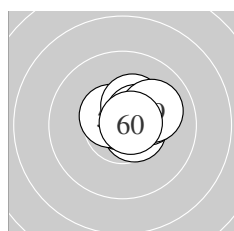

Serie 6:	10.6 *	10.6 *	10.5 *	10.8 *	10.2 *
	10.5 *	10.3 *	10.5 *	10.0 →	10.7 *
beste Teiler	47.8 (54.) 60.1 (60.) 81.2 (51.)				
Trefferlage	0.71 mm rechts, 0.62 mm hoch				
Streuwert	0.68, horizontal: 0.83, vertikal: 0.50				

Meyton Elektronik

ISSF AR Men – Wertung – Männer

StandNr: 124

Mathis, Thomas #266

StartNr: 58

24. Januar 2017 11:48

AUT

QF – Schütze hat sich fürs Finale qualifiziert

Unterschrift des Schuetzen

Meyton Elektronik

Ergebnis:	622.7	(595)					
Serien:	104.9	103.6	103.5	103.8	103.4	103.5	
Zaehler:	55	5	0	0	0	0	0
Innenzehner:	46						
weiteste:	305 (13), 288 (43), 262 (55)						
beste Teiler	43.9 (34.) 57.2 (40.) 64.5 (57.)						
Trefferlage	0.19 mm links, 0.01 mm hoch						
Streuwert	1.12, horizontal: 1.26, vertikal: 0.97						

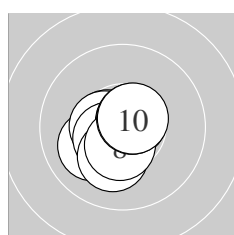
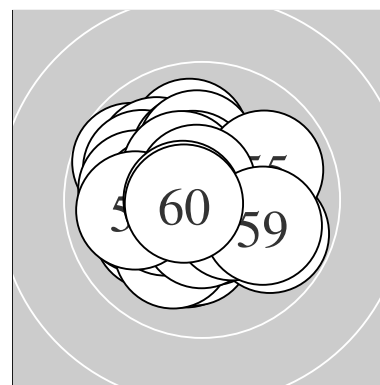

Serie 1:					
10.1 ↙	10.6 *	10.5 *	10.6 *	10.5 *	
10.2 *	10.7 *	10.5 *	10.6 *	10.6 *	
beste Teiler	65.2 (7.) 80.0 (9.) 83.4 (4.)				
Trefferlage	0.45 mm links, 0.37 mm tief				
Streuwert	0.83, horizontal: 0.84, vertikal: 0.83				

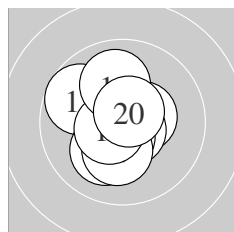

Serie 2:					
10.5 *	10.6 *	9.7 ↘	10.7 *	10.6 *	
10.1 ↘	10.2 *	10.6 *	10.0 ↑	10.6 *	
beste Teiler	72.1 (14.) 78.0 (20.) 82.7 (12.)				
Trefferlage	0.36 mm links, 0.02 mm hoch				
Streuwert	1.21, horizontal: 1.06, vertikal: 1.35				

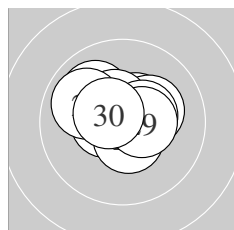

Serie 3:					
10.0 ↘	10.5 *	10.5 *	10.2 *	10.5 *	
9.9 ↘	10.4 *	10.5 *	10.5 *	10.5 *	
beste Teiler	105.0 (22.) 105.1 (30.) 106.6 (28.)				
Trefferlage	0.11 mm links, 0.54 mm hoch				
Streuwert	1.10, horizontal: 1.37, vertikal: 0.75				

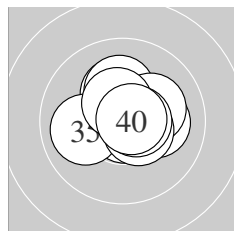

Serie 4:					
10.1 →	10.2 *	10.2 *	10.8 *	10.0 ←	
10.2 *	10.5 *	10.5 *	10.6 *	10.7 *	
beste Teiler	43.9 (34.) 57.2 (40.) 87.0 (39.)				
Trefferlage	0.30 mm rechts, 0.40 mm hoch				
Streuwert	1.11, horizontal: 1.26, vertikal: 0.93				

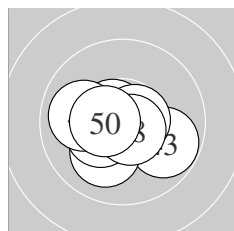

Serie 5:					
10.6 *	10.4 *	9.8 ↘	10.4 *	10.6 *	
10.1 ↘	10.3 *	10.7 *	10.0 ←	10.5 *	
beste Teiler	70.0 (48.) 78.0 (41.) 79.0 (45.)				
Trefferlage	0.48 mm links, 0.48 mm tief				
Streuwert	1.15, horizontal: 1.42, vertikal: 0.78				

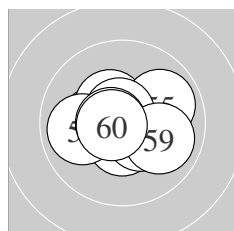

Serie 6:					
10.5 *	10.3 *	10.4 *	10.4 *	9.9 →	
9.9 ←	10.7 *	10.7 *	10.0 →	10.7 *	
beste Teiler	64.5 (57.) 70.4 (60.) 74.0 (58.)				
Trefferlage	0.08 mm links, 0.04 mm tief				
Streuwert	1.27, horizontal: 1.60, vertikal: 0.82				

Meyton Elektronik

ISSF AR Men – Wertung – **Männer**

StandNr: 125

Sampson, Dane #70804688

StartNr: 59

24. Januar 2017 11:39

Australia

Unterschrift des Schuetzen

Meyton Elektronik

Ergebnis:	615.9	(587)							
Serien:	103.2	101.7	100.3	103.0	103.5	104.2			
Zaehler:	48	11	1	0	0	0	0	0	0
Innenzehner:	42								
weiteste:	504 (15), 431 (23), 421 (28)								
beste Teiler	21.1 (17.)	27.1 (42.)	37.1 (59.)						
Trefferlage	0.25 mm links, 0.40 mm hoch								
Streuwert	1.40, horizontal: 1.67, vertikal: 1.05								

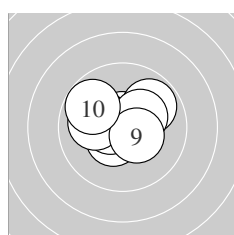
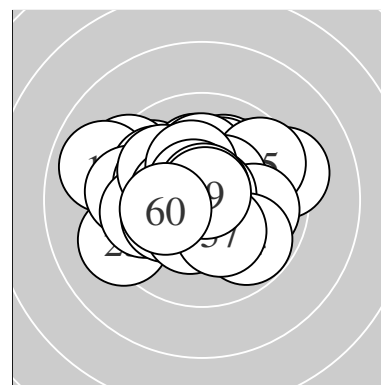

Serie 1:	10.7 *	10.8 *	10.5 *	10.6 *	10.2 *
	9.9 ↗	10.0 ←	10.3 *	10.4 *	9.8 ↘
beste Teiler	41.0 (2.) 66.1 (1.) 99.0 (4.)				
Trefferlage	0.34 mm links, 0.39 mm hoch				
Streuwert	1.29, horizontal: 1.58, vertikal: 0.91				

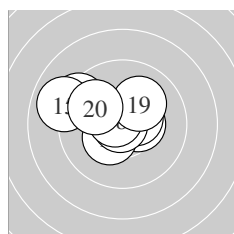

Serie 2:	10.4 *	10.6 *	10.4 *	9.3 ↘	8.9 ↘
	10.5 *	10.9 *	10.7 *	10.1 ↗	9.9 ↘
beste Teiler	21.1 (17.) 71.8 (18.) 82.5 (12.)				
Trefferlage	0.85 mm links, 0.70 mm hoch				
Streuwert	1.63, horizontal: 2.09, vertikal: 0.95				

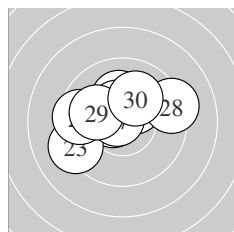

Serie 3:	10.2 *	10.6 *	9.2 ↙	10.4 *	9.5 ←
	10.3 *	10.7 *	9.3 →	10.0 ↖	10.1 ↗
beste Teiler	53.3 (27.) 79.6 (22.) 127.3 (24.)				
Trefferlage	0.54 mm links, 0.73 mm hoch				
Streuwert	1.82, horizontal: 2.30, vertikal: 1.14				

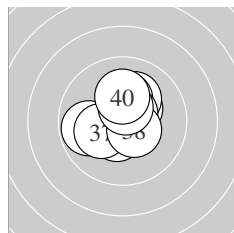

Serie 4:	10.4 *	10.1 ↗	9.8 ←	10.5 *	10.2 *
	10.6 *	10.2 *	10.5 *	10.5 *	10.2 *
beste Teiler	88.3 (36.) 113.7 (39.) 115.5 (34.)				
Trefferlage	0.09 mm links, 0.51 mm hoch				
Streuwert	1.23, horizontal: 1.25, vertikal: 1.20				

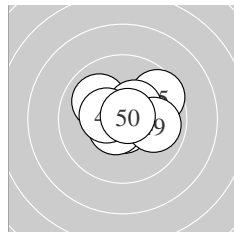

Serie 5:	10.3 *	10.8 *	10.0 ↖	10.7 *	9.6 ↗
	10.6 *	10.4 *	10.4 *	9.9 →	10.8 *
beste Teiler	27.1 (42.) 48.8 (50.) 56.7 (44.)				
Trefferlage	0.42 mm rechts, 0.37 mm hoch				
Streuwert	1.25, horizontal: 1.55, vertikal: 0.84				

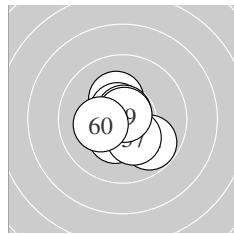

Serie 6:	10.3 *	10.5 *	10.7 *	9.8 ↘	10.4 *
	10.6 *	10.2 *	10.7 *	10.8 *	10.2 *
beste Teiler	37.1 (59.) 52.7 (58.) 67.7 (53.)				
Trefferlage	0.13 mm links, 0.30 mm tief				
Streuwert	1.11, horizontal: 1.09, vertikal: 1.12				

Meyton Elektronik

ISSF AR Men – Wertung – Männer

StandNr: 126

Friman,, Cristian #70804640

StartNr: 60

24. Januar 2017 11:53

F – Esbo Skytteförening

Unterschrift des Schuetzen

Meyton Elektronik

Ergebnis: **619.6** (591)
 Serien: 102.9 104.4 101.1 104.7 104.2 102.3
 Zaehler: 51 9 0 0 0 0 0 0 0 0
 Innenzehner: 44
 weiteste: 488 (25), 359 (10), 342 (22)
 beste Teiler 37.0 (38.) 42.7 (26.) 56.2 (17.)
 Trefferlage 0.23 mm rechts, 0.04 mm tief
 Streuwert 1.28, horizontal: 1.52, vertikal: 0.99

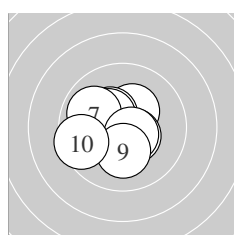
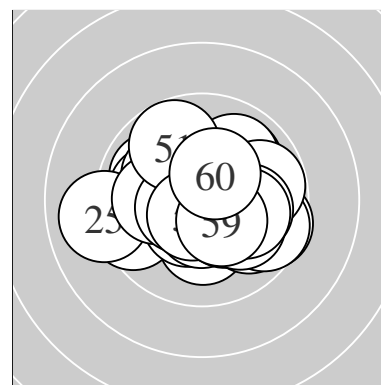

Serie 1:
 10.3 * 10.4 * 10.5 * 10.5 * 10.6 *
 10.4 * 9.9 ↖ 10.6 * 10.2 * 9.5 ←
 beste Teiler 79.3 (5.) 92.9 (8.) 110.9 (3.)
 Trefferlage 0.65 mm links, 0.03 mm tief
 Streuwert 1.29, horizontal: 1.42, vertikal: 1.15

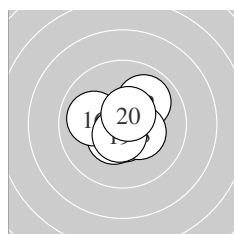

Serie 2:
 10.6 * 10.0 ↗ 10.6 * 10.4 * 10.5 *
 10.0 ← 10.7 * 10.4 * 10.6 * 10.6 *
 beste Teiler 56.2 (17.) 86.9 (11.) 91.7 (19.)
 Trefferlage 0.10 mm rechts, 0.21 mm tief
 Streuwert 1.06, horizontal: 1.17, vertikal: 0.94

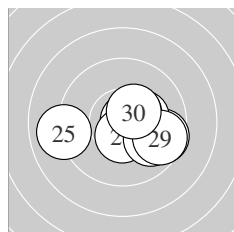

Serie 3:
 10.4 * 9.6 → 10.3 * 10.5 * 9.0 ←
 10.8 * 10.5 * 9.9 ↘ 9.6 → 10.5 *
 beste Teiler 42.7 (26.) 111.0 (27.) 121.4 (24.)
 Trefferlage 0.88 mm rechts, 0.43 mm tief
 Streuwert 1.72, horizontal: 2.27, vertikal: 0.87

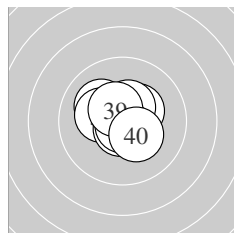

Serie 4:
 10.4 * 10.6 * 10.1 ↖ 10.2 * 10.6 *
 10.7 * 10.5 * 10.8 * 10.5 * 10.3 *
 beste Teiler 37.0 (38.) 67.1 (36.) 89.4 (35.)
 Trefferlage 0.21 mm links, 0.40 mm hoch
 Streuwert 0.92, horizontal: 1.02, vertikal: 0.81

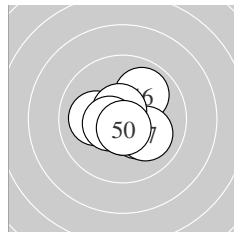

Serie 5:
 10.6 * 10.6 * 10.1 ← 10.3 * 10.7 *
 9.9 ↗ 10.1 ↘ 10.7 * 10.5 * 10.7 *
 beste Teiler 67.0 (45.) 71.3 (48.) 73.5 (50.)
 Trefferlage 0.19 mm rechts, 0.27 mm tief
 Streuwert 1.10, horizontal: 1.22, vertikal: 0.96

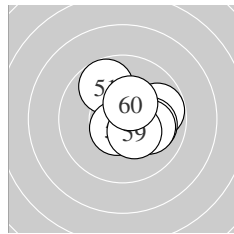

Serie 6:
 9.8 ↖ 10.6 * 10.4 * 10.2 * 9.8 →
 10.6 * 10.0 → 10.1 → 10.4 * 10.4 *
 beste Teiler 87.6 (56.) 89.6 (52.) 140.7 (59.)
 Trefferlage 1.09 mm rechts, 0.28 mm hoch
 Streuwert 1.21, horizontal: 1.28, vertikal: 1.12

Meyton Elektronik

ISSF AR Men – Wertung – **Männer**

StandNr: 127

Rumpler, Stefan #112

StartNr: 61

24. Januar 2017 11:56

AUT

Unterschrift des Schuetzen

Meyton Elektronik

Ergebnis: **616.2** (587)
 Serien: 103.0 105.2 101.0 102.6 101.4 103.0
 Zaehler: 47 13 0 0 0 0 0 0 0
 Innenzehner: 35
 weiteste: 400 (29), 364 (25), 318 (22)
 beste Teiler 52.1 (32.) 57.2 (18.) 57.6 (54.)
 Trefferlage 0.17 mm links, 0.16 mm hoch
 Streuwert 1.36, horizontal: 1.33, vertikal: 1.39

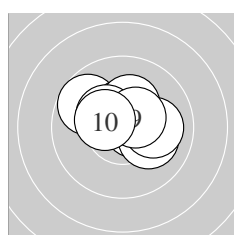
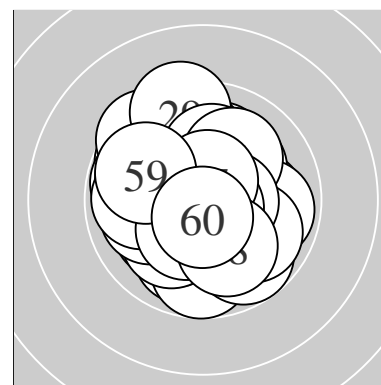

Serie 1:
 10.5 * 10.6 * 9.7 ↖ 10.1 ↗ 10.5 *
 10.3 * 10.0 → 10.4 * 10.5 * 10.4 *
 beste Teiler 86.0 (2.) 118.3 (1.) 119.4 (9.)
 Trefferlage 0.19 mm rechts, 0.68 mm hoch
 Streuwert 1.20, horizontal: 1.51, vertikal: 0.79

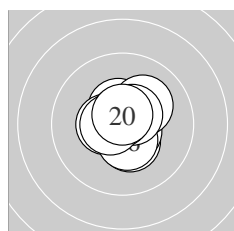

Serie 2:
 10.5 * 10.4 * 10.6 * 10.5 * 10.1 ↗
 10.5 * 10.6 * 10.7 * 10.6 * 10.7 *
 beste Teiler 57.2 (18.) 70.0 (20.) 84.5 (13.)
 Trefferlage 0.10 mm rechts, 0.14 mm hoch
 Streuwert 0.86, horizontal: 0.81, vertikal: 0.91

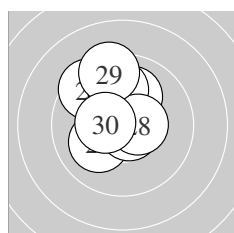

Serie 3:
 10.1 ↙ 9.7 ↖ 10.1 ↑ 10.7 * 9.5 ↖
 10.7 * 9.9 ↑ 10.5 * 9.4 ↑ 10.4 *
 beste Teiler 61.8 (24.) 71.8 (26.) 113.0 (28.)
 Trefferlage 0.62 mm links, 1.33 mm hoch
 Streuwert 1.46, horizontal: 1.15, vertikal: 1.70

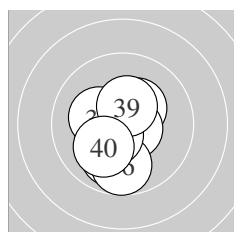

Serie 4:
 10.3 * 10.7 * 10.6 * 10.1 ↓ 10.0 ↓
 9.7 ↓ 10.5 * 10.2 * 10.4 * 10.1 ↙
 beste Teiler 52.1 (32.) 79.6 (33.) 109.2 (37.)
 Trefferlage 0.35 mm links, 0.78 mm tief
 Streuwert 1.24, horizontal: 0.91, vertikal: 1.49

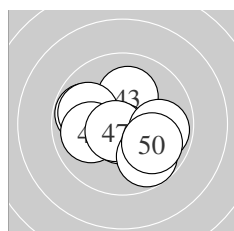

Serie 5:
 10.6 * 9.8 ↖ 10.1 ↑ 9.9 ↖ 10.0 ←
 10.7 * 10.7 * 9.8 ↘ 9.9 → 9.9 ↘
 beste Teiler 71.3 (46.) 74.2 (47.) 99.2 (41.)
 Trefferlage 0.21 mm links, 0.20 mm tief
 Streuwert 1.66, horizontal: 1.98, vertikal: 1.25

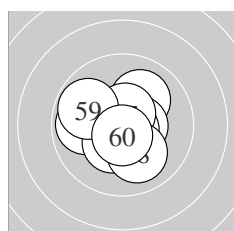

Serie 6:
 10.1 ↗ 10.4 * 10.5 * 10.7 * 9.9 ←
 10.4 * 10.6 * 10.0 ↘ 9.8 ↖ 10.6 *
 beste Teiler 57.6 (54.) 77.0 (60.) 87.0 (57.)
 Trefferlage 0.17 mm links, 0.19 mm tief
 Streuwert 1.33, horizontal: 1.43, vertikal: 1.22

Meyton Elektronik

ISSF AR Men – Wertung – Männer

StandNr: 128

Bale, Jack #70804689

StartNr: 62

24. Januar 2017 12:01

GBR

Unterschrift des Schuetzen

Meyton Elektronik

Ergebnis:	628.1	(595) ^{QF}			
Serien:	102.7	105.5	105.6	104.4	104.5 105.4
Zaehler:	55	5	0	0	0 0 0 0 0
Innenzehner:	51				
weiteste:	399	(1), 293	(4), 291	(11)	
beste Teiler	5.0	(17.)	9.0	(20.)	10.8
Trefferlage	0.01	mm rechts,	0.26	mm hoch	
Streuwert	1.01,	horizontal:	1.09,	vertikal:	0.92

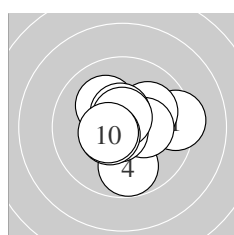
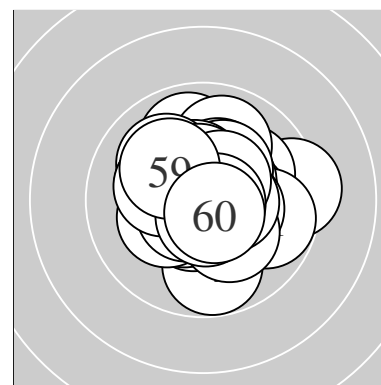

Serie 1:

9.4 →	10.1 ↘	10.1 ↗	9.8 ↓	10.3 *	
10.5 *	10.8 *	10.7 *	10.5 *	10.5 *	
beste Teiler	50.9	(7.)	73.1	(8.)	
Trefferlage	0.39	mm rechts,	0.07	mm hoch	
Streuwert	1.47,	horizontal:	1.64,	vertikal:	1.28

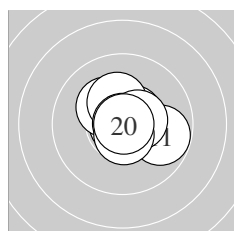

Serie 2:

9.8 ↘	10.9 *	10.8 *	10.6 *	10.2 *	
10.3 *	10.9 *	10.5 *	10.6 *	10.9 *	
beste Teiler	5.0	(17.)	9.0	(20.)	
Trefferlage	0.32	mm rechts,	0.25	mm hoch	
Streuwert	0.94,	horizontal:	1.08,	vertikal:	0.78

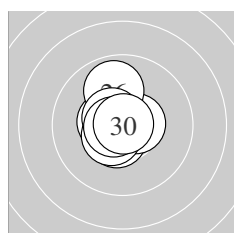

Serie 3:

10.7 *	10.7 *	10.5 *	10.6 *	10.5 *	
9.9 ↑	10.5 *	10.6 *	10.7 *	10.9 *	
beste Teiler	10.8	(30.)	51.9	(22.)	
Trefferlage	0.38	mm links,	0.23	mm hoch	
Streuwert	0.80,	horizontal:	0.62,	vertikal:	0.95

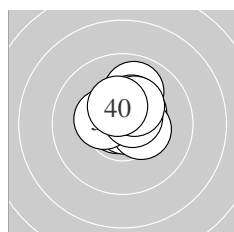

Serie 4:

10.8 *	9.9 ↑	10.4 *	10.9 *	10.3 *	
10.4 *	10.4 *	10.6 *	10.3 *	10.4 *	
beste Teiler	18.0	(34.)	40.3	(31.)	
Trefferlage	0.35	mm rechts,	0.78	mm hoch	
Streuwert	0.85,	horizontal:	0.85,	vertikal:	0.85

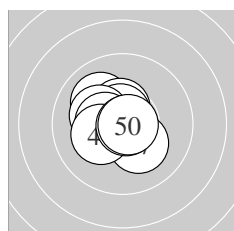

Serie 5:

10.0 ↘	10.5 *	10.6 *	10.2 *	10.8 *	
10.4 *	10.2 *	10.2 *	10.8 *	10.8 *	
beste Teiler	28.6	(49.)	40.8	(45.)	
Trefferlage	0.51	mm links,	0.18	mm hoch	
Streuwert	0.96,	horizontal:	1.01,	vertikal:	0.90

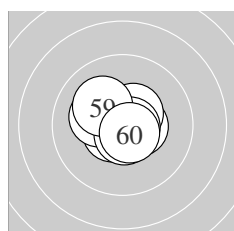

Serie 6:

10.8 *	10.5 *	10.5 *	10.7 *	10.7 *	
10.6 *	10.2 *	10.7 *	10.1 ↘	10.6 *	
beste Teiler	42.4	(51.)	57.2	(55.)	
Trefferlage	0.10	mm links,	0.04	mm hoch	
Streuwert	0.86,	horizontal:	0.99,	vertikal:	0.70

Meyton Elektronik

ISSF AR Men – Wertung – Männer

StandNr: 129

Zott, Georg #70804306

StartNr: 63

24. Januar 2017 11:38

AUT

QF – Schütze hat sich fürs Finale qualifiziert

Unterschrift des Schuetzen

Meyton Elektronik

Ergebnis:	624.7	(597) ^{QF}							
Serien:	104.1	104.9	104.3	104.7	102.6	104.1			
Zaehler:	57	3	0	0	0	0	0	0	0
Innenzehner:	50								
weiteste:	318 (57), 281 (47), 259 (48)								
beste Teiler	12.5 (26.)	17.8 (33.)	36.6 (52.)						
Trefferlage	0.09 mm links, 0.32 mm tief								
Streuwert	1.03, horizontal: 1.15, vertikal: 0.89								

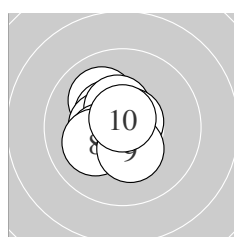
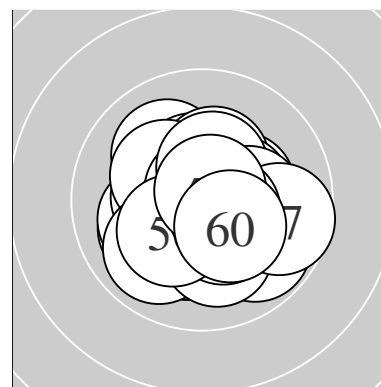

Serie 1:	10.0 ↘	10.4 *	10.4 *	10.8 *	10.4 *
	10.7 *	10.3 *	10.1 ↙	10.3 *	10.7 *
beste Teiler	45.0 (4.)	59.0 (10.)	62.2 (6.)		
Trefferlage	0.67 mm links, 0.19 mm hoch				
Streuwert	0.93, horizontal: 0.84, vertikal: 1.01				

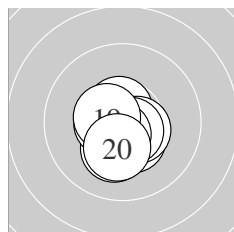

Serie 2:	10.4 *	10.7 *	10.2 *	10.6 *	10.5 *
	10.5 *	10.6 *	10.6 *	10.5 *	10.3 *
beste Teiler	57.4 (12.)	76.5 (17.)	84.2 (14.)		
Trefferlage	0.19 mm links, 0.51 mm tief				
Streuwert	0.78, horizontal: 0.69, vertikal: 0.87				

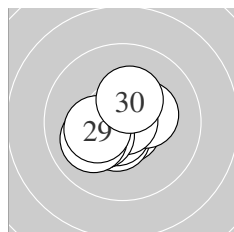

Serie 3:	10.7 *	10.5 *	10.3 *	10.6 *	10.3 *
	10.9 *	10.3 *	10.1 ↙	10.3 *	10.3 *
beste Teiler	12.5 (26.)	56.6 (21.)	78.0 (24.)		
Trefferlage	0.47 mm links, 0.34 mm tief				
Streuwert	0.98, horizontal: 1.11, vertikal: 0.82				

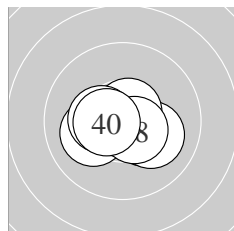

Serie 4:	10.1 ↙	10.6 *	10.9 *	10.3 *	10.1 ↘
	10.5 *	10.7 *	10.6 *	10.4 *	10.5 *
beste Teiler	17.8 (33.)	72.7 (37.)	77.7 (32.)		
Trefferlage	0.19 mm links, 0.24 mm tief				
Streuwert	0.98, horizontal: 1.29, vertikal: 0.50				

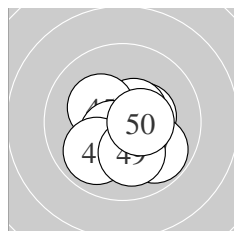

Serie 5:	10.1 ↙	10.4 *	10.4 *	10.6 *	10.3 *
	10.5 *	9.8 ↘	9.9 ↙	10.1 ↓	10.5 *
beste Teiler	99.8 (44.)	103.2 (46.)	120.0 (50.)		
Trefferlage	0.19 mm rechts, 0.71 mm tief				
Streuwert	1.27, horizontal: 1.38, vertikal: 1.16				

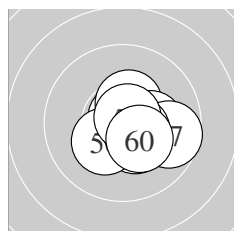

Serie 6:	10.4 *	10.8 *	10.4 *	10.2 *	10.7 *
	10.3 *	9.7 →	10.5 *	10.8 *	10.3 *
beste Teiler	36.6 (52.)	49.5 (59.)	53.2 (55.)		
Trefferlage	0.75 mm rechts, 0.32 mm tief				
Streuwert	0.99, horizontal: 1.15, vertikal: 0.81				

Meyton Elektronik

ISSF AR Men – Wertung – **Männer**

StandNr: 130

Okada, Naoya #70804691

StartNr: 64

24. Januar 2017 11:53

Japan

QF – Schütze hat sich fürs Finale qualifiziert

Unterschrift des Schuetzen

Meyton Elektronik

Ergebnis:	620.8	(596)							
Serien:	102.9	104.3	103.3	103.5	103.8	103.0			
Zähler:	56	4	0	0	0	0	0	0	0
Innenzehner:	46								
weiteste:	448	(8),	302	(34),	281	(53)			
beste Teiler	3.1	(17.)	38.4	(20.)	48.8	(48.)			
Trefferlage	0.02 mm rechts, 0.06 mm hoch								
Streuwert	1.21, horizontal: 1.29, vertikal: 1.11								

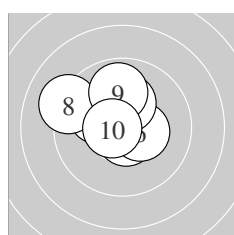
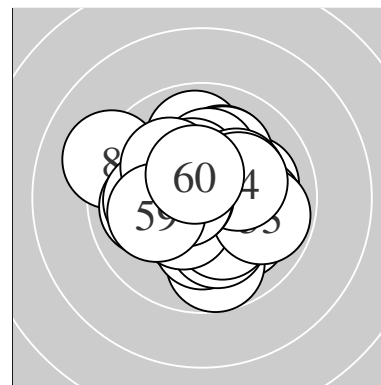

Serie 1:	10.6 *	10.6 *	10.6 *	10.7 *	10.1 ↘
	10.4 *	10.2 *	9.2 ↙	9.9 ↑	10.6 *
beste Teiler	60.9 (4.) 76.8 (2.) 79.5 (10.)				
Trefferlage	0.49 mm links, 0.81 mm hoch				
Streuwert	1.32, horizontal: 1.54, vertikal: 1.05				

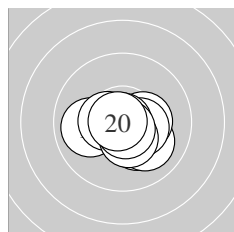

Serie 2:	10.2 *	10.1 ↘	10.0 ←	10.5 *	10.3 *
	10.4 *	10.9 *	10.4 *	10.7 *	10.8 *
beste Teiler	3.1 (17.) 38.4 (20.) 58.6 (19.)				
Trefferlage	0.23 mm rechts, 0.52 mm tief				
Streuwert	1.02, horizontal: 1.31, vertikal: 0.62				

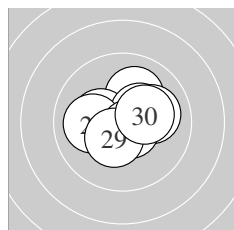

Serie 3:	10.6 *	10.1 ↑	10.6 *	10.3 *	10.4 *
	10.0 ←	10.0 →	10.7 *	10.4 *	10.2 *
beste Teiler	75.6 (28.) 76.4 (21.) 96.8 (23.)				
Trefferlage	0.07 mm rechts, 0.11 mm hoch				
Streuwert	1.22, horizontal: 1.47, vertikal: 0.91				

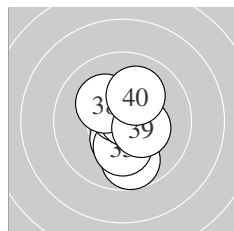

Serie 4:	10.3 *	10.4 *	10.8 *	9.7 ↓	10.2 *
	10.7 *	10.8 *	10.2 *	10.3 *	10.1 ↑
beste Teiler	50.4 (37.) 50.8 (33.) 69.4 (36.)				
Trefferlage	0.08 mm rechts, 0.17 mm tief				
Streuwert	1.26, horizontal: 0.86, vertikal: 1.56				

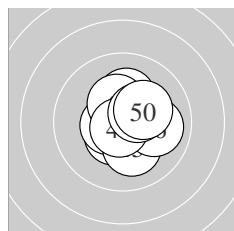

Serie 5:	10.5 *	10.6 *	10.5 *	10.2 *	10.2 *
	10.0 →	10.4 *	10.8 *	10.4 *	10.2 *
beste Teiler	48.8 (48.) 80.0 (42.) 103.0 (43.)				
Trefferlage	0.44 mm rechts, 0.12 mm hoch				
Streuwert	1.10, horizontal: 1.07, vertikal: 1.13				

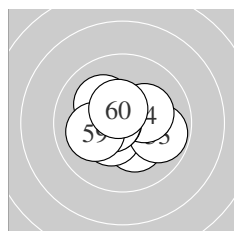

Serie 6:	10.3 *	10.4 *	9.8 →	10.2 *	10.6 *
	10.4 *	10.1 ↘	10.6 *	10.1 ←	10.5 *
beste Teiler	78.4 (55.) 84.0 (58.) 111.9 (60.)				
Trefferlage	0.19 mm links, 0.04 mm hoch				
Streuwert	1.27, horizontal: 1.49, vertikal: 1.01				

Meyton Elektronik

ISSF AR Men – Wertung – Männer

StandNr: 131

Kostenzer, Thomas #70804294

StartNr: 65

24. Januar 2017 11:57

T – SG Münster

Unterschrift des Schuetzen

Meyton Elektronik

Ergebnis: **615.1** (587)
 Serien: 101.5 101.7 100.9 103.7 104.3 103.0
 Zaehler: 47 13 0 0 0 0 0 0 0
 Innenzehner: 38
 weiteste: 468 (20), 402 (8), 333 (38)
 beste Teiler 26.0 (32.) 37.6 (39.) 47.1 (54.)
 Trefferlage 0.14 mm links, 0.08 mm hoch
 Streuwert 1.41, horizontal: 1.70, vertikal: 1.05

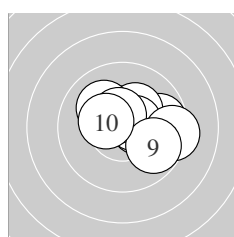
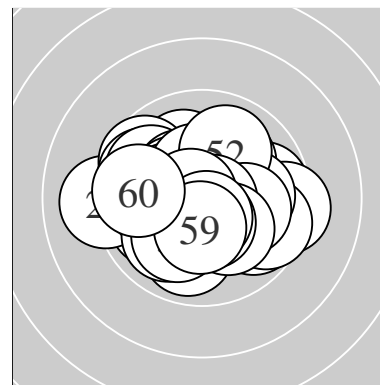

Serie 1:
 10.3 * 9.8 → 10.4 * 10.3 * 10.1 ↘
 10.6 * 10.5 * 9.3 → 9.8 ↘ 10.4 *
 beste Teiler 99.6 (6.) 101.1 (7.) 128.0 (3.)
 Trefferlage 0.83 mm rechts, 0.45 mm hoch
 Streuwert 1.50, horizontal: 1.91, vertikal: 0.94

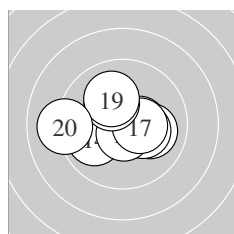

Serie 2:
 10.4 * 10.6 * 10.0 → 9.9 ↙ 10.3 *
 10.7 * 10.4 * 10.2 * 10.1 ↗ 9.1 ←
 beste Teiler 74.6 (16.) 91.5 (12.) 132.0 (11.)
 Trefferlage 0.13 mm links, 0.00 mm
 Streuwert 1.67, horizontal: 2.12, vertikal: 1.04

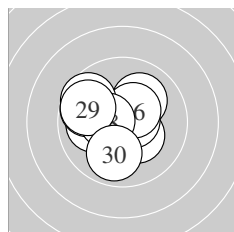

Serie 3:
 10.3 * 10.1 ↗ 10.0 ← 9.8 ↖ 10.6 *
 10.4 * 9.6 ↖ 10.5 * 9.7 ↖ 9.9 ↓
 beste Teiler 79.0 (25.) 125.4 (28.) 127.4 (26.)
 Trefferlage 0.85 mm links, 0.31 mm hoch
 Streuwert 1.57, horizontal: 1.77, vertikal: 1.33

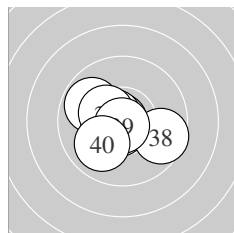

Serie 4:
 10.7 * 10.8 * 9.8 ↖ 10.6 * 10.4 *
 10.6 * 10.4 * 9.6 ↖ 10.8 * 10.0 ↙
 beste Teiler 26.0 (32.) 37.6 (39.) 67.1 (31.)
 Trefferlage 0.56 mm links, 0.31 mm tief
 Streuwert 1.23, horizontal: 1.48, vertikal: 0.91

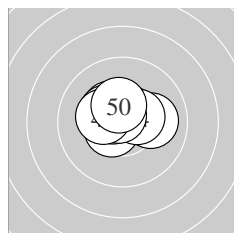

Serie 5:
 10.5 * 10.0 → 10.6 * 10.5 * 10.6 *
 10.4 * 10.3 * 10.7 * 10.3 * 10.4 *
 beste Teiler 61.9 (48.) 86.6 (43.) 91.9 (45.)
 Trefferlage 0.21 mm links, 0.52 mm hoch
 Streuwert 0.93, horizontal: 1.21, vertikal: 0.53

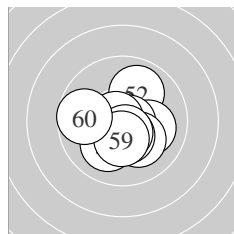

Serie 6:
 10.1 ↙ 9.9 ↗ 10.1 → 10.8 * 10.2 *
 10.7 * 10.5 * 10.6 * 10.4 * 9.7 ←
 beste Teiler 47.1 (54.) 56.7 (56.) 96.1 (58.)
 Trefferlage 0.05 mm rechts, 0.48 mm tief
 Streuwert 1.33, horizontal: 1.45, vertikal: 1.21

Meyton Elektronik

ISSF AR Men – Wertung – Männer

StandNr: 132

Clopatofsky, Daniel #70804637

StartNr: 66

24. Januar 2017 12:07

Australia

Unterschrift des Schuetzen

Meyton Elektronik

ISSF AR Men – Probe – Männer

StartNr: 67

StandNr: 133

24. Januar 2017 9:34

Will, Shaner #70804641

USA

Ergebnis: **0.0** (0)_{DNS}
Serien:
Zähler: 0 0 0 0 0 0 0 0 0 0
Innenzehner: 0
weiteste:
~~beste Teiler~~ – Schütze ist nicht zum Wettkampf angetreten
Trefferlage 0.00 mm , 0.00 mm
Streuwert
Unterschrift des Schuetzen

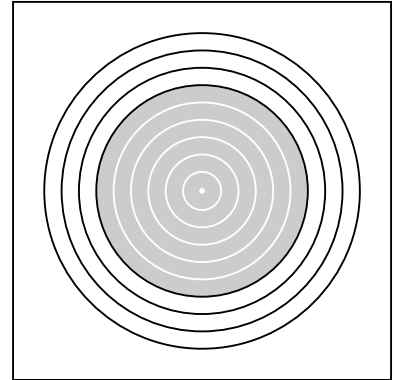

Meyton Elektronik

Ergebnis:	626.7	(597) ^{QF}							
Serien:	105.6	104.7	103.8	104.0	104.2	104.4			
Zähler:	57	3	0	0	0	0	0	0	0
Innenzehner:	51								
weiteste:	315 (25), 270 (45), 270 (55)								
beste Teiler	5.3 (9.) 9.2 (2.) 16.0 (52.)								
Trefferlage	0.14 mm links, 0.27 mm hoch								
Streuwert	1.00, horizontal: 0.92, vertikal: 1.07								

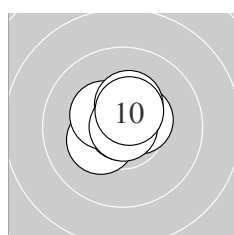
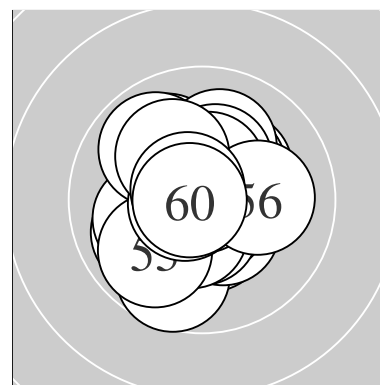

Serie 1:					
	10.3 *	10.9 *	10.5 *	10.7 *	10.6 *
	10.4 *	10.5 *	10.3 *	10.9 *	10.5 *
beste Teiler	5.3 (9.) 9.2 (2.) 67.5 (4.)				
Trefferlage	0.11 mm links, 0.52 mm hoch				
Streuwert	0.71, horizontal: 0.77, vertikal: 0.65				

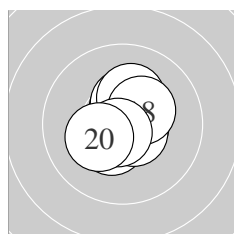

Serie 2:					
	10.5 *	10.4 *	10.6 *	10.7 *	10.6 *
	10.4 *	10.2 *	10.3 *	10.7 *	10.3 *
beste Teiler	63.1 (19.) 67.1 (14.) 81.2 (13.)				
Trefferlage	0.15 mm rechts, 0.20 mm hoch				
Streuwert	0.91, horizontal: 0.82, vertikal: 0.99				

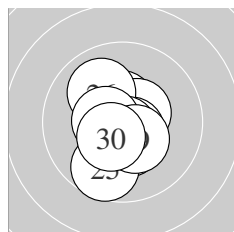

Serie 3:					
	10.5 *	10.4 *	10.5 *	10.6 *	9.7 ↘
	10.0 ↘	10.7 *	10.5 *	10.4 *	10.5 *
beste Teiler	52.2 (27.) 77.9 (24.) 110.3 (28.)				
Trefferlage	0.18 mm links, 0.37 mm tief				
Streuwert	1.15, horizontal: 0.86, vertikal: 1.39				

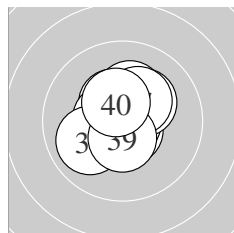

Serie 4:					
	10.7 *	10.8 *	10.2 *	10.4 *	10.5 *
	10.2 *	10.3 *	10.0 ↙	10.5 *	10.4 *
beste Teiler	30.8 (32.) 72.6 (31.) 103.7 (35.)				
Trefferlage	0.07 mm links, 0.37 mm hoch				
Streuwert	1.06, horizontal: 1.02, vertikal: 1.10				

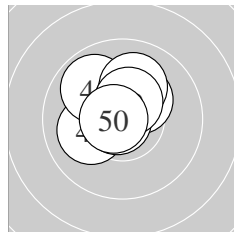

Serie 5:					
	10.8 *	10.4 *	10.6 *	10.1 ↙	9.9 ↘
	10.3 *	10.1 ↗	10.8 *	10.5 *	10.7 *
beste Teiler	36.1 (48.) 43.2 (41.) 59.0 (50.)				
Trefferlage	0.45 mm links, 0.72 mm hoch				
Streuwert	0.99, horizontal: 1.04, vertikal: 0.94				

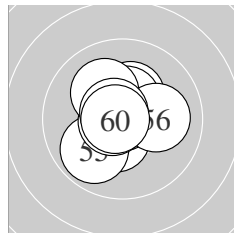

Serie 6:					
	10.4 *	10.9 *	10.3 *	10.5 *	9.9 ↙
	10.1 →	10.7 *	10.1 ↘	10.7 *	10.8 *
beste Teiler	16.0 (52.) 49.0 (60.) 68.6 (57.)				
Trefferlage	0.22 mm links, 0.17 mm hoch				
Streuwert	1.12, horizontal: 1.09, vertikal: 1.16				

Meyton Elektronik

ISSF AR Men – Wertung – Männer

StandNr: 134

Pickl, Bernhard #268

StartNr: 68

24. Januar 2017 11:51

AUT

QF – Schütze hat sich fürs Finale qualifiziert

Unterschrift des Schuetzen

Meyton Elektronik

Ergebnis:	626.7	(595) ^{QF}							
Serien:	103.7	104.3	104.5	105.1	105.3	103.8			
Zaehler:	55	5	0	0	0	0	0	0	0
Innenzehner:	51								
weiteste:	322 (17), 310 (1), 279 (59)								
beste Teiler	23.3 (8.)	32.6 (35.)	40.0 (56.)						
Trefferlage	0.28 mm links, 0.07 mm tief								
Streuwert	1.02, horizontal: 1.10, vertikal: 0.94								

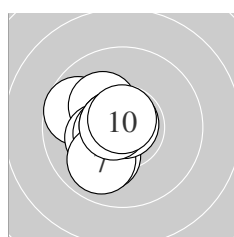
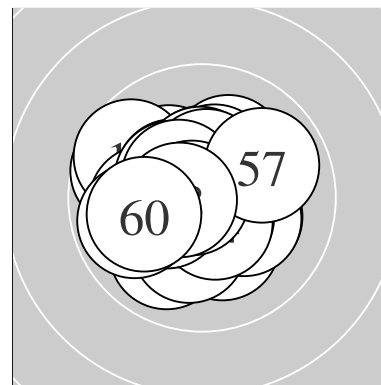

Serie 1:	9.7 ↖	10.1 ↙	10.2 *	10.3 *	10.5 *
	10.7 *	9.9 ↙	10.9 *	10.7 *	10.7 *
beste Teiler	23.3 (8.)	52.1 (10.)	60.0 (6.)		
Trefferlage	1.03 mm links, 0.17 mm tief				
Streuwert	1.01, horizontal: 0.86, vertikal: 1.14				

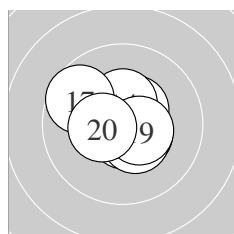

Serie 2:	10.5 *	10.6 *	10.6 *	10.4 *	10.7 *
	10.5 *	9.7 ↖	10.4 *	10.5 *	10.4 *
beste Teiler	69.8 (15.)	95.5 (13.)	98.6 (12.)		
Trefferlage	0.01 mm links, 0.10 mm hoch				
Streuwert	1.11, horizontal: 1.25, vertikal: 0.95				

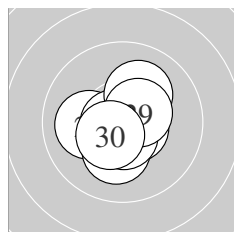

Serie 3:	10.6 *	10.6 *	10.1 ←	10.6 *	10.7 *
	10.2 *	10.6 *	10.1 ↗	10.5 *	10.5 *
beste Teiler	55.3 (25.)	77.4 (22.)	85.4 (24.)		
Trefferlage	0.12 mm links, 0.17 mm tief				
Streuwert	1.00, horizontal: 1.02, vertikal: 0.98				

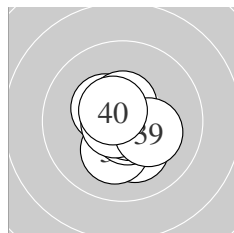

Serie 4:	10.2 *	10.2 *	10.4 *	10.7 *	10.8 *
	10.7 *	10.8 *	10.5 *	10.2 *	10.6 *
beste Teiler	32.6 (35.)	50.5 (37.)	57.4 (36.)		
Trefferlage	0.08 mm rechts, 0.30 mm tief				
Streuwert	0.91, horizontal: 0.82, vertikal: 1.00				

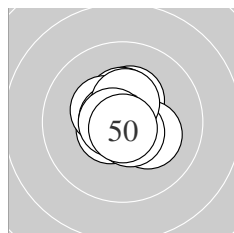

Serie 5:	10.4 *	10.2 *	10.6 *	10.4 *	10.4 *
	10.7 *	10.6 *	10.5 *	10.7 *	10.8 *
beste Teiler	42.0 (50.)	64.5 (46.)	65.0 (49.)		
Trefferlage	0.04 mm links, 0.25 mm hoch				
Streuwert	0.85, horizontal: 0.82, vertikal: 0.87				

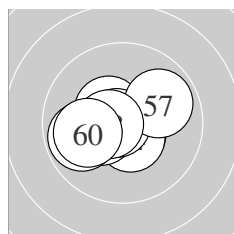

Serie 6:	10.6 *	10.7 *	10.5 *	10.5 *	10.4 *
	10.8 *	9.9 ↗	10.6 *	9.8 ←	10.0 ←
beste Teiler	40.0 (56.)	61.4 (52.)	88.3 (58.)		
Trefferlage	0.56 mm links, 0.16 mm tief				
Streuwert	1.16, horizontal: 1.46, vertikal: 0.75				

Meyton Elektronik

ISSF AR Men – Wertung – **Männer**

StandNr: 135

Loretan, Pascal #70804308

StartNr: 69

24. Januar 2017 12:06

Switzerland

QF – Schütze hat sich fürs Finale qualifiziert

Unterschrift des Schuetzen

Meyton Elektronik

Ergebnis:	614.5	(589)
Serien:	100.9	103.9 103.0 101.7 101.9 103.1
Zaehler:	49 11 0 0 0 0 0 0 0	
Innenzehner:	36	
weiteste:	482 (33), 395 (3), 342 (48)	
beste Teiler	10.8 (43.)	50.4 (15.) 53.1 (24.)
Trefferlage	0.00 mm , 0.22 mm tief	
Streuwert	1.43, horizontal: 1.70, vertikal: 1.09	

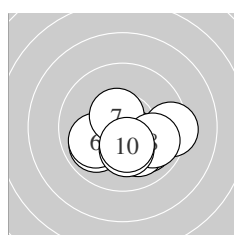
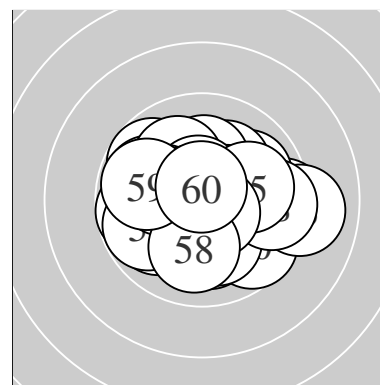

Serie 1:

10.0 ↘	10.1 ↘	9.4 →	9.9 ↙	10.5 *
10.0 ↙	10.5 *	9.9 ↘	10.2 *	10.4 *
beste Teiler	105.5 (7.) 125.8 (5.) 149.1 (10.)			
Trefferlage	0.63 mm rechts, 1.03 mm tief			
Streuwert	1.49, horizontal: 1.93, vertikal: 0.84			

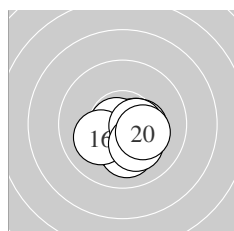

Serie 2:

10.4 *	10.1 ↓	10.7 *	10.5 *	10.8 *
10.1 ↙	10.4 *	10.5 *	10.2 *	10.2 *
beste Teiler	50.4 (15.) 53.8 (13.) 107.7 (14.)			
Trefferlage	0.45 mm rechts, 0.77 mm tief			
Streuwert	0.92, horizontal: 1.06, vertikal: 0.75			

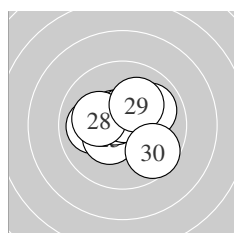

Serie 3:

10.0 ↗	10.0 ←	10.7 *	10.7 *	10.4 *
10.6 *	10.6 *	10.2 *	10.1 ↗	9.7 ↘
beste Teiler	53.1 (24.) 59.0 (23.) 83.1 (27.)			
Trefferlage	0.05 mm links, 0.06 mm hoch			
Streuwert	1.39, horizontal: 1.61, vertikal: 1.13			

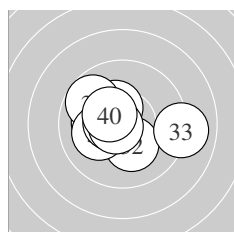

Serie 4:

10.5 *	10.2 *	9.0 →	10.4 *	10.2 *
9.7 ↘	10.1 ↙	10.5 *	10.7 *	10.4 *
beste Teiler	59.4 (39.) 101.4 (38.) 115.2 (31.)			
Trefferlage	0.47 mm links, 0.19 mm hoch			
Streuwert	1.63, horizontal: 2.06, vertikal: 1.03			

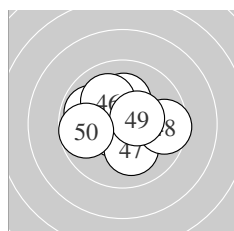

Serie 5:

9.9 ↙	10.3 *	10.9 *	10.2 *	10.7 *
10.1 ↘	10.1 ↓	9.6 →	10.4 *	9.7 ←
beste Teiler	10.8 (43.) 75.7 (45.) 127.5 (49.)			
Trefferlage	0.05 mm links, 0.12 mm hoch			
Streuwert	1.60, horizontal: 1.91, vertikal: 1.21			

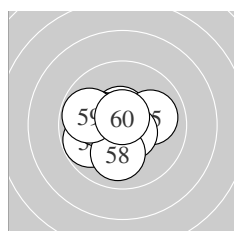

Serie 6:

10.7 *	10.6 *	9.8 ↙	10.2 *	10.0 →
10.7 *	10.6 *	10.0 ↓	9.8 ↙	10.7 *
beste Teiler	64.1 (60.) 66.4 (56.) 69.0 (51.)			
Trefferlage	0.53 mm links, 0.04 mm hoch			
Streuwert	1.32, horizontal: 1.53, vertikal: 1.07			

ISSF AR Men – Wertung – **Männer**

StandNr: 136

Anrain, Julian #70804301

StartNr: 70

24. Januar 2017 12:00

T – SG Münster

Unterschrift des Schuetzen

Meyton Elektronik

Ergebnis:	617.9	(593)							
Serien:	102.3	102.5	103.2	103.5	103.8	102.6			
Zaehler:	53	7	0	0	0	0	0	0	0
Innenzehner:	42								
weiteste:	365 (14), 308 (57), 303 (30)								
beste Teiler	19.8 (35.) 40.7 (51.) 48.5 (5.)								
Trefferlage	0.14 mm rechts, 0.23 mm hoch								
Streuwert	1.26, horizontal: 1.39, vertikal: 1.12								

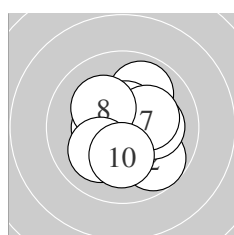
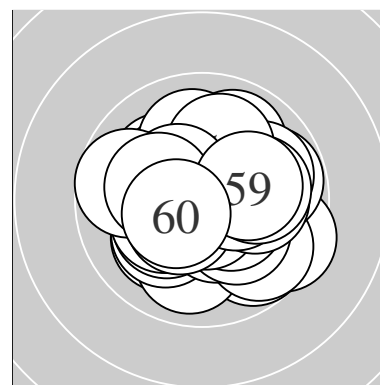

Serie 1:

9.9 ↗	9.8 ↘	10.1 →	10.6 *	10.8 *
10.4 *	10.2 *	10.2 *	10.1 ↙	10.2 *
beste Teiler	48.5 (5.) 96.1 (4.) 129.0 (6.)			
Trefferlage	0.26 mm rechts, 0.03 mm tief			
Streuwert	1.44, horizontal: 1.43, vertikal: 1.45			

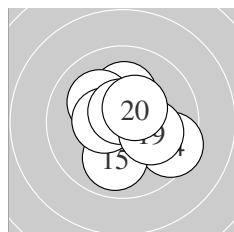

Serie 2:

10.5 *	10.5 *	10.2 *	9.5 ↘	10.0 ↓
10.1 ↖	10.5 *	10.7 *	10.1 →	10.4 *
beste Teiler	73.5 (18.) 117.1 (11.) 117.7 (12.)			
Trefferlage	0.03 mm rechts, 0.06 mm hoch			
Streuwert	1.46, horizontal: 1.58, vertikal: 1.33			

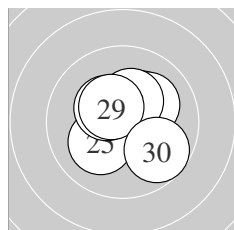

Serie 3:

10.7 *	10.6 *	10.3 *	10.6 *	10.1 ↙
10.4 *	10.1 ↗	10.3 *	10.4 *	9.7 ↘
beste Teiler	71.4 (21.) 85.0 (24.) 94.3 (22.)			
Trefferlage	0.43 mm rechts, 0.31 mm hoch			
Streuwert	1.21, horizontal: 1.23, vertikal: 1.18			

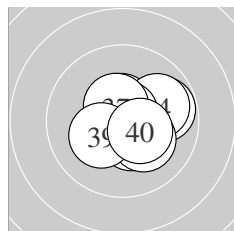

Serie 4:

10.5 *	9.8 →	10.4 *	9.9 →	10.9 *
10.7 *	10.5 *	10.2 *	10.2 *	10.4 *
beste Teiler	19.8 (35.) 55.7 (36.) 103.4 (31.)			
Trefferlage	0.64 mm rechts, 0.01 mm hoch			
Streuwert	1.15, horizontal: 1.31, vertikal: 0.97			

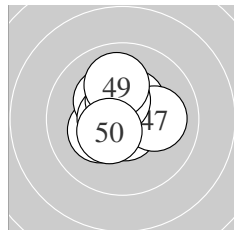

Serie 5:

10.3 *	10.7 *	10.5 *	10.3 *	10.6 *
10.4 *	10.1 →	10.4 *	10.0 ↑	10.5 *
beste Teiler	65.5 (42.) 89.1 (45.) 119.4 (43.)			
Trefferlage	0.27 mm links, 0.49 mm hoch			
Streuwert	1.08, horizontal: 1.08, vertikal: 1.07			

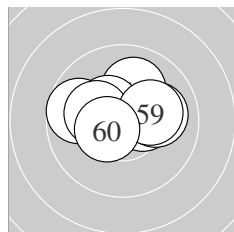

Serie 6:

10.8 *	10.4 *	10.0 →	10.4 *	10.0 ↑
10.4 *	9.7 ←	10.2 *	10.2 *	10.5 *
beste Teiler	40.7 (51.) 121.2 (60.) 133.8 (56.)			
Trefferlage	0.21 mm links, 0.56 mm hoch			
Streuwert	1.31, horizontal: 1.73, vertikal: 0.69			

ISSF AR Men – Wertung – **Männer**

StandNr: 137

Walder, Markus #99

StartNr: 71

24. Januar 2017 12:01

AUT

Unterschrift des Schuetzen

Meyton Elektronik

Ergebnis: **620.2** (593)
 Serien: 102.7 104.4 101.7 102.8 105.4 103.2
 Zaehler: 53 7 0 0 0 0 0 0 0
 Innenzehner: 44
 weiteste: 367 (23), 331 (8), 324 (37)
 beste Teiler 37.8 (7.) 45.3 (50.) 45.7 (49.)
 Trefferlage 0.19 mm rechts, 0.13 mm hoch
 Streuwert 1.22, horizontal: 1.36, vertikal: 1.05

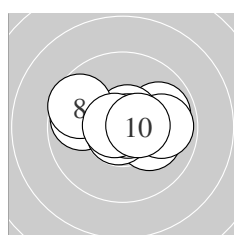
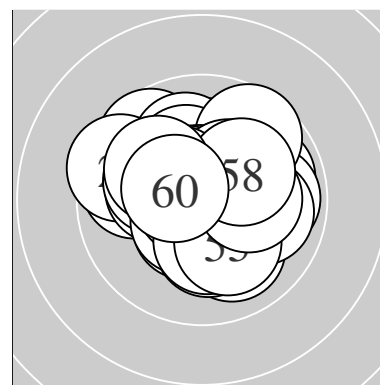

Serie 1:
 9.9 → 9.8 ← 10.1 ↘ 9.9 → 10.8 *
 10.6 * 10.8 * 9.6 ↙ 10.7 * 10.5 *
 beste Teiler 37.8 (7.) 47.8 (5.) 57.2 (9.)
 Trefferlage 0.22 mm rechts, 0.29 mm hoch
 Streuwert 1.47, horizontal: 1.98, vertikal: 0.65

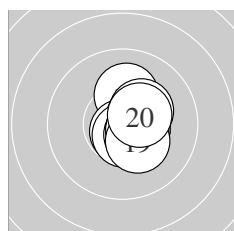

Serie 2:
 10.1 ↑ 10.7 * 10.5 * 10.6 * 10.5 *
 10.5 * 10.5 * 10.3 * 10.3 * 10.4 *
 beste Teiler 51.3 (12.) 77.9 (14.) 112.2 (16.)
 Trefferlage 0.80 mm rechts, 0.01 mm hoch
 Streuwert 0.78, horizontal: 0.50, vertikal: 0.98

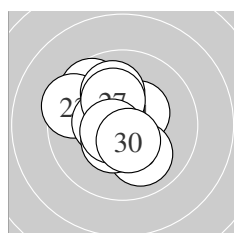

Serie 3:
 10.4 * 9.7 ↘ 9.5 ↘ 10.0 ↑ 10.4 *
 10.0 ↘ 10.2 * 10.4 * 10.6 * 10.5 *
 beste Teiler 85.5 (29.) 115.1 (30.) 127.4 (28.)
 Trefferlage 0.69 mm links, 0.41 mm hoch
 Streuwert 1.48, horizontal: 1.41, vertikal: 1.54

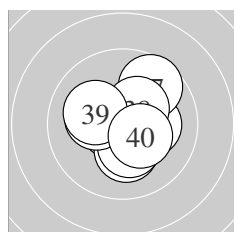

Serie 4:
 10.7 * 10.6 * 10.2 * 10.3 * 10.2 *
 10.2 * 9.7 ↗ 10.4 * 10.1 ↙ 10.4 *
 beste Teiler 74.5 (31.) 92.4 (32.) 147.8 (38.)
 Trefferlage 0.32 mm rechts, 0.06 mm hoch
 Streuwert 1.34, horizontal: 1.39, vertikal: 1.29

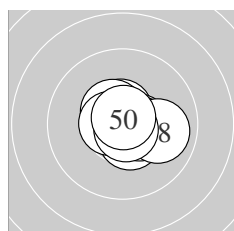

Serie 5:
 10.6 * 10.5 * 10.6 * 10.5 * 10.5 *
 10.6 * 10.5 * 10.0 → 10.8 * 10.8 *
 beste Teiler 45.3 (50.) 45.7 (49.) 82.0 (46.)
 Trefferlage 0.46 mm rechts, 0.03 mm tief
 Streuwert 0.81, horizontal: 0.97, vertikal: 0.60

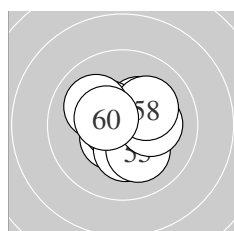

Serie 6:
 10.3 * 10.5 * 10.7 * 10.3 * 10.1 ↘
 10.4 * 10.2 * 10.1 ↗ 10.1 ↙ 10.5 *
 beste Teiler 52.9 (53.) 115.6 (52.) 123.6 (60.)
 Trefferlage 0.06 mm rechts, 0.05 mm hoch
 Streuwert 1.24, horizontal: 1.32, vertikal: 1.15

Meyton Elektronik

ISSF AR Men – Wertung – Männer

StandNr: 138

Lochbihler, Jan #70804717

StartNr: 72

24. Januar 2017 12:00

Switzerland

Unterschrift des Schuetzen

Meyton Elektronik

Ergebnis:	622.7	(596)					
Serien:	104.4	103.8	104.1	102.4	104.2	103.8	
Zaehler:	56	4	0	0	0	0	0
Innenzehner:	47						
weiteste:	306 (35), 288 (21), 265 (39)						
beste Teiler	8.0 (15.) 14.8 (3.) 40.1 (4.)						
Trefferlage	0.26 mm links, 0.14 mm hoch						
Streuwert	1.12, horizontal: 1.21, vertikal: 1.02						

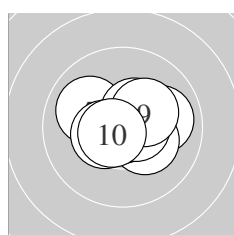
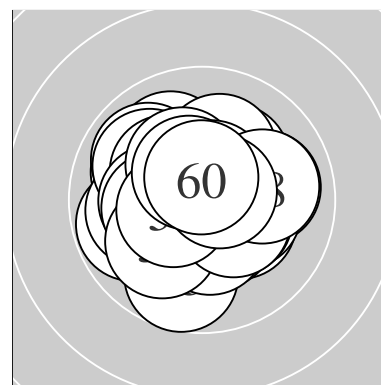

Serie 1:	10.0 →	10.3 *	10.9 *	10.8 *	10.0 ↖
	10.5 *	10.4 *	10.6 *	10.3 *	10.6 *
beste Teiler	14.8 (3.) 40.1 (4.) 79.6 (10.)				
Trefferlage	0.33 mm rechts, 0.17 mm hoch				
Streuwert	1.08, horizontal: 1.37, vertikal: 0.68				

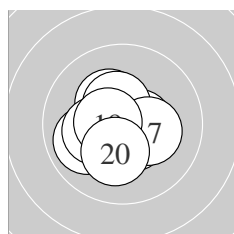

Serie 2:	10.5 *	10.5 *	10.3 *	9.9 ↙	10.9 *
	10.4 *	10.3 *	10.2 *	10.6 *	10.2 *
beste Teiler	8.0 (15.) 97.8 (19.) 104.0 (11.)				
Trefferlage	0.35 mm links, 0.18 mm tief				
Streuwert	1.11, horizontal: 1.23, vertikal: 0.97				

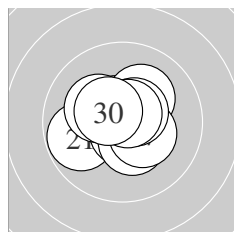

Serie 3:	9.8 ↙	10.6 *	10.7 *	10.2 *	10.2 *
	10.4 *	10.4 *	10.6 *	10.7 *	10.5 *
beste Teiler	63.2 (23.) 65.5 (29.) 91.3 (22.)				
Trefferlage	0.13 mm links, 0.16 mm hoch				
Streuwert	1.14, horizontal: 1.29, vertikal: 0.96				

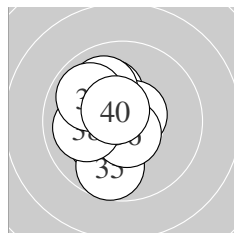

Serie 4:	10.2 *	10.7 *	10.1 ↗	10.6 *	9.7 ↓
	10.6 *	10.0 ↘	10.0 ←	9.9 ↖	10.6 *
beste Teiler	69.0 (32.) 79.9 (34.) 85.0 (36.)				
Trefferlage	0.83 mm links, 0.05 mm hoch				
Streuwert	1.31, horizontal: 0.99, vertikal: 1.56				

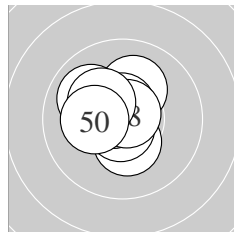

Serie 5:	10.3 *	10.1 ↗	10.6 *	10.6 *	10.7 *
	10.0 ↖	10.7 *	10.8 *	10.2 *	10.2 *
beste Teiler	44.2 (48.) 56.5 (45.) 67.1 (47.)				
Trefferlage	0.51 mm links, 0.44 mm hoch				
Streuwert	0.96, horizontal: 0.95, vertikal: 0.98				

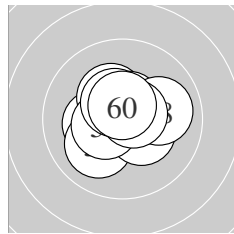

Serie 6:	10.3 *	10.0 ↙	10.4 *	10.3 *	10.6 *
	10.5 *	10.5 *	10.0 →	10.6 *	10.6 *
beste Teiler	77.8 (59.) 89.0 (60.) 96.3 (55.)				
Trefferlage	0.10 mm links, 0.19 mm hoch				
Streuwert	1.14, horizontal: 1.30, vertikal: 0.96				

ISSF AR Men – Wertung – Männer

StandNr: 139

Blamauer, Nikolaus #70804298

StartNr: 73

24. Januar 2017 11:49

AUT

Unterschrift des Schuetzen

Meyton Elektronik

Ergebnis: **611.1** (585)
 Serien: 102.0 103.0 101.0 100.9 100.0 104.2
 Zaehler: 46 13 1 0 0 0 0 0 0
 Innenzehner: 37
 weiteste: 502 (30), 446 (40), 444 (49)
 beste Teiler 5.3 (36.) 16.1 (19.) 22.6 (26.)
 Trefferlage 0.29 mm rechts, 0.10 mm tief
 Streuwert 1.58, horizontal: 1.93, vertikal: 1.12

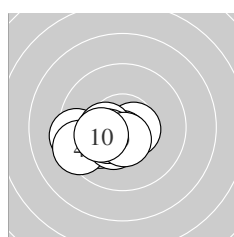
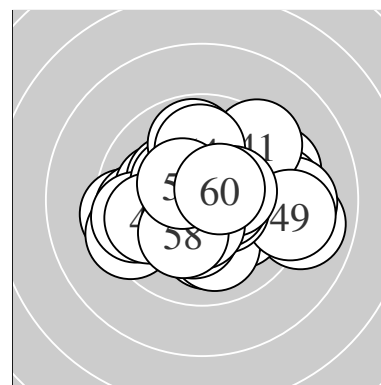

Serie 1:
 9.4 ← 10.1 ↖ 10.6 * 9.4 ← 10.4 *
 10.6 * 10.4 * 10.4 * 10.5 * 10.2 *
 beste Teiler 85.9 (6.) 92.7 (3.) 102.8 (9.)
 Trefferlage 1.34 mm links, 0.84 mm tief
 Streuwert 1.12, horizontal: 1.51, vertikal: 0.46

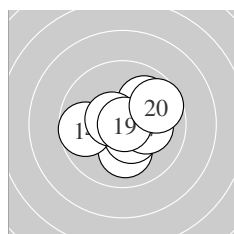

Serie 2:
 10.6 * 10.1 ↓ 10.7 * 9.7 ← 10.0 ↗
 10.5 * 10.2 * 10.6 * 10.9 * 9.7 ↗
 beste Teiler 16.1 (19.) 52.1 (13.) 87.6 (11.)
 Trefferlage 0.49 mm rechts, 0.03 mm hoch
 Streuwert 1.41, horizontal: 1.63, vertikal: 1.14

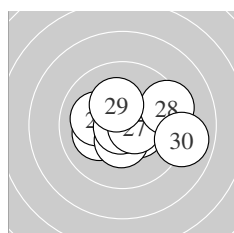

Serie 3:
 10.1 ← 9.9 → 10.1 ↖ 10.4 * 10.4 *
 10.9 * 10.6 * 9.4 → 10.3 * 8.9 →
 beste Teiler 22.6 (26.) 99.7 (27.) 128.3 (25.)
 Trefferlage 0.86 mm rechts, 0.00 mm
 Streuwert 1.78, horizontal: 2.30, vertikal: 1.00

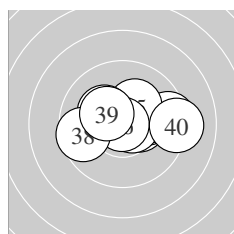

Serie 4:
 10.4 * 10.1 → 9.4 → 10.6 * 10.2 *
 10.9 * 10.2 * 9.6 ← 10.3 * 9.2 →
 beste Teiler 5.3 (36.) 80.2 (34.) 135.1 (31.)
 Trefferlage 0.72 mm rechts, 0.30 mm hoch
 Streuwert 1.75, horizontal: 2.38, vertikal: 0.68

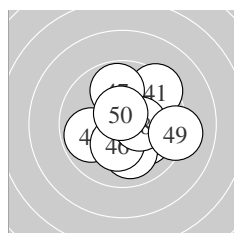

Serie 5:
 9.4 ↗ 10.1 ↘ 9.9 ← 10.3 * 10.0 ↓
 10.3 * 9.8 ↑ 10.4 * 9.2 → 10.6 *
 beste Teiler 90.4 (50.) 142.0 (48.) 170.5 (46.)
 Trefferlage 0.89 mm rechts, 0.10 mm tief
 Streuwert 1.84, horizontal: 1.95, vertikal: 1.73

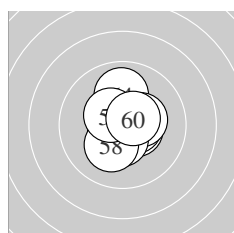

Serie 6:
 10.7 * 10.5 * 10.6 * 10.0 ↑ 10.5 *
 10.3 * 10.5 * 10.2 * 10.4 * 10.5 *
 beste Teiler 75.8 (51.) 95.0 (53.) 102.3 (60.)
 Trefferlage 0.16 mm rechts, 0.04 mm tief
 Streuwert 1.05, horizontal: 0.89, vertikal: 1.18

Meyton Elektronik

ISSF AR Men – Wertung – **Männer**

StandNr: 140

Rodrigues, Pierre #70804685

StartNr: 74

24. Januar 2017 11:48

France

Unterschrift des Schuetzen

Meyton Elektronik

Ergebnis:	620.3	(594)
Serien:	103.3	105.3 102.4 103.6 103.7 102.0
Zaehler:	54	6 0 0 0 0 0 0 0 0
Innenzehner:	42	
weiteste:	368 (53), 357 (44), 313 (23)	
beste Teiler	32.0 (13.)	43.7 (47.) 44.5 (59.)
Trefferlage	0.08 mm rechts, 0.13 mm tief	
Streuwert	1.22, horizontal: 1.40, vertikal: 1.02	

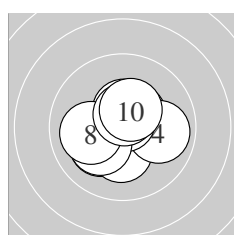
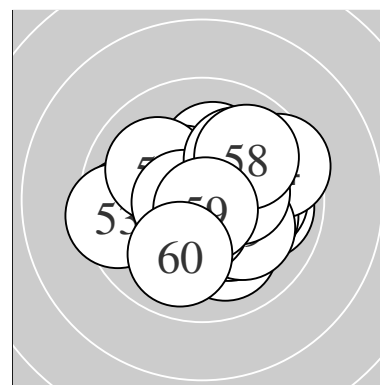

Serie 1:	10.1 ↙	10.3 *	10.5 *	9.9 →	10.8 *
	10.2 *	10.5 *	10.0 ←	10.6 *	10.4 *
beste Teiler	49.4 (5.) 91.9 (9.) 119.2 (7.)				
Trefferlage	0.11 mm links, 0.02 mm tief				
Streuwert	1.26, horizontal: 1.40, vertikal: 1.11				

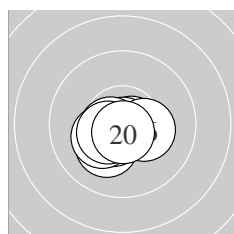

Serie 2:	10.7 *	10.7 *	10.8 *	10.2 *	10.5 *
	10.3 *	10.6 *	10.3 *	10.5 *	10.7 *
beste Teiler	32.0 (13.) 58.0 (20.) 65.7 (12.)				
Trefferlage	0.34 mm links, 0.62 mm tief				
Streuwert	0.70, horizontal: 0.91, vertikal: 0.39				

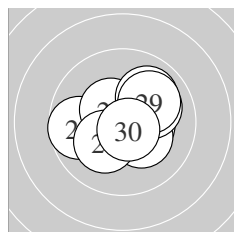

Serie 3:	10.7 *	10.3 *	9.7 ←	10.3 *	10.0 →
	10.5 *	10.0 ↗	10.2 *	10.0 ↗	10.7 *
beste Teiler	67.8 (30.) 73.3 (21.) 123.1 (26.)				
Trefferlage	0.35 mm rechts, 0.22 mm hoch				
Streuwert	1.42, horizontal: 1.69, vertikal: 1.09				

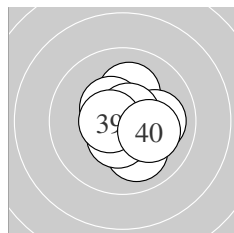

Serie 4:	10.1 ↑	10.4 *	10.0 →	10.7 *	10.0 ↓
	10.5 *	10.7 *	10.5 *	10.6 *	10.1 →
beste Teiler	63.7 (37.) 65.9 (34.) 90.0 (39.)				
Trefferlage	0.50 mm rechts, 0.17 mm tief				
Streuwert	1.10, horizontal: 1.06, vertikal: 1.13				

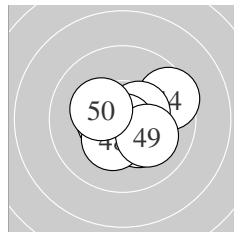

Serie 5:	10.7 *	10.7 *	10.5 *	9.5 →	10.5 *
	10.3 *	10.8 *	10.3 *	10.1 ↘	10.3 *
beste Teiler	43.7 (47.) 62.6 (41.) 64.4 (42.)				
Trefferlage	0.46 mm rechts, 0.27 mm tief				
Streuwert	1.21, horizontal: 1.43, vertikal: 0.93				

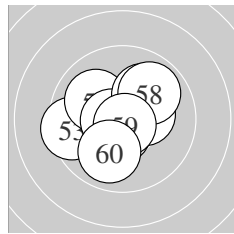

Serie 6:	10.4 *	10.6 *	9.5 ←	10.0 ↘	10.6 *
	10.0 ↗	10.3 *	9.9 ↗	10.8 *	9.9 ↓
beste Teiler	44.5 (59.) 78.6 (55.) 96.1 (52.)				
Trefferlage	0.38 mm links, 0.08 mm hoch				
Streuwert	1.53, horizontal: 1.74, vertikal: 1.30				

Meyton Elektronik

ISSF AR Men – Wertung – Männer

StandNr: 141

Andersen,, Nicklas Kildehøj #70804690

StartNr: 75

24. Januar 2017 12:09

DK

Unterschrift des Schuetzen

Meyton Elektronik

Ergebnis: **616.5** (587)
 Serien: 102.3 103.0 102.6 101.7 102.2 104.7
 Zaehler: 47 13 0 0 0 0 0 0 0 0
 Innenzehner: 43
 weiteste: 358 (35), 349 (7), 327 (15)
 beste Teiler 15.2 (44.) 66.3 (43.) 68.0 (51.)
 Trefferlage 0.02 mm links, 0.47 mm hoch
 Streuwert 1.30, horizontal: 1.28, vertikal: 1.31

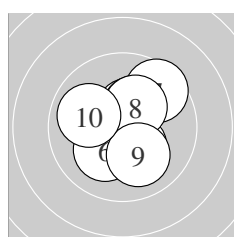
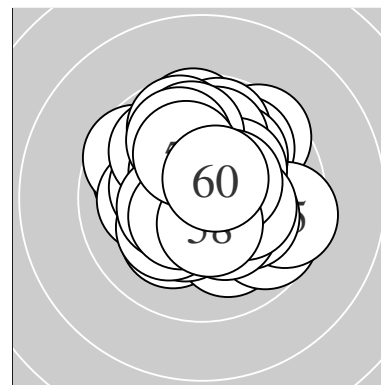

Serie 1:
 10.4 * 10.3 * 10.6 * 10.6 * 10.3 *
 10.2 * 9.6 ↗ 10.3 * 10.1 ↘ 9.9 ↖
 beste Teiler 89.0 (3.) 94.3 (4.) 127.1 (1.)
 Trefferlage 0.37 mm rechts, 0.09 mm hoch
 Streuwert 1.44, horizontal: 1.31, vertikal: 1.56

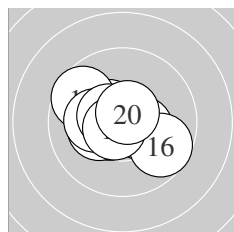

Serie 2:
 10.4 * 10.5 * 10.3 * 10.5 * 9.6 ↖
 9.7 ↘ 10.2 * 10.5 * 10.7 * 10.6 *
 beste Teiler 71.6 (19.) 76.0 (20.) 101.0 (12.)
 Trefferlage 0.55 mm links, 0.03 mm hoch
 Streuwert 1.31, horizontal: 1.61, vertikal: 0.91

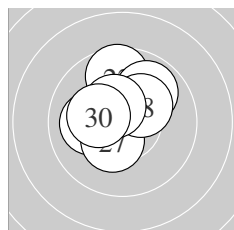

Serie 3:
 10.4 * 9.6 ↑ 10.6 * 9.9 ↗ 10.1 ←
 10.6 * 10.4 * 10.3 * 10.4 * 10.3 *
 beste Teiler 84.8 (26.) 93.4 (23.) 127.0 (29.)
 Trefferlage 0.38 mm links, 0.92 mm hoch
 Streuwert 1.20, horizontal: 1.18, vertikal: 1.22

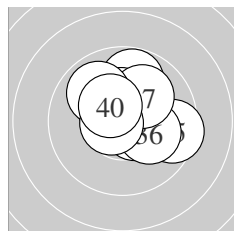

Serie 4:
 10.6 * 9.8 ↑ 10.4 * 10.3 * 9.5 →
 10.1 ↘ 10.1 ↗ 9.9 ↘ 10.6 * 10.4 *
 beste Teiler 79.4 (39.) 100.7 (31.) 138.6 (40.)
 Trefferlage 0.38 mm rechts, 0.80 mm hoch
 Streuwert 1.44, horizontal: 1.59, vertikal: 1.28

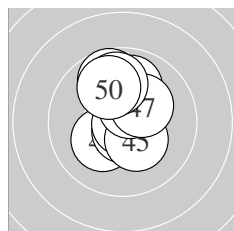

Serie 5:
 10.2 * 9.9 ↑ 10.7 * 10.9 * 10.3 *
 10.5 * 10.2 * 9.7 ↖ 9.9 ↑ 9.9 ↖
 beste Teiler 15.2 (44.) 66.3 (43.) 120.3 (46.)
 Trefferlage 0.02 mm links, 0.95 mm hoch
 Streuwert 1.34, horizontal: 0.90, vertikal: 1.67

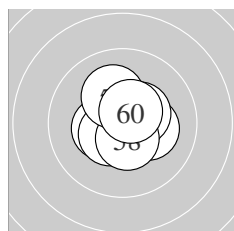

Serie 6:
 10.7 * 10.2 * 10.4 * 10.5 * 10.7 *
 10.4 * 10.5 * 10.5 * 10.2 * 10.6 *
 beste Teiler 68.0 (51.) 70.2 (55.) 99.8 (60.)
 Trefferlage 0.05 mm rechts, 0.04 mm hoch
 Streuwert 0.97, horizontal: 0.95, vertikal: 0.98

Meyton Elektronik

ISSF AR Men – Wertung – Männer

StandNr: 142

Rossiter, Jack #70804629

StartNr: 76

24. Januar 2017 12:00

Australia

Unterschrift des Schuetzen

Meyton Elektronik

Ergebnis: **609.3** (584)
 Serien: 102.5 100.5 102.4 101.8 102.4 99.7
 Zaehler: 45 14 1 0 0 0 0 0 0
 Innenzehner: 35
 weiteste: 556 (60), 425 (12), 405 (18)
 beste Teiler 37.3 (17.) 47.8 (13.) 66.2 (10.)
 Trefferlage 0.01 mm rechts, 0.14 mm hoch
 Streuwert 1.59, horizontal: 1.78, vertikal: 1.38

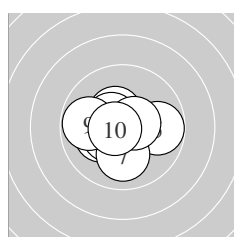
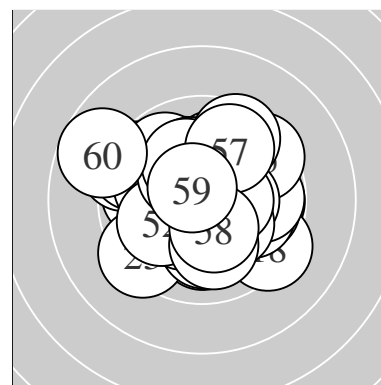

Serie 1:
 10.2 * 10.4 * 10.2 * 10.4 * 9.8 →
 10.5 * 10.0 ↓ 10.5 * 9.8 ← 10.7 *
 beste Teiler 66.2 (10.) 101.5 (8.) 115.4 (6.)
 Trefferlage 0.58 mm links, 0.13 mm tief
 Streuwert 1.32, horizontal: 1.61, vertikal: 0.95

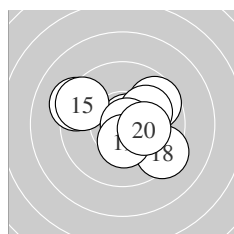

Serie 2:
 10.5 * 9.3 ↖ 10.8 * 9.7 ↗ 9.4 ↖
 10.1 ↗ 10.8 * 9.3 ↘ 10.4 * 10.2 *
 beste Teiler 37.3 (17.) 47.8 (13.) 109.1 (11.)
 Trefferlage 0.43 mm rechts, 0.20 mm hoch
 Streuwert 1.96, horizontal: 2.39, vertikal: 1.38

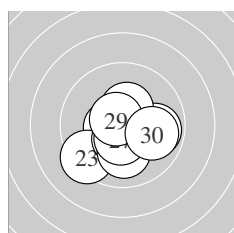

Serie 3:
 10.6 * 10.5 * 9.3 ↙ 10.5 * 9.9 →
 10.1 ↓ 10.5 * 10.4 * 10.7 * 9.9 →
 beste Teiler 73.5 (29.) 88.7 (21.) 106.7 (22.)
 Trefferlage 0.00 mm , 0.72 mm tief
 Streuwert 1.43, horizontal: 1.64, vertikal: 1.18

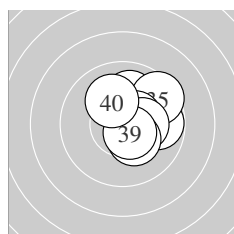

Serie 4:
 10.3 * 10.0 ↑ 10.4 * 9.8 → 9.5 ↗
 10.5 * 10.3 * 10.3 * 10.6 * 10.1 ↘
 beste Teiler 93.6 (39.) 118.5 (36.) 144.0 (33.)
 Trefferlage 1.18 mm rechts, 0.64 mm hoch
 Streuwert 1.19, horizontal: 1.14, vertikal: 1.24

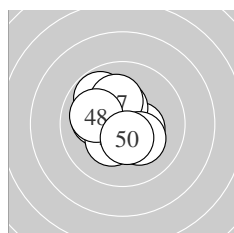

Serie 5:
 10.4 * 9.8 ↘ 10.4 * 10.1 ← 10.5 *
 10.3 * 10.2 * 10.0 ← 10.2 * 10.5 *
 beste Teiler 110.6 (45.) 120.8 (50.) 136.4 (41.)
 Trefferlage 0.54 mm links, 0.18 mm hoch
 Streuwert 1.31, horizontal: 1.30, vertikal: 1.32

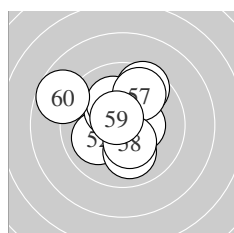

Serie 6:
 9.5 ↗ 10.0 ↙ 10.0 ↓ 10.3 * 10.1 ↘
 10.4 * 9.8 ↗ 10.3 * 10.6 * 8.7 ↖
 beste Teiler 78.8 (59.) 136.0 (56.) 153.2 (58.)
 Trefferlage 0.37 mm links, 0.70 mm hoch
 Streuwert 1.94, horizontal: 2.04, vertikal: 1.84

Meyton Elektronik

ISSF AR Men – Wertung – **Männer**

StandNr: 143

Moser, Manuel #70804356

StartNr: 77

24. Januar 2017 11:56

T – SG Münster

Unterschrift des Schuetzen

Meyton Elektronik