

Ergebnis: **599.7** (573)  
 Serien: 100.3 99.3 100.4 100.2 100.5 99.0  
 Zähler: 36 21 3 0 0 0 0 0 0 0  
 Innenzehner: 29  
 weiteste: 585 (40), 573 (16), 510 (53)  
 beste Teiler 66.4 (5.) 72.5 (34.) 75.9 (58.)  
 Trefferlage 0.53 mm rechts, 0.77 mm hoch  
 Streuwert 1.81, horizontal: 1.89, vertikal: 1.72

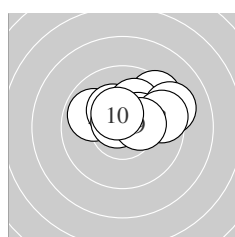

Serie 1:  
 9.4 ↗ 9.9 ↖ 10.3 \* 10.1 ↗ 10.7 \*  
 9.2 → 10.3 \* 9.6 → 10.3 \* 10.5 \*  
 beste Teiler 66.4 (5.) 124.7 (10.) 151.2 (7.)  
 Trefferlage 0.97 mm rechts, 1.21 mm hoch  
 Streuwert 1.53, horizontal: 2.05, vertikal: 0.70

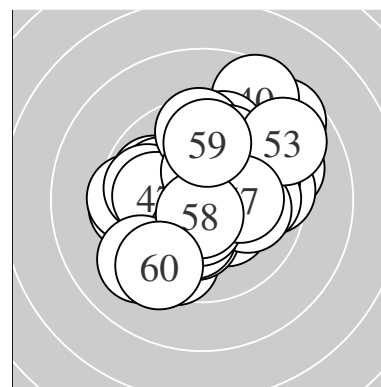
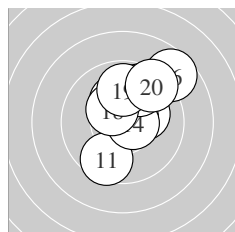

Serie 2:  
 9.6 ↓ 10.2 \* 10.6 \* 10.6 \* 10.2 \*  
 8.7 ↗ 9.7 ↑ 10.4 \* 9.9 ↑ 9.4 ↗  
 beste Teiler 89.4 (14.) 92.7 (13.) 140.7 (18.)  
 Trefferlage 0.86 mm rechts, 1.34 mm hoch  
 Streuwert 1.87, horizontal: 1.67, vertikal: 2.05

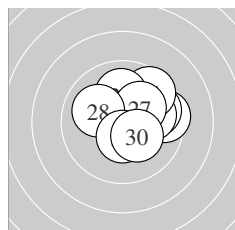

Serie 3:  
 9.5 → 9.8 → 10.0 → 9.6 ↗ 10.0 ↑  
 10.5 \* 10.2 \* 10.0 ↖ 10.5 \* 10.3 \*  
 beste Teiler 103.7 (26.) 124.0 (29.) 169.0 (30.)  
 Trefferlage 1.23 mm rechts, 0.73 mm hoch  
 Streuwert 1.46, horizontal: 1.66, vertikal: 1.23

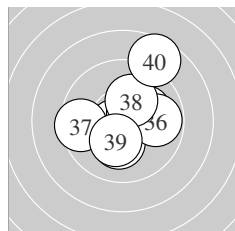

Serie 4:  
 10.2 \* 10.3 \* 10.1 → 10.7 \* 10.5 \*  
 9.8 → 9.5 ← 10.2 \* 10.3 \* 8.6 ↗  
 beste Teiler 72.5 (34.) 107.4 (35.) 173.7 (32.)  
 Trefferlage 0.54 mm rechts, 0.51 mm hoch  
 Streuwert 1.96, horizontal: 1.92, vertikal: 1.99

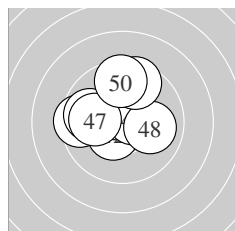

Serie 5:  
 9.5 ← 10.4 \* 10.4 \* 10.6 \* 10.6 \*  
 9.8 ← 10.0 ← 10.0 → 9.6 ↑ 9.6 ↑  
 beste Teiler 91.4 (44.) 93.9 (45.) 128.8 (42.)  
 Trefferlage 0.59 mm links, 0.87 mm hoch  
 Streuwert 1.69, horizontal: 1.88, vertikal: 1.49

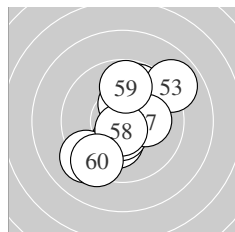

Serie 6:  
 10.2 \* 9.8 ↗ 8.9 ↗ 10.5 \* 10.4 \*  
 9.2 ↗ 10.2 \* 10.7 \* 9.8 ↑ 9.3 ↘  
 beste Teiler 75.9 (58.) 114.8 (54.) 146.6 (55.)  
 Trefferlage 0.17 mm rechts, 0.00 mm  
 Streuwert 2.23, horizontal: 2.03, vertikal: 2.41

**ISSF AR Men – Wertung – Männer**

StandNr: 101

**Novak, Patrik** #70817551

**StartNr: 146**

2. Dezember 2017 19:13

VBG

---

\_\_\_\_\_  
Unterschrift des Schützen

Meyton Elektronik

Ergebnis: **624.6** (593)<sup>QF</sup>  
 Serien: 104.9 102.1 106.1 104.8 103.8 102.9  
 Zähler: 53 7 0 0 0 0 0 0 0  
 Innenzehner: 49  
 weiteste: 327 (13), 316 (17), 295 (15)  
 beste Teiler 27.3 (24.) 29.0 (29.) 41.7 (55.)  
 Trefferlage 0.00 mm , 0.44 mm hoch  
 Streuwert 1.06, horizontal: 1.18, vertikal: 0.93

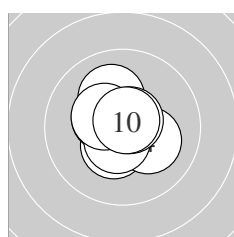
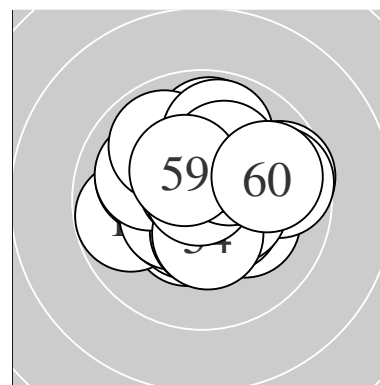

Serie 1:  
 10.7 \*                      10.4 \*                      10.7 \*                      10.2 \*                      10.4 \*  
 10.6 \*                      10.1 ↖                      10.7 \*                      10.4 \*                      10.7 \*  
 beste Teiler 52.3 (10.) 67.2 (3.) 67.8 (8.)  
 Trefferlage 0.29 mm links, 0.15 mm hoch  
 Streuwert 0.92, horizontal: 0.90, vertikal: 0.95

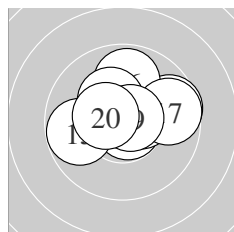

Serie 2:  
 10.8 \*                      10.4 \*                      9.6 →                      10.4 \*                      9.8 ←  
 9.9 ↑                      9.7 →                      10.3 \*                      10.7 \*                      10.5 \*  
 beste Teiler 45.4 (11.) 59.9 (19.) 121.4 (20.)  
 Trefferlage 0.45 mm rechts, 0.70 mm hoch  
 Streuwert 1.45, horizontal: 1.83, vertikal: 0.94

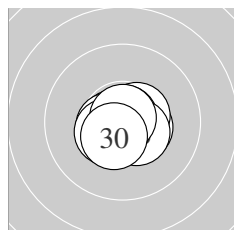

Serie 3:  
 10.5 \*                      10.5 \*                      10.7 \*                      10.8 \*                      10.6 \*  
 10.5 \*                      10.7 \*                      10.5 \*                      10.8 \*                      10.5 \*  
 beste Teiler 27.3 (24.) 29.0 (29.) 51.7 (27.)  
 Trefferlage 0.02 mm links, 0.23 mm tief  
 Streuwert 0.65, horizontal: 0.80, vertikal: 0.46

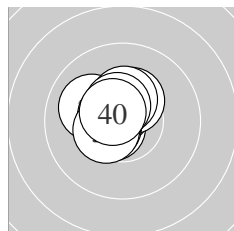

Serie 4:  
 10.6 \*                      10.7 \*                      10.0 ↘                      10.4 \*                      10.5 \*  
 10.4 \*                      10.6 \*                      10.5 \*                      10.5 \*                      10.6 \*  
 beste Teiler 74.9 (32.) 82.1 (31.) 86.8 (37.)  
 Trefferlage 0.63 mm links, 0.49 mm hoch  
 Streuwert 0.73, horizontal: 0.71, vertikal: 0.75

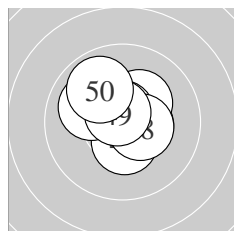

Serie 5:  
 10.7 \*                      10.5 \*                      10.3 \*                      10.1 ↘                      10.4 \*  
 10.0 ↘                      10.7 \*                      10.5 \*                      10.7 \*                      9.9 ↘  
 beste Teiler 58.6 (47.) 72.4 (41.) 72.4 (49.)  
 Trefferlage 0.12 mm links, 0.54 mm hoch  
 Streuwert 1.12, horizontal: 1.23, vertikal: 1.00

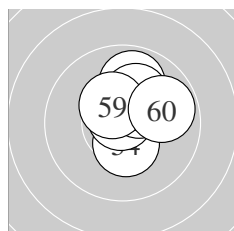

Serie 6:  
 10.5 \*                      10.2 \*                      10.4 \*                      10.4 \*                      10.8 \*  
 10.3 \*                      9.9 ↑                      10.2 \*                      10.4 \*                      9.8 →  
 beste Teiler 41.7 (55.) 113.8 (51.) 136.0 (53.)  
 Trefferlage 0.60 mm rechts, 1.00 mm hoch  
 Streuwert 1.03, horizontal: 1.03, vertikal: 1.02

Meyton Elektronik

**ISSF AR Men – Wertung – Männer**

StandNr: 102

**Simon, Weithaler** #390

**StartNr: 147**

2. Dezember 2017 19:10

ITA

---

QF – Schütze hat sich fürs Finale qualifiziert

---

Unterschrift des Schützen

Meyton Elektronik

Ergebnis:	<b>588.9</b>	(562)
Serien:	101.5 97.2 95.5 100.3 97.8 96.6	
Zähler:	28 26 6 0 0 0 0 0 0 0	
Innenzehner:	22	
weiteste:	710 (16), 677 (55), 620 (41)	
beste Teiler	12.0 (2.) 16.4 (34.) 22.8 (47.)	
Trefferlage	0.08 mm links, 0.90 mm hoch	
Streuwert	2.28, horizontal: 2.78, vertikal: 1.63	

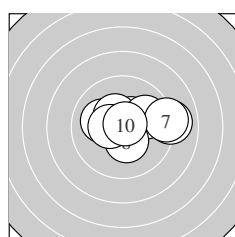
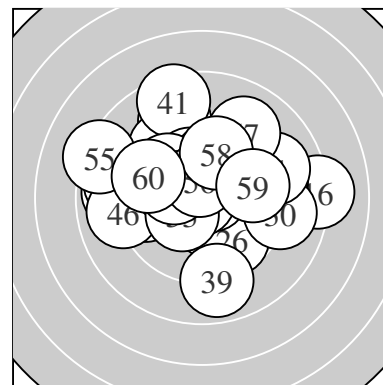

Serie 1:

10.5 *	10.9 *	9.0 →	10.1 ←	10.4 *
9.9 ↗	9.1 →	10.4 *	10.4 *	10.8 *
beste Teiler	12.0 (2.) 42.2 (10.) 123.0 (1.)			
Trefferlage	0.91 mm rechts, 0.40 mm hoch			
Streuwert	1.72, horizontal: 2.32, vertikal: 0.73			

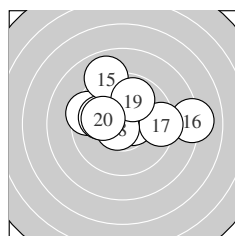

Serie 2:

9.5 ←	10.0 ←	10.0 ↑	10.5 *	9.0 ↖
8.1 →	9.4 →	10.7 *	9.9 ↗	10.1 ←
beste Teiler	67.6 (18.) 103.1 (14.) 208.5 (20.)			
Trefferlage	0.31 mm rechts, 1.18 mm hoch			
Streuwert	2.52, horizontal: 3.20, vertikal: 1.56			

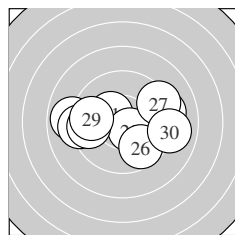

Serie 3:

10.4 *	9.2 →	8.9 ←	9.2 ←	10.5 *
9.7 ↘	9.3 ↗	9.6 ←	9.7 ←	9.0 →
beste Teiler	108.9 (25.) 149.6 (21.) 313.2 (26.)			
Trefferlage	0.20 mm links, 0.05 mm tief			
Streuwert	2.80, horizontal: 3.76, vertikal: 1.25			

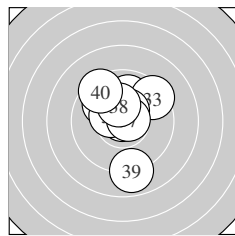

Serie 4:

9.9 ↘	9.9 ↑	9.4 ↗	10.9 *	10.4 *
10.5 *	10.7 *	10.3 *	8.9 ↓	9.4 ↘
beste Teiler	16.4 (34.) 60.7 (37.) 117.2 (36.)			
Trefferlage	0.02 mm links, 0.82 mm hoch			
Streuwert	1.96, horizontal: 1.54, vertikal: 2.30			

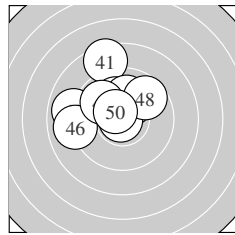

Serie 5:

8.5 ↖	10.3 *	8.9 ←	10.1 ↖	10.0 ↑
9.0 ←	10.9 *	9.7 ↗	9.9 ↘	10.5 *
beste Teiler	22.8 (47.) 106.0 (50.) 173.5 (42.)			
Trefferlage	1.18 mm links, 1.63 mm hoch			
Streuwert	2.10, horizontal: 2.34, vertikal: 1.83			

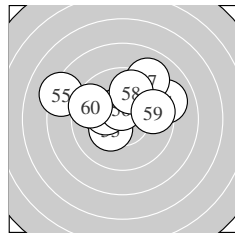

Serie 6:

9.1 →	10.2 *	10.3 *	10.2 *	8.2 ↖
10.5 *	9.1 ↗	9.8 ↑	9.7 →	9.5 ↖
beste Teiler	108.9 (56.) 159.6 (53.) 181.8 (54.)			
Trefferlage	0.35 mm links, 1.43 mm hoch			
Streuwert	2.48, horizontal: 3.22, vertikal: 1.40			

Meyton Elektronik

**ISSF AR Men – Wertung – Männer**

StandNr: 103

**Shajinbat, Erdembileg** #70817495

**StartNr: 148**

2. Dezember 2017 18:38

Mongolei

---

\_\_\_\_\_  
Unterschrift des Schützen

Meyton Elektronik

Ergebnis: **624.2** (597)<sup>QF</sup>  
 Serien: 103.0 104.1 103.2 105.0 104.4 104.5  
 Zähler: 57 3 0 0 0 0 0 0 0 0  
 Innenzehner: 47  
 weiteste: 299 (2), 289 (27), 260 (25)  
 beste Teiler 26.8 (42.) 31.3 (38.) 32.5 (32.)  
 Trefferlage 0.01 mm links, 0.02 mm tief  
 Streuwert 1.08, horizontal: 1.14, vertikal: 1.02

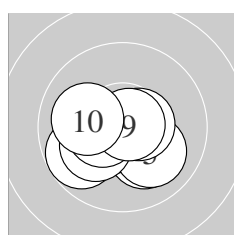
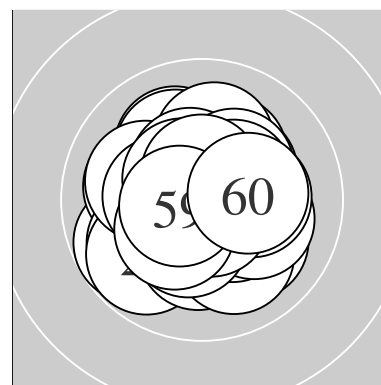

Serie 1:  
 10.6 \* 9.8 ↙ 10.1 ↘ 10.6 \* 10.0 ↘  
 10.5 \* 10.1 ↙ 10.4 \* 10.8 \* 10.1 ↖  
 beste Teiler 42.1 (9.) 83.8 (1.) 96.2 (4.)  
 Trefferlage 0.37 mm links, 0.66 mm tief  
 Streuwert 1.20, horizontal: 1.51, vertikal: 0.78

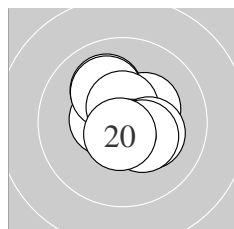

Serie 2:  
 10.1 ↖ 10.5 \* 10.5 \* 10.3 \* 10.8 \*  
 10.1 ↖ 10.6 \* 10.2 \* 10.4 \* 10.6 \*  
 beste Teiler 41.0 (15.) 76.9 (20.) 93.0 (17.)  
 Trefferlage 0.12 mm rechts, 0.45 mm hoch  
 Streuwert 1.03, horizontal: 1.02, vertikal: 1.05

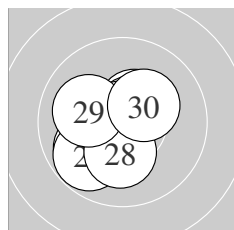

Serie 3:  
 10.5 \* 10.6 \* 10.4 \* 10.6 \* 9.9 ↙  
 10.8 \* 9.8 ↙ 10.2 \* 10.1 ↖ 10.3 \*  
 beste Teiler 35.2 (26.) 83.6 (22.) 85.7 (24.)  
 Trefferlage 0.62 mm links, 0.15 mm tief  
 Streuwert 1.23, horizontal: 1.26, vertikal: 1.20

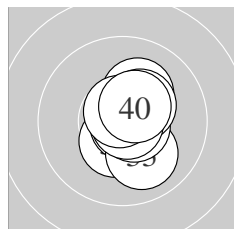

Serie 4:  
 10.4 \* 10.8 \* 10.0 ↘ 10.6 \* 10.6 \*  
 10.2 \* 10.4 \* 10.8 \* 10.7 \* 10.5 \*  
 beste Teiler 31.3 (38.) 32.5 (32.) 61.6 (39.)  
 Trefferlage 0.50 mm rechts, 0.10 mm hoch  
 Streuwert 0.87, horizontal: 0.54, vertikal: 1.11

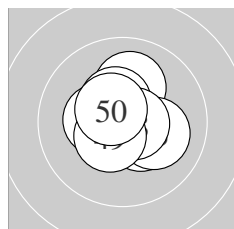

Serie 5:  
 10.5 \* 10.8 \* 10.4 \* 10.1 ↑ 10.1 ↘  
 10.4 \* 10.4 \* 10.7 \* 10.5 \* 10.5 \*  
 beste Teiler 26.8 (42.) 67.7 (48.) 106.8 (50.)  
 Trefferlage 0.01 mm links, 0.21 mm hoch  
 Streuwert 1.02, horizontal: 1.08, vertikal: 0.95

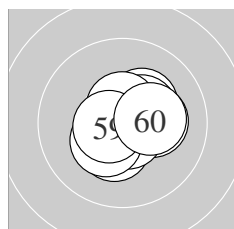

Serie 6:  
 10.6 \* 10.3 \* 10.2 \* 10.4 \* 10.6 \*  
 10.4 \* 10.7 \* 10.4 \* 10.6 \* 10.3 \*  
 beste Teiler 68.8 (57.) 87.0 (59.) 93.0 (55.)  
 Trefferlage 0.33 mm rechts, 0.09 mm tief  
 Streuwert 0.98, horizontal: 1.07, vertikal: 0.88

Meyton Elektronik

**ISSF AR Men – Wertung – Männer**

StandNr: 104

**Rumpler, Gernot #265**

**StartNr: 149**

2. Dezember 2017 19:19

AUT

---

QF – Schütze hat sich fürs Finale qualifiziert

---

Unterschrift des Schützen

Meyton Elektronik



Ergebnis:	<b>625.0</b>	(596) <sup>QF</sup>
Serien:	103.8	102.5 104.8 104.2 104.1 105.6
Zähler:	56	4 0 0 0 0 0 0 0 0
Innenzehner:	53	
weiteste:	390	(13), 296 (49), 289 (37)
beste Teiler	26.6	(39.) 26.8 (10.) 28.8 (32.)
Trefferlage	0.09 mm	links, 0.07 mm tief
Streuwert	1.08,	horizontal: 1.15, vertikal: 1.01

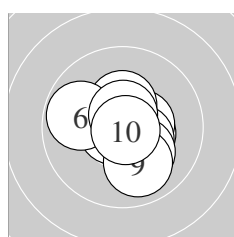
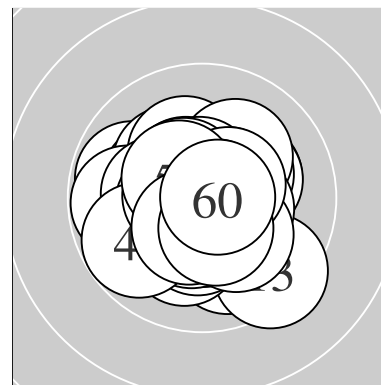

Serie 1:	10.4 *	10.5 *	10.7 *	10.4 *	10.4 *
	9.8 ←	10.6 *	10.2 *	10.0 ↓	10.8 *
beste Teiler	26.8	(10.) 64.5	(3.) 81.0	(7.)	
Trefferlage	0.25 mm	rechts, 0.22 mm	tief		
Streuwert	1.18,	horizontal: 1.23,	vertikal: 1.13		

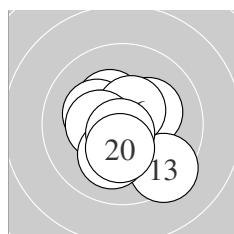

Serie 2:	10.3 *	10.2 *	9.4 ↘	10.2 *	10.4 *
	10.5 *	10.4 *	10.1 ↓	10.7 *	10.3 *
beste Teiler	61.1	(19.) 106.8	(16.) 138.0	(15.)	
Trefferlage	0.14 mm	links, 0.33 mm	tief		
Streuwert	1.40,	horizontal: 1.42,	vertikal: 1.39		

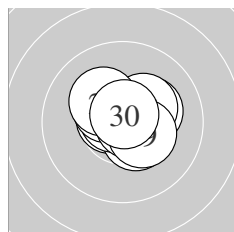

Serie 3:	10.6 *	10.5 *	10.7 *	10.4 *	10.8 *
	10.2 *	10.3 *	10.2 *	10.4 *	10.7 *
beste Teiler	49.7	(25.) 52.1	(30.) 63.5	(23.)	
Trefferlage	0.21 mm	rechts, 0.31 mm	hoch		
Streuwert	0.92,	horizontal: 1.07,	vertikal: 0.73		

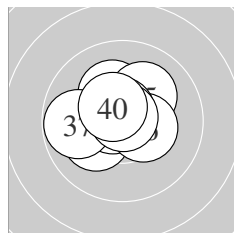

Serie 4:	10.2 *	10.8 *	10.2 *	10.7 *	10.1 ↗
	10.4 *	9.8 ←	10.7 *	10.8 *	10.5 *
beste Teiler	26.6	(39.) 28.8	(32.) 63.5	(38.)	
Trefferlage	0.42 mm	links, 0.35 mm	hoch		
Streuwert	1.09,	horizontal: 1.26,	vertikal: 0.88		

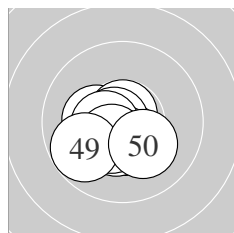

Serie 5:	10.3 *	10.8 *	10.5 *	10.7 *	10.5 *
	10.5 *	10.4 *	10.4 *	9.8 ←	10.2 *
beste Teiler	50.0	(42.) 55.0	(44.) 115.9	(46.)	
Trefferlage	0.51 mm	links, 0.72 mm	tief		
Streuwert	0.94,	horizontal: 1.09,	vertikal: 0.77		

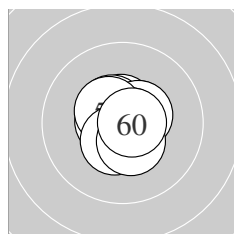

Serie 6:	10.5 *	10.6 *	10.5 *	10.6 *	10.5 *
	10.8 *	10.5 *	10.5 *	10.4 *	10.7 *
beste Teiler	50.2	(56.) 61.0	(60.) 87.5	(54.)	
Trefferlage	0.05 mm	rechts, 0.14 mm	hoch		
Streuwert	0.76,	horizontal: 0.76,	vertikal: 0.76		

**ISSF AR Men – Wertung – Männer**

StandNr: 105

**Piasecki, Pierre Edmond** #70817552

**StartNr: 150**

2. Dezember 2017 19:11

FRA

---

QF – Schütze hat sich fürs Finale qualifiziert

---

Unterschrift des Schützen

Meyton Elektronik

Ergebnis: **610.0** (584)  
 Serien: 97.8 100.8 102.8 102.6 103.4 102.6  
 Zähler: 45 14 1 0 0 0 0 0 0  
 Innenzehner: 34  
 weiteste: 519 (1), 417 (12), 401 (10)  
 beste Teiler 48.1 (41.) 59.4 (13.) 59.6 (51.)  
 Trefferlage 0.10 mm links, 0.60 mm hoch  
 Streuwert 1.50, horizontal: 1.59, vertikal: 1.41

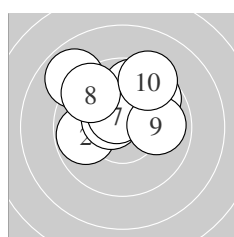
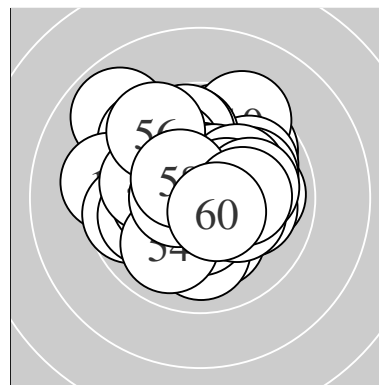

Serie 1:  
 8.9 ↘                      9.8 ←                      10.5 \*                      9.7 ↑                      10.0 →  
 9.7 ↗                      10.5 \*                      9.5 ↘                      9.9 →                      9.3 ↗  
 beste Teiler 104.3 (3.) 109.6 (7.) 232.0 (5.)  
 Trefferlage 0.06 mm links, 1.69 mm hoch  
 Streuwert 1.94, horizontal: 2.31, vertikal: 1.48

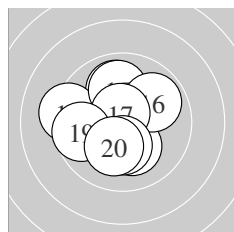

Serie 2:  
 9.9 ↑                      9.3 ←                      10.7 \*                      10.2 \*                      10.0 ↑  
 9.9 ↗                      10.7 \*                      10.2 \*                      9.7 ←                      10.2 \*  
 beste Teiler 59.4 (13.) 71.0 (17.) 176.0 (18.)  
 Trefferlage 0.64 mm links, 0.12 mm hoch  
 Streuwert 1.74, horizontal: 1.80, vertikal: 1.68

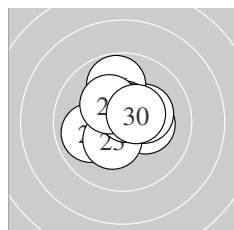

Serie 3:  
 9.9 ←                      10.3 \*                      10.3 \*                      10.2 \*                      10.3 \*  
 9.8 ↑                      10.6 \*                      10.6 \*                      10.3 \*                      10.5 \*  
 beste Teiler 77.8 (28.) 89.2 (27.) 117.9 (30.)  
 Trefferlage 0.06 mm links, 0.64 mm hoch  
 Streuwert 1.25, horizontal: 1.29, vertikal: 1.21

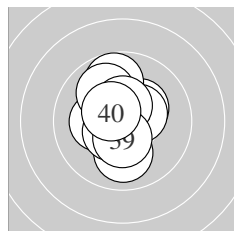

Serie 4:  
 10.3 \*                      10.0 ↓                      9.8 ↑                      10.4 \*                      10.2 \*  
 10.0 ↘                      10.5 \*                      10.5 \*                      10.4 \*                      10.5 \*  
 beste Teiler 113.8 (38.) 114.2 (40.) 118.0 (37.)  
 Trefferlage 0.29 mm links, 0.39 mm hoch  
 Streuwert 1.32, horizontal: 0.99, vertikal: 1.59

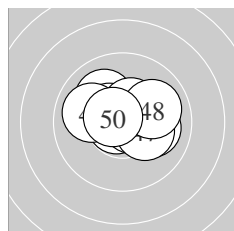

Serie 5:  
 10.8 \*                      10.1 →                      10.1 ↘                      10.7 \*                      10.5 \*  
 10.4 \*                      10.2 \*                      10.0 →                      10.0 ←                      10.6 \*  
 beste Teiler 48.1 (41.) 72.3 (44.) 82.2 (50.)  
 Trefferlage 0.15 mm rechts, 0.42 mm hoch  
 Streuwert 1.24, horizontal: 1.58, vertikal: 0.77

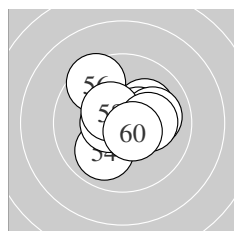

Serie 6:  
 10.7 \*                      10.1 ↗                      10.4 \*                      10.0 ↙                      10.0 →  
 9.5 ↘                      10.6 \*                      10.5 \*                      10.2 \*                      10.6 \*  
 beste Teiler 59.6 (51.) 98.7 (60.) 99.0 (57.)  
 Trefferlage 0.30 mm rechts, 0.36 mm hoch  
 Streuwert 1.41, horizontal: 1.52, vertikal: 1.30

Meyton Elektronik

**ISSF AR Men** – Wertung – **Männer**

StandNr: 106

**Walder, Markus** #99

**StartNr: 151**

2. Dezember 2017 19:14

AUT

---

\_\_\_\_\_  
Unterschrift des Schützen

Meyton Elektronik

Ergebnis:	<b>617.9</b>	(594)					
Serien:	103.3	101.7	102.3	103.5	103.3	103.8	
Zähler:	54	6	0	0	0	0	0
Innenzehner:	44						
weiteste:	449 (25), 331 (9), 309 (12)						
beste Teiler	10.7 (10.) 32.2 (8.) 42.0 (53.)						
Trefferlage	0.20 mm rechts, 0.40 mm hoch						
Streuwert	1.26, horizontal: 1.33, vertikal: 1.18						

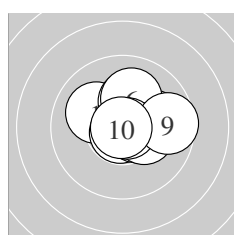
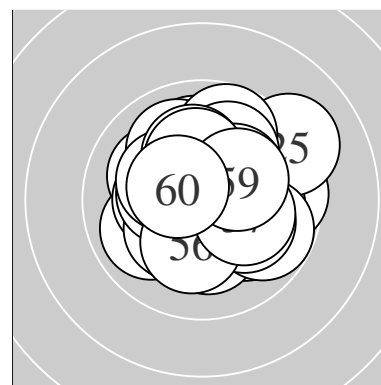

Serie 1:					
	10.1 ↘	10.2 *	10.8 *	10.0 →	10.5 *
	10.1 ↑	10.3 *	10.8 *	9.6 →	10.9 *
beste Teiler	10.7 (10.) 32.2 (8.) 42.9 (3.)				
Trefferlage	0.73 mm rechts, 0.44 mm hoch				
Streuwert	1.21, horizontal: 1.43, vertikal: 0.93				

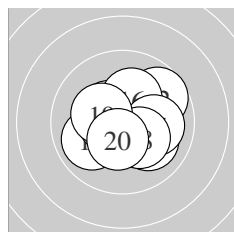

Serie 2:					
	9.9 ↙	9.7 ↗	10.4 *	10.5 *	10.0 ↘
	10.2 *	10.0 →	10.3 *	10.3 *	10.4 *
beste Teiler	103.0 (14.) 128.2 (13.) 131.0 (20.)				
Trefferlage	0.24 mm rechts, 0.03 mm tief				
Streuwert	1.48, horizontal: 1.70, vertikal: 1.21				

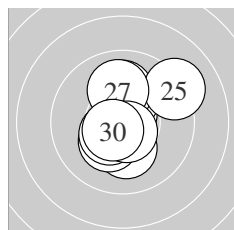

Serie 3:					
	10.2 *	10.7 *	10.3 *	10.0 ↑	9.2 ↗
	10.3 *	10.0 ↑	10.4 *	10.6 *	10.6 *
beste Teiler	62.1 (22.) 77.0 (29.) 92.3 (30.)				
Trefferlage	0.20 mm rechts, 0.37 mm hoch				
Streuwert	1.53, horizontal: 1.37, vertikal: 1.67				

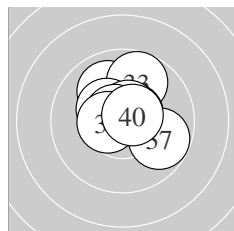

Serie 4:					
	10.6 *	10.0 ↘	9.7 ↑	10.6 *	10.4 *
	10.6 *	9.8 ↘	10.7 *	10.5 *	10.6 *
beste Teiler	69.8 (38.) 84.1 (36.) 84.3 (40.)				
Trefferlage	0.16 mm rechts, 0.75 mm hoch				
Streuwert	1.17, horizontal: 1.21, vertikal: 1.13				

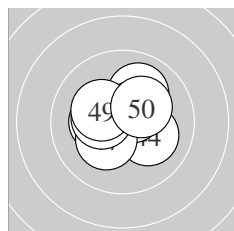

Serie 5:					
	10.8 *	10.0 ↑	10.4 *	10.1 ↘	10.6 *
	10.3 *	10.3 *	10.3 *	10.3 *	10.2 *
beste Teiler	50.4 (41.) 98.3 (45.) 138.2 (43.)				
Trefferlage	0.20 mm links, 0.39 mm hoch				
Streuwert	1.19, horizontal: 1.38, vertikal: 0.96				

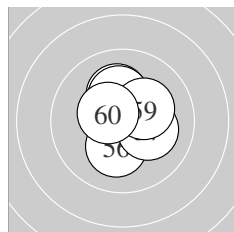

Serie 6:					
	10.2 *	10.6 *	10.8 *	10.6 *	10.3 *
	10.2 *	10.2 *	10.2 *	10.2 *	10.5 *
beste Teiler	42.0 (53.) 76.8 (54.) 88.0 (52.)				
Trefferlage	0.08 mm rechts, 0.51 mm hoch				
Streuwert	1.08, horizontal: 0.96, vertikal: 1.19				

Meyton Elektronik

**ISSF AR Men** – Wertung – **Männer**

StandNr: 107

**Hári, Péter** #70817553

**StartNr: 152**

2. Dezember 2017 19:17

HUN – BHSE

---

\_\_\_\_\_  
Unterschrift des Schützen

Meyton Elektronik

Ergebnis: **619.5** (594)  
 Serien: 105.6 101.5 101.9 104.4 102.7 103.4  
 Zähler: 54 6 0 0 0 0 0 0 0  
 Innenzehner: 46  
 weiteste: 413 (23), 368 (20), 346 (43)  
 beste Teiler 39.5 (47.) 42.7 (4.) 53.5 (2.)  
 Trefferlage 0.41 mm links, 0.08 mm hoch  
 Streuwert 1.22, horizontal: 1.26, vertikal: 1.18

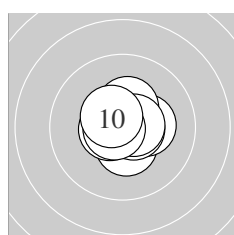
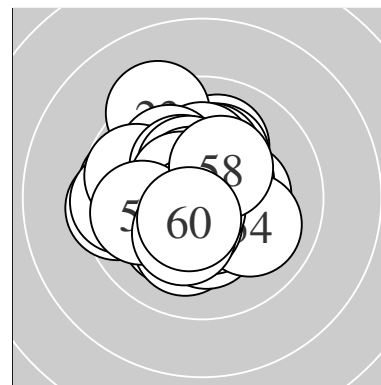

Serie 1:  
 10.4 \*                      10.7 \*                      10.3 \*                      10.8 \*                      10.4 \*  
 10.6 \*                      10.6 \*                      10.6 \*                      10.7 \*                      10.5 \*  
 beste Teiler 42.7 (4.) 53.5 (2.) 61.9 (9.)  
 Trefferlage 0.16 mm rechts, 0.13 mm hoch  
 Streuwert 0.75, horizontal: 0.81, vertikal: 0.69

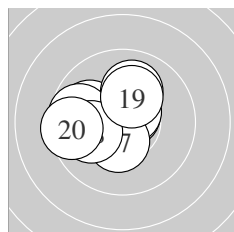

Serie 2:  
 10.7 \*                      10.0 ↖                      10.4 \*                      10.0 ↗                      9.7 ↖  
 10.6 \*                      10.4 \*                      10.0 ↖                      10.2 \*                      9.5 ↖  
 beste Teiler 68.6 (11.) 92.2 (16.) 126.8 (13.)  
 Trefferlage 0.88 mm links, 0.52 mm hoch  
 Streuwert 1.46, horizontal: 1.75, vertikal: 1.11

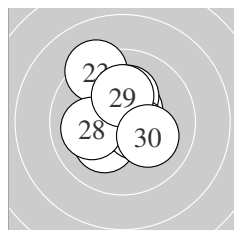

Serie 3:  
 10.5 \*                      10.6 \*                      9.3 ↘                      10.2 \*                      10.2 \*  
 10.2 \*                      10.5 \*                      10.1 ↖                      10.2 \*                      10.1 ↘  
 beste Teiler 90.0 (22.) 107.2 (21.) 110.0 (27.)  
 Trefferlage 0.24 mm links, 0.67 mm hoch  
 Streuwert 1.46, horizontal: 1.30, vertikal: 1.61

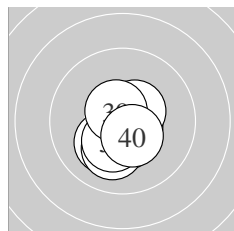

Serie 4:  
 10.6 \*                      10.2 \*                      10.4 \*                      10.6 \*                      10.5 \*  
 10.1 ↘                      10.6 \*                      10.3 \*                      10.6 \*                      10.5 \*  
 beste Teiler 76.3 (31.) 83.8 (37.) 85.9 (39.)  
 Trefferlage 0.11 mm links, 0.80 mm tief  
 Streuwert 0.81, horizontal: 0.70, vertikal: 0.91

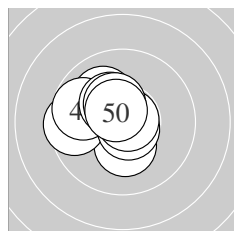

Serie 5:  
 10.3 \*                      10.2 \*                      9.6 ↖                      10.0 ↘                      10.7 \*  
 9.8 ↖                      10.8 \*                      10.3 \*                      10.4 \*                      10.6 \*  
 beste Teiler 39.5 (47.) 64.5 (45.) 95.3 (50.)  
 Trefferlage 0.99 mm links, 0.52 mm hoch  
 Streuwert 1.19, horizontal: 1.31, vertikal: 1.06

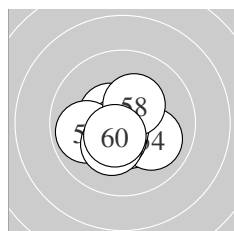

Serie 6:  
 10.5 \*                      10.2 \*                      10.5 \*                      10.0 ↘                      10.5 \*  
 10.7 \*                      9.9 ↖                      10.3 \*                      10.3 \*                      10.5 \*  
 beste Teiler 60.6 (56.) 107.7 (60.) 109.2 (53.)  
 Trefferlage 0.43 mm links, 0.54 mm tief  
 Streuwert 1.11, horizontal: 1.31, vertikal: 0.87

Meyton Elektronik

**ISSF AR Men** – Wertung – **Männer**

StandNr: 108

**Anrain, Julian** #70804301

**StartNr: 153**

2. Dezember 2017 19:19

T – SG Münster

---

\_\_\_\_\_  
Unterschrift des Schützen

Meyton Elektronik



Ergebnis: **610.0** (584)  
 Serien: 101.6 99.2 102.1 102.1 102.9 102.1  
 Zähler: 44 16 0 0 0 0 0 0 0 0  
 Innenzehner: 37  
 weiteste: 484 (13), 447 (34), 434 (44)  
 beste Teiler 14.4 (2.) 26.6 (43.) 31.0 (55.)  
 Trefferlage 0.47 mm links, 0.39 mm tief  
 Streuwert 1.54, horizontal: 1.89, vertikal: 1.08

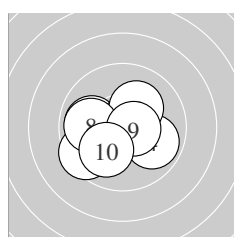
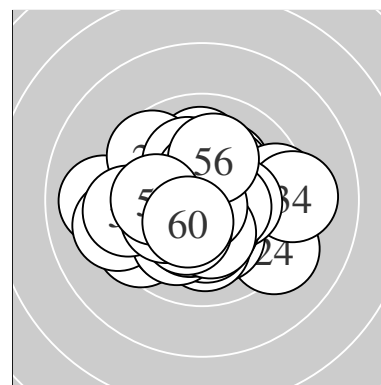

Serie 1:  
 9.9 ← 10.9 \* 10.2 \* 9.9 ↘ 10.5 \*  
 10.2 \* 9.5 ↙ 9.9 ← 10.6 \* 10.0 ↘  
 beste Teiler 14.4 (2.) 90.9 (9.) 114.0 (5.)  
 Trefferlage 0.75 mm links, 0.45 mm tief  
 Streuwert 1.50, horizontal: 1.82, vertikal: 1.09

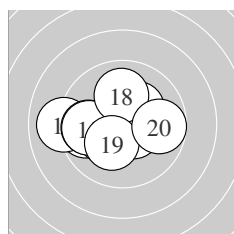

Serie 2:  
 9.7 ← 10.2 \* 9.0 ← 9.8 ← 9.8 ←  
 10.5 \* 10.3 \* 10.0 ↑ 10.2 \* 9.7 →  
 beste Teiler 107.8 (16.) 174.7 (17.) 177.2 (12.)  
 Trefferlage 1.08 mm links, 0.08 mm tief  
 Streuwert 1.86, horizontal: 2.38, vertikal: 1.12

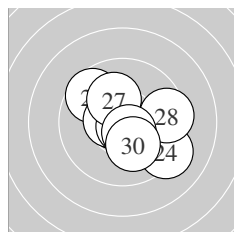

Serie 3:  
 10.7 \* 9.6 ↘ 10.5 \* 9.2 ↘ 10.8 \*  
 10.8 \* 10.2 \* 9.5 → 10.6 \* 10.2 \*  
 beste Teiler 31.1 (25.) 34.3 (26.) 54.2 (21.)  
 Trefferlage 0.41 mm rechts, 0.09 mm tief  
 Streuwert 1.69, horizontal: 1.92, vertikal: 1.43

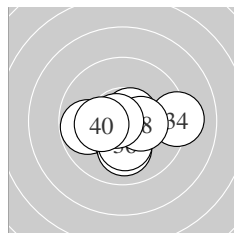

Serie 4:  
 9.8 ← 10.3 \* 10.7 \* 9.2 → 10.0 ↓  
 10.2 \* 10.6 \* 10.3 \* 10.7 \* 10.3 \*  
 beste Teiler 52.0 (39.) 70.4 (33.) 79.8 (37.)  
 Trefferlage 0.23 mm rechts, 0.56 mm tief  
 Streuwert 1.54, horizontal: 1.95, vertikal: 0.99

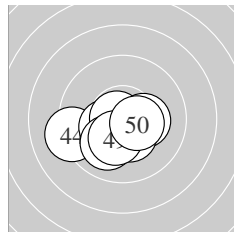

Serie 5:  
 10.2 \* 10.3 \* 10.8 \* 9.2 ← 10.4 \*  
 10.8 \* 10.4 \* 10.0 ↘ 10.3 \* 10.5 \*  
 beste Teiler 26.6 (43.) 48.3 (46.) 122.8 (50.)  
 Trefferlage 0.59 mm links, 0.84 mm tief  
 Streuwert 1.27, horizontal: 1.66, vertikal: 0.68

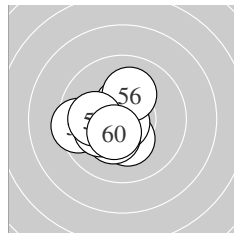

Serie 6:  
 10.0 ← 10.3 \* 9.5 ← 10.5 \* 10.8 \*  
 10.1 ↑ 10.3 \* 10.2 \* 10.0 ← 10.4 \*  
 beste Teiler 31.0 (55.) 107.2 (54.) 129.5 (60.)  
 Trefferlage 1.06 mm links, 0.30 mm tief  
 Streuwert 1.27, horizontal: 1.40, vertikal: 1.13

Meyton Elektronik

**ISSF AR Men** – Wertung – **Männer**

StandNr: 109

**Sohm, Jodok** #103

**StartNr: 154**

2. Dezember 2017 18:52

VBG

---

\_\_\_\_\_  
Unterschrift des Schützen

Meyton Elektronik

Ergebnis:	<b>614.8</b>	(588)
Serien:	103.2	103.2 103.9 103.2 100.7 100.6
Zähler:	48	12 0 0 0 0 0 0 0 0
Innenzehner:	40	
weiteste:	423	(47), 422 (60), 416 (50)
beste Teiler	35.1	(8.) 35.3 (33.) 44.2 (21.)
Trefferlage	0.08 mm	rechts, 0.55 mm hoch
Streuwert	1.37,	horizontal: 1.66, vertikal: 1.01

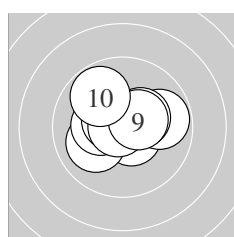
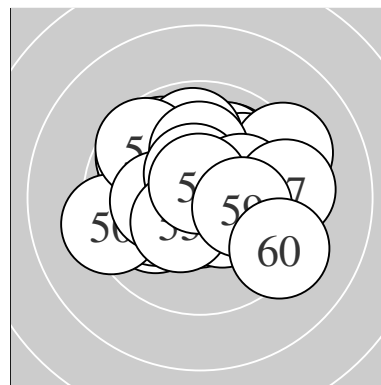

Serie 1:	10.6 *	10.6 *	9.8 →	10.0 ↙	10.3 *
	10.6 *	10.3 *	10.8 *	10.4 *	9.8 ↘
beste Teiler	35.1	(8.) 90.4	(2.) 92.6	(1.)	
Trefferlage	0.13 mm	links, 0.35 mm	hoch		
Streuwert	1.28,	horizontal: 1.56,	vertikal: 0.91		

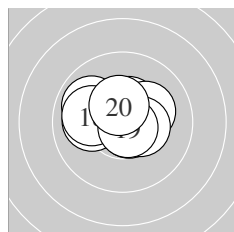

Serie 2:	10.7 *	10.5 *	10.4 *	10.2 *	9.9 ↘
	10.4 *	10.0 ←	10.0 ←	10.7 *	10.4 *
beste Teiler	56.5	(19.) 66.5	(11.) 125.7	(12.)	
Trefferlage	0.41 mm	links, 0.41 mm	hoch		
Streuwert	1.19,	horizontal: 1.54,	vertikal: 0.68		

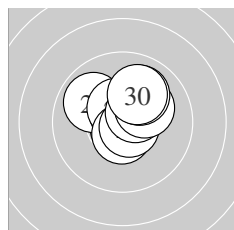

Serie 3:	10.8 *	9.9 ↘	10.7 *	10.5 *	10.6 *
	10.7 *	10.5 *	10.2 *	10.0 ↗	10.0 ↗
beste Teiler	44.2	(21.) 62.0	(26.) 71.5	(23.)	
Trefferlage	0.23 mm	rechts, 0.73 mm	hoch		
Streuwert	1.07,	horizontal: 1.11,	vertikal: 1.02		

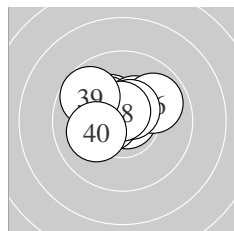

Serie 4:	10.3 *	10.3 *	10.8 *	10.4 *	10.5 *
	9.9 ↗	10.5 *	10.7 *	9.7 ↘	10.1 ←
beste Teiler	35.3	(33.) 74.5	(38.) 102.0	(37.)	
Trefferlage	0.36 mm	links, 0.75 mm	hoch		
Streuwert	1.15,	horizontal: 1.42,	vertikal: 0.77		

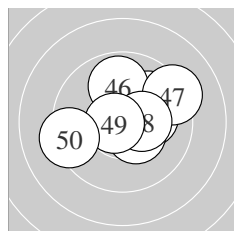

Serie 5:	10.2 *	10.4 *	10.0 ↗	10.2 *	10.3 *
	9.9 ↑	9.3 ↗	10.4 *	10.7 *	9.3 ←
beste Teiler	62.6	(49.) 133.2	(42.) 144.0	(48.)	
Trefferlage	0.62 mm	rechts, 0.74 mm	hoch		
Streuwert	1.72,	horizontal: 2.06,	vertikal: 1.29		

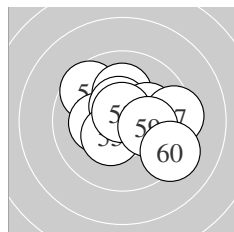

Serie 6:	9.6 ↘	10.2 *	10.1 ↑	10.5 *	10.4 *
	10.2 *	9.4 →	10.7 *	10.2 *	9.3 ↘
beste Teiler	64.2	(58.) 112.5	(54.) 140.0	(55.)	
Trefferlage	0.56 mm	rechts, 0.31 mm	hoch		
Streuwert	1.80,	horizontal: 2.14,	vertikal: 1.38		

Meyton Elektronik

**ISSF AR Men** – Wertung – **Männer**

StandNr: 110

**Cipro, Adam** #70804300

**StartNr: 155**

2. Dezember 2017 19:11

CZE – Dukla Pilsen

---

\_\_\_\_\_  
Unterschrift des Schützen

Meyton Elektronik

Ergebnis: **617.9** (592)  
 Serien: 103.2 101.5 102.7 103.7 103.6 103.2  
 Zähler: 52 8 0 0 0 0 0 0 0  
 Innenzehner: 44  
 weiteste: 410 (19), 342 (51), 318 (12)  
 beste Teiler 25.4 (33.) 37.4 (8.) 54.0 (24.)  
 Trefferlage 0.21 mm links, 0.31 mm hoch  
 Streuwert 1.27, horizontal: 1.18, vertikal: 1.35

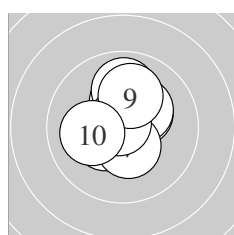
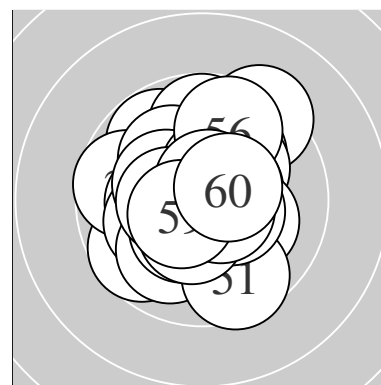

Serie 1:  
 10.3 \* 10.7 \* 10.4 \* 10.2 \* 9.9 ↑  
 10.3 \* 10.4 \* 10.8 \* 10.1 ↑ 10.1 ←  
 beste Teiler 37.4 (8.) 67.7 (2.) 136.3 (7.)  
 Trefferlage 0.03 mm links, 0.70 mm hoch  
 Streuwert 1.16, horizontal: 1.03, vertikal: 1.28

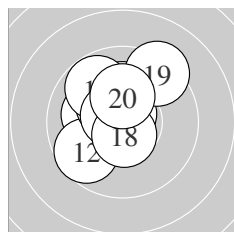

Serie 2:  
 10.1 ← 9.7 ↙ 10.3 \* 10.2 \* 10.7 \*  
 9.8 ↘ 10.6 \* 10.6 \* 9.3 ↗ 10.2 \*  
 beste Teiler 58.0 (15.) 82.0 (17.) 88.6 (18.)  
 Trefferlage 0.53 mm links, 0.93 mm hoch  
 Streuwert 1.48, horizontal: 1.40, vertikal: 1.56

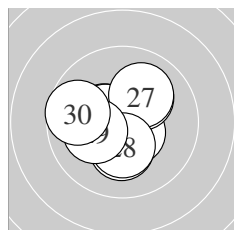

Serie 3:  
 10.2 \* 10.4 \* 10.5 \* 10.7 \* 10.1 ↗  
 10.5 \* 10.1 ↗ 10.3 \* 10.2 \* 9.7 ←  
 beste Teiler 54.0 (24.) 101.1 (23.) 124.6 (26.)  
 Trefferlage 0.42 mm links, 0.07 mm hoch  
 Streuwert 1.34, horizontal: 1.43, vertikal: 1.24

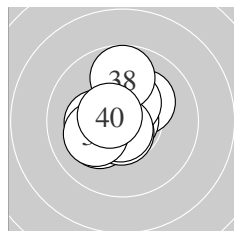

Serie 4:  
 10.2 \* 10.2 \* 10.9 \* 10.2 \* 10.6 \*  
 10.4 \* 10.7 \* 9.8 ↑ 10.1 ← 10.6 \*  
 beste Teiler 25.4 (33.) 59.6 (37.) 80.3 (35.)  
 Trefferlage 0.42 mm links, 0.25 mm hoch  
 Streuwert 1.18, horizontal: 1.07, vertikal: 1.27

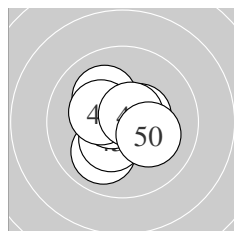

Serie 5:  
 10.0 ↙ 10.5 \* 10.5 \* 10.4 \* 10.4 \*  
 10.1 ↘ 10.6 \* 10.3 \* 10.6 \* 10.2 \*  
 beste Teiler 76.4 (49.) 83.2 (47.) 114.2 (42.)  
 Trefferlage 0.21 mm links, 0.00 mm  
 Streuwert 1.17, horizontal: 1.21, vertikal: 1.13

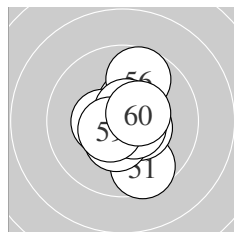

Serie 6:  
 9.6 ↘ 10.4 \* 10.4 \* 10.4 \* 10.6 \*  
 9.7 ↑ 10.4 \* 10.7 \* 10.5 \* 10.5 \*  
 beste Teiler 71.8 (58.) 86.7 (55.) 103.4 (59.)  
 Trefferlage 0.37 mm rechts, 0.06 mm tief  
 Streuwert 1.30, horizontal: 0.94, vertikal: 1.58

Meyton Elektronik

**ISSF AR Men** – Wertung – **Männer**

StandNr: 111

**Kostenzer, Thomas** #70804294

**StartNr: 156**

2. Dezember 2017 19:17

T – SG Münster

---

\_\_\_\_\_  
Unterschrift des Schützen

Meyton Elektronik

Ergebnis: **628.3** (596)<sup>QF</sup>  
 Serien: 104.1 105.4 103.8 106.0 104.9 104.1  
 Zähler: 56 4 0 0 0 0 0 0 0  
 Innenzehner: 51  
 weiteste: 301 (28), 284 (10), 263 (53)  
 beste Teiler 16.0 (8.) 26.0 (14.) 33.3 (7.)  
 Trefferlage 0.29 mm rechts, 0.16 mm hoch  
 Streuwert 0.97, horizontal: 0.99, vertikal: 0.94

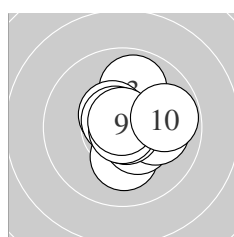
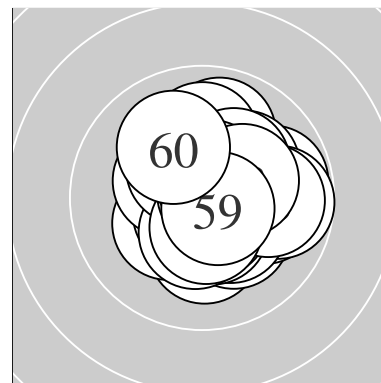

Serie 1:  
 10.2 \*                      10.4 \*                      9.9 ↑                      10.5 \*                      10.7 \*  
 10.1 →                      10.8 \*                      10.9 \*                      10.8 \*                      9.8 →  
 beste Teiler 16.0 (8.) 33.3 (7.) 38.4 (9.)  
 Trefferlage 0.57 mm rechts, 0.13 mm hoch  
 Streuwert 1.15, horizontal: 1.12, vertikal: 1.17

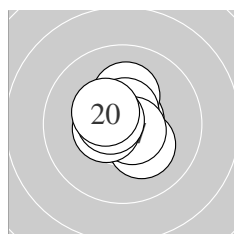

Serie 2:  
 10.7 \*                      10.8 \*                      10.2 \*                      10.8 \*                      10.2 \*  
 10.6 \*                      10.6 \*                      10.5 \*                      10.6 \*                      10.4 \*  
 beste Teiler 26.0 (14.) 47.8 (12.) 57.8 (11.)  
 Trefferlage 0.03 mm links, 0.24 mm hoch  
 Streuwert 0.82, horizontal: 0.78, vertikal: 0.86

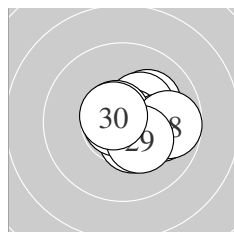

Serie 3:  
 10.1 ↗                      10.3 \*                      10.4 \*                      10.8 \*                      10.8 \*  
 10.0 →                      10.7 \*                      9.7 →                      10.3 \*                      10.7 \*  
 beste Teiler 37.0 (24.) 48.2 (25.) 65.9 (27.)  
 Trefferlage 0.91 mm rechts, 0.03 mm hoch  
 Streuwert 1.03, horizontal: 1.22, vertikal: 0.80

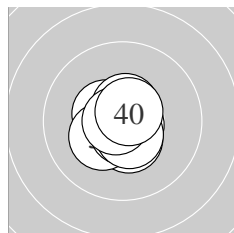

Serie 4:  
 10.6 \*                      10.5 \*                      10.7 \*                      10.5 \*                      10.3 \*  
 10.7 \*                      10.6 \*                      10.6 \*                      10.8 \*                      10.7 \*  
 beste Teiler 44.0 (39.) 56.3 (33.) 65.1 (36.)  
 Trefferlage 0.17 mm links, 0.18 mm tief  
 Streuwert 0.72, horizontal: 0.70, vertikal: 0.73

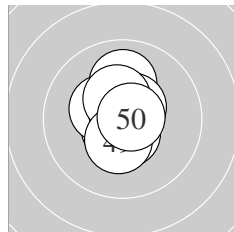

Serie 5:  
 10.0 ↑                      10.6 \*                      10.4 \*                      10.5 \*                      10.8 \*  
 10.5 \*                      10.4 \*                      10.6 \*                      10.4 \*                      10.7 \*  
 beste Teiler 46.0 (45.) 57.4 (50.) 78.8 (42.)  
 Trefferlage 0.08 mm links, 0.38 mm hoch  
 Streuwert 0.89, horizontal: 0.57, vertikal: 1.12

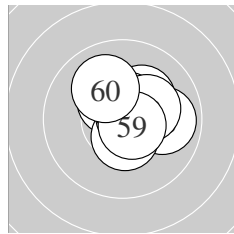

Serie 6:  
 10.4 \*                      10.7 \*                      9.9 →                      10.5 \*                      10.8 \*  
 10.2 \*                      10.6 \*                      10.3 \*                      10.7 \*                      10.0 ↘  
 beste Teiler 50.1 (55.) 69.8 (52.) 75.7 (59.)  
 Trefferlage 0.57 mm rechts, 0.41 mm hoch  
 Streuwert 1.03, horizontal: 1.09, vertikal: 0.97

Meyton Elektronik

**ISSF AR Men – Wertung – Männer**

StandNr: 112

**Schmirl, Alexander #264**

**StartNr: 157**

2. Dezember 2017 19:16

AUT

---

QF – Schütze hat sich fürs Finale qualifiziert

---

Unterschrift des Schützen

Meyton Elektronik



ISSF AR Men – Wertung – Männer

StandNr: 113

Abrudán, Zsolt #70817554

StartNr: 158

2. Dezember 2017 17:16

HUN – BHSE

Ergebnis: **0.0** (0)<sub>DNS</sub>  
Serien:  
Zähler: 0 0 0 0 0 0 0 0 0 0  
Innenzehner: 0  
weiteste:  
beste Teiler – Schütze ist nicht zum Wettkampf angetreten  
Trefferlage 0.00 mm , 0.00 mm  
Streuwert  
Unterschrift des Schützen

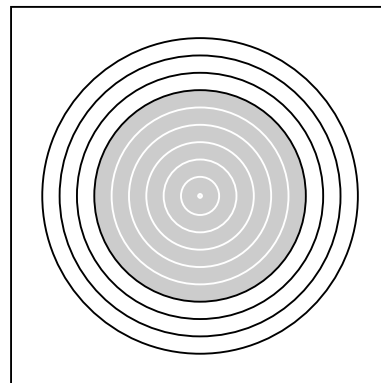

Ergebnis:	<b>621.4</b>	(594)							
Serien:	104.4	101.3	102.3	104.7	104.4	104.3			
Zähler:	54	6	0	0	0	0	0	0	0
Innenzehner:	49								
weiteste:	441	(24),	318	(15),	313	(16)			
beste Teiler	23.4	(2.)	64.5	(4.)	66.0	(41.)			
Trefferlage	0.07 mm links, 0.19 mm hoch								
Streuwert	1.21, horizontal: 1.47, vertikal: 0.87								

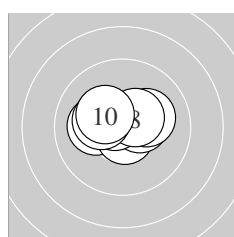
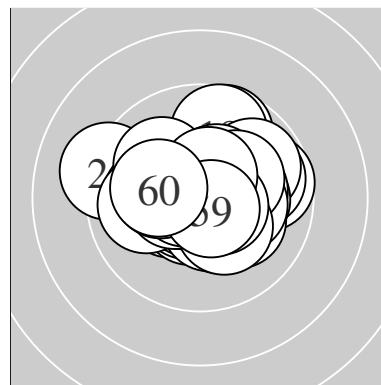

Serie 1:				
10.1 ←	10.9 *	10.3 *	10.7 *	10.4 *
10.7 *	10.2 *	10.5 *	10.3 *	10.3 *
beste Teiler	23.4 (2.)	64.5 (4.)	75.0 (6.)	
Trefferlage	0.24 mm links, 0.41 mm hoch			
Streuwert	1.01, horizontal: 1.35, vertikal: 0.48			

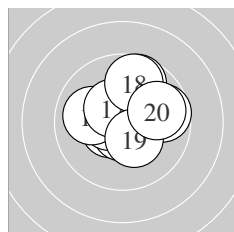

Serie 2:				
10.5 *	10.7 *	10.5 *	10.0 ←	9.7 ↑
9.7 →	10.4 *	9.7 ↑	10.3 *	9.8 →
beste Teiler	74.4 (12.)	102.2 (13.)	107.7 (11.)	
Trefferlage	0.34 mm rechts, 0.67 mm hoch			
Streuwert	1.57, horizontal: 1.70, vertikal: 1.43			

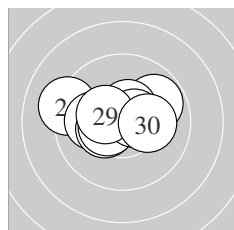

Serie 3:				
9.8 ↗	10.6 *	10.5 *	9.2 ←	10.1 ←
10.4 *	10.5 *	10.6 *	10.4 *	10.2 *
beste Teiler	93.7 (22.)	94.8 (28.)	110.8 (23.)	
Trefferlage	0.39 mm links, 0.42 mm hoch			
Streuwert	1.52, horizontal: 2.04, vertikal: 0.66			

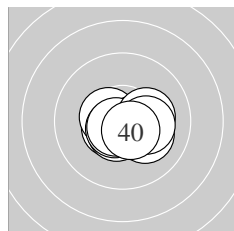

Serie 4:				
10.5 *	10.6 *	10.5 *	10.6 *	10.6 *
10.2 *	10.7 *	10.2 *	10.2 *	10.6 *
beste Teiler	68.0 (37.)	84.1 (34.)	85.6 (35.)	
Trefferlage	0.31 mm rechts, 0.41 mm tief			
Streuwert	0.89, horizontal: 1.17, vertikal: 0.45			

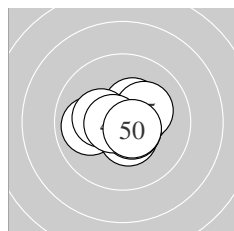

Serie 5:				
10.7 *	10.4 *	10.4 *	10.0 ←	10.2 *
10.5 *	10.6 *	10.3 *	10.7 *	10.6 *
beste Teiler	66.0 (41.)	75.1 (49.)	90.4 (50.)	
Trefferlage	0.07 mm rechts, 0.05 mm tief			
Streuwert	1.07, horizontal: 1.32, vertikal: 0.74			

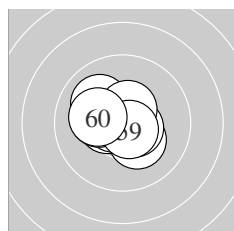

Serie 6:				
10.6 *	10.3 *	10.6 *	10.5 *	10.0 ↘
10.7 *	10.2 *	10.5 *	10.7 *	10.2 *
beste Teiler	70.0 (56.)	71.4 (59.)	91.1 (51.)	
Trefferlage	0.53 mm links, 0.11 mm hoch			
Streuwert	1.00, horizontal: 1.17, vertikal: 0.79			

Meyton Elektronik

**ISSF AR Men – Wertung – Männer**

StandNr: 114

**De, Nicolo Marco** #70817555

**StartNr: 159**

2. Dezember 2017 19:18

ITA – Fiamme Gialle

---

\_\_\_\_\_  
Unterschrift des Schützen

Meyton Elektronik

Ergebnis:	<b>627.8</b>	(597) <sup>QF</sup>							
Serien:	104.1	104.6	105.8	104.1	104.3	104.9			
Zähler:	57	3	0	0	0	0	0	0	0
Innenzehner:	54								
weiteste:	307 (37), 267 (1), 257 (13)								
beste Teiler	16.0 (6.)	23.4 (40.)	28.6 (16.)						
Trefferlage	0.08 mm rechts, 0.08 mm hoch								
Streuwert	0.99, horizontal: 0.94, vertikal: 1.04								

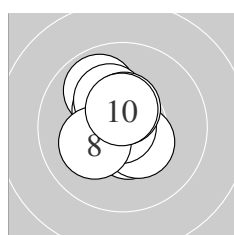
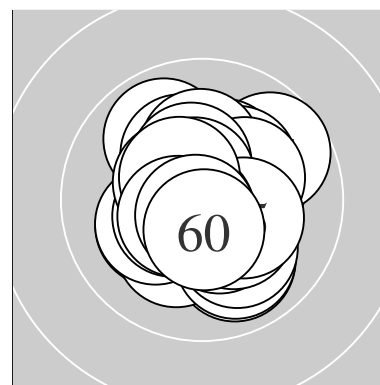

Serie 1:	9.9 ↘	10.4 *	10.6 *	10.5 *	10.4 *
	10.9 *	10.2 *	10.2 *	10.5 *	10.5 *
beste Teiler	16.0 (6.)	79.3 (3.)	104.0 (4.)		
Trefferlage	0.30 mm links, 0.37 mm hoch				
Streuwert	1.06, horizontal: 0.87, vertikal: 1.22				

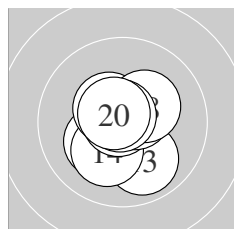

Serie 2:	10.2 *	10.7 *	9.9 ↘	10.2 *	10.5 *
	10.8 *	10.6 *	10.3 *	10.8 *	10.6 *
beste Teiler	28.6 (16.)	43.0 (19.)	62.9 (12.)		
Trefferlage	0.07 mm links, 0.24 mm tief				
Streuwert	1.05, horizontal: 0.93, vertikal: 1.15				

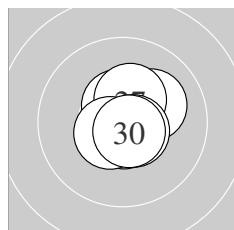

Serie 3:	10.7 *	10.1 ↗	10.8 *	10.5 *	10.8 *
	10.7 *	10.4 *	10.5 *	10.6 *	10.7 *
beste Teiler	35.0 (25.)	43.0 (23.)	57.1 (21.)		
Trefferlage	0.31 mm rechts, 0.14 mm hoch				
Streuwert	0.73, horizontal: 0.67, vertikal: 0.78				

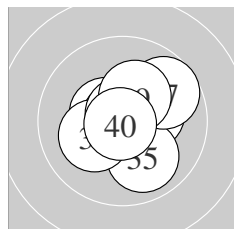

Serie 4:	10.6 *	10.5 *	10.3 *	10.8 *	10.0 ↘
	10.2 *	9.7 ↗	10.8 *	10.3 *	10.9 *
beste Teiler	23.4 (40.)	33.5 (34.)	47.5 (38.)		
Trefferlage	0.37 mm rechts, 0.16 mm hoch				
Streuwert	1.20, horizontal: 1.28, vertikal: 1.12				

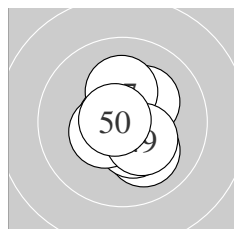

Serie 5:	10.4 *	10.2 *	10.1 ↘	10.7 *	10.4 *
	10.7 *	10.2 *	10.5 *	10.3 *	10.8 *
beste Teiler	49.7 (50.)	53.7 (46.)	54.5 (44.)		
Trefferlage	0.28 mm rechts, 0.04 mm tief				
Streuwert	1.05, horizontal: 0.91, vertikal: 1.17				

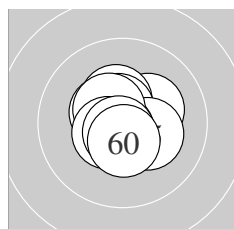

Serie 6:	10.2 *	10.4 *	10.5 *	10.6 *	10.3 *
	10.7 *	10.5 *	10.5 *	10.7 *	10.5 *
beste Teiler	52.6 (56.)	61.8 (59.)	86.6 (54.)		
Trefferlage	0.08 mm links, 0.11 mm hoch				
Streuwert	0.90, horizontal: 0.93, vertikal: 0.87				

**ISSF AR Men – Wertung – Männer**

StandNr: 115

**Zott, Georg** #70804306

**StartNr: 160**

2. Dezember 2017 18:50

AUT

---

QF – Schütze hat sich fürs Finale qualifiziert

---

Unterschrift des Schützen

Meyton Elektronik

Ergebnis:	<b>615.8</b>	(591)
Serien:	99.7	103.2 103.4 102.9 103.7 102.9
Zähler:	51	9 0 0 0 0 0 0 0 0
Innenzehner:	39	
weiteste:	383	(3), 383 (4), 371 (7)
beste Teiler	21.1	(33.) 34.5 (45.) 58.3 (32.)
Trefferlage	0.09 mm	rechts, 0.18 mm hoch
Streuwert	1.36,	horizontal: 1.40, vertikal: 1.33

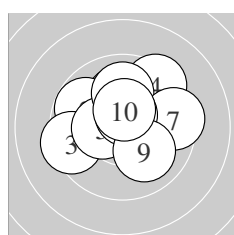
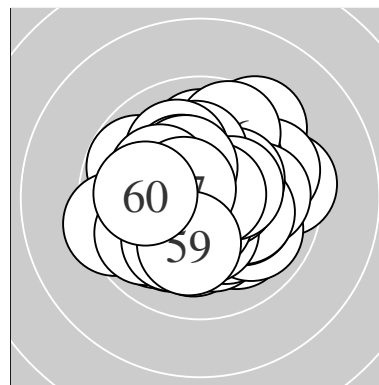

Serie 1:

10.1 ↑	9.8 ↖	9.4 ←	9.4 ↗	10.4 *
10.0 ↑	9.5 →	10.6 *	10.0 ↘	10.5 *
beste Teiler	91.7 (8.)	125.5 (10.)	144.0 (5.)	
Trefferlage	0.01 mm links, 0.87 mm hoch			
Streuwert	1.90, horizontal: 2.22, vertikal: 1.51			

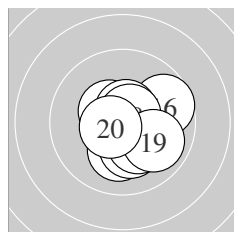

Serie 2:

10.1 ↓	10.2 *	10.7 *	10.5 *	10.2 *
9.7 →	10.6 *	10.7 *	9.9 ↘	10.6 *
beste Teiler	63.0 (13.)	71.4 (18.)	85.4 (17.)	
Trefferlage	0.51 mm rechts, 0.31 mm tief			
Streuwert	1.25, horizontal: 1.27, vertikal: 1.23			

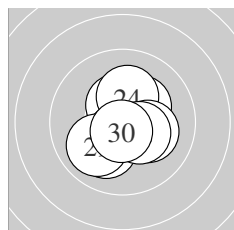

Serie 3:

10.4 *	10.6 *	10.3 *	10.2 *	10.5 *
10.2 *	10.1 ↙	10.4 *	10.0 ↘	10.7 *
beste Teiler	66.6 (30.)	93.3 (22.)	112.4 (25.)	
Trefferlage	0.04 mm rechts, 0.33 mm tief			
Streuwert	1.20, horizontal: 1.14, vertikal: 1.26			

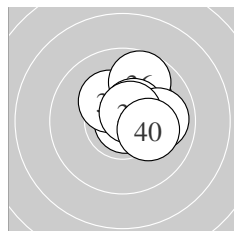

Serie 4:

10.0 ↗	10.7 *	10.9 *	10.3 *	10.1 ↗
9.7 ↗	10.5 *	9.9 →	10.6 *	10.2 *
beste Teiler	21.1 (33.)	58.3 (32.)	83.5 (39.)	
Trefferlage	0.91 mm rechts, 0.91 mm hoch			
Streuwert	1.01, horizontal: 0.94, vertikal: 1.07			

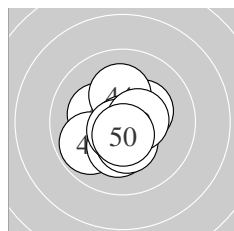

Serie 5:

10.3 *	10.2 *	9.8 ↙	10.2 *	10.8 *
10.2 *	10.4 *	10.7 *	10.5 *	10.6 *
beste Teiler	34.5 (45.)	68.9 (48.)	93.0 (50.)	
Trefferlage	0.20 mm links, 0.31 mm tief			
Streuwert	1.16, horizontal: 1.13, vertikal: 1.18			

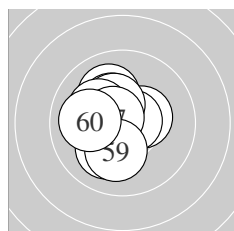

Serie 6:

10.1 ↖	10.4 *	10.7 *	10.3 *	10.4 *
10.2 *	10.6 *	10.1 ↙	10.1 ↓	10.0 ←
beste Teiler	63.0 (53.)	80.1 (57.)	141.3 (52.)	
Trefferlage	0.69 mm links, 0.30 mm hoch			
Streuwert	1.18, horizontal: 1.06, vertikal: 1.29			

**ISSF AR Men** – Wertung – **Männer**

StandNr: 116

**Entrichel, Alés** #70804305

**StartNr: 161**

2. Dezember 2017 19:01

CZE – Dukla Pilsen

---

\_\_\_\_\_  
Unterschrift des Schützen

Meyton Elektronik

Ergebnis: **613.2** (586)  
 Serien: 99.9 104.8 100.7 104.5 100.6 102.7  
 Zähler: 48 10 2 0 0 0 0 0 0  
 Innenzehner: 37  
 weiteste: 543 (7), 529 (48), 475 (29)  
 beste Teiler 16.9 (16.) 18.6 (1.) 38.4 (31.)  
 Trefferlage 0.48 mm links, 0.01 mm tief  
 Streuwert 1.54, horizontal: 1.71, vertikal: 1.33

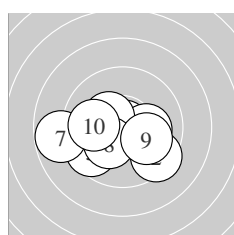
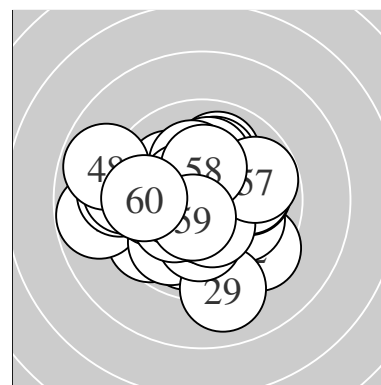

Serie 1:  
 10.9 \* 9.4 ↘ 10.1 → 10.5 \* 9.6 ↙  
 10.4 \* 8.8 ← 10.2 \* 10.0 ↘ 10.0 ←  
 beste Teiler 18.6 (1.) 104.6 (4.) 146.4 (6.)  
 Trefferlage 0.64 mm links, 0.75 mm tief  
 Streuwert 1.95, horizontal: 2.55, vertikal: 1.03

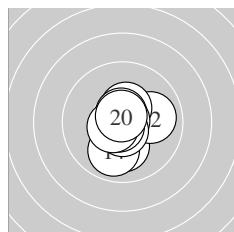

Serie 2:  
 10.1 ↓ 10.0 → 10.4 \* 9.9 ↓ 10.7 \*  
 10.9 \* 10.7 \* 10.8 \* 10.6 \* 10.7 \*  
 beste Teiler 16.9 (16.) 50.2 (18.) 54.3 (20.)  
 Trefferlage 0.06 mm rechts, 0.30 mm tief  
 Streuwert 1.06, horizontal: 0.91, vertikal: 1.19

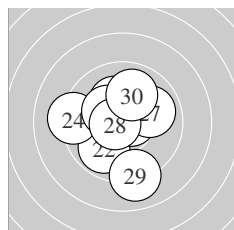

Serie 3:  
 10.2 \* 9.9 ↙ 10.7 \* 9.2 ← 10.7 \*  
 10.3 \* 9.9 → 10.7 \* 9.1 ↓ 10.0 ↑  
 beste Teiler 64.6 (25.) 67.9 (28.) 72.3 (23.)  
 Trefferlage 0.39 mm links, 0.00 mm  
 Streuwert 1.93, horizontal: 1.83, vertikal: 2.03

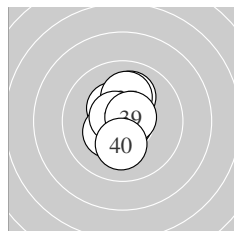

Serie 4:  
 10.8 \* 10.7 \* 10.1 ↑ 10.6 \* 10.4 \*  
 10.3 \* 10.1 ↑ 10.7 \* 10.6 \* 10.2 \*  
 beste Teiler 38.4 (31.) 66.1 (32.) 75.5 (38.)  
 Trefferlage 0.22 mm links, 0.21 mm hoch  
 Streuwert 1.04, horizontal: 0.69, vertikal: 1.30

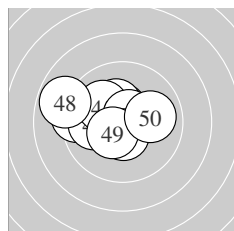

Serie 5:  
 9.4 ← 10.5 \* 10.0 ← 10.3 \* 10.1 ↘  
 10.6 \* 10.5 \* 8.8 ← 10.4 \* 10.0 →  
 beste Teiler 78.5 (46.) 110.2 (47.) 112.6 (42.)  
 Trefferlage 1.17 mm links, 0.50 mm hoch  
 Streuwert 1.70, horizontal: 2.20, vertikal: 0.99

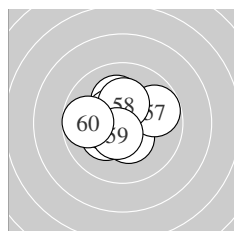

Serie 6:  
 10.4 \* 10.6 \* 10.2 \* 10.3 \* 10.4 \*  
 10.5 \* 9.8 → 10.3 \* 10.5 \* 9.7 ←  
 beste Teiler 92.2 (52.) 103.7 (59.) 120.2 (56.)  
 Trefferlage 0.54 mm links, 0.22 mm hoch  
 Streuwert 1.33, horizontal: 1.51, vertikal: 1.11

Meyton Elektronik



**ISSF AR Men** – Wertung – **Männer**

StandNr: 117

**Simo, Kornél** #70817556

**StartNr: 162**

2. Dezember 2017 19:19

HUN – BHSE

---

\_\_\_\_\_  
Unterschrift des Schützen

Meyton Elektronik

Ergebnis: **623.3** (597)  
 Serien: 103.7 102.9 104.7 103.8 102.3 105.9  
 Zähler: 57 3 0 0 0 0 0 0 0 0  
 Innenzehner: 51  
 weiteste: 319 (45), 271 (35), 267 (43)  
 beste Teiler 48.0 (30.) 51.9 (32.) 57.1 (38.)  
 Trefferlage 0.17 mm rechts, 0.38 mm hoch  
 Streuwert 1.07, horizontal: 1.11, vertikal: 1.02

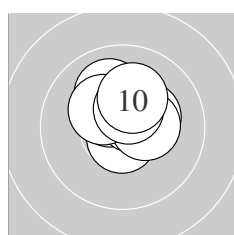
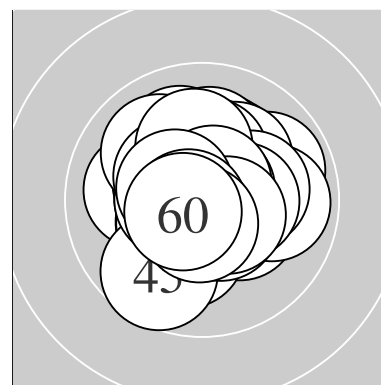

Serie 1:  
 10.7 \* 10.3 \* 10.2 \* 10.5 \* 10.0 ↗  
 10.6 \* 10.4 \* 10.3 \* 10.5 \* 10.2 \*  
 beste Teiler 69.1 (1.) 90.5 (6.) 123.0 (9.)  
 Trefferlage 0.12 mm rechts, 0.98 mm hoch  
 Streuwert 0.91, horizontal: 0.95, vertikal: 0.86

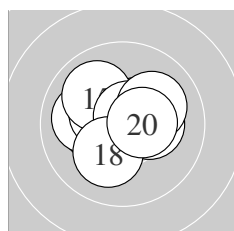

Serie 2:  
 10.3 \* 10.0 ← 10.4 \* 10.4 \* 10.0 ↘  
 10.3 \* 10.7 \* 10.2 \* 10.1 → 10.5 \*  
 beste Teiler 63.6 (17.) 125.3 (20.) 130.2 (13.)  
 Trefferlage 0.14 mm links, 0.34 mm hoch  
 Streuwert 1.29, horizontal: 1.56, vertikal: 0.94

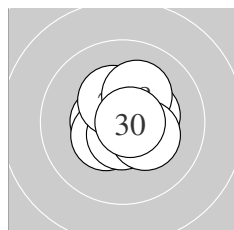

Serie 3:  
 10.6 \* 10.5 \* 10.5 \* 10.4 \* 10.4 \*  
 10.6 \* 10.4 \* 10.2 \* 10.3 \* 10.8 \*  
 beste Teiler 48.0 (30.) 80.2 (26.) 83.0 (21.)  
 Trefferlage 0.22 mm rechts, 0.26 mm hoch  
 Streuwert 0.94, horizontal: 0.96, vertikal: 0.92

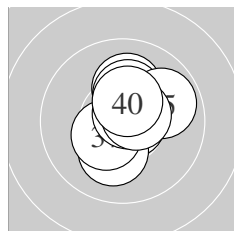

Serie 4:  
 10.1 ↑ 10.7 \* 10.5 \* 10.3 \* 9.9 →  
 10.2 \* 10.4 \* 10.7 \* 10.6 \* 10.4 \*  
 beste Teiler 51.9 (32.) 57.1 (38.) 94.4 (39.)  
 Trefferlage 0.43 mm rechts, 0.49 mm hoch  
 Streuwert 1.08, horizontal: 0.93, vertikal: 1.20

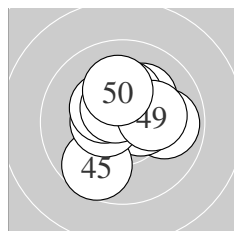

Serie 5:  
 10.2 \* 10.3 \* 9.9 → 10.5 \* 9.7 ↙  
 10.5 \* 10.4 \* 10.5 \* 10.2 \* 10.1 ↑  
 beste Teiler 102.4 (48.) 111.0 (46.) 115.2 (44.)  
 Trefferlage 0.25 mm rechts, 0.46 mm hoch  
 Streuwert 1.39, horizontal: 1.43, vertikal: 1.34

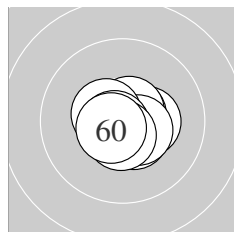

Serie 6:  
 10.4 \* 10.5 \* 10.7 \* 10.7 \* 10.5 \*  
 10.5 \* 10.7 \* 10.7 \* 10.6 \* 10.6 \*  
 beste Teiler 60.5 (58.) 67.4 (53.) 69.4 (57.)  
 Trefferlage 0.13 mm rechts, 0.23 mm tief  
 Streuwert 0.69, horizontal: 0.81, vertikal: 0.55

Meyton Elektronik

**ISSF AR Men** – Wertung – **Männer**

StandNr: 118

**Raynaud, Alexis** #70817557

**StartNr: 163**

2. Dezember 2017 19:12

FRA

---

\_\_\_\_\_  
Unterschrift des Schützen

Meyton Elektronik

Ergebnis:	<b>625.8</b>	(597) <sup>QF</sup>							
Serien:	103.8	102.2	105.0	105.0	105.5	104.3			
Zähler:	57	3	0	0	0	0	0	0	0
Innenzehner:	55								
weiteste:	381	(13), 320	(18), 300	(36)					
beste Teiler	29.9	(9.)	31.3	(27.)	35.3	(22.)			
Trefferlage	0.08	mm rechts,	0.03	mm tief					
Streuwert	1.04,	horizontal: 1.11,	vertikal: 0.97						

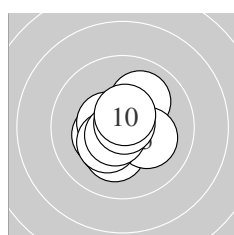
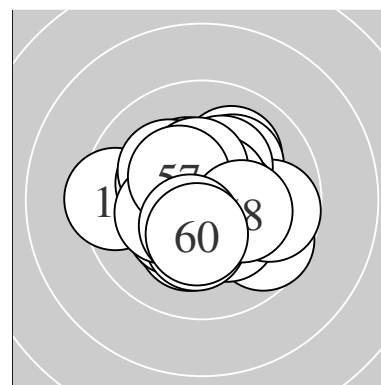

Serie 1:						
	10.3 *	10.3 *	10.2 *	10.0 ↗	10.2 *	
	10.5 *	10.3 *	10.6 *	10.8 *	10.6 *	
beste Teiler	29.9	(9.)	79.9	(8.)	91.5	(10.)
Trefferlage	0.24	mm links,	0.27	mm tief		
Streuwert	1.09,	horizontal: 1.08,	vertikal: 1.11			

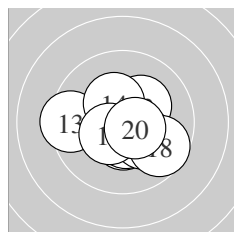

Serie 2:						
	10.6 *	10.2 *	9.4 ←	10.3 *	10.4 *	
	10.5 *	10.2 *	9.7 ↘	10.4 *	10.5 *	
beste Teiler	89.8	(11.)	101.0	(20.)	117.2	(16.)
Trefferlage	0.09	mm rechts,	0.32	mm tief		
Streuwert	1.48,	horizontal: 1.77,	vertikal: 1.12			

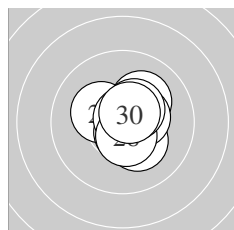

Serie 3:						
	10.1 ↗	10.8 *	10.3 *	10.3 *	10.4 *	
	10.7 *	10.8 *	10.5 *	10.5 *	10.6 *	
beste Teiler	31.3	(27.)	35.3	(22.)	75.1	(26.)
Trefferlage	0.43	mm rechts,	0.15	mm hoch		
Streuwert	0.88,	horizontal: 0.84,	vertikal: 0.91			

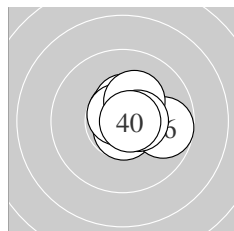

Serie 4:						
	10.7 *	10.5 *	10.6 *	10.7 *	10.5 *	
	9.8 →	10.7 *	10.3 *	10.5 *	10.7 *	
beste Teiler	55.0	(40.)	60.0	(37.)	61.6	(34.)
Trefferlage	0.63	mm rechts,	0.43	mm hoch		
Streuwert	0.83,	horizontal: 0.95,	vertikal: 0.69			

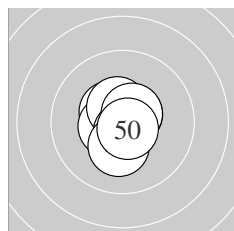

Serie 5:						
	10.5 *	10.7 *	10.6 *	10.5 *	10.6 *	
	10.5 *	10.6 *	10.6 *	10.2 *	10.7 *	
beste Teiler	59.5	(42.)	61.4	(50.)	77.5	(47.)
Trefferlage	0.13	mm links,	0.02	mm tief		
Streuwert	0.76,	horizontal: 0.62,	vertikal: 0.88			

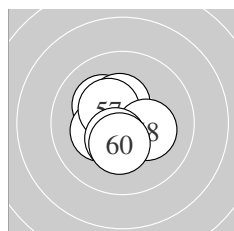

Serie 6:						
	10.8 *	10.6 *	10.2 *	10.4 *	10.6 *	
	10.3 *	10.4 *	10.2 *	10.5 *	10.3 *	
beste Teiler	40.4	(51.)	85.0	(52.)	99.6	(55.)
Trefferlage	0.25	mm links,	0.20	mm tief		
Streuwert	1.02,	horizontal: 0.98,	vertikal: 1.05			

Meyton Elektronik

**ISSF AR Men – Wertung – Männer**

StandNr: 119

**Höllwarth, Michael #30**

**StartNr: 164**

2. Dezember 2017 19:17

AUT

---

QF – Schütze hat sich fürs Finale qualifiziert

---

Unterschrift des Schützen

Meyton Elektronik

Ergebnis: **621.4** (594)  
 Serien: 104.7 103.2 105.0 101.5 103.1 103.9  
 Zähler: 54 6 0 0 0 0 0 0 0  
 Innenzehner: 45  
 weiteste: 494 (38), 386 (40), 315 (42)  
 beste Teiler 25.3 (22.) 27.2 (54.) 36.4 (45.)  
 Trefferlage 0.49 mm rechts, 0.06 mm tief  
 Streuwert 1.20, horizontal: 1.27, vertikal: 1.13

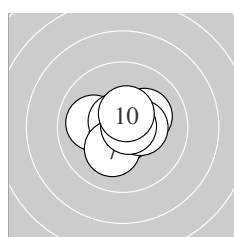
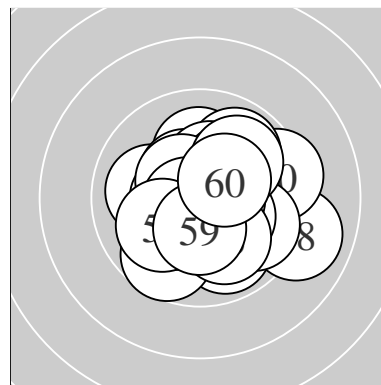

Serie 1:  
 10.6 \*                      10.6 \*                      10.0 ←                      10.7 \*                      10.7 \*  
 10.2 \*                      10.2 \*                      10.4 \*                      10.8 \*                      10.5 \*  
 beste Teiler 48.3 (9.) 52.4 (5.) 70.8 (4.)  
 Trefferlage 0.23 mm rechts, 0.10 mm hoch  
 Streuwert 1.01, horizontal: 1.20, vertikal: 0.79

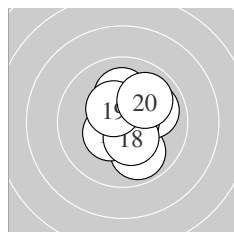

Serie 2:  
 9.9 ↘                      10.0 →                      10.7 \*                      10.5 \*                      10.8 \*  
 10.1 ↑                      10.4 \*                      10.4 \*                      10.4 \*                      10.0 ↗  
 beste Teiler 37.3 (15.) 70.0 (13.) 120.7 (14.)  
 Trefferlage 0.58 mm rechts, 0.23 mm hoch  
 Streuwert 1.24, horizontal: 1.03, vertikal: 1.42

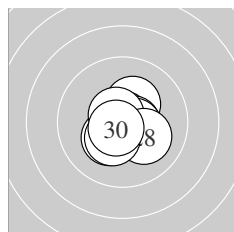

Serie 3:  
 10.3 \*                      10.9 \*                      10.3 \*                      10.6 \*                      10.6 \*  
 10.6 \*                      10.6 \*                      10.1 ↘                      10.3 \*                      10.7 \*  
 beste Teiler 25.3 (22.) 71.5 (30.) 76.4 (27.)  
 Trefferlage 0.08 mm rechts, 0.31 mm tief  
 Streuwert 0.90, horizontal: 0.92, vertikal: 0.88

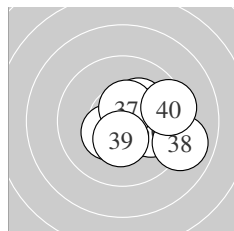

Serie 4:  
 10.2 \*                      10.4 \*                      10.5 \*                      10.4 \*                      10.7 \*  
 10.0 →                      10.5 \*                      9.0 →                      10.4 \*                      9.4 →  
 beste Teiler 68.7 (35.) 104.4 (33.) 109.7 (37.)  
 Trefferlage 1.36 mm rechts, 0.16 mm tief  
 Streuwert 1.45, horizontal: 1.75, vertikal: 1.09

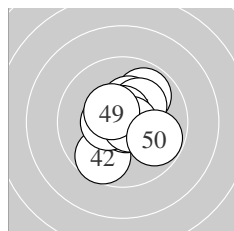

Serie 5:  
 9.9 ↗                      9.7 ↙                      10.3 \*                      10.2 \*                      10.8 \*  
 10.7 \*                      10.5 \*                      10.7 \*                      10.5 \*                      9.8 ↘  
 beste Teiler 36.4 (45.) 62.3 (48.) 69.0 (46.)  
 Trefferlage 0.32 mm rechts, 0.19 mm hoch  
 Streuwert 1.37, horizontal: 1.31, vertikal: 1.42

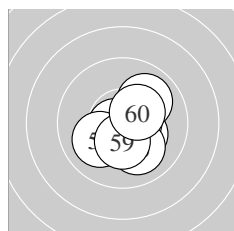

Serie 6:  
 10.3 \*                      10.6 \*                      10.5 \*                      10.8 \*                      10.7 \*  
 10.1 ↘                      10.1 ←                      10.0 ↗                      10.4 \*                      10.4 \*  
 beste Teiler 27.2 (54.) 64.4 (55.) 90.1 (52.)  
 Trefferlage 0.37 mm rechts, 0.43 mm tief  
 Streuwert 1.12, horizontal: 1.12, vertikal: 1.12

Meyton Elektronik

**ISSF AR Men – Wertung – Männer**

StandNr: 120

**Monnier, Jérémy** #70817558

**StartNr: 165**

2. Dezember 2017 19:23

FRA

---

\_\_\_\_\_  
Unterschrift des Schützen

Meyton Elektronik

Ergebnis:	<b>622.4</b>	(593)					
Serien:	104.4	104.2	103.5	102.8	104.0	103.5	
Zähler:	53	7	0	0	0	0	0
Innenzehner:	48						
weiteste:	420 (34), 322 (54), 292 (60)						
beste Teiler	5.6 (52.) 37.4 (10.) 42.7 (28.)						
Trefferlage	0.09 mm rechts, 0.68 mm hoch						
Streuwert	1.08, horizontal: 1.19, vertikal: 0.96						

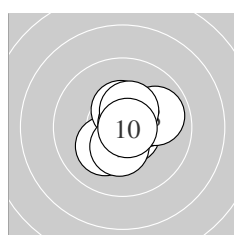
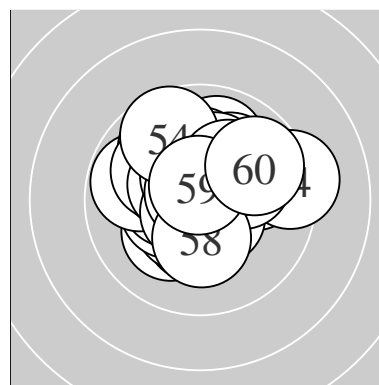

Serie 1:	10.2 *	10.4 *	10.7 *	10.8 *	10.6 *
	10.2 *	10.4 *	9.9 ↗	10.4 *	10.8 *
beste Teiler	37.4 (10.) 46.4 (4.) 63.6 (3.)				
Trefferlage	0.48 mm rechts, 0.07 mm hoch				
Streuwert	1.02, horizontal: 1.03, vertikal: 1.00				

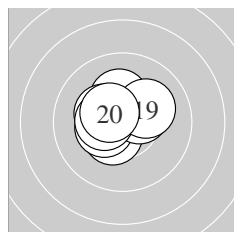

Serie 2:	10.8 *	10.5 *	10.4 *	10.6 *	10.2 *
	10.3 *	10.4 *	10.4 *	10.1 ↗	10.5 *
beste Teiler	50.0 (11.) 93.9 (14.) 122.4 (20.)				
Trefferlage	0.39 mm links, 0.43 mm hoch				
Streuwert	0.96, horizontal: 1.10, vertikal: 0.79				

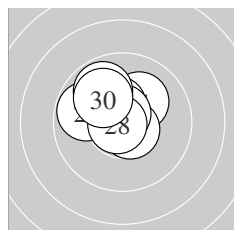

Serie 3:	10.2 *	10.7 *	10.6 *	10.4 *	10.5 *
	10.7 *	9.8 ↖	10.8 *	9.8 ↖	10.0 ↖
beste Teiler	42.7 (28.) 56.2 (22.) 63.7 (26.)				
Trefferlage	0.55 mm links, 0.91 mm hoch				
Streuwert	1.01, horizontal: 1.13, vertikal: 0.88				

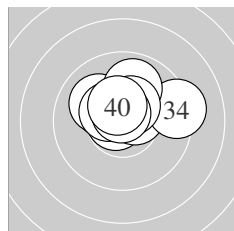

Serie 4:	10.3 *	10.7 *	10.5 *	9.3 ↗	10.1 ↖
	10.4 *	9.9 ↑	10.4 *	10.7 *	10.5 *
beste Teiler	52.0 (32.) 60.0 (39.) 103.7 (33.)				
Trefferlage	0.11 mm rechts, 0.98 mm hoch				
Streuwert	1.27, horizontal: 1.68, vertikal: 0.66				

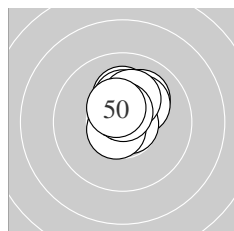

Serie 5:	10.2 *	10.4 *	10.1 ↗	10.2 *	10.8 *
	10.3 *	10.7 *	10.2 *	10.6 *	10.5 *
beste Teiler	50.5 (45.) 73.7 (47.) 77.1 (49.)				
Trefferlage	0.35 mm rechts, 1.08 mm hoch				
Streuwert	0.76, horizontal: 0.66, vertikal: 0.85				

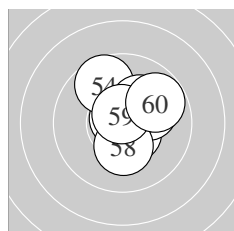

Serie 6:	10.5 *	10.9 *	10.8 *	9.7 ↖	10.5 *
	10.1 ↗	10.2 *	10.3 *	10.7 *	9.8 ↗
beste Teiler	5.6 (52.) 44.8 (53.) 67.4 (59.)				
Trefferlage	0.57 mm rechts, 0.59 mm hoch				
Streuwert	1.21, horizontal: 1.14, vertikal: 1.28				

Meyton Elektronik



**ISSF AR Men** – Wertung – **Männer**

StandNr: 121

**Mathis, Thomas** #266

**StartNr: 166**

2. Dezember 2017 18:54

AUT

---

\_\_\_\_\_  
Unterschrift des Schützen

Meyton Elektronik

Ergebnis: **616.7** (592)  
 Serien: 101.7 102.0 103.2 102.4 102.8 104.6  
 Zähler: 52 8 0 0 0 0 0 0 0  
 Innenzehner: 43  
 weiteste: 443 (33), 392 (9), 362 (41)  
 beste Teiler 6.0 (53.) 21.5 (56.) 27.6 (47.)  
 Trefferlage 0.60 mm rechts, 0.32 mm tief  
 Streuwert 1.26, horizontal: 1.43, vertikal: 1.05

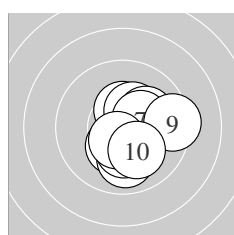
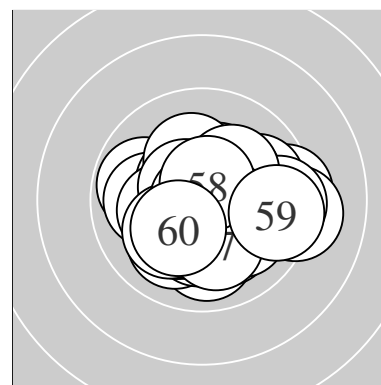

Serie 1:  
 10.3 \* 10.0 ↓ 10.4 \* 10.3 \* 10.1 ↗  
 10.3 \* 10.3 \* 10.5 \* 9.4 → 10.1 ↘  
 beste Teiler 110.3 (8.) 134.0 (3.) 151.6 (4.)  
 Trefferlage 0.82 mm rechts, 0.39 mm tief  
 Streuwert 1.40, horizontal: 1.34, vertikal: 1.46

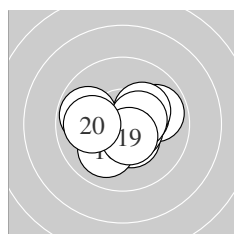

Serie 2:  
 9.9 → 10.3 \* 10.2 \* 10.4 \* 9.8 ←  
 10.0 ↙ 10.5 \* 10.4 \* 10.5 \* 10.0 ←  
 beste Teiler 102.0 (17.) 106.9 (19.) 128.8 (18.)  
 Trefferlage 0.24 mm rechts, 0.09 mm tief  
 Streuwert 1.43, horizontal: 1.77, vertikal: 0.99

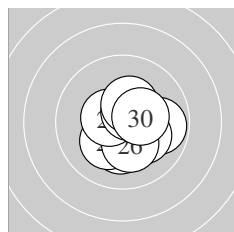

Serie 3:  
 10.2 \* 9.8 → 10.7 \* 10.2 \* 10.2 \*  
 10.2 \* 10.5 \* 10.6 \* 10.4 \* 10.4 \*  
 beste Teiler 66.4 (23.) 96.5 (28.) 109.7 (27.)  
 Trefferlage 0.55 mm rechts, 0.38 mm tief  
 Streuwert 1.15, horizontal: 1.18, vertikal: 1.11

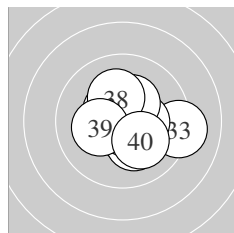

Serie 4:  
 10.6 \* 10.2 \* 9.2 → 10.5 \* 10.7 \*  
 10.4 \* 10.3 \* 10.2 \* 10.2 \* 10.1 ↘  
 beste Teiler 62.6 (35.) 93.1 (31.) 120.2 (34.)  
 Trefferlage 0.62 mm rechts, 0.17 mm tief  
 Streuwert 1.44, horizontal: 1.67, vertikal: 1.18

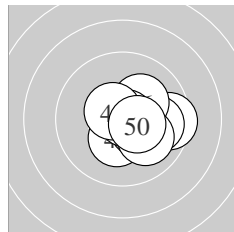

Serie 5:  
 9.5 → 10.3 \* 10.6 \* 10.4 \* 9.9 →  
 10.2 \* 10.8 \* 10.0 ↘ 10.6 \* 10.5 \*  
 beste Teiler 27.6 (47.) 95.1 (43.) 98.2 (49.)  
 Trefferlage 1.17 mm rechts, 0.27 mm tief  
 Streuwert 1.11, horizontal: 1.32, vertikal: 0.84

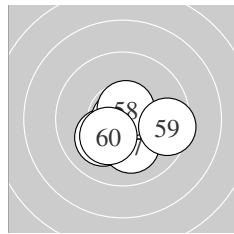

Serie 6:  
 10.8 \* 10.1 ↙ 10.9 \* 10.8 \* 10.6 \*  
 10.9 \* 10.1 ↓ 10.6 \* 9.5 → 10.3 \*  
 beste Teiler 6.0 (53.) 21.5 (56.) 42.1 (54.)  
 Trefferlage 0.21 mm rechts, 0.61 mm tief  
 Streuwert 1.11, horizontal: 1.36, vertikal: 0.80

Meyton Elektronik

**ISSF AR Men** – Wertung – **Männer**

StandNr: 122

**Patka, Hannes** #318

**StartNr: 167**

2. Dezember 2017 19:24

T – SG Mieming

---

Unterschrift des Schützen

---

Meyton Elektronik

Ergebnis: **619.7** (593)  
 Serien: 104.9 103.9 103.2 102.5 101.7 103.5  
 Zähler: 54 5 1 0 0 0 0 0 0  
 Innenzehner: 45  
 weiteste: 531 (42), 314 (37), 311 (39)  
 beste Teiler 20.6 (7.) 65.0 (50.) 66.1 (32.)  
 Trefferlage 0.06 mm rechts, 0.22 mm hoch  
 Streuwert 1.25, horizontal: 1.46, vertikal: 1.01

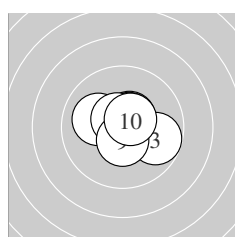
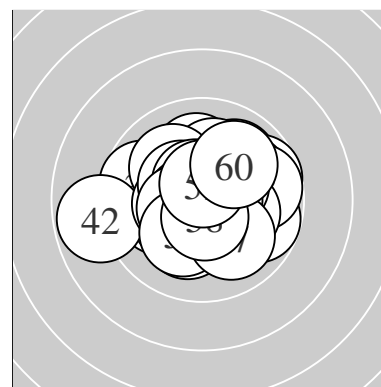

Serie 1:  
 10.5 \* 10.6 \* 9.8 ↘ 10.6 \* 10.7 \*  
 10.1 ↖ 10.9 \* 10.6 \* 10.5 \* 10.6 \*  
 beste Teiler 20.6 (7.) 70.7 (5.) 84.8 (8.)  
 Trefferlage 0.08 mm rechts, 0.26 mm hoch  
 Streuwert 1.03, horizontal: 1.27, vertikal: 0.72

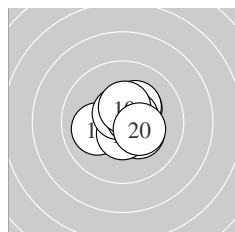

Serie 2:  
 10.3 \* 10.1 ← 10.4 \* 10.3 \* 10.6 \*  
 10.3 \* 10.6 \* 10.6 \* 10.4 \* 10.3 \*  
 beste Teiler 83.1 (17.) 92.5 (18.) 98.0 (15.)  
 Trefferlage 0.39 mm rechts, 0.30 mm hoch  
 Streuwert 1.02, horizontal: 1.08, vertikal: 0.96

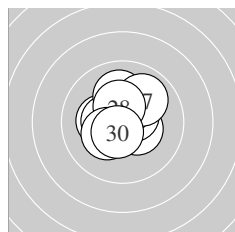

Serie 3:  
 10.2 \* 10.4 \* 10.5 \* 10.4 \* 10.4 \*  
 10.1 ↑ 9.9 ↗ 10.4 \* 10.3 \* 10.6 \*  
 beste Teiler 96.6 (30.) 105.1 (23.) 131.7 (25.)  
 Trefferlage 0.13 mm links, 0.50 mm hoch  
 Streuwert 1.15, horizontal: 1.15, vertikal: 1.14

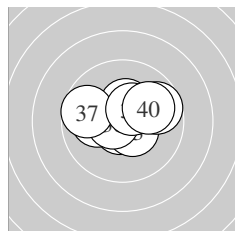

Serie 4:  
 10.4 \* 10.7 \* 10.5 \* 10.1 ← 10.4 \*  
 10.6 \* 9.7 ← 10.4 \* 9.7 → 10.0 →  
 beste Teiler 66.1 (32.) 83.3 (36.) 116.7 (33.)  
 Trefferlage 0.20 mm rechts, 0.40 mm hoch  
 Streuwert 1.42, horizontal: 1.85, vertikal: 0.79

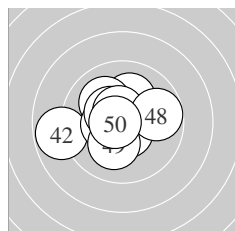

Serie 5:  
 10.1 ↗ 8.8 ← 10.1 ↘ 10.6 \* 10.4 \*  
 10.4 \* 10.6 \* 9.8 → 10.2 \* 10.7 \*  
 beste Teiler 65.0 (50.) 91.2 (44.) 93.4 (47.)  
 Trefferlage 0.70 mm links, 0.21 mm hoch  
 Streuwert 1.68, horizontal: 2.05, vertikal: 1.20

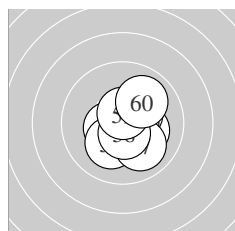

Serie 6:  
 10.4 \* 10.5 \* 10.2 \* 10.4 \* 10.6 \*  
 10.2 \* 10.0 ↘ 10.6 \* 10.6 \* 10.0 ↗  
 beste Teiler 83.1 (59.) 86.0 (55.) 88.1 (58.)  
 Trefferlage 0.55 mm rechts, 0.33 mm tief  
 Streuwert 1.12, horizontal: 1.04, vertikal: 1.19

Meyton Elektronik

**ISSF AR Men – Wertung – Männer**

StandNr: 123

**Rumpler, Stefan** #112

**StartNr: 168**

2. Dezember 2017 19:07

AUT

---

\_\_\_\_\_  
Unterschrift des Schützen

Meyton Elektronik

Ergebnis:	<b>624.3</b>	(596) <sup>QF</sup>							
Serien:	100.5	104.4	105.2	105.2	103.8	105.2			
Zähler:	56	4	0	0	0	0	0	0	0
Innenzehner:	46								
weiteste:	337 (10), 317 (5), 309 (7)								
beste Teiler	9.0 (31.)	24.7 (59.)	30.6 (11.)						
Trefferlage	0.28 mm rechts, 0.02 mm hoch								
Streuwert	1.10, horizontal: 1.18, vertikal: 1.01								

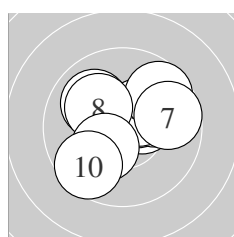
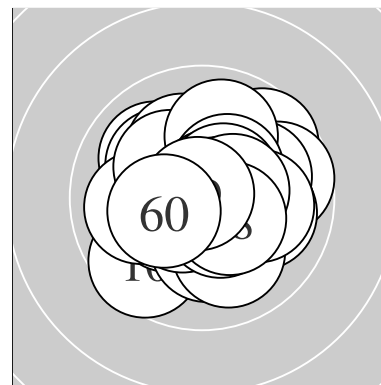

Serie 1:	10.4 *	10.4 *	10.0 →	10.4 *	9.7 ↗
	10.0 ↘	9.7 →	10.1 ↖	10.2 *	9.6 ↙
beste Teiler	134.6 (2.) 137.6 (1.) 149.4 (4.)				
Trefferlage	0.40 mm rechts, 0.52 mm hoch				
Streuwert	1.69, horizontal: 1.94, vertikal: 1.39				

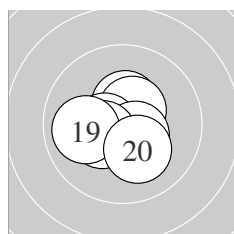

Serie 2:	10.8 *	10.7 *	10.4 *	10.5 *	10.4 *
	10.5 *	10.5 *	10.4 *	10.0 ←	10.2 *
beste Teiler	30.6 (11.) 52.1 (12.) 111.2 (17.)				
Trefferlage	0.37 mm links, 0.25 mm tief				
Streuwert	0.99, horizontal: 1.13, vertikal: 0.83				

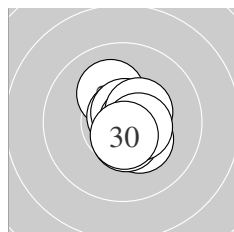

Serie 3:	10.6 *	10.1 ↖	10.3 *	10.8 *	10.5 *
	10.7 *	10.7 *	10.4 *	10.5 *	10.6 *
beste Teiler	38.8 (24.) 64.5 (26.) 67.0 (27.)				
Trefferlage	0.43 mm rechts, 0.00 mm				
Streuwert	0.79, horizontal: 0.63, vertikal: 0.93				

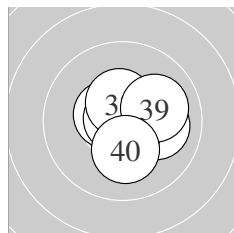

Serie 4:	10.9 *	10.8 *	10.5 *	10.1 →	10.6 *
	10.8 *	10.8 *	10.5 *	10.0 →	10.2 *
beste Teiler	9.0 (31.) 33.4 (32.) 36.0 (36.)				
Trefferlage	0.35 mm rechts, 0.01 mm tief				
Streuwert	0.95, horizontal: 1.02, vertikal: 0.87				

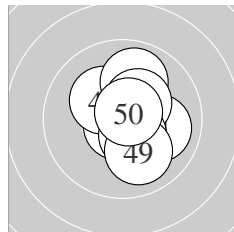

Serie 5:	10.0 →	10.8 *	10.7 *	10.6 *	10.2 *
	9.9 ↑	10.4 *	10.5 *	10.0 ↓	10.7 *
beste Teiler	37.1 (42.) 56.2 (43.) 61.0 (50.)				
Trefferlage	0.47 mm rechts, 0.15 mm hoch				
Streuwert	1.15, horizontal: 0.97, vertikal: 1.30				

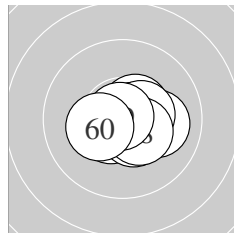

Serie 6:	10.5 *	10.5 *	10.8 *	10.5 *	10.1 →
	10.7 *	10.5 *	10.4 *	10.9 *	10.3 *
beste Teiler	24.7 (59.) 41.1 (53.) 59.2 (56.)				
Trefferlage	0.40 mm rechts, 0.23 mm tief				
Streuwert	0.85, horizontal: 1.07, vertikal: 0.54				

Meyton Elektronik

**ISSF AR Men – Wertung – Männer**

StandNr: 124

**Baudouin, Brian** #70804692

**StartNr: 169**

2. Dezember 2017 19:14

FRA

---

QF – Schütze hat sich fürs Finale qualifiziert

---

Unterschrift des Schützen

Meyton Elektronik

Ergebnis: **601.1** (577)  
 Serien: 100.7 97.0 102.1 100.3 99.6 101.4  
 Zähler: 37 23 0 0 0 0 0 0 0 0  
 Innenzehner: 32  
 weiteste: 478 (20), 477 (48), 470 (16)  
 beste Teiler 46.0 (29.) 50.1 (34.) 55.0 (55.)  
 Trefferlage 0.26 mm links, 0.39 mm hoch  
 Streuwert 1.88, horizontal: 2.25, vertikal: 1.42

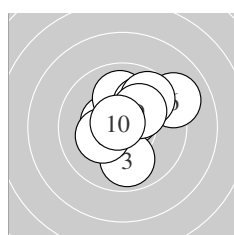
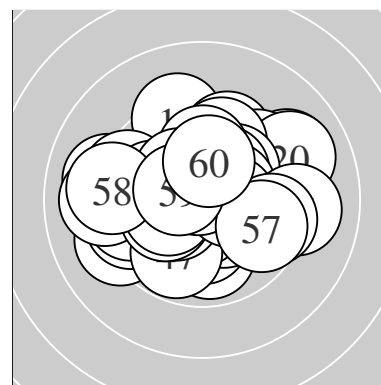

Serie 1:  
 10.4 \* 10.5 \* 9.9 ↓ 10.0 ↑ 10.0 ↗  
 9.1 ↗ 9.7 ↗ 10.2 \* 10.2 \* 10.7 \*  
 beste Teiler 55.2 (10.) 111.1 (2.) 127.4 (1.)  
 Trefferlage 0.66 mm rechts, 0.83 mm hoch  
 Streuwert 1.63, horizontal: 1.69, vertikal: 1.57

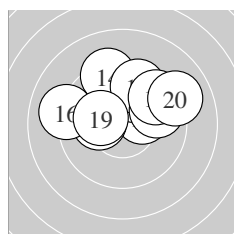

Serie 2:  
 10.3 \* 9.9 ↑ 10.2 \* 9.3 ↑ 9.6 ↑  
 9.1 ← 9.8 ↗ 9.6 ↗ 10.2 \* 9.0 ↗  
 beste Teiler 171.2 (11.) 185.8 (19.) 192.4 (13.)  
 Trefferlage 0.39 mm rechts, 1.70 mm hoch  
 Streuwert 2.11, horizontal: 2.72, vertikal: 1.24

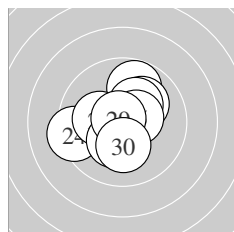

Serie 3:  
 9.8 ↑ 10.1 ↗ 10.3 \* 9.3 ← 10.5 \*  
 10.6 \* 10.2 \* 10.3 \* 10.8 \* 10.2 \*  
 beste Teiler 46.0 (29.) 91.0 (26.) 117.0 (25.)  
 Trefferlage 0.30 mm links, 0.22 mm hoch  
 Streuwert 1.56, horizontal: 1.67, vertikal: 1.43

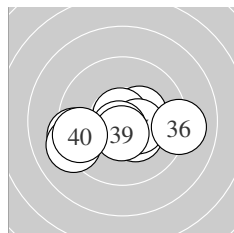

Serie 4:  
 10.4 \* 9.3 ← 10.3 \* 10.8 \* 10.4 \*  
 9.1 → 9.2 ← 10.7 \* 10.6 \* 9.5 ←  
 beste Teiler 50.1 (34.) 67.0 (38.) 100.4 (39.)  
 Trefferlage 0.37 mm links, 0.67 mm tief  
 Streuwert 2.02, horizontal: 2.75, vertikal: 0.78

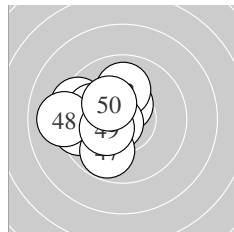

Serie 5:  
 10.5 \* 10.0 ↑ 9.4 ← 9.5 ← 10.7 \*  
 10.0 ← 9.8 ↓ 9.0 ← 10.4 \* 10.3 \*  
 beste Teiler 62.2 (45.) 121.5 (41.) 148.2 (49.)  
 Trefferlage 1.81 mm links, 0.23 mm hoch  
 Streuwert 1.55, horizontal: 1.69, vertikal: 1.41

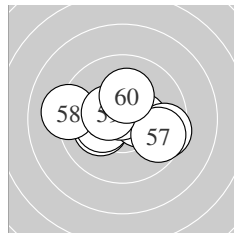

Serie 6:  
 10.2 \* 10.7 \* 10.3 \* 10.4 \* 10.7 \*  
 9.5 → 9.7 → 9.2 ← 10.5 \* 10.2 \*  
 beste Teiler 55.0 (55.) 75.1 (52.) 123.9 (59.)  
 Trefferlage 0.14 mm links, 0.06 mm hoch  
 Streuwert 1.78, horizontal: 2.33, vertikal: 0.96



**ISSF AR Men – Wertung – Männer**

StandNr: 125

**Insam, Fabian** #70418009

**StartNr: 170**

2. Dezember 2017 19:20

T – SG Fügenberg

---

\_\_\_\_\_  
Unterschrift des Schützen

Meyton Elektronik

Ergebnis:	<b>629.7</b>	(596) <sup>QF</sup>
Serien:	106.4	105.6 106.3 104.7 104.2 102.5
Zähler:	56	4 0 0 0 0 0 0 0 0
Innenzehner:	54	
weiteste:	391	(51), 318 (43), 296 (56)
beste Teiler	3.0	(1.) 23.0 (34.) 35.0 (52.)
Trefferlage	0.02 mm	rechts, 0.02 mm tief
Streuwert	0.97,	horizontal: 1.03, vertikal: 0.90

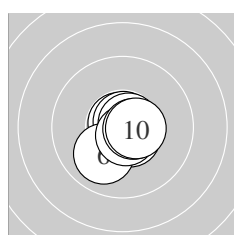
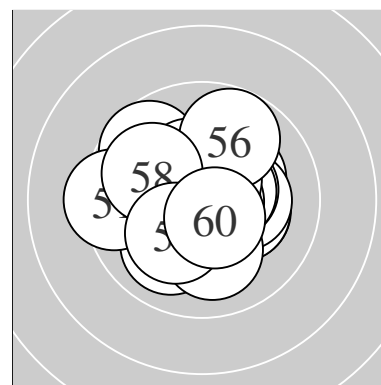

Serie 1:	10.9 *	10.8 *	10.8 *	10.6 *	10.7 *
	10.0 ↙	10.7 *	10.7 *	10.6 *	10.6 *
beste Teiler	3.0	(1.) 40.4 (3.)	44.5 (2.)		
Trefferlage	0.19 mm	rechts, 0.26 mm	tief		
Streuwert	0.69,	horizontal: 0.67,	vertikal: 0.70		

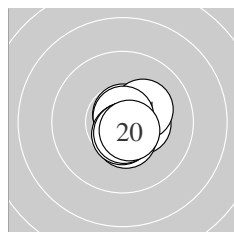

Serie 2:	10.4 *	10.7 *	10.6 *	10.2 *	10.8 *
	10.6 *	10.5 *	10.6 *	10.6 *	10.6 *
beste Teiler	42.4	(15.) 58.0 (12.)	76.0 (13.)		
Trefferlage	0.43 mm	rechts, 0.30 mm	tief		
Streuwert	0.64,	horizontal: 0.55,	vertikal: 0.72		

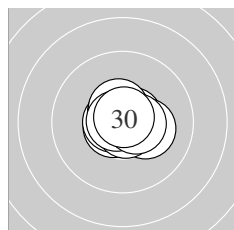

Serie 3:	10.6 *	10.6 *	10.7 *	10.6 *	10.2 *
	10.6 *	10.8 *	10.8 *	10.6 *	10.8 *
beste Teiler	37.3	(30.) 45.8 (28.)	49.2 (27.)		
Trefferlage	0.12 mm	rechts, 0.10 mm	hoch		
Streuwert	0.66,	horizontal: 0.79,	vertikal: 0.49		

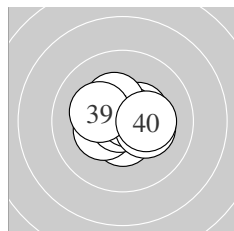

Serie 4:	10.5 *	10.3 *	10.7 *	10.9 *	10.4 *
	10.7 *	10.4 *	10.3 *	10.2 *	10.3 *
beste Teiler	23.0	(34.) 53.6 (36.)	55.9 (33.)		
Trefferlage	0.07 mm	rechts, 0.10 mm	hoch		
Streuwert	0.99,	horizontal: 1.19,	vertikal: 0.73		

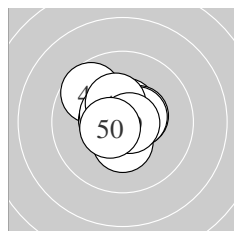

Serie 5:	10.5 *	10.4 *	9.7 ↘	10.5 *	10.5 *
	10.5 *	10.5 *	10.4 *	10.7 *	10.5 *
beste Teiler	51.6	(49.) 102.4 (50.)	102.8 (41.)		
Trefferlage	0.27 mm	links, 0.40 mm	hoch		
Streuwert	1.04,	horizontal: 1.08,	vertikal: 1.00		

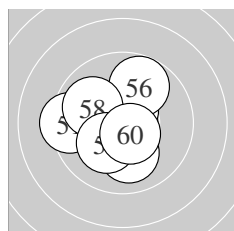

Serie 6:	9.4 ←	10.8 *	10.6 *	10.6 *	10.5 *
	9.8 ↗	10.1 ↓	9.9 ↘	10.2 *	10.6 *
beste Teiler	35.0	(52.) 77.3 (54.)	97.6 (60.)		
Trefferlage	0.39 mm	links, 0.16 mm	tief		
Streuwert	1.51,	horizontal: 1.58,	vertikal: 1.45		

Meyton Elektronik

**ISSF AR Men – Wertung – Männer**

StandNr: 126

**Strepfl, Martin** #70817559

**StartNr: 171**

2. Dezember 2017 19:23

AUT

---

QF – Schütze hat sich fürs Finale qualifiziert

---

Unterschrift des Schützen

Meyton Elektronik

Ergebnis:	<b>611.0</b>	(586)
Serien:	99.8	100.2 103.3 103.8 101.3 102.6
Zähler:	46	14 0 0 0 0 0 0 0 0
Innenzehner:	31	
weiteste:	471	(4), 416 (8), 343 (29)
beste Teiler	34.1	(49.) 44.3 (25.) 47.2 (39.)
Trefferlage	0.22 mm links, 0.19 mm hoch	
Streuwert	1.50, horizontal: 1.71, vertikal: 1.24	

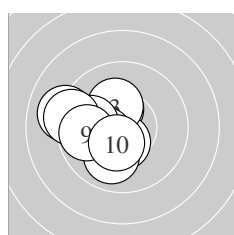
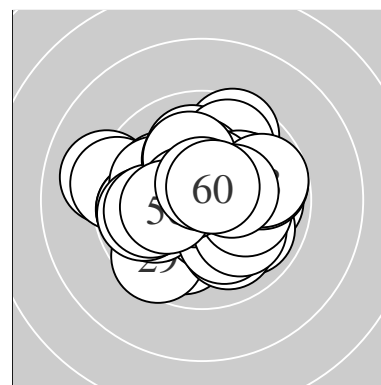

Serie 1:	10.3 *	10.5 *	10.2 *	9.1 ↖	10.3 *
	10.0 ↙	9.9 ←	9.3 ←	9.8 ←	10.4 *
beste Teiler	120.0 (2.) 135.1 (10.) 153.5 (1.)				
Trefferlage	1.81 mm links, 0.05 mm tief				
Streuwert	1.48, horizontal: 1.62, vertikal: 1.32				

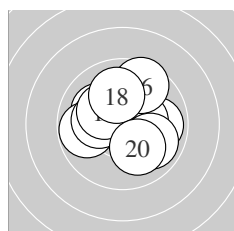

Serie 2:	9.9 →	10.1 ↖	9.8 ←	10.2 *	10.4 *
	9.6 ↗	10.2 *	10.0 ↑	9.9 ↘	10.1 ↘
beste Teiler	143.9 (15.) 177.8 (17.) 190.5 (14.)				
Trefferlage	0.03 mm rechts, 0.43 mm hoch				
Streuwert	1.76, horizontal: 1.97, vertikal: 1.52				

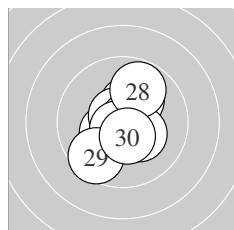

Serie 3:	10.4 *	10.1 ↗	10.4 *	10.7 *	10.8 *
	10.7 *	10.3 *	9.8 ↗	9.6 ↙	10.5 *
beste Teiler	44.3 (25.) 67.2 (26.) 72.1 (24.)				
Trefferlage	0.06 mm rechts, 0.02 mm hoch				
Streuwert	1.37, horizontal: 1.12, vertikal: 1.58				

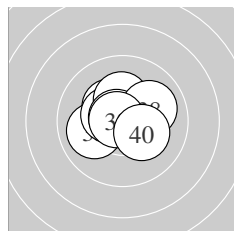

Serie 4:	10.6 *	10.3 *	10.0 ←	10.5 *	10.4 *
	10.3 *	10.7 *	10.0 →	10.8 *	10.2 *
beste Teiler	47.2 (39.) 56.9 (37.) 91.4 (31.)				
Trefferlage	0.14 mm links, 0.28 mm hoch				
Streuwert	1.13, horizontal: 1.37, vertikal: 0.84				

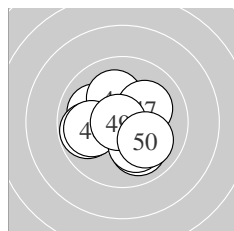

Serie 5:	10.0 ↘	10.0 ↖	10.5 *	10.1 ↑	9.8 ←
	9.9 ←	10.1 ↗	10.1 ↘	10.8 *	10.0 ↘
beste Teiler	34.1 (49.) 122.9 (43.) 203.6 (44.)				
Trefferlage	0.22 mm links, 0.14 mm tief				
Streuwert	1.58, horizontal: 1.77, vertikal: 1.37				

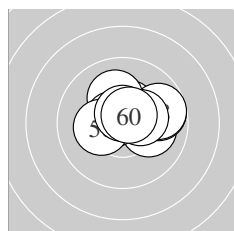

Serie 6:	10.1 →	10.4 *	10.1 ↑	9.8 →	10.6 *
	10.3 *	10.6 *	9.7 →	10.4 *	10.6 *
beste Teiler	77.0 (57.) 81.6 (60.) 83.0 (55.)				
Trefferlage	0.71 mm rechts, 0.62 mm hoch				
Streuwert	1.22, horizontal: 1.56, vertikal: 0.72				

Meyton Elektronik

**ISSF AR Men – Wertung – Männer**

StandNr: 127

**Zach, Michael** #70804295

**StartNr: 172**

2. Dezember 2017 19:10

VBG

---

\_\_\_\_\_  
Unterschrift des Schützen

Meyton Elektronik