

Ergebnis: **624.2** (595)^{QF}
 Serien: 102.9 103.4 104.9 105.3 104.1 103.6
 Zähler: 55 5 0 0 0 0 0 0 0 0
 Innenzehner: 47
 weiteste: 325 (1), 284 (14), 271 (2)
 beste Teiler 13.0 (30.) 40.4 (46.) 50.1 (34.)
 Trefferlage 0.06 mm rechts, 0.33 mm hoch
 Streuwert 1.08, horizontal: 1.09, vertikal: 1.07

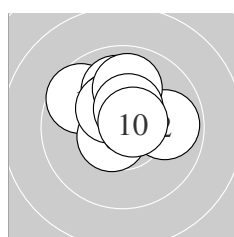

Serie 1:
 9.7 ↘ 9.9 → 10.0 ↑ 10.7 * 10.4 *
 10.6 * 10.4 * 10.0 ↑ 10.5 * 10.7 *
 beste Teiler 73.7 (10.) 75.2 (4.) 92.0 (6.)
 Trefferlage 0.15 mm links, 1.09 mm hoch
 Streuwert 1.19, horizontal: 1.36, vertikal: 0.99

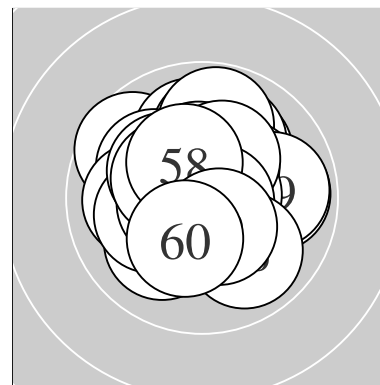
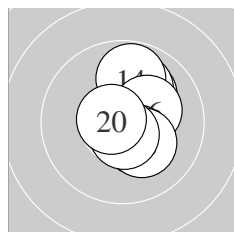

Serie 2:
 10.1 ↗ 10.7 * 10.0 ↗ 9.8 ↑ 10.6 *
 10.3 * 10.4 * 10.2 * 10.6 * 10.7 *
 beste Teiler 53.1 (12.) 74.2 (20.) 79.7 (19.)
 Trefferlage 0.71 mm rechts, 0.37 mm hoch
 Streuwert 1.12, horizontal: 0.66, vertikal: 1.44

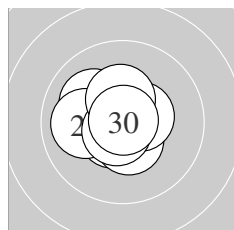

Serie 3:
 10.1 ↘ 10.6 * 10.6 * 10.5 * 10.6 *
 10.5 * 10.0 ← 10.7 * 10.4 * 10.9 *
 beste Teiler 13.0 (30.) 67.6 (28.) 85.4 (25.)
 Trefferlage 0.38 mm links, 0.13 mm hoch
 Streuwert 0.96, horizontal: 1.09, vertikal: 0.81

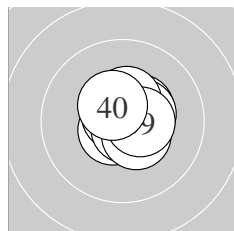

Serie 4:
 10.6 * 10.7 * 10.4 * 10.8 * 10.5 *
 10.5 * 10.4 * 10.4 * 10.5 * 10.5 *
 beste Teiler 50.1 (34.) 52.4 (32.) 85.6 (31.)
 Trefferlage 0.26 mm rechts, 0.28 mm hoch
 Streuwert 0.75, horizontal: 0.76, vertikal: 0.75

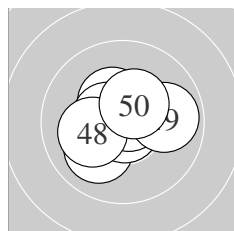

Serie 5:
 10.0 ↗ 10.7 * 10.4 * 10.6 * 10.5 *
 10.8 * 10.7 * 10.1 ← 9.9 → 10.4 *
 beste Teiler 40.4 (46.) 54.5 (47.) 68.6 (42.)
 Trefferlage 0.01 mm rechts, 0.15 mm hoch
 Streuwert 1.14, horizontal: 1.35, vertikal: 0.88

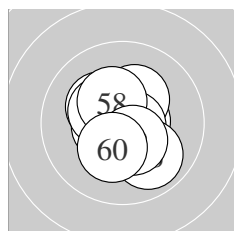

Serie 6:
 10.6 * 10.2 * 10.5 * 10.3 * 10.7 *
 9.9 ↘ 10.4 * 10.3 * 10.4 * 10.3 *
 beste Teiler 56.3 (55.) 83.8 (51.) 107.0 (53.)
 Trefferlage 0.06 mm links, 0.02 mm tief
 Streuwert 1.16, horizontal: 1.07, vertikal: 1.23

Meyton Elektronik

ISSF AR Men – Wertung – Männer

StandNr: 117

Blamauer, Nikolaus #132

StartNr: 64

30. November 2019 11:37

AUT

QF – Schütze hat sich fürs Finale qualifiziert

Unterschrift des Schützen

Meyton Elektronik

| | | | | | | | | | |
|--------------|--|---------------------|-------|-------|-------|-------|---|---|---|
| Ergebnis: | 626.8 | (595) ^{QF} | | | | | | | |
| Serien: | 105.1 | 105.0 | 105.0 | 105.0 | 104.4 | 102.3 | | | |
| Zähler: | 55 | 5 | 0 | 0 | 0 | 0 | 0 | 0 | 0 |
| Innenzehner: | 52 | | | | | | | | |
| weiteste: | 365 (53), 337 (59), 326 (22) | | | | | | | | |
| beste Teiler | 12.7 (15.) 15.2 (26.) 25.0 (19.) | | | | | | | | |
| Trefferlage | 0.02 mm rechts, 0.06 mm hoch | | | | | | | | |
| Streuwert | 1.06, horizontal: 1.23, vertikal: 0.84 | | | | | | | | |

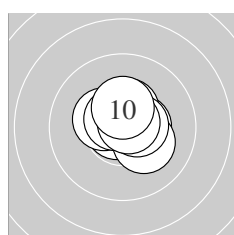
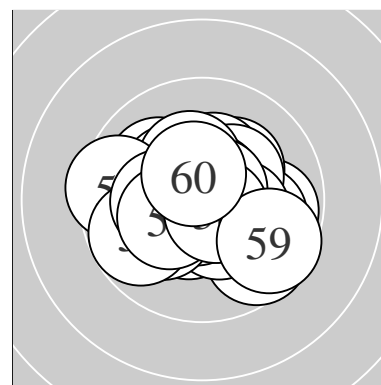

| | | | | | |
|--------------|--|--------|--------|--------|--------|
| Serie 1: | 10.8 * | 10.5 * | 10.6 * | 10.4 * | 10.2 * |
| | 10.4 * | 10.6 * | 10.5 * | 10.7 * | 10.4 * |
| beste Teiler | 42.5 (1.) 54.8 (9.) 78.5 (7.) | | | | |
| Trefferlage | 0.23 mm rechts, 0.41 mm hoch | | | | |
| Streuwert | 0.80, horizontal: 0.88, vertikal: 0.71 | | | | |

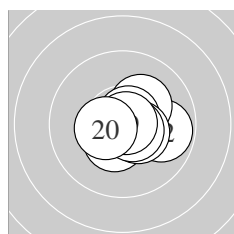

| | | | | | |
|--------------|--|--------|--------|--------|--------|
| Serie 2: | 10.6 * | 9.8 → | 10.4 * | 10.2 * | 10.9 * |
| | 10.7 * | 10.4 * | 10.6 * | 10.9 * | 10.5 * |
| beste Teiler | 12.7 (15.) 25.0 (19.) 63.8 (16.) | | | | |
| Trefferlage | 0.56 mm rechts, 0.08 mm tief | | | | |
| Streuwert | 0.90, horizontal: 1.08, vertikal: 0.67 | | | | |

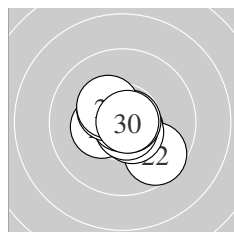

| | | | | | |
|--------------|--|--------|--------|--------|--------|
| Serie 3: | 10.6 * | 9.6 ↘ | 10.3 * | 10.6 * | 10.7 * |
| | 10.9 * | 10.8 * | 10.4 * | 10.3 * | 10.8 * |
| beste Teiler | 15.2 (26.) 34.0 (30.) 49.3 (27.) | | | | |
| Trefferlage | 0.11 mm rechts, 0.21 mm tief | | | | |
| Streuwert | 1.02, horizontal: 1.11, vertikal: 0.93 | | | | |

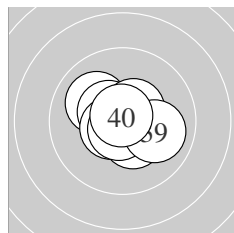

| | | | | | |
|--------------|--|--------|--------|--------|--------|
| Serie 4: | 10.7 * | 10.0 ↖ | 10.5 * | 10.5 * | 10.8 * |
| | 10.6 * | 10.4 * | 10.7 * | 10.0 → | 10.8 * |
| beste Teiler | 36.6 (35.) 41.0 (40.) 62.6 (38.) | | | | |
| Trefferlage | 0.09 mm links, 0.00 mm | | | | |
| Streuwert | 0.98, horizontal: 1.15, vertikal: 0.78 | | | | |

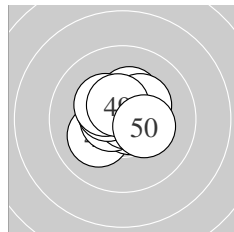

| | | | | | |
|--------------|--|--------|--------|--------|--------|
| Serie 5: | 10.3 * | 10.1 ↙ | 10.7 * | 10.6 * | 10.8 * |
| | 10.3 * | 10.5 * | 10.3 * | 10.5 * | 10.3 * |
| beste Teiler | 35.1 (45.) 61.7 (43.) 80.3 (44.) | | | | |
| Trefferlage | 0.09 mm links, 0.31 mm hoch | | | | |
| Streuwert | 0.98, horizontal: 1.10, vertikal: 0.85 | | | | |

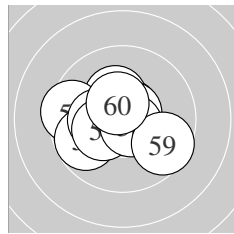

| | | | | | |
|--------------|--|--------|--------|-------|--------|
| Serie 6: | 10.7 * | 10.3 * | 9.5 ← | 9.8 ↙ | 10.3 * |
| | 10.7 * | 10.3 * | 10.6 * | 9.6 → | 10.5 * |
| beste Teiler | 71.2 (56.) 71.3 (51.) 76.4 (58.) | | | | |
| Trefferlage | 0.58 mm links, 0.01 mm tief | | | | |
| Streuwert | 1.52, horizontal: 1.86, vertikal: 1.08 | | | | |

Meyton Elektronik

ISSF AR Men – Wertung – Männer

StandNr: 118

Diaz, Garcia Jorge #40

StartNr: 65

30. November 2019 12:08

ESP

QF – Schütze hat sich fürs Finale qualifiziert

Unterschrift des Schützen

Meyton Elektronik

Ergebnis: **622.2** (595)
 Serien: 101.9 104.6 104.6 105.4 103.3 102.4
 Zähler: 55 5 0 0 0 0 0 0 0 0
 Innenzehner: 46
 weiteste: 430 (1), 357 (2), 334 (51)
 beste Teiler 13.6 (31.) 40.6 (27.) 45.3 (4.)
 Trefferlage 0.20 mm links, 0.00 mm
 Streuwert 1.20, horizontal: 1.18, vertikal: 1.22

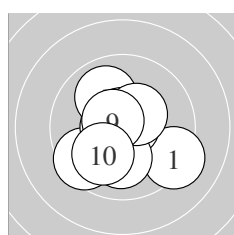
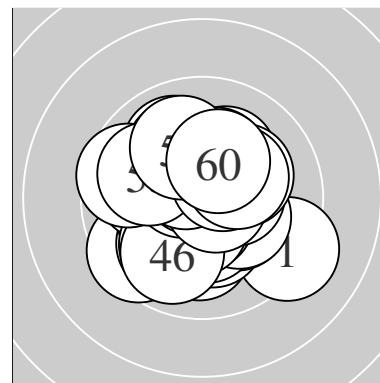

Serie 1:
 9.2 ↘ 9.5 ↙ 10.6 * 10.8 * 10.0 ↗
 10.7 * 10.1 ↓ 10.4 * 10.6 * 10.0 ↘
 beste Teiler 45.3 (4.) 61.4 (6.) 83.0 (3.)
 Trefferlage 0.19 mm links, 0.42 mm tief
 Streuwert 1.66, horizontal: 1.72, vertikal: 1.60

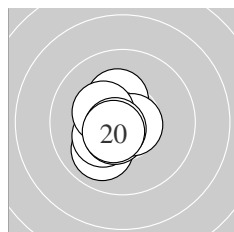

Serie 2:
 10.5 * 10.0 ↙ 10.3 * 10.6 * 10.6 *
 10.3 * 10.7 * 10.3 * 10.7 * 10.6 *
 beste Teiler 67.7 (17.) 73.0 (19.) 94.7 (20.)
 Trefferlage 0.64 mm links, 0.07 mm tief
 Streuwert 0.92, horizontal: 0.65, vertikal: 1.12

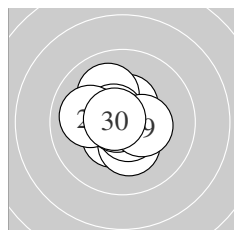

Serie 3:
 10.5 * 10.5 * 10.1 ↗ 10.6 * 10.3 *
 10.7 * 10.8 * 10.0 ← 10.4 * 10.7 *
 beste Teiler 40.6 (27.) 61.6 (30.) 72.6 (26.)
 Trefferlage 0.31 mm links, 0.08 mm hoch
 Streuwert 1.04, horizontal: 1.02, vertikal: 1.05

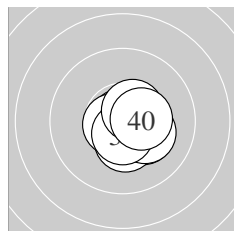

Serie 4:
 10.9 * 10.3 * 10.8 * 10.4 * 10.7 *
 10.2 * 10.6 * 10.6 * 10.5 * 10.4 *
 beste Teiler 13.6 (31.) 47.5 (33.) 68.7 (35.)
 Trefferlage 0.58 mm rechts, 0.29 mm tief
 Streuwert 0.72, horizontal: 0.74, vertikal: 0.70

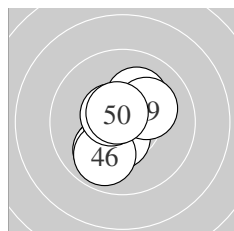

Serie 5:
 10.1 ↘ 10.0 ↙ 10.5 * 10.7 * 10.5 *
 9.9 ↘ 10.2 * 10.6 * 10.2 * 10.6 *
 beste Teiler 63.2 (44.) 77.1 (50.) 97.0 (48.)
 Trefferlage 0.37 mm links, 0.44 mm tief
 Streuwert 1.23, horizontal: 1.01, vertikal: 1.41

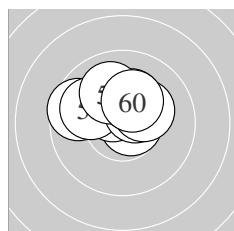

Serie 6:
 9.6 ↖ 10.7 * 10.4 * 10.5 * 9.9 ↗
 10.5 * 10.3 * 10.2 * 10.0 ↗ 10.3 *
 beste Teiler 61.1 (52.) 113.2 (54.) 121.0 (56.)
 Trefferlage 0.28 mm links, 1.12 mm hoch
 Streuwert 1.15, horizontal: 1.50, vertikal: 0.62

Meyton Elektronik

ISSF AR Men – Wertung – Männer

StandNr: 119

Diem, Patrick #133

StartNr: 66

30. November 2019 12:03

AUT

Unterschrift des Schützen

Meyton Elektronik

| | | |
|--------------|--------------|----------------------------------|
| Ergebnis: | 623.5 | (593) ^{QF} |
| Serien: | 105.8 | 102.3 104.1 103.5 104.2 103.6 |
| Zähler: | 53 | 7 0 0 0 0 0 0 0 0 |
| Innenzehner: | 48 | |
| weiteste: | 323 | (59), 322 (11), 309 (18) |
| beste Teiler | 3.6 | (49.) 15.2 (48.) 40.1 (6.) |
| Trefferlage | 0.25 mm | rechts, 0.17 mm hoch |
| Streuwert | 1.13, | horizontal: 1.07, vertikal: 1.18 |

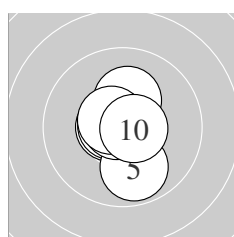
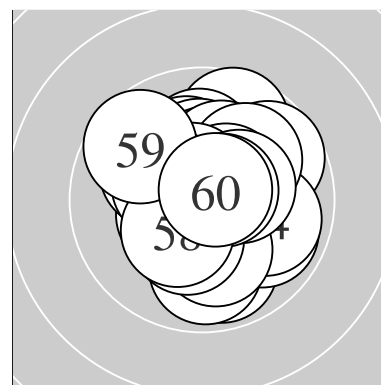

Serie 1:

| | | | | |
|--------------|--|-----------|-----------|--------|
| 10.6 * | 10.7 * | 10.7 * | 10.8 * | 9.9 ↓ |
| 10.8 * | 10.2 * | 10.8 * | 10.6 * | 10.7 * |
| beste Teiler | 40.1 (6.) | 40.5 (8.) | 41.7 (4.) | |
| Trefferlage | 0.05 mm rechts, 0.02 mm tief | | | |
| Streuwert | 0.88, horizontal: 0.65, vertikal: 1.07 | | | |

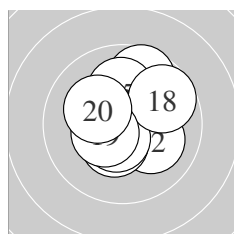

Serie 2:

| | | | | |
|--------------|--|-------------|-------------|--------|
| 9.7 ↑ | 10.1 ↘ | 10.6 * | 10.4 * | 10.1 ↑ |
| 10.5 * | 10.6 * | 9.7 ↗ | 10.4 * | 10.2 * |
| beste Teiler | 98.8 (13.) | 100.7 (17.) | 119.0 (16.) | |
| Trefferlage | 0.02 mm links, 0.35 mm hoch | | | |
| Streuwert | 1.46, horizontal: 1.43, vertikal: 1.49 | | | |

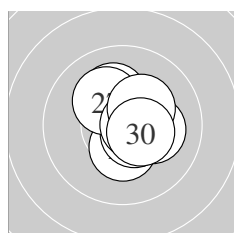

Serie 3:

| | | | | |
|--------------|--|------------|------------|--------|
| 10.3 * | 10.8 * | 10.4 * | 10.2 * | 10.6 * |
| 10.2 * | 10.2 * | 10.7 * | 10.3 * | 10.4 * |
| beste Teiler | 41.0 (22.) | 75.0 (28.) | 95.2 (25.) | |
| Trefferlage | 0.57 mm rechts, 0.28 mm hoch | | | |
| Streuwert | 0.99, horizontal: 0.91, vertikal: 1.07 | | | |

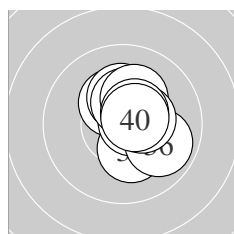

Serie 4:

| | | | | |
|--------------|--|------------|-------------|--------|
| 10.3 * | 10.3 * | 10.7 * | 10.2 * | 10.4 * |
| 9.9 ↘ | 10.2 * | 10.4 * | 10.5 * | 10.6 * |
| beste Teiler | 64.5 (33.) | 91.7 (40.) | 108.2 (39.) | |
| Trefferlage | 0.65 mm rechts, 0.50 mm hoch | | | |
| Streuwert | 1.01, horizontal: 0.82, vertikal: 1.17 | | | |

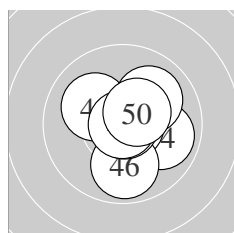

Serie 5:

| | | | | |
|--------------|--|------------|------------|--------|
| 10.7 * | 10.5 * | 10.1 ↘ | 9.9 ↘ | 10.8 * |
| 9.9 ↓ | 10.0 ↗ | 10.9 * | 10.9 * | 10.5 * |
| beste Teiler | 3.6 (49.) | 15.2 (48.) | 50.0 (45.) | |
| Trefferlage | 0.56 mm rechts, 0.05 mm tief | | | |
| Streuwert | 1.16, horizontal: 1.14, vertikal: 1.17 | | | |

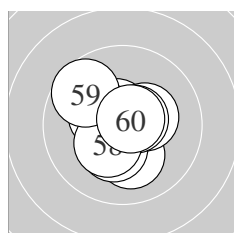

Serie 6:

| | | | | |
|--------------|--|------------|------------|--------|
| 10.6 * | 10.6 * | 10.4 * | 10.1 ↓ | 10.3 * |
| 10.3 * | 10.6 * | 10.3 * | 9.7 ↘ | 10.7 * |
| beste Teiler | 66.4 (60.) | 84.2 (52.) | 86.7 (57.) | |
| Trefferlage | 0.30 mm links, 0.04 mm tief | | | |
| Streuwert | 1.20, horizontal: 1.16, vertikal: 1.25 | | | |

Meyton Elektronik

ISSF AR Men – Wertung – Männer

StandNr: 120

Eberlberger, Florian #134

StartNr: 67

30. November 2019 11:54

OÖ – ASKO Bad Goisern

QF – Schütze hat sich fürs Finale qualifiziert

Unterschrift des Schützen

Meyton Elektronik

Ergebnis: **622.8** (592)
 Serien: 103.5 104.7 101.8 102.6 105.1 105.1
 Zähler: 52 8 0 0 0 0 0 0 0
 Innenzehner: 47
 weiteste: 378 (24), 369 (40), 316 (58)
 beste Teiler 2.2 (51.) 15.0 (47.) 24.0 (5.)
 Trefferlage 0.24 mm links, 0.14 mm tief
 Streuwert 1.18, horizontal: 1.27, vertikal: 1.09

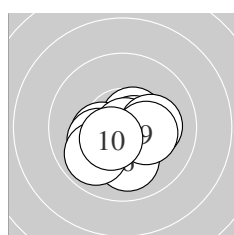
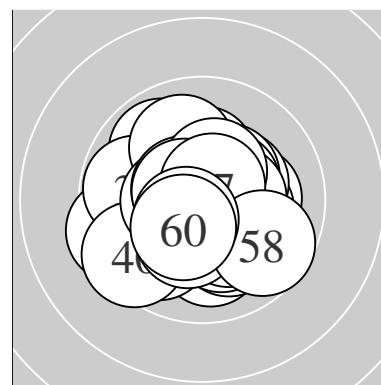

Serie 1:
 10.6 * 10.6 * 10.3 * 10.2 * 10.9 *
 10.0 ↓ 10.2 * 9.9 ↙ 10.3 * 10.5 *
 beste Teiler 24.0 (5.) 80.0 (2.) 93.7 (1.)
 Trefferlage 0.01 mm links, 0.62 mm tief
 Streuwert 1.17, horizontal: 1.39, vertikal: 0.89

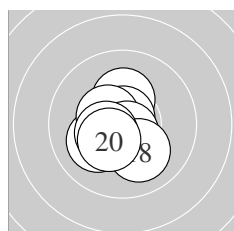

Serie 2:
 10.7 * 10.3 * 10.1 ↙ 10.7 * 10.8 *
 10.5 * 10.7 * 10.1 ↘ 10.4 * 10.4 *
 beste Teiler 46.1 (15.) 53.0 (11.) 68.4 (17.)
 Trefferlage 0.46 mm links, 0.26 mm tief
 Streuwert 0.95, horizontal: 0.85, vertikal: 1.04

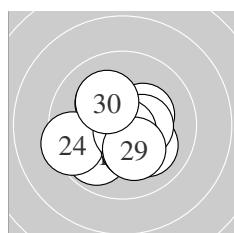

Serie 3:
 9.9 ↙ 10.3 * 10.2 * 9.4 ↙ 10.1 ↘
 10.4 * 10.3 * 10.8 * 10.2 * 10.2 *
 beste Teiler 42.7 (28.) 136.1 (26.) 160.9 (22.)
 Trefferlage 0.14 mm links, 0.45 mm tief
 Streuwert 1.54, horizontal: 1.71, vertikal: 1.36

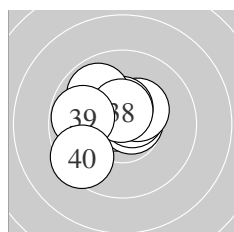

Serie 4:
 10.7 * 10.7 * 9.9 ← 10.6 * 10.4 *
 10.5 * 9.9 ↘ 10.6 * 9.8 ← 9.5 ↙
 beste Teiler 64.1 (32.) 68.4 (31.) 89.4 (34.)
 Trefferlage 0.85 mm links, 0.48 mm hoch
 Streuwert 1.35, horizontal: 1.55, vertikal: 1.13

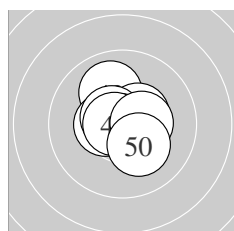

Serie 5:
 10.7 * 10.7 * 10.0 ↗ 10.5 * 10.4 *
 10.6 * 10.9 * 10.7 * 10.4 * 10.2 *
 beste Teiler 15.0 (47.) 58.0 (48.) 61.2 (42.)
 Trefferlage 0.10 mm links, 0.25 mm hoch
 Streuwert 0.93, horizontal: 0.94, vertikal: 0.91

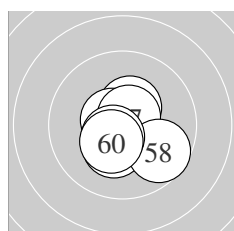

Serie 6:
 10.9 * 10.8 * 10.8 * 10.3 * 10.4 *
 10.6 * 10.7 * 9.7 ↘ 10.5 * 10.4 *
 beste Teiler 2.2 (51.) 40.4 (53.) 48.0 (52.)
 Trefferlage 0.09 mm rechts, 0.26 mm tief
 Streuwert 1.01, horizontal: 1.01, vertikal: 1.02

Meyton Elektronik

ISSF AR Men – Wertung – Männer

StandNr: 121

Entrichel, Ales #135

StartNr: 68

30. November 2019 11:48

CZE – Dukla Pilsen

Unterschrift des Schützen

Meyton Elektronik

| | | | | | | |
|--------------|--|-----------|-----------|-------|------|-----------|
| Ergebnis: | 593.2 | (567) | | | | |
| Serien: | 96.6 | 100.9 | 93.9 | 100.8 | 99.0 | 102.0 |
| Zähler: | 33 | 23 | 3 | 0 | 1 | 0 0 0 0 0 |
| Innenzehner: | 23 | | | | | |
| weiteste: | 1134 | (24), 585 | (13), 530 | (3) | | |
| beste Teiler | 26.9 | (44.) | 41.7 | (19.) | 44.2 | (31.) |
| Trefferlage | 0.39 mm links, 0.71 mm hoch | | | | | |
| Streuwert | 2.18, horizontal: 2.02, vertikal: 2.33 | | | | | |

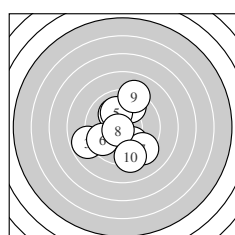
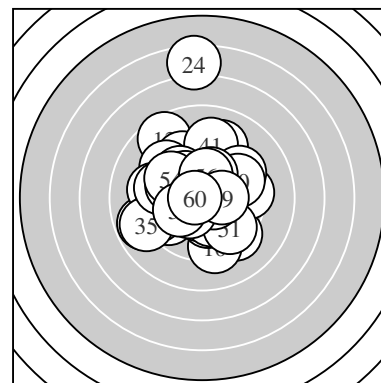

| | | | | | |
|--------------|--|-------|--------|--------|--------|
| Serie 1: | 9.7 ↗ | 9.9 ↘ | 8.8 ↙ | 10.1 ↖ | 10.1 ↗ |
| | 9.7 ↙ | 9.3 ↘ | 10.6 * | 9.1 ↗ | 9.3 ↘ |
| beste Teiler | 76.0 (8.) 214.1 (4.) 219.5 (5.) | | | | |
| Trefferlage | 0.25 mm links, 0.25 mm tief | | | | |
| Streuwert | 2.56, horizontal: 2.30, vertikal: 2.80 | | | | |

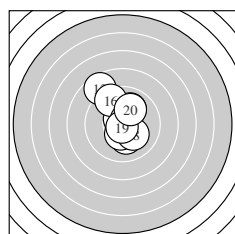

| | | | | | |
|--------------|--|--------|--------|--------|--------|
| Serie 2: | 10.2 * | 10.4 * | 8.6 ↖ | 10.0 ↗ | 10.6 * |
| | 9.5 ↘ | 10.6 * | 10.2 * | 10.8 * | 10.0 ↗ |
| beste Teiler | 41.7 (19.) 84.5 (17.) 85.2 (15.) | | | | |
| Trefferlage | 0.09 mm links, 0.86 mm hoch | | | | |
| Streuwert | 1.87, horizontal: 1.40, vertikal: 2.24 | | | | |

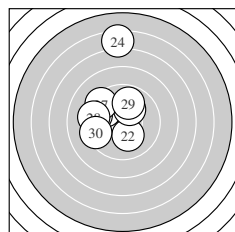

| | | | | | |
|--------------|--|--------|-------|-------|-------|
| Serie 3: | 10.1 ↖ | 10.2 * | 9.8 ↖ | 6.4 ↑ | 9.4 ↖ |
| | 10.1 ↗ | 9.4 ↖ | 9.3 ↙ | 9.9 ↗ | 9.3 ↙ |
| beste Teiler | 195.9 (22.) 201.8 (26.) 209.4 (21.) | | | | |
| Trefferlage | 1.68 mm links, 1.92 mm hoch | | | | |
| Streuwert | 2.93, horizontal: 2.01, vertikal: 3.62 | | | | |

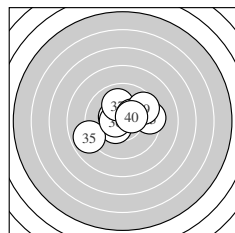

| | | | | | |
|--------------|--|--------|--------|--------|--------|
| Serie 4: | 10.8 * | 10.4 * | 9.4 → | 10.4 * | 8.9 ↙ |
| | 10.6 * | 10.0 ↖ | 10.3 * | 9.6 ↗ | 10.4 * |
| beste Teiler | 44.2 (31.) 100.0 (36.) 127.4 (34.) | | | | |
| Trefferlage | 0.03 mm rechts, 0.35 mm hoch | | | | |
| Streuwert | 1.91, horizontal: 2.39, vertikal: 1.26 | | | | |

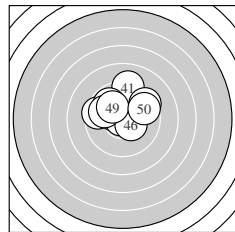

| | | | | | |
|--------------|--|--------|-------|--------|-------|
| Serie 5: | 9.1 ↗ | 10.4 * | 9.5 ↙ | 10.8 * | 9.8 ↖ |
| | 10.4 * | 9.4 ↗ | 9.9 ↖ | 10.1 ↖ | 9.6 ↗ |
| beste Teiler | 26.9 (44.) 127.9 (42.) 140.6 (46.) | | | | |
| Trefferlage | 0.25 mm links, 1.33 mm hoch | | | | |
| Streuwert | 1.88, horizontal: 2.24, vertikal: 1.44 | | | | |

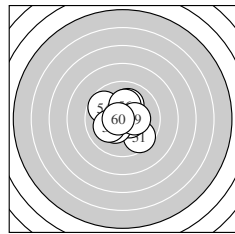

| | | | | | |
|--------------|--|--------|--------|--------|--------|
| Serie 6: | 9.6 ↘ | 10.5 * | 10.5 * | 9.7 ↖ | 10.1 ↗ |
| | 10.2 * | 10.3 * | 10.1 ↙ | 10.3 * | 10.7 * |
| beste Teiler | 61.0 (60.) 103.6 (52.) 120.3 (53.) | | | | |
| Trefferlage | 0.12 mm links, 0.05 mm hoch | | | | |
| Streuwert | 1.52, horizontal: 1.59, vertikal: 1.44 | | | | |

Meyton Elektronik

ISSF AR Men – Wertung – Männer

StandNr: 122

Fölzer, Karl-Heinz #136

StartNr: 69

30. November 2019 11:54

ST – Brucker SV

Unterschrift des Schützen

Meyton Elektronik

Ergebnis: **614.3** (586)
 Serien: 100.0 103.5 102.5 103.0 101.9 103.4
 Zähler: 46 14 0 0 0 0 0 0 0
 Innenzehner: 34
 weiteste: 439 (5), 426 (49), 366 (37)
 beste Teiler 18.3 (45.) 18.8 (18.) 51.0 (39.)
 Trefferlage 0.23 mm rechts, 0.11 mm hoch
 Streuwert 1.44, horizontal: 1.59, vertikal: 1.27

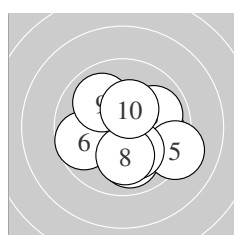
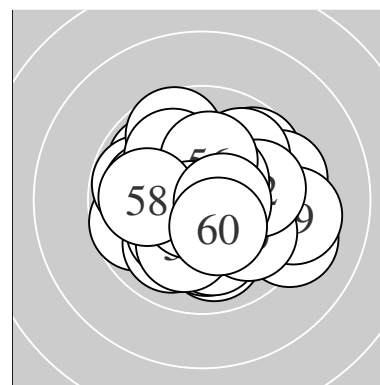

Serie 1:
 10.6 * 9.9 → 9.9 → 10.0 ↓ 9.2 →
 9.7 ← 10.2 * 10.1 ↓ 10.0 ↖ 10.4 *
 beste Teiler 78.4 (1.) 148.7 (10.) 199.5 (7.)
 Trefferlage 0.61 mm rechts, 0.48 mm tief
 Streuwert 1.83, horizontal: 2.05, vertikal: 1.58

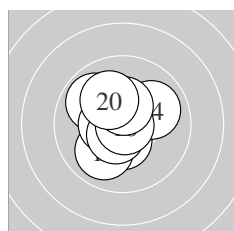

Serie 2:
 10.5 * 10.6 * 10.0 ✓ 10.0 → 9.9 ↖
 10.5 * 10.6 * 10.9 * 10.4 * 10.1 ↖
 beste Teiler 18.8 (18.) 95.4 (17.) 96.6 (12.)
 Trefferlage 0.46 mm links, 0.14 mm hoch
 Streuwert 1.25, horizontal: 1.18, vertikal: 1.31

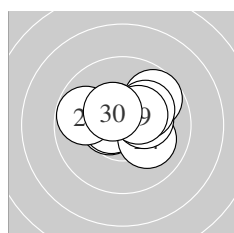

Serie 3:
 10.5 * 10.6 * 10.6 * 10.1 ↘ 9.7 ↗
 9.8 ← 10.3 * 10.1 → 10.4 * 10.4 *
 beste Teiler 85.2 (23.) 99.0 (22.) 119.5 (21.)
 Trefferlage 0.27 mm rechts, 0.61 mm hoch
 Streuwert 1.34, horizontal: 1.71, vertikal: 0.83

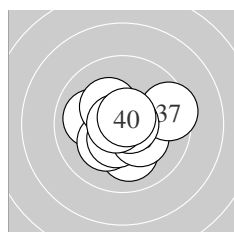

Serie 4:
 10.1 ↓ 10.0 ← 10.2 * 10.3 * 10.5 *
 10.3 * 9.5 → 10.7 * 10.7 * 10.7 *
 beste Teiler 51.0 (39.) 53.0 (38.) 59.1 (40.)
 Trefferlage 0.05 mm rechts, 0.23 mm tief
 Streuwert 1.39, horizontal: 1.61, vertikal: 1.12

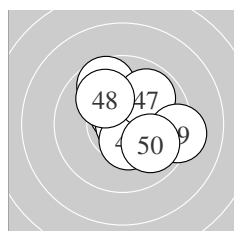

Serie 5:
 9.7 ↖ 10.6 * 10.6 * 10.7 * 10.9 *
 10.4 * 9.9 ↗ 10.0 ↖ 9.2 → 9.9 ↘
 beste Teiler 18.3 (45.) 69.3 (44.) 91.0 (42.)
 Trefferlage 0.68 mm rechts, 0.55 mm hoch
 Streuwert 1.57, horizontal: 1.67, vertikal: 1.47

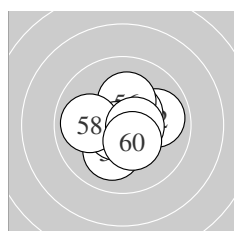

Serie 6:
 10.1 ↓ 9.9 → 10.5 * 10.4 * 10.7 *
 10.2 * 10.7 * 9.9 ← 10.6 * 10.4 *
 beste Teiler 67.9 (57.) 69.8 (55.) 94.6 (59.)
 Trefferlage 0.24 mm rechts, 0.07 mm hoch
 Streuwert 1.24, horizontal: 1.32, vertikal: 1.14

Meyton Elektronik

ISSF AR Men – Wertung – **Männer**

StandNr: 123

Rumpler, Gernot #137

StartNr: 70

30. November 2019 11:57

AUT

Unterschrift des Schützen

Meyton Elektronik

| | | |
|--------------|--|-------|
| Ergebnis: | 592.6 | (570) |
| Serien: | 97.8 96.7 99.6 99.9 96.0 102.6 | |
| Zähler: | 36 18 6 0 0 0 0 0 0 | |
| Innenzehner: | 23 | |
| weiteste: | 697 (28), 678 (1), 660 (41) | |
| beste Teiler | 7.0 (49.) 34.8 (54.) 48.5 (43.) | |
| Trefferlage | 0.09 mm rechts, 0.61 mm hoch | |
| Streuwert | 2.23, horizontal: 2.85, vertikal: 1.35 | |

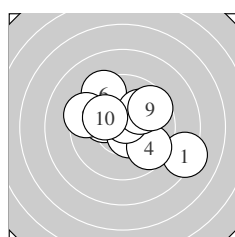
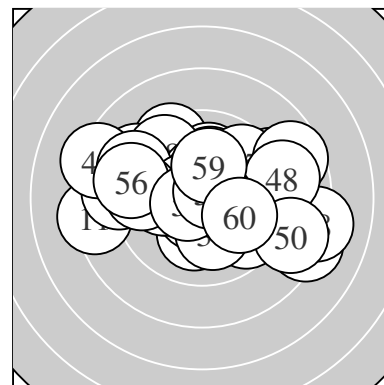

Serie 1:

| | | | | |
|--------------|--|------------|------------|--------|
| 8.2 ↘ | 10.2 * | 10.5 * | 9.6 ↘ | 10.7 * |
| 9.4 ↘ | 10.0 ↗ | 9.4 ↖ | 9.6 ↗ | 10.2 * |
| beste Teiler | 70.6 (5.) | 104.4 (3.) | 196.2 (2.) | |
| Trefferlage | 0.52 mm rechts, 0.48 mm hoch | | | |
| Streuwert | 2.44, horizontal: 2.92, vertikal: 1.85 | | | |

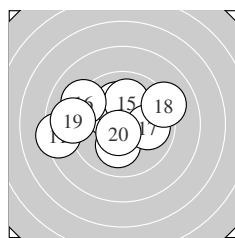

Serie 2:

| | | | | |
|--------------|--|-------------|-------------|--------|
| 8.4 ← | 10.1 ↓ | 10.3 * | 10.1 ↑ | 10.0 ↑ |
| 9.2 ↖ | 9.9 → | 9.1 ↗ | 9.0 ← | 10.6 * |
| beste Teiler | 97.5 (20.) | 154.7 (13.) | 205.9 (14.) | |
| Trefferlage | 1.10 mm links, 0.51 mm hoch | | | |
| Streuwert | 2.54, horizontal: 3.24, vertikal: 1.57 | | | |

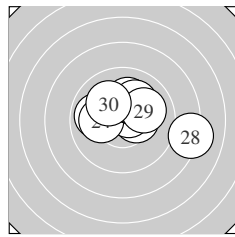

Serie 3:

| | | | | |
|--------------|--|-------------|-------------|--------|
| 10.4 * | 9.9 ← | 10.6 * | 10.1 ← | 10.1 ↑ |
| 10.1 ↑ | 10.1 ↗ | 8.2 → | 10.0 ↗ | 10.1 ↘ |
| beste Teiler | 79.6 (23.) | 137.0 (21.) | 202.6 (25.) | |
| Trefferlage | 0.72 mm rechts, 0.76 mm hoch | | | |
| Streuwert | 2.03, horizontal: 2.65, vertikal: 1.13 | | | |

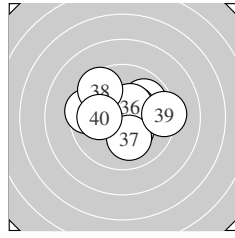

Serie 4:

| | | | | |
|--------------|--|-------------|-------------|--------|
| 10.3 * | 9.9 ↗ | 10.5 * | 9.5 ← | 10.4 * |
| 10.4 * | 10.1 ↓ | 9.5 ↘ | 9.3 → | 10.0 ← |
| beste Teiler | 106.0 (33.) | 132.3 (36.) | 135.5 (35.) | |
| Trefferlage | 0.22 mm rechts, 0.45 mm hoch | | | |
| Streuwert | 1.88, horizontal: 2.29, vertikal: 1.36 | | | |

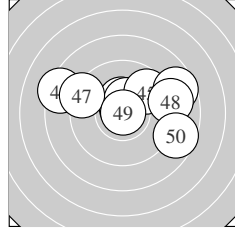

Serie 5:

| | | | | |
|--------------|--|------------|-------------|-------|
| 8.3 ↖ | 10.4 * | 10.8 * | 10.4 * | 9.7 ↗ |
| 8.6 ↗ | 9.2 ↖ | 9.0 → | 10.9 * | 8.7 → |
| beste Teiler | 7.0 (49.) | 48.5 (43.) | 133.2 (44.) | |
| Trefferlage | 0.76 mm rechts, 1.05 mm hoch | | | |
| Streuwert | 2.90, horizontal: 3.86, vertikal: 1.38 | | | |

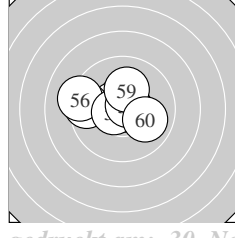

Serie 6:

| | | | | |
|--------------|--|------------|------------|--------|
| 10.6 * | 10.5 * | 10.5 * | 10.8 * | 9.5 ← |
| 9.2 ← | 10.6 * | 10.7 * | 10.2 * | 10.0 → |
| beste Teiler | 34.8 (54.) | 65.6 (58.) | 91.0 (51.) | |
| Trefferlage | 0.59 mm links, 0.38 mm hoch | | | |
| Streuwert | 1.52, horizontal: 1.98, vertikal: 0.82 | | | |

Meyton Elektronik

ISSF AR Men – Wertung – **Männer**

StandNr: 124

Grün, Günther #138

StartNr: 71

30. November 2019 12:04

ST – SV Kapfenberg

Unterschrift des Schützen

Meyton Elektronik

Ergebnis: **612.5** (585)
 Serien: 101.1 101.8 102.8 104.1 103.0 99.7
 Zähler: 45 15 0 0 0 0 0 0 0
 Innenzehner: 33
 weiteste: 382 (5), 368 (8), 357 (55)
 beste Teiler 21.0 (23.) 41.2 (15.) 59.4 (33.)
 Trefferlage 0.04 mm links, 0.07 mm tief
 Streuwert 1.47, horizontal: 1.47, vertikal: 1.47

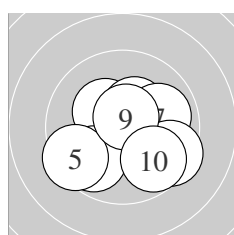
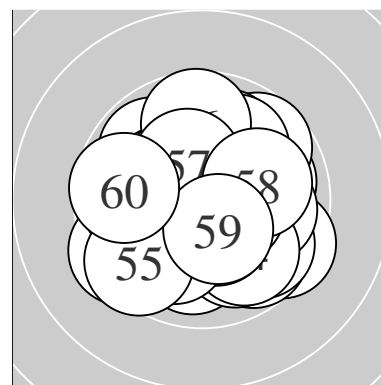

Serie 1:
 10.3 * 10.7 * 10.7 * 9.8 ↙ 9.4 ↙
 10.4 * 9.9 → 9.5 ↘ 10.7 * 9.7 ↘
 beste Teiler 65.2 (2.) 72.7 (9.) 75.2 (3.)
 Trefferlage 0.30 mm rechts, 0.57 mm tief
 Streuwert 1.74, horizontal: 2.01, vertikal: 1.41

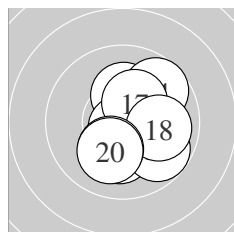

Serie 2:
 10.2 * 10.6 * 10.2 * 9.7 ↗ 10.8 *
 9.8 ↘ 10.3 * 10.0 → 10.1 ↓ 10.1 ↓
 beste Teiler 41.2 (15.) 92.1 (12.) 157.0 (17.)
 Trefferlage 0.69 mm rechts, 0.29 mm tief
 Streuwert 1.46, horizontal: 1.29, vertikal: 1.61

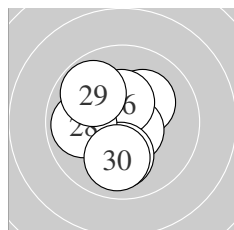

Serie 3:
 10.2 * 10.7 * 10.9 * 10.6 * 10.3 *
 10.4 * 10.0 ↓ 9.9 ← 9.8 ↘ 10.0 ↓
 beste Teiler 21.0 (23.) 65.1 (22.) 78.5 (24.)
 Trefferlage 0.48 mm links, 0.02 mm tief
 Streuwert 1.35, horizontal: 1.17, vertikal: 1.51

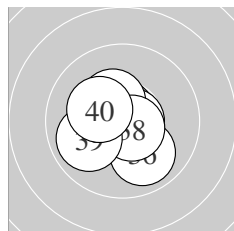

Serie 4:
 10.4 * 10.5 * 10.7 * 10.7 * 10.7 *
 9.9 ↘ 10.4 * 10.6 * 9.9 ↙ 10.3 *
 beste Teiler 59.4 (33.) 60.0 (35.) 69.3 (34.)
 Trefferlage 0.39 mm links, 0.19 mm tief
 Streuwert 1.07, horizontal: 1.12, vertikal: 1.03

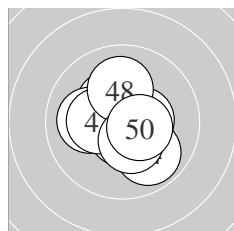

Serie 5:
 10.4 * 10.6 * 10.3 * 9.9 ↘ 10.1 ←
 10.4 * 10.3 * 10.1 ↑ 10.4 * 10.5 *
 beste Teiler 77.2 (42.) 122.0 (50.) 127.6 (46.)
 Trefferlage 0.13 mm links, 0.00 mm
 Streuwert 1.27, horizontal: 1.32, vertikal: 1.23

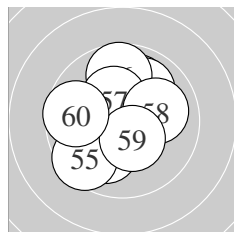

Serie 6:
 10.1 ↑ 10.0 ↗ 10.0 ↙ 10.0 ↗ 9.5 ↙
 9.7 ↑ 10.3 * 10.0 → 10.4 * 9.7 ←
 beste Teiler 136.0 (59.) 159.6 (57.) 210.0 (51.)
 Trefferlage 0.23 mm links, 0.65 mm hoch
 Streuwert 1.83, horizontal: 1.70, vertikal: 1.94

Meyton Elektronik

ISSF AR Men – Wertung – Männer

StandNr: 125

Haner, Tamas #139

StartNr: 72

30. November 2019 11:44

LZ Vorarlberg

Unterschrift des Schützen

Meyton Elektronik

| | | | | | | | |
|--------------|--|-------|-------|-------|------|-------|---|
| Ergebnis: | 601.3 | (575) | | | | | |
| Serien: | 101.6 | 96.7 | 101.6 | 100.0 | 99.0 | 102.4 | |
| Zähler: | 37 | 22 | 0 | 1 | 0 | 0 | 0 |
| Innenzehner: | 27 | | | | | | |
| weiteste: | 899 (13), 470 (50), 469 (36) | | | | | | |
| beste Teiler | 8.9 (53.) 19.4 (32.) 30.2 (55.) | | | | | | |
| Trefferlage | 0.50 mm links, 0.04 mm hoch | | | | | | |
| Streuwert | 1.94, horizontal: 2.50, vertikal: 1.14 | | | | | | |

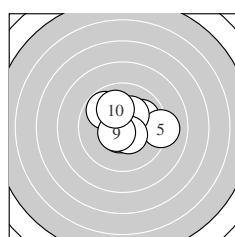
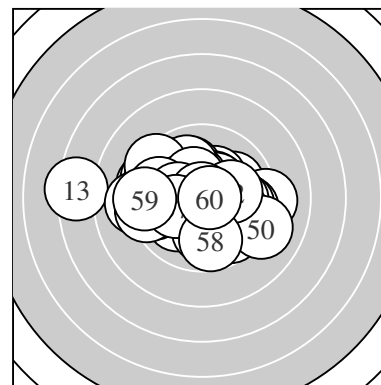

Serie 1:

| | | | | |
|--------------|--|--------|--------|--------|
| 10.1 → | 10.0 ↗ | 9.8 ↘ | 10.6 * | 9.1 → |
| 10.6 * | 10.3 * | 10.5 * | 10.6 * | 10.0 ↘ |
| beste Teiler | 77.1 (6.) 87.7 (4.) 94.2 (9.) | | | |
| Trefferlage | 0.66 mm rechts, 0.55 mm hoch | | | |
| Streuwert | 1.57, horizontal: 1.90, vertikal: 1.14 | | | |

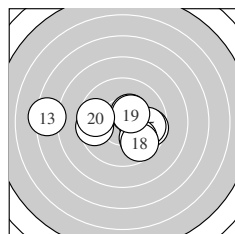

Serie 2:

| | | | | |
|--------------|--|-------|--------|-------|
| 9.6 → | 10.2 * | 7.4 ← | 10.4 * | 9.8 → |
| 9.9 ↘ | 9.6 ← | 9.7 ↘ | 10.4 * | 9.7 ← |
| beste Teiler | 135.0 (14.) 137.8 (19.) 177.8 (12.) | | | |
| Trefferlage | 0.20 mm links, 0.29 mm tief | | | |
| Streuwert | 2.83, horizontal: 3.83, vertikal: 1.17 | | | |

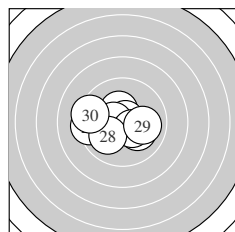

Serie 3:

| | | | | |
|--------------|--|--------|--------|--------|
| 10.6 * | 10.4 * | 9.4 ← | 10.8 * | 10.5 * |
| 10.1 ↘ | 10.4 * | 10.0 ↗ | 10.0 → | 9.4 ← |
| beste Teiler | 45.2 (24.) 89.9 (21.) 109.6 (25.) | | | |
| Trefferlage | 0.63 mm links, 0.10 mm tief | | | |
| Streuwert | 1.66, horizontal: 2.15, vertikal: 0.93 | | | |

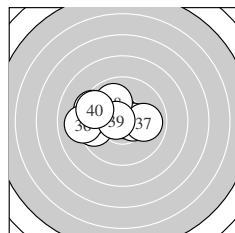

Serie 4:

| | | | | |
|--------------|--|--------|--------|-------|
| 10.5 * | 10.9 * | 10.4 * | 9.6 ← | 9.4 ↘ |
| 9.1 ← | 10.0 → | 10.0 ↘ | 10.6 * | 9.5 ↘ |
| beste Teiler | 19.4 (32.) 78.5 (39.) 109.2 (31.) | | | |
| Trefferlage | 1.34 mm links, 0.48 mm hoch | | | |
| Streuwert | 1.78, horizontal: 2.33, vertikal: 0.95 | | | |

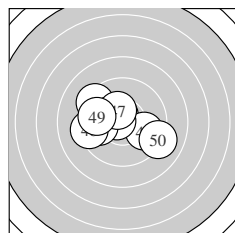

Serie 5:

| | | | | |
|--------------|--|-------|--------|--------|
| 10.6 * | 9.8 → | 9.4 ↘ | 10.2 * | 10.7 * |
| 9.8 ← | 10.4 * | 9.3 ← | 9.7 ← | 9.1 → |
| beste Teiler | 69.2 (45.) 89.8 (41.) 150.4 (47.) | | | |
| Trefferlage | 0.95 mm links, 0.14 mm hoch | | | |
| Streuwert | 2.07, horizontal: 2.63, vertikal: 1.30 | | | |

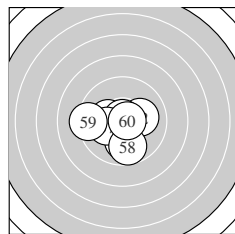

Serie 6:

| | | | | |
|--------------|--|--------|--------|--------|
| 10.4 * | 10.1 → | 10.9 * | 10.3 * | 10.8 * |
| 10.0 ↓ | 10.2 * | 9.7 ↓ | 9.3 ← | 10.7 * |
| beste Teiler | 8.9 (53.) 30.2 (55.) 54.0 (60.) | | | |
| Trefferlage | 0.56 mm links, 0.48 mm tief | | | |
| Streuwert | 1.48, horizontal: 1.72, vertikal: 1.20 | | | |

Meyton Elektronik

ISSF AR Men – Wertung – Männer

StandNr: 126

Heidegger, Daniel #140

StartNr: 73

30. November 2019 12:04

WSV

Unterschrift des Schützen

Meyton Elektronik

| | | | | | | | | | |
|--------------|--|---------------------|-------|-------|-------|-------|---|---|---|
| Ergebnis: | 623.9 | (598) ^{QF} | | | | | | | |
| Serien: | 103.4 | 103.3 | 104.4 | 104.7 | 104.2 | 103.9 | | | |
| Zähler: | 58 | 2 | 0 | 0 | 0 | 0 | 0 | 0 | 0 |
| Innenzehner: | 50 | | | | | | | | |
| weiteste: | 278 (39), 267 (8), 242 (26) | | | | | | | | |
| beste Teiler | 5.0 (33.) 47.2 (51.) 51.4 (49.) | | | | | | | | |
| Trefferlage | 0.14 mm rechts, 0.20 mm hoch | | | | | | | | |
| Streuwert | 1.05, horizontal: 0.95, vertikal: 1.14 | | | | | | | | |

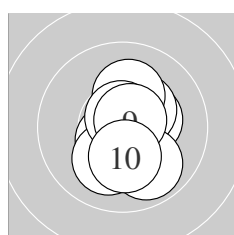
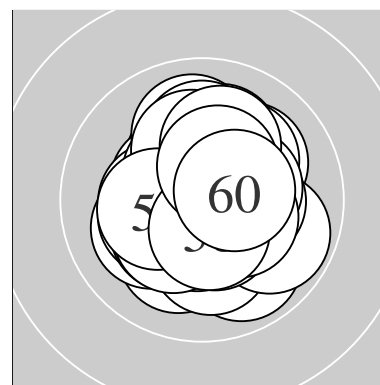

| | | | | | |
|--------------|--|--------|--------|--------|--------|
| Serie 1: | 10.5 * | 10.3 * | 10.5 * | 10.3 * | 10.2 * |
| | 10.1 ↙ | 10.7 * | 9.9 ↘ | 10.7 * | 10.2 * |
| beste Teiler | 62.6 (7.) 64.3 (9.) 104.9 (1.) | | | | |
| Trefferlage | 0.42 mm rechts, 0.14 mm tief | | | | |
| Streuwert | 1.18, horizontal: 0.82, vertikal: 1.45 | | | | |

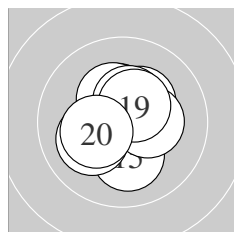

| | | | | | |
|--------------|--|--------|--------|--------|--------|
| Serie 2: | 10.6 * | 10.4 * | 10.3 * | 10.3 * | 10.1 ↓ |
| | 10.1 ↙ | 10.3 * | 10.4 * | 10.5 * | 10.3 * |
| beste Teiler | 82.9 (11.) 124.8 (19.) 129.9 (18.) | | | | |
| Trefferlage | 0.01 mm links, 0.18 mm hoch | | | | |
| Streuwert | 1.17, horizontal: 1.10, vertikal: 1.23 | | | | |

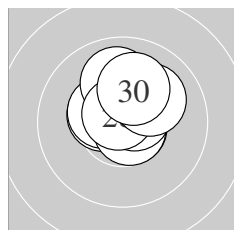

| | | | | | |
|--------------|--|--------|--------|--------|--------|
| Serie 3: | 10.4 * | 10.7 * | 10.7 * | 10.4 * | 10.7 * |
| | 10.0 ↑ | 10.6 * | 10.7 * | 10.1 ↗ | 10.1 ↑ |
| beste Teiler | 58.5 (28.) 60.1 (25.) 60.8 (23.) | | | | |
| Trefferlage | 0.06 mm rechts, 0.76 mm hoch | | | | |
| Streuwert | 0.91, horizontal: 0.90, vertikal: 0.93 | | | | |

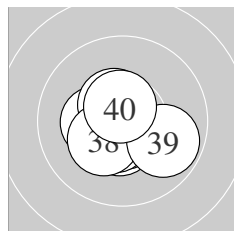

| | | | | | |
|--------------|--|--------|--------|--------|--------|
| Serie 4: | 10.6 * | 10.3 * | 10.9 * | 10.5 * | 10.5 * |
| | 10.7 * | 10.5 * | 10.3 * | 9.8 ↘ | 10.6 * |
| beste Teiler | 5.0 (33.) 74.4 (36.) 80.8 (31.) | | | | |
| Trefferlage | 0.23 mm links, 0.32 mm tief | | | | |
| Streuwert | 0.97, horizontal: 1.10, vertikal: 0.83 | | | | |

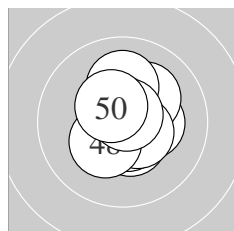

| | | | | | |
|--------------|--|--------|--------|--------|--------|
| Serie 5: | 10.5 * | 10.5 * | 10.3 * | 10.2 * | 10.6 * |
| | 10.1 ↑ | 10.5 * | 10.3 * | 10.7 * | 10.5 * |
| beste Teiler | 51.4 (49.) 86.1 (45.) 103.5 (41.) | | | | |
| Trefferlage | 0.28 mm rechts, 0.23 mm hoch | | | | |
| Streuwert | 1.02, horizontal: 0.85, vertikal: 1.16 | | | | |

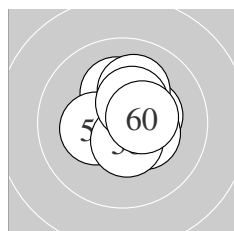

| | | | | | |
|--------------|--|--------|--------|--------|--------|
| Serie 6: | 10.8 * | 10.4 * | 10.2 * | 10.3 * | 10.3 * |
| | 10.4 * | 10.1 ↑ | 10.5 * | 10.4 * | 10.5 * |
| beste Teiler | 47.2 (51.) 112.2 (58.) 125.0 (60.) | | | | |
| Trefferlage | 0.35 mm rechts, 0.53 mm hoch | | | | |
| Streuwert | 1.01, horizontal: 0.96, vertikal: 1.05 | | | | |

Meyton Elektronik

ISSF AR Men – Wertung – Männer

StandNr: 127

Höllwarth, Michael #35

StartNr: 74

30. November 2019 12:00

AUT

QF – Schütze hat sich fürs Finale qualifiziert

Unterschrift des Schützen

Meyton Elektronik

| | | |
|--------------|--------------|----------------------------------|
| Ergebnis: | 624.6 | (595) ^{QF} |
| Serien: | 104.6 | 103.5 105.0 104.9 102.9 103.7 |
| Zähler: | 55 | 5 0 0 0 0 0 0 0 0 |
| Innenzehner: | 47 | |
| weiteste: | 360 | (40), 352 (49), 300 (42) |
| beste Teiler | 4.4 | (29.) 7.2 (37.) 12.5 (54.) |
| Trefferlage | 0.09 mm | links, 0.13 mm hoch |
| Streuwert | 1.13, | horizontal: 1.33, vertikal: 0.89 |

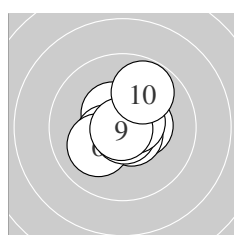
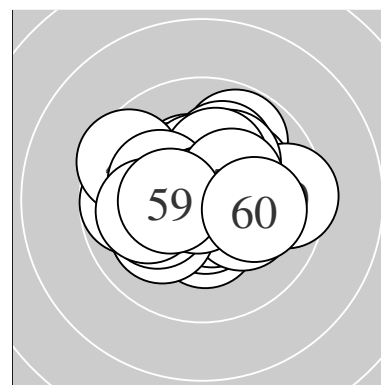

| | | | | | |
|--------------|---------|----------------------------------|-----------|--------|--------|
| Serie 1: | 10.5 * | 10.5 * | 10.4 * | 10.4 * | 10.6 * |
| | 10.1 ↙ | 10.8 * | 10.6 * | 10.9 * | 9.8 ↗ |
| beste Teiler | 15.8 | (9.) 40.8 (7.) | 82.3 (5.) | | |
| Trefferlage | 0.17 mm | rechts, 0.11 mm hoch | | | |
| Streuwert | 1.06, | horizontal: 1.08, vertikal: 1.04 | | | |

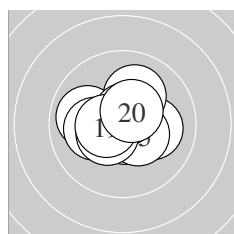

| | | | | | |
|--------------|---------|----------------------------------|-------------|--------|--------|
| Serie 2: | 9.9 ↖ | 10.1 → | 10.7 * | 10.1 ↗ | 10.4 * |
| | 10.7 * | 10.2 * | 10.4 * | 10.5 * | 10.5 * |
| beste Teiler | 63.7 | (13.) 71.8 (16.) | 113.7 (20.) | | |
| Trefferlage | 0.17 mm | links, 0.13 mm hoch | | | |
| Streuwert | 1.20, | horizontal: 1.46, vertikal: 0.88 | | | |

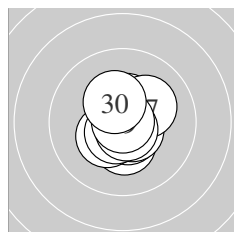

| | | | | | |
|--------------|---------|----------------------------------|------------|--------|--------|
| Serie 3: | 10.4 * | 10.3 * | 10.6 * | 10.4 * | 10.6 * |
| | 10.6 * | 10.2 * | 10.7 * | 10.9 * | 10.3 * |
| beste Teiler | 4.4 | (29.) 58.5 (28.) | 87.3 (25.) | | |
| Trefferlage | 0.12 mm | rechts, 0.13 mm tief | | | |
| Streuwert | 0.91, | horizontal: 0.75, vertikal: 1.04 | | | |

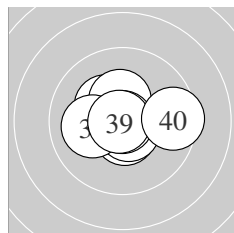

| | | | | | |
|--------------|---------|----------------------------------|------------|--------|--------|
| Serie 4: | 10.6 * | 10.9 * | 10.7 * | 10.3 * | 10.6 * |
| | 10.4 * | 10.9 * | 10.1 ↙ | 10.9 * | 9.5 → |
| beste Teiler | 7.2 | (37.) 19.2 (32.) | 24.5 (39.) | | |
| Trefferlage | 0.00 mm | , 0.07 mm hoch | | | |
| Streuwert | 1.16, | horizontal: 1.48, vertikal: 0.71 | | | |

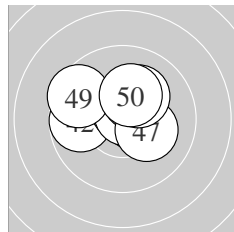

| | | | | | |
|--------------|---------|----------------------------------|------------|--------|--------|
| Serie 5: | 10.6 * | 9.8 ↖ | 10.6 * | 10.7 * | 10.8 * |
| | 10.3 * | 10.2 * | 10.2 * | 9.5 ↖ | 10.2 * |
| beste Teiler | 41.3 | (45.) 74.1 (44.) | 86.0 (43.) | | |
| Trefferlage | 0.04 mm | links, 0.74 mm hoch | | | |
| Streuwert | 1.33, | horizontal: 1.66, vertikal: 0.86 | | | |

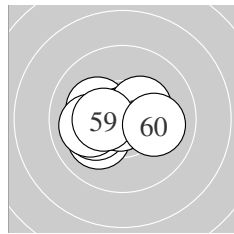

| | | | | | |
|--------------|---------|----------------------------------|------------|--------|--------|
| Serie 6: | 10.7 * | 10.2 * | 10.1 ↙ | 10.9 * | 10.1 ↙ |
| | 10.0 ↖ | 10.9 * | 10.4 * | 10.4 * | 10.0 → |
| beste Teiler | 12.5 | (54.) 19.6 (57.) | 73.0 (51.) | | |
| Trefferlage | 0.63 mm | links, 0.13 mm tief | | | |
| Streuwert | 1.15, | horizontal: 1.49, vertikal: 0.64 | | | |

Meyton Elektronik

ISSF AR Men – Wertung – Männer

StandNr: 128

Hrckulak, David #32

StartNr: 75

30. November 2019 11:58

CZE – Dukla Pilsen

QF – Schütze hat sich fürs Finale qualifiziert

Unterschrift des Schützen

Meyton Elektronik

| | | |
|--------------|--|-------------------------|
| Ergebnis: | 605.1 | (581) |
| Serien: | 100.5 99.4 | 103.5 100.0 100.8 100.9 |
| Zähler: | 44 14 1 1 | 0 0 0 0 0 0 |
| Innenzehner: | 34 | |
| weiteste: | 878 (12), 618 (36), 442 (56) | |
| beste Teiler | 30.0 (26.) 37.5 (41.) | 56.3 (37.) |
| Trefferlage | 0.42 mm links, 0.24 mm hoch | |
| Streuwert | 1.83, horizontal: 2.12, vertikal: 1.48 | |

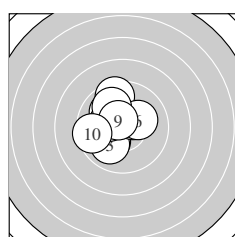
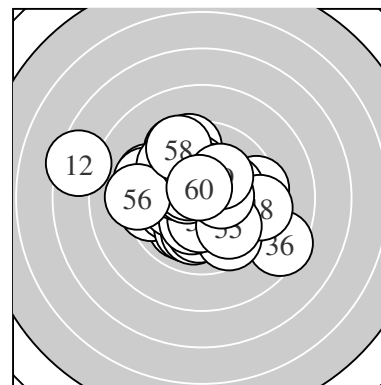

| | | | | | |
|--------------|--|--------|--------|--------|-------|
| Serie 1: | 10.1 ↙ | 10.0 ↘ | 10.0 ↙ | 10.4 * | 9.5 ↑ |
| | 10.2 * | 10.3 * | 9.9 ↘ | 10.6 * | 9.5 ← |
| beste Teiler | 94.0 (9.) 144.5 (4.) 166.9 (7.) | | | | |
| Trefferlage | 0.90 mm links, 0.63 mm hoch | | | | |
| Streuwert | 1.59, horizontal: 1.48, vertikal: 1.70 | | | | |

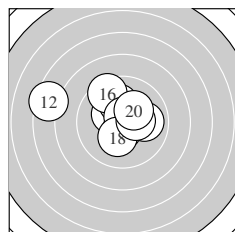

| | | | | | |
|--------------|--|--------|--------|--------|--------|
| Serie 2: | 10.3 * | 7.4 ← | 10.6 * | 10.0 → | 10.1 ↑ |
| | 9.5 ↘ | 10.7 * | 10.2 * | 10.4 * | 10.2 * |
| beste Teiler | 62.9 (17.) 92.2 (13.) 150.8 (19.) | | | | |
| Trefferlage | 0.72 mm links, 0.82 mm hoch | | | | |
| Streuwert | 2.39, horizontal: 3.01, vertikal: 1.52 | | | | |

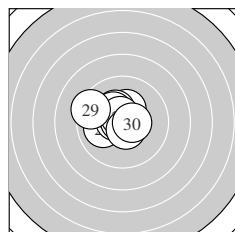

| | | | | | |
|--------------|--|--------|--------|--------|--------|
| Serie 3: | 10.3 * | 10.0 ← | 10.6 * | 10.3 * | 10.3 * |
| | 10.8 * | 10.7 * | 10.6 * | 9.4 ↖ | 10.5 * |
| beste Teiler | 30.0 (26.) 73.5 (27.) 84.8 (23.) | | | | |
| Trefferlage | 0.73 mm links, 0.48 mm hoch | | | | |
| Streuwert | 1.16, horizontal: 1.38, vertikal: 0.88 | | | | |

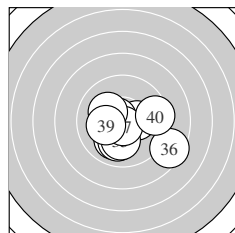

| | | | | | |
|--------------|--|--------|--------|--------|--------|
| Serie 4: | 10.0 ↙ | 10.3 * | 10.0 ↓ | 10.6 * | 10.1 ↓ |
| | 8.5 ↘ | 10.7 * | 10.2 * | 10.2 * | 9.4 → |
| beste Teiler | 56.3 (37.) 78.5 (34.) 163.1 (32.) | | | | |
| Trefferlage | 0.46 mm rechts, 0.86 mm tief | | | | |
| Streuwert | 1.98, horizontal: 2.39, vertikal: 1.46 | | | | |

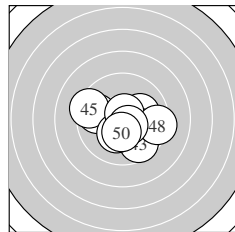

| | | | | | |
|--------------|--|--------|-------|--------|--------|
| Serie 5: | 10.8 * | 10.1 → | 9.6 ↘ | 9.8 ← | 9.3 ← |
| | 10.2 * | 10.7 * | 9.3 → | 10.6 * | 10.4 * |
| beste Teiler | 37.5 (41.) 67.0 (47.) 94.8 (49.) | | | | |
| Trefferlage | 0.07 mm rechts, 0.38 mm tief | | | | |
| Streuwert | 1.85, horizontal: 2.29, vertikal: 1.26 | | | | |

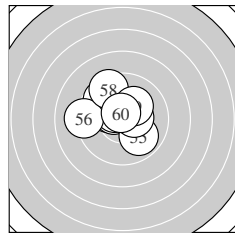

| | | | | | |
|--------------|--|--------|--------|--------|--------|
| Serie 6: | 10.3 * | 10.5 * | 10.5 * | 9.7 ↘ | 9.9 ↘ |
| | 9.2 ← | 10.4 * | 9.5 ↘ | 10.2 * | 10.7 * |
| beste Teiler | 72.5 (60.) 112.2 (52.) 115.4 (53.) | | | | |
| Trefferlage | 0.75 mm links, 0.79 mm hoch | | | | |
| Streuwert | 1.67, horizontal: 1.90, vertikal: 1.40 | | | | |

Meyton Elektronik

ISSF AR Men – Wertung – Männer

StandNr: 142

Insam, Fabian #141

StartNr: 76

30. November 2019 12:02

SG Schwaz

Unterschrift des Schützen

Meyton Elektronik

| | | |
|--------------|--|------------------------------|
| Ergebnis: | 610.9 | (580) |
| Serien: | 103.9 | 103.5 102.2 102.3 100.0 99.0 |
| Zähler: | 41 | 18 1 0 0 0 0 0 0 0 |
| Innenzehner: | 34 | |
| weiteste: | 589 (60), 386 (39), 375 (53) | |
| beste Teiler | 17.1 (17.) | 19.1 (13.) 32.8 (18.) |
| Trefferlage | 0.38 mm rechts, 0.25 mm tief | |
| Streuwert | 1.56, horizontal: 1.64, vertikal: 1.47 | |

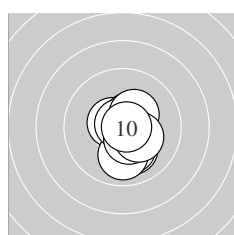
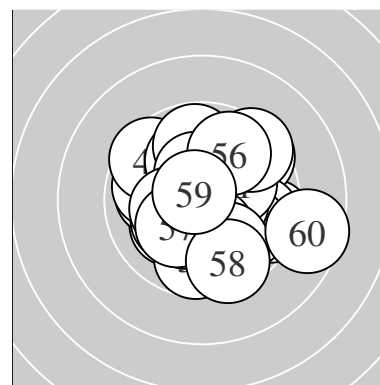

| | | | | | |
|--------------|--|--------|--------|--------|--------|
| Serie 1: | 10.5 * | 10.1 ↘ | 10.1 ↘ | 10.0 ↓ | 10.5 * |
| | 10.8 * | 10.5 * | 10.3 * | 10.3 * | 10.8 * |
| beste Teiler | 35.0 (10.) 38.9 (6.) 101.2 (1.) | | | | |
| Trefferlage | 0.44 mm rechts, 0.55 mm tief | | | | |
| Streuwert | 1.02, horizontal: 0.68, vertikal: 1.28 | | | | |

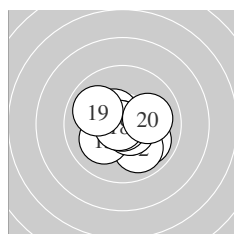

| | | | | | |
|--------------|--|--------|--------|--------|--------|
| Serie 2: | 9.9 ↘ | 9.9 ↘ | 10.9 * | 10.5 * | 10.1 ↗ |
| | 10.6 * | 10.9 * | 10.8 * | 9.9 ↖ | 10.0 → |
| beste Teiler | 17.1 (17.) 19.1 (13.) 32.8 (18.) | | | | |
| Trefferlage | 0.15 mm rechts, 0.32 mm tief | | | | |
| Streuwert | 1.29, horizontal: 1.49, vertikal: 1.05 | | | | |

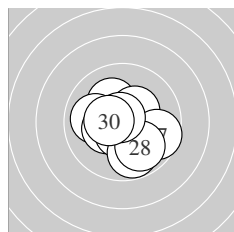

| | | | | | |
|--------------|--|--------|--------|--------|--------|
| Serie 3: | 10.2 * | 10.0 ← | 10.4 * | 10.3 * | 10.6 * |
| | 9.8 ↓ | 9.7 ↘ | 9.9 ↘ | 10.8 * | 10.5 * |
| beste Teiler | 46.5 (29.) 100.4 (25.) 122.8 (30.) | | | | |
| Trefferlage | 0.00 mm , 0.40 mm tief | | | | |
| Streuwert | 1.51, horizontal: 1.64, vertikal: 1.38 | | | | |

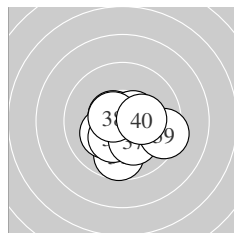

| | | | | | |
|--------------|--|--------|--------|--------|--------|
| Serie 4: | 9.7 ↓ | 10.6 * | 10.5 * | 10.2 * | 10.5 * |
| | 10.3 * | 10.2 * | 10.6 * | 9.4 → | 10.3 * |
| beste Teiler | 92.7 (38.) 97.1 (32.) 105.0 (35.) | | | | |
| Trefferlage | 0.40 mm rechts, 0.69 mm tief | | | | |
| Streuwert | 1.40, horizontal: 1.60, vertikal: 1.18 | | | | |

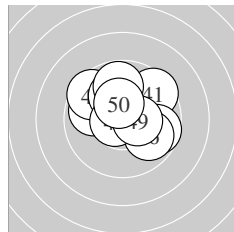

| | | | | | |
|--------------|--|--------|-------|--------|--------|
| Serie 5: | 9.5 ↗ | 9.9 ↖ | 9.6 ↖ | 9.7 → | 10.1 ↖ |
| | 9.9 ↘ | 10.7 * | 9.8 ↑ | 10.4 * | 10.4 * |
| beste Teiler | 71.8 (47.) 133.8 (49.) 144.8 (50.) | | | | |
| Trefferlage | 0.18 mm rechts, 0.88 mm hoch | | | | |
| Streuwert | 1.82, horizontal: 2.08, vertikal: 1.51 | | | | |

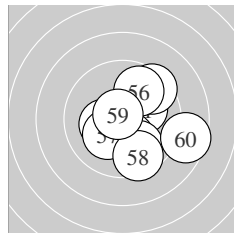

| | | | | | |
|--------------|--|--------|-------|--------|--------|
| Serie 6: | 10.2 * | 10.3 * | 9.5 ↗ | 9.9 ↘ | 10.3 * |
| | 9.8 ↗ | 10.2 * | 9.5 ↓ | 10.7 * | 8.6 → |
| beste Teiler | 59.3 (59.) 172.5 (55.) 173.6 (52.) | | | | |
| Trefferlage | 1.14 mm rechts, 0.43 mm tief | | | | |
| Streuwert | 2.06, horizontal: 2.11, vertikal: 2.02 | | | | |

Meyton Elektronik

ISSF AR Men – Wertung – **Männer**

StandNr: 130

Matej, Medved #142

StartNr: 77

30. November 2019 12:04

SK – SK Dukla

Unterschrift des Schützen

Meyton Elektronik

| | | | | | | | | | |
|--------------|--|---------------------|-----------|-------|-------|-------|---|---|---|
| Ergebnis: | 624.6 | (595) ^{QF} | | | | | | | |
| Serien: | 105.5 | 104.2 | 105.0 | 104.2 | 103.7 | 102.0 | | | |
| Zähler: | 55 | 5 | 0 | 0 | 0 | 0 | 0 | 0 | 0 |
| Innenzehner: | 50 | | | | | | | | |
| weiteste: | 380 (60), 291 (7), 289 (45) | | | | | | | | |
| beste Teiler | 5.0 (17.) | 22.5 (9.) | 29.1 (1.) | | | | | | |
| Trefferlage | 0.05 mm rechts, 0.50 mm hoch | | | | | | | | |
| Streuwert | 1.04, horizontal: 1.16, vertikal: 0.92 | | | | | | | | |

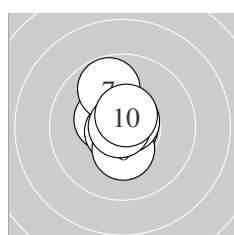
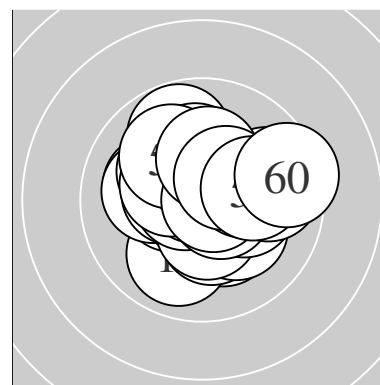

| | | | | | |
|--------------|--|-----------|-----------|--------|--------|
| Serie 1: | 10.8 * | 10.7 * | 10.6 * | 10.4 * | 10.7 * |
| | 10.3 * | 9.8 ↖ | 10.7 * | 10.9 * | 10.6 * |
| beste Teiler | 22.5 (9.) | 29.1 (1.) | 58.5 (5.) | | |
| Trefferlage | 0.26 mm links, 0.40 mm hoch | | | | |
| Streuwert | 0.86, horizontal: 0.56, vertikal: 1.08 | | | | |

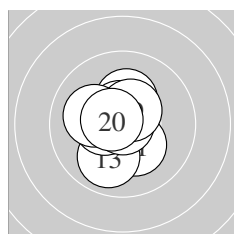

| | | | | | |
|--------------|--|------------|------------|--------|--------|
| Serie 2: | 10.3 * | 10.6 * | 9.9 ↙ | 10.3 * | 10.4 * |
| | 10.6 * | 10.9 * | 10.1 ← | 10.5 * | 10.6 * |
| beste Teiler | 5.0 (17.) | 84.3 (20.) | 90.7 (16.) | | |
| Trefferlage | 0.40 mm links, 0.16 mm hoch | | | | |
| Streuwert | 1.07, horizontal: 0.90, vertikal: 1.21 | | | | |

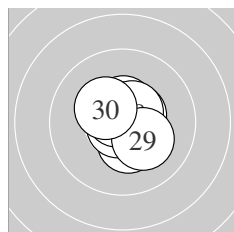

| | | | | | |
|--------------|--|------------|------------|--------|--------|
| Serie 3: | 10.5 * | 10.4 * | 10.4 * | 10.5 * | 10.6 * |
| | 10.8 * | 10.7 * | 10.6 * | 10.2 * | 10.3 * |
| beste Teiler | 46.6 (26.) | 59.5 (27.) | 96.9 (25.) | | |
| Trefferlage | 0.01 mm links, 0.23 mm hoch | | | | |
| Streuwert | 0.89, horizontal: 0.87, vertikal: 0.91 | | | | |

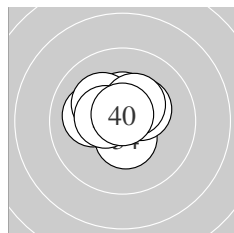

| | | | | | |
|--------------|--|------------|-------------|--------|--------|
| Serie 4: | 10.3 * | 10.4 * | 10.8 * | 10.5 * | 10.1 ← |
| | 10.3 * | 10.2 * | 10.4 * | 10.4 * | 10.8 * |
| beste Teiler | 34.3 (33.) | 48.0 (40.) | 121.2 (34.) | | |
| Trefferlage | 0.32 mm links, 0.57 mm hoch | | | | |
| Streuwert | 0.94, horizontal: 1.09, vertikal: 0.76 | | | | |

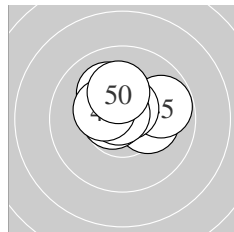

| | | | | | |
|--------------|--|------------|------------|--------|--------|
| Serie 5: | 10.4 * | 10.5 * | 10.2 * | 10.7 * | 9.8 → |
| | 10.6 * | 10.8 * | 10.1 ↖ | 10.4 * | 10.2 * |
| beste Teiler | 47.2 (47.) | 72.4 (44.) | 83.6 (46.) | | |
| Trefferlage | 0.13 mm rechts, 0.88 mm hoch | | | | |
| Streuwert | 1.03, horizontal: 1.28, vertikal: 0.71 | | | | |

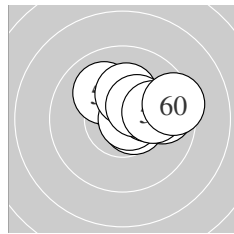

| | | | | | |
|--------------|--|------------|-------------|--------|--------|
| Serie 6: | 10.5 * | 10.6 * | 10.0 ↖ | 9.8 → | 10.8 * |
| | 10.2 * | 10.2 * | 10.4 * | 10.1 → | 9.4 → |
| beste Teiler | 49.0 (55.) | 86.3 (52.) | 112.2 (51.) | | |
| Trefferlage | 1.17 mm rechts, 0.80 mm hoch | | | | |
| Streuwert | 1.16, horizontal: 1.48, vertikal: 0.70 | | | | |

Meyton Elektronik

ISSF AR Men – Wertung – Männer

StandNr: 131

Mathis, Thomas #39

StartNr: 78

30. November 2019 11:42

AUT

QF – Schütze hat sich fürs Finale qualifiziert

Unterschrift des Schützen

Meyton Elektronik

| | | | | | | | | | |
|--------------|--|------------|------------|-------|-------|-------|---|---|---|
| Ergebnis: | 618.6 | (594) | | | | | | | |
| Serien: | 101.6 | 103.5 | 101.7 | 104.5 | 104.1 | 103.2 | | | |
| Zähler: | 54 | 6 | 0 | 0 | 0 | 0 | 0 | 0 | 0 |
| Innenzehner: | 38 | | | | | | | | |
| weiteste: | 286 (19), 284 (3), 284 (43) | | | | | | | | |
| beste Teiler | 4.1 (34.) | 13.8 (49.) | 51.1 (52.) | | | | | | |
| Trefferlage | 0.05 mm links, 0.15 mm hoch | | | | | | | | |
| Streuwert | 1.24, horizontal: 1.37, vertikal: 1.09 | | | | | | | | |

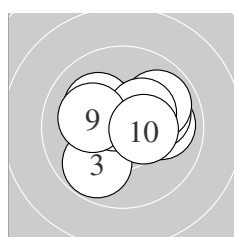
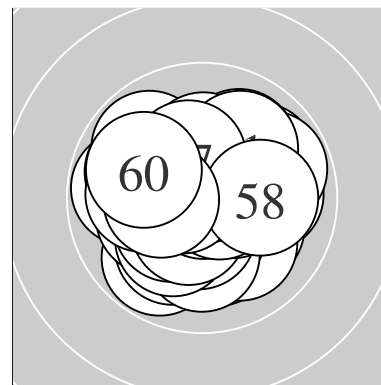

| | | | | | |
|--------------|--|--------|--------|--------|--------|
| Serie 1: | 10.0 → | 10.0 → | 9.8 ↗ | 10.6 * | 10.4 * |
| | 10.1 ↖ | 9.9 ↗ | 10.3 * | 10.1 ↖ | 10.4 * |
| beste Teiler | 88.0 (4.) 136.6 (10.) 150.2 (5.) | | | | |
| Trefferlage | 0.50 mm rechts, 0.42 mm hoch | | | | |
| Streuwert | 1.45, horizontal: 1.75, vertikal: 1.07 | | | | |

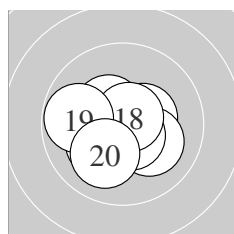

| | | | | | |
|--------------|--|--------|--------|--------|--------|
| Serie 2: | 10.4 * | 10.7 * | 10.2 * | 10.5 * | 10.1 ↘ |
| | 10.4 * | 10.6 * | 10.7 * | 9.8 ← | 10.1 ↗ |
| beste Teiler | 60.2 (18.) 60.8 (12.) 89.6 (17.) | | | | |
| Trefferlage | 0.31 mm links, 0.43 mm tief | | | | |
| Streuwert | 1.17, horizontal: 1.36, vertikal: 0.93 | | | | |

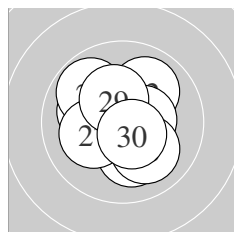

| | | | | | |
|--------------|--|--------|--------|--------|--------|
| Serie 3: | 10.1 ↓ | 10.0 ↗ | 10.1 ↖ | 9.8 ↖ | 10.3 * |
| | 10.4 * | 10.1 ← | 10.0 ↘ | 10.3 * | 10.6 * |
| beste Teiler | 98.4 (30.) 126.7 (26.) 155.9 (25.) | | | | |
| Trefferlage | 0.26 mm links, 0.04 mm hoch | | | | |
| Streuwert | 1.46, horizontal: 1.49, vertikal: 1.43 | | | | |

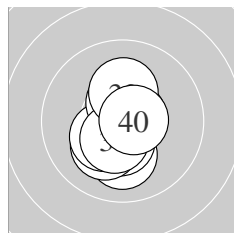

| | | | | | |
|--------------|--|--------|--------|--------|--------|
| Serie 4: | 10.1 ↓ | 10.4 * | 10.2 * | 10.9 * | 10.3 * |
| | 10.7 * | 10.5 * | 10.5 * | 10.2 * | 10.7 * |
| beste Teiler | 4.1 (34.) 64.1 (36.) 72.3 (40.) | | | | |
| Trefferlage | 0.17 mm links, 0.37 mm tief | | | | |
| Streuwert | 1.01, horizontal: 0.62, vertikal: 1.28 | | | | |

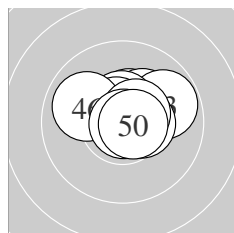

| | | | | | |
|--------------|--|--------|--------|--------|--------|
| Serie 5: | 10.4 * | 10.2 * | 9.8 ↗ | 10.5 * | 10.6 * |
| | 9.9 ↖ | 10.5 * | 10.6 * | 10.9 * | 10.7 * |
| beste Teiler | 13.8 (49.) 69.4 (50.) 78.5 (45.) | | | | |
| Trefferlage | 0.42 mm rechts, 0.64 mm hoch | | | | |
| Streuwert | 0.99, horizontal: 1.29, vertikal: 0.57 | | | | |

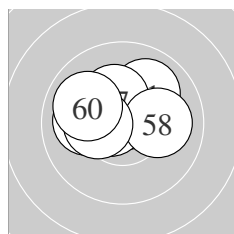

| | | | | | |
|--------------|--|--------|--------|--------|--------|
| Serie 6: | 10.0 ↗ | 10.7 * | 10.7 * | 10.0 ← | 10.6 * |
| | 10.6 * | 10.3 * | 10.0 → | 10.3 * | 10.0 ↖ |
| beste Teiler | 51.1 (52.) 65.7 (53.) 79.5 (56.) | | | | |
| Trefferlage | 0.49 mm links, 0.61 mm hoch | | | | |
| Streuwert | 1.15, horizontal: 1.47, vertikal: 0.68 | | | | |

Meyton Elektronik

ISSF AR Men – Wertung – **Männer**

StandNr: 132

Muxel, Thomas #143

StartNr: 79

30. November 2019 11:37

LZ Vorarlberg

Unterschrift des Schützen

Meyton Elektronik

| | | | | | | | |
|--------------|--|-------|-------|-------|-------|-------|---|
| Ergebnis: | 620.8 | (596) | | | | | |
| Serien: | 104.3 | 103.8 | 103.2 | 102.3 | 103.2 | 104.0 | |
| Zähler: | 56 | 4 | 0 | 0 | 0 | 0 | 0 |
| Innenzehner: | 48 | | | | | | |
| weiteste: | 368 (43), 301 (39), 261 (24) | | | | | | |
| beste Teiler | 15.6 (4.) 29.4 (47.) 42.1 (21.) | | | | | | |
| Trefferlage | 0.07 mm rechts, 0.08 mm hoch | | | | | | |
| Streuwert | 1.19, horizontal: 1.14, vertikal: 1.23 | | | | | | |

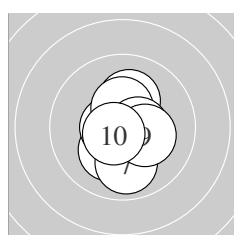
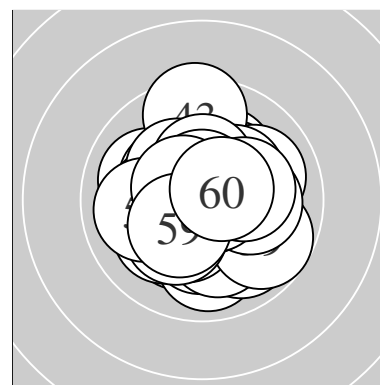

| | | | | | |
|--------------|--|--------|--------|--------|--------|
| Serie 1: | 10.2 * | 10.2 * | 10.6 * | 10.9 * | 10.7 * |
| | 10.4 * | 9.9 ↓ | 10.5 * | 10.3 * | 10.6 * |
| beste Teiler | 15.6 (4.) 59.5 (5.) 79.4 (10.) | | | | |
| Trefferlage | 0.04 mm rechts, 0.26 mm tief | | | | |
| Streuwert | 1.08, horizontal: 0.84, vertikal: 1.28 | | | | |

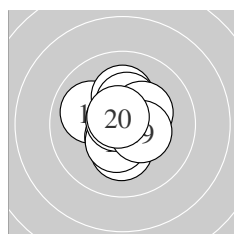

| | | | | | |
|--------------|--|--------|--------|--------|--------|
| Serie 2: | 10.0 ↖ | 10.2 * | 10.5 * | 10.2 * | 10.3 * |
| | 10.3 * | 10.4 * | 10.8 * | 10.4 * | 10.7 * |
| beste Teiler | 50.2 (18.) 61.5 (20.) 102.0 (13.) | | | | |
| Trefferlage | 0.10 mm links, 0.15 mm hoch | | | | |
| Streuwert | 1.13, horizontal: 1.02, vertikal: 1.23 | | | | |

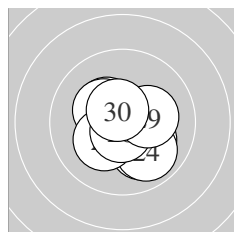

| | | | | | |
|--------------|--|--------|--------|--------|--------|
| Serie 3: | 10.8 * | 10.1 ↘ | 10.0 ↘ | 9.9 ↘ | 10.4 * |
| | 10.3 * | 10.2 * | 10.7 * | 10.2 * | 10.6 * |
| beste Teiler | 42.1 (21.) 66.9 (28.) 93.6 (30.) | | | | |
| Trefferlage | 0.17 mm rechts, 0.39 mm tief | | | | |
| Streuwert | 1.24, horizontal: 1.31, vertikal: 1.17 | | | | |

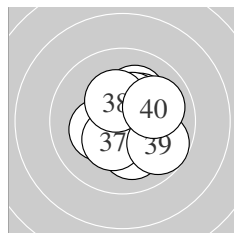

| | | | | | |
|--------------|--|--------|--------|--------|--------|
| Serie 4: | 10.2 * | 10.3 * | 10.1 ↓ | 10.6 * | 10.4 * |
| | 10.3 * | 10.4 * | 10.3 * | 9.7 ↘ | 10.0 → |
| beste Teiler | 80.5 (34.) 143.6 (35.) 148.9 (37.) | | | | |
| Trefferlage | 0.62 mm rechts, 0.15 mm hoch | | | | |
| Streuwert | 1.34, horizontal: 1.28, vertikal: 1.40 | | | | |

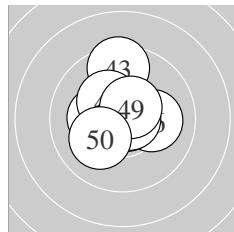

| | | | | | |
|--------------|--|--------|--------|--------|--------|
| Serie 5: | 10.2 * | 10.2 * | 9.5 ↑ | 10.7 * | 10.3 * |
| | 10.1 → | 10.8 * | 10.8 * | 10.5 * | 10.1 ↖ |
| beste Teiler | 29.4 (47.) 50.0 (48.) 60.7 (44.) | | | | |
| Trefferlage | 0.13 mm links, 0.64 mm hoch | | | | |
| Streuwert | 1.27, horizontal: 1.17, vertikal: 1.37 | | | | |

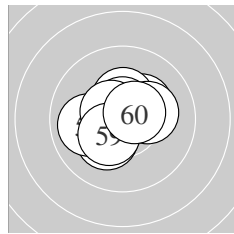

| | | | | | |
|--------------|--|--------|--------|--------|--------|
| Serie 6: | 10.2 * | 10.7 * | 10.0 ← | 10.3 * | 10.4 * |
| | 10.6 * | 10.6 * | 10.2 * | 10.4 * | 10.6 * |
| beste Teiler | 56.9 (52.) 79.0 (56.) 97.1 (60.) | | | | |
| Trefferlage | 0.16 mm links, 0.22 mm hoch | | | | |
| Streuwert | 1.11, horizontal: 1.27, vertikal: 0.92 | | | | |

Meyton Elektronik

ISSF AR Men – Wertung – Männer

StandNr: 133

Thum, Andreas #45

StartNr: 80

30. November 2019 11:49

AUT

Unterschrift des Schützen

Meyton Elektronik

| | | | | | | | |
|--------------|--|-------|-------|-------|-------|-------|---|
| Ergebnis: | 623.0 | (596) | | | | | |
| Serien: | 104.5 | 103.5 | 103.5 | 103.4 | 104.6 | 103.5 | |
| Zähler: | 56 | 4 | 0 | 0 | 0 | 0 | 0 |
| Innenzehner: | 47 | | | | | | |
| weiteste: | 324 (14), 307 (40), 259 (36) | | | | | | |
| beste Teiler | 18.2 (47.) 29.1 (39.) 31.0 (25.) | | | | | | |
| Trefferlage | 0.11 mm rechts, 0.11 mm hoch | | | | | | |
| Streuwert | 1.13, horizontal: 1.29, vertikal: 0.94 | | | | | | |

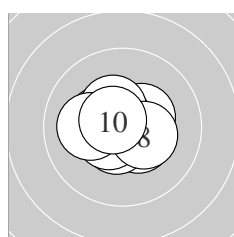
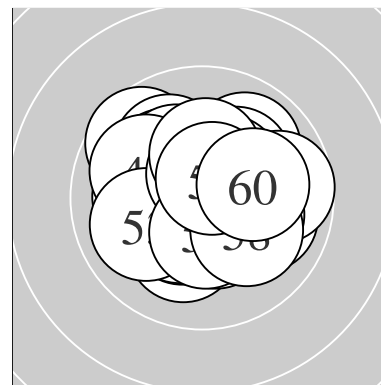

Serie 1:

| | | | | |
|--------------|--|--------|--------|--------|
| 10.4 * | 10.4 * | 10.6 * | 10.4 * | 10.5 * |
| 10.7 * | 10.4 * | 10.4 * | 10.1 ← | 10.6 * |
| beste Teiler | 73.9 (6.) 81.0 (10.) 96.6 (3.) | | | |
| Trefferlage | 0.28 mm links, 0.07 mm hoch | | | |
| Streuwert | 0.98, horizontal: 1.17, vertikal: 0.73 | | | |

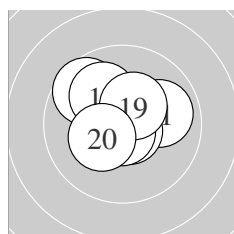

Serie 2:

| | | | | |
|--------------|--|--------|--------|--------|
| 9.9 → | 10.6 * | 10.7 * | 9.7 ↘ | 10.6 * |
| 10.6 * | 10.0 ↘ | 10.7 * | 10.4 * | 10.3 * |
| beste Teiler | 52.3 (18.) 60.1 (13.) 81.1 (12.) | | | |
| Trefferlage | 0.30 mm links, 0.57 mm hoch | | | |
| Streuwert | 1.20, horizontal: 1.35, vertikal: 1.03 | | | |

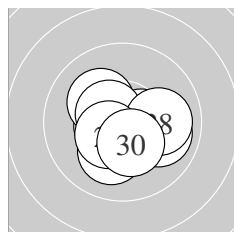

Serie 3:

| | | | | |
|--------------|--|--------|--------|--------|
| 10.0 → | 10.1 ↓ | 10.5 * | 10.2 * | 10.8 * |
| 10.5 * | 10.5 * | 10.0 → | 10.5 * | 10.4 * |
| beste Teiler | 31.0 (25.) 103.3 (23.) 104.9 (27.) | | | |
| Trefferlage | 0.14 mm rechts, 0.35 mm tief | | | |
| Streuwert | 1.20, horizontal: 1.43, vertikal: 0.92 | | | |

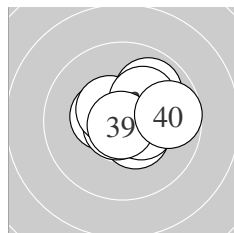

Serie 4:

| | | | | |
|--------------|--|--------|--------|--------|
| 10.4 * | 10.4 * | 10.4 * | 10.7 * | 10.5 * |
| 9.9 ↗ | 10.4 * | 10.2 * | 10.8 * | 9.7 → |
| beste Teiler | 29.1 (39.) 51.0 (34.) 115.4 (35.) | | | |
| Trefferlage | 0.69 mm rechts, 0.35 mm hoch | | | |
| Streuwert | 1.12, horizontal: 1.32, vertikal: 0.87 | | | |

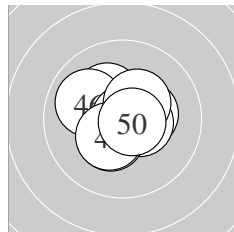

Serie 5:

| | | | | |
|--------------|--|--------|--------|--------|
| 10.4 * | 10.5 * | 10.2 * | 10.7 * | 10.4 * |
| 10.0 ↘ | 10.9 * | 10.4 * | 10.4 * | 10.7 * |
| beste Teiler | 18.2 (47.) 55.3 (44.) 65.8 (50.) | | | |
| Trefferlage | 0.11 mm links, 0.13 mm hoch | | | |
| Streuwert | 1.05, horizontal: 1.17, vertikal: 0.90 | | | |

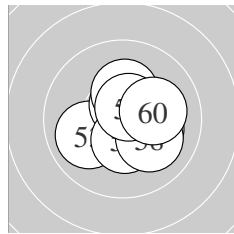

Serie 6:

| | | | | |
|--------------|--|--------|--------|--------|
| 10.5 * | 10.7 * | 10.0 ← | 10.6 * | 10.2 * |
| 10.4 * | 10.3 * | 10.1 ↘ | 10.6 * | 10.1 → |
| beste Teiler | 75.0 (52.) 87.6 (59.) 96.0 (54.) | | | |
| Trefferlage | 0.56 mm rechts, 0.11 mm tief | | | |
| Streuwert | 1.16, horizontal: 1.24, vertikal: 1.07 | | | |

Meyton Elektronik

ISSF AR Men – Wertung – **Männer**

StandNr: 134

Nymbursky, Petr #28

StartNr: 81

30. November 2019 11:52

CZE

Unterschrift des Schützen

Meyton Elektronik

| | | | | | | | | | |
|--------------|--|------------|------------|-------|-------|-------|---|---|---|
| Ergebnis: | 618.9 | (594) | | | | | | | |
| Serien: | 101.7 | 103.6 | 103.0 | 102.2 | 103.7 | 104.7 | | | |
| Zähler: | 54 | 6 | 0 | 0 | 0 | 0 | 0 | 0 | 0 |
| Innenzehner: | 45 | | | | | | | | |
| weiteste: | 420 (1), 378 (13), 302 (35) | | | | | | | | |
| beste Teiler | 8.6 (27.) | 28.6 (19.) | 31.2 (51.) | | | | | | |
| Trefferlage | 0.07 mm rechts, 0.28 mm hoch | | | | | | | | |
| Streuwert | 1.24, horizontal: 1.38, vertikal: 1.09 | | | | | | | | |

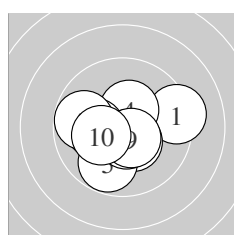
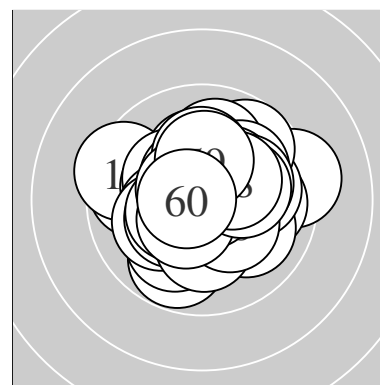

| | | | | | |
|--------------|--|--------|--------|--------|--------|
| Serie 1: | 9.3 → | 10.5 * | 10.4 * | 10.4 * | 9.8 ↙ |
| | 10.1 ← | 9.8 ← | 10.6 * | 10.5 * | 10.3 * |
| beste Teiler | 96.4 (8.) 101.5 (2.) 104.6 (9.) | | | | |
| Trefferlage | 0.11 mm links, 0.23 mm tief | | | | |
| Streuwert | 1.64, horizontal: 1.97, vertikal: 1.23 | | | | |

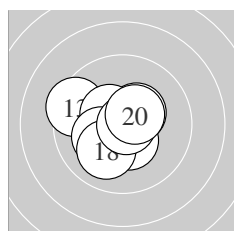

| | | | | | |
|--------------|--|--------|--------|--------|--------|
| Serie 2: | 10.6 * | 10.4 * | 9.4 ↖ | 10.8 * | 10.5 * |
| | 10.2 * | 10.4 * | 10.0 ↗ | 10.8 * | 10.5 * |
| beste Teiler | 28.6 (19.) 49.2 (14.) 78.2 (11.) | | | | |
| Trefferlage | 0.37 mm links, 0.02 mm hoch | | | | |
| Streuwert | 1.27, horizontal: 1.46, vertikal: 1.06 | | | | |

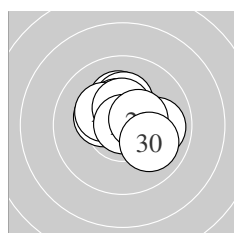

| | | | | | |
|--------------|--|--------|--------|--------|--------|
| Serie 3: | 10.3 * | 10.2 * | 10.2 * | 10.4 * | 10.3 * |
| | 10.4 * | 10.9 * | 9.9 → | 10.4 * | 10.0 ↘ |
| beste Teiler | 8.6 (27.) 127.2 (29.) 131.1 (26.) | | | | |
| Trefferlage | 0.22 mm rechts, 0.69 mm hoch | | | | |
| Streuwert | 1.16, horizontal: 1.32, vertikal: 0.96 | | | | |

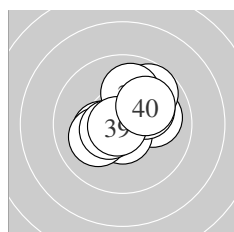

| | | | | | |
|--------------|--|--------|--------|--------|--------|
| Serie 4: | 10.0 → | 10.6 * | 10.3 * | 10.1 ↙ | 9.7 ↗ |
| | 10.1 ↗ | 10.5 * | 10.0 ↑ | 10.8 * | 10.1 ↗ |
| beste Teiler | 44.3 (39.) 78.0 (32.) 111.2 (37.) | | | | |
| Trefferlage | 0.34 mm rechts, 0.47 mm hoch | | | | |
| Streuwert | 1.40, horizontal: 1.54, vertikal: 1.24 | | | | |

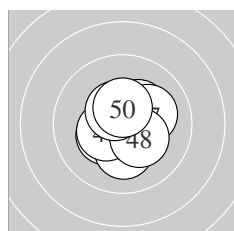

| | | | | | |
|--------------|--|--------|--------|--------|--------|
| Serie 5: | 10.6 * | 10.3 * | 10.5 * | 10.2 * | 10.3 * |
| | 10.4 * | 10.1 → | 10.3 * | 10.5 * | 10.5 * |
| beste Teiler | 89.1 (41.) 103.5 (43.) 115.2 (49.) | | | | |
| Trefferlage | 0.18 mm rechts, 0.14 mm hoch | | | | |
| Streuwert | 1.10, horizontal: 1.07, vertikal: 1.12 | | | | |

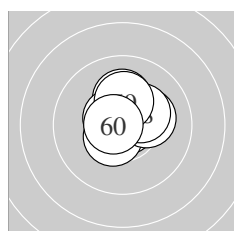

| | | | | | |
|--------------|--|--------|--------|--------|--------|
| Serie 6: | 10.8 * | 10.7 * | 10.5 * | 10.2 * | 10.6 * |
| | 10.2 * | 10.5 * | 10.3 * | 10.2 * | 10.7 * |
| beste Teiler | 31.2 (51.) 52.2 (52.) 70.1 (60.) | | | | |
| Trefferlage | 0.16 mm rechts, 0.64 mm hoch | | | | |
| Streuwert | 0.86, horizontal: 0.87, vertikal: 0.84 | | | | |

Meyton Elektronik

ISSF AR Men – Wertung – **Männer**

StandNr: 135

Ondrej, Holko #144

StartNr: 82

30. November 2019 12:03

SK – SK Dukla

Unterschrift des Schützen

Meyton Elektronik

Ergebnis: **615.8** (586)

Serien: 101.4 103.4 102.7 103.0 102.8 102.5

Zähler: 47 12 1 0 0 0 0 0 0

Innenzehner: 40

weiteste: 520 (8), 484 (7), 412 (32)

beste Teiler 7.0 (11.) 36.0 (1.) 36.0 (26.)

Trefferlage 0.24 mm rechts, 0.21 mm hoch

Streuwert 1.43, horizontal: 1.69, vertikal: 1.11

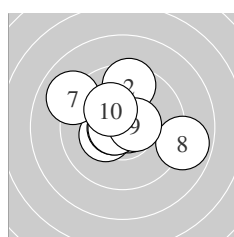
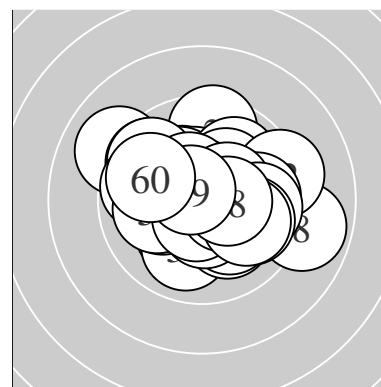

Serie 1:

| | | | | |
|--------|-------|--------|--------|--------|
| 10.8 * | 9.5 ↑ | 10.8 * | 10.3 * | 10.7 * |
| 10.7 * | 9.0 ↖ | 8.9 → | 10.5 * | 10.2 * |

beste Teiler 36.0 (1.) 43.9 (3.) 66.6 (6.)

Trefferlage 0.13 mm links, 0.56 mm hoch

Streuwert 1.94, horizontal: 2.31, vertikal: 1.48

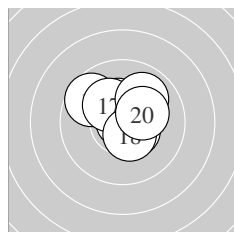

Serie 2:

| | | | | |
|--------|--------|--------|--------|--------|
| 10.9 * | 10.4 * | 10.5 * | 10.5 * | 10.6 * |
| 9.7 ↖ | 10.2 * | 10.5 * | 9.9 ↗ | 10.2 * |

beste Teiler 7.0 (11.) 95.5 (15.) 115.2 (13.)

Trefferlage 0.14 mm rechts, 0.71 mm hoch

Streuwert 1.19, horizontal: 1.32, vertikal: 1.04

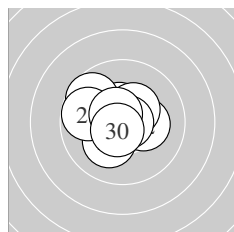

Serie 3:

| | | | | |
|--------|--------|--------|--------|--------|
| 9.8 ↖ | 10.3 * | 10.5 * | 10.4 * | 10.2 * |
| 10.8 * | 9.7 ↖ | 9.8 ← | 10.6 * | 10.6 * |

beste Teiler 36.0 (26.) 79.8 (30.) 88.6 (29.)

Trefferlage 0.74 mm links, 0.45 mm hoch

Streuwert 1.33, horizontal: 1.56, vertikal: 1.06

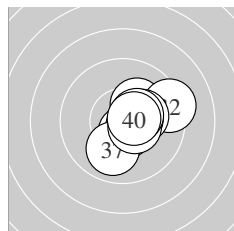

Serie 4:

| | | | | |
|--------|--------|--------|--------|--------|
| 10.2 * | 9.3 → | 10.6 * | 10.3 * | 10.5 * |
| 10.6 * | 10.0 ↓ | 10.5 * | 10.4 * | 10.6 * |

beste Teiler 95.3 (36.) 96.8 (33.) 98.2 (40.)

Trefferlage 1.12 mm rechts, 0.02 mm tief

Streuwert 1.15, horizontal: 1.20, vertikal: 1.09

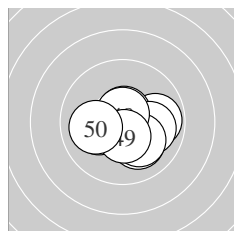

Serie 5:

| | | | | |
|--------|--------|--------|--------|--------|
| 10.8 * | 9.9 → | 10.6 * | 10.1 ← | 10.1 ↓ |
| 10.0 → | 10.1 ↘ | 10.7 * | 10.5 * | 10.0 ← |

beste Teiler 50.9 (41.) 67.0 (48.) 76.9 (43.)

Trefferlage 0.38 mm rechts, 0.38 mm tief

Streuwert 1.31, horizontal: 1.62, vertikal: 0.89

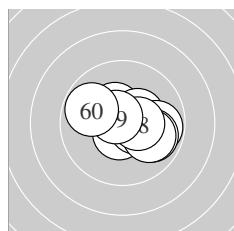

Serie 6:

| | | | | |
|--------|--------|--------|--------|-------|
| 10.4 * | 10.6 * | 10.4 * | 9.8 → | 9.9 → |
| 10.5 * | 10.0 ↘ | 10.4 * | 10.7 * | 9.8 ↖ |

beste Teiler 75.0 (59.) 89.4 (52.) 117.0 (56.)

Trefferlage 0.70 mm rechts, 0.03 mm tief

Streuwert 1.34, horizontal: 1.70, vertikal: 0.85

Meyton Elektronik

ISSF AR Men – Wertung – **Männer**

StandNr: 136

Patka, Hannes #145

StartNr: 83

30. November 2019 12:07

T – SG Mieming

Unterschrift des Schützen

Meyton Elektronik

| | | |
|--------------|--------------|----------------------------------|
| Ergebnis: | 621.1 | (595) |
| Serien: | 104.3 | 104.1 104.2 102.3 103.8 102.4 |
| Zähler: | 55 | 5 0 0 0 0 0 0 0 0 |
| Innenzehner: | 48 | |
| weiteste: | 335 | (58), 284 (38), 278 (45) |
| beste Teiler | 49.4 | (42.) 50.6 (52.) 53.0 (24.) |
| Trefferlage | 0.09 | mm links, 0.12 mm hoch |
| Streuwert | 1.17, | horizontal: 1.07, vertikal: 1.26 |

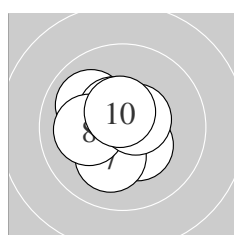
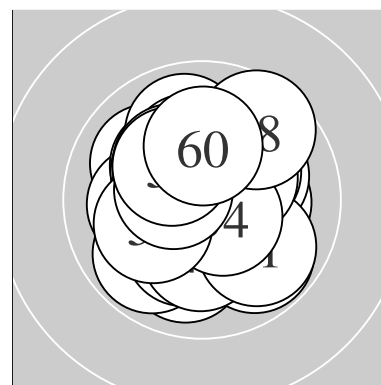

| | | | | | |
|--------------|--------|----------------------------------|--------|--------|--------|
| Serie 1: | 10.0 ↘ | 10.6 * | 10.6 * | 10.5 * | 10.4 * |
| | 10.7 * | 10.2 * | 10.1 ← | 10.6 * | 10.6 * |
| beste Teiler | 53.8 | (6.) 77.1 (2.) 86.9 (3.) | | | |
| Trefferlage | 0.47 | mm links, 0.10 mm hoch | | | |
| Streuwert | 1.02, | horizontal: 1.02, vertikal: 1.03 | | | |

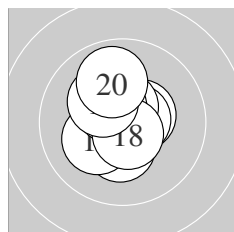

| | | | | | |
|--------------|--------|----------------------------------|--------|--------|--------|
| Serie 2: | 10.5 * | 10.6 * | 10.7 * | 10.3 * | 10.2 * |
| | 10.6 * | 10.5 * | 10.6 * | 10.2 * | 9.9 ↑ |
| beste Teiler | 54.0 | (13.) 80.1 (18.) 80.8 (12.) | | | |
| Trefferlage | 0.26 | mm links, 0.29 mm hoch | | | |
| Streuwert | 1.05, | horizontal: 0.86, vertikal: 1.21 | | | |

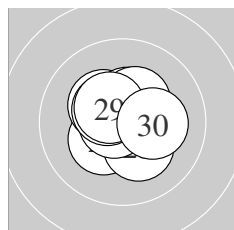

| | | | | | |
|--------------|--------|----------------------------------|--------|--------|--------|
| Serie 3: | 10.6 * | 10.3 * | 10.2 * | 10.7 * | 10.3 * |
| | 10.5 * | 10.5 * | 10.4 * | 10.5 * | 10.2 * |
| beste Teiler | 53.0 | (24.) 89.6 (21.) 121.8 (29.) | | | |
| Trefferlage | 0.00 | mm, 0.19 mm hoch | | | |
| Streuwert | 1.04, | horizontal: 1.08, vertikal: 0.99 | | | |

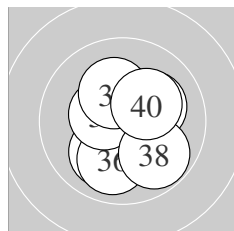

| | | | | | |
|--------------|--------|----------------------------------|--------|--------|--------|
| Serie 4: | 10.1 ↙ | 10.4 * | 10.1 ↗ | 10.5 * | 10.5 * |
| | 10.0 ↓ | 10.5 * | 9.8 ↘ | 10.2 * | 10.2 * |
| beste Teiler | 113.2 | (35.) 121.1 (34.) 123.7 (37.) | | | |
| Trefferlage | 0.19 | mm rechts, 0.13 mm hoch | | | |
| Streuwert | 1.41, | horizontal: 1.19, vertikal: 1.59 | | | |

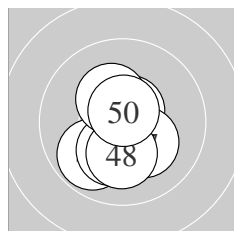

| | | | | | |
|--------------|--------|----------------------------------|--------|--------|--------|
| Serie 5: | 10.4 * | 10.8 * | 10.6 * | 10.6 * | 9.8 ↙ |
| | 10.2 * | 10.2 * | 10.2 * | 10.3 * | 10.7 * |
| beste Teiler | 49.4 | (42.) 71.2 (50.) 81.1 (43.) | | | |
| Trefferlage | 0.10 | mm links, 0.56 mm tief | | | |
| Streuwert | 1.11, | horizontal: 0.91, vertikal: 1.28 | | | |

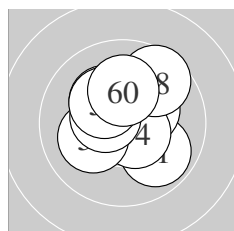

| | | | | | |
|--------------|--------|----------------------------------|--------|--------|--------|
| Serie 6: | 9.9 ↘ | 10.8 * | 10.3 * | 10.6 * | 10.2 * |
| | 10.1 ← | 10.5 * | 9.6 ↗ | 10.3 * | 10.1 ↑ |
| beste Teiler | 50.6 | (52.) 100.4 (54.) 114.8 (57.) | | | |
| Trefferlage | 0.12 | mm rechts, 0.57 mm hoch | | | |
| Streuwert | 1.39, | horizontal: 1.41, vertikal: 1.37 | | | |

Meyton Elektronik

ISSF AR Men – Wertung – **Männer**

StandNr: 137

Kostenzer, Thomas #146

StartNr: 84

30. November 2019 12:02

T – SG Münster

Unterschrift des Schützen

Meyton Elektronik

| | | |
|--------------|--|--------------------------|
| Ergebnis: | 573.4 | (547) |
| Serien: | 99.5 | 91.6 94.8 96.1 95.9 95.5 |
| Zähler: | 21 27 10 2 0 0 0 0 0 0 | |
| Innenzehner: | 14 | |
| weiteste: | 789 (15), 785 (56), 659 (20) | |
| beste Teiler | 78.0 (38.) 96.8 (28.) 113.5 (7.) | |
| Trefferlage | 0.39 mm rechts, 0.27 mm hoch | |
| Streuwert | 2.75, horizontal: 3.34, vertikal: 2.00 | |

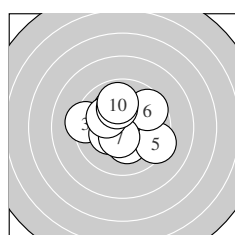
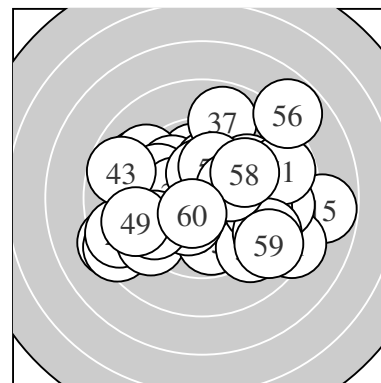

| | | | | | |
|--------------|--|------------|------------|--------|-------|
| Serie 1: | 10.2 * | 10.1 ↖ | 9.3 ← | 10.3 * | 9.4 ↘ |
| | 9.6 ↗ | 10.5 * | 10.1 ↘ | 10.1 ↑ | 9.9 ↑ |
| beste Teiler | 113.5 (7.) | 160.9 (4.) | 179.8 (1.) | | |
| Trefferlage | 0.28 mm links, 0.48 mm hoch | | | | |
| Streuwert | 1.94, horizontal: 2.18, vertikal: 1.66 | | | | |

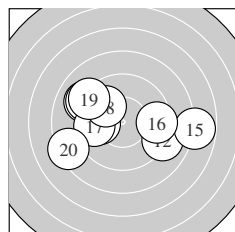

| | | | | | |
|--------------|--|-------------|-------------|-------|-------|
| Serie 2: | 9.1 ↖ | 9.0 ↘ | 10.0 ← | 9.1 ↖ | 7.8 → |
| | 9.5 → | 9.7 ← | 9.9 ↘ | 9.2 ↖ | 8.3 ← |
| beste Teiler | 249.8 (13.) | 251.8 (18.) | 310.5 (17.) | | |
| Trefferlage | 0.91 mm links, 0.25 mm hoch | | | | |
| Streuwert | 3.49, horizontal: 4.55, vertikal: 1.89 | | | | |

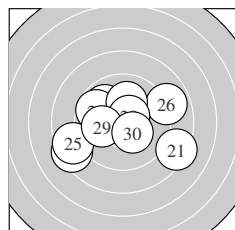

| | | | | | |
|--------------|--|-------------|-------------|--------|--------|
| Serie 3: | 8.3 ↘ | 8.4 ↖ | 9.9 ↖ | 9.7 ↖ | 8.6 ← |
| | 8.9 → | 10.1 ↑ | 10.6 * | 10.0 ← | 10.3 * |
| beste Teiler | 96.8 (28.) | 156.3 (30.) | 222.5 (27.) | | |
| Trefferlage | 0.50 mm links, 0.21 mm tief | | | | |
| Streuwert | 3.10, horizontal: 3.85, vertikal: 2.10 | | | | |

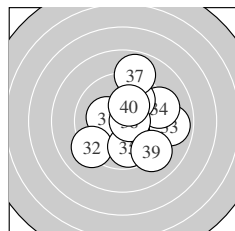

| | | | | | |
|--------------|--|-------------|-------------|-------|--------|
| Serie 4: | 10.2 * | 9.2 ↖ | 8.9 → | 9.3 → | 9.8 ↓ |
| | 9.9 ↗ | 8.9 ↑ | 10.6 * | 9.1 ↘ | 10.2 * |
| beste Teiler | 78.0 (38.) | 177.7 (31.) | 183.4 (40.) | | |
| Trefferlage | 1.18 mm rechts, 0.15 mm hoch | | | | |
| Streuwert | 2.57, horizontal: 2.52, vertikal: 2.62 | | | | |

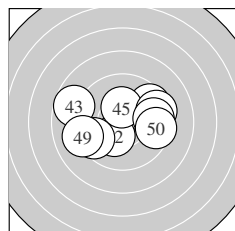

| | | | | | |
|--------------|--|-------------|-------------|-------|--------|
| Serie 5: | 9.9 → | 10.3 * | 8.7 ↖ | 9.6 ↗ | 10.3 * |
| | 9.4 → | 9.5 ← | 9.6 → | 9.1 ← | 9.5 → |
| beste Teiler | 160.3 (45.) | 175.2 (42.) | 270.1 (41.) | | |
| Trefferlage | 0.23 mm rechts, 0.25 mm hoch | | | | |
| Streuwert | 2.68, horizontal: 3.49, vertikal: 1.48 | | | | |

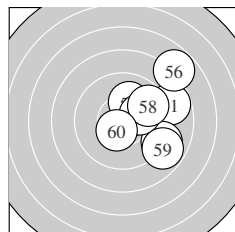

| | | | | | |
|--------------|--|-------------|-------------|--------|--------|
| Serie 6: | 8.8 → | 10.3 * | 9.0 ↘ | 10.3 * | 10.1 ↑ |
| | 7.8 ↗ | 10.2 * | 9.7 ↗ | 8.8 ↘ | 10.5 * |
| beste Teiler | 120.9 (60.) | 154.3 (52.) | 163.8 (54.) | | |
| Trefferlage | 2.64 mm rechts, 0.74 mm hoch | | | | |
| Streuwert | 2.27, horizontal: 2.11, vertikal: 2.42 | | | | |

Meyton Elektronik

ISSF AR Men – Wertung – Männer
StandNr: 138
Grabensberger, Siegfried #147

StartNr: 85
30. November 2019 11:49
ST – SV Kapfenberg

Unterschrift des Schützen

Meyton Elektronik

| | | |
|--------------|--------------|----------------------------------|
| Ergebnis: | 624.2 | (599) ^{QF} |
| Serien: | 104.7 | 104.5 103.9 103.7 103.6 103.8 |
| Zähler: | 59 | 1 0 0 0 0 0 0 0 0 |
| Innenzehner: | 47 | |
| weiteste: | 259 | (56), 233 (2), 232 (49) |
| beste Teiler | 11.0 | (17.) 25.3 (18.) 31.3 (53.) |
| Trefferlage | 0.10 mm | rechts, 0.02 mm hoch |
| Streuwert | 1.07, | horizontal: 1.01, vertikal: 1.13 |

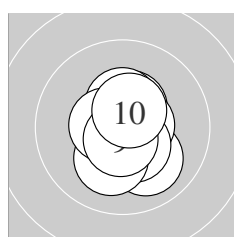
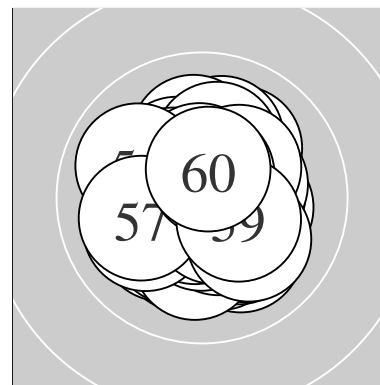

| | | | | | |
|--------------|---------|-------------------|----------------|--------|--------|
| Serie 1: | 10.5 * | 10.0 ↘ | 10.7 * | 10.6 * | 10.4 * |
| | 10.5 * | 10.2 * | 10.6 * | 10.7 * | 10.5 * |
| beste Teiler | 65.0 | (3.) 72.9 (9.) | 88.8 (4.) | | |
| Trefferlage | 0.13 mm | rechts, 0.21 mm | tief | | |
| Streuwert | 0.99, | horizontal: 0.75, | vertikal: 1.18 | | |

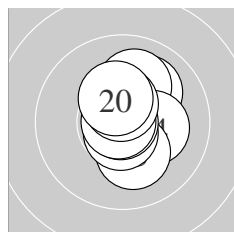

| | | | | | |
|--------------|---------|-------------------|----------------|--------|--------|
| Serie 2: | 10.1 ↗ | 10.0 ↑ | 10.6 * | 10.2 * | 10.2 * |
| | 10.7 * | 10.9 * | 10.9 * | 10.5 * | 10.4 * |
| beste Teiler | 11.0 | (17.) 25.3 (18.) | 65.9 (16.) | | |
| Trefferlage | 0.37 mm | rechts, 0.29 mm | hoch | | |
| Streuwert | 1.04, | horizontal: 0.73, | vertikal: 1.27 | | |

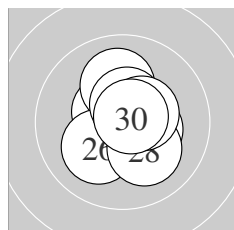

| | | | | | |
|--------------|---------|-------------------|----------------|--------|--------|
| Serie 3: | 10.5 * | 10.6 * | 10.5 * | 10.1 ↑ | 10.4 * |
| | 10.1 ↙ | 10.5 * | 10.1 ↘ | 10.4 * | 10.7 * |
| beste Teiler | 60.4 | (30.) 90.6 (22.) | 102.6 (21.) | | |
| Trefferlage | 0.33 mm | rechts, 0.24 mm | hoch | | |
| Streuwert | 1.05, | horizontal: 0.94, | vertikal: 1.15 | | |

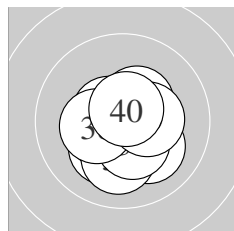

| | | | | | |
|--------------|---------|-------------------|----------------|--------|--------|
| Serie 4: | 10.2 * | 10.4 * | 10.1 ↘ | 10.6 * | 10.5 * |
| | 10.1 ↓ | 10.4 * | 10.3 * | 10.4 * | 10.7 * |
| beste Teiler | 75.2 | (40.) 93.9 (34.) | 125.8 (35.) | | |
| Trefferlage | 0.00 mm | , 0.51 mm | tief | | |
| Streuwert | 1.10, | horizontal: 1.11, | vertikal: 1.09 | | |

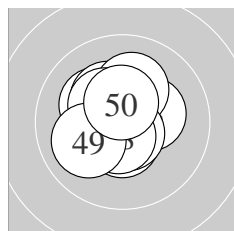

| | | | | | |
|--------------|---------|-------------------|----------------|--------|--------|
| Serie 5: | 10.5 * | 10.2 * | 10.3 * | 10.3 * | 10.1 ↑ |
| | 10.7 * | 10.4 * | 10.6 * | 10.0 ↙ | 10.5 * |
| beste Teiler | 73.5 | (46.) 89.5 (48.) | 110.0 (41.) | | |
| Trefferlage | 0.35 mm | links, 0.33 mm | hoch | | |
| Streuwert | 1.11, | horizontal: 1.07, | vertikal: 1.15 | | |

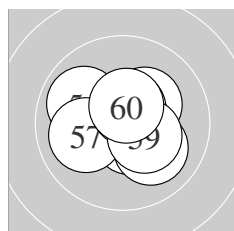

| | | | | | |
|--------------|---------|-------------------|----------------|--------|--------|
| Serie 6: | 10.3 * | 10.7 * | 10.8 * | 10.6 * | 10.1 ↘ |
| | 9.9 ↖ | 10.0 ← | 10.6 * | 10.3 * | 10.5 * |
| beste Teiler | 31.3 | (53.) 60.4 (52.) | 92.3 (58.) | | |
| Trefferlage | 0.17 mm | rechts, 0.02 mm | hoch | | |
| Streuwert | 1.19, | horizontal: 1.38, | vertikal: 0.97 | | |

Meyton Elektronik

ISSF AR Men – Wertung – Männer

StandNr: 139

Schmir, Alexander #148

StartNr: 86

30. November 2019 12:04

AUT

QF – Schütze hat sich fürs Finale qualifiziert

Unterschrift des Schützen

Meyton Elektronik

Ergebnis: **617.5** (590)
 Serien: 102.9 103.5 102.1 103.2 103.2 102.6
 Zähler: 50 10 0 0 0 0 0 0 0
 Innenzehner: 41
 weiteste: 288 (51), 285 (40), 281 (57)
 beste Teiler 10.8 (13.) 46.0 (34.) 67.2 (3.)
 Trefferlage 0.17 mm links, 0.35 mm tief
 Streuwert 1.24, horizontal: 1.30, vertikal: 1.19

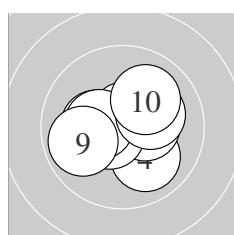
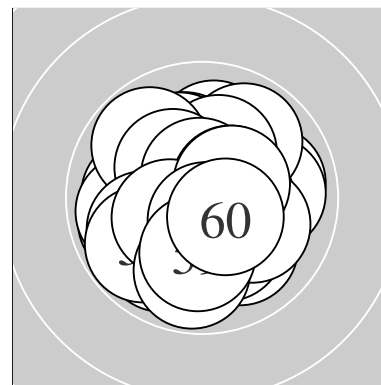

Serie 1:
 10.4 * 10.3 * 10.7 * 10.0 ↘ 10.4 *
 10.6 * 10.4 * 10.2 * 9.9 ← 10.0 ↗
 beste Teiler 67.2 (3.) 93.5 (6.) 132.9 (1.)
 Trefferlage 0.08 mm rechts, 0.03 mm tief
 Streuwert 1.34, horizontal: 1.60, vertikal: 1.02

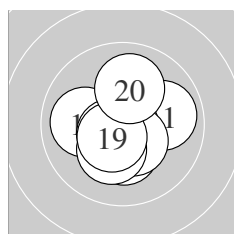

Serie 2:
 9.9 → 10.0 ← 10.9 * 10.3 * 10.6 *
 10.7 * 10.4 * 10.2 * 10.5 * 10.0 ↑
 beste Teiler 10.8 (13.) 74.7 (16.) 93.6 (15.)
 Trefferlage 0.09 mm links, 0.36 mm tief
 Streuwert 1.22, horizontal: 1.26, vertikal: 1.17

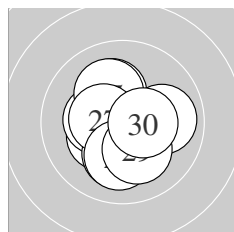

Serie 3:
 10.3 * 10.3 * 10.2 * 9.9 → 10.1 ↖
 10.1 ↓ 10.5 * 10.1 ↓ 10.2 * 10.4 *
 beste Teiler 123.7 (27.) 131.0 (30.) 159.7 (22.)
 Trefferlage 0.15 mm links, 0.26 mm tief
 Streuwert 1.38, horizontal: 1.33, vertikal: 1.43

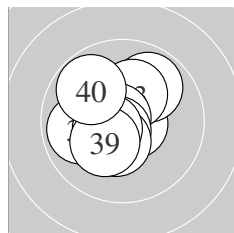

Serie 4:
 10.7 * 9.9 ↗ 10.2 * 10.8 * 10.7 *
 10.4 * 9.9 ← 10.5 * 10.3 * 9.8 ↘
 beste Teiler 46.0 (34.) 68.1 (31.) 75.7 (35.)
 Trefferlage 0.51 mm links, 0.16 mm hoch
 Streuwert 1.30, horizontal: 1.28, vertikal: 1.33

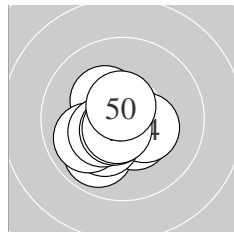

Serie 5:
 9.9 ↖ 10.3 * 10.4 * 10.3 * 10.2 *
 9.9 ← 10.3 * 10.6 * 10.7 * 10.6 *
 beste Teiler 70.8 (49.) 84.7 (50.) 88.6 (48.)
 Trefferlage 0.61 mm links, 0.65 mm tief
 Streuwert 1.05, horizontal: 1.09, vertikal: 1.00

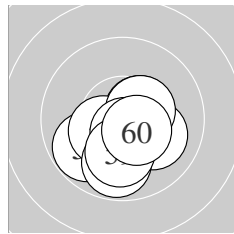

Serie 6:
 9.8 ↖ 10.5 * 10.4 * 10.1 ↘ 10.4 *
 10.4 * 9.8 ↓ 10.6 * 10.1 ↓ 10.5 *
 beste Teiler 88.2 (58.) 115.8 (60.) 121.6 (52.)
 Trefferlage 0.23 mm rechts, 0.97 mm tief
 Streuwert 1.17, horizontal: 1.28, vertikal: 1.05

Meyton Elektronik

ISSF AR Men – Wertung – Männer

StandNr: 140

Smetana, Frantisek #149

StartNr: 87

30. November 2019 11:53

CZE – Dukla Pilsen

Unterschrift des Schützen

Meyton Elektronik

| | | | | | | | | |
|--------------|--|-------|-------|-------|-------|-------|---|---|
| Ergebnis: | 618.0 | (590) | | | | | | |
| Serien: | 101.4 | 104.0 | 103.4 | 103.8 | 102.5 | 102.9 | | |
| Zähler: | 50 | 10 | 0 | 0 | 0 | 0 | 0 | 0 |
| Innenzehner: | 43 | | | | | | | |
| weiteste: | 393 (49), 307 (6), 306 (3) | | | | | | | |
| beste Teiler | 16.7 (24.) 23.7 (26.) 25.0 (11.) | | | | | | | |
| Trefferlage | 0.06 mm rechts, 0.20 mm hoch | | | | | | | |
| Streuwert | 1.29, horizontal: 1.52, vertikal: 1.03 | | | | | | | |

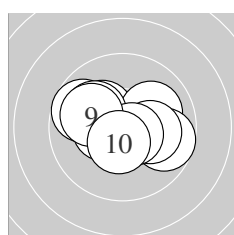
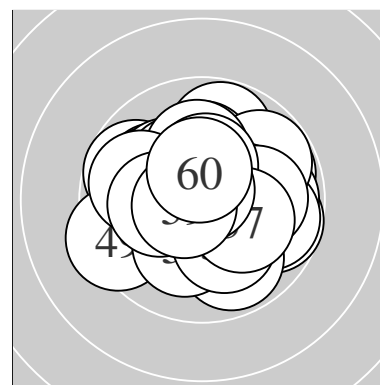

| | | | | | |
|--------------|--|--------|--------|--------|--------|
| Serie 1: | 10.4 * | 10.2 * | 9.7 ↖ | 10.0 ↗ | 10.1 ↖ |
| | 9.7 → | 10.2 * | 10.6 * | 10.0 ↖ | 10.5 * |
| beste Teiler | 83.4 (8.) 110.3 (10.) 133.0 (1.) | | | | |
| Trefferlage | 0.24 mm links, 0.22 mm hoch | | | | |
| Streuwert | 1.57, horizontal: 2.03, vertikal: 0.90 | | | | |

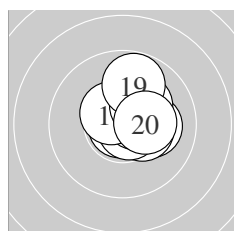

| | | | | | |
|--------------|--|--------|--------|--------|--------|
| Serie 2: | 10.9 * | 10.6 * | 10.1 → | 10.4 * | 10.7 * |
| | 10.5 * | 10.5 * | 10.2 * | 9.8 ↑ | 10.3 * |
| beste Teiler | 25.0 (11.) 54.9 (15.) 96.0 (12.) | | | | |
| Trefferlage | 0.75 mm rechts, 0.53 mm hoch | | | | |
| Streuwert | 0.93, horizontal: 0.88, vertikal: 0.98 | | | | |

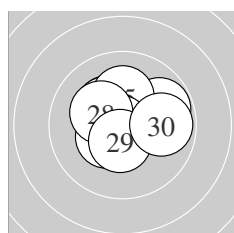

| | | | | | |
|--------------|--|--------|--------|--------|--------|
| Serie 3: | 10.3 * | 9.8 ↗ | 10.3 * | 10.9 * | 10.2 * |
| | 10.9 * | 10.4 * | 10.2 * | 10.5 * | 9.9 → |
| beste Teiler | 16.7 (24.) 23.7 (26.) 114.4 (29.) | | | | |
| Trefferlage | 0.01 mm rechts, 0.46 mm hoch | | | | |
| Streuwert | 1.28, horizontal: 1.51, vertikal: 1.00 | | | | |

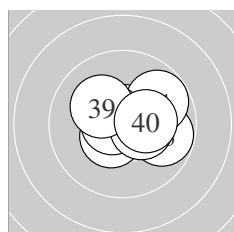

| | | | | | |
|--------------|--|--------|--------|--------|--------|
| Serie 4: | 10.7 * | 10.8 * | 9.8 → | 9.8 ↗ | 10.5 * |
| | 10.6 * | 10.7 * | 10.4 * | 10.2 * | 10.3 * |
| beste Teiler | 33.4 (32.) 57.9 (31.) 73.2 (37.) | | | | |
| Trefferlage | 0.48 mm rechts, 0.20 mm hoch | | | | |
| Streuwert | 1.20, horizontal: 1.50, vertikal: 0.80 | | | | |

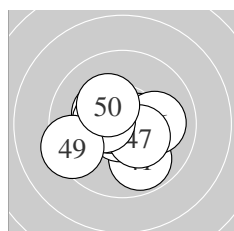

| | | | | | |
|--------------|--|--------|--------|--------|--------|
| Serie 5: | 9.8 ↘ | 10.5 * | 10.8 * | 10.6 * | 10.3 * |
| | 10.0 → | 10.4 * | 10.4 * | 9.4 ↖ | 10.3 * |
| beste Teiler | 47.9 (43.) 89.6 (44.) 102.1 (42.) | | | | |
| Trefferlage | 0.27 mm links, 0.29 mm tief | | | | |
| Streuwert | 1.45, horizontal: 1.73, vertikal: 1.12 | | | | |

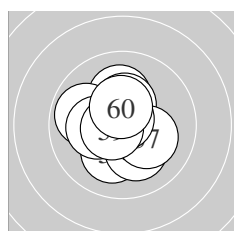

| | | | | | |
|--------------|--|--------|--------|--------|--------|
| Serie 6: | 10.1 ↓ | 10.1 ↑ | 10.4 * | 9.9 ↖ | 10.2 * |
| | 10.2 * | 10.2 * | 10.8 * | 10.6 * | 10.4 * |
| beste Teiler | 43.0 (58.) 79.6 (59.) 128.5 (60.) | | | | |
| Trefferlage | 0.34 mm links, 0.10 mm hoch | | | | |
| Streuwert | 1.28, horizontal: 1.24, vertikal: 1.33 | | | | |

Meyton Elektronik

ISSF AR Men – Wertung – Männer

StandNr: 141

Stefan, Sulek #150

StartNr: 88

30. November 2019 12:08

SK – SK Dukla

Unterschrift des Schützen

Meyton Elektronik

Ergebnis: **627.2** (598)^{QF}
 Serien: 105.3 104.3 105.8 103.7 103.7 104.4
 Zähler: 58 2 0 0 0 0 0 0 0
 Innenzehner: 51
 weiteste: 296 (50), 252 (35), 219 (32)
 beste Teiler 8.9 (34.) 34.7 (21.) 41.0 (24.)
 Trefferlage 0.01 mm rechts, 0.03 mm tief
 Streuwert 0.99, horizontal: 0.99, vertikal: 1.00

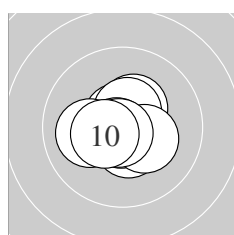
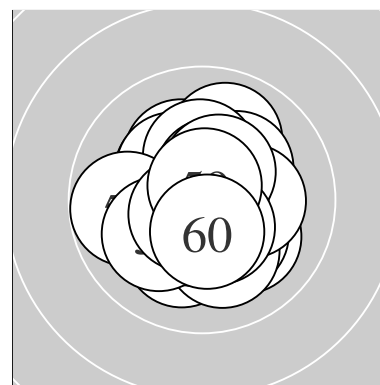

Serie 1:
 10.4 * 10.5 * 10.8 * 10.7 * 10.5 *
 10.1 ← 10.3 * 10.7 * 10.8 * 10.5 *
 beste Teiler 45.1 (3.) 45.4 (9.) 51.2 (8.)
 Trefferlage 0.15 mm links, 0.09 mm tief
 Streuwert 0.89, horizontal: 0.99, vertikal: 0.77

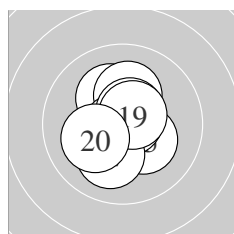

Serie 2:
 10.2 * 10.6 * 10.2 * 10.8 * 10.3 *
 10.8 * 10.1 ↙ 10.6 * 10.6 * 10.1 ←
 beste Teiler 43.3 (16.) 44.4 (14.) 83.6 (12.)
 Trefferlage 0.04 mm links, 0.01 mm hoch
 Streuwert 1.09, horizontal: 0.91, vertikal: 1.25

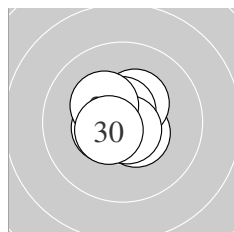

Serie 3:
 10.8 * 10.6 * 10.5 * 10.8 * 10.5 *
 10.4 * 10.7 * 10.7 * 10.3 * 10.5 *
 beste Teiler 34.7 (21.) 41.0 (24.) 57.9 (28.)
 Trefferlage 0.16 mm links, 0.10 mm hoch
 Streuwert 0.76, horizontal: 0.81, vertikal: 0.70

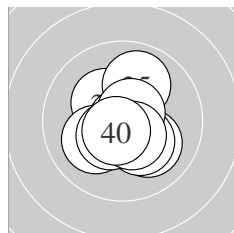

Serie 4:
 10.3 * 10.1 ↘ 10.2 * 10.9 * 9.9 ↗
 10.6 * 10.1 ↙ 10.5 * 10.5 * 10.6 *
 beste Teiler 8.9 (34.) 76.3 (36.) 76.5 (40.)
 Trefferlage 0.07 mm rechts, 0.24 mm tief
 Streuwert 1.18, horizontal: 1.10, vertikal: 1.26

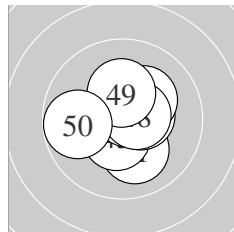

Serie 5:
 10.1 ↘ 10.4 * 10.5 * 10.6 * 10.7 *
 10.5 * 10.2 * 10.6 * 10.3 * 9.8 ←
 beste Teiler 53.9 (45.) 77.0 (44.) 96.3 (48.)
 Trefferlage 0.20 mm rechts, 0.19 mm hoch
 Streuwert 1.19, horizontal: 1.27, vertikal: 1.11

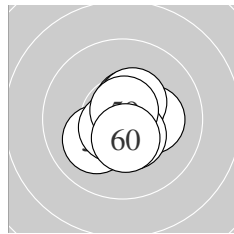

Serie 6:
 10.5 * 10.2 * 10.5 * 10.4 * 10.5 *
 10.1 ↙ 10.6 * 10.5 * 10.7 * 10.4 *
 beste Teiler 57.8 (59.) 85.7 (57.) 104.9 (53.)
 Trefferlage 0.18 mm rechts, 0.20 mm tief
 Streuwert 0.96, horizontal: 0.97, vertikal: 0.95

Meyton Elektronik

ISSF AR Men – Wertung – Männer

StandNr: 129

Strepfl, Martin #31

StartNr: 89

30. November 2019 12:02

AUT

QF – Schütze hat sich fürs Finale qualifiziert

Unterschrift des Schützen

Meyton Elektronik

Ergebnis: **598.9** (569)
 Serien: 100.1 97.3 99.0 102.8 99.3 100.4
 Zähler: 33 23 4 0 0 0 0 0 0
 Innenzehner: 28
 weiteste: 639 (49), 606 (51), 544 (29)
 beste Teiler 25.0 (35.) 41.7 (43.) 61.0 (60.)
 Trefferlage 0.02 mm rechts, 0.32 mm tief
 Streuwert 1.97, horizontal: 1.83, vertikal: 2.09

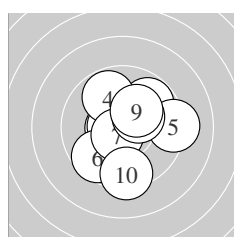
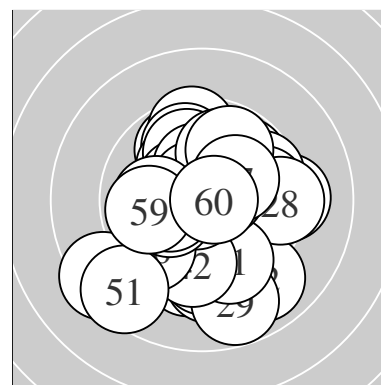

Serie 1:
 9.8 ↗ 10.6 * 10.6 * 9.8 ↘ 9.2 →
 9.6 ↙ 10.6 * 10.3 * 10.2 * 9.4 ↓
 beste Teiler 78.5 (3.) 79.8 (7.) 97.1 (2.)
 Trefferlage 0.37 mm rechts, 0.01 mm tief
 Streuwert 1.95, horizontal: 1.91, vertikal: 1.99

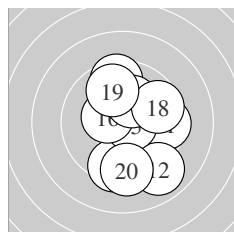

Serie 2:
 9.5 → 8.9 ↘ 9.5 ↑ 9.4 ↓ 10.7 *
 10.4 * 10.2 * 9.6 → 9.8 ↗ 9.3 ↓
 beste Teiler 74.0 (15.) 136.9 (16.) 192.9 (17.)
 Trefferlage 0.80 mm rechts, 0.23 mm tief
 Streuwert 2.35, horizontal: 1.80, vertikal: 2.80

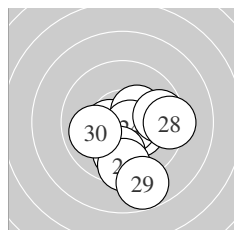

Serie 3:
 10.5 * 10.3 * 10.3 * 10.7 * 9.9 ↓
 9.5 ↓ 9.7 → 9.3 → 8.8 ↓ 10.0 ←
 beste Teiler 75.6 (24.) 114.5 (21.) 152.2 (23.)
 Trefferlage 0.84 mm rechts, 1.22 mm tief
 Streuwert 1.92, horizontal: 1.89, vertikal: 1.95

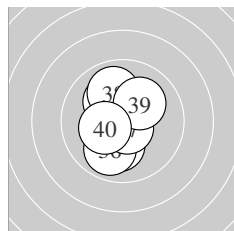

Serie 4:
 10.4 * 10.1 ↓ 10.4 * 10.1 ↘ 10.9 *
 9.9 ↓ 10.7 * 9.9 ↗ 10.1 ↗ 10.3 *
 beste Teiler 25.0 (35.) 69.6 (37.) 146.7 (33.)
 Trefferlage 0.30 mm links, 0.30 mm hoch
 Streuwert 1.33, horizontal: 0.90, vertikal: 1.65

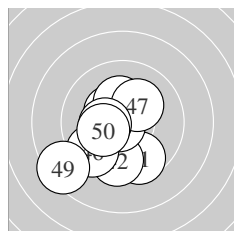

Serie 5:
 9.6 ↘ 9.6 ↓ 10.8 * 10.4 * 10.3 *
 9.5 ↙ 10.2 * 10.3 * 8.4 ↙ 10.2 *
 beste Teiler 41.7 (43.) 138.5 (44.) 151.1 (48.)
 Trefferlage 1.02 mm links, 0.97 mm tief
 Streuwert 1.97, horizontal: 1.88, vertikal: 2.05

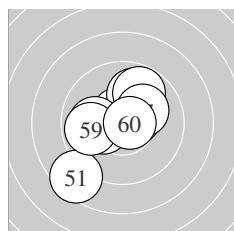

Serie 6:
 8.5 ↙ 10.5 * 10.6 * 10.3 * 9.9 ↑
 9.8 ↗ 10.2 * 10.0 ← 9.9 ← 10.7 *
 beste Teiler 61.0 (60.) 86.7 (53.) 107.3 (52.)
 Trefferlage 0.54 mm links, 0.17 mm hoch
 Streuwert 1.98, horizontal: 1.99, vertikal: 1.98

ISSF AR Men – Wertung – Männer

StandNr: 143

Novak, Patrick #151

StartNr: 90

30. November 2019 11:56

LZ Vorarlberg

Unterschrift des Schützen

Meyton Elektronik

Ergebnis: **617.7** (592)
 Serien: 101.1 103.3 102.9 104.0 102.3 104.1
 Zähler: 52 8 0 0 0 0 0 0 0 0
 Innenzehner: 44
 weiteste: 426 (56), 370 (42), 364 (45)
 beste Teiler 40.0 (57.) 51.6 (11.) 59.4 (55.)
 Trefferlage 0.28 mm links, 0.67 mm hoch
 Streuwert 1.21, horizontal: 1.36, vertikal: 1.04

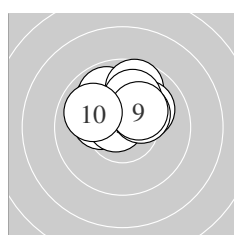
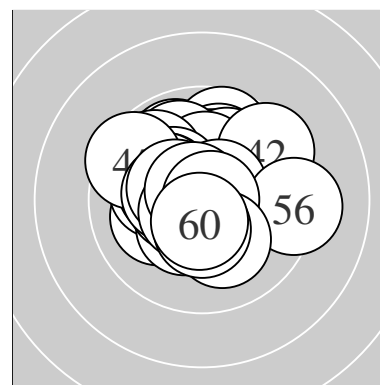

Serie 1:
 10.0 ↘ 10.3 * 9.9 ↘ 10.7 * 9.7 ↑
 10.1 ↗ 10.3 * 10.0 ↑ 10.2 * 9.9 ↖
 beste Teiler 62.1 (4.) 174.2 (2.) 175.0 (7.)
 Trefferlage 0.11 mm links, 1.50 mm hoch
 Streuwert 1.22, horizontal: 1.50, vertikal: 0.84

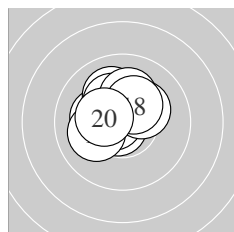

Serie 2:
 10.7 * 10.2 * 10.7 * 10.1 ↘ 10.3 *
 10.3 * 10.2 * 10.3 * 10.1 ← 10.4 *
 beste Teiler 51.6 (11.) 68.5 (13.) 147.2 (20.)
 Trefferlage 0.52 mm links, 0.75 mm hoch
 Streuwert 1.06, horizontal: 1.14, vertikal: 0.96

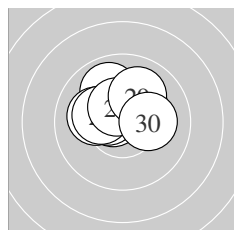

Serie 3:
 10.6 * 10.6 * 9.9 ↘ 10.1 ← 10.2 *
 10.5 * 10.3 * 10.5 * 10.0 ↑ 10.2 *
 beste Teiler 80.9 (21.) 93.7 (22.) 120.5 (26.)
 Trefferlage 0.32 mm links, 0.96 mm hoch
 Streuwert 1.08, horizontal: 1.33, vertikal: 0.76

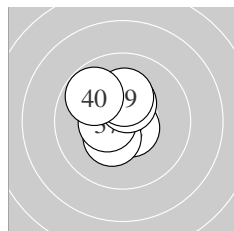

Serie 4:
 10.6 * 10.6 * 10.3 * 10.7 * 10.5 *
 10.4 * 10.5 * 10.4 * 10.2 * 9.8 ↘
 beste Teiler 68.0 (34.) 80.8 (32.) 81.1 (31.)
 Trefferlage 0.52 mm links, 0.61 mm hoch
 Streuwert 0.95, horizontal: 0.84, vertikal: 1.05

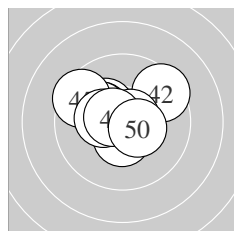

Serie 5:
 10.3 * 9.5 ↗ 10.2 * 10.2 * 9.5 ↖
 10.5 * 10.7 * 10.3 * 10.6 * 10.5 *
 beste Teiler 68.0 (47.) 84.5 (49.) 119.0 (46.)
 Trefferlage 0.55 mm links, 0.62 mm hoch
 Streuwert 1.43, horizontal: 1.76, vertikal: 1.01

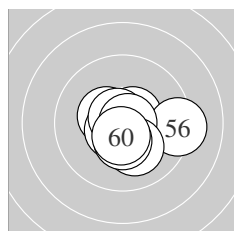

Serie 6:
 10.4 * 10.7 * 10.6 * 10.6 * 10.7 *
 9.2 → 10.8 * 10.1 ↘ 10.4 * 10.6 *
 beste Teiler 40.0 (57.) 59.4 (55.) 65.2 (52.)
 Trefferlage 0.34 mm rechts, 0.38 mm tief
 Streuwert 1.23, horizontal: 1.53, vertikal: 0.82

Meyton Elektronik

ISSF AR Men – Wertung – Männer

StandNr: 144

Weithaler, Simon #152

StartNr: 91

30. November 2019 11:57

Italien

Unterschrift des Schützen

Meyton Elektronik

| | | | | | | | | | |
|--------------|--|------------|------------|-------|-------|-------|---|---|---|
| Ergebnis: | 615.5 | (587) | | | | | | | |
| Serien: | 103.4 | 99.8 | 102.1 | 103.6 | 103.7 | 102.9 | | | |
| Zähler: | 47 | 13 | 0 | 0 | 0 | 0 | 0 | 0 | 0 |
| Innenzehner: | 41 | | | | | | | | |
| weiteste: | 489 (13), 421 (25), 421 (54) | | | | | | | | |
| beste Teiler | 14.5 (60.) | 17.2 (34.) | 25.0 (33.) | | | | | | |
| Trefferlage | 0.25 mm links, 0.48 mm hoch | | | | | | | | |
| Streuwert | 1.42, horizontal: 1.57, vertikal: 1.25 | | | | | | | | |

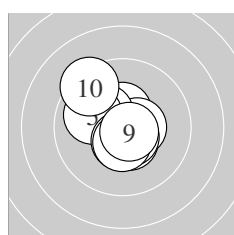
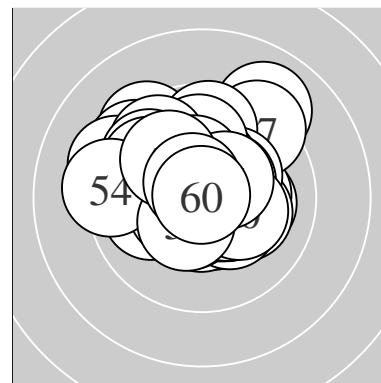

| | | | | | |
|--------------|--|--------|--------|--------|--------|
| Serie 1: | 10.5 * | 10.5 * | 10.5 * | 10.3 * | 10.0 ↖ |
| | 10.6 * | 10.5 * | 10.5 * | 10.7 * | 9.3 ↘ |
| beste Teiler | 61.0 (9.) 93.0 (6.) 105.3 (7.) | | | | |
| Trefferlage | 0.38 mm links, 0.19 mm hoch | | | | |
| Streuwert | 1.32, horizontal: 1.26, vertikal: 1.37 | | | | |

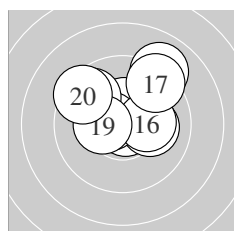

| | | | | | |
|--------------|--|--------|-------|--------|--------|
| Serie 2: | 10.8 * | 10.4 * | 9.0 ↗ | 10.1 → | 10.6 * |
| | 10.2 * | 9.3 ↗ | 9.7 ↘ | 10.3 * | 9.4 ↘ |
| beste Teiler | 31.8 (11.) 97.7 (15.) 132.4 (12.) | | | | |
| Trefferlage | 0.17 mm rechts, 1.26 mm hoch | | | | |
| Streuwert | 1.84, horizontal: 2.11, vertikal: 1.53 | | | | |

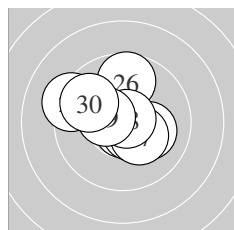

| | | | | | |
|--------------|--|--------|--------|--------|-------|
| Serie 3: | 10.3 * | 10.1 → | 10.8 * | 10.6 * | 9.3 ↖ |
| | 9.7 ↑ | 10.3 * | 10.8 * | 10.4 * | 9.8 ↗ |
| beste Teiler | 39.8 (28.) 50.3 (23.) 99.0 (24.) | | | | |
| Trefferlage | 0.18 mm links, 0.31 mm hoch | | | | |
| Streuwert | 1.62, horizontal: 1.86, vertikal: 1.35 | | | | |

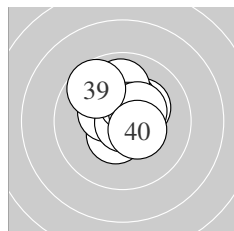

| | | | | | |
|--------------|--|--------|--------|--------|--------|
| Serie 4: | 10.5 * | 10.4 * | 10.9 * | 10.9 * | 10.2 * |
| | 10.3 * | 9.9 ↑ | 10.4 * | 9.7 ↘ | 10.4 * |
| beste Teiler | 17.2 (34.) 25.0 (33.) 115.8 (31.) | | | | |
| Trefferlage | 0.04 mm rechts, 0.72 mm hoch | | | | |
| Streuwert | 1.14, horizontal: 1.09, vertikal: 1.20 | | | | |

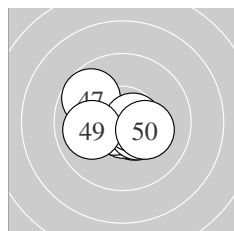

| | | | | | |
|--------------|--|--------|--------|--------|--------|
| Serie 5: | 10.5 * | 10.7 * | 10.1 ← | 10.8 * | 10.7 * |
| | 10.4 * | 9.7 ↘ | 10.6 * | 10.0 ← | 10.2 * |
| beste Teiler | 46.6 (44.) 53.7 (42.) 66.6 (45.) | | | | |
| Trefferlage | 0.24 mm links, 0.22 mm tief | | | | |
| Streuwert | 1.20, horizontal: 1.53, vertikal: 0.75 | | | | |

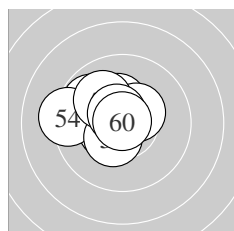

| | | | | | |
|--------------|--|--------|--------|--------|--------|
| Serie 6: | 10.7 * | 10.5 * | 9.8 ↘ | 9.3 ← | 10.3 * |
| | 10.4 * | 10.4 * | 10.0 ↘ | 10.6 * | 10.9 * |
| beste Teiler | 14.5 (60.) 75.7 (51.) 85.7 (59.) | | | | |
| Trefferlage | 0.95 mm links, 0.60 mm hoch | | | | |
| Streuwert | 1.23, horizontal: 1.49, vertikal: 0.91 | | | | |

ISSF AR Men – Wertung – **Männer**

StandNr: 145

Zach, Michael #153

StartNr: 92

30. November 2019 11:57

LZ Vorarlberg

Unterschrift des Schützen

Meyton Elektronik

Ergebnis: **622.8** (596)
 Serien: 102.7 104.5 103.5 103.7 103.7 104.7
 Zähler: 56 4 0 0 0 0 0 0 0
 Innenzehner: 53
 weiteste: 354 (8), 352 (44), 289 (1)
 beste Teiler 6.7 (16.) 9.2 (29.) 39.6 (14.)
 Trefferlage 0.04 mm rechts, 0.00 mm
 Streuwert 1.13, horizontal: 1.23, vertikal: 1.02

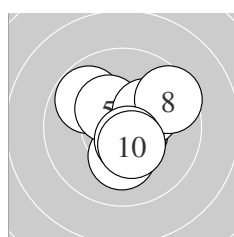
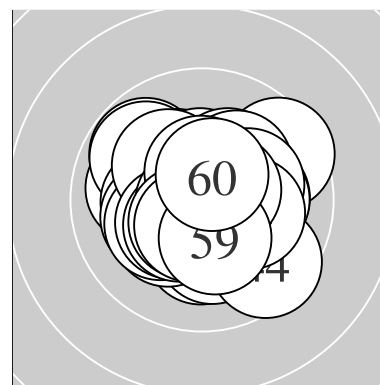

Serie 1:
 9.8 ↘ 10.2 * 10.6 * 10.6 * 10.3 *
 10.2 * 10.5 * 9.5 ↗ 10.6 * 10.4 *
 beste Teiler 82.8 (4.) 85.9 (3.) 92.7 (9.)
 Trefferlage 0.42 mm rechts, 0.01 mm hoch
 Streuwert 1.37, horizontal: 1.40, vertikal: 1.34

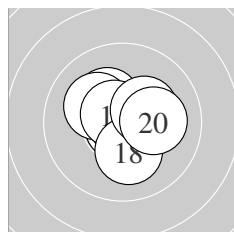

Serie 2:
 10.6 * 10.3 * 10.5 * 10.8 * 10.2 *
 10.9 * 10.6 * 10.2 * 10.3 * 10.1 →
 beste Teiler 6.7 (16.) 39.6 (14.) 77.7 (17.)
 Trefferlage 0.21 mm rechts, 0.22 mm hoch
 Streuwert 1.04, horizontal: 1.15, vertikal: 0.92

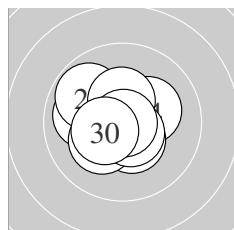

Serie 3:
 10.6 * 10.0 ← 9.8 ↘ 10.2 * 10.4 *
 10.2 * 10.6 * 10.4 * 10.9 * 10.4 *
 beste Teiler 9.2 (29.) 90.0 (27.) 92.9 (21.)
 Trefferlage 0.48 mm links, 0.13 mm hoch
 Streuwert 1.18, horizontal: 1.31, vertikal: 1.04

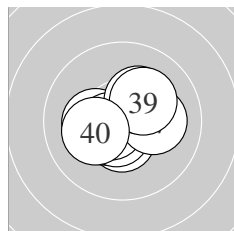

Serie 4:
 10.5 * 10.2 * 10.4 * 10.6 * 10.6 *
 10.6 * 10.1 → 10.3 * 10.2 * 10.2 *
 beste Teiler 86.0 (36.) 89.0 (34.) 90.4 (35.)
 Trefferlage 0.08 mm links, 0.04 mm tief
 Streuwert 1.14, horizontal: 1.34, vertikal: 0.88

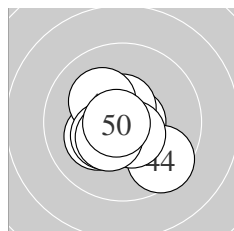

Serie 5:
 10.5 * 10.7 * 10.6 * 9.5 ↘ 10.2 *
 10.2 * 10.5 * 10.3 * 10.4 * 10.8 *
 beste Teiler 41.7 (50.) 63.0 (42.) 94.0 (43.)
 Trefferlage 0.25 mm links, 0.32 mm tief
 Streuwert 1.20, horizontal: 1.25, vertikal: 1.13

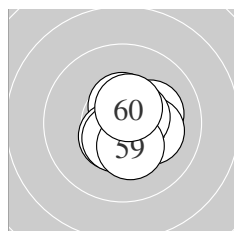

Serie 6:
 10.2 * 10.8 * 10.6 * 10.2 * 10.5 *
 10.5 * 10.5 * 10.6 * 10.3 * 10.5 *
 beste Teiler 41.0 (52.) 87.7 (53.) 99.4 (58.)
 Trefferlage 0.47 mm rechts, 0.04 mm tief
 Streuwert 0.90, horizontal: 0.86, vertikal: 0.94

Meyton Elektronik

ISSF AR Men – Wertung – **Männer**

StandNr: 146

Zott, Georg #47

StartNr: 93

30. November 2019 11:37

AUT

Unterschrift des Schützen

Meyton Elektronik

Ergebnis: **600.8** (571)
 Serien: 101.8 101.7 100.5 98.7 98.8 99.3
 Zähler: 33 25 2 0 0 0 0 0 0
 Innenzehner: 28
 weiteste: 557 (24), 536 (25), 479 (34)
 beste Teiler 15.6 (39.) 18.3 (57.) 56.5 (30.)
 Trefferlage 0.36 mm rechts, 0.34 mm hoch
 Streuwert 1.87, horizontal: 2.39, vertikal: 1.14

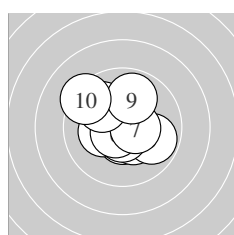
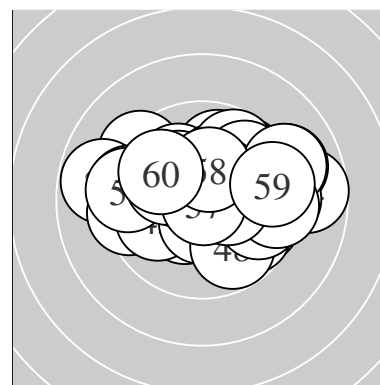

Serie 1:
 10.5 * 10.4 * 9.8 ↘ 10.3 * 10.6 *
 10.6 * 10.5 * 9.9 ↖ 9.9 ↑ 9.3 ↗
 beste Teiler 77.8 (6.) 85.0 (5.) 105.0 (1.)
 Trefferlage 0.19 mm links, 0.18 mm hoch
 Streuwert 1.60, horizontal: 1.71, vertikal: 1.49

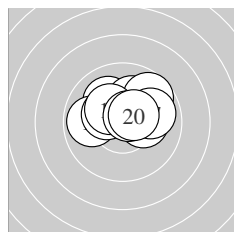

Serie 2:
 10.2 * 10.1 ↖ 9.9 ← 10.1 ↑ 10.3 *
 9.7 ↗ 9.9 → 10.3 * 10.7 * 10.5 *
 beste Teiler 74.9 (19.) 115.9 (20.) 156.9 (15.)
 Trefferlage 0.23 mm rechts, 0.96 mm hoch
 Streuwert 1.36, horizontal: 1.77, vertikal: 0.76

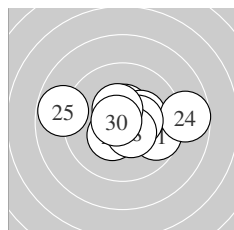

Serie 3:
 9.7 ↘ 10.5 * 10.3 * 8.7 → 8.8 ←
 10.4 * 10.4 * 10.5 * 10.5 * 10.7 *
 beste Teiler 56.5 (30.) 112.1 (22.) 117.7 (28.)
 Trefferlage 0.52 mm rechts, 0.14 mm hoch
 Streuwert 2.09, horizontal: 2.81, vertikal: 0.91

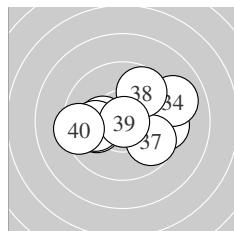

Serie 4:
 9.5 → 10.3 * 10.2 * 9.0 → 10.0 ←
 10.0 ← 9.7 ↘ 9.7 ↑ 10.9 * 9.4 ←
 beste Teiler 15.6 (39.) 175.0 (32.) 195.1 (33.)
 Trefferlage 0.40 mm rechts, 0.01 mm tief
 Streuwert 2.20, horizontal: 2.85, vertikal: 1.25

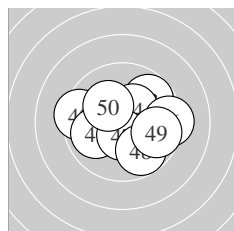

Serie 5:
 9.8 → 9.4 ← 9.8 ↗ 10.4 * 9.9 ←
 9.3 → 10.5 * 9.8 ↘ 9.7 → 10.2 *
 beste Teiler 115.1 (47.) 145.7 (44.) 191.2 (50.)
 Trefferlage 0.72 mm rechts, 0.03 mm hoch
 Streuwert 2.06, horizontal: 2.57, vertikal: 1.39

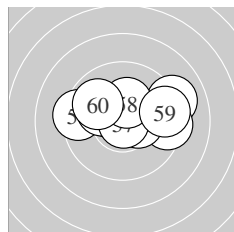

Serie 6:
 9.4 ← 10.4 * 10.1 ↖ 9.1 → 9.4 →
 10.4 * 10.9 * 10.3 * 9.4 → 9.9 ↗
 beste Teiler 18.3 (57.) 130.0 (52.) 138.9 (56.)
 Trefferlage 0.48 mm rechts, 0.72 mm hoch
 Streuwert 2.09, horizontal: 2.86, vertikal: 0.76

ISSF AR Men – Wertung – Männer

StandNr: 147

Kaiser, Elias #154

StartNr: 94

30. November 2019 11:42

LIE

Unterschrift des Schützen

Meyton Elektronik