

Ergebnis: **418.4** (396)  
 Serien: 104.0 104.5 105.1 104.8  
 Zähler: 36 4 0 0 0 0 0 0 0 0  
 Innenzehner: 33  
 weiteste: 275 (2), 273 (35), 259 (11)  
 beste Teiler 11.4 (19.) 27.4 (38.) 29.7 (29.)  
 Trefferlage 0.27 mm rechts, 0.32 mm hoch  
 Streuwert 0.97, horizontal: 0.96, vertikal: 0.98

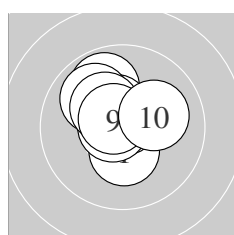

Serie 1:  
 10.4 \* 9.9 ↖ 10.8 \* 10.8 \* 10.7 \*  
 10.5 \* 9.9 ↖ 10.3 \* 10.6 \* 10.1 →  
 beste Teiler 48.2 (4.) 50.2 (3.) 62.0 (5.)  
 Trefferlage 0.38 mm links, 0.73 mm hoch  
 Streuwert 1.04, horizontal: 1.01, vertikal: 1.08

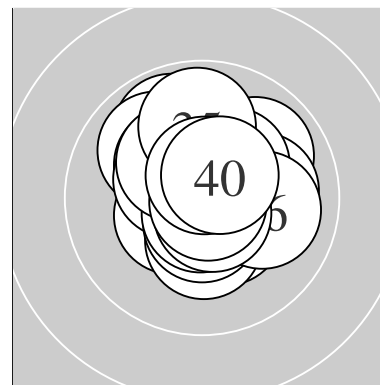
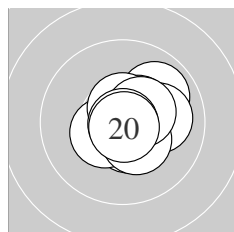

Serie 2:  
 9.9 ↗ 10.5 \* 10.5 \* 10.4 \* 10.1 →  
 10.6 \* 10.4 \* 10.4 \* 10.9 \* 10.8 \*  
 beste Teiler 11.4 (19.) 32.2 (20.) 90.0 (16.)  
 Trefferlage 0.66 mm rechts, 0.09 mm hoch  
 Streuwert 0.95, horizontal: 1.01, vertikal: 0.89

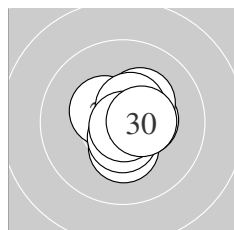

Serie 3:  
 10.7 \* 10.3 \* 10.4 \* 10.3 \* 10.6 \*  
 10.4 \* 10.5 \* 10.6 \* 10.8 \* 10.5 \*  
 beste Teiler 29.7 (29.) 65.7 (21.) 92.1 (25.)  
 Trefferlage 0.45 mm rechts, 0.02 mm hoch  
 Streuwert 0.81, horizontal: 0.74, vertikal: 0.87

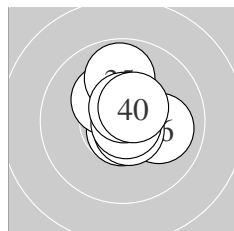

Serie 4:  
 10.7 \* 10.7 \* 10.3 \* 10.6 \* 9.9 ↑  
 10.0 → 10.7 \* 10.8 \* 10.6 \* 10.5 \*  
 beste Teiler 27.4 (38.) 60.2 (32.) 70.4 (37.)  
 Trefferlage 0.36 mm rechts, 0.43 mm hoch  
 Streuwert 0.97, horizontal: 0.86, vertikal: 1.07

Unterschrift des Schützen

Ergebnis: **412.2** (397)  
 Serien: 104.0 103.5 102.6 102.1  
 Zähler: 37 3 0 0 0 0 0 0 0 0  
 Innenzehner: 25  
 weiteste: 323 (32), 315 (31), 258 (24)  
 beste Teiler 13.0 (34.) 27.4 (20.) 70.1 (7.)  
 Trefferlage 0.21 mm rechts, 0.08 mm hoch  
 Streuwert 1.26, horizontal: 1.38, vertikal: 1.14

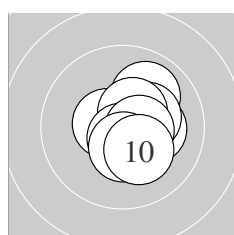
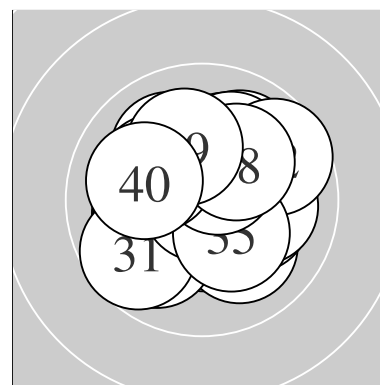

Serie 1:  
 10.6 \* 10.0 ↗ 10.2 \* 10.3 \* 10.6 \*  
 10.5 \* 10.7 \* 10.5 \* 10.4 \* 10.2 \*  
 beste Teiler 70.1 (7.) 79.2 (1.) 100.6 (5.)  
 Trefferlage 0.71 mm rechts, 0.05 mm tief  
 Streuwert 0.96, horizontal: 0.86, vertikal: 1.05

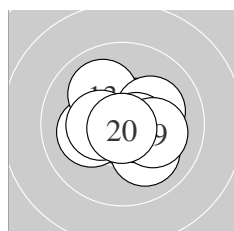

Serie 2:  
 10.6 \* 10.1 ← 10.0 ↘ 10.6 \* 10.4 \*  
 10.2 \* 10.1 ↘ 10.6 \* 10.1 → 10.8 \*  
 beste Teiler 27.4 (20.) 88.7 (18.) 96.8 (14.)  
 Trefferlage 0.26 mm rechts, 0.06 mm tief  
 Streuwert 1.21, horizontal: 1.39, vertikal: 1.00

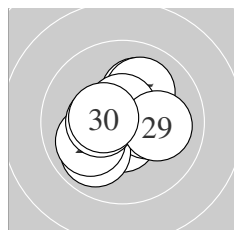

Serie 3:  
 10.6 \* 10.1 ↗ 10.3 \* 9.9 ↙ 10.1 ↗  
 10.6 \* 10.0 ↙ 10.4 \* 10.1 → 10.5 \*  
 beste Teiler 86.0 (26.) 96.0 (21.) 125.1 (30.)  
 Trefferlage 0.07 mm links, 0.04 mm hoch  
 Streuwert 1.38, horizontal: 1.50, vertikal: 1.25

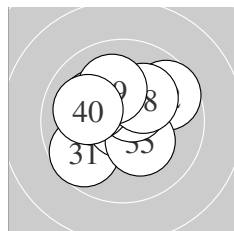

Serie 4:  
 9.7 ↙ 9.7 ↗ 10.6 \* 10.9 \* 10.3 \*  
 10.5 \* 10.1 ↘ 10.2 \* 10.1 ↗ 10.0 ↙  
 beste Teiler 13.0 (34.) 96.5 (33.) 109.5 (36.)  
 Trefferlage 0.05 mm links, 0.38 mm hoch  
 Streuwert 1.53, horizontal: 1.70, vertikal: 1.33

Unterschrift des Schützen

Meyton Elektronik

Ergebnis: **414.2** (394)  
 Serien: 104.0 102.4 104.0 103.8  
 Zähler: 34 6 0 0 0 0 0 0 0 0  
 Innenzehner: 30  
 weiteste: 397 (8), 316 (18), 309 (35)  
 beste Teiler 12.1 (26.) 26.4 (31.) 31.7 (24.)  
 Trefferlage 0.49 mm rechts, 0.39 mm hoch  
 Streuwert 1.18, horizontal: 1.31, vertikal: 1.03

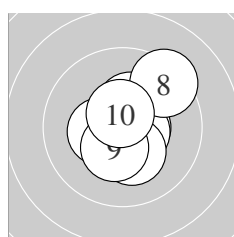
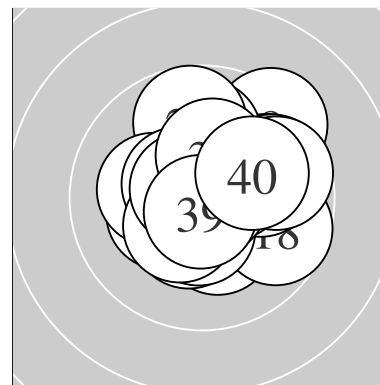

Serie 1:  
 10.6 \* 10.6 \* 10.4 \* 10.7 \* 10.6 \*  
 10.3 \* 10.4 \* 9.4 ↗ 10.4 \* 10.6 \*  
 beste Teiler 64.3 (4.) 77.9 (2.) 91.4 (10.)  
 Trefferlage 0.40 mm rechts, 0.24 mm hoch  
 Streuwert 1.21, horizontal: 1.09, vertikal: 1.32

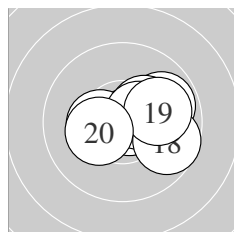

Serie 2:  
 10.6 \* 10.0 → 10.8 \* 9.8 → 10.4 \*  
 10.3 \* 10.5 \* 9.7 ↘ 10.0 → 10.3 \*  
 beste Teiler 45.1 (13.) 87.5 (11.) 115.1 (17.)  
 Trefferlage 1.07 mm rechts, 0.19 mm hoch  
 Streuwert 1.22, horizontal: 1.58, vertikal: 0.70

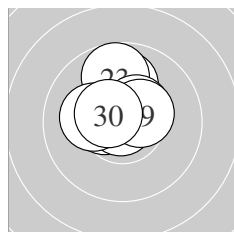

Serie 3:  
 10.0 ↑ 10.5 \* 9.7 ↑ 10.8 \* 10.5 \*  
 10.9 \* 10.5 \* 10.2 \* 10.4 \* 10.5 \*  
 beste Teiler 12.1 (26.) 31.7 (24.) 102.8 (22.)  
 Trefferlage 0.18 mm links, 0.90 mm hoch  
 Streuwert 0.99, horizontal: 0.97, vertikal: 1.01

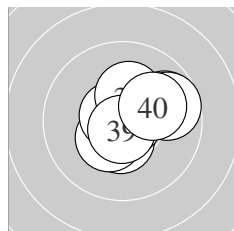

Serie 4:  
 10.8 \* 9.8 → 10.5 \* 10.4 \* 9.7 →  
 10.8 \* 10.7 \* 10.3 \* 10.7 \* 10.1 →  
 beste Teiler 26.4 (31.) 39.1 (36.) 55.3 (39.)  
 Trefferlage 0.66 mm rechts, 0.24 mm hoch  
 Streuwert 1.20, horizontal: 1.38, vertikal: 0.97

Unterschrift des Schützen

Ergebnis: **414.2** (397)  
 Serien: 103.4 103.4 103.4 104.0  
 Zähler: 37 3 0 0 0 0 0 0 0 0  
 Innenzehner: 30  
 weiteste: 317 (31), 276 (18), 259 (6)  
 beste Teiler 64.9 (2.) 66.0 (8.) 69.2 (28.)  
 Trefferlage 0.13 mm rechts, 0.39 mm tief  
 Streuwert 1.13, horizontal: 1.28, vertikal: 0.96

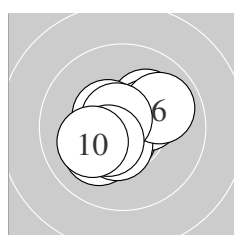
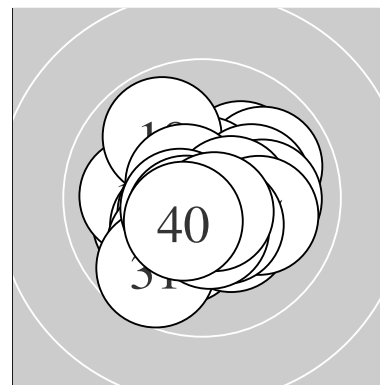

Serie 1:  
 10.1 ↙ 10.7 \* 10.1 ↗ 10.3 \* 10.5 \*  
 9.9 ↘ 10.5 \* 10.7 \* 10.5 \* 10.1 ←  
 beste Teiler 64.9 (2.) 66.0 (8.) 117.3 (5.)  
 Trefferlage 0.08 mm links, 0.03 mm tief  
 Streuwert 1.23, horizontal: 1.38, vertikal: 1.06

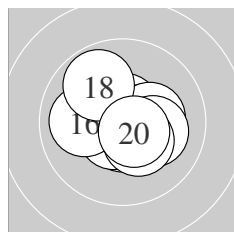

Serie 2:  
 10.6 \* 10.4 \* 10.6 \* 10.6 \* 10.3 \*  
 10.0 ← 10.2 \* 9.8 ↘ 10.3 \* 10.6 \*  
 beste Teiler 83.7 (11.) 89.0 (13.) 92.8 (14.)  
 Trefferlage 0.24 mm rechts, 0.03 mm tief  
 Streuwert 1.24, horizontal: 1.41, vertikal: 1.03

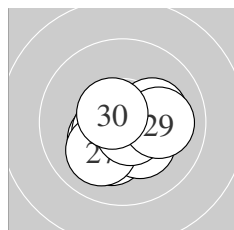

Serie 3:  
 10.5 \* 10.2 \* 10.3 \* 10.3 \* 10.5 \*  
 10.2 \* 10.1 ↙ 10.7 \* 10.0 → 10.6 \*  
 beste Teiler 69.2 (28.) 84.5 (30.) 111.3 (25.)  
 Trefferlage 0.18 mm rechts, 0.65 mm tief  
 Streuwert 1.11, horizontal: 1.33, vertikal: 0.84

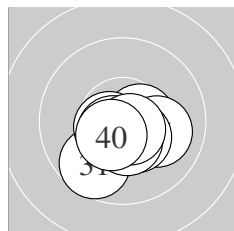

Serie 4:  
 9.7 ↙ 10.4 \* 10.5 \* 10.6 \* 10.1 →  
 10.6 \* 10.4 \* 10.5 \* 10.7 \* 10.5 \*  
 beste Teiler 69.4 (39.) 88.4 (36.) 92.6 (34.)  
 Trefferlage 0.21 mm rechts, 0.86 mm tief  
 Streuwert 0.98, horizontal: 1.18, vertikal: 0.72

Unterschrift des Schützen

Ergebnis: **419.2** (399)  
 Serien: 104.9 105.3 104.3 104.7  
 Zähler: 39 1 0 0 0 0 0 0 0 0  
 Innenzehner: 37  
 weiteste: 260 (28), 244 (29), 231 (39)  
 beste Teiler 25.0 (16.) 41.1 (2.) 42.6 (24.)  
 Trefferlage 0.25 mm links, 0.13 mm tief  
 Streuwert 0.91, horizontal: 1.09, vertikal: 0.69

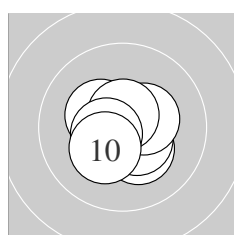
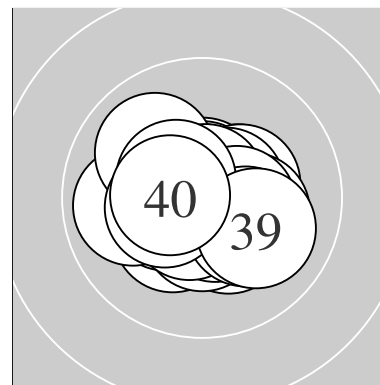

Serie 1:  
 10.6 \* 10.8 \* 10.6 \* 10.3 \* 10.5 \*  
 10.4 \* 10.3 \* 10.6 \* 10.5 \* 10.3 \*  
 beste Teiler 41.1 (2.) 76.0 (8.) 78.2 (1.)  
 Trefferlage 0.19 mm links, 0.18 mm tief  
 Streuwert 0.88, horizontal: 0.96, vertikal: 0.80

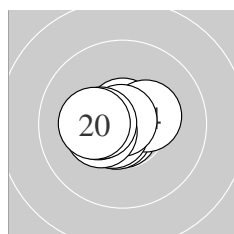

Serie 2:  
 10.8 \* 10.7 \* 10.7 \* 10.3 \* 10.6 \*  
 10.9 \* 10.4 \* 10.3 \* 10.4 \* 10.2 \*  
 beste Teiler 25.0 (16.) 49.0 (11.) 63.0 (12.)  
 Trefferlage 0.57 mm links, 0.05 mm tief  
 Streuwert 0.76, horizontal: 0.97, vertikal: 0.44

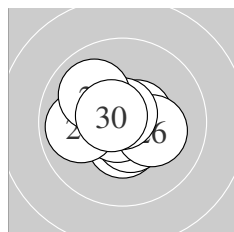

Serie 3:  
 10.6 \* 10.5 \* 10.5 \* 10.8 \* 10.5 \*  
 10.2 \* 10.7 \* 9.9 ← 10.0 ↘ 10.6 \*  
 beste Teiler 42.6 (24.) 53.4 (27.) 80.6 (30.)  
 Trefferlage 0.31 mm links, 0.04 mm hoch  
 Streuwert 1.09, horizontal: 1.27, vertikal: 0.87

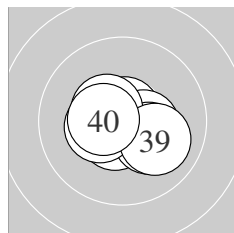

Serie 4:  
 10.7 \* 10.6 \* 10.8 \* 10.4 \* 10.6 \*  
 10.2 \* 10.4 \* 10.5 \* 10.0 ↘ 10.5 \*  
 beste Teiler 44.6 (33.) 53.3 (31.) 76.8 (32.)  
 Trefferlage 0.06 mm rechts, 0.34 mm tief  
 Streuwert 0.96, horizontal: 1.21, vertikal: 0.62

Unterschrift des Schützen

Meyton Elektronik

Ergebnis: **421.5** (400)  
 Serien: 106.8 103.9 105.5 105.3  
 Zähler: 40 0 0 0 0 0 0 0 0 0  
 Innenzehner: 36  
 weiteste: 232 (13), 215 (36), 208 (20)  
 beste Teiler 4.1 (10.) 10.8 (34.) 15.0 (8.)  
 Trefferlage 0.12 mm rechts, 0.11 mm hoch  
 Streuwert 0.84, horizontal: 0.91, vertikal: 0.76

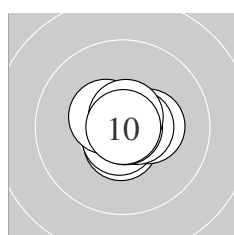
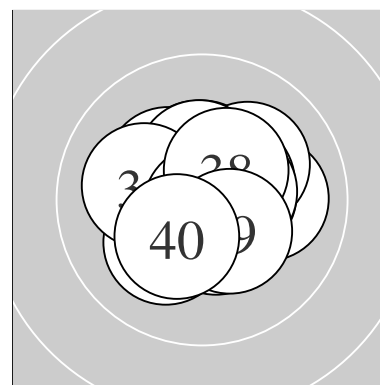

Serie 1:  
 10.6 \* 10.9 \* 10.6 \* 10.4 \* 10.7 \*  
 10.5 \* 10.6 \* 10.9 \* 10.7 \* 10.9 \*  
 beste Teiler 4.1 (10.) 15.0 (8.) 22.8 (2.)  
 Trefferlage 0.21 mm rechts, 0.02 mm tief  
 Streuwert 0.60, horizontal: 0.69, vertikal: 0.49

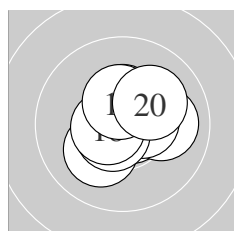

Serie 2:  
 10.7 \* 10.5 \* 10.0 → 10.5 \* 10.1 ↗  
 10.6 \* 10.4 \* 10.6 \* 10.4 \* 10.1 ↗  
 beste Teiler 51.4 (11.) 83.4 (16.) 90.0 (18.)  
 Trefferlage 0.31 mm rechts, 0.27 mm hoch  
 Streuwert 1.05, horizontal: 1.14, vertikal: 0.95

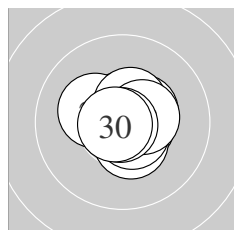

Serie 3:  
 10.6 \* 10.4 \* 10.6 \* 10.6 \* 10.4 \*  
 10.2 \* 10.5 \* 10.5 \* 10.9 \* 10.8 \*  
 beste Teiler 21.4 (29.) 48.0 (30.) 82.0 (23.)  
 Trefferlage 0.24 mm rechts, 0.11 mm hoch  
 Streuwert 0.78, horizontal: 0.85, vertikal: 0.70

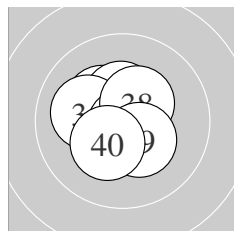

Serie 4:  
 10.3 \* 10.9 \* 10.4 \* 10.9 \* 10.8 \*  
 10.1 ← 10.8 \* 10.4 \* 10.4 \* 10.3 \*  
 beste Teiler 10.8 (34.) 15.2 (32.) 29.0 (37.)  
 Trefferlage 0.27 mm links, 0.10 mm hoch  
 Streuwert 0.92, horizontal: 0.93, vertikal: 0.91

Unterschrift des Schützen

Ergebnis: **417.2** (397)  
 Serien: 102.4 105.0 104.4 105.4  
 Zähler: 37 3 0 0 0 0 0 0 0 0  
 Innenzehner: 35  
 weiteste: 322 (17), 293 (6), 259 (2)  
 beste Teiler 20.6 (15.) 29.5 (21.) 48.3 (25.)  
 Trefferlage 0.11 mm rechts, 0.14 mm tief  
 Streuwert 1.05, horizontal: 1.25, vertikal: 0.80

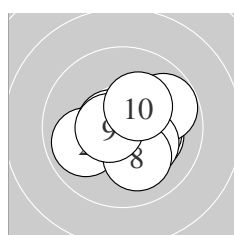
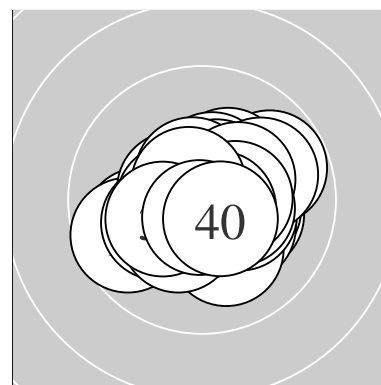

Serie 1:  
 10.4 \*                      9.9 ←                      10.2 \*                      10.3 \*                      10.6 \*  
 9.8 →                      10.2 \*                      10.1 ↓                      10.6 \*                      10.3 \*  
 beste Teiler 76.6 (5.) 86.1 (9.) 143.1 (1.)  
 Trefferlage 0.41 mm rechts, 0.25 mm tief  
 Streuwert 1.36, horizontal: 1.63, vertikal: 1.01

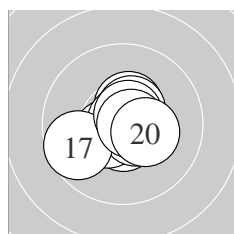

Serie 2:  
 10.5 \*                      10.5 \*                      10.6 \*                      10.5 \*                      10.9 \*  
 10.6 \*                      9.7 ←                      10.7 \*                      10.7 \*                      10.3 \*  
 beste Teiler 20.6 (15.) 56.0 (19.) 70.8 (18.)  
 Trefferlage 0.03 mm rechts, 0.09 mm tief  
 Streuwert 1.04, horizontal: 1.21, vertikal: 0.82

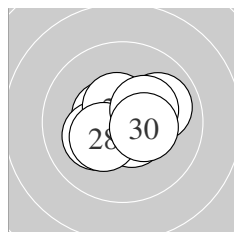

Serie 3:  
 10.8 \*                      10.0 →                      10.6 \*                      10.5 \*                      10.8 \*  
 10.2 \*                      10.5 \*                      10.3 \*                      10.3 \*                      10.4 \*  
 beste Teiler 29.5 (21.) 48.3 (25.) 92.9 (23.)  
 Trefferlage 0.17 mm rechts, 0.08 mm hoch  
 Streuwert 1.06, horizontal: 1.30, vertikal: 0.76

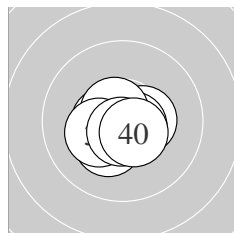

Serie 4:  
 10.3 \*                      10.7 \*                      10.4 \*                      10.7 \*                      10.7 \*  
 10.5 \*                      10.6 \*                      10.3 \*                      10.7 \*                      10.5 \*  
 beste Teiler 60.0 (35.) 63.7 (32.) 69.7 (39.)  
 Trefferlage 0.17 mm links, 0.33 mm tief  
 Streuwert 0.77, horizontal: 0.90, vertikal: 0.61

Unterschrift des Schützen

Meyton Elektronik

Ergebnis: **393.8** (376)  
 Serien: 98.0 98.9 98.5 98.4  
 Zähler: 19 18 3 0 0 0 0 0 0 0  
 Innenzehner: 13  
 weiteste: 592 (11), 514 (28), 512 (25)  
 beste Teiler 58.0 (38.) 69.1 (26.) 72.0 (19.)  
 Trefferlage 1.40 mm links, 0.94 mm hoch  
 Streuwert 1.87, horizontal: 2.07, vertikal: 1.65

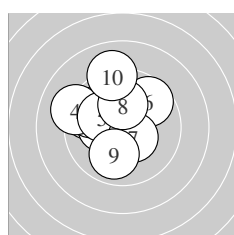
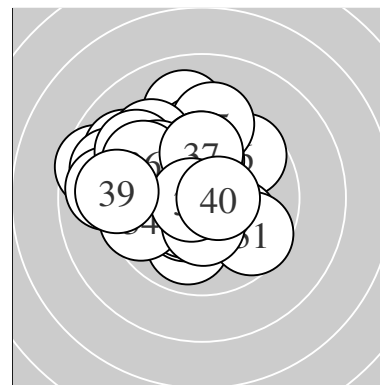

Serie 1:  
 9.6 ↘ 10.2 \* 9.7 ↘ 9.2 ↘ 10.1 ↘  
 9.7 ↗ 10.4 \* 10.1 ↑ 9.9 ↓ 9.1 ↑  
 beste Teiler 130.1 (7.) 179.0 (2.) 203.0 (8.)  
 Trefferlage 1.21 mm links, 1.06 mm hoch  
 Streuwert 1.93, horizontal: 1.96, vertikal: 1.90

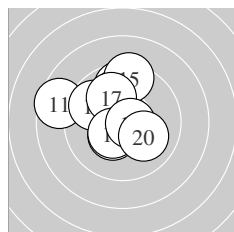

Serie 2:  
 8.6 ↘ 9.7 ↑ 10.4 \* 9.9 ↑ 9.3 ↑  
 9.8 ↘ 10.0 ↘ 10.4 \* 10.7 \* 10.1 ↘  
 beste Teiler 72.0 (19.) 131.7 (18.) 146.4 (13.)  
 Trefferlage 0.87 mm links, 1.15 mm hoch  
 Streuwert 1.99, horizontal: 2.07, vertikal: 1.91

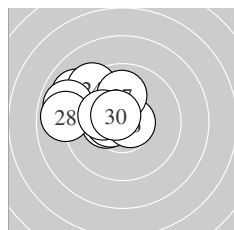

Serie 3:  
 10.4 \* 10.5 \* 9.0 ↘ 9.3 ↘ 8.9 ↘  
 10.7 \* 10.0 ↑ 8.9 ← 10.2 \* 10.6 \*  
 beste Teiler 69.1 (26.) 87.6 (30.) 110.0 (22.)  
 Trefferlage 2.12 mm links, 1.11 mm hoch  
 Streuwert 1.66, horizontal: 2.03, vertikal: 1.18

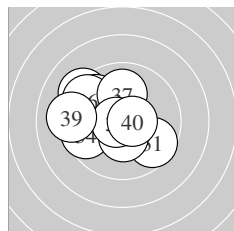

Serie 4:  
 9.6 ↘ 9.2 ↘ 9.7 ↘ 9.6 ← 10.4 \*  
 9.5 ↘ 10.0 ↑ 10.7 \* 9.1 ← 10.6 \*  
 beste Teiler 58.0 (38.) 87.0 (40.) 141.1 (35.)  
 Trefferlage 1.39 mm links, 0.45 mm hoch  
 Streuwert 2.02, horizontal: 2.33, vertikal: 1.65

Unterschrift des Schützen



Ergebnis: **414.7** (395)  
 Serien: 104.4 104.3 101.8 104.2  
 Zähler: 36 3 1 0 0 0 0 0 0  
 Innenzehner: 33  
 weiteste: 510 (24), 407 (16), 331 (25)  
 beste Teiler 28.1 (36.) 37.0 (35.) 46.6 (9.)  
 Trefferlage 0.19 mm rechts, 0.08 mm tief  
 Streuwert 1.24, horizontal: 1.41, vertikal: 1.05

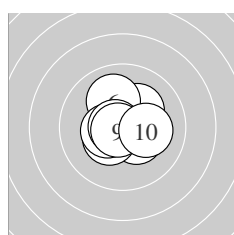
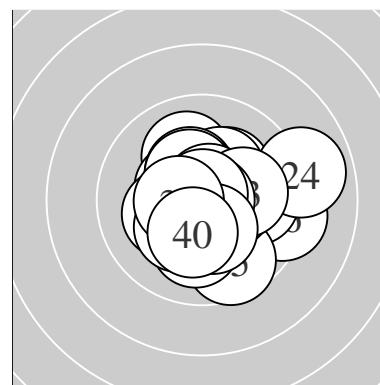

Serie 1:  
 10.4 \*                      10.7 \*                      10.4 \*                      10.6 \*                      10.2 \*  
 10.0 †                      10.4 \*                      10.7 \*                      10.8 \*                      10.2 \*  
 beste Teiler 46.6 (9.) 62.1 (8.) 74.0 (2.)  
 Trefferlage 0.06 mm links, 0.20 mm hoch  
 Streuwert 1.04, horizontal: 1.11, vertikal: 0.97

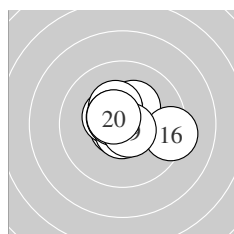

Serie 2:  
 10.7 \*                      10.4 \*                      10.3 \*                      10.7 \*                      10.4 \*  
 9.3 →                      10.6 \*                      10.6 \*                      10.7 \*                      10.6 \*  
 beste Teiler 56.3 (11.) 62.3 (14.) 72.9 (19.)  
 Trefferlage 0.09 mm rechts, 0.27 mm hoch  
 Streuwert 1.20, horizontal: 1.51, vertikal: 0.79

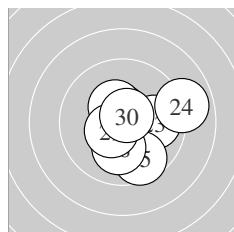

Serie 3:  
 10.4 \*                      10.7 \*                      9.9 →                      8.9 →                      9.6 †  
 10.6 \*                      10.4 \*                      10.1 ↓                      10.5 \*                      10.7 \*  
 beste Teiler 56.9 (22.) 64.6 (30.) 95.3 (26.)  
 Trefferlage 0.81 mm rechts, 0.27 mm tief  
 Streuwert 1.63, horizontal: 1.77, vertikal: 1.48

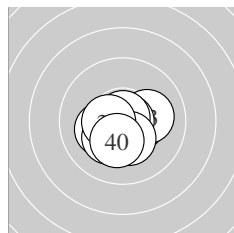

Serie 4:  
 10.4 \*                      10.6 \*                      10.1 →                      10.2 \*                      10.8 \*  
 10.8 \*                      10.2 \*                      10.3 \*                      10.5 \*                      10.3 \*  
 beste Teiler 28.1 (36.) 37.0 (35.) 84.2 (32.)  
 Trefferlage 0.05 mm links, 0.55 mm tief  
 Streuwert 0.97, horizontal: 1.16, vertikal: 0.73

Unterschrift des Schützen

Meyton Elektronik

Ergebnis: **416.7** (397)  
 Serien: 102.1 104.7 105.0 104.9  
 Zähler: 37 3 0 0 0 0 0 0 0 0  
 Innenzehner: 34  
 weiteste: 311 (1), 310 (6), 288 (38)  
 beste Teiler 28.7 (36.) 34.9 (33.) 41.2 (13.)  
 Trefferlage 0.44 mm links, 0.17 mm tief  
 Streuwert 1.03, horizontal: 1.13, vertikal: 0.92

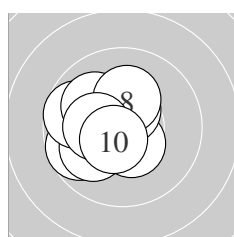
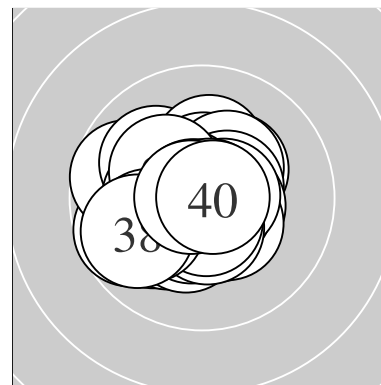

Serie 1:  
 9.7 ← 10.5 \* 10.5 \* 10.6 \* 10.0 ↙  
 9.7 ← 10.0 ↘ 10.2 \* 10.3 \* 10.6 \*  
 beste Teiler 94.1 (4.) 100.8 (10.) 116.4 (3.)  
 Trefferlage 1.14 mm links, 0.01 mm hoch  
 Streuwert 1.25, horizontal: 1.30, vertikal: 1.20

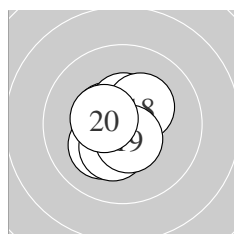

Serie 2:  
 10.2 \* 10.5 \* 10.8 \* 10.7 \* 10.3 \*  
 10.5 \* 10.5 \* 10.3 \* 10.5 \* 10.4 \*  
 beste Teiler 41.2 (13.) 53.0 (14.) 104.9 (19.)  
 Trefferlage 0.34 mm links, 0.12 mm tief  
 Streuwert 0.91, horizontal: 0.84, vertikal: 0.97

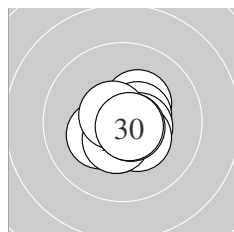

Serie 3:  
 10.3 \* 10.5 \* 10.3 \* 10.5 \* 10.5 \*  
 10.4 \* 10.5 \* 10.6 \* 10.7 \* 10.7 \*  
 beste Teiler 53.2 (30.) 64.6 (29.) 79.6 (28.)  
 Trefferlage 0.21 mm rechts, 0.29 mm tief  
 Streuwert 0.83, horizontal: 0.88, vertikal: 0.79

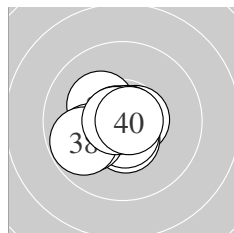

Serie 4:  
 10.6 \* 10.2 \* 10.8 \* 10.5 \* 10.6 \*  
 10.8 \* 10.0 ← 9.8 ← 10.8 \* 10.8 \*  
 beste Teiler 28.7 (36.) 34.9 (33.) 43.1 (40.)  
 Trefferlage 0.49 mm links, 0.30 mm tief  
 Streuwert 0.98, horizontal: 1.16, vertikal: 0.76

Unterschrift des Schützen

Meyton Elektronik

Ergebnis: **414.2** (396)  
 Serien: 102.5 103.6 103.9 104.2  
 Zähler: 36 4 0 0 0 0 0 0 0 0  
 Innenzehner: 29  
 weiteste: 380 (2), 359 (30), 269 (22)  
 beste Teiler 21.8 (26.) 49.2 (19.) 58.0 (14.)  
 Trefferlage 0.06 mm links, 0.15 mm hoch  
 Streuwert 1.23, horizontal: 1.18, vertikal: 1.27

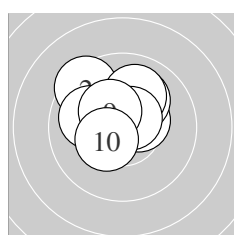
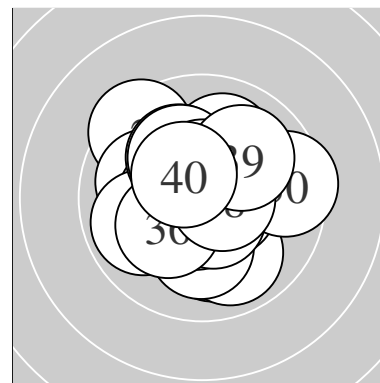

Serie 1:  
 10.5 \* 9.4 ↖ 10.6 \* 10.5 \* 10.1 ↗  
 10.0 ↗ 10.6 \* 10.0 ↖ 10.4 \* 10.4 \*  
 beste Teiler 85.0 (7.) 90.6 (3.) 109.5 (1.)  
 Trefferlage 0.48 mm links, 0.90 mm hoch  
 Streuwert 1.26, horizontal: 1.36, vertikal: 1.15

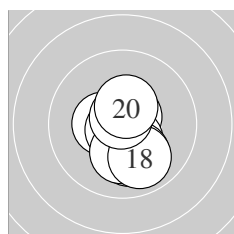

Serie 2:  
 10.1 ↓ 10.7 \* 10.4 \* 10.7 \* 10.4 \*  
 10.0 ↓ 10.2 \* 9.9 ↓ 10.8 \* 10.4 \*  
 beste Teiler 49.2 (19.) 58.0 (14.) 74.9 (12.)  
 Trefferlage 0.21 mm rechts, 0.77 mm tief  
 Streuwert 1.07, horizontal: 0.75, vertikal: 1.32

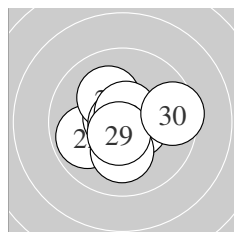

Serie 3:  
 10.7 \* 9.9 ↖ 10.7 \* 10.6 \* 10.2 \*  
 10.9 \* 10.1 ↓ 10.7 \* 10.6 \* 9.5 →  
 beste Teiler 21.8 (26.) 63.0 (23.) 66.6 (21.)  
 Trefferlage 0.06 mm rechts, 0.14 mm tief  
 Streuwert 1.32, horizontal: 1.54, vertikal: 1.05

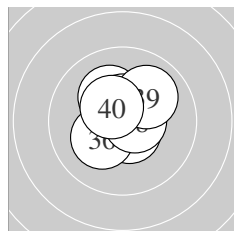

Serie 4:  
 10.6 \* 10.5 \* 10.6 \* 10.5 \* 10.2 \*  
 10.2 \* 10.5 \* 10.6 \* 10.0 ↗ 10.5 \*  
 beste Teiler 87.0 (38.) 89.8 (33.) 90.5 (31.)  
 Trefferlage 0.06 mm links, 0.62 mm hoch  
 Streuwert 0.96, horizontal: 0.94, vertikal: 0.97

Unterschrift des Schützen

Meyton Elektronik

Ergebnis: **419.0** (396)  
 Serien: 104.8 104.2 105.8 104.2  
 Zähler: 36 4 0 0 0 0 0 0 0 0  
 Innenzehner: 32  
 weiteste: 324 (17), 264 (32), 261 (2)  
 beste Teiler 5.0 (19.) 28.6 (29.) 43.5 (20.)  
 Trefferlage 0.02 mm rechts, 0.35 mm hoch  
 Streuwert 0.99, horizontal: 0.86, vertikal: 1.10

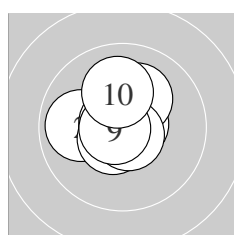
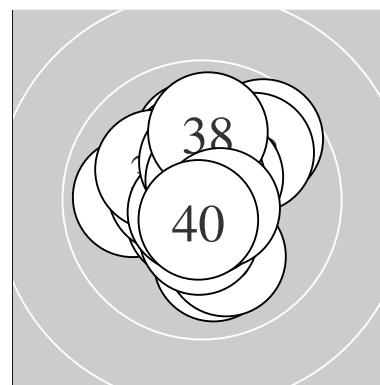

Serie 1:  
 10.4 \*                      9.9 ←                      10.7 \*                      10.7 \*                      10.6 \*  
 10.7 \*                      10.2 \*                      10.7 \*                      10.8 \*                      10.1 ↑  
 beste Teiler 49.8 (9.) 51.2 (4.) 56.8 (3.)  
 Trefferlage 0.26 mm links, 0.44 mm hoch  
 Streuwert 0.99, horizontal: 1.00, vertikal: 0.98

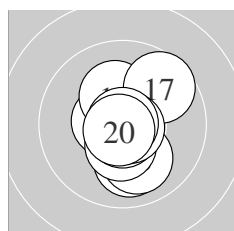

Serie 2:  
 10.0 ↓                      10.6 \*                      10.0 ↓                      10.4 \*                      10.8 \*  
 10.2 \*                      9.7 ↗                      10.8 \*                      10.9 \*                      10.8 \*  
 beste Teiler 5.0 (19.) 43.5 (20.) 44.4 (18.)  
 Trefferlage 0.22 mm rechts, 0.26 mm tief  
 Streuwert 1.22, horizontal: 0.89, vertikal: 1.48

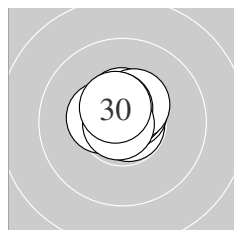

Serie 3:  
 10.6 \*                      10.8 \*                      10.4 \*                      10.5 \*                      10.6 \*  
 10.6 \*                      10.4 \*                      10.6 \*                      10.8 \*                      10.5 \*  
 beste Teiler 28.6 (29.) 43.9 (22.) 83.6 (25.)  
 Trefferlage 0.01 mm rechts, 0.60 mm hoch  
 Streuwert 0.55, horizontal: 0.62, vertikal: 0.48

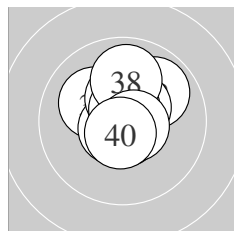

Serie 4:  
 10.1 ↖                      9.9 ↗                      10.7 \*                      10.5 \*                      10.4 \*  
 10.7 \*                      10.7 \*                      9.9 ↑                      10.7 \*                      10.6 \*  
 beste Teiler 62.1 (36.) 71.7 (33.) 74.3 (39.)  
 Trefferlage 0.13 mm rechts, 0.63 mm hoch  
 Streuwert 1.05, horizontal: 0.96, vertikal: 1.13

Unterschrift des Schützen

Meyton Elektronik

Ergebnis: **411.1** (393)  
 Serien: 101.1 104.2 103.9 101.9  
 Zähler: 33 7 0 0 0 0 0 0 0 0  
 Innenzehner: 27  
 weiteste: 329 (3), 296 (6), 292 (2)  
 beste Teiler 28.0 (21.) 59.0 (12.) 65.0 (19.)  
 Trefferlage 0.36 mm rechts, 0.05 mm tief  
 Streuwert 1.29, horizontal: 1.32, vertikal: 1.26

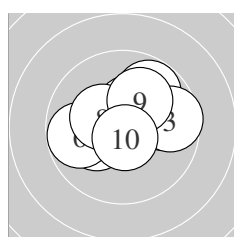
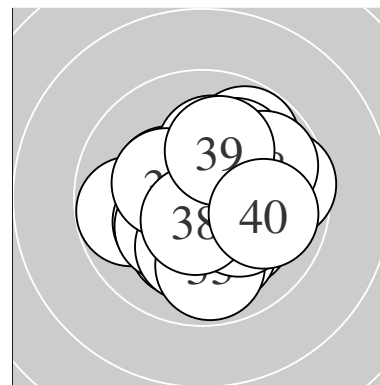

Serie 1:  
 9.8 →                      9.8 ↗                      9.6 →                      10.4 \*                      10.2 \*  
 9.8 ←                      10.4 \*                      10.3 \*                      10.1 ↗                      10.7 \*  
 beste Teiler 73.7 (10.) 137.5 (7.) 138.6 (4.)  
 Trefferlage 0.22 mm rechts, 0.59 mm hoch  
 Streuwert 1.62, horizontal: 2.03, vertikal: 1.05

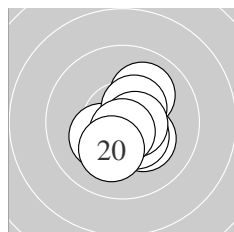

Serie 2:  
 10.6 \*                      10.7 \*                      10.0 ↗                      10.2 \*                      10.3 \*  
 10.4 \*                      10.5 \*                      10.6 \*                      10.7 \*                      10.2 \*  
 beste Teiler 59.0 (12.) 65.0 (19.) 79.7 (11.)  
 Trefferlage 0.39 mm rechts, 0.35 mm tief  
 Streuwert 1.00, horizontal: 0.92, vertikal: 1.07

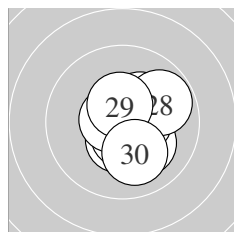

Serie 3:  
 10.8 \*                      10.1 ↘                      10.5 \*                      10.5 \*                      10.6 \*  
 10.3 \*                      10.7 \*                      9.8 ↗                      10.5 \*                      10.1 ↘  
 beste Teiler 28.0 (21.) 75.9 (27.) 89.2 (25.)  
 Trefferlage 0.56 mm rechts, 0.16 mm tief  
 Streuwert 1.11, horizontal: 1.02, vertikal: 1.19

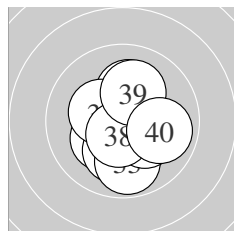

Serie 4:  
 10.2 \*                      10.1 ↓                      9.8 ↓                      10.2 \*                      10.2 \*  
 10.5 \*                      10.3 \*                      10.6 \*                      10.1 ↗                      9.9 →  
 beste Teiler 94.9 (38.) 115.5 (36.) 158.2 (37.)  
 Trefferlage 0.26 mm rechts, 0.31 mm tief  
 Streuwert 1.42, horizontal: 1.23, vertikal: 1.59

Unterschrift des Schützen

Meyton Elektronik

Ergebnis: **411.4** (391)  
 Serien: 103.6 104.8 100.3 102.7  
 Zähler: 33 5 2 0 0 0 0 0 0 0  
 Innenzehner: 29  
 weiteste: 630 (30), 553 (27), 380 (37)  
 beste Teiler 33.0 (14.) 47.4 (7.) 52.2 (35.)  
 Trefferlage 0.44 mm rechts, 0.07 mm tief  
 Streuwert 1.47, horizontal: 1.62, vertikal: 1.29

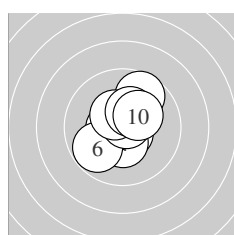
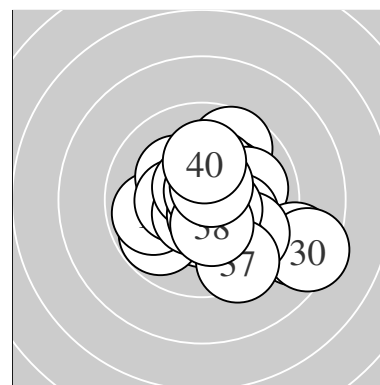

Serie 1:  
 9.7 ↗ 10.7 \* 10.7 \* 10.4 \* 10.5 \*  
 9.8 ↙ 10.8 \* 10.4 \* 10.3 \* 10.3 \*  
 beste Teiler 47.4 (7.) 58.1 (3.) 75.0 (2.)  
 Trefferlage 0.00 mm , 0.28 mm hoch  
 Streuwert 1.27, horizontal: 1.17, vertikal: 1.37

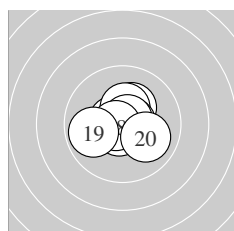

Serie 2:  
 10.6 \* 10.3 \* 10.4 \* 10.8 \* 10.7 \*  
 10.7 \* 10.7 \* 10.7 \* 9.9 ← 10.0 ↘  
 beste Teiler 33.0 (14.) 58.7 (17.) 61.3 (18.)  
 Trefferlage 0.01 mm links, 0.08 mm hoch  
 Streuwert 1.07, horizontal: 1.23, vertikal: 0.88

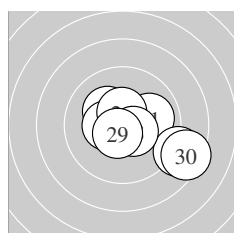

Serie 3:  
 10.0 → 10.6 \* 10.4 \* 10.2 \* 10.4 \*  
 10.5 \* 8.7 ↘ 10.5 \* 10.6 \* 8.4 ↘  
 beste Teiler 84.1 (22.) 87.1 (29.) 111.1 (28.)  
 Trefferlage 0.95 mm rechts, 0.20 mm tief  
 Streuwert 2.08, horizontal: 2.59, vertikal: 1.40

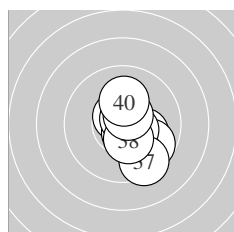

Serie 4:  
 10.1 ↘ 10.6 \* 9.7 ↘ 10.6 \* 10.7 \*  
 10.5 \* 9.4 ↘ 10.4 \* 10.6 \* 10.1 ↑  
 beste Teiler 52.2 (35.) 82.3 (32.) 86.4 (34.)  
 Trefferlage 0.85 mm rechts, 0.44 mm tief  
 Streuwert 1.27, horizontal: 0.95, vertikal: 1.52

Unterschrift des Schützen

Ergebnis: **419.0** (399)  
 Serien: 103.8 105.5 105.2 104.5  
 Zähler: 39 1 0 0 0 0 0 0 0 0  
 Innenzehner: 36  
 weiteste: 293 (13), 243 (3), 217 (39)  
 beste Teiler 7.2 (26.) 13.0 (15.) 35.7 (29.)  
 Trefferlage 0.21 mm rechts, 0.26 mm hoch  
 Streuwert 0.94, horizontal: 0.97, vertikal: 0.89

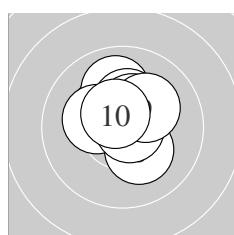
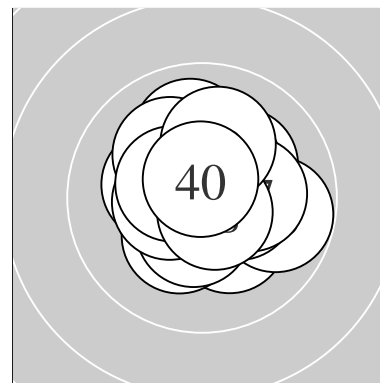

Serie 1:  
 10.7 \*                    10.3 \*                    10.0 ↑                    10.3 \*                    10.4 \*  
 10.2 \*                    10.3 \*                    10.8 \*                    10.2 \*                    10.6 \*  
 beste Teiler 46.3 (8.) 67.7 (1.) 98.8 (10.)  
 Trefferlage 0.07 mm rechts, 0.69 mm hoch  
 Streuwert 1.04, horizontal: 1.02, vertikal: 1.07

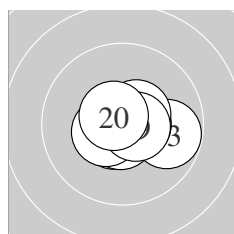

Serie 2:  
 10.6 \*                    10.7 \*                    9.8 →                    10.7 \*                    10.9 \*  
 10.5 \*                    10.6 \*                    10.5 \*                    10.6 \*                    10.6 \*  
 beste Teiler 13.0 (15.) 51.6 (14.) 71.1 (12.)  
 Trefferlage 0.28 mm rechts, 0.10 mm tief  
 Streuwert 0.88, horizontal: 1.14, vertikal: 0.51

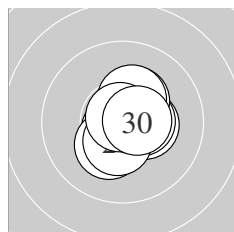

Serie 3:  
 10.7 \*                    10.4 \*                    10.5 \*                    10.3 \*                    10.3 \*  
 10.9 \*                    10.3 \*                    10.4 \*                    10.8 \*                    10.6 \*  
 beste Teiler 7.2 (26.) 35.7 (29.) 65.9 (21.)  
 Trefferlage 0.32 mm rechts, 0.00 mm  
 Streuwert 0.86, horizontal: 0.77, vertikal: 0.94

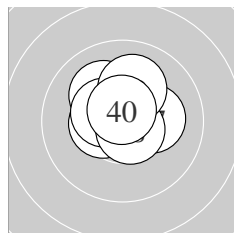

Serie 4:  
 10.4 \*                    10.1 ↘                    10.5 \*                    10.5 \*                    10.7 \*  
 10.6 \*                    10.2 \*                    10.7 \*                    10.1 ↑                    10.7 \*  
 beste Teiler 67.3 (35.) 73.2 (40.) 74.3 (38.)  
 Trefferlage 0.18 mm rechts, 0.48 mm hoch  
 Streuwert 0.96, horizontal: 1.08, vertikal: 0.83

Unterschrift des Schützen

Meyton Elektronik

Ergebnis: **417.1** (398)  
 Serien: 104.2 103.9 103.1 105.9  
 Zähler: 38 2 0 0 0 0 0 0 0 0  
 Innenzehner: 35  
 weiteste: 327 (21), 321 (28), 245 (15)  
 beste Teiler 24.5 (33.) 45.1 (3.) 51.6 (26.)  
 Trefferlage 0.27 mm links, 0.01 mm tief  
 Streuwert 1.05, horizontal: 1.07, vertikal: 1.03

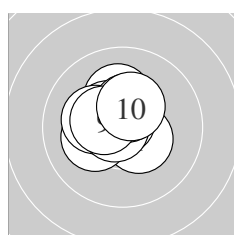
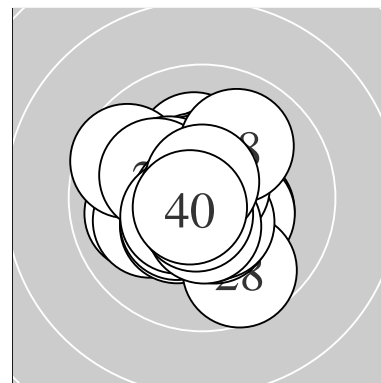

Serie 1:  
 10.4 \*                      10.2 \*                      10.8 \*                      10.2 \*                      10.5 \*  
 10.2 \*                      10.7 \*                      10.4 \*                      10.4 \*                      10.4 \*  
 beste Teiler 45.1 (3.) 52.0 (7.) 124.9 (5.)  
 Trefferlage 0.48 mm links, 0.52 mm hoch  
 Streuwert 0.91, horizontal: 0.96, vertikal: 0.86

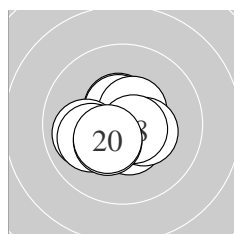

Serie 2:  
 10.5 \*                      10.5 \*                      10.5 \*                      10.5 \*                      10.0 ←  
 10.4 \*                      10.1 ←                      10.6 \*                      10.4 \*                      10.4 \*  
 beste Teiler 77.3 (18.) 103.5 (13.) 110.8 (14.)  
 Trefferlage 0.37 mm links, 0.25 mm tief  
 Streuwert 1.07, horizontal: 1.23, vertikal: 0.90

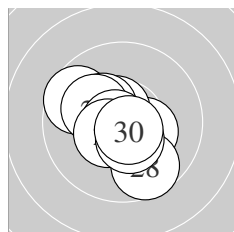

Serie 3:  
 9.6 ↖                      10.3 \*                      10.6 \*                      10.3 \*                      10.2 \*  
 10.7 \*                      10.5 \*                      9.7 ↘                      10.5 \*                      10.7 \*  
 beste Teiler 51.6 (26.) 65.6 (30.) 90.4 (23.)  
 Trefferlage 0.41 mm links, 0.18 mm tief  
 Streuwert 1.34, horizontal: 1.40, vertikal: 1.28

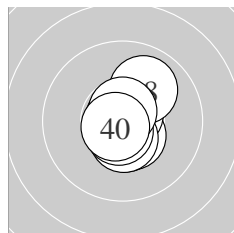

Serie 4:  
 10.5 \*                      10.5 \*                      10.9 \*                      10.7 \*                      10.7 \*  
 10.5 \*                      10.7 \*                      10.0 ↗                      10.7 \*                      10.7 \*  
 beste Teiler 24.5 (33.) 60.6 (40.) 61.5 (35.)  
 Trefferlage 0.17 mm rechts, 0.15 mm tief  
 Streuwert 0.79, horizontal: 0.52, vertikal: 0.99

Unterschrift des Schützen



Ergebnis: **416.6** (397)  
 Serien: 105.2 102.8 105.4 103.2  
 Zähler: 37 3 0 0 0 0 0 0 0 0  
 Innenzehner: 36  
 weiteste: 322 (16), 274 (18), 270 (31)  
 beste Teiler 37.5 (6.) 41.0 (21.) 51.6 (1.)  
 Trefferlage 0.00 mm , 0.17 mm tief  
 Streuwert 1.06, horizontal: 0.92, vertikal: 1.19

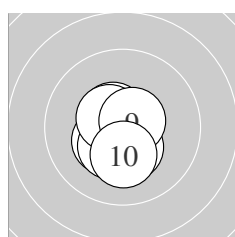
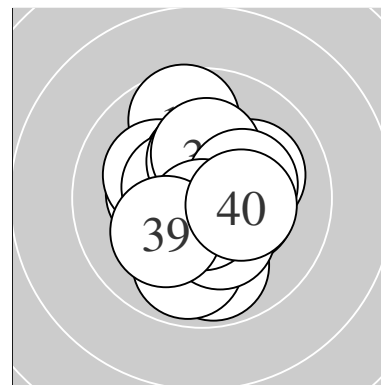

Serie 1:  
 10.7 \*                      10.6 \*                      10.4 \*                      10.4 \*                      10.4 \*  
 10.8 \*                      10.6 \*                      10.5 \*                      10.6 \*                      10.2 \*  
 beste Teiler 37.5 (6.) 51.6 (1.) 77.9 (9.)  
 Trefferlage 0.35 mm links, 0.31 mm tief  
 Streuwert 0.80, horizontal: 0.61, vertikal: 0.95

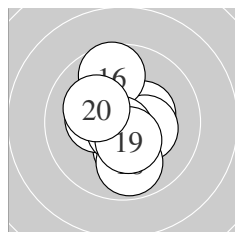

Serie 2:  
 10.7 \*                      10.4 \*                      10.3 \*                      10.2 \*                      10.3 \*  
 9.7 ↑                      10.7 \*                      9.9 ↓                      10.4 \*                      10.2 \*  
 beste Teiler 53.4 (17.) 61.2 (11.) 127.1 (19.)  
 Trefferlage 0.01 mm links, 0.23 mm tief  
 Streuwert 1.37, horizontal: 1.10, vertikal: 1.60

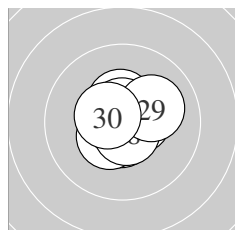

Serie 3:  
 10.8 \*                      10.4 \*                      10.7 \*                      10.5 \*                      10.6 \*  
 10.4 \*                      10.7 \*                      10.7 \*                      10.1 →                      10.5 \*  
 beste Teiler 41.0 (21.) 65.6 (23.) 71.8 (28.)  
 Trefferlage 0.05 mm rechts, 0.17 mm hoch  
 Streuwert 0.82, horizontal: 0.87, vertikal: 0.78

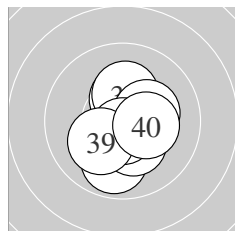

Serie 4:  
 9.9 ↓                      10.4 \*                      10.6 \*                      10.3 \*                      10.3 \*  
 10.2 \*                      10.3 \*                      10.7 \*                      10.2 \*                      10.3 \*  
 beste Teiler 68.0 (38.) 99.4 (33.) 148.0 (32.)  
 Trefferlage 0.33 mm rechts, 0.31 mm tief  
 Streuwert 1.22, horizontal: 1.02, vertikal: 1.39

Unterschrift des Schützen

Meyton Elektronik

Ergebnis: **416.6** (397)  
 Serien: 102.4 105.2 105.0 104.0  
 Zähler: 37 3 0 0 0 0 0 0 0 0  
 Innenzehner: 33  
 weiteste: 271 (8), 264 (5), 256 (3)  
 beste Teiler 17.0 (18.) 33.2 (26.) 51.6 (23.)  
 Trefferlage 0.03 mm rechts, 0.54 mm hoch  
 Streuwert 1.00, horizontal: 0.94, vertikal: 1.05

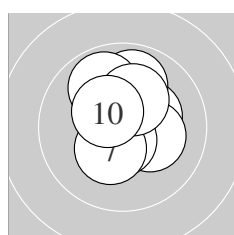
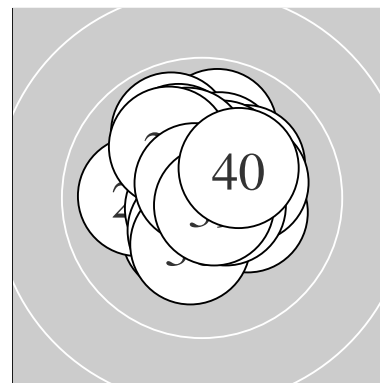

Serie 1:  
 10.3 \*                      10.7 \*                      9.9 ↗                      10.2 \*                      9.9 ↑  
 10.6 \*                      10.3 \*                      9.9 ↗                      10.2 \*                      10.4 \*  
 beste Teiler 63.0 (2.) 81.7 (6.) 135.7 (10.)  
 Trefferlage 0.06 mm rechts, 0.75 mm hoch  
 Streuwert 1.29, horizontal: 1.03, vertikal: 1.50

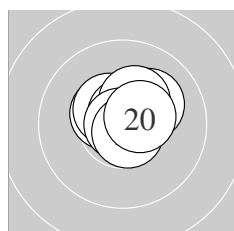

Serie 2:  
 10.5 \*                      10.5 \*                      10.7 \*                      10.7 \*                      10.3 \*  
 10.1 ↗                      10.3 \*                      10.9 \*                      10.7 \*                      10.5 \*  
 beste Teiler 17.0 (18.) 58.5 (19.) 61.2 (14.)  
 Trefferlage 0.31 mm rechts, 0.65 mm hoch  
 Streuwert 0.73, horizontal: 0.84, vertikal: 0.60

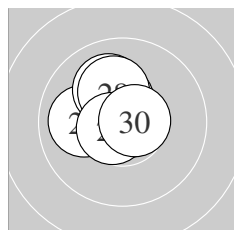

Serie 3:  
 10.7 \*                      10.7 \*                      10.7 \*                      10.0 ←                      10.4 \*  
 10.8 \*                      10.1 ↘                      10.2 \*                      10.7 \*                      10.7 \*  
 beste Teiler 33.2 (26.) 51.6 (23.) 52.0 (21.)  
 Trefferlage 0.44 mm links, 0.52 mm hoch  
 Streuwert 0.87, horizontal: 0.87, vertikal: 0.88

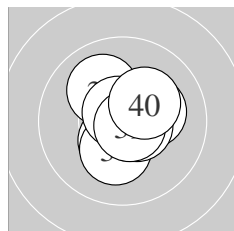

Serie 4:  
 10.5 \*                      10.4 \*                      10.2 \*                      10.5 \*                      10.0 ↘  
 10.2 \*                      10.7 \*                      10.6 \*                      10.7 \*                      10.2 \*  
 beste Teiler 53.0 (39.) 61.7 (37.) 93.3 (38.)  
 Trefferlage 0.21 mm rechts, 0.26 mm hoch  
 Streuwert 1.05, horizontal: 0.95, vertikal: 1.13

Unterschrift des Schützen

Meyton Elektronik

Ergebnis: **414.2** (396)  
 Serien: 104.2 103.5 102.8 103.7  
 Zähler: 36 4 0 0 0 0 0 0 0 0  
 Innenzehner: 31  
 weiteste: 303 (28), 284 (20), 269 (39)  
 beste Teiler 26.1 (38.) 29.6 (9.) 36.0 (16.)  
 Trefferlage 0.31 mm rechts, 0.24 mm hoch  
 Streuwert 1.13, horizontal: 1.37, vertikal: 0.83

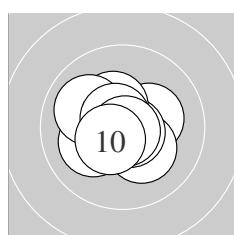
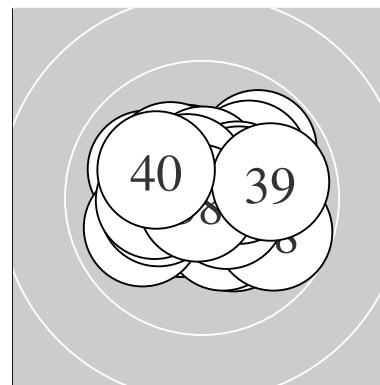

Serie 1:  
 10.6 \* 10.2 \* 10.2 \* 10.1 ↙ 10.7 \*  
 10.4 \* 10.0 ↘ 10.7 \* 10.8 \* 10.5 \*  
 beste Teiler 29.6 (9.) 56.8 (5.) 72.3 (8.)  
 Trefferlage 0.30 mm links, 0.05 mm tief  
 Streuwert 1.07, horizontal: 1.21, vertikal: 0.89

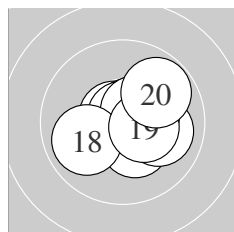

Serie 2:  
 10.3 \* 10.0 → 10.7 \* 10.4 \* 10.7 \*  
 10.8 \* 10.5 \* 9.9 ↙ 10.4 \* 9.8 ↗  
 beste Teiler 36.0 (16.) 65.4 (13.) 68.6 (15.)  
 Trefferlage 0.63 mm rechts, 0.09 mm hoch  
 Streuwert 1.17, horizontal: 1.35, vertikal: 0.95

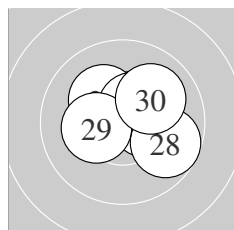

Serie 3:  
 10.5 \* 10.2 \* 10.4 \* 10.4 \* 10.4 \*  
 10.5 \* 10.4 \* 9.7 ↘ 10.3 \* 10.0 ↗  
 beste Teiler 114.6 (26.) 116.8 (21.) 134.1 (24.)  
 Trefferlage 0.81 mm rechts, 0.47 mm hoch  
 Streuwert 1.12, horizontal: 1.33, vertikal: 0.86

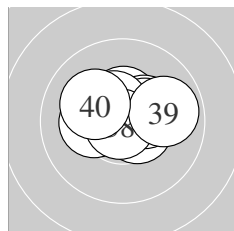

Serie 4:  
 10.5 \* 10.5 \* 10.2 \* 10.5 \* 10.3 \*  
 10.4 \* 10.5 \* 10.8 \* 9.9 → 10.1 ↘  
 beste Teiler 26.1 (38.) 105.0 (34.) 111.1 (37.)  
 Trefferlage 0.09 mm rechts, 0.47 mm hoch  
 Streuwert 1.12, horizontal: 1.47, vertikal: 0.57

Unterschrift des Schützen

Meyton Elektronik

Ergebnis: **412.2** (397)  
 Serien: 102.2 102.2 103.8 104.0  
 Zähler: 37 3 0 0 0 0 0 0 0 0  
 Innenzehner: 28  
 weiteste: 328 (40), 299 (15), 264 (4)  
 beste Teiler 30.8 (34.) 72.2 (39.) 75.6 (13.)  
 Trefferlage 0.10 mm links, 0.05 mm tief  
 Streuwert 1.26, horizontal: 1.29, vertikal: 1.23

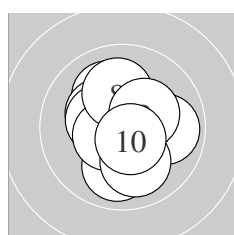
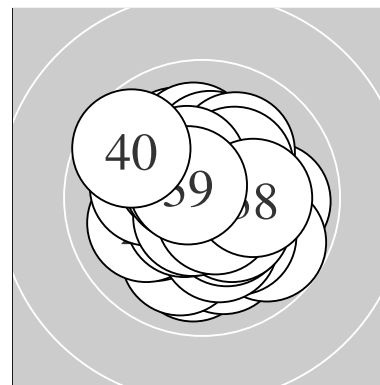

Serie 1:  
 10.1 ↖ 10.3 \* 10.4 \* 9.9 → 10.0 ↓  
 10.5 \* 10.0 ↓ 10.1 ↑ 10.3 \* 10.6 \*  
 beste Teiler 90.9 (10.) 106.0 (6.) 145.7 (3.)  
 Trefferlage 0.00 mm , 0.02 mm hoch  
 Streuwert 1.44, horizontal: 1.32, vertikal: 1.55

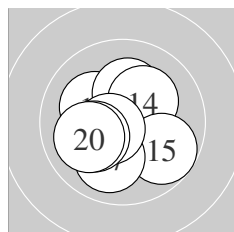

Serie 2:  
 10.2 \* 10.2 \* 10.7 \* 10.2 \* 9.8 ↘  
 10.4 \* 10.0 ↓ 10.6 \* 10.1 ← 10.0 ←  
 beste Teiler 75.6 (13.) 92.5 (18.) 144.1 (16.)  
 Trefferlage 0.40 mm links, 0.33 mm tief  
 Streuwert 1.41, horizontal: 1.50, vertikal: 1.31

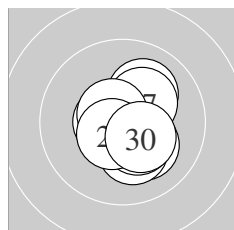

Serie 3:  
 10.6 \* 10.2 \* 10.2 \* 10.1 ↗ 10.5 \*  
 10.4 \* 10.3 \* 10.6 \* 10.5 \* 10.4 \*  
 beste Teiler 82.0 (28.) 91.0 (21.) 101.3 (29.)  
 Trefferlage 0.52 mm rechts, 0.32 mm tief  
 Streuwert 1.04, horizontal: 0.90, vertikal: 1.16

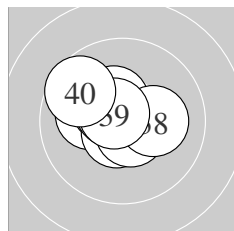

Serie 4:  
 10.1 ← 10.4 \* 10.6 \* 10.8 \* 10.6 \*  
 10.6 \* 10.4 \* 10.2 \* 10.7 \* 9.6 ↘  
 beste Teiler 30.8 (34.) 72.2 (39.) 80.9 (33.)  
 Trefferlage 0.51 mm links, 0.42 mm hoch  
 Streuwert 1.08, horizontal: 1.29, vertikal: 0.81

Unterschrift des Schützen

Ergebnis: **416.1** (396)  
 Serien: 103.2 104.3 104.7 103.9  
 Zähler: 36 4 0 0 0 0 0 0 0 0  
 Innenzehner: 33  
 weiteste: 289 (39), 271 (10), 266 (6)  
 beste Teiler 58.0 (21.) 59.5 (13.) 59.5 (31.)  
 Trefferlage 0.00 mm , 0.05 mm tief  
 Streuwert 1.09, horizontal: 1.24, vertikal: 0.91

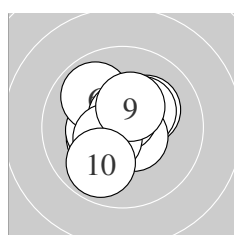
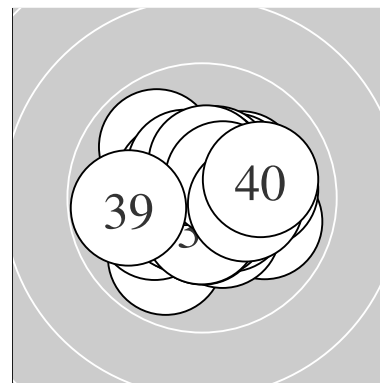

Serie 1:  
 10.2 \*                      10.3 \*                      10.3 \*                      10.6 \*                      10.4 \*  
 9.9 ↘                      10.7 \*                      10.5 \*                      10.4 \*                      9.9 ↙  
 beste Teiler 67.0 (7.) 93.5 (4.) 121.6 (8.)  
 Trefferlage 0.30 mm links, 0.16 mm hoch  
 Streuwert 1.27, horizontal: 1.24, vertikal: 1.29

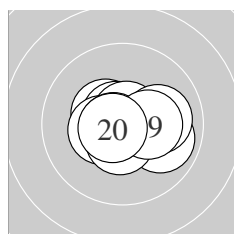

Serie 2:  
 10.4 \*                      10.7 \*                      10.7 \*                      9.9 ↗                      10.4 \*  
 10.5 \*                      10.7 \*                      10.0 →                      10.3 \*                      10.7 \*  
 beste Teiler 59.5 (13.) 62.2 (17.) 67.0 (12.)  
 Trefferlage 0.23 mm rechts, 0.07 mm tief  
 Streuwert 1.07, horizontal: 1.39, vertikal: 0.60

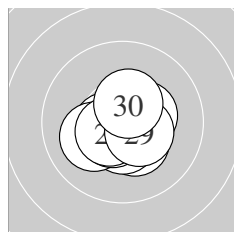

Serie 3:  
 10.7 \*                      10.4 \*                      10.5 \*                      10.5 \*                      10.1 ↖  
 10.6 \*                      10.5 \*                      10.4 \*                      10.5 \*                      10.5 \*  
 beste Teiler 58.0 (21.) 95.5 (26.) 103.4 (24.)  
 Trefferlage 0.11 mm links, 0.43 mm tief  
 Streuwert 0.89, horizontal: 1.01, vertikal: 0.75

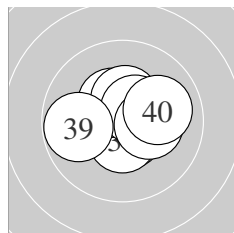

Serie 4:  
 10.7 \*                      10.6 \*                      10.7 \*                      10.5 \*                      10.4 \*  
 10.4 \*                      10.5 \*                      10.3 \*                      9.8 ←                      10.0 →  
 beste Teiler 59.5 (31.) 69.6 (33.) 92.6 (32.)  
 Trefferlage 0.14 mm rechts, 0.14 mm hoch  
 Streuwert 1.17, horizontal: 1.40, vertikal: 0.88

Unterschrift des Schützen

Meyton Elektronik

Ergebnis: **413.8** (394)  
 Serien: 102.5 103.4 103.5 104.4  
 Zähler: 34 6 0 0 0 0 0 0 0 0  
 Innenzehner: 29  
 weiteste: 354 (5), 283 (24), 279 (15)  
 beste Teiler 40.0 (17.) 47.1 (33.) 52.3 (21.)  
 Trefferlage 0.19 mm rechts, 0.19 mm tief  
 Streuwert 1.20, horizontal: 1.25, vertikal: 1.14

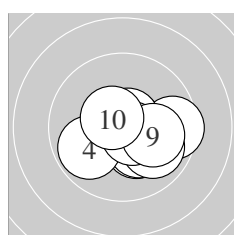
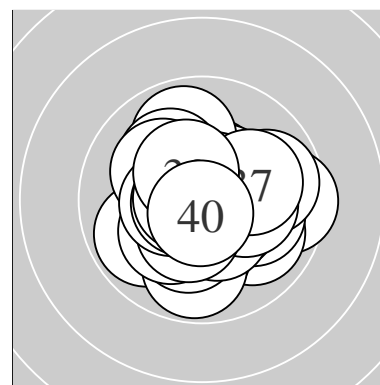

Serie 1:  
 10.3 \*                      10.2 \*                      10.7 \*                      9.9 ↙                      9.5 →  
    9.9 ↘                      10.7 \*                      10.6 \*                      10.1 →                      10.6 \*  
 beste Teiler 61.8 (3.) 63.8 (7.) 83.7 (8.)  
 Trefferlage 0.84 mm rechts, 0.50 mm tief  
 Streuwert 1.30, horizontal: 1.63, vertikal: 0.85

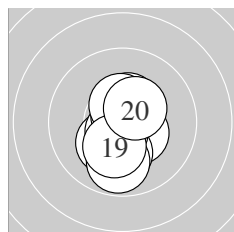

Serie 2:  
 10.4 \*                      10.1 ↓                      10.4 \*                      10.2 \*                      9.8 ↓  
    10.6 \*                      10.8 \*                      10.5 \*                      10.2 \*                      10.4 \*  
 beste Teiler 40.0 (17.) 78.2 (16.) 120.8 (18.)  
 Trefferlage 0.03 mm links, 0.57 mm tief  
 Streuwert 1.14, horizontal: 0.65, vertikal: 1.47

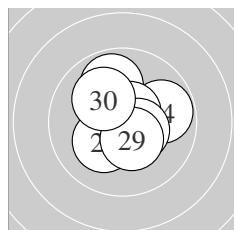

Serie 3:  
 10.7 \*                      10.7 \*                      10.6 \*                      9.8 →                      9.9 ↑  
    10.6 \*                      10.5 \*                      10.2 \*                      10.4 \*                      10.1 ↘  
 beste Teiler 52.3 (21.) 75.2 (22.) 80.6 (26.)  
 Trefferlage 0.13 mm rechts, 0.19 mm hoch  
 Streuwert 1.26, horizontal: 1.24, vertikal: 1.27

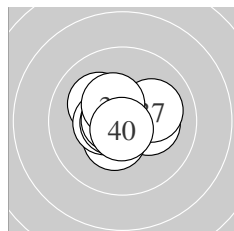

Serie 4:  
 10.2 \*                      10.1 ↖                      10.8 \*                      10.4 \*                      10.4 \*  
    10.6 \*                      10.1 →                      10.7 \*                      10.4 \*                      10.7 \*  
 beste Teiler 47.1 (33.) 57.4 (40.) 69.2 (38.)  
 Trefferlage 0.14 mm links, 0.10 mm hoch  
 Streuwert 1.03, horizontal: 1.24, vertikal: 0.76

Unterschrift des Schützen

Meyton Elektronik

Ergebnis: **418.6** (397)  
 Serien: 104.0 104.6 105.0 105.0  
 Zähler: 37 3 0 0 0 0 0 0 0 0  
 Innenzehner: 32  
 weiteste: 365 (5), 271 (15), 252 (26)  
 beste Teiler 31.9 (7.) 33.6 (27.) 34.3 (20.)  
 Trefferlage 0.14 mm links, 0.17 mm hoch  
 Streuwert 1.04, horizontal: 1.02, vertikal: 1.05

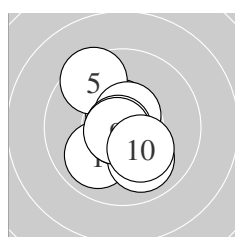
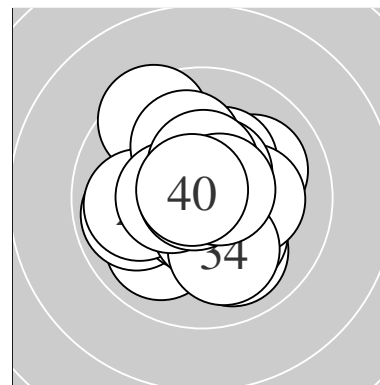

Serie 1:  
 10.0 ↘ 10.8 \* 10.6 \* 10.7 \* 9.5 ↗  
 10.6 \* 10.8 \* 10.0 ↘ 10.8 \* 10.2 \*  
 beste Teiler 31.9 (7.) 43.1 (2.) 45.2 (9.)  
 Trefferlage 0.19 mm links, 0.05 mm tief  
 Streuwert 1.32, horizontal: 1.03, vertikal: 1.56

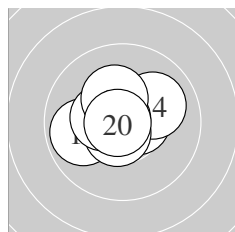

Serie 2:  
 10.6 \* 10.6 \* 10.6 \* 10.0 ↗ 9.9 ←  
 10.8 \* 10.6 \* 10.4 \* 10.3 \* 10.8 \*  
 beste Teiler 34.3 (20.) 43.0 (16.) 80.0 (17.)  
 Trefferlage 0.27 mm links, 0.23 mm hoch  
 Streuwert 1.04, horizontal: 1.26, vertikal: 0.75

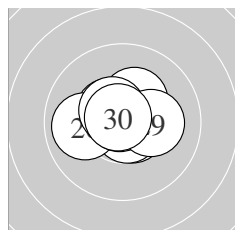

Serie 3:  
 10.6 \* 10.7 \* 10.7 \* 10.3 \* 10.5 \*  
 9.9 ← 10.8 \* 10.5 \* 10.2 \* 10.8 \*  
 beste Teiler 33.6 (27.) 44.5 (30.) 59.3 (22.)  
 Trefferlage 0.10 mm links, 0.28 mm hoch  
 Streuwert 0.94, horizontal: 1.17, vertikal: 0.63

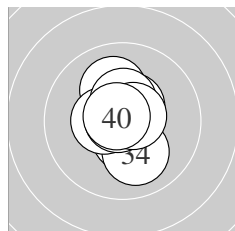

Serie 4:  
 10.5 \* 10.5 \* 10.8 \* 10.1 ↘ 10.1 ↗  
 10.5 \* 10.4 \* 10.8 \* 10.6 \* 10.7 \*  
 beste Teiler 34.9 (38.) 41.0 (33.) 51.2 (40.)  
 Trefferlage 0.01 mm links, 0.24 mm hoch  
 Streuwert 0.94, horizontal: 0.65, vertikal: 1.17

Unterschrift des Schützen

Meyton Elektronik

Ergebnis: **416.4** (400)  
 Serien: 104.1 103.7 104.1 104.5  
 Zähler: 40 0 0 0 0 0 0 0 0 0  
 Innenzehner: 33  
 weiteste: 243 (2), 224 (16), 214 (8)  
 beste Teiler 10.8 (1.) 34.2 (30.) 42.0 (35.)  
 Trefferlage 0.28 mm rechts, 0.04 mm tief  
 Streuwert 1.05, horizontal: 0.93, vertikal: 1.16

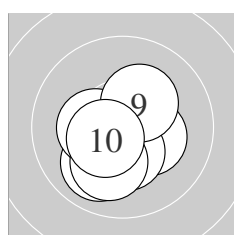
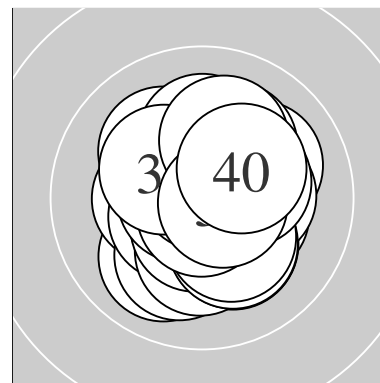

Serie 1:  
 10.9 \*                      10.0 ↘                      10.7 \*                      10.6 \*                      10.3 \*  
 10.4 \*                      10.3 \*                      10.1 ↘                      10.3 \*                      10.5 \*  
 beste Teiler 10.8 (1.) 64.7 (3.) 90.8 (4.)  
 Trefferlage 0.20 mm links, 0.67 mm tief  
 Streuwert 1.00, horizontal: 0.98, vertikal: 1.02

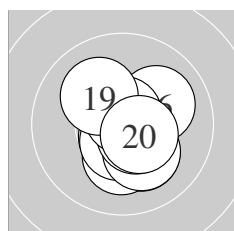

Serie 2:  
 10.2 \*                      10.6 \*                      10.2 \*                      10.5 \*                      10.2 \*  
 10.1 ↗                      10.6 \*                      10.7 \*                      10.1 ↘                      10.5 \*  
 beste Teiler 51.0 (18.) 78.9 (12.) 97.9 (17.)  
 Trefferlage 0.38 mm rechts, 0.47 mm tief  
 Streuwert 1.07, horizontal: 0.95, vertikal: 1.19

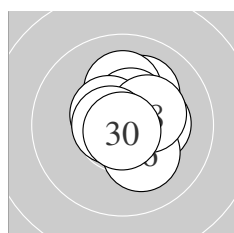

Serie 3:  
 10.1 ↗                      10.3 \*                      10.5 \*                      10.1 ↑                      10.5 \*  
 10.2 \*                      10.6 \*                      10.3 \*                      10.7 \*                      10.8 \*  
 beste Teiler 34.2 (30.) 69.0 (29.) 100.6 (27.)  
 Trefferlage 0.38 mm rechts, 0.53 mm hoch  
 Streuwert 0.98, horizontal: 0.90, vertikal: 1.06

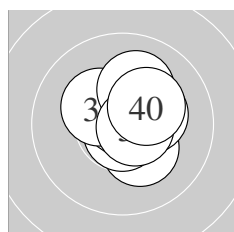

Serie 4:  
 10.3 \*                      10.3 \*                      10.6 \*                      10.8 \*                      10.8 \*  
 10.3 \*                      10.1 ↑                      10.3 \*                      10.7 \*                      10.3 \*  
 beste Teiler 42.0 (35.) 48.0 (34.) 73.9 (39.)  
 Trefferlage 0.58 mm rechts, 0.44 mm hoch  
 Streuwert 0.90, horizontal: 0.84, vertikal: 0.96

Unterschrift des Schützen

Meyton Elektronik



Ergebnis: **417.8** (396)  
 Serien: 103.9 104.7 103.6 105.6  
 Zähler: 36 4 0 0 0 0 0 0 0 0  
 Innenzehner: 34  
 weiteste: 439 (22), 269 (19), 260 (6)  
 beste Teiler 15.0 (10.) 24.5 (3.) 25.4 (14.)  
 Trefferlage 0.02 mm links, 0.46 mm hoch  
 Streuwert 1.04, horizontal: 1.14, vertikal: 0.94

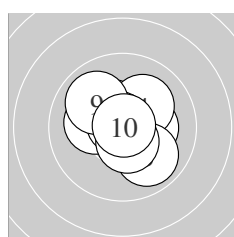
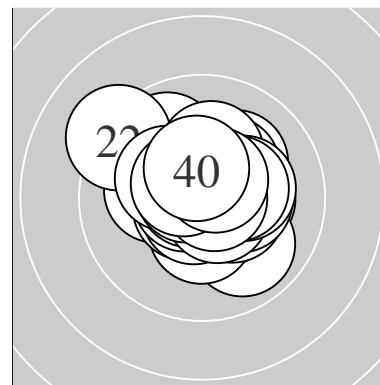

Serie 1:  
 10.3 \*                      10.4 \*                      10.9 \*                      10.1 ↗                      10.2 \*  
 9.9 ↘                      10.8 \*                      10.5 \*                      9.9 ↘                      10.9 \*  
 beste Teiler 15.0 (10.) 24.5 (3.) 46.0 (7.)  
 Trefferlage 0.06 mm rechts, 0.20 mm hoch  
 Streuwert 1.23, horizontal: 1.33, vertikal: 1.12

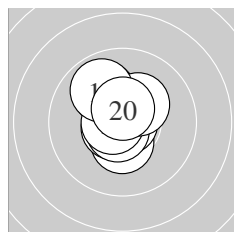

Serie 2:  
 10.4 \*                      10.6 \*                      10.6 \*                      10.9 \*                      10.0 ↖  
 10.7 \*                      10.7 \*                      10.3 \*                      9.9 ↖                      10.6 \*  
 beste Teiler 25.4 (14.) 67.7 (16.) 70.1 (17.)  
 Trefferlage 0.36 mm links, 0.47 mm hoch  
 Streuwert 0.99, horizontal: 0.75, vertikal: 1.18

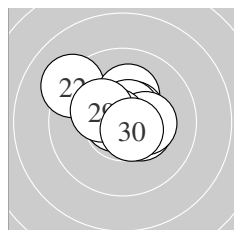

Serie 3:  
 10.7 \*                      9.2 ↖                      10.2 \*                      10.4 \*                      10.6 \*  
 10.6 \*                      10.3 \*                      10.7 \*                      10.3 \*                      10.6 \*  
 beste Teiler 52.8 (28.) 69.8 (21.) 83.8 (30.)  
 Trefferlage 0.02 mm links, 0.63 mm hoch  
 Streuwert 1.28, horizontal: 1.52, vertikal: 0.99

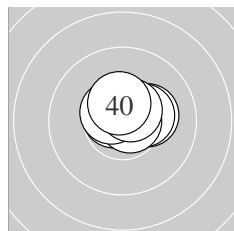

Serie 4:  
 10.6 \*                      10.8 \*                      10.6 \*                      10.7 \*                      10.2 \*  
 10.4 \*                      10.7 \*                      10.6 \*                      10.6 \*                      10.4 \*  
 beste Teiler 46.6 (32.) 53.0 (37.) 70.7 (34.)  
 Trefferlage 0.20 mm rechts, 0.53 mm hoch  
 Streuwert 0.67, horizontal: 0.88, vertikal: 0.35

Unterschrift des Schützen

Meyton Elektronik

Ergebnis: **412.1** (393)  
 Serien: 103.3 103.2 102.3 103.3  
 Zähler: 33 7 0 0 0 0 0 0 0 0  
 Innenzehner: 24  
 weiteste: 378 (17), 291 (23), 284 (40)  
 beste Teiler 12.0 (11.) 27.8 (8.) 41.9 (36.)  
 Trefferlage 0.57 mm links, 0.15 mm tief  
 Streuwert 1.25, horizontal: 1.40, vertikal: 1.08

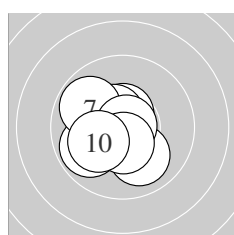
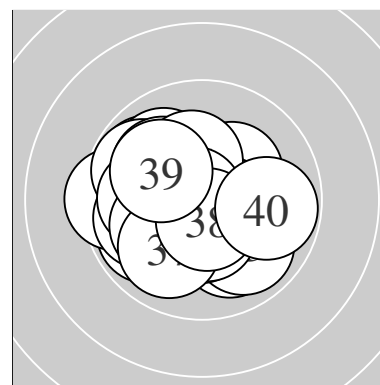

Serie 1:  
 10.0 ↘ 10.6 \* 10.4 \* 10.7 \* 10.5 \*  
 9.9 ↙ 9.8 ↖ 10.8 \* 10.5 \* 10.1 ↖  
 beste Teiler 27.8 (8.) 70.7 (4.) 94.0 (2.)  
 Trefferlage 0.70 mm links, 0.28 mm tief  
 Streuwert 1.18, horizontal: 1.21, vertikal: 1.16

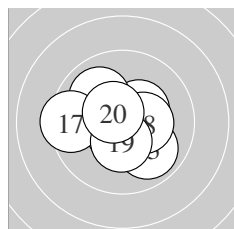

Serie 2:  
 10.9 \* 10.6 \* 9.9 ↘ 10.4 \* 10.0 ↖  
 10.6 \* 9.4 ← 10.4 \* 10.4 \* 10.6 \*  
 beste Teiler 12.0 (11.) 77.3 (16.) 82.4 (12.)  
 Trefferlage 0.14 mm links, 0.09 mm tief  
 Streuwert 1.40, horizontal: 1.66, vertikal: 1.08

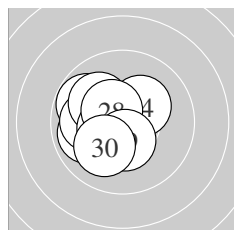

Serie 3:  
 10.7 \* 9.9 ← 9.8 ↖ 10.3 \* 10.0 ←  
 10.1 ↖ 10.5 \* 10.5 \* 10.4 \* 10.1 ↖  
 beste Teiler 56.8 (21.) 116.7 (28.) 117.9 (27.)  
 Trefferlage 1.11 mm links, 0.00 mm  
 Streuwert 1.20, horizontal: 1.27, vertikal: 1.13

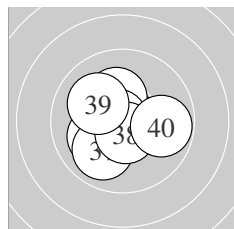

Serie 4:  
 10.4 \* 10.1 ↙ 10.5 \* 10.7 \* 10.3 \*  
 10.8 \* 10.0 ↙ 10.6 \* 10.1 ↖ 9.8 →  
 beste Teiler 41.9 (36.) 61.4 (34.) 88.7 (38.)  
 Trefferlage 0.36 mm links, 0.24 mm tief  
 Streuwert 1.28, horizontal: 1.45, vertikal: 1.09

Unterschrift des Schützen

Meyton Elektronik

Ergebnis: **408.4** (392)  
 Serien: 102.4 102.7 101.7 101.6  
 Zähler: 32 8 0 0 0 0 0 0 0 0  
 Innenzehner: 26  
 weiteste: 397 (35), 345 (10), 344 (7)  
 beste Teiler 31.7 (6.) 80.0 (8.) 86.7 (11.)  
 Trefferlage 0.33 mm rechts, 0.31 mm hoch  
 Streuwert 1.42, horizontal: 1.50, vertikal: 1.33

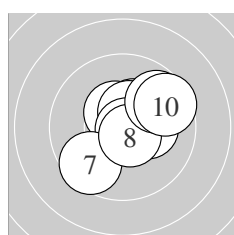
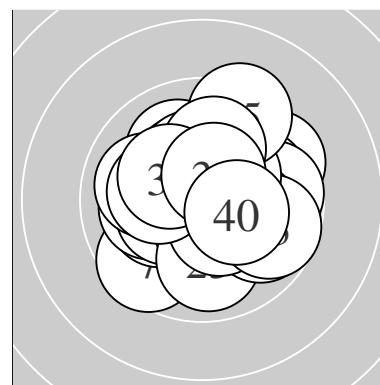

Serie 1:  
 10.4 \*                      10.5 \*                      10.5 \*                      10.5 \*                      10.2 \*  
 10.8 \*                      9.6 ↙                      10.6 \*                      9.7 ↗                      9.6 ↗  
 beste Teiler 31.7 (6.) 80.0 (8.) 108.2 (3.)  
 Trefferlage 0.74 mm rechts, 0.38 mm hoch  
 Streuwert 1.41, horizontal: 1.51, vertikal: 1.31

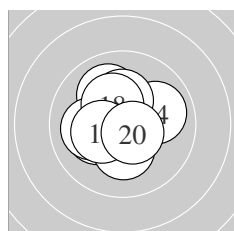

Serie 2:  
 10.6 \*                      10.2 \*                      10.0 ↖                      10.0 →                      10.1 ←  
 10.3 \*                      10.3 \*                      10.3 \*                      10.3 \*                      10.6 \*  
 beste Teiler 86.7 (11.) 93.6 (20.) 156.9 (19.)  
 Trefferlage 0.40 mm links, 0.29 mm hoch  
 Streuwert 1.29, horizontal: 1.34, vertikal: 1.24

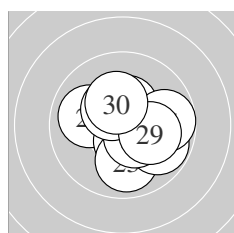

Serie 3:  
 10.0 ↖                      10.5 \*                      9.9 ↓                      10.4 \*                      9.8 ↘  
 10.5 \*                      9.8 →                      10.4 \*                      10.1 →                      10.3 \*  
 beste Teiler 115.1 (22.) 119.5 (26.) 135.5 (24.)  
 Trefferlage 0.54 mm rechts, 0.13 mm tief  
 Streuwert 1.49, horizontal: 1.61, vertikal: 1.35

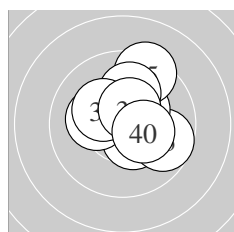

Serie 4:  
 10.4 \*                      10.4 \*                      9.7 ↘                      10.3 \*                      9.4 ↗  
 10.2 \*                      10.1 ↑                      10.3 \*                      10.5 \*                      10.3 \*  
 beste Teiler 118.1 (39.) 126.6 (31.) 129.2 (32.)  
 Trefferlage 0.45 mm rechts, 0.73 mm hoch  
 Streuwert 1.47, horizontal: 1.49, vertikal: 1.46

Unterschrift des Schützen

Meyton Elektronik

Ergebnis: **413.0** (393)  
 Serien: 102.9 103.9 103.1 103.1  
 Zähler: 33 7 0 0 0 0 0 0 0 0  
 Innenzehner: 30  
 weiteste: 414 (40), 391 (7), 318 (8)  
 beste Teiler 33.8 (31.) 39.3 (34.) 42.7 (13.)  
 Trefferlage 0.33 mm rechts, 0.37 mm tief  
 Streuwert 1.26, horizontal: 1.37, vertikal: 1.15

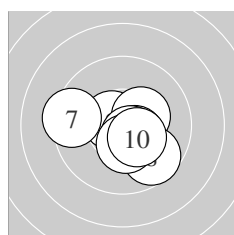
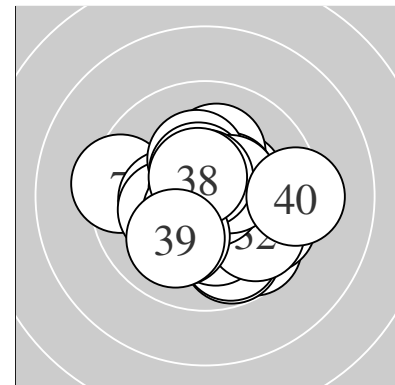

Serie 1:  
 10.6 \* 10.6 \* 10.4 \* 10.3 \* 10.5 \*  
 10.6 \* 9.4 ← 9.7 ↘ 10.4 \* 10.4 \*  
 beste Teiler 76.5 (1.) 89.9 (2.) 97.0 (6.)  
 Trefferlage 0.35 mm rechts, 0.51 mm tief  
 Streuwert 1.36, horizontal: 1.67, vertikal: 0.95

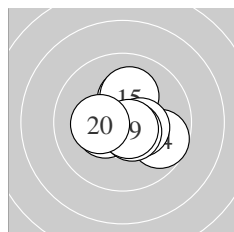

Serie 2:  
 10.3 \* 10.7 \* 10.8 \* 9.7 ↘ 10.1 ↑  
 10.4 \* 10.4 \* 10.5 \* 10.7 \* 10.3 \*  
 beste Teiler 42.7 (13.) 55.3 (12.) 70.7 (19.)  
 Trefferlage 0.30 mm rechts, 0.00 mm  
 Streuwert 1.17, horizontal: 1.30, vertikal: 1.04

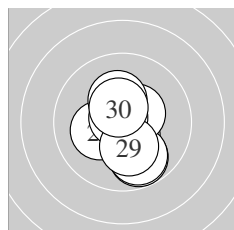

Serie 3:  
 9.8 ↘ 10.5 \* 9.8 ↘ 10.5 \* 10.5 \*  
 10.2 \* 10.8 \* 10.3 \* 10.2 \* 10.5 \*  
 beste Teiler 47.3 (27.) 114.8 (24.) 115.2 (30.)  
 Trefferlage 0.20 mm rechts, 0.60 mm tief  
 Streuwert 1.25, horizontal: 0.92, vertikal: 1.52

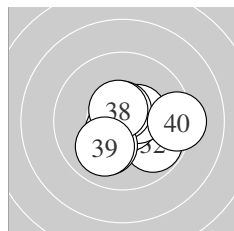

Serie 4:  
 10.8 \* 9.8 ↘ 10.6 \* 10.8 \* 10.5 \*  
 10.6 \* 10.1 ↙ 10.6 \* 10.0 ↙ 9.3 →  
 beste Teiler 33.8 (31.) 39.3 (34.) 79.1 (36.)  
 Trefferlage 0.48 mm rechts, 0.39 mm tief  
 Streuwert 1.41, horizontal: 1.67, vertikal: 1.08

Unterschrift des Schützen

Ergebnis: **418.2** (398)  
 Serien: 103.3 105.2 104.9 104.8  
 Zähler: 38 2 0 0 0 0 0 0 0 0  
 Innenzehner: 35  
 weiteste: 287 (9), 260 (31), 218 (4)  
 beste Teiler 12.2 (15.) 12.5 (22.) 27.1 (2.)  
 Trefferlage 0.13 mm rechts, 0.17 mm hoch  
 Streuwert 0.99, horizontal: 0.92, vertikal: 1.05

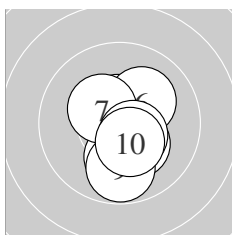
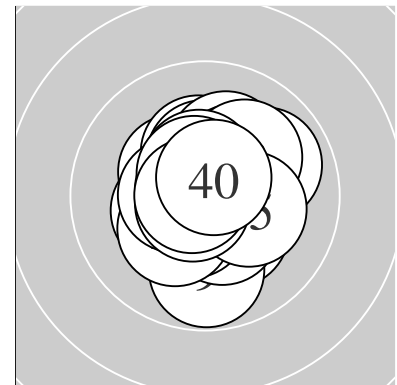

Serie 1:  
 10.3 \*                      10.8 \*                      10.6 \*                      10.1 ↓                      10.3 \*  
 10.1 ↗                      10.4 \*                      10.5 \*                      9.8 ↓                      10.4 \*  
 beste Teiler 27.1 (2.) 92.9 (3.) 116.9 (8.)  
 Trefferlage 0.41 mm rechts, 0.39 mm tief  
 Streuwert 1.19, horizontal: 0.77, vertikal: 1.50

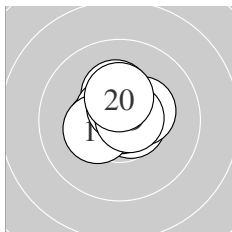

Serie 2:  
 10.6 \*                      10.3 \*                      10.5 \*                      10.3 \*                      10.9 \*  
 10.6 \*                      10.3 \*                      10.6 \*                      10.7 \*                      10.4 \*  
 beste Teiler 12.2 (15.) 65.5 (19.) 77.4 (11.)  
 Trefferlage 0.05 mm links, 0.42 mm hoch  
 Streuwert 0.81, horizontal: 0.87, vertikal: 0.75

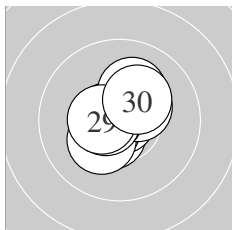

Serie 3:  
 10.5 \*                      10.9 \*                      10.5 \*                      10.3 \*                      10.4 \*  
 10.7 \*                      10.2 \*                      10.6 \*                      10.5 \*                      10.3 \*  
 beste Teiler 12.5 (22.) 69.8 (26.) 89.2 (28.)  
 Trefferlage 0.20 mm links, 0.14 mm hoch  
 Streuwert 0.96, horizontal: 0.94, vertikal: 0.97

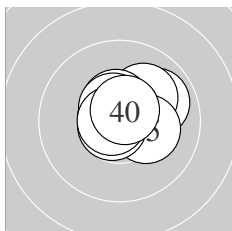

Serie 4:  
 9.9 ↗                      10.7 \*                      10.1 ↗                      10.8 \*                      10.2 \*  
 10.7 \*                      10.5 \*                      10.6 \*                      10.7 \*                      10.6 \*  
 beste Teiler 35.1 (34.) 51.0 (39.) 54.5 (32.)  
 Trefferlage 0.37 mm rechts, 0.52 mm hoch  
 Streuwert 0.89, horizontal: 1.07, vertikal: 0.67

Unterschrift des Schützen

Ergebnis: **415.6** (399)  
 Serien: 103.6 102.9 104.7 104.4  
 Zähler: 39 1 0 0 0 0 0 0 0 0  
 Innenzehner: 34  
 weiteste: 282 (17), 250 (13), 226 (9)  
 beste Teiler 36.1 (23.) 41.1 (25.) 42.9 (4.)  
 Trefferlage 0.02 mm links, 0.33 mm hoch  
 Streuwert 1.08, horizontal: 1.18, vertikal: 0.96

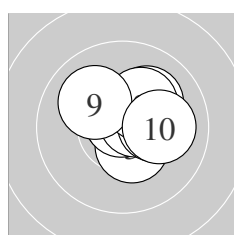
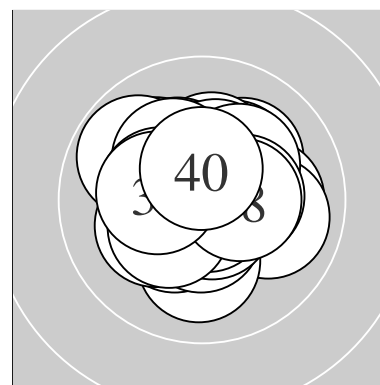

Serie 1:  
 10.7 \*                      10.5 \*                      10.4 \*                      10.8 \*                      10.6 \*  
 10.2 \*                      10.1 ↗                      10.2 \*                      10.0 ↖                      10.1 →  
 beste Teiler 42.9 (4.) 58.8 (1.) 89.9 (5.)  
 Trefferlage 0.71 mm rechts, 0.55 mm hoch  
 Streuwert 0.99, horizontal: 1.15, vertikal: 0.81

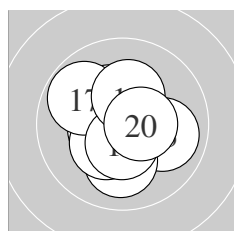

Serie 2:  
 10.3 \*                      10.5 \*                      10.0 →                      10.6 \*                      10.1 ↓  
 10.3 \*                      9.8 ↘                      10.5 \*                      10.3 \*                      10.5 \*  
 beste Teiler 99.0 (14.) 111.0 (20.) 114.0 (18.)  
 Trefferlage 0.15 mm links, 0.01 mm hoch  
 Streuwert 1.33, horizontal: 1.31, vertikal: 1.34

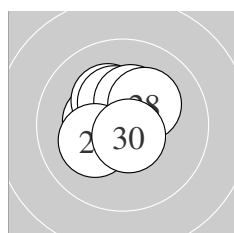

Serie 3:  
 10.4 \*                      10.6 \*                      10.8 \*                      10.3 \*                      10.8 \*  
 10.4 \*                      10.3 \*                      10.2 \*                      10.2 \*                      10.7 \*  
 beste Teiler 36.1 (23.) 41.1 (25.) 75.6 (30.)  
 Trefferlage 0.34 mm links, 0.50 mm hoch  
 Streuwert 0.91, horizontal: 0.90, vertikal: 0.91

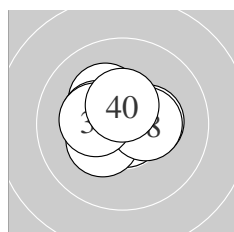

Serie 4:  
 10.8 \*                      10.4 \*                      10.8 \*                      10.2 \*                      10.3 \*  
 10.4 \*                      10.3 \*                      10.4 \*                      10.3 \*                      10.5 \*  
 beste Teiler 43.3 (33.) 49.7 (31.) 115.0 (40.)  
 Trefferlage 0.31 mm links, 0.23 mm hoch  
 Streuwert 0.97, horizontal: 1.19, vertikal: 0.69

Unterschrift des Schützen

Meyton Elektronik

Ergebnis: **420.6** (400)  
 Serien: 105.0 104.5 105.5 105.6  
 Zähler: 40 0 0 0 0 0 0 0 0 0  
 Innenzehner: 37  
 weiteste: 249 (20), 240 (39), 207 (34)  
 beste Teiler 38.0 (36.) 41.0 (30.) 43.0 (9.)  
 Trefferlage 0.23 mm links, 0.01 mm tief  
 Streuwert 0.87, horizontal: 1.04, vertikal: 0.67

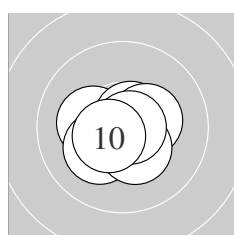
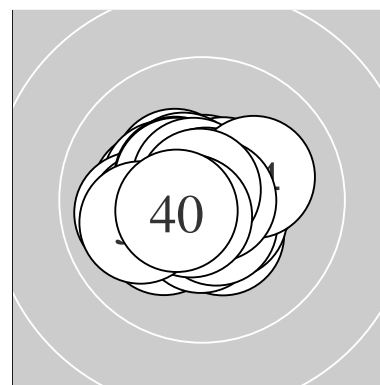

Serie 1:  
 10.6 \*                      10.2 \*                      10.6 \*                      10.2 \*                      10.7 \*  
 10.5 \*                      10.4 \*                      10.4 \*                      10.8 \*                      10.6 \*  
 beste Teiler 43.0 (9.) 74.4 (5.) 89.2 (1.)  
 Trefferlage 0.01 mm links, 0.22 mm tief  
 Streuwert 0.92, horizontal: 1.11, vertikal: 0.67

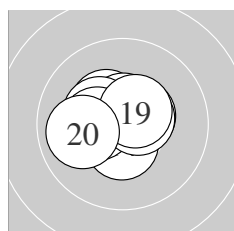

Serie 2:  
 10.5 \*                      10.8 \*                      10.4 \*                      10.5 \*                      10.6 \*  
 10.3 \*                      10.3 \*                      10.6 \*                      10.5 \*                      10.0 ←  
 beste Teiler 50.0 (12.) 88.1 (15.) 99.9 (18.)  
 Trefferlage 0.35 mm links, 0.21 mm hoch  
 Streuwert 0.98, horizontal: 1.18, vertikal: 0.73

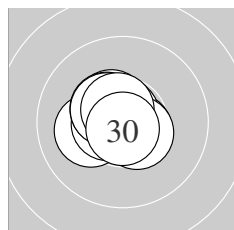

Serie 3:  
 10.5 \*                      10.6 \*                      10.2 \*                      10.6 \*                      10.4 \*  
 10.5 \*                      10.8 \*                      10.5 \*                      10.6 \*                      10.8 \*  
 beste Teiler 41.0 (30.) 44.0 (27.) 83.3 (29.)  
 Trefferlage 0.41 mm links, 0.15 mm hoch  
 Streuwert 0.77, horizontal: 0.87, vertikal: 0.65

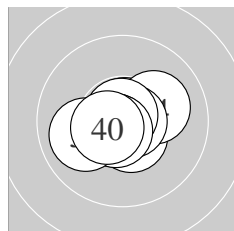

Serie 4:  
 10.7 \*                      10.5 \*                      10.8 \*                      10.1 →                      10.8 \*  
 10.8 \*                      10.7 \*                      10.7 \*                      10.0 ←                      10.5 \*  
 beste Teiler 38.0 (36.) 43.3 (33.) 48.0 (35.)  
 Trefferlage 0.16 mm links, 0.19 mm tief  
 Streuwert 0.87, horizontal: 1.08, vertikal: 0.58

Unterschrift des Schützen

Meyton Elektronik

Ergebnis: **416.5** (399)  
 Serien: 104.7 104.0 104.6 103.2  
 Zähler: 39 1 0 0 0 0 0 0 0 0  
 Innenzehner: 33  
 weiteste: 301 (38), 237 (19), 214 (10)  
 beste Teiler 35.0 (3.) 38.0 (30.) 45.8 (40.)  
 Trefferlage 0.41 mm links, 0.25 mm hoch  
 Streuwert 1.01, horizontal: 0.97, vertikal: 1.04

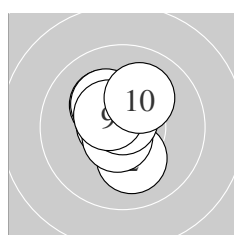
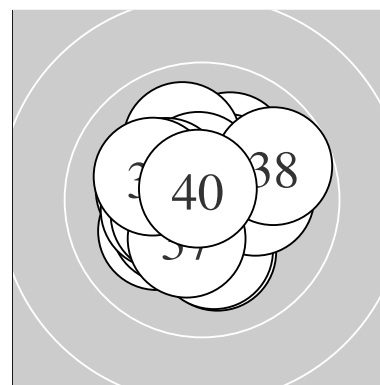

Serie 1:  
 10.2 \*                      10.1 ↓                      10.8 \*                      10.6 \*                      10.2 \*  
 10.7 \*                      10.7 \*                      10.8 \*                      10.5 \*                      10.1 ↗  
 beste Teiler 35.0 (3.) 49.0 (8.) 70.2 (7.)  
 Trefferlage 0.34 mm links, 0.42 mm hoch  
 Streuwert 0.94, horizontal: 0.72, vertikal: 1.13

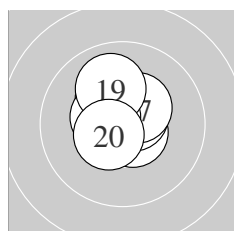

Serie 2:  
 10.2 \*                      10.6 \*                      10.3 \*                      10.4 \*                      10.5 \*  
 10.6 \*                      10.4 \*                      10.5 \*                      10.0 ↑                      10.5 \*  
 beste Teiler 82.0 (12.) 85.4 (16.) 107.2 (15.)  
 Trefferlage 0.28 mm links, 0.87 mm hoch  
 Streuwert 0.85, horizontal: 0.74, vertikal: 0.96

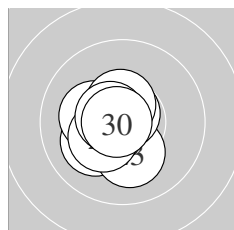

Serie 3:  
 10.6 \*                      10.1 ↖                      10.2 \*                      10.2 \*                      10.7 \*  
 10.6 \*                      10.3 \*                      10.5 \*                      10.6 \*                      10.8 \*  
 beste Teiler 38.0 (30.) 56.7 (25.) 85.0 (29.)  
 Trefferlage 0.66 mm links, 0.30 mm tief  
 Streuwert 0.85, horizontal: 0.76, vertikal: 0.94

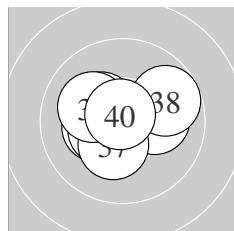

Serie 4:  
 10.7 \*                      10.5 \*                      10.3 \*                      10.4 \*                      10.3 \*  
 10.1 →                      10.3 \*                      9.7 ↗                      10.1 ↖                      10.8 \*  
 beste Teiler 45.8 (40.) 73.6 (31.) 110.9 (32.)  
 Trefferlage 0.35 mm links, 0.00 mm  
 Streuwert 1.25, horizontal: 1.54, vertikal: 0.86

Unterschrift des Schützen

Meyton Elektronik



Ergebnis: **415.2** (397)  
 Serien: 103.5 104.3 105.1 102.3  
 Zähler: 37 3 0 0 0 0 0 0 0 0  
 Innenzehner: 32  
 weiteste: 300 (35), 289 (7), 254 (5)  
 beste Teiler 22.4 (8.) 29.6 (28.) 47.0 (29.)  
 Trefferlage 0.37 mm links, 0.04 mm hoch  
 Streuwert 1.12, horizontal: 1.07, vertikal: 1.16

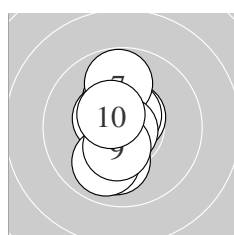
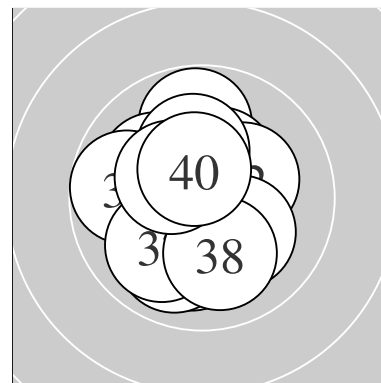

Serie 1:  
 10.2 \*                      10.6 \*                      10.1 ↓                      10.5 \*                      9.9 ↙  
 10.6 \*                      9.8 ↑                      10.9 \*                      10.4 \*                      10.5 \*  
 beste Teiler 22.4 (8.) 85.2 (6.) 88.5 (2.)  
 Trefferlage 0.34 mm links, 0.15 mm hoch  
 Streuwert 1.25, horizontal: 0.56, vertikal: 1.68

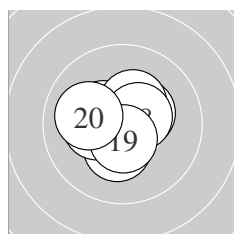

Serie 2:  
 10.4 \*                      10.7 \*                      10.4 \*                      10.7 \*                      10.3 \*  
 10.4 \*                      10.3 \*                      10.5 \*                      10.6 \*                      10.0 ←  
 beste Teiler 71.0 (14.) 72.4 (12.) 97.0 (19.)  
 Trefferlage 0.31 mm links, 0.22 mm hoch  
 Streuwert 1.02, horizontal: 1.15, vertikal: 0.87

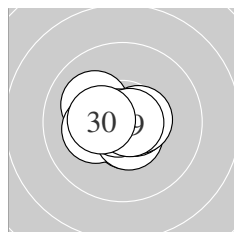

Serie 3:  
 10.1 ↘                      10.5 \*                      10.6 \*                      10.2 \*                      10.6 \*  
 10.6 \*                      10.5 \*                      10.8 \*                      10.8 \*                      10.4 \*  
 beste Teiler 29.6 (28.) 47.0 (29.) 78.0 (26.)  
 Trefferlage 0.34 mm links, 0.09 mm tief  
 Streuwert 0.87, horizontal: 1.09, vertikal: 0.58

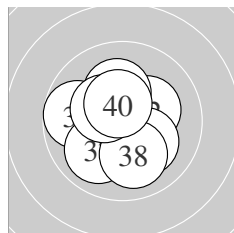

Serie 4:  
 10.7 \*                      10.2 \*                      10.2 \*                      10.3 \*                      9.8 ←  
 10.2 \*                      10.0 ↙                      10.0 ↓                      10.4 \*                      10.5 \*  
 beste Teiler 72.9 (31.) 118.1 (40.) 146.1 (39.)  
 Trefferlage 0.49 mm links, 0.12 mm tief  
 Streuwert 1.40, horizontal: 1.45, vertikal: 1.35

Unterschrift des Schützen

Meyton Elektronik

Ergebnis: **413.5** (393)  
 Serien: 102.8 104.3 103.0 103.4  
 Zähler: 33 7 0 0 0 0 0 0 0 0  
 Innenzehner: 27  
 weiteste: 405 (23), 348 (35), 337 (2)  
 beste Teiler 14.3 (17.) 34.0 (22.) 42.0 (27.)  
 Trefferlage 0.10 mm links, 0.25 mm hoch  
 Streuwert 1.28, horizontal: 1.54, vertikal: 0.96

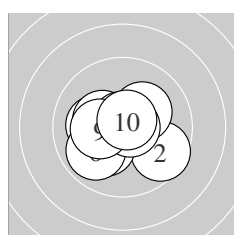
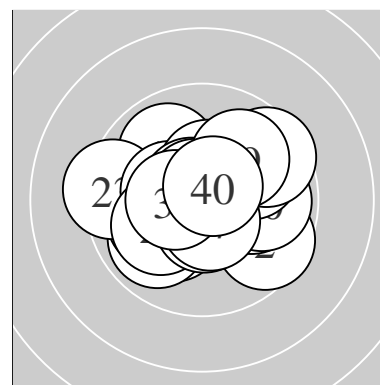

Serie 1:  
 10.1 ←                      9.6 ↘                      10.2 \*                      10.2 \*                      10.3 \*  
 9.9 ↙                      10.8 \*                      10.7 \*                      10.3 \*                      10.7 \*  
 beste Teiler 45.5 (7.) 57.0 (8.) 62.7 (10.)  
 Trefferlage 0.33 mm links, 0.22 mm tief  
 Streuwert 1.38, horizontal: 1.65, vertikal: 1.05

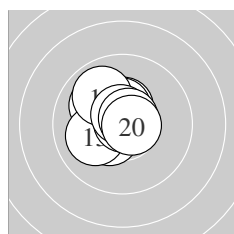

Serie 2:  
 10.4 \*                      10.0 ↘                      10.1 ↙                      10.4 \*                      10.5 \*  
 9.9 ↘                      10.9 \*                      10.7 \*                      10.7 \*                      10.7 \*  
 beste Teiler 14.3 (17.) 62.2 (19.) 67.4 (20.)  
 Trefferlage 0.54 mm links, 0.55 mm hoch  
 Streuwert 0.98, horizontal: 0.97, vertikal: 0.99

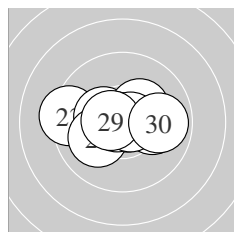

Serie 3:  
 10.1 →                      10.8 \*                      9.3 ←                      10.4 \*                      10.3 \*  
 10.1 ↙                      10.8 \*                      10.7 \*                      10.6 \*                      9.9 →  
 beste Teiler 34.0 (22.) 42.0 (27.) 59.0 (28.)  
 Trefferlage 0.14 mm links, 0.06 mm hoch  
 Streuwert 1.48, horizontal: 2.02, vertikal: 0.55

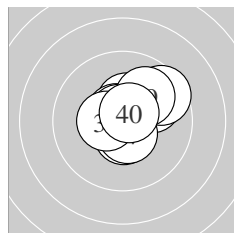

Serie 4:  
 10.5 \*                      10.4 \*                      10.7 \*                      9.9 ↗                      9.6 ↗  
 10.7 \*                      10.5 \*                      10.5 \*                      10.0 ↗                      10.6 \*  
 beste Teiler 57.7 (36.) 74.4 (33.) 79.0 (40.)  
 Trefferlage 0.60 mm rechts, 0.62 mm hoch  
 Streuwert 1.17, horizontal: 1.27, vertikal: 1.05

Unterschrift des Schützen

Meyton Elektronik

Ergebnis: **413.3** (397)  
 Serien: 102.1 103.0 104.7 103.5  
 Zähler: 37 3 0 0 0 0 0 0 0 0  
 Innenzehner: 35  
 weiteste: 339 (8), 277 (5), 259 (19)  
 beste Teiler 4.2 (24.) 51.0 (1.) 51.9 (31.)  
 Trefferlage 0.42 mm links, 0.22 mm hoch  
 Streuwert 1.13, horizontal: 1.14, vertikal: 1.13

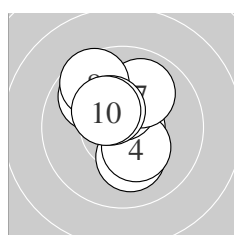
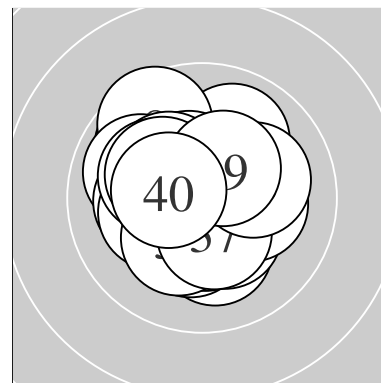

Serie 1:  
 10.7 \*                      10.2 \*                      10.4 \*                      10.3 \*                      9.8 ↖  
 10.4 \*                      10.0 ↗                      9.6 ↘                      10.4 \*                      10.3 \*  
 beste Teiler 51.0 (1.) 133.4 (9.) 137.8 (3.)  
 Trefferlage 0.34 mm links, 0.84 mm hoch  
 Streuwert 1.33, horizontal: 1.11, vertikal: 1.52

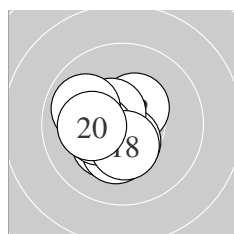

Serie 2:  
 10.2 \*                      10.4 \*                      10.5 \*                      10.5 \*                      10.3 \*  
 10.3 \*                      10.3 \*                      10.4 \*                      9.9 ↖                      10.2 \*  
 beste Teiler 103.9 (14.) 113.3 (13.) 132.4 (12.)  
 Trefferlage 0.88 mm links, 0.25 mm tief  
 Streuwert 1.05, horizontal: 1.06, vertikal: 1.04

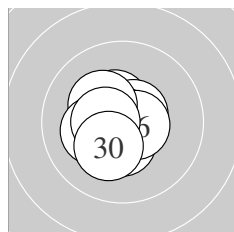

Serie 3:  
 10.5 \*                      10.5 \*                      10.6 \*                      10.9 \*                      10.4 \*  
 10.6 \*                      10.3 \*                      10.2 \*                      10.5 \*                      10.2 \*  
 beste Teiler 4.2 (24.) 84.1 (26.) 86.6 (23.)  
 Trefferlage 0.51 mm links, 0.07 mm tief  
 Streuwert 0.88, horizontal: 0.87, vertikal: 0.89

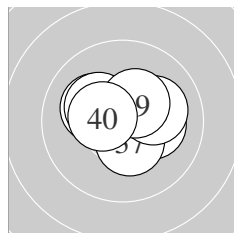

Serie 4:  
 10.7 \*                      10.5 \*                      10.2 \*                      10.2 \*                      10.4 \*  
 10.2 \*                      10.4 \*                      10.1 →                      10.4 \*                      10.4 \*  
 beste Teiler 51.9 (31.) 102.0 (32.) 133.4 (40.)  
 Trefferlage 0.04 mm rechts, 0.36 mm hoch  
 Streuwert 1.13, horizontal: 1.42, vertikal: 0.72

Unterschrift des Schützen

Ergebnis: **421.6** (400)  
 Serien: 105.5 106.0 105.3 104.8  
 Zähler: 40 0 0 0 0 0 0 0 0 0  
 Innenzehner: 38  
 weiteste: 250 (27), 205 (21), 178 (33)  
 beste Teiler 34.0 (24.) 36.6 (7.) 45.8 (29.)  
 Trefferlage 0.22 mm rechts, 0.21 mm hoch  
 Streuwert 0.78, horizontal: 0.78, vertikal: 0.77

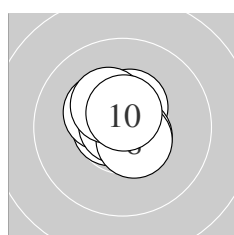
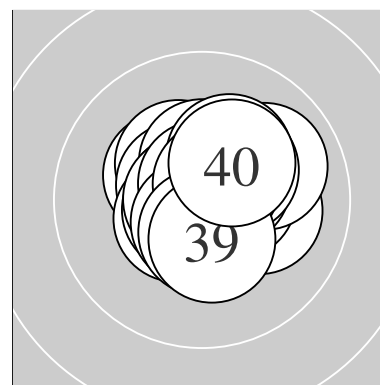

Serie 1:  
 10.5 \*                      10.6 \*                      10.6 \*                      10.6 \*                      10.7 \*  
 10.3 \*                      10.8 \*                      10.5 \*                      10.3 \*                      10.6 \*  
 beste Teiler 36.6 (7.) 72.0 (5.) 84.3 (10.)  
 Trefferlage 0.26 mm links, 0.41 mm hoch  
 Streuwert 0.69, horizontal: 0.69, vertikal: 0.70

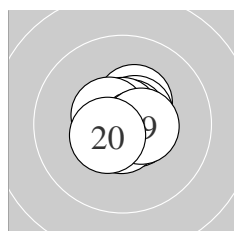

Serie 2:  
 10.4 \*                      10.6 \*                      10.7 \*                      10.7 \*                      10.7 \*  
 10.6 \*                      10.6 \*                      10.7 \*                      10.5 \*                      10.5 \*  
 beste Teiler 51.0 (14.) 57.3 (13.) 62.1 (15.)  
 Trefferlage 0.16 mm rechts, 0.10 mm hoch  
 Streuwert 0.67, horizontal: 0.68, vertikal: 0.66

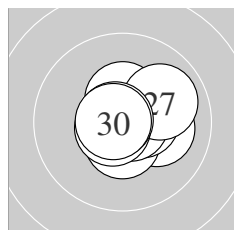

Serie 3:  
 10.1 →                      10.4 \*                      10.5 \*                      10.8 \*                      10.5 \*  
 10.8 \*                      10.0 ↗                      10.7 \*                      10.8 \*                      10.7 \*  
 beste Teiler 34.0 (24.) 45.8 (29.) 47.3 (26.)  
 Trefferlage 0.45 mm rechts, 0.09 mm hoch  
 Streuwert 0.88, horizontal: 1.01, vertikal: 0.71

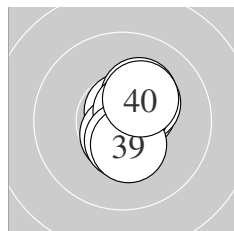

Serie 4:  
 10.7 \*                      10.6 \*                      10.2 \*                      10.5 \*                      10.3 \*  
 10.6 \*                      10.7 \*                      10.5 \*                      10.4 \*                      10.3 \*  
 beste Teiler 58.0 (31.) 75.8 (37.) 81.0 (32.)  
 Trefferlage 0.53 mm rechts, 0.26 mm hoch  
 Streuwert 0.81, horizontal: 0.51, vertikal: 1.02

Unterschrift des Schützen

Meyton Elektronik

Ergebnis: **413.3** (396)  
 Serien: 103.1 103.2 102.2 104.8  
 Zähler: 36 4 0 0 0 0 0 0 0 0  
 Innenzehner: 30  
 weiteste: 327 (30), 296 (27), 290 (20)  
 beste Teiler 28.0 (36.) 42.9 (40.) 46.0 (15.)  
 Trefferlage 0.00 mm , 0.32 mm tief  
 Streuwert 1.20, horizontal: 1.33, vertikal: 1.06

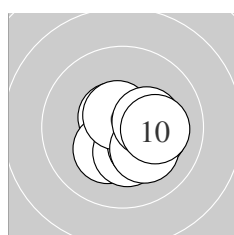
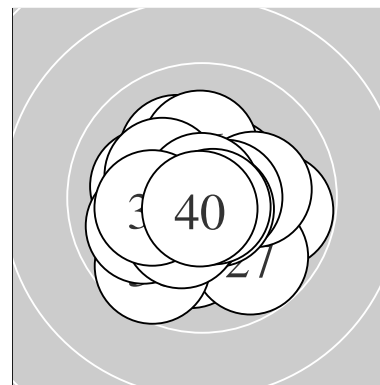

Serie 1:  
 10.6 \*                      10.3 \*                      10.3 \*                      10.3 \*                      10.2 \*  
 10.6 \*                      10.2 \*                      10.2 \*                      10.3 \*                      10.1 →  
 beste Teiler 84.1 (6.) 91.2 (1.) 160.3 (9.)  
 Trefferlage 0.85 mm rechts, 0.43 mm tief  
 Streuwert 1.04, horizontal: 1.16, vertikal: 0.90

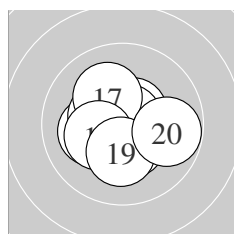

Serie 2:  
 10.5 \*                      10.1 ←                      10.6 \*                      10.4 \*                      10.8 \*  
 10.4 \*                      10.1 ↘                      10.3 \*                      10.2 \*                      9.8 →  
 beste Teiler 46.0 (15.) 100.1 (13.) 110.4 (11.)  
 Trefferlage 0.21 mm links, 0.03 mm tief  
 Streuwert 1.26, horizontal: 1.41, vertikal: 1.09

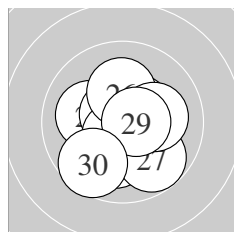

Serie 3:  
 10.1 ←                      10.6 \*                      10.5 \*                      10.1 ↓                      10.6 \*  
 10.2 \*                      9.8 ↘                      10.1 →                      10.6 \*                      9.6 ↙  
 beste Teiler 76.4 (22.) 88.0 (29.) 96.6 (25.)  
 Trefferlage 0.01 mm rechts, 0.37 mm tief  
 Streuwert 1.47, horizontal: 1.42, vertikal: 1.52

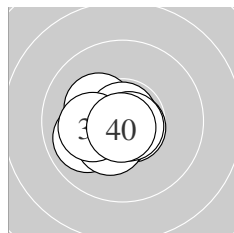

Serie 4:  
 10.6 \*                      10.7 \*                      10.5 \*                      10.2 \*                      9.9 ←  
 10.8 \*                      10.4 \*                      10.7 \*                      10.2 \*                      10.8 \*  
 beste Teiler 28.0 (36.) 42.9 (40.) 54.0 (38.)  
 Trefferlage 0.68 mm links, 0.44 mm tief  
 Streuwert 0.82, horizontal: 0.97, vertikal: 0.64

Unterschrift des Schützen

Meyton Elektronik

Ergebnis: **413.6** (393)  
 Serien: 100.2 104.8 105.2 103.4  
 Zähler: 34 5 1 0 0 0 0 0 0  
 Innenzehner: 31  
 weiteste: 566 (6), 384 (10), 343 (33)  
 beste Teiler 30.8 (37.) 37.6 (18.) 40.8 (13.)  
 Trefferlage 0.11 mm links, 0.15 mm hoch  
 Streuwert 1.33, horizontal: 1.58, vertikal: 1.02

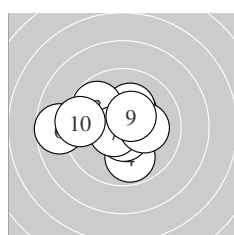
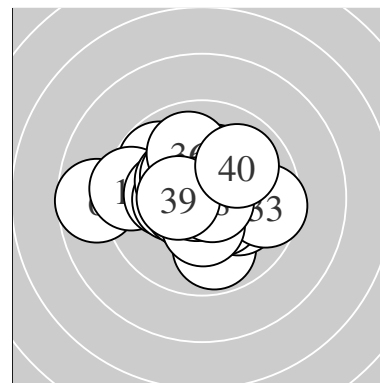

Serie 1:  
 10.3 \*                      10.2 \*                      9.8 ↖                      9.9 ↓                      10.6 \*  
 8.7 ←                      10.6 \*                      10.2 \*                      10.5 \*                      9.4 ←  
 beste Teiler 81.7 (5.) 87.2 (7.) 123.2 (9.)  
 Trefferlage 0.75 mm links, 0.22 mm hoch  
 Streuwert 1.96, horizontal: 2.42, vertikal: 1.37

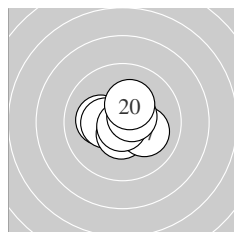

Serie 2:  
 10.2 \*                      10.4 \*                      10.8 \*                      10.8 \*                      10.3 \*  
 10.5 \*                      10.1 ↘                      10.8 \*                      10.6 \*                      10.3 \*  
 beste Teiler 37.6 (18.) 40.8 (13.) 44.1 (14.)  
 Trefferlage 0.12 mm rechts, 0.06 mm tief  
 Streuwert 1.00, horizontal: 1.18, vertikal: 0.78

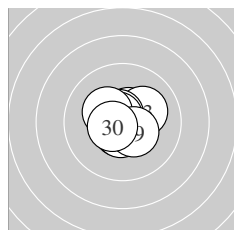

Serie 3:  
 10.6 \*                      10.6 \*                      10.1 ↗                      10.6 \*                      10.7 \*  
 10.6 \*                      10.7 \*                      10.3 \*                      10.4 \*                      10.6 \*  
 beste Teiler 59.4 (25.) 64.3 (27.) 76.9 (24.)  
 Trefferlage 0.02 mm links, 0.02 mm hoch  
 Streuwert 0.87, horizontal: 0.92, vertikal: 0.81

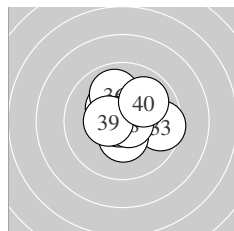

Serie 4:  
 10.7 \*                      10.6 \*                      9.6 →                      10.4 \*                      10.3 \*  
 10.0 ↑                      10.8 \*                      10.7 \*                      10.4 \*                      9.9 ↗  
 beste Teiler 30.8 (37.) 56.5 (38.) 67.4 (31.)  
 Trefferlage 0.20 mm rechts, 0.44 mm hoch  
 Streuwert 1.29, horizontal: 1.45, vertikal: 1.11

Unterschrift des Schützen

Meyton Elektronik

Ergebnis: **415.4** (396)  
 Serien: 102.9 104.2 105.1 103.2  
 Zähler: 36 4 0 0 0 0 0 0 0 0  
 Innenzehner: 33  
 weiteste: 294 (34), 281 (9), 269 (1)  
 beste Teiler 25.0 (24.) 38.4 (10.) 41.9 (28.)  
 Trefferlage 0.06 mm rechts, 0.39 mm tief  
 Streuwert 1.10, horizontal: 1.11, vertikal: 1.09

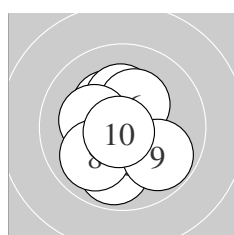
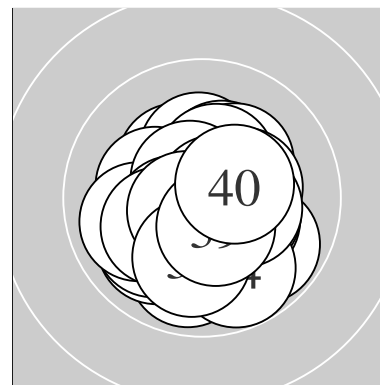

Serie 1:  
 9.9 ↓                      10.3 \*                      10.3 \*                      10.6 \*                      10.7 \*  
 10.3 \*                      10.2 \*                      10.0 ↙                      9.8 ↘                      10.8 \*  
 beste Teiler 38.4 (10.) 54.4 (5.) 96.0 (4.)  
 Trefferlage 0.22 mm links, 0.26 mm tief  
 Streuwert 1.36, horizontal: 1.19, vertikal: 1.50

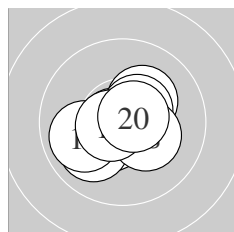

Serie 2:  
 10.5 \*                      10.0 ↙                      10.8 \*                      10.2 \*                      10.5 \*  
 10.8 \*                      9.9 ↙                      10.3 \*                      10.6 \*                      10.6 \*  
 beste Teiler 42.1 (16.) 50.8 (13.) 76.2 (19.)  
 Trefferlage 0.15 mm links, 0.20 mm tief  
 Streuwert 1.10, horizontal: 1.30, vertikal: 0.86

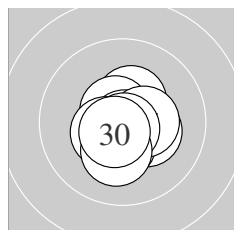

Serie 3:  
 10.4 \*                      10.6 \*                      10.3 \*                      10.9 \*                      10.5 \*  
 10.4 \*                      10.4 \*                      10.8 \*                      10.2 \*                      10.6 \*  
 beste Teiler 25.0 (24.) 41.9 (28.) 80.2 (30.)  
 Trefferlage 0.10 mm rechts, 0.36 mm tief  
 Streuwert 0.86, horizontal: 0.82, vertikal: 0.90

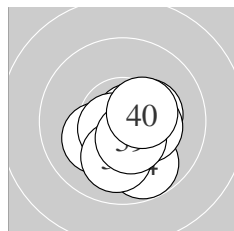

Serie 4:  
 10.4 \*                      10.7 \*                      10.2 \*                      9.8 ↘                      10.6 \*  
 10.3 \*                      10.0 ↓                      10.3 \*                      10.5 \*                      10.4 \*  
 beste Teiler 51.4 (32.) 76.0 (35.) 119.8 (39.)  
 Trefferlage 0.53 mm rechts, 0.75 mm tief  
 Streuwert 1.06, horizontal: 1.07, vertikal: 1.05

Unterschrift des Schützen

Meyton Elektronik

Ergebnis: **419.5** (398)  
 Serien: 105.6 104.1 104.5 105.3  
 Zähler: 38 2 0 0 0 0 0 0 0 0  
 Innenzehner: 36  
 weiteste: 295 (13), 293 (29), 245 (15)  
 beste Teiler 7.2 (3.) 21.0 (23.) 30.0 (12.)  
 Trefferlage 0.19 mm rechts, 0.09 mm tief  
 Streuwert 0.96, horizontal: 0.83, vertikal: 1.07

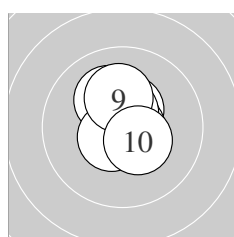
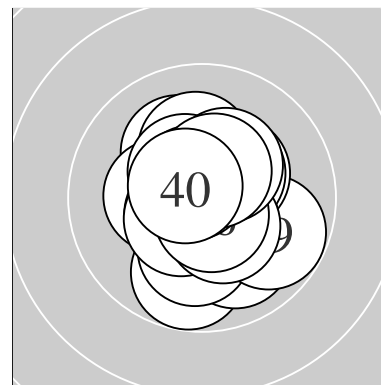

Serie 1:  
 10.1 ↖ 10.8 \* 10.9 \* 10.5 \* 10.8 \*  
 10.7 \* 10.6 \* 10.6 \* 10.2 \* 10.4 \*  
 beste Teiler 7.2 (3.) 37.9 (2.) 48.6 (5.)  
 Trefferlage 0.05 mm rechts, 0.42 mm hoch  
 Streuwert 0.81, horizontal: 0.58, vertikal: 0.98

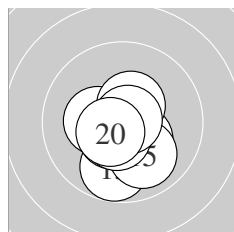

Serie 2:  
 10.3 \* 10.8 \* 9.8 ↓ 10.3 \* 10.0 ↘  
 10.5 \* 10.5 \* 10.6 \* 10.8 \* 10.5 \*  
 beste Teiler 30.0 (12.) 37.5 (19.) 98.2 (18.)  
 Trefferlage 0.04 mm links, 0.71 mm tief  
 Streuwert 1.04, horizontal: 0.91, vertikal: 1.16

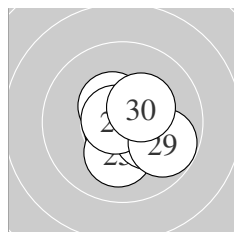

Serie 3:  
 10.7 \* 10.4 \* 10.9 \* 10.7 \* 10.2 \*  
 10.5 \* 10.2 \* 10.8 \* 9.8 ↘ 10.3 \*  
 beste Teiler 21.0 (23.) 49.6 (28.) 54.1 (21.)  
 Trefferlage 0.50 mm rechts, 0.23 mm tief  
 Streuwert 1.05, horizontal: 1.09, vertikal: 1.00

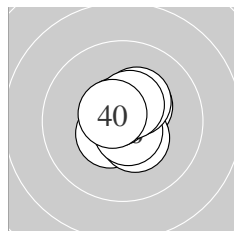

Serie 4:  
 10.5 \* 10.7 \* 10.5 \* 10.4 \* 10.4 \*  
 10.7 \* 10.7 \* 10.3 \* 10.5 \* 10.6 \*  
 beste Teiler 58.5 (32.) 70.4 (37.) 75.6 (36.)  
 Trefferlage 0.27 mm rechts, 0.14 mm hoch  
 Streuwert 0.80, horizontal: 0.67, vertikal: 0.90

Unterschrift des Schützen

Meyton Elektronik



Ergebnis: **416.7** (396)  
 Serien: 104.4 103.6 104.0 104.7  
 Zähler: 36 4 0 0 0 0 0 0 0 0  
 Innenzehner: 32  
 weiteste: 332 (11), 300 (22), 287 (1)  
 beste Teiler 13.0 (37.) 30.6 (4.) 36.4 (8.)  
 Trefferlage 0.40 mm rechts, 0.58 mm hoch  
 Streuwert 1.00, horizontal: 1.22, vertikal: 0.72

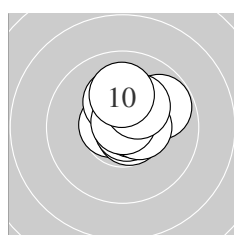
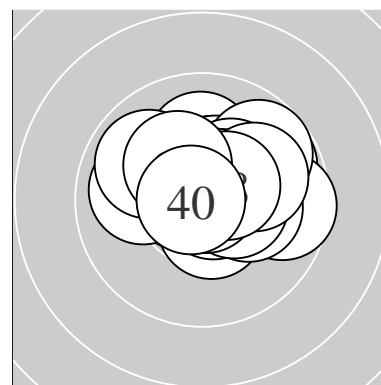

Serie 1:  
 9.8 ↗ 10.6 \* 10.7 \* 10.8 \* 10.7 \*  
 10.5 \* 10.2 \* 10.8 \* 10.2 \* 10.1 ↑  
 beste Teiler 30.6 (4.) 36.4 (8.) 60.4 (3.)  
 Trefferlage 0.48 mm rechts, 0.69 mm hoch  
 Streuwert 0.93, horizontal: 0.94, vertikal: 0.91

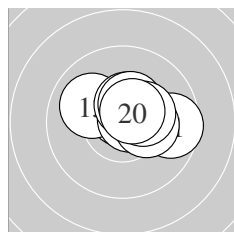

Serie 2:  
 9.6 → 10.7 \* 10.0 ↖ 10.7 \* 10.5 \*  
 10.5 \* 10.4 \* 10.3 \* 10.3 \* 10.6 \*  
 beste Teiler 54.0 (14.) 56.3 (12.) 100.5 (20.)  
 Trefferlage 0.70 mm rechts, 0.60 mm hoch  
 Streuwert 1.04, horizontal: 1.37, vertikal: 0.55

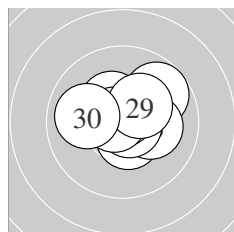

Serie 3:  
 10.5 \* 9.8 ↗ 10.2 \* 10.7 \* 10.7 \*  
 10.7 \* 10.4 \* 10.7 \* 10.3 \* 10.0 ←  
 beste Teiler 51.4 (24.) 55.0 (26.) 59.4 (28.)  
 Trefferlage 0.22 mm rechts, 0.45 mm hoch  
 Streuwert 1.15, horizontal: 1.39, vertikal: 0.85

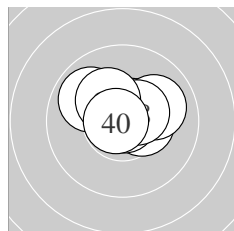

Serie 4:  
 10.4 \* 10.8 \* 10.5 \* 10.6 \* 9.9 ↖  
 10.0 ↗ 10.9 \* 10.5 \* 10.3 \* 10.8 \*  
 beste Teiler 13.0 (37.) 40.2 (32.) 46.0 (40.)  
 Trefferlage 0.21 mm rechts, 0.58 mm hoch  
 Streuwert 0.98, horizontal: 1.26, vertikal: 0.58

Unterschrift des Schützen

Meyton Elektronik

Ergebnis: **411.7** (395)  
 Serien: 102.9 104.5 101.2 103.1  
 Zähler: 35 5 0 0 0 0 0 0 0 0  
 Innenzehner: 30  
 weiteste: 367 (22), 309 (8), 305 (21)  
 beste Teiler 8.5 (16.) 32.9 (36.) 46.5 (18.)  
 Trefferlage 0.25 mm links, 0.04 mm tief  
 Streuwert 1.28, horizontal: 1.29, vertikal: 1.28

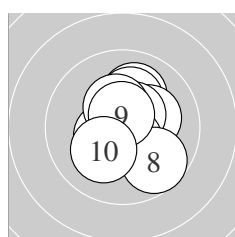
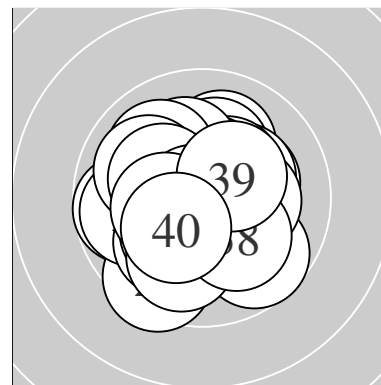

Serie 1:  
 10.0 ↗ 10.2 \* 10.2 \* 10.5 \* 10.5 \*  
 10.4 \* 10.6 \* 9.7 ↘ 10.6 \* 10.2 \*  
 beste Teiler 85.3 (9.) 98.3 (7.) 108.7 (5.)  
 Trefferlage 0.34 mm rechts, 0.24 mm hoch  
 Streuwert 1.30, horizontal: 1.11, vertikal: 1.47

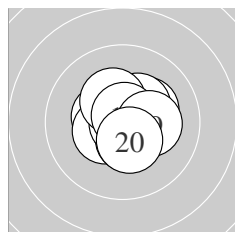

Serie 2:  
 10.2 \* 10.4 \* 10.4 \* 10.5 \* 10.4 \*  
 10.9 \* 10.3 \* 10.8 \* 10.2 \* 10.4 \*  
 beste Teiler 8.5 (16.) 46.5 (18.) 121.7 (14.)  
 Trefferlage 0.22 mm rechts, 0.10 mm hoch  
 Streuwert 0.98, horizontal: 1.05, vertikal: 0.90

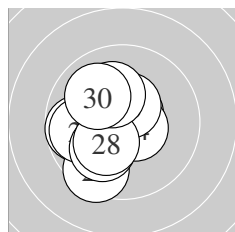

Serie 3:  
 9.7 ← 9.5 ↙ 10.6 \* 10.6 \* 10.5 \*  
 9.8 ← 10.1 ↙ 10.2 \* 10.2 \* 10.0 ↘  
 beste Teiler 77.8 (23.) 93.9 (24.) 116.6 (25.)  
 Trefferlage 1.06 mm links, 0.24 mm tief  
 Streuwert 1.48, horizontal: 1.33, vertikal: 1.61

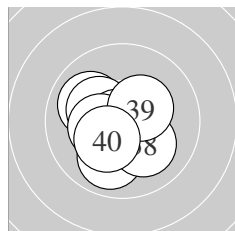

Serie 4:  
 10.0 ↘ 10.5 \* 10.2 \* 10.6 \* 9.9 ↙  
 10.8 \* 10.3 \* 10.1 ↘ 10.4 \* 10.3 \*  
 beste Teiler 32.9 (36.) 89.5 (34.) 125.6 (32.)  
 Trefferlage 0.52 mm links, 0.28 mm tief  
 Streuwert 1.20, horizontal: 1.27, vertikal: 1.13

Unterschrift des Schützen

Meyton Elektronik

Ergebnis: **409.5** (392)  
 Serien: 100.4 102.4 104.0 102.7  
 Zähler: 32 8 0 0 0 0 0 0 0 0  
 Innenzehner: 24  
 weiteste: 433 (3), 389 (22), 359 (5)  
 beste Teiler 48.7 (29.) 61.6 (25.) 68.9 (18.)  
 Trefferlage 0.02 mm rechts, 0.31 mm hoch  
 Streuwert 1.41, horizontal: 1.60, vertikal: 1.21

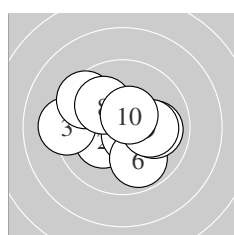
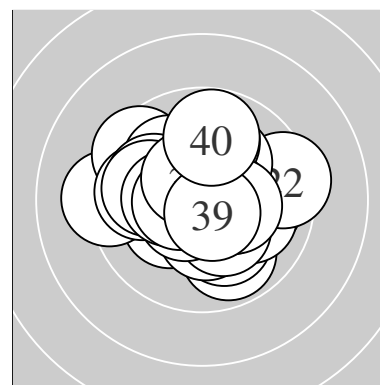

Serie 1:  
 10.4 \*                      10.2 \*                      9.2 ←                      10.6 \*                      9.5 ↘  
 9.9 ↘                      10.0 →                      10.0 ↖                      10.1 →                      10.5 \*  
 beste Teiler 82.7 (4.) 106.9 (10.) 131.6 (1.)  
 Trefferlage 0.22 mm links, 0.01 mm tief  
 Streuwert 1.84, horizontal: 2.23, vertikal: 1.34

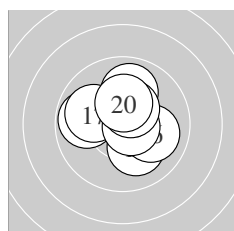

Serie 2:  
 10.5 \*                      9.9 ↑                      10.7 \*                      9.8 ←                      10.1 ↘  
 10.0 →                      10.0 ←                      10.7 \*                      10.4 \*                      10.3 \*  
 beste Teiler 68.9 (18.) 71.3 (13.) 110.2 (11.)  
 Trefferlage 0.01 mm rechts, 0.45 mm hoch  
 Streuwert 1.38, horizontal: 1.52, vertikal: 1.23

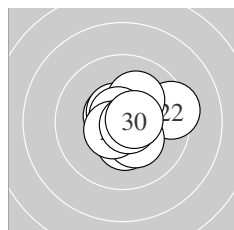

Serie 3:  
 10.6 \*                      9.4 →                      10.6 \*                      10.1 ↗                      10.7 \*  
 10.3 \*                      10.3 \*                      10.6 \*                      10.8 \*                      10.6 \*  
 beste Teiler 48.7 (29.) 61.6 (25.) 92.1 (30.)  
 Trefferlage 0.47 mm rechts, 0.09 mm hoch  
 Streuwert 1.20, horizontal: 1.37, vertikal: 1.02

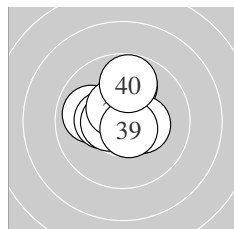

Serie 4:  
 10.4 \*                      10.0 ←                      10.4 \*                      9.9 ↑                      10.3 \*  
 10.3 \*                      10.5 \*                      10.5 \*                      10.6 \*                      9.8 ↑  
 beste Teiler 76.8 (39.) 103.3 (37.) 117.4 (38.)  
 Trefferlage 0.16 mm links, 0.73 mm hoch  
 Streuwert 1.25, horizontal: 1.25, vertikal: 1.25

Unterschrift des Schützen

Meyton Elektronik

Ergebnis: **410.0** (392)  
 Serien: 104.2 99.2 103.4 103.2  
 Zähler: 32 8 0 0 0 0 0 0 0 0  
 Innenzehner: 25  
 weiteste: 360 (16), 354 (12), 348 (14)  
 beste Teiler 10.8 (39.) 34.2 (28.) 73.8 (10.)  
 Trefferlage 0.01 mm rechts, 0.50 mm hoch  
 Streuwert 1.36, horizontal: 1.63, vertikal: 1.01

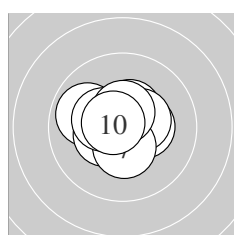
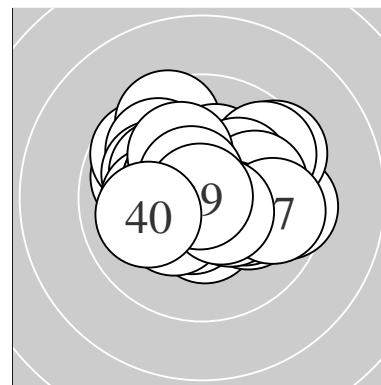

Serie 1:  
 10.6 \*                      10.4 \*                      9.9 ↖                      10.5 \*                      10.4 \*  
 10.4 \*                      10.4 \*                      10.4 \*                      10.5 \*                      10.7 \*  
 beste Teiler 73.8 (10.) 99.3 (1.) 106.0 (9.)  
 Trefferlage 0.20 mm links, 0.34 mm hoch  
 Streuwert 1.04, horizontal: 1.23, vertikal: 0.79

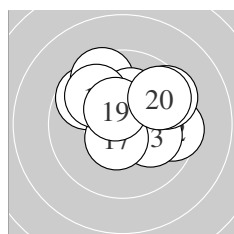

Serie 2:  
 9.7 ↖                      9.5 →                      10.1 ↘                      9.6 ↖                      10.2 \*  
 9.5 ↗                      10.5 \*                      9.9 ↖                      10.5 \*                      9.7 ↗  
 beste Teiler 107.9 (17.) 117.6 (19.) 182.7 (15.)  
 Trefferlage 0.49 mm rechts, 1.14 mm hoch  
 Streuwert 1.83, horizontal: 2.18, vertikal: 1.39

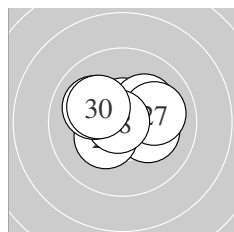

Serie 3:  
 10.6 \*                      10.6 \*                      10.2 \*                      10.6 \*                      10.2 \*  
 10.3 \*                      10.0 →                      10.8 \*                      10.0 ↖                      10.1 ↖  
 beste Teiler 34.2 (28.) 79.9 (22.) 88.0 (24.)  
 Trefferlage 0.06 mm rechts, 0.37 mm hoch  
 Streuwert 1.19, horizontal: 1.50, vertikal: 0.75

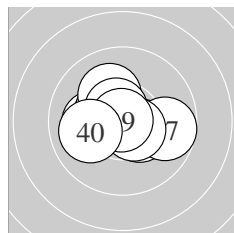

Serie 4:  
 10.1 ←                      10.4 \*                      10.4 \*                      10.4 \*                      10.1 ↖  
 10.6 \*                      9.7 →                      10.6 \*                      10.9 \*                      10.0 ←  
 beste Teiler 10.8 (39.) 92.2 (36.) 99.6 (38.)  
 Trefferlage 0.30 mm links, 0.14 mm hoch  
 Streuwert 1.28, horizontal: 1.61, vertikal: 0.84

Unterschrift des Schützen

Meyton Elektronik

Ergebnis: **415.5** (396)  
 Serien: 102.3 104.8 104.3 104.1  
 Zähler: 36 4 0 0 0 0 0 0 0 0  
 Innenzehner: 30  
 weiteste: 349 (22), 343 (32), 278 (14)  
 beste Teiler 27.0 (18.) 39.1 (27.) 40.0 (30.)  
 Trefferlage 0.10 mm links, 0.21 mm hoch  
 Streuwert 1.15, horizontal: 1.23, vertikal: 1.07

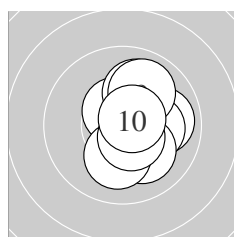
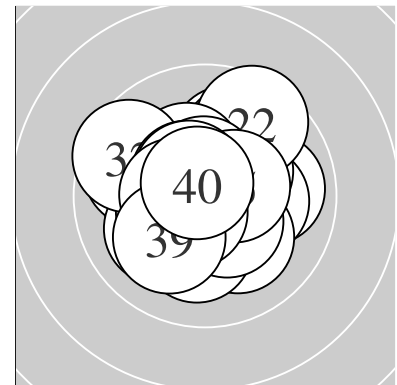

Serie 1:  
 10.2 \* 9.9 → 10.5 \* 10.2 \* 10.1 ↘  
 10.1 ↓ 10.6 \* 10.0 ↑ 10.0 ↑ 10.7 \*  
 beste Teiler 75.7 (10.) 97.4 (7.) 105.1 (3.)  
 Trefferlage 0.94 mm rechts, 0.00 mm  
 Streuwert 1.23, horizontal: 0.92, vertikal: 1.48

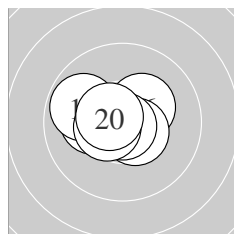

Serie 2:  
 10.2 \* 10.6 \* 10.7 \* 9.8 ↖ 10.8 \*  
 10.3 \* 10.5 \* 10.8 \* 10.5 \* 10.6 \*  
 beste Teiler 27.0 (18.) 43.4 (15.) 55.3 (13.)  
 Trefferlage 0.51 mm links, 0.13 mm hoch  
 Streuwert 0.93, horizontal: 1.20, vertikal: 0.55

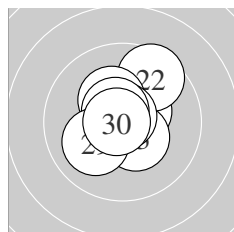

Serie 3:  
 10.4 \* 9.6 ↗ 10.4 \* 10.6 \* 10.3 \*  
 10.7 \* 10.8 \* 10.6 \* 10.1 ↙ 10.8 \*  
 beste Teiler 39.1 (27.) 40.0 (30.) 62.9 (26.)  
 Trefferlage 0.05 mm links, 0.52 mm hoch  
 Streuwert 1.13, horizontal: 1.05, vertikal: 1.20

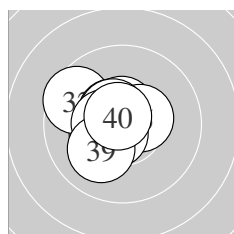

Serie 4:  
 10.4 \* 9.6 ↖ 10.5 \* 10.6 \* 10.5 \*  
 10.6 \* 10.6 \* 10.5 \* 10.1 ↙ 10.7 \*  
 beste Teiler 61.0 (40.) 85.1 (36.) 93.1 (34.)  
 Trefferlage 0.81 mm links, 0.20 mm hoch  
 Streuwert 1.02, horizontal: 1.08, vertikal: 0.95

Unterschrift des Schützen

Ergebnis: **411.4** (390)  
 Serien: 103.3 101.6 101.1 105.4  
 Zähler: 30 10 0 0 0 0 0 0 0 0  
 Innenzehner: 27  
 weiteste: 339 (25), 308 (18), 293 (27)  
 beste Teiler 11.3 (39.) 29.8 (5.) 30.0 (24.)  
 Trefferlage 0.16 mm links, 0.23 mm hoch  
 Streuwert 1.34, horizontal: 1.58, vertikal: 1.06

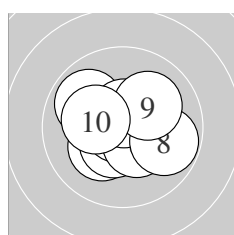
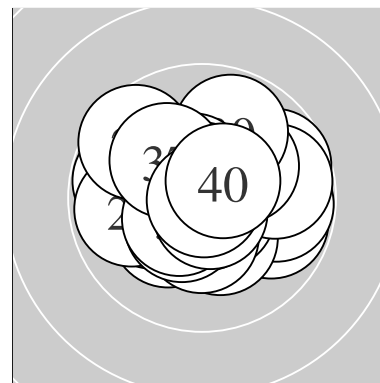

Serie 1:  
 10.8 \*                      10.2 \*                      9.9 ↖                      10.5 \*                      10.8 \*  
 10.4 \*                      10.6 \*                      9.8 →                      10.1 ↗                      10.2 \*  
 beste Teiler 29.8 (5.) 38.3 (1.) 90.4 (7.)  
 Trefferlage 0.07 mm links, 0.03 mm hoch  
 Streuwert 1.31, horizontal: 1.53, vertikal: 1.06

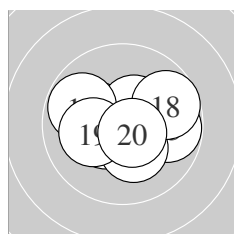

Serie 2:  
 10.3 \*                      10.4 \*                      9.8 →                      10.0 ↖                      10.5 \*  
 9.8 ↖                      10.3 \*                      9.7 ↗                      10.2 \*                      10.6 \*  
 beste Teiler 84.9 (20.) 121.2 (15.) 128.4 (12.)  
 Trefferlage 0.17 mm links, 0.08 mm hoch  
 Streuwert 1.58, horizontal: 2.03, vertikal: 0.93

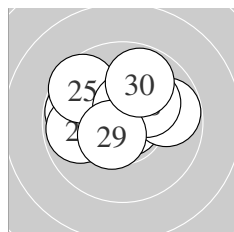

Serie 3:  
 9.8 ↖                      10.2 \*                      9.8 ←                      10.8 \*                      9.6 ↖  
 10.6 \*                      9.8 →                      10.2 \*                      10.5 \*                      9.8 ↗  
 beste Teiler 30.0 (24.) 100.2 (26.) 108.5 (29.)  
 Trefferlage 0.21 mm links, 0.88 mm hoch  
 Streuwert 1.60, horizontal: 1.97, vertikal: 1.11

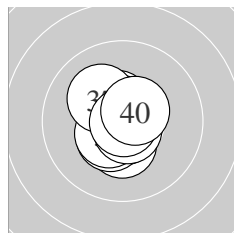

Serie 4:  
 10.4 \*                      10.7 \*                      10.4 \*                      10.5 \*                      10.5 \*  
 10.7 \*                      10.1 ↖                      10.7 \*                      10.9 \*                      10.5 \*  
 beste Teiler 11.3 (39.) 61.8 (32.) 62.7 (38.)  
 Trefferlage 0.22 mm links, 0.06 mm tief  
 Streuwert 0.84, horizontal: 0.65, vertikal: 0.99

Unterschrift des Schützen

Meyton Elektronik

Ergebnis: **414.0** (396)  
 Serien: 104.4 103.9 102.8 102.9  
 Zähler: 36 4 0 0 0 0 0 0 0 0  
 Innenzehner: 35  
 weiteste: 404 (28), 341 (38), 285 (35)  
 beste Teiler 19.3 (31.) 32.3 (5.) 53.2 (34.)  
 Trefferlage 0.13 mm links, 0.12 mm hoch  
 Streuwert 1.20, horizontal: 1.48, vertikal: 0.82

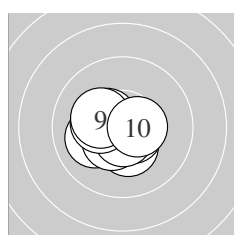
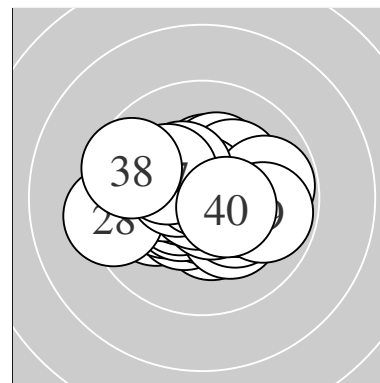

Serie 1:  
 10.1 ←                      10.4 \*                      10.6 \*                      10.4 \*                      10.8 \*  
 10.7 \*                      10.4 \*                      10.3 \*                      10.2 \*                      10.5 \*  
 beste Teiler 32.3 (5.) 70.1 (6.) 85.9 (3.)  
 Trefferlage 0.51 mm links, 0.30 mm tief  
 Streuwert 0.93, horizontal: 1.10, vertikal: 0.71

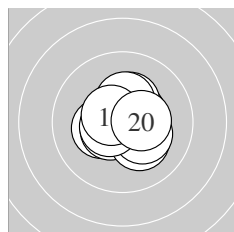

Serie 2:  
 10.3 \*                      10.5 \*                      10.2 \*                      10.5 \*                      10.3 \*  
 10.3 \*                      10.3 \*                      10.5 \*                      10.6 \*                      10.4 \*  
 beste Teiler 98.2 (19.) 102.1 (18.) 108.7 (12.)  
 Trefferlage 0.15 mm rechts, 0.06 mm hoch  
 Streuwert 1.06, horizontal: 1.14, vertikal: 0.96

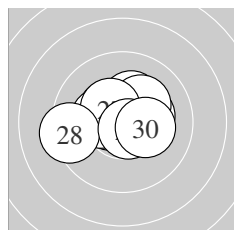

Serie 3:  
 10.6 \*                      10.4 \*                      10.3 \*                      10.3 \*                      10.2 \*  
 10.3 \*                      10.4 \*                      9.3 ←                      10.7 \*                      10.3 \*  
 beste Teiler 66.0 (29.) 85.9 (21.) 136.6 (27.)  
 Trefferlage 0.25 mm links, 0.39 mm hoch  
 Streuwert 1.38, horizontal: 1.77, vertikal: 0.80

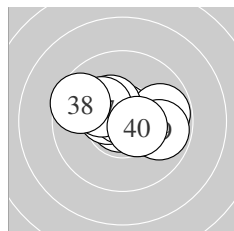

Serie 4:  
 10.9 \*                      10.5 \*                      10.5 \*                      10.7 \*                      9.8 →  
 10.4 \*                      10.2 \*                      9.6 ↖                      9.8 →                      10.5 \*  
 beste Teiler 19.3 (31.) 53.2 (34.) 116.4 (40.)  
 Trefferlage 0.08 mm rechts, 0.36 mm hoch  
 Streuwert 1.43, horizontal: 1.89, vertikal: 0.71

Unterschrift des Schützen

Meyton Elektronik

Ergebnis: **419.5** (400)  
 Serien: 103.8 105.9 105.5 104.3  
 Zähler: 40 0 0 0 0 0 0 0 0 0  
 Innenzehner: 35  
 weiteste: 250 (3), 249 (5), 239 (31)  
 beste Teiler 28.0 (22.) 31.9 (17.) 39.3 (9.)  
 Trefferlage 0.21 mm rechts, 0.04 mm tief  
 Streuwert 0.93, horizontal: 0.93, vertikal: 0.92

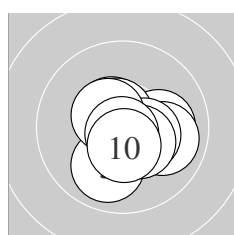
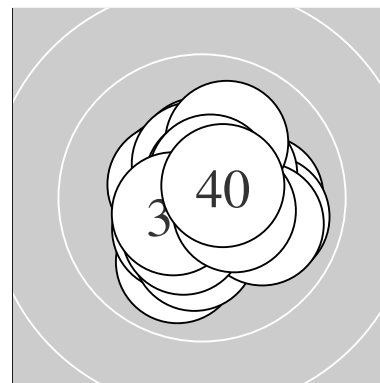

Serie 1:  
 10.5 \*                      10.1 →                      10.0 →                      10.6 \*                      10.0 ↙  
 10.4 \*                      10.5 \*                      10.4 \*                      10.8 \*                      10.5 \*  
 beste Teiler 39.3 (9.) 83.6 (4.) 106.5 (1.)  
 Trefferlage 0.40 mm rechts, 0.35 mm tief  
 Streuwert 1.12, horizontal: 1.24, vertikal: 0.99

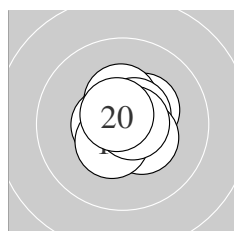

Serie 2:  
 10.4 \*                      10.4 \*                      10.8 \*                      10.6 \*                      10.4 \*  
 10.6 \*                      10.8 \*                      10.5 \*                      10.7 \*                      10.7 \*  
 beste Teiler 31.9 (17.) 49.4 (13.) 61.4 (19.)  
 Trefferlage 0.17 mm rechts, 0.21 mm hoch  
 Streuwert 0.74, horizontal: 0.74, vertikal: 0.74

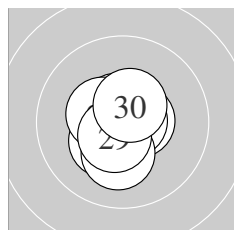

Serie 3:  
 10.7 \*                      10.8 \*                      10.6 \*                      10.8 \*                      10.3 \*  
 10.6 \*                      10.4 \*                      10.2 \*                      10.6 \*                      10.5 \*  
 beste Teiler 28.0 (22.) 48.6 (24.) 69.6 (21.)  
 Trefferlage 0.16 mm links, 0.20 mm tief  
 Streuwert 0.80, horizontal: 0.69, vertikal: 0.90

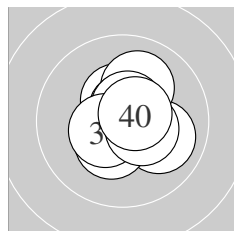

Serie 4:  
 10.0 →                      10.4 \*                      10.1 ↗                      10.6 \*                      10.7 \*  
 10.6 \*                      10.4 \*                      10.5 \*                      10.4 \*                      10.6 \*  
 beste Teiler 70.0 (35.) 81.6 (34.) 85.4 (36.)  
 Trefferlage 0.42 mm rechts, 0.18 mm hoch  
 Streuwert 1.00, horizontal: 0.96, vertikal: 1.04

Unterschrift des Schützen