

Ergebnis: **413.2** (393)
 Serien: 102.3 102.7 103.9 104.3
 Zähler: 33 7 0 0 0 0 0 0 0 0
 Innenzehner: 30
 weiteste: 321 (14), 311 (17), 296 (12)
 beste Teiler 31.2 (18.) 37.2 (26.) 61.0 (35.)
 Trefferlage 0.15 mm rechts, 0.27 mm hoch
 Streuwert 1.22, horizontal: 1.51, vertikal: 0.82

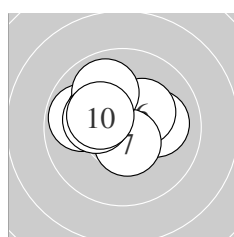

Serie 1:
 10.4 * 9.8 ← 10.6 * 10.1 → 10.2 *
 10.3 * 10.5 * 9.9 ↘ 10.2 * 10.3 *
 beste Teiler 76.8 (3.) 106.9 (7.) 132.7 (1.)
 Trefferlage 0.45 mm links, 0.68 mm hoch
 Streuwert 1.25, horizontal: 1.55, vertikal: 0.85

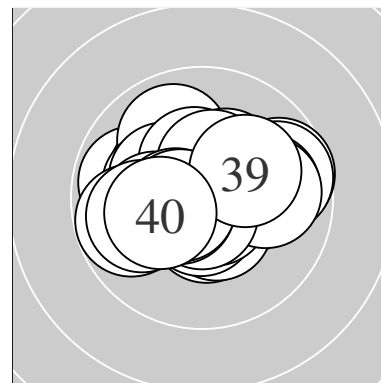
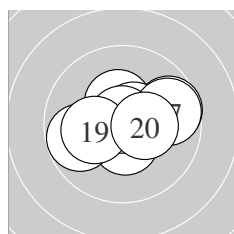

Serie 2:
 10.5 * 9.8 ← 10.6 * 9.7 → 10.4 *
 10.6 * 9.7 → 10.8 * 10.2 * 10.4 *
 beste Teiler 31.2 (18.) 84.8 (13.) 92.0 (16.)
 Trefferlage 0.40 mm rechts, 0.20 mm hoch
 Streuwert 1.45, horizontal: 1.87, vertikal: 0.83

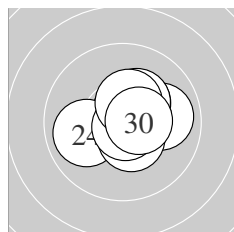

Serie 3:
 10.6 * 10.6 * 9.9 → 10.0 ← 10.5 *
 10.8 * 10.3 * 10.3 * 10.4 * 10.5 *
 beste Teiler 37.2 (26.) 79.9 (22.) 86.0 (21.)
 Trefferlage 0.50 mm rechts, 0.36 mm hoch
 Streuwert 1.05, horizontal: 1.21, vertikal: 0.86

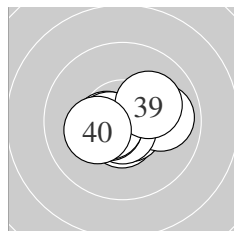

Serie 4:
 10.6 * 10.4 * 10.7 * 9.9 → 10.7 *
 10.6 * 10.5 * 10.6 * 10.1 ↗ 10.2 *
 beste Teiler 61.0 (35.) 66.4 (33.) 88.0 (31.)
 Trefferlage 0.16 mm rechts, 0.17 mm tief
 Streuwert 1.06, horizontal: 1.37, vertikal: 0.59

Unterschrift des Schützen

Meyton Elektronik

Ergebnis: **408.8** (392)
 Serien: 103.8 100.2 102.5 102.3
 Zähler: 32 8 0 0 0 0 0 0 0 0
 Innenzehner: 24
 weiteste: 380 (13), 378 (11), 332 (29)
 beste Teiler 18.6 (7.) 21.9 (24.) 44.0 (27.)
 Trefferlage 0.70 mm rechts, 0.35 mm tief
 Streuwert 1.33, horizontal: 1.39, vertikal: 1.26

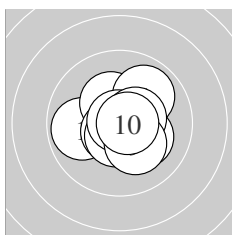
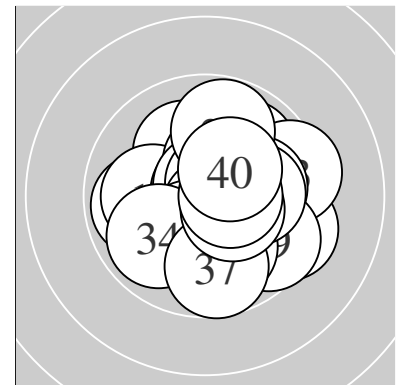

Serie 1:
 9.9 ← 10.3 * 10.2 * 9.9 ↗ 10.6 *
 10.6 * 10.9 * 10.5 * 10.2 * 10.7 *
 beste Teiler 18.6 (7.) 57.0 (10.) 82.0 (5.)
 Trefferlage 0.19 mm rechts, 0.04 mm tief
 Streuwert 1.22, horizontal: 1.34, vertikal: 1.08

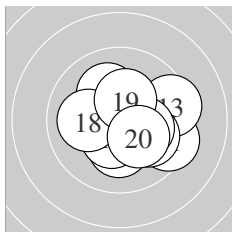

Serie 2:
 9.4 ↘ 10.1 ↖ 9.4 → 10.0 ↘ 10.2 *
 10.4 * 10.2 * 10.0 ← 10.3 * 10.2 *
 beste Teiler 135.1 (16.) 151.9 (19.) 179.3 (17.)
 Trefferlage 0.90 mm rechts, 0.30 mm tief
 Streuwert 1.65, horizontal: 1.92, vertikal: 1.33

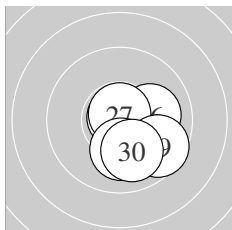

Serie 3:
 10.3 * 10.4 * 10.1 ↘ 10.9 * 10.2 *
 10.1 → 10.8 * 10.1 ↓ 9.6 ↘ 10.0 ↓
 beste Teiler 21.9 (24.) 44.0 (27.) 127.0 (22.)
 Trefferlage 1.21 mm rechts, 0.76 mm tief
 Streuwert 1.00, horizontal: 0.98, vertikal: 1.02

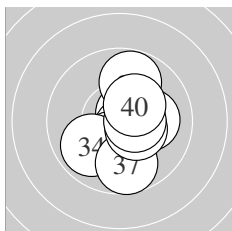

Serie 4:
 10.6 * 10.7 * 10.3 * 9.9 ↙ 9.8 ↑
 10.1 → 9.7 ↓ 10.4 * 10.5 * 10.3 *
 beste Teiler 66.4 (32.) 76.4 (31.) 110.0 (39.)
 Trefferlage 0.50 mm rechts, 0.28 mm tief
 Streuwert 1.40, horizontal: 1.12, vertikal: 1.63

Unterschrift des Schützen

Meyton Elektronik

Ergebnis: **414.7** (395)
 Serien: 105.0 103.7 102.4 103.6
 Zähler: 35 5 0 0 0 0 0 0 0 0
 Innenzehner: 31
 weiteste: 441 (23), 337 (30), 319 (33)
 beste Teiler 5.0 (34.) 12.2 (38.) 15.5 (5.)
 Trefferlage 0.03 mm links, 0.04 mm tief
 Streuwert 1.25, horizontal: 1.18, vertikal: 1.32

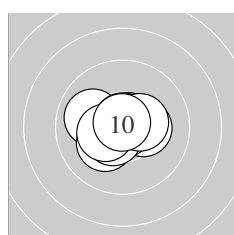
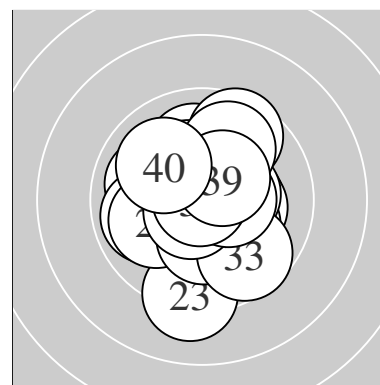

Serie 1:
 10.7 * 10.0 ← 10.2 * 10.3 * 10.9 *
 10.8 * 10.5 * 10.4 * 10.4 * 10.8 *
 beste Teiler 15.5 (5.) 37.4 (10.) 44.0 (6.)
 Trefferlage 0.23 mm links, 0.02 mm tief
 Streuwert 0.98, horizontal: 1.24, vertikal: 0.62

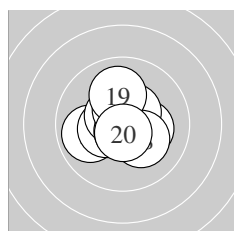

Serie 2:
 9.9 ← 10.4 * 10.2 * 10.6 * 10.7 *
 10.5 * 10.5 * 10.2 * 10.0 ↑ 10.7 *
 beste Teiler 53.0 (15.) 68.1 (20.) 100.5 (14.)
 Trefferlage 0.10 mm links, 0.11 mm hoch
 Streuwert 1.18, horizontal: 1.27, vertikal: 1.08

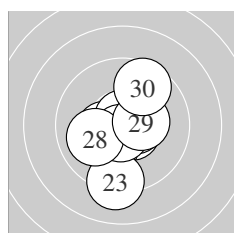

Serie 3:
 10.6 * 10.2 * 9.2 ↓ 10.6 * 10.4 *
 10.7 * 10.7 * 10.0 ← 10.4 * 9.6 ↗
 beste Teiler 52.0 (26.) 64.7 (27.) 86.6 (21.)
 Trefferlage 0.04 mm links, 0.46 mm tief
 Streuwert 1.57, horizontal: 1.24, vertikal: 1.84

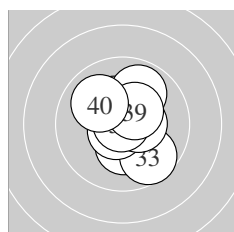

Serie 4:
 10.3 * 10.3 * 9.7 ↘ 10.9 * 10.7 *
 9.9 ↗ 10.5 * 10.9 * 10.4 * 10.0 ↖
 beste Teiler 5.0 (34.) 12.2 (38.) 73.5 (35.)
 Trefferlage 0.24 mm rechts, 0.18 mm hoch
 Streuwert 1.33, horizontal: 1.12, vertikal: 1.52

Unterschrift des Schützen

Meyton Elektronik

Ergebnis: **414.1** (398)
 Serien: 104.0 103.8 104.1 102.2
 Zähler: 38 2 0 0 0 0 0 0 0 0
 Innenzehner: 30
 weiteste: 356 (35), 269 (14), 244 (33)
 beste Teiler 42.0 (26.) 44.0 (29.) 45.7 (4.)
 Trefferlage 0.08 mm links, 0.18 mm hoch
 Streuwert 1.19, horizontal: 1.27, vertikal: 1.10

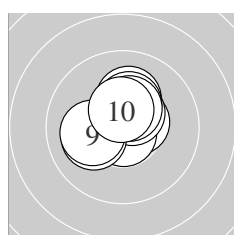
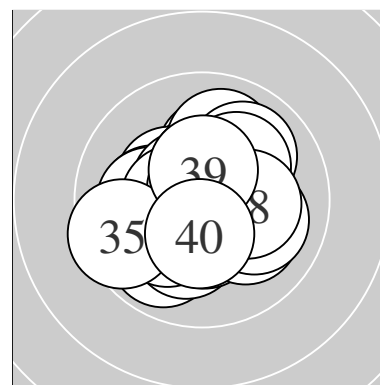

Serie 1:
 10.5 * 10.6 * 10.2 * 10.8 * 10.5 *
 10.3 * 10.1 ← 10.4 * 10.1 ← 10.5 *
 beste Teiler 45.7 (4.) 96.0 (2.) 104.0 (1.)
 Trefferlage 0.12 mm links, 0.67 mm hoch
 Streuwert 0.99, horizontal: 1.05, vertikal: 0.92

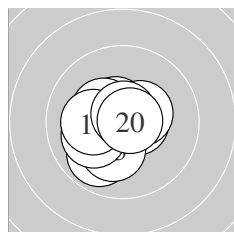

Serie 2:
 10.6 * 10.6 * 10.4 * 9.9 ↙ 10.2 *
 10.3 * 10.1 ← 10.2 * 10.7 * 10.8 *
 beste Teiler 50.9 (20.) 57.4 (19.) 93.0 (11.)
 Trefferlage 0.52 mm links, 0.20 mm tief
 Streuwert 1.13, horizontal: 1.18, vertikal: 1.08

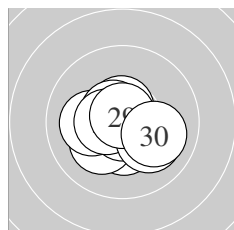

Serie 3:
 10.6 * 10.4 * 10.2 * 10.1 ← 10.6 *
 10.8 * 10.5 * 10.1 ↘ 10.8 * 10.0 ↘
 beste Teiler 42.0 (26.) 44.0 (29.) 90.5 (25.)
 Trefferlage 0.13 mm links, 0.32 mm tief
 Streuwert 1.11, horizontal: 1.32, vertikal: 0.85

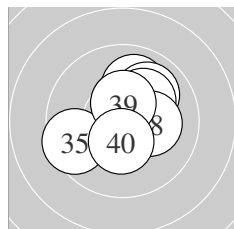

Serie 4:
 10.4 * 10.4 * 10.0 ↑ 10.6 * 9.5 ←
 10.0 ↗ 10.2 * 10.2 * 10.5 * 10.4 *
 beste Teiler 90.1 (34.) 123.1 (39.) 127.3 (32.)
 Trefferlage 0.45 mm rechts, 0.60 mm hoch
 Streuwert 1.38, horizontal: 1.49, vertikal: 1.27

Unterschrift des Schützen

Meyton Elektronik

Ergebnis: **409.2** (392)
 Serien: 103.6 101.6 102.7 101.3
 Zähler: 32 8 0 0 0 0 0 0 0 0
 Innenzehner: 26
 weiteste: 438 (39), 319 (24), 312 (12)
 beste Teiler 15.6 (21.) 41.4 (7.) 57.0 (3.)
 Trefferlage 0.09 mm links, 0.46 mm hoch
 Streuwert 1.39, horizontal: 1.62, vertikal: 1.11

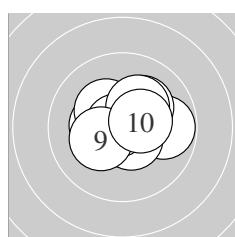
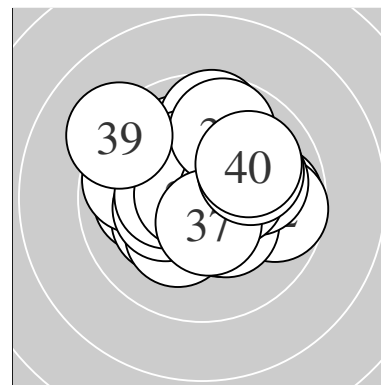

Serie 1:
 10.3 * 10.3 * 10.7 * 9.8 → 10.6 *
 10.2 * 10.8 * 10.2 * 10.3 * 10.4 *
 beste Teiler 41.4 (7.) 57.0 (3.) 99.0 (5.)
 Trefferlage 0.23 mm rechts, 0.25 mm hoch
 Streuwert 1.19, horizontal: 1.45, vertikal: 0.85

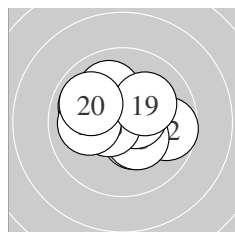

Serie 2:
 10.4 * 9.7 → 10.4 * 9.9 ↖ 10.6 *
 10.6 * 10.0 ↖ 10.0 ← 10.1 ↗ 9.9 ↖
 beste Teiler 95.8 (15.) 98.8 (16.) 134.0 (11.)
 Trefferlage 0.14 mm links, 0.32 mm hoch
 Streuwert 1.54, horizontal: 1.88, vertikal: 1.09

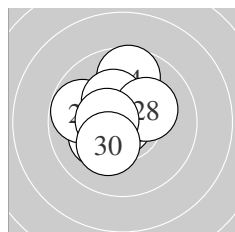

Serie 3:
 10.9 * 10.2 * 10.3 * 9.7 ↑ 9.8 ↖
 10.6 * 10.3 * 10.2 * 10.5 * 10.2 *
 beste Teiler 15.6 (21.) 89.8 (26.) 110.7 (29.)
 Trefferlage 0.64 mm links, 0.52 mm hoch
 Streuwert 1.29, horizontal: 1.28, vertikal: 1.29

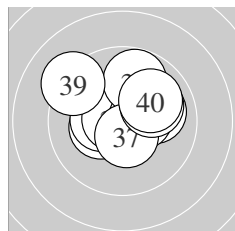

Serie 4:
 10.3 * 10.4 * 10.0 → 10.7 * 10.4 *
 9.8 ↑ 10.5 * 10.0 → 9.2 ↖ 10.0 ↗
 beste Teiler 64.7 (34.) 107.7 (37.) 128.8 (35.)
 Trefferlage 0.15 mm rechts, 0.76 mm hoch
 Streuwert 1.61, horizontal: 1.90, vertikal: 1.25

Unterschrift des Schützen

Meyton Elektronik

Ergebnis: **409.7** (389)
 Serien: 102.3 101.0 102.7 103.7
 Zähler: 29 11 0 0 0 0 0 0 0 0
 Innenzehner: 25
 weiteste: 350 (27), 335 (15), 335 (17)
 beste Teiler 37.0 (33.) 50.6 (26.) 63.5 (36.)
 Trefferlage 0.19 mm rechts, 0.08 mm hoch
 Streuwert 1.42, horizontal: 1.50, vertikal: 1.33

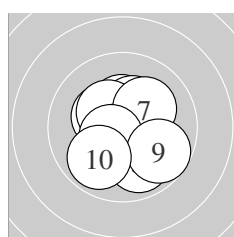
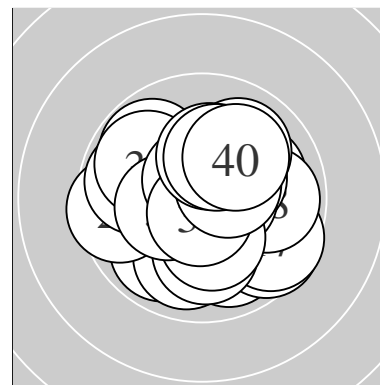

Serie 1:
 10.4 * 10.3 * 10.3 * 10.7 * 9.9 ↘
 10.4 * 10.2 * 10.5 * 9.7 ↘ 9.9 ↗
 beste Teiler 63.8 (4.) 105.2 (8.) 145.2 (1.)
 Trefferlage 0.15 mm rechts, 0.12 mm tief
 Streuwert 1.44, horizontal: 1.37, vertikal: 1.51

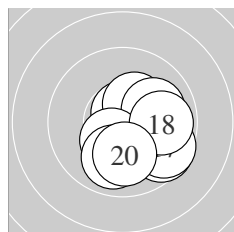

Serie 2:
 10.7 * 10.5 * 10.3 * 10.0 → 9.6 ↘
 10.4 * 9.6 ↘ 9.9 → 9.9 ↓ 10.1 ↓
 beste Teiler 65.0 (11.) 112.4 (12.) 147.6 (16.)
 Trefferlage 1.10 mm rechts, 0.64 mm tief
 Streuwert 1.42, horizontal: 1.43, vertikal: 1.42

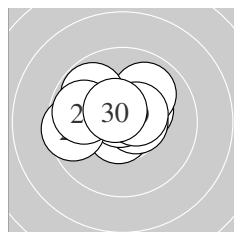

Serie 3:
 10.3 * 10.0 ↗ 10.7 * 10.6 * 9.8 ↖
 10.8 * 9.6 ← 9.8 ← 10.5 * 10.6 *
 beste Teiler 50.6 (26.) 72.6 (23.) 94.0 (24.)
 Trefferlage 0.45 mm links, 0.61 mm hoch
 Streuwert 1.39, horizontal: 1.76, vertikal: 0.87

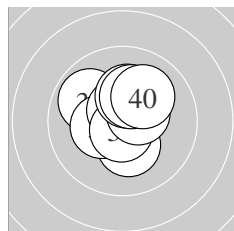

Serie 4:
 9.9 ↖ 10.3 * 10.8 * 10.4 * 10.6 *
 10.7 * 10.5 * 10.2 * 10.2 * 10.1 ↗
 beste Teiler 37.0 (33.) 63.5 (36.) 81.9 (35.)
 Trefferlage 0.02 mm links, 0.49 mm hoch
 Streuwert 1.16, horizontal: 1.12, vertikal: 1.20

Unterschrift des Schützen

Meyton Elektronik

Ergebnis: **415.3** (396)
 Serien: 103.8 102.9 103.5 105.1
 Zähler: 36 4 0 0 0 0 0 0 0 0
 Innenzehner: 30
 weiteste: 353 (18), 345 (1), 289 (28)
 beste Teiler 14.3 (27.) 19.2 (33.) 32.6 (39.)
 Trefferlage 0.03 mm rechts, 0.15 mm hoch
 Streuwert 1.15, horizontal: 1.28, vertikal: 1.01

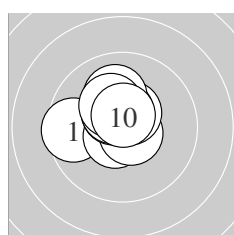
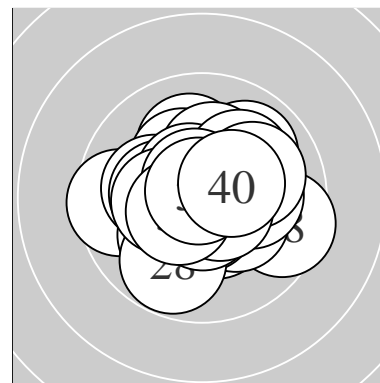

Serie 1:
 9.6 ← 10.6 * 10.7 * 10.5 * 10.5 *
 10.5 * 10.4 * 10.1 ↑ 10.3 * 10.6 *
 beste Teiler 71.6 (3.) 81.6 (2.) 84.0 (10.)
 Trefferlage 0.55 mm links, 0.73 mm hoch
 Streuwert 1.01, horizontal: 1.13, vertikal: 0.88

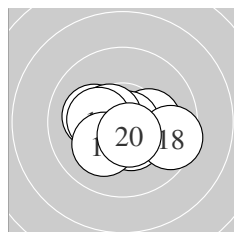

Serie 2:
 10.4 * 10.2 * 10.8 * 10.1 ← 10.5 *
 10.5 * 10.3 * 9.5 → 10.1 ↙ 10.5 *
 beste Teiler 33.7 (13.) 101.0 (20.) 101.1 (16.)
 Trefferlage 0.00 mm , 0.44 mm tief
 Streuwert 1.29, horizontal: 1.68, vertikal: 0.73

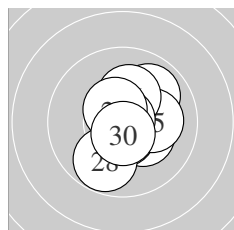

Serie 3:
 10.3 * 9.9 ↗ 10.6 * 10.6 * 10.1 →
 10.2 * 10.9 * 9.8 ↘ 10.5 * 10.6 *
 beste Teiler 14.3 (27.) 77.4 (24.) 80.0 (30.)
 Trefferlage 0.47 mm rechts, 0.00 mm
 Streuwert 1.20, horizontal: 1.03, vertikal: 1.35

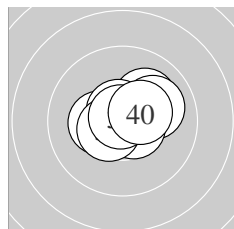

Serie 4:
 10.1 ↗ 10.3 * 10.9 * 10.0 → 10.8 *
 10.7 * 10.6 * 10.5 * 10.8 * 10.4 *
 beste Teiler 19.2 (33.) 32.6 (39.) 49.7 (35.)
 Trefferlage 0.24 mm rechts, 0.31 mm hoch
 Streuwert 0.93, horizontal: 1.15, vertikal: 0.64

Unterschrift des Schützen

Meyton Elektronik

Ergebnis: **416.6** (396)
 Serien: 102.4 104.2 105.1 104.9
 Zähler: 36 4 0 0 0 0 0 0 0 0
 Innenzehner: 31
 weiteste: 291 (31), 278 (6), 277 (7)
 beste Teiler 37.1 (17.) 40.4 (22.) 42.0 (33.)
 Trefferlage 0.27 mm rechts, 0.07 mm hoch
 Streuwert 1.09, horizontal: 1.24, vertikal: 0.91

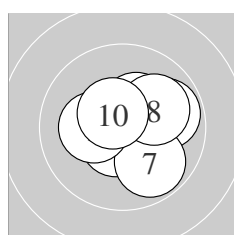
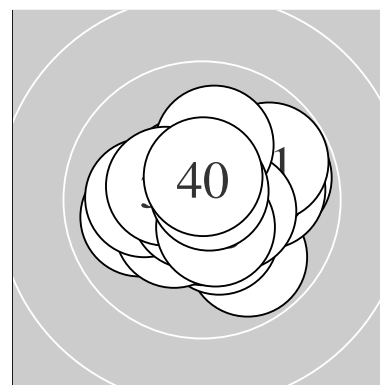

Serie 1:
 10.6 * 10.5 * 9.9 → 10.7 * 10.4 *
 9.8 → 9.8 ↘ 10.0 → 10.2 * 10.5 *
 beste Teiler 63.1 (4.) 97.9 (1.) 106.8 (10.)
 Trefferlage 0.75 mm rechts, 0.34 mm hoch
 Streuwert 1.29, horizontal: 1.47, vertikal: 1.08

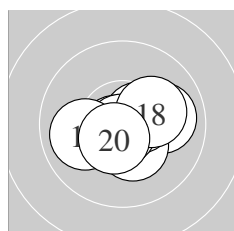

Serie 2:
 10.6 * 10.5 * 10.0 → 10.4 * 10.5 *
 10.7 * 10.8 * 10.2 * 10.0 ← 10.5 *
 beste Teiler 37.1 (17.) 60.1 (16.) 78.2 (11.)
 Trefferlage 0.19 mm rechts, 0.34 mm tief
 Streuwert 1.08, horizontal: 1.38, vertikal: 0.66

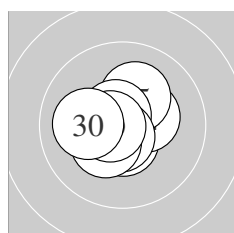

Serie 3:
 10.8 * 10.8 * 10.6 * 10.4 * 10.2 *
 10.6 * 10.7 * 10.3 * 10.6 * 10.1 ←
 beste Teiler 40.4 (22.) 47.3 (21.) 75.9 (27.)
 Trefferlage 0.20 mm links, 0.04 mm hoch
 Streuwert 0.93, horizontal: 1.00, vertikal: 0.85

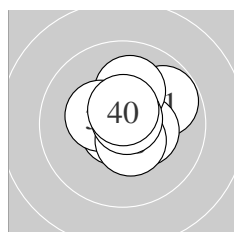

Serie 4:
 9.8 → 10.8 * 10.8 * 10.7 * 10.4 *
 10.1 ↑ 10.4 * 10.5 * 10.8 * 10.6 *
 beste Teiler 42.0 (33.) 42.6 (39.) 47.2 (32.)
 Trefferlage 0.34 mm rechts, 0.25 mm hoch
 Streuwert 1.01, horizontal: 1.04, vertikal: 0.98

Unterschrift des Schützen

Meyton Elektronik

Ergebnis: **416.0** (399)
 Serien: 102.7 104.2 104.7 104.4
 Zähler: 39 1 0 0 0 0 0 0 0 0
 Innenzehner: 32
 weiteste: 375 (8), 242 (32), 225 (3)
 beste Teiler 6.0 (7.) 51.2 (35.) 54.0 (29.)
 Trefferlage 0.12 mm rechts, 0.28 mm hoch
 Streuwert 1.07, horizontal: 0.99, vertikal: 1.13

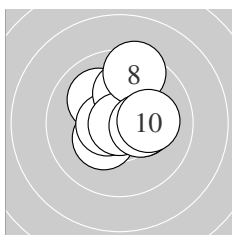
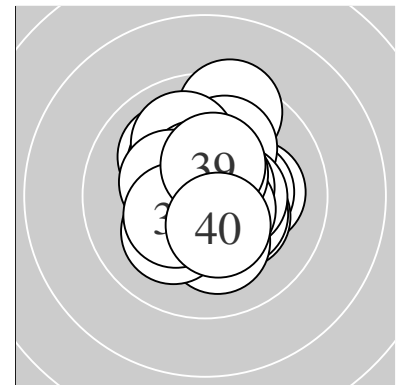

Serie 1:
 10.3 * 10.4 * 10.1 ↘ 10.6 * 10.1 ↑
 10.3 * 10.9 * 9.5 ↑ 10.4 * 10.1 →
 beste Teiler 6.0 (7.) 88.4 (4.) 142.4 (2.)
 Trefferlage 0.20 mm rechts, 0.70 mm hoch
 Streuwert 1.35, horizontal: 1.29, vertikal: 1.40

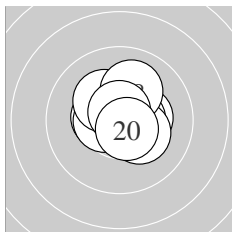

Serie 2:
 10.5 * 10.5 * 10.4 * 10.3 * 10.5 *
 10.3 * 10.3 * 10.1 ↑ 10.7 * 10.6 *
 beste Teiler 58.0 (19.) 81.6 (20.) 105.0 (15.)
 Trefferlage 0.14 mm rechts, 0.40 mm hoch
 Streuwert 1.00, horizontal: 1.08, vertikal: 0.91

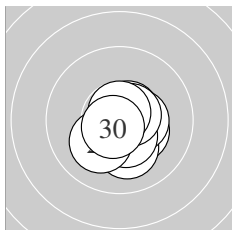

Serie 3:
 10.7 * 10.6 * 10.3 * 10.1 ↓ 10.4 *
 10.5 * 10.1 ↙ 10.6 * 10.7 * 10.7 *
 beste Teiler 54.0 (29.) 54.7 (21.) 68.5 (30.)
 Trefferlage 0.35 mm rechts, 0.42 mm tief
 Streuwert 0.85, horizontal: 0.80, vertikal: 0.90

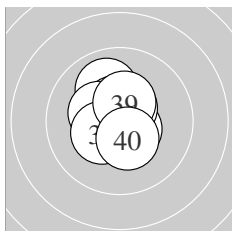

Serie 4:
 10.6 * 10.0 ↘ 10.6 * 10.5 * 10.7 *
 10.5 * 10.3 * 10.4 * 10.4 * 10.4 *
 beste Teiler 51.2 (35.) 90.0 (31.) 96.6 (33.)
 Trefferlage 0.21 mm links, 0.47 mm hoch
 Streuwert 0.94, horizontal: 0.78, vertikal: 1.07

Unterschrift des Schützen

Meyton Elektronik

Ergebnis: **402.0** (386)
 Serien: 101.4 100.6 99.7 100.3
 Zähler: 26 14 0 0 0 0 0 0 0 0
 Innenzehner: 20
 weiteste: 429 (12), 420 (27), 407 (24)
 beste Teiler 51.6 (23.) 74.2 (18.) 74.6 (7.)
 Trefferlage 0.29 mm rechts, 0.19 mm hoch
 Streuwert 1.74, horizontal: 2.23, vertikal: 1.06

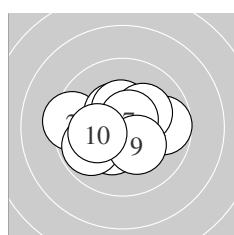
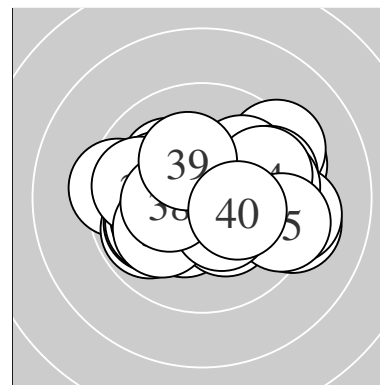

Serie 1:
 9.7 → 9.4 ← 10.3 * 10.4 * 10.4 *
 10.2 * 10.7 * 9.8 ↙ 10.3 * 10.2 *
 beste Teiler 74.6 (7.) 131.2 (4.) 135.7 (5.)
 Trefferlage 0.36 mm links, 0.01 mm hoch
 Streuwert 1.63, horizontal: 2.03, vertikal: 1.09

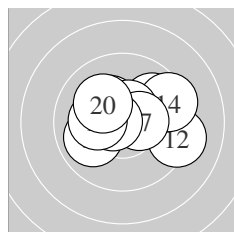

Serie 2:
 9.9 ↙ 9.2 → 9.9 ↗ 9.4 → 10.3 *
 10.5 * 10.4 * 10.7 * 10.2 * 10.1 ↘
 beste Teiler 74.2 (18.) 105.1 (16.) 128.3 (17.)
 Trefferlage 0.41 mm rechts, 0.46 mm hoch
 Streuwert 1.77, horizontal: 2.28, vertikal: 1.04

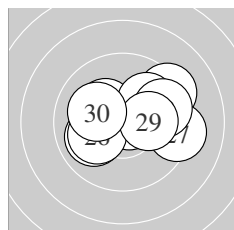

Serie 3:
 10.3 * 10.0 ↙ 10.7 * 9.3 ↗ 10.0 ↗
 10.1 ↙ 9.3 → 9.7 → 10.2 * 10.1 ↖
 beste Teiler 51.6 (23.) 168.3 (21.) 198.1 (29.)
 Trefferlage 0.75 mm rechts, 0.40 mm hoch
 Streuwert 1.90, horizontal: 2.45, vertikal: 1.12

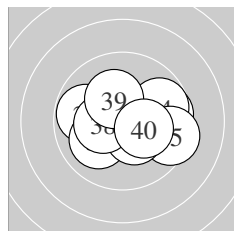

Serie 4:
 9.8 ↖ 9.7 → 10.3 * 9.8 → 9.4 →
 10.0 ↙ 10.4 * 10.4 * 10.2 * 10.3 *
 beste Teiler 141.3 (37.) 149.4 (38.) 168.3 (33.)
 Trefferlage 0.38 mm rechts, 0.12 mm tief
 Streuwert 1.80, horizontal: 2.34, vertikal: 1.03

Unterschrift des Schützen

Meyton Elektronik

Ergebnis: **417.8** (398)
 Serien: 103.9 103.6 103.8 106.5
 Zähler: 38 2 0 0 0 0 0 0 0 0
 Innenzehner: 35
 weiteste: 303 (13), 255 (29), 249 (7)
 beste Teiler 5.0 (32.) 7.8 (21.) 8.0 (40.)
 Trefferlage 0.23 mm rechts, 0.12 mm tief
 Streuwert 1.03, horizontal: 1.31, vertikal: 0.61

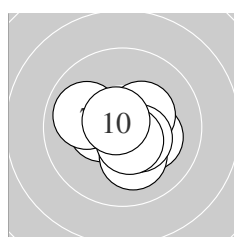
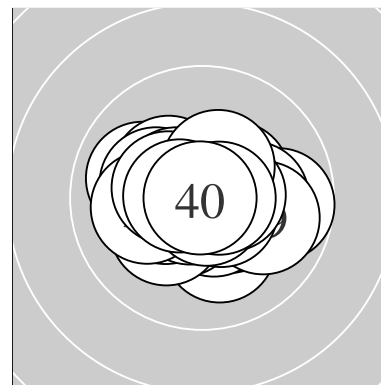

Serie 1:
 10.4 * 10.5 * 10.2 * 10.6 * 10.1 ↘
 10.4 * 10.0 ← 10.4 * 10.6 * 10.7 *
 beste Teiler 60.8 (10.) 84.5 (4.) 99.7 (9.)
 Trefferlage 0.30 mm rechts, 0.27 mm tief
 Streuwert 1.09, horizontal: 1.30, vertikal: 0.83

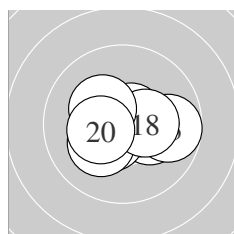

Serie 2:
 10.2 * 10.6 * 9.7 → 10.6 * 10.5 *
 10.2 * 10.7 * 10.4 * 10.3 * 10.4 *
 beste Teiler 72.2 (17.) 86.3 (14.) 100.3 (12.)
 Trefferlage 0.21 mm rechts, 0.19 mm tief
 Streuwert 1.21, horizontal: 1.58, vertikal: 0.65

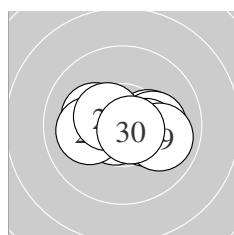

Serie 3:
 10.9 * 10.3 * 10.2 * 10.7 * 10.2 *
 10.3 * 10.1 ← 10.5 * 9.9 → 10.7 *
 beste Teiler 7.8 (21.) 62.4 (24.) 62.7 (30.)
 Trefferlage 0.26 mm rechts, 0.12 mm tief
 Streuwert 1.20, horizontal: 1.63, vertikal: 0.44

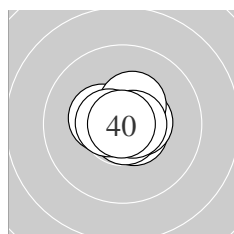

Serie 4:
 10.7 * 10.9 * 10.4 * 10.6 * 10.5 *
 10.8 * 10.4 * 10.7 * 10.6 * 10.9 *
 beste Teiler 5.0 (32.) 8.0 (40.) 48.4 (36.)
 Trefferlage 0.15 mm rechts, 0.10 mm hoch
 Streuwert 0.64, horizontal: 0.77, vertikal: 0.48

Unterschrift des Schützen

Ergebnis: **414.9** (395)
 Serien: 103.7 104.5 102.4 104.3
 Zähler: 36 3 1 0 0 0 0 0 0 0
 Innenzehner: 32
 weiteste: 529 (28), 291 (29), 284 (5)
 beste Teiler 21.9 (33.) 36.4 (19.) 46.6 (14.)
 Trefferlage 0.17 mm rechts, 0.15 mm tief
 Streuwert 1.21, horizontal: 1.22, vertikal: 1.21

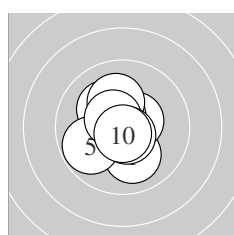
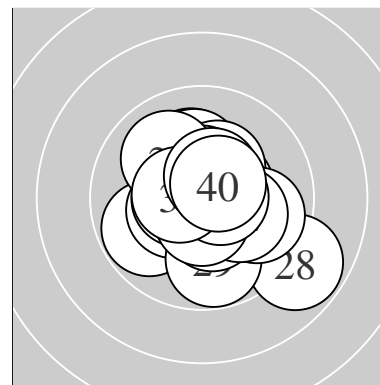

Serie 1:
 10.0 ↘ 10.5 * 10.5 * 10.2 * 9.8 ↙
 10.6 * 10.1 ↗ 10.6 * 10.7 * 10.7 *
 beste Teiler 51.0 (10.) 72.4 (9.) 98.8 (6.)
 Trefferlage 0.44 mm links, 0.07 mm hoch
 Streuwert 1.16, horizontal: 1.03, vertikal: 1.27

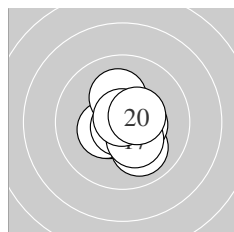

Serie 2:
 10.5 * 10.4 * 10.0 ↘ 10.8 * 10.4 *
 10.6 * 10.3 * 10.2 * 10.8 * 10.5 *
 beste Teiler 36.4 (19.) 46.6 (14.) 90.0 (16.)
 Trefferlage 0.23 mm rechts, 0.27 mm tief
 Streuwert 1.02, horizontal: 0.98, vertikal: 1.05

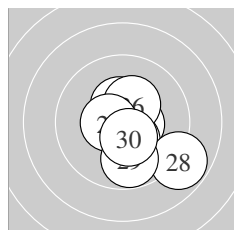

Serie 3:
 10.7 * 10.5 * 10.7 * 10.3 * 10.4 *
 10.3 * 10.5 * 8.8 ↘ 9.8 ↓ 10.4 *
 beste Teiler 53.7 (21.) 56.1 (23.) 104.3 (22.)
 Trefferlage 0.55 mm rechts, 0.64 mm tief
 Streuwert 1.50, horizontal: 1.50, vertikal: 1.50

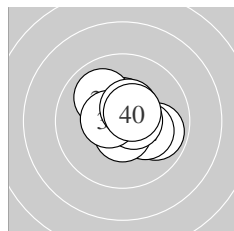

Serie 4:
 9.9 ↗ 10.2 * 10.9 * 10.6 * 10.5 *
 10.0 ↘ 10.6 * 10.5 * 10.5 * 10.6 *
 beste Teiler 21.9 (33.) 87.0 (37.) 94.0 (34.)
 Trefferlage 0.36 mm rechts, 0.21 mm hoch
 Streuwert 1.09, horizontal: 1.22, vertikal: 0.94

Unterschrift des Schützen

Ergebnis: **406.8** (388)
 Serien: 101.3 102.0 101.0 102.5
 Zähler: 28 12 0 0 0 0 0 0 0 0
 Innenzehner: 24
 weiteste: 445 (4), 415 (21), 364 (27)
 beste Teiler 37.4 (31.) 49.6 (14.) 51.8 (29.)
 Trefferlage 0.47 mm links, 0.16 mm hoch
 Streuwert 1.54, horizontal: 1.91, vertikal: 1.04

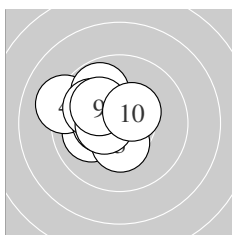
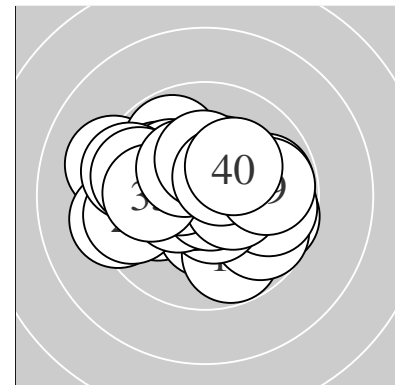

Serie 1:
 10.6 * 10.0 ← 10.3 * 9.2 ↖ 10.4 *
 9.8 ↘ 10.0 ↖ 10.5 * 10.1 ↖ 10.4 *
 beste Teiler 94.5 (1.) 117.7 (8.) 128.0 (10.)
 Trefferlage 1.34 mm links, 0.39 mm hoch
 Streuwert 1.33, horizontal: 1.41, vertikal: 1.24

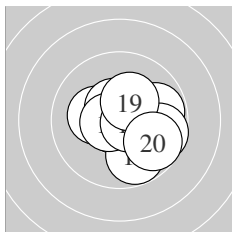

Serie 2:
 9.8 → 10.2 * 10.5 * 10.8 * 9.7 →
 9.8 ↓ 10.6 * 10.6 * 10.3 * 9.7 ↘
 beste Teiler 49.6 (14.) 78.8 (18.) 82.5 (17.)
 Trefferlage 0.76 mm rechts, 0.25 mm tief
 Streuwert 1.45, horizontal: 1.64, vertikal: 1.24

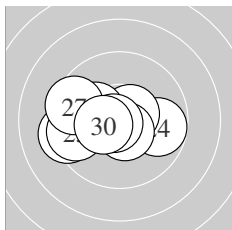

Serie 3:
 9.3 ← 10.3 * 9.6 ← 9.8 → 10.6 *
 10.2 * 9.5 ← 10.6 * 10.7 * 10.4 *
 beste Teiler 51.8 (29.) 94.1 (25.) 96.1 (28.)
 Trefferlage 1.18 mm links, 0.13 mm tief
 Streuwert 1.62, horizontal: 2.17, vertikal: 0.75

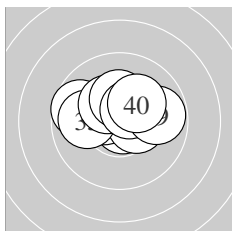

Serie 4:
 10.8 * 10.5 * 9.7 ↖ 10.4 * 10.0 ←
 10.3 * 10.3 * 10.5 * 9.8 → 10.2 *
 beste Teiler 37.4 (31.) 114.9 (38.) 123.7 (32.)
 Trefferlage 0.12 mm links, 0.66 mm hoch
 Streuwert 1.36, horizontal: 1.81, vertikal: 0.67

Unterschrift des Schützen

Meyton Elektronik

Ergebnis: **411.4** (394)
 Serien: 102.4 103.3 104.2 101.5
 Zähler: 34 6 0 0 0 0 0 0 0 0
 Innenzehner: 31
 weiteste: 463 (40), 428 (5), 312 (28)
 beste Teiler 12.0 (23.) 43.5 (14.) 50.4 (25.)
 Trefferlage 0.24 mm links, 0.00 mm
 Streuwert 1.36, horizontal: 1.65, vertikal: 0.99

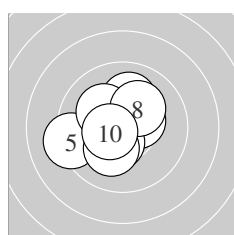
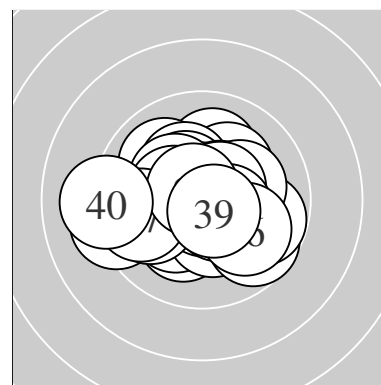

Serie 1:
 10.6 * 10.6 * 10.4 * 10.1 ↑ 9.2 ←
 10.4 * 10.2 * 10.2 * 10.2 * 10.5 *
 beste Teiler 79.3 (2.) 98.8 (1.) 109.4 (10.)
 Trefferlage 0.48 mm links, 0.09 mm hoch
 Streuwert 1.46, horizontal: 1.62, vertikal: 1.29

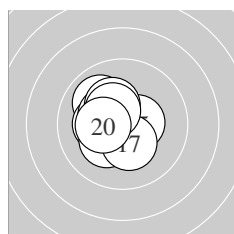

Serie 2:
 10.0 ↘ 10.2 * 10.2 * 10.8 * 10.5 *
 10.3 * 10.3 * 10.3 * 10.4 * 10.3 *
 beste Teiler 43.5 (14.) 116.6 (15.) 134.4 (19.)
 Trefferlage 0.76 mm links, 0.27 mm hoch
 Streuwert 1.04, horizontal: 1.02, vertikal: 1.06

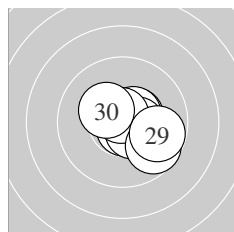

Serie 3:
 10.5 * 10.5 * 10.9 * 10.5 * 10.8 *
 10.5 * 10.7 * 9.7 ↘ 9.8 → 10.3 *
 beste Teiler 12.0 (23.) 50.4 (25.) 55.5 (27.)
 Trefferlage 0.79 mm rechts, 0.16 mm tief
 Streuwert 1.06, horizontal: 1.21, vertikal: 0.88

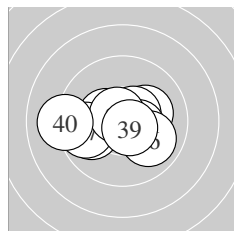

Serie 4:
 9.9 ← 10.2 * 10.5 * 10.4 * 10.4 *
 10.0 ↘ 9.7 ← 10.7 * 10.6 * 9.1 ←
 beste Teiler 65.1 (38.) 78.5 (39.) 101.7 (33.)
 Trefferlage 0.53 mm links, 0.21 mm tief
 Streuwert 1.67, horizontal: 2.25, vertikal: 0.70

Unterschrift des Schützen

Meyton Elektronik

Ergebnis: **413.3** (393)
 Serien: 101.4 103.4 105.4 103.1
 Zähler: 33 7 0 0 0 0 0 0 0 0
 Innenzehner: 30
 weiteste: 400 (7), 362 (9), 291 (13)
 beste Teiler 12.0 (23.) 27.2 (24.) 31.0 (27.)
 Trefferlage 0.26 mm links, 0.18 mm hoch
 Streuwert 1.27, horizontal: 1.36, vertikal: 1.17

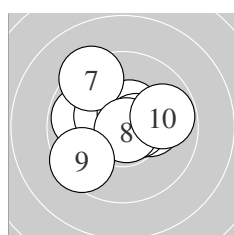
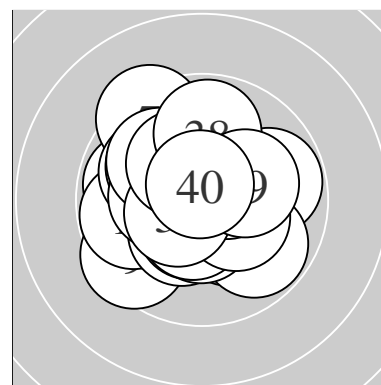

Serie 1:
 9.8 ← 10.4 * 10.4 * 10.2 * 10.5 *
 10.6 * 9.4 ↘ 10.8 * 9.5 ↙ 9.8 →
 beste Teiler 34.2 (8.) 96.4 (6.) 113.6 (5.)
 Trefferlage 0.34 mm links, 0.54 mm hoch
 Streuwert 1.68, horizontal: 1.92, vertikal: 1.39

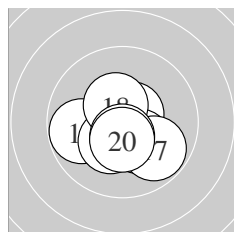

Serie 2:
 10.3 * 10.8 * 9.8 ← 10.6 * 10.3 *
 10.3 * 9.8 ↘ 10.4 * 10.6 * 10.5 *
 beste Teiler 46.2 (12.) 82.8 (14.) 99.0 (19.)
 Trefferlage 0.15 mm links, 0.69 mm tief
 Streuwert 1.17, horizontal: 1.37, vertikal: 0.92

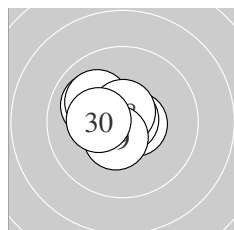

Serie 3:
 10.7 * 10.0 ↘ 10.9 * 10.8 * 10.6 *
 10.1 ↘ 10.8 * 10.7 * 10.5 * 10.3 *
 beste Teiler 12.0 (23.) 27.2 (24.) 31.0 (27.)
 Trefferlage 0.55 mm links, 0.23 mm hoch
 Streuwert 0.85, horizontal: 0.97, vertikal: 0.71

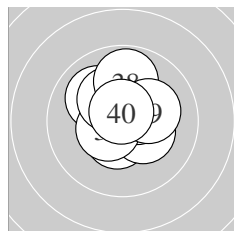

Serie 4:
 10.0 ↘ 10.5 * 10.3 * 10.5 * 10.4 *
 10.5 * 10.2 * 9.8 ↑ 10.2 * 10.7 *
 beste Teiler 65.6 (40.) 113.1 (36.) 114.1 (32.)
 Trefferlage 0.01 mm links, 0.67 mm hoch
 Streuwert 1.16, horizontal: 1.13, vertikal: 1.18

Unterschrift des Schützen

Meyton Elektronik

Ergebnis: **414.4** (393)
 Serien: 101.0 104.4 105.3 103.7
 Zähler: 33 7 0 0 0 0 0 0 0 0
 Innenzehner: 30
 weiteste: 356 (32), 328 (10), 313 (12)
 beste Teiler 3.6 (33.) 20.2 (22.) 46.5 (15.)
 Trefferlage 0.05 mm links, 0.02 mm tief
 Streuwert 1.24, horizontal: 1.45, vertikal: 0.99

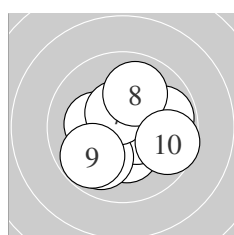
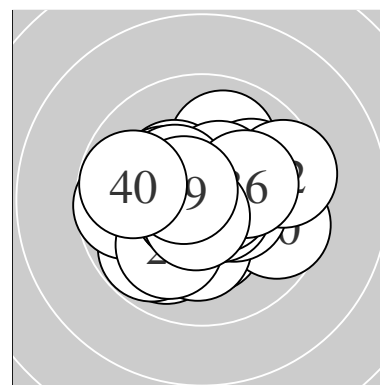

Serie 1:
 10.4 * 9.8 → 10.3 * 10.5 * 10.2 *
 9.9 ↙ 10.5 * 10.0 ↑ 9.8 ↙ 9.6 →
 beste Teiler 103.7 (4.) 106.9 (7.) 136.4 (1.)
 Trefferlage 0.14 mm rechts, 0.40 mm tief
 Streuwert 1.63, horizontal: 1.81, vertikal: 1.44

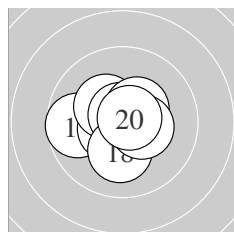

Serie 2:
 10.6 * 9.7 ← 10.6 * 10.3 * 10.8 *
 10.7 * 10.4 * 10.2 * 10.4 * 10.7 *
 beste Teiler 46.5 (15.) 53.4 (16.) 56.6 (20.)
 Trefferlage 0.31 mm links, 0.01 mm tief
 Streuwert 1.09, horizontal: 1.27, vertikal: 0.87

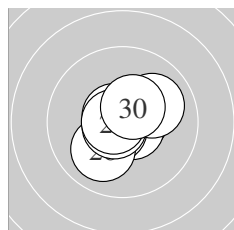

Serie 3:
 10.6 * 10.9 * 10.7 * 10.7 * 10.6 *
 10.0 ↙ 10.7 * 10.7 * 10.0 → 10.4 *
 beste Teiler 20.2 (22.) 62.0 (28.) 64.8 (27.)
 Trefferlage 0.06 mm rechts, 0.04 mm tief
 Streuwert 0.94, horizontal: 1.01, vertikal: 0.86

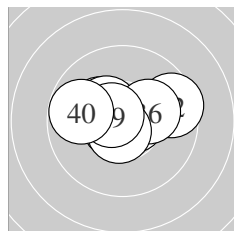

Serie 4:
 10.2 * 9.5 → 10.9 * 10.4 * 10.7 *
 10.2 * 10.7 * 10.7 * 10.6 * 9.8 ←
 beste Teiler 3.6 (33.) 64.8 (37.) 71.1 (35.)
 Trefferlage 0.12 mm links, 0.35 mm hoch
 Streuwert 1.31, horizontal: 1.76, vertikal: 0.58

Unterschrift des Schützen

Meyton Elektronik

Ergebnis: **402.4** (380)
 Serien: 100.4 98.3 100.5 103.2
 Zähler: 23 14 3 0 0 0 0 0 0 0
 Innenzehner: 20
 weiteste: 610 (30), 554 (9), 518 (13)
 beste Teiler 25.4 (31.) 52.8 (37.) 64.0 (28.)
 Trefferlage 0.07 mm links, 0.11 mm hoch
 Streuwert 1.86, horizontal: 2.01, vertikal: 1.71

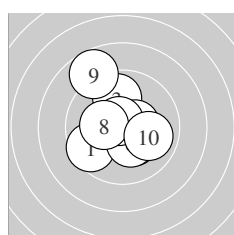
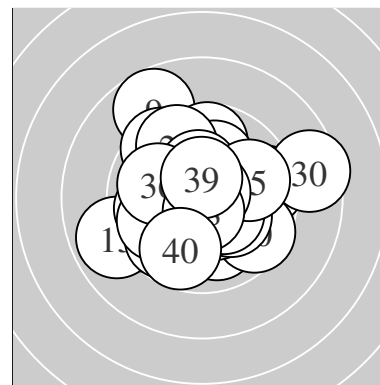

Serie 1:
 9.6 ↙ 10.2 * 9.9 ↑ 10.5 * 10.3 *
 10.3 * 10.7 * 10.3 * 8.7 ↗ 9.9 →
 beste Teiler 65.0 (7.) 116.9 (4.) 159.6 (6.)
 Trefferlage 0.10 mm links, 0.23 mm hoch
 Streuwert 1.97, horizontal: 1.84, vertikal: 2.09

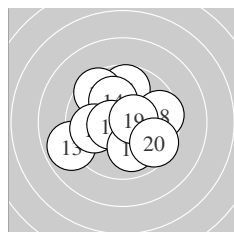

Serie 2:
 9.7 ↑ 9.5 ↘ 8.9 ↙ 10.1 ↗ 9.9 ←
 10.5 * 10.0 ↓ 9.6 → 10.5 * 9.6 ↘
 beste Teiler 104.2 (19.) 106.9 (16.) 214.4 (14.)
 Trefferlage 0.30 mm links, 0.14 mm hoch
 Streuwert 2.25, horizontal: 2.51, vertikal: 1.96

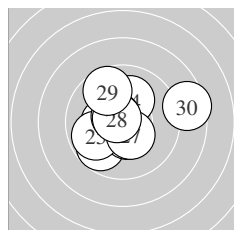

Serie 3:
 9.8 ↙ 10.5 * 10.3 * 10.1 ↑ 9.9 ←
 10.6 * 10.4 * 10.7 * 9.7 ↗ 8.5 →
 beste Teiler 64.0 (28.) 84.5 (26.) 125.5 (22.)
 Trefferlage 0.08 mm links, 0.14 mm hoch
 Streuwert 2.05, horizontal: 2.39, vertikal: 1.63

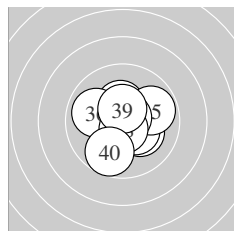

Serie 4:
 10.9 * 10.2 * 10.4 * 10.4 * 9.8 →
 9.9 ↙ 10.7 * 10.7 * 10.5 * 9.7 ↙
 beste Teiler 25.4 (31.) 52.8 (37.) 72.4 (38.)
 Trefferlage 0.19 mm rechts, 0.04 mm tief
 Streuwert 1.36, horizontal: 1.41, vertikal: 1.30

Unterschrift des Schützen

Ergebnis: **379.4** (363)
 Serien: 92.6 95.1 94.6 97.1
 Zähler: 14 20 3 2 0 1 0 0 0 0
 Innenzehner: 9
 weiteste: 1253 (1), 887 (15), 818 (17)
 beste Teiler 56.5 (19.) 71.8 (14.) 126.6 (32.)
 Trefferlage 1.09 mm rechts, 0.24 mm tief
 Streuwert 3.00, horizontal: 3.73, vertikal: 2.02

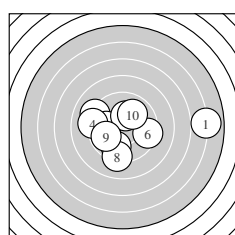
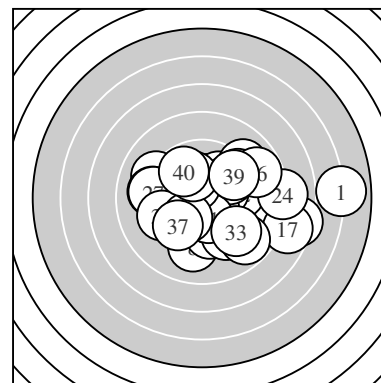

Serie 1:
 5.9 → 9.1 ↖ 10.0 ← 9.2 ← 9.7 ↓
 9.4 → 10.3 * 9.2 ↓ 9.8 ↙ 10.0 ↗
 beste Teiler 175.8 (7.) 244.0 (10.) 246.3 (3.)
 Trefferlage 0.28 mm rechts, 0.26 mm tief
 Streuwert 3.83, horizontal: 4.98, vertikal: 2.13

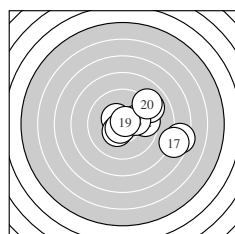

Serie 2:
 10.4 * 9.6 → 10.4 * 10.7 * 7.4 →
 9.1 ↗ 7.7 ↘ 10.1 → 10.7 * 9.0 ↗
 beste Teiler 56.5 (19.) 71.8 (14.) 127.5 (11.)
 Trefferlage 2.76 mm rechts, 0.11 mm hoch
 Streuwert 2.74, horizontal: 3.41, vertikal: 1.83

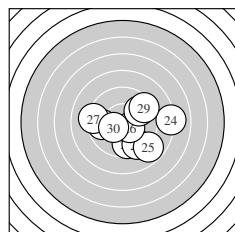

Serie 3:
 9.6 ↓ 9.7 ← 9.4 ↘ 8.0 → 8.8 ↘
 10.4 * 9.2 ← 9.8 ↗ 9.4 ↗ 10.3 *
 beste Teiler 134.8 (26.) 157.7 (30.) 297.3 (28.)
 Trefferlage 1.19 mm rechts, 0.75 mm tief
 Streuwert 2.85, horizontal: 3.44, vertikal: 2.09

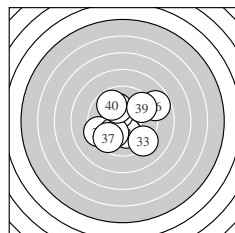

Serie 4:
 10.2 * 10.4 * 9.2 ↘ 9.4 ↙ 10.1 ↙
 8.8 ↗ 9.6 ↙ 10.1 ↘ 9.5 ↗ 9.8 ↘
 beste Teiler 126.6 (32.) 191.3 (31.) 209.8 (38.)
 Trefferlage 0.12 mm rechts, 0.08 mm tief
 Streuwert 2.46, horizontal: 2.69, vertikal: 2.21

Unterschrift des Schützen

Meyton Elektronik

Ergebnis: **409.4** (393)
 Serien: 101.7 102.0 102.6 103.1
 Zähler: 33 7 0 0 0 0 0 0 0 0
 Innenzehner: 26
 weiteste: 324 (3), 317 (9), 294 (11)
 beste Teiler 43.6 (19.) 57.2 (31.) 77.1 (4.)
 Trefferlage 0.15 mm links, 0.47 mm hoch
 Streuwert 1.34, horizontal: 1.34, vertikal: 1.34

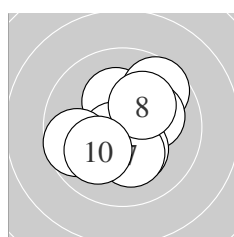
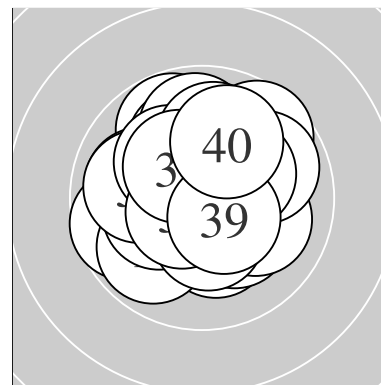

Serie 1:
 10.5 * 10.3 * 9.7 ↗ 10.6 * 10.1 →
 10.3 * 10.2 * 10.2 * 9.7 ← 10.1 ←
 beste Teiler 77.1 (4.) 119.5 (1.) 165.1 (6.)
 Trefferlage 0.19 mm rechts, 0.08 mm hoch
 Streuwert 1.57, horizontal: 1.61, vertikal: 1.52

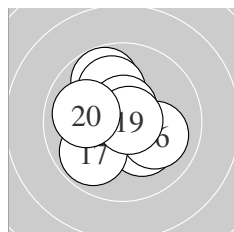

Serie 2:
 9.8 ↖ 10.3 * 10.4 * 10.0 ↖ 10.2 *
 10.0 → 9.9 ↙ 10.6 * 10.8 * 10.0 ←
 beste Teiler 43.6 (19.) 86.2 (18.) 136.2 (13.)
 Trefferlage 0.49 mm links, 0.17 mm hoch
 Streuwert 1.46, horizontal: 1.45, vertikal: 1.48

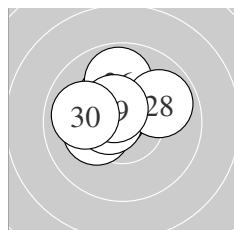

Serie 3:
 10.2 * 10.6 * 10.6 * 10.2 * 10.2 *
 9.9 ↑ 10.6 * 9.9 ↗ 10.5 * 9.9 ←
 beste Teiler 78.2 (22.) 89.6 (27.) 92.6 (23.)
 Trefferlage 0.56 mm links, 0.95 mm hoch
 Streuwert 1.12, horizontal: 1.26, vertikal: 0.97

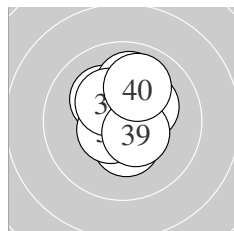

Serie 4:
 10.7 * 10.4 * 10.2 * 10.2 * 10.2 *
 10.0 ↑ 10.6 * 10.3 * 10.5 * 10.0 ↑
 beste Teiler 57.2 (31.) 96.8 (37.) 116.1 (39.)
 Trefferlage 0.24 mm rechts, 0.69 mm hoch
 Streuwert 1.15, horizontal: 0.92, vertikal: 1.34

Unterschrift des Schützen

Meyton Elektronik

Ergebnis: **407.7** (388)
 Serien: 101.4 100.8 104.0 101.5
 Zähler: 28 12 0 0 0 0 0 0 0 0
 Innenzehner: 22
 weiteste: 476 (8), 364 (27), 346 (10)
 beste Teiler 25.6 (17.) 46.3 (6.) 52.0 (25.)
 Trefferlage 0.39 mm rechts, 0.27 mm hoch
 Streuwert 1.52, horizontal: 1.50, vertikal: 1.55

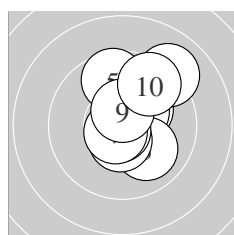
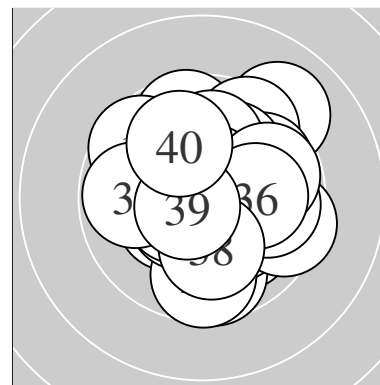

Serie 1:
 10.3 * 10.4 * 10.0 ↘ 10.5 * 9.6 ↑
 10.8 * 10.7 * 9.0 ↗ 10.5 * 9.6 ↗
 beste Teiler 46.3 (6.) 70.0 (7.) 103.0 (9.)
 Trefferlage 0.75 mm rechts, 0.90 mm hoch
 Streuwert 1.58, horizontal: 1.27, vertikal: 1.83

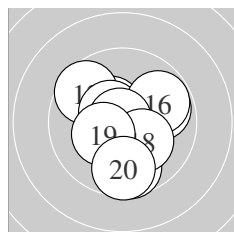

Serie 2:
 10.4 * 9.7 ↓ 9.6 ↖ 10.5 * 9.8 →
 9.8 ↗ 10.9 * 10.2 * 10.3 * 9.6 ↓
 beste Teiler 25.6 (17.) 112.2 (14.) 132.0 (11.)
 Trefferlage 0.11 mm rechts, 0.22 mm tief
 Streuwert 1.77, horizontal: 1.67, vertikal: 1.87

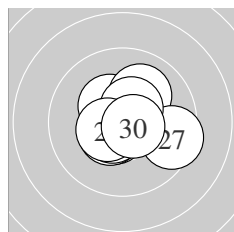

Serie 3:
 10.4 * 10.1 ↗ 10.6 * 10.5 * 10.7 *
 10.6 * 9.5 ↘ 10.5 * 10.5 * 10.6 *
 beste Teiler 52.0 (25.) 79.8 (30.) 90.8 (23.)
 Trefferlage 0.24 mm rechts, 0.01 mm tief
 Streuwert 1.22, horizontal: 1.40, vertikal: 1.00

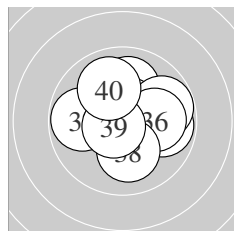

Serie 4:
 10.0 ↑ 10.6 * 10.7 * 9.8 → 9.8 →
 10.0 → 9.8 ← 10.1 ↓ 10.7 * 10.0 ↘
 beste Teiler 60.1 (33.) 73.0 (39.) 93.4 (32.)
 Trefferlage 0.47 mm rechts, 0.44 mm hoch
 Streuwert 1.55, horizontal: 1.77, vertikal: 1.30

Unterschrift des Schützen

Meyton Elektronik

Ergebnis: **416.4** (397)
 Serien: 103.4 104.1 103.1 105.8
 Zähler: 37 3 0 0 0 0 0 0 0 0
 Innenzehner: 34
 weiteste: 294 (12), 269 (28), 262 (25)
 beste Teiler 28.1 (17.) 36.8 (40.) 43.0 (35.)
 Trefferlage 0.05 mm links, 0.23 mm hoch
 Streuwert 1.05, horizontal: 1.07, vertikal: 1.03

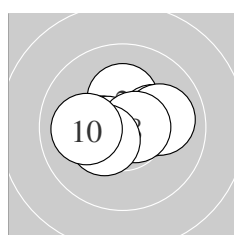
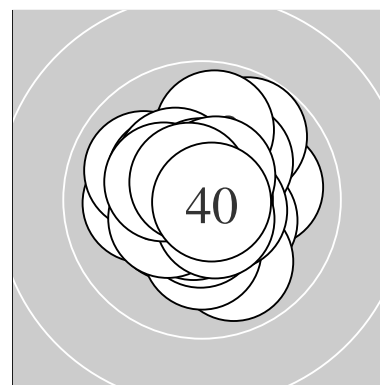

Serie 1:
 10.7 * 10.2 * 10.4 * 10.4 * 10.5 *
 10.2 * 10.0 → 10.6 * 10.4 * 10.0 ←
 beste Teiler 54.2 (1.) 79.0 (8.) 103.4 (5.)
 Trefferlage 0.23 mm links, 0.10 mm hoch
 Streuwert 1.18, horizontal: 1.50, vertikal: 0.73

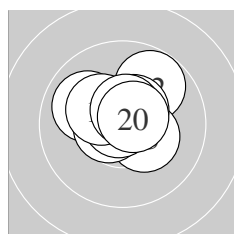

Serie 2:
 10.0 ↖ 9.8 ↗ 10.3 * 10.6 * 10.5 *
 10.6 * 10.8 * 10.3 * 10.6 * 10.6 *
 beste Teiler 28.1 (17.) 80.4 (20.) 89.0 (16.)
 Trefferlage 0.06 mm links, 0.65 mm hoch
 Streuwert 1.05, horizontal: 1.23, vertikal: 0.85

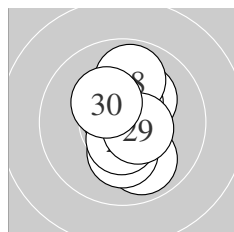

Serie 3:
 10.2 * 10.4 * 10.5 * 10.7 * 9.9 ↘
 10.2 * 10.5 * 9.9 ↑ 10.5 * 10.3 *
 beste Teiler 57.0 (24.) 102.6 (23.) 104.9 (29.)
 Trefferlage 0.29 mm rechts, 0.03 mm hoch
 Streuwert 1.25, horizontal: 0.70, vertikal: 1.62

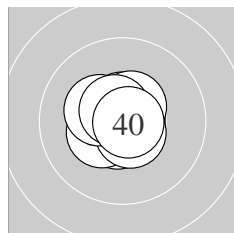

Serie 4:
 10.6 * 10.4 * 10.6 * 10.6 * 10.8 *
 10.5 * 10.6 * 10.3 * 10.6 * 10.8 *
 beste Teiler 36.8 (40.) 43.0 (35.) 76.5 (33.)
 Trefferlage 0.23 mm links, 0.14 mm hoch
 Streuwert 0.70, horizontal: 0.72, vertikal: 0.68

Unterschrift des Schützen

Meyton Elektronik

Ergebnis: **405.2** (387)
 Serien: 101.7 101.7 102.4 99.4
 Zähler: 29 9 2 0 0 0 0 0 0 0
 Innenzehner: 23
 weiteste: 565 (28), 554 (15), 420 (31)
 beste Teiler 12.3 (13.) 38.4 (35.) 62.3 (22.)
 Trefferlage 0.00 mm , 0.51 mm hoch
 Streuwert 1.68, horizontal: 1.94, vertikal: 1.38

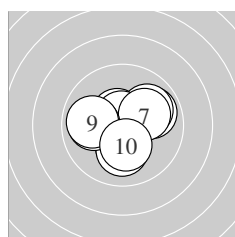
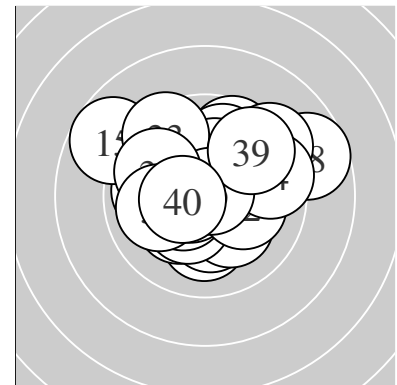

Serie 1:
 10.2 * 10.5 * 9.9 ↗ 10.0 ↗ 10.1 ↓
 10.7 * 10.1 ↗ 10.0 ← 9.9 ← 10.3 *
 beste Teiler 70.7 (6.) 102.4 (2.) 172.2 (10.)
 Trefferlage 0.09 mm rechts, 0.05 mm tief
 Streuwert 1.55, horizontal: 1.73, vertikal: 1.34

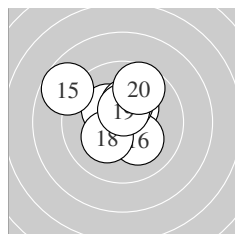

Serie 2:
 10.3 * 10.4 * 10.9 * 10.5 * 8.7 ↘
 10.2 * 10.3 * 10.2 * 10.5 * 9.7 ↗
 beste Teiler 12.3 (13.) 103.9 (14.) 106.3 (19.)
 Trefferlage 0.28 mm links, 0.68 mm hoch
 Streuwert 1.71, horizontal: 1.83, vertikal: 1.58

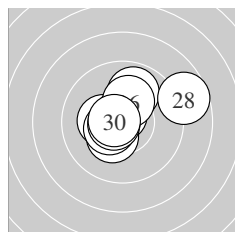

Serie 3:
 10.3 * 10.7 * 10.5 * 9.9 ↗ 10.3 *
 10.2 * 10.5 * 8.7 ↗ 10.6 * 10.7 *
 beste Teiler 62.3 (22.) 73.1 (30.) 77.8 (29.)
 Trefferlage 0.05 mm rechts, 0.46 mm hoch
 Streuwert 1.66, horizontal: 1.99, vertikal: 1.25

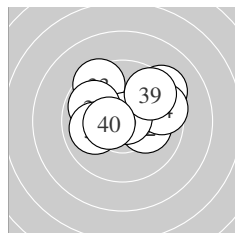

Serie 4:
 9.3 ↗ 10.1 → 9.5 ↘ 9.5 → 10.8 *
 10.2 * 9.9 ↘ 10.0 ← 9.6 ↗ 10.5 *
 beste Teiler 38.4 (35.) 118.3 (40.) 196.4 (36.)
 Trefferlage 0.13 mm rechts, 0.94 mm hoch
 Streuwert 1.96, horizontal: 2.43, vertikal: 1.35

Unterschrift des Schützen

Meyton Elektronik

Ergebnis: **406.2** (389)
 Serien: 100.4 101.5 101.5 102.8
 Zähler: 29 11 0 0 0 0 0 0 0 0
 Innenzehner: 23
 weiteste: 460 (7), 418 (33), 379 (15)
 beste Teiler 60.1 (37.) 69.6 (32.) 81.4 (4.)
 Trefferlage 0.17 mm links, 0.03 mm tief
 Streuwert 1.57, horizontal: 1.83, vertikal: 1.25

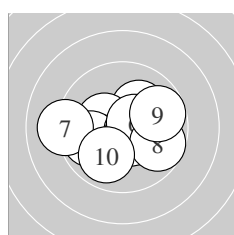
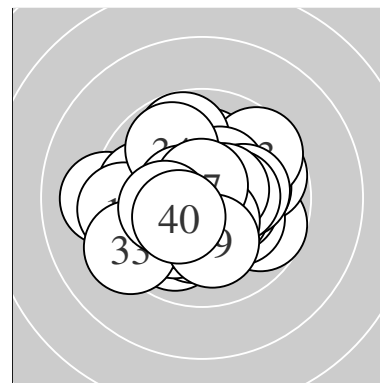

Serie 1:
 10.2 * 10.3 * 9.9 ← 10.6 * 10.5 *
 10.5 * 9.1 ← 9.7 → 9.7 → 9.9 ↙
 beste Teiler 81.4 (4.) 102.6 (6.) 109.8 (5.)
 Trefferlage 0.06 mm links, 0.22 mm tief
 Streuwert 1.87, horizontal: 2.38, vertikal: 1.14

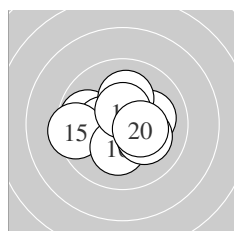

Serie 2:
 10.1 → 9.8 ← 10.5 * 10.3 * 9.4 ←
 10.2 * 10.2 * 10.1 ↑ 10.5 * 10.4 *
 beste Teiler 109.0 (19.) 125.0 (13.) 147.9 (20.)
 Trefferlage 0.42 mm links, 0.04 mm hoch
 Streuwert 1.57, horizontal: 1.93, vertikal: 1.09

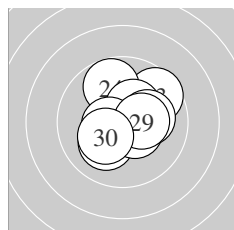

Serie 3:
 10.1 ↘ 10.0 ↗ 9.6 ↗ 9.8 ↑ 10.4 *
 10.5 * 10.5 * 10.1 → 10.3 * 10.2 *
 beste Teiler 108.6 (26.) 119.5 (27.) 146.2 (25.)
 Trefferlage 0.52 mm rechts, 0.40 mm hoch
 Streuwert 1.48, horizontal: 1.55, vertikal: 1.42

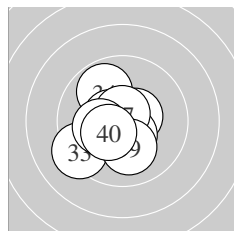

Serie 4:
 10.5 * 10.7 * 9.3 ← 9.8 ↖ 10.5 *
 10.6 * 10.7 * 10.2 * 10.1 ↓ 10.4 *
 beste Teiler 60.1 (37.) 69.6 (32.) 98.3 (36.)
 Trefferlage 0.73 mm links, 0.36 mm tief
 Streuwert 1.35, horizontal: 1.32, vertikal: 1.38

Unterschrift des Schützen

Meyton Elektronik

Ergebnis: **411.5** (395)
 Serien: 103.4 102.5 103.8 101.8
 Zähler: 35 5 0 0 0 0 0 0 0 0
 Innenzehner: 27
 weiteste: 370 (33), 369 (4), 273 (12)
 beste Teiler 18.3 (15.) 66.2 (7.) 74.3 (24.)
 Trefferlage 0.10 mm rechts, 0.10 mm hoch
 Streuwert 1.31, horizontal: 1.17, vertikal: 1.43

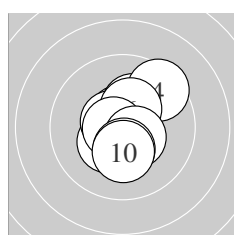
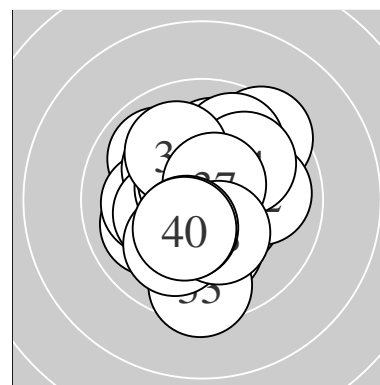

Serie 1:
 10.4 * 10.6 * 10.2 * 9.5 ↗ 10.6 *
 10.4 * 10.7 * 10.5 * 10.3 * 10.2 *
 beste Teiler 66.2 (7.) 81.7 (2.) 90.3 (5.)
 Trefferlage 0.22 mm rechts, 0.16 mm hoch
 Streuwert 1.28, horizontal: 1.05, vertikal: 1.46

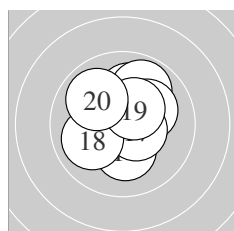

Serie 2:
 10.1 ↑ 9.9 ↗ 10.1 ↗ 10.2 * 10.9 *
 10.5 * 10.5 * 10.0 ↖ 10.4 * 9.9 ↘
 beste Teiler 18.3 (15.) 106.2 (17.) 113.2 (16.)
 Trefferlage 0.23 mm rechts, 0.61 mm hoch
 Streuwert 1.34, horizontal: 1.28, vertikal: 1.40

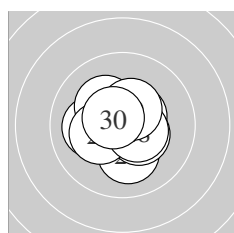

Serie 3:
 10.1 ← 10.5 * 10.1 ↓ 10.7 * 10.2 *
 10.4 * 10.3 * 10.5 * 10.4 * 10.6 *
 beste Teiler 74.3 (24.) 86.2 (30.) 114.0 (28.)
 Trefferlage 0.16 mm links, 0.05 mm hoch
 Streuwert 1.11, horizontal: 1.20, vertikal: 1.01

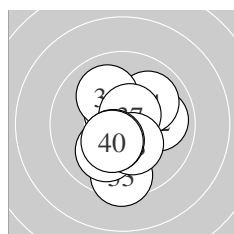

Serie 4:
 10.6 * 9.9 → 9.5 ↓ 10.0 ↗ 10.1 ↖
 10.0 ↘ 10.6 * 10.3 * 10.4 * 10.4 *
 beste Teiler 85.4 (37.) 99.0 (31.) 137.9 (39.)
 Trefferlage 0.12 mm rechts, 0.40 mm tief
 Streuwert 1.54, horizontal: 1.26, vertikal: 1.78

Unterschrift des Schützen

Meyton Elektronik

Ergebnis: **413.6** (397)
 Serien: 102.9 104.3 103.0 103.4
 Zähler: 37 3 0 0 0 0 0 0 0 0
 Innenzehner: 32
 weiteste: 320 (36), 278 (4), 265 (32)
 beste Teiler 13.4 (5.) 68.1 (38.) 70.8 (39.)
 Trefferlage 0.05 mm rechts, 0.11 mm hoch
 Streuwert 1.19, horizontal: 1.14, vertikal: 1.23

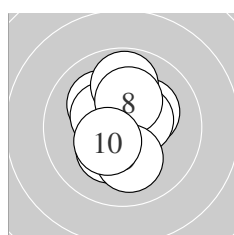
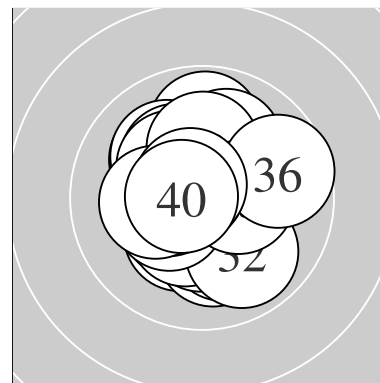

Serie 1:
 10.1 ↘ 10.4 * 10.2 * 9.8 ↑ 10.9 *
 10.5 * 10.3 * 10.2 * 10.1 ↓ 10.4 *
 beste Teiler 13.4 (5.) 123.1 (6.) 136.5 (10.)
 Trefferlage 0.07 mm links, 0.37 mm hoch
 Streuwert 1.29, horizontal: 1.02, vertikal: 1.52

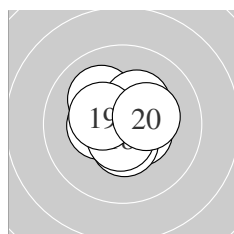

Serie 2:
 10.6 * 10.4 * 10.1 ↘ 10.6 * 10.5 *
 10.3 * 10.5 * 10.6 * 10.4 * 10.3 *
 beste Teiler 83.6 (11.) 87.9 (18.) 91.9 (14.)
 Trefferlage 0.09 mm rechts, 0.13 mm hoch
 Streuwert 1.03, horizontal: 1.13, vertikal: 0.93

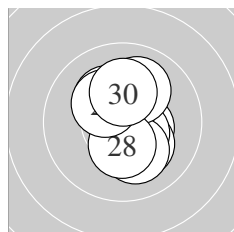

Serie 3:
 10.5 * 10.2 * 10.5 * 10.6 * 10.1 ↓
 10.0 ↗ 10.2 * 10.4 * 10.3 * 10.2 *
 beste Teiler 93.0 (24.) 113.5 (23.) 123.9 (21.)
 Trefferlage 0.28 mm rechts, 0.18 mm hoch
 Streuwert 1.24, horizontal: 0.87, vertikal: 1.52

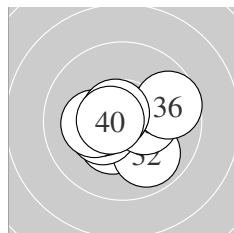

Serie 4:
 10.4 * 9.9 ↘ 10.4 * 10.4 * 10.4 *
 9.7 → 10.2 * 10.7 * 10.7 * 10.6 *
 beste Teiler 68.1 (38.) 70.8 (39.) 82.2 (40.)
 Trefferlage 0.09 mm links, 0.21 mm tief
 Streuwert 1.29, horizontal: 1.57, vertikal: 0.93

Unterschrift des Schützen

Meyton Elektronik

Ergebnis: **400.6** (381)
 Serien: 97.8 100.3 99.8 102.7
 Zähler: 23 15 2 0 0 0 0 0 0 0
 Innenzehner: 16
 weiteste: 636 (30), 576 (7), 451 (4)
 beste Teiler 17.0 (19.) 36.1 (35.) 52.7 (25.)
 Trefferlage 0.07 mm links, 0.16 mm tief
 Streuwert 1.96, horizontal: 2.20, vertikal: 1.69

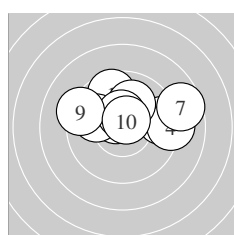
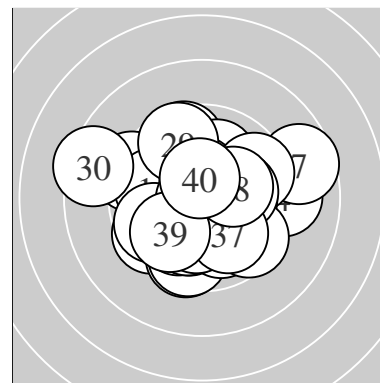

Serie 1:
 9.6 ↗ 9.5 → 10.6 * 9.1 → 9.9 ↖
 10.0 ↗ 8.6 → 10.5 * 9.3 ↖ 10.7 *
 beste Teiler 75.1 (10.) 93.5 (3.) 123.6 (8.)
 Trefferlage 0.65 mm rechts, 1.28 mm hoch
 Streuwert 2.24, horizontal: 3.03, vertikal: 0.92

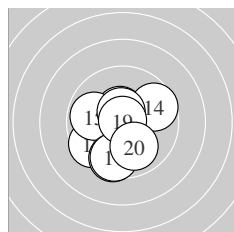

Serie 2:
 9.9 ↘ 9.6 ↘ 10.5 * 9.7 → 9.9 ↖
 9.6 ↓ 9.6 ↓ 10.6 * 10.9 * 10.0 ↓
 beste Teiler 17.0 (19.) 98.0 (18.) 112.8 (13.)
 Trefferlage 0.49 mm links, 0.87 mm tief
 Streuwert 1.79, horizontal: 1.69, vertikal: 1.89

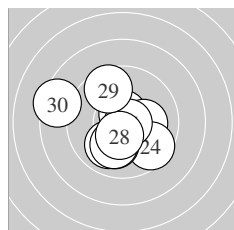

Serie 3:
 10.7 * 10.0 ↘ 10.2 * 9.6 ↘ 10.7 *
 10.1 ↓ 10.1 ↓ 10.4 * 9.6 ↗ 8.4 ↖
 beste Teiler 52.7 (25.) 75.0 (21.) 127.3 (28.)
 Trefferlage 0.54 mm links, 0.43 mm tief
 Streuwert 2.13, horizontal: 2.36, vertikal: 1.86

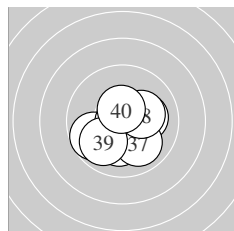

Serie 4:
 10.1 → 10.2 * 9.7 ↖ 10.6 * 10.8 *
 10.7 * 10.0 ↘ 10.2 * 9.9 ↗ 10.5 *
 beste Teiler 36.1 (35.) 65.9 (36.) 77.5 (34.)
 Trefferlage 0.07 mm rechts, 0.63 mm tief
 Streuwert 1.34, horizontal: 1.51, vertikal: 1.14

Unterschrift des Schützen

Meyton Elektronik

Ergebnis: **411.0** (391)
 Serien: 102.5 102.0 104.4 102.1
 Zähler: 31 9 0 0 0 0 0 0 0 0
 Innenzehner: 28
 weiteste: 433 (36), 375 (26), 348 (7)
 beste Teiler 34.7 (21.) 37.9 (17.) 43.1 (28.)
 Trefferlage 0.21 mm links, 0.24 mm hoch
 Streuwert 1.40, horizontal: 1.70, vertikal: 1.00

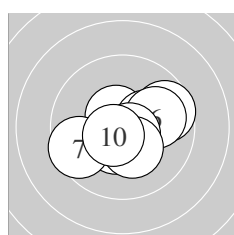
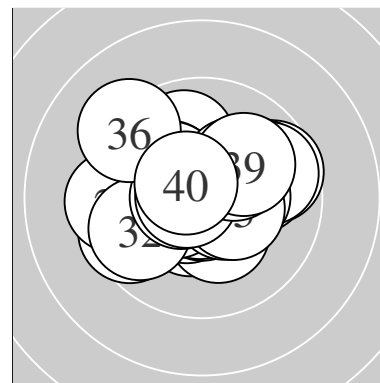

Serie 1:
 9.6 → 10.6 * 10.5 * 10.2 * 10.4 *
 10.0 → 9.6 ← 10.7 * 10.3 * 10.6 *
 beste Teiler 69.3 (8.) 89.9 (10.) 93.2 (2.)
 Trefferlage 0.34 mm rechts, 0.32 mm tief
 Streuwert 1.44, horizontal: 1.78, vertikal: 1.01

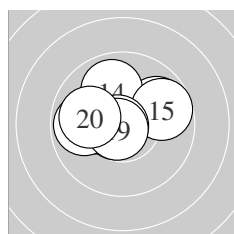

Serie 2:
 9.9 → 10.2 * 10.3 * 9.9 ↑ 9.7 →
 10.7 * 10.8 * 9.8 ← 10.7 * 10.0 ←
 beste Teiler 37.9 (17.) 53.7 (19.) 61.2 (16.)
 Trefferlage 0.45 mm links, 0.59 mm hoch
 Streuwert 1.46, horizontal: 1.84, vertikal: 0.94

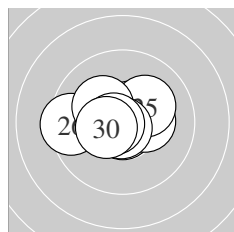

Serie 3:
 10.8 * 10.6 * 10.8 * 10.3 * 10.2 *
 9.5 ← 10.2 * 10.8 * 10.7 * 10.5 *
 beste Teiler 34.7 (21.) 43.1 (28.) 49.0 (23.)
 Trefferlage 0.34 mm links, 0.18 mm hoch
 Streuwert 1.20, horizontal: 1.57, vertikal: 0.63

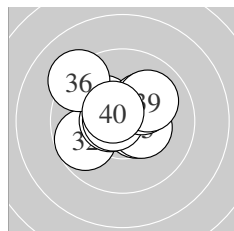

Serie 4:
 10.2 * 9.7 ← 10.6 * 10.5 * 10.4 *
 9.2 ↘ 10.7 * 10.2 * 10.0 → 10.6 *
 beste Teiler 67.3 (37.) 91.0 (33.) 95.5 (40.)
 Trefferlage 0.40 mm links, 0.52 mm hoch
 Streuwert 1.51, horizontal: 1.75, vertikal: 1.22

Unterschrift des Schützen

Meyton Elektronik

Ergebnis: **407.9** (391)
 Serien: 104.0 99.3 101.8 102.8
 Zähler: 31 9 0 0 0 0 0 0 0 0
 Innenzehner: 23
 weiteste: 408 (23), 339 (14), 319 (16)
 beste Teiler 44.9 (3.) 60.9 (31.) 65.0 (10.)
 Trefferlage 0.04 mm links, 0.09 mm hoch
 Streuwert 1.49, horizontal: 1.61, vertikal: 1.37

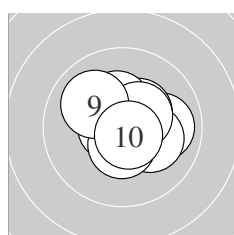
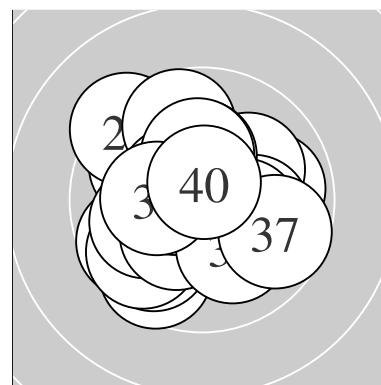

Serie 1:
 10.0 → 10.2 * 10.8 * 10.7 * 10.5 *
 10.4 * 10.3 * 10.4 * 10.0 ↘ 10.7 *
 beste Teiler 44.9 (3.) 65.0 (10.) 72.0 (4.)
 Trefferlage 0.42 mm rechts, 0.24 mm hoch
 Streuwert 1.10, horizontal: 1.26, vertikal: 0.91

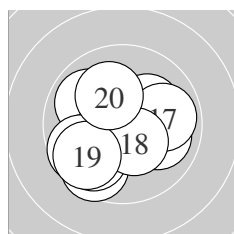

Serie 2:
 9.9 ↘ 10.0 → 10.2 * 9.6 ↙ 9.8 ↙
 9.7 ↙ 9.9 → 10.4 * 9.7 ↙ 10.1 ↘
 beste Teiler 138.3 (18.) 194.1 (13.) 208.0 (20.)
 Trefferlage 0.46 mm links, 0.58 mm tief
 Streuwert 1.89, horizontal: 2.09, vertikal: 1.67

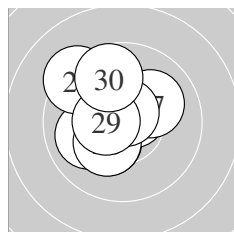

Serie 3:
 10.3 * 10.0 ← 9.3 ↘ 10.6 * 10.3 *
 10.3 * 10.1 ↗ 10.7 * 10.5 * 9.7 ↗
 beste Teiler 65.9 (28.) 84.5 (24.) 109.2 (29.)
 Trefferlage 0.56 mm links, 0.59 mm hoch
 Streuwert 1.49, horizontal: 1.46, vertikal: 1.51

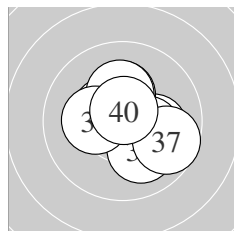

Serie 4:
 10.7 * 10.1 → 10.5 * 10.3 * 10.3 *
 10.1 ↘ 9.7 → 10.2 * 10.2 * 10.7 *
 beste Teiler 60.9 (31.) 70.4 (40.) 124.0 (33.)
 Trefferlage 0.43 mm rechts, 0.12 mm hoch
 Streuwert 1.33, horizontal: 1.46, vertikal: 1.19

Unterschrift des Schützen

Meyton Elektronik

Ergebnis: **407.8** (392)
 Serien: 103.0 100.6 101.9 102.3
 Zähler: 32 8 0 0 0 0 0 0 0 0
 Innenzehner: 25
 weiteste: 444 (20), 361 (19), 339 (1)
 beste Teiler 49.1 (10.) 50.2 (4.) 53.9 (17.)
 Trefferlage 0.07 mm links, 0.28 mm tief
 Streuwert 1.49, horizontal: 1.51, vertikal: 1.46

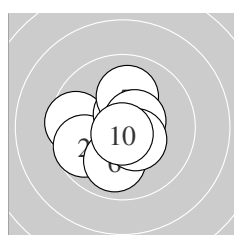
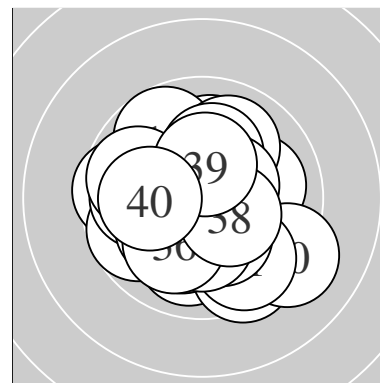

Serie 1:
 9.6 ← 9.7 ↙ 10.4 * 10.8 * 10.6 *
 10.0 ↓ 10.1 ↑ 10.6 * 10.4 * 10.8 *
 beste Teiler 49.1 (10.) 50.2 (4.) 94.8 (5.)
 Trefferlage 0.39 mm links, 0.26 mm tief
 Streuwert 1.41, horizontal: 1.49, vertikal: 1.33

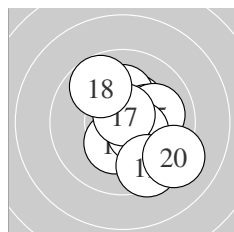

Serie 2:
 10.4 * 10.2 * 10.2 * 10.3 * 10.0 →
 10.4 * 10.7 * 9.7 ↘ 9.5 ↘ 9.2 ↘
 beste Teiler 53.9 (17.) 129.0 (16.) 146.4 (11.)
 Trefferlage 0.93 mm rechts, 0.05 mm tief
 Streuwert 1.70, horizontal: 1.53, vertikal: 1.86

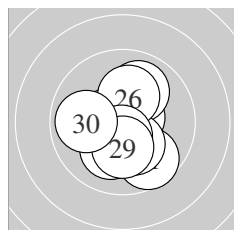

Serie 3:
 9.7 ↘ 10.5 * 10.6 * 10.0 ↗ 10.2 *
 10.2 * 10.1 ↓ 10.5 * 10.2 * 9.9 ←
 beste Teiler 87.8 (23.) 102.3 (28.) 106.5 (22.)
 Trefferlage 0.03 mm rechts, 0.43 mm tief
 Streuwert 1.47, horizontal: 1.29, vertikal: 1.63

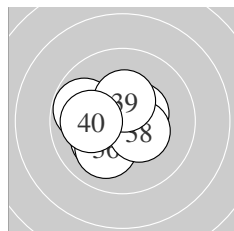

Serie 4:
 9.8 ↖ 10.2 * 10.5 * 10.2 * 10.2 *
 10.1 ↙ 10.5 * 10.4 * 10.4 * 10.0 ←
 beste Teiler 117.6 (33.) 122.5 (37.) 139.0 (38.)
 Trefferlage 0.88 mm links, 0.40 mm tief
 Streuwert 1.22, horizontal: 1.31, vertikal: 1.12

Unterschrift des Schützen

Meyton Elektronik

Ergebnis: **409.0** (394)
 Serien: 104.2 99.3 103.0 102.5
 Zähler: 34 6 0 0 0 0 0 0 0 0
 Innenzehner: 26
 weiteste: 403 (15), 381 (14), 377 (13)
 beste Teiler 14.0 (6.) 29.4 (9.) 65.0 (30.)
 Trefferlage 0.17 mm links, 0.09 mm hoch
 Streuwert 1.44, horizontal: 1.56, vertikal: 1.32

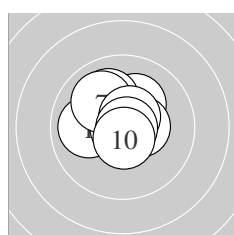
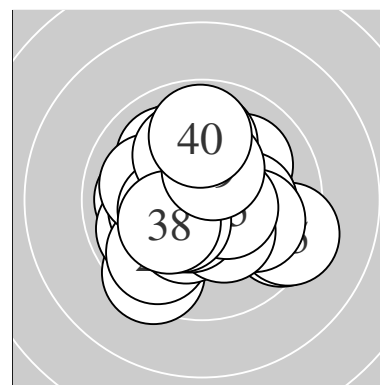

Serie 1:
 10.0 ← 10.2 * 10.0 ↗ 10.6 * 10.5 *
 10.9 * 10.0 ↘ 10.6 * 10.8 * 10.6 *
 beste Teiler 14.0 (6.) 29.4 (9.) 80.6 (4.)
 Trefferlage 0.18 mm links, 0.62 mm hoch
 Streuwert 1.05, horizontal: 1.15, vertikal: 0.95

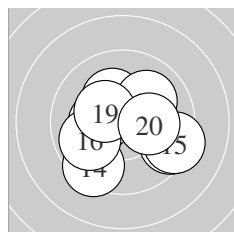

Serie 2:
 10.2 * 10.3 * 9.4 ↘ 9.4 ✓ 9.3 ↗
 9.9 ↙ 10.2 * 10.0 ↗ 10.4 * 10.2 *
 beste Teiler 150.7 (19.) 170.0 (12.) 182.6 (11.)
 Trefferlage 0.44 mm rechts, 0.36 mm tief
 Streuwert 1.97, horizontal: 2.34, vertikal: 1.51

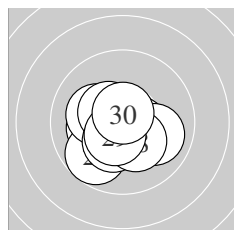

Serie 3:
 10.5 * 10.2 * 9.8 ✓ 10.0 ↘ 10.2 *
 10.5 * 10.3 * 10.3 * 10.5 * 10.7 *
 beste Teiler 65.0 (30.) 107.1 (29.) 110.6 (21.)
 Trefferlage 0.36 mm links, 0.57 mm tief
 Streuwert 1.23, horizontal: 1.43, vertikal: 1.00

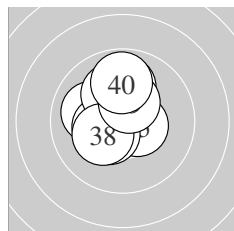

Serie 4:
 10.0 ↖ 10.6 * 10.4 * 10.1 ↗ 10.5 *
 10.4 * 10.0 ↑ 10.3 * 10.4 * 9.8 ↑
 beste Teiler 77.6 (32.) 112.9 (35.) 134.4 (36.)
 Trefferlage 0.58 mm links, 0.70 mm hoch
 Streuwert 1.21, horizontal: 1.01, vertikal: 1.39

Unterschrift des Schützen

Meyton Elektronik

Ergebnis: **413.7** (397)
 Serien: 103.9 105.0 102.1 102.7
 Zähler: 37 3 0 0 0 0 0 0 0 0
 Innenzehner: 29
 weiteste: 306 (31), 302 (23), 270 (29)
 beste Teiler 29.0 (6.) 39.0 (19.) 53.0 (13.)
 Trefferlage 0.46 mm rechts, 0.54 mm hoch
 Streuwert 1.09, horizontal: 1.07, vertikal: 1.11

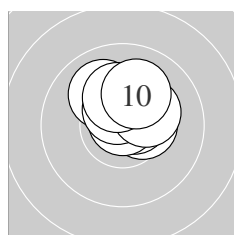
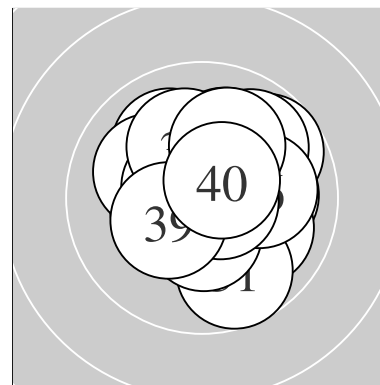

Serie 1:
 10.4 * 10.6 * 10.3 * 10.0 ↘ 10.7 *
 10.8 * 10.5 * 10.3 * 10.2 * 10.1 ↗
 beste Teiler 29.0 (6.) 64.0 (5.) 83.1 (2.)
 Trefferlage 0.33 mm rechts, 1.04 mm hoch
 Streuwert 0.80, horizontal: 0.86, vertikal: 0.73

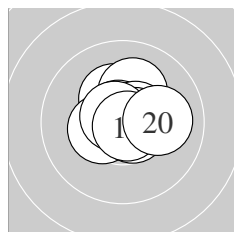

Serie 2:
 10.3 * 10.2 * 10.7 * 10.4 * 10.6 *
 10.6 * 10.7 * 10.7 * 10.8 * 10.0 →
 beste Teiler 39.0 (19.) 53.0 (13.) 63.6 (18.)
 Trefferlage 0.28 mm rechts, 0.36 mm hoch
 Streuwert 0.89, horizontal: 1.00, vertikal: 0.78

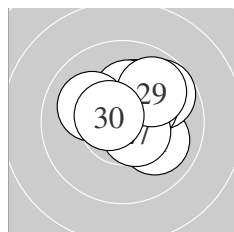

Serie 3:
 10.0 ↘ 10.6 * 9.7 ↗ 10.2 * 10.2 *
 10.3 * 10.5 * 10.1 ↘ 9.9 ↗ 10.6 *
 beste Teiler 86.2 (22.) 96.6 (30.) 104.6 (27.)
 Trefferlage 0.77 mm rechts, 0.79 mm hoch
 Streuwert 1.23, horizontal: 1.35, vertikal: 1.09

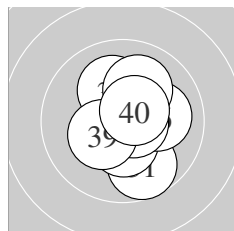

Serie 4:
 9.7 ↘ 10.5 * 10.4 * 10.3 * 10.1 ↘
 10.1 → 10.7 * 10.1 ↗ 10.3 * 10.5 *
 beste Teiler 72.0 (37.) 101.9 (40.) 120.6 (32.)
 Trefferlage 0.46 mm rechts, 0.03 mm tief
 Streuwert 1.32, horizontal: 1.11, vertikal: 1.50

Unterschrift des Schützen

Meyton Elektronik

Ergebnis: **413.8** (398)
 Serien: 103.1 104.5 103.7 102.5
 Zähler: 38 2 0 0 0 0 0 0 0 0
 Innenzehner: 32
 weiteste: 333 (7), 255 (33), 248 (35)
 beste Teiler 21.0 (30.) 40.8 (15.) 58.0 (29.)
 Trefferlage 0.00 mm , 0.06 mm tief
 Streuwert 1.18, horizontal: 1.20, vertikal: 1.15

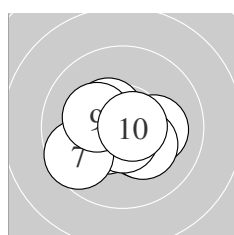
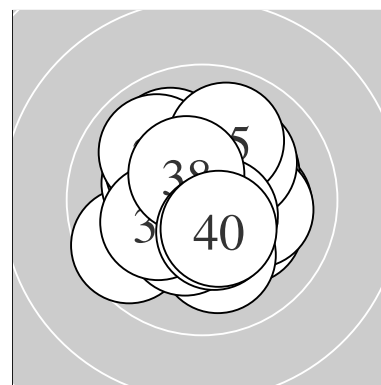

Serie 1:
 10.1 → 10.3 * 10.4 * 10.3 * 10.4 *
 10.7 * 9.6 ↙ 10.4 * 10.2 * 10.7 *
 beste Teiler 64.1 (10.) 71.1 (6.) 127.6 (5.)
 Trefferlage 0.01 mm links, 0.48 mm tief
 Streuwert 1.24, horizontal: 1.54, vertikal: 0.84

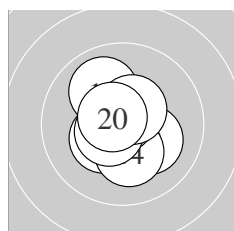

Serie 2:
 10.6 * 10.3 * 10.2 * 10.2 * 10.8 *
 10.7 * 10.0 ↘ 10.6 * 10.5 * 10.6 *
 beste Teiler 40.8 (15.) 72.2 (16.) 80.4 (20.)
 Trefferlage 0.12 mm links, 0.03 mm tief
 Streuwert 1.04, horizontal: 0.94, vertikal: 1.14

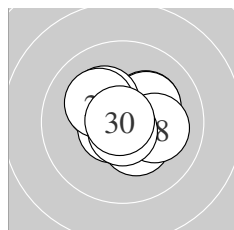

Serie 3:
 10.2 * 10.2 * 10.6 * 10.2 * 10.2 *
 10.2 * 10.4 * 10.1 → 10.7 * 10.9 *
 beste Teiler 21.0 (30.) 58.0 (29.) 76.6 (23.)
 Trefferlage 0.10 mm rechts, 0.33 mm hoch
 Streuwert 1.14, horizontal: 1.32, vertikal: 0.93

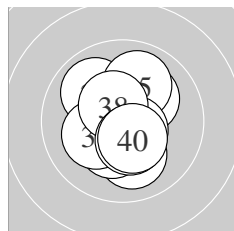

Serie 4:
 10.1 ↓ 10.3 * 9.9 ↘ 10.1 ↗ 10.0 ↗
 10.6 * 10.2 * 10.5 * 10.4 * 10.4 *
 beste Teiler 91.4 (36.) 117.1 (38.) 128.9 (40.)
 Trefferlage 0.00 mm , 0.08 mm tief
 Streuwert 1.36, horizontal: 1.11, vertikal: 1.57

Unterschrift des Schützen

Meyton Elektronik

Ergebnis: **405.5** (389)
 Serien: 99.6 102.4 101.0 102.5
 Zähler: 31 7 2 0 0 0 0 0 0 0
 Innenzehner: 23
 weiteste: 534 (30), 526 (3), 500 (4)
 beste Teiler 25.2 (26.) 48.4 (24.) 54.1 (8.)
 Trefferlage 0.07 mm rechts, 0.36 mm hoch
 Streuwert 1.66, horizontal: 1.80, vertikal: 1.52

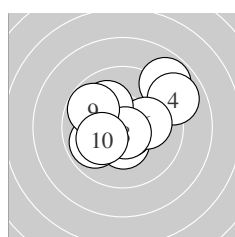
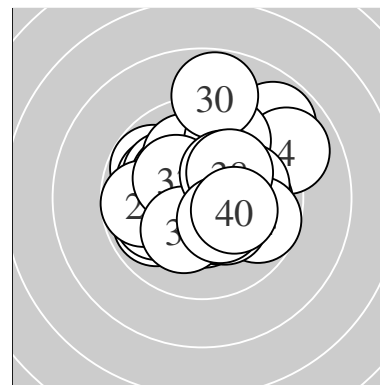

Serie 1:
 10.4 * 10.7 * 8.8 ↗ 9.0 ↗ 9.9 ↖
 10.1 → 10.1 ↘ 10.7 * 9.8 ↖ 10.1 ↖
 beste Teiler 54.1 (8.) 56.8 (2.) 137.2 (1.)
 Trefferlage 0.28 mm rechts, 0.53 mm hoch
 Streuwert 2.12, horizontal: 2.43, vertikal: 1.76

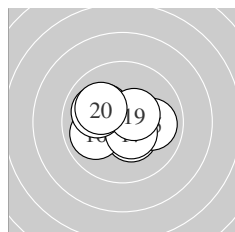

Serie 2:
 10.4 * 10.6 * 10.2 * 10.2 * 10.0 →
 9.9 ↖ 10.5 * 10.0 ↖ 10.5 * 10.1 ↖
 beste Teiler 97.6 (12.) 118.6 (17.) 118.9 (19.)
 Trefferlage 0.42 mm links, 0.06 mm tief
 Streuwert 1.38, horizontal: 1.73, vertikal: 0.92

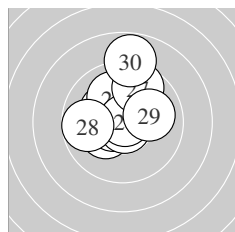

Serie 3:
 10.2 * 10.3 * 10.6 * 10.8 * 10.0 ↖
 10.9 * 9.7 ↗ 9.7 ← 10.0 → 8.8 ↗
 beste Teiler 25.2 (26.) 48.4 (24.) 86.6 (23.)
 Trefferlage 0.29 mm links, 1.02 mm hoch
 Streuwert 1.75, horizontal: 1.54, vertikal: 1.93

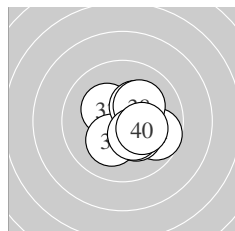

Serie 4:
 10.3 * 10.6 * 10.3 * 9.7 ↗ 10.3 *
 10.2 * 10.3 * 10.2 * 10.4 * 10.2 *
 beste Teiler 76.4 (32.) 146.9 (39.) 165.8 (37.)
 Trefferlage 0.75 mm rechts, 0.04 mm tief
 Streuwert 1.26, horizontal: 1.32, vertikal: 1.21

Unterschrift des Schützen

Meyton Elektronik

Ergebnis: **408.7** (390)
 Serien: 101.5 101.9 103.6 101.7
 Zähler: 31 8 1 0 0 0 0 0 0
 Innenzehner: 28
 weiteste: 671 (40), 390 (12), 388 (5)
 beste Teiler 13.9 (19.) 64.5 (2.) 71.7 (21.)
 Trefferlage 0.00 mm , 0.27 mm hoch
 Streuwert 1.57, horizontal: 1.96, vertikal: 1.04

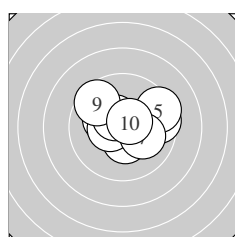
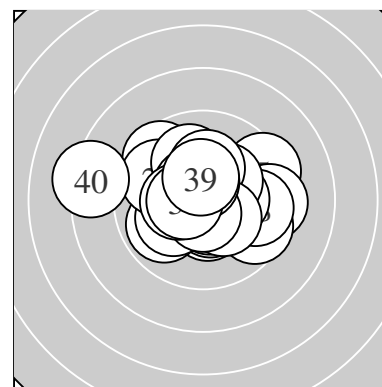

Serie 1:
 10.4 * 10.7 * 9.5 → 10.2 * 9.4 ↗
 10.5 * 10.1 ↘ 10.5 * 9.6 ↖ 10.6 *
 beste Teiler 64.5 (2.) 88.0 (10.) 116.8 (8.)
 Trefferlage 0.31 mm rechts, 0.48 mm hoch
 Streuwert 1.67, horizontal: 2.09, vertikal: 1.10

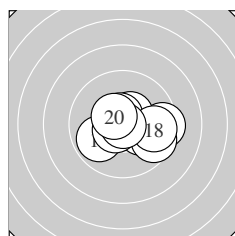

Serie 2:
 9.9 ↙ 9.4 → 10.2 * 10.5 * 10.6 *
 9.6 ↘ 10.6 * 9.7 → 10.9 * 10.5 *
 beste Teiler 13.9 (19.) 85.0 (17.) 91.2 (15.)
 Trefferlage 0.85 mm rechts, 0.25 mm tief
 Streuwert 1.56, horizontal: 2.02, vertikal: 0.88

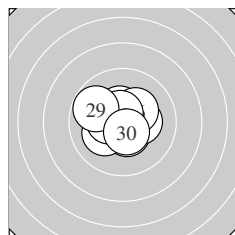

Serie 3:
 10.7 * 10.5 * 10.1 ↙ 10.3 * 10.4 *
 10.3 * 10.4 * 10.6 * 9.8 ↖ 10.5 *
 beste Teiler 71.7 (21.) 88.3 (28.) 103.2 (30.)
 Trefferlage 0.22 mm links, 0.22 mm hoch
 Streuwert 1.17, horizontal: 1.33, vertikal: 0.98

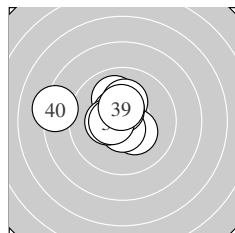

Serie 4:
 10.0 ↖ 10.5 * 10.2 * 10.3 * 10.6 *
 10.5 * 10.4 * 10.5 * 10.4 * 8.3 ←
 beste Teiler 80.0 (35.) 103.7 (32.) 107.6 (36.)
 Trefferlage 0.94 mm links, 0.64 mm hoch
 Streuwert 1.69, horizontal: 2.12, vertikal: 1.10

Unterschrift des Schützen

Meyton Elektronik

Ergebnis: **407.8** (390)
 Serien: 103.5 101.3 102.1 100.9
 Zähler: 31 8 1 0 0 0 0 0 0 0
 Innenzehner: 27
 weiteste: 532 (16), 414 (30), 397 (31)
 beste Teiler 59.9 (24.) 89.4 (27.) 94.2 (40.)
 Trefferlage 0.24 mm rechts, 0.22 mm hoch
 Streuwert 1.53, horizontal: 1.83, vertikal: 1.14

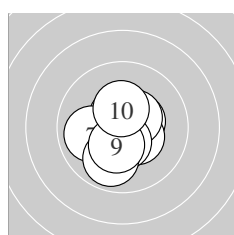
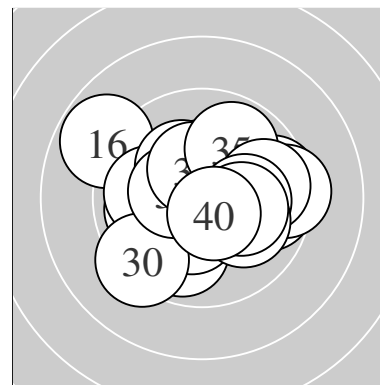

Serie 1:
 10.4 * 10.4 * 10.5 * 10.6 * 10.5 *
 10.5 * 9.9 ← 9.9 ↓ 10.4 * 10.4 *
 beste Teiler 95.2 (4.) 116.2 (5.) 117.2 (6.)
 Trefferlage 0.21 mm links, 0.35 mm tief
 Streuwert 1.17, horizontal: 1.12, vertikal: 1.22

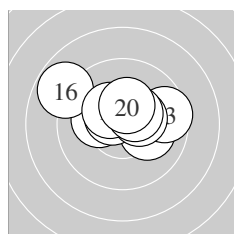

Serie 2:
 10.1 → 10.2 * 9.6 → 10.6 * 10.4 *
 8.8 ↖ 10.5 * 10.4 * 10.4 * 10.3 *
 beste Teiler 99.8 (14.) 121.5 (17.) 130.4 (19.)
 Trefferlage 0.01 mm links, 0.89 mm hoch
 Streuwert 1.68, horizontal: 2.22, vertikal: 0.87

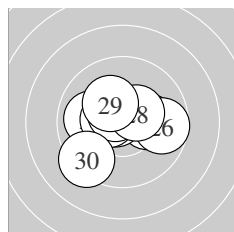

Serie 3:
 10.2 * 10.0 ← 10.5 * 10.7 * 10.5 *
 9.7 → 10.6 * 10.4 * 10.2 * 9.3 ↙
 beste Teiler 59.9 (24.) 89.4 (27.) 117.7 (25.)
 Trefferlage 0.31 mm links, 0.13 mm hoch
 Streuwert 1.58, horizontal: 1.88, vertikal: 1.21

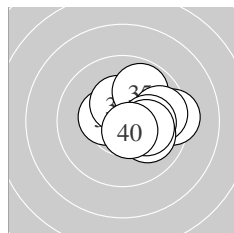

Serie 4:
 9.4 → 10.4 * 10.2 * 10.4 * 9.9 ↗
 9.7 → 10.1 → 10.0 ↘ 10.2 * 10.6 *
 beste Teiler 94.2 (40.) 134.8 (32.) 145.3 (34.)
 Trefferlage 1.50 mm rechts, 0.20 mm hoch
 Streuwert 1.32, horizontal: 1.54, vertikal: 1.05

Unterschrift des Schützen

Meyton Elektronik

Ergebnis: **412.8** (394)
 Serien: 103.5 102.9 103.4 103.0
 Zähler: 34 6 0 0 0 0 0 0 0 0
 Innenzehner: 30
 weiteste: 344 (15), 335 (21), 296 (38)
 beste Teiler 33.5 (6.) 38.4 (19.) 51.3 (28.)
 Trefferlage 0.02 mm links, 0.28 mm tief
 Streuwert 1.24, horizontal: 1.37, vertikal: 1.11

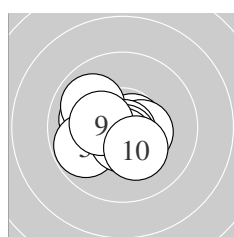
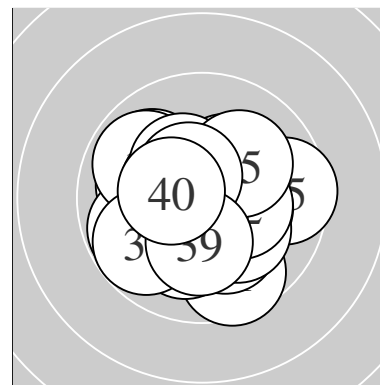

Serie 1:
 10.7 * 10.0 ← 9.9 ↘ 10.4 * 9.8 ↙
 10.8 * 10.7 * 10.6 * 10.3 * 10.3 *
 beste Teiler 33.5 (6.) 65.6 (1.) 66.7 (7.)
 Trefferlage 0.53 mm links, 0.25 mm tief
 Streuwert 1.19, horizontal: 1.42, vertikal: 0.89

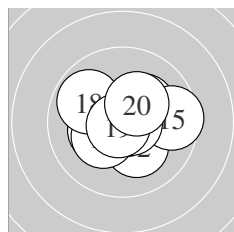

Serie 2:
 10.6 * 10.2 * 10.3 * 10.2 * 9.6 →
 10.7 * 10.3 * 9.9 ↘ 10.8 * 10.3 *
 beste Teiler 38.4 (19.) 53.7 (16.) 90.8 (11.)
 Trefferlage 0.25 mm rechts, 0.10 mm hoch
 Streuwert 1.40, horizontal: 1.70, vertikal: 1.00

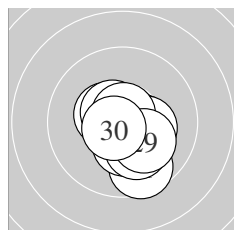

Serie 3:
 9.6 ↓ 10.3 * 10.5 * 10.4 * 10.3 *
 10.1 ↓ 10.6 * 10.7 * 10.2 * 10.7 *
 beste Teiler 51.3 (28.) 74.6 (30.) 99.0 (27.)
 Trefferlage 0.41 mm rechts, 0.70 mm tief
 Streuwert 1.12, horizontal: 1.01, vertikal: 1.21

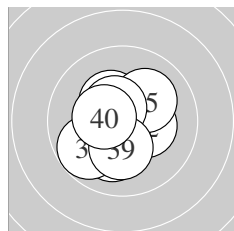

Serie 4:
 10.7 * 10.3 * 10.3 * 10.6 * 10.1 ↗
 10.1 ↓ 10.5 * 9.8 ↙ 10.2 * 10.4 *
 beste Teiler 71.0 (31.) 93.4 (34.) 107.7 (37.)
 Trefferlage 0.23 mm links, 0.29 mm tief
 Streuwert 1.27, horizontal: 1.23, vertikal: 1.31

Unterschrift des Schützen

Meyton Elektronik

Ergebnis: **413.4** (395)
 Serien: 101.6 103.5 104.1 104.2
 Zähler: 35 5 0 0 0 0 0 0 0 0
 Innenzehner: 30
 weiteste: 318 (31), 301 (2), 300 (15)
 beste Teiler 28.8 (22.) 38.1 (40.) 50.2 (17.)
 Trefferlage 0.05 mm rechts, 0.18 mm hoch
 Streuwert 1.22, horizontal: 1.38, vertikal: 1.04

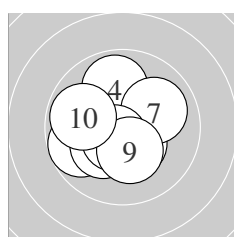
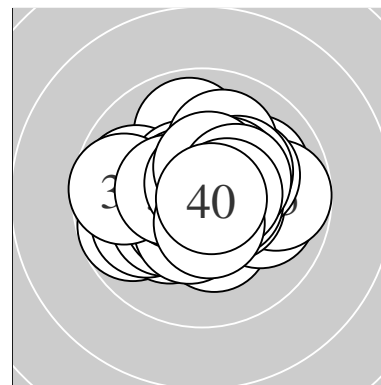

Serie 1:
 10.7 * 9.7 ← 10.0 ↑ 9.9 ↑ 10.4 *
 10.2 * 10.0 → 10.6 * 10.3 * 9.8 ←
 beste Teiler 69.7 (1.) 92.2 (8.) 132.3 (5.)
 Trefferlage 0.48 mm links, 0.03 mm hoch
 Streuwert 1.53, horizontal: 1.51, vertikal: 1.54

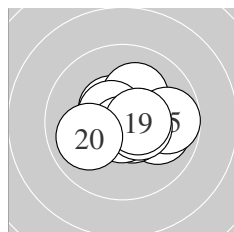

Serie 2:
 10.5 * 10.0 → 10.2 * 10.6 * 9.8 →
 10.6 * 10.8 * 10.5 * 10.5 * 10.0 ←
 beste Teiler 50.2 (17.) 83.4 (14.) 94.4 (16.)
 Trefferlage 0.52 mm rechts, 0.04 mm hoch
 Streuwert 1.24, horizontal: 1.55, vertikal: 0.83

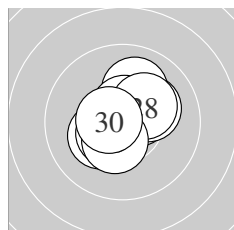

Serie 3:
 10.5 * 10.8 * 10.2 * 10.0 ↑ 10.3 *
 10.6 * 10.5 * 10.2 * 10.4 * 10.6 *
 beste Teiler 28.8 (22.) 91.7 (26.) 93.0 (30.)
 Trefferlage 0.11 mm rechts, 0.31 mm hoch
 Streuwert 1.07, horizontal: 1.09, vertikal: 1.04

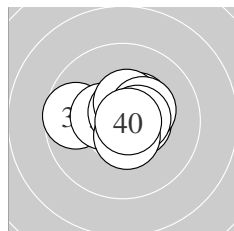

Serie 4:
 9.7 ← 10.4 * 10.7 * 10.4 * 10.4 *
 10.5 * 10.3 * 10.5 * 10.5 * 10.8 *
 beste Teiler 38.1 (40.) 60.6 (33.) 102.4 (38.)
 Trefferlage 0.08 mm rechts, 0.33 mm hoch
 Streuwert 1.07, horizontal: 1.37, vertikal: 0.65

Unterschrift des Schützen

Meyton Elektronik

Ergebnis: **415.1** (397)
 Serien: 103.4 103.4 104.2 104.1
 Zähler: 37 3 0 0 0 0 0 0 0 0
 Innenzehner: 33
 weiteste: 362 (32), 279 (5), 268 (24)
 beste Teiler 23.7 (29.) 56.8 (35.) 65.2 (36.)
 Trefferlage 0.06 mm links, 0.08 mm hoch
 Streuwert 1.14, horizontal: 1.20, vertikal: 1.09

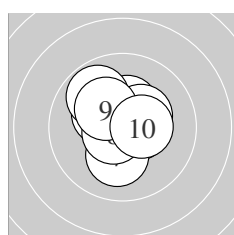
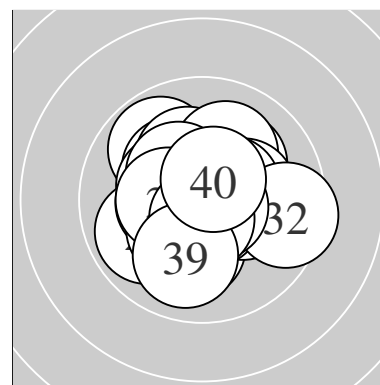

Serie 1:
 10.5 * 10.4 * 10.6 * 10.3 * 9.8 ↖
 10.3 * 10.2 * 10.7 * 10.2 * 10.4 *
 beste Teiler 75.2 (8.) 99.3 (3.) 104.6 (1.)
 Trefferlage 0.03 mm links, 0.43 mm hoch
 Streuwert 1.18, horizontal: 1.19, vertikal: 1.16

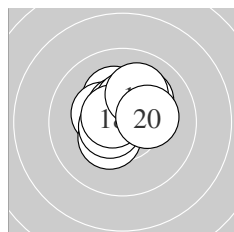

Serie 2:
 10.1 ↗ 10.2 * 10.3 * 10.4 * 10.6 *
 10.5 * 10.4 * 10.6 * 10.1 ↗ 10.2 *
 beste Teiler 82.8 (18.) 94.5 (15.) 101.5 (16.)
 Trefferlage 0.04 mm links, 0.75 mm hoch
 Streuwert 1.03, horizontal: 1.09, vertikal: 0.96

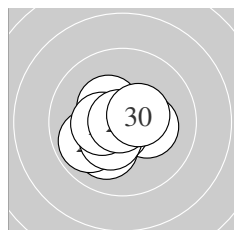

Serie 3:
 10.7 * 10.2 * 10.1 ↙ 9.9 ↙ 10.7 *
 10.4 * 10.4 * 10.4 * 10.9 * 10.5 *
 beste Teiler 23.7 (29.) 66.0 (25.) 68.4 (21.)
 Trefferlage 0.38 mm links, 0.37 mm tief
 Streuwert 1.08, horizontal: 1.25, vertikal: 0.88

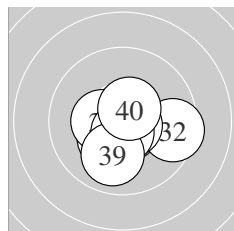

Serie 4:
 10.7 * 9.5 → 10.6 * 10.3 * 10.7 *
 10.7 * 10.4 * 10.6 * 10.0 ↓ 10.6 *
 beste Teiler 56.8 (35.) 65.2 (36.) 70.3 (31.)
 Trefferlage 0.19 mm rechts, 0.48 mm tief
 Streuwert 1.17, horizontal: 1.37, vertikal: 0.93

Unterschrift des Schützen

Meyton Elektronik

Ergebnis: **411.9** (390)
 Serien: 101.7 102.5 104.3 103.4
 Zähler: 30 10 0 0 0 0 0 0 0 0
 Innenzehner: 27
 weiteste: 335 (39), 312 (7), 291 (37)
 beste Teiler 41.8 (26.) 51.7 (32.) 60.9 (33.)
 Trefferlage 0.04 mm rechts, 0.41 mm hoch
 Streuwert 1.27, horizontal: 1.23, vertikal: 1.30

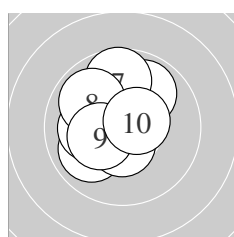
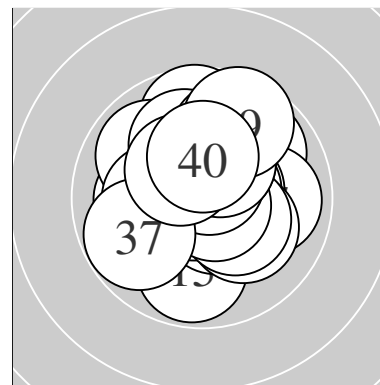

Serie 1:
 9.9 ↙ 10.5 * 10.1 ← 10.3 * 9.9 ↗
 10.6 * 9.7 ↑ 9.9 ↘ 10.3 * 10.5 *
 beste Teiler 96.3 (6.) 102.9 (10.) 108.0 (2.)
 Trefferlage 0.70 mm links, 0.47 mm hoch
 Streuwert 1.41, horizontal: 1.30, vertikal: 1.51

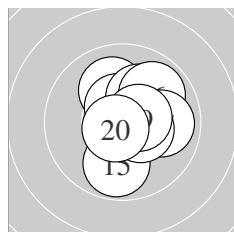

Serie 2:
 10.5 * 10.1 ↑ 10.5 * 10.2 * 9.8 ↓
 9.9 ↗ 9.9 → 10.4 * 10.5 * 10.7 *
 beste Teiler 63.7 (20.) 105.9 (13.) 110.8 (19.)
 Trefferlage 0.71 mm rechts, 0.30 mm hoch
 Streuwert 1.30, horizontal: 1.13, vertikal: 1.44

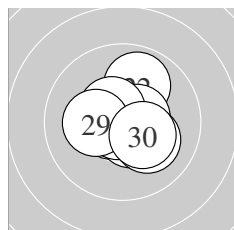

Serie 3:
 10.6 * 9.9 ↑ 10.6 * 10.6 * 10.7 *
 10.8 * 10.1 ↘ 10.5 * 10.2 * 10.3 *
 beste Teiler 41.8 (26.) 68.1 (25.) 77.1 (21.)
 Trefferlage 0.12 mm rechts, 0.01 mm hoch
 Streuwert 1.08, horizontal: 1.12, vertikal: 1.04

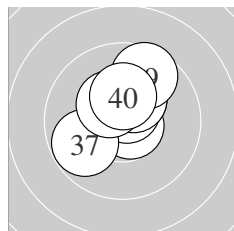

Serie 4:
 10.7 * 10.7 * 10.7 * 10.3 * 10.6 *
 10.3 * 9.8 ↙ 10.4 * 9.6 ↗ 10.3 *
 beste Teiler 51.7 (32.) 60.9 (33.) 74.8 (31.)
 Trefferlage 0.02 mm rechts, 0.87 mm hoch
 Streuwert 1.16, horizontal: 1.10, vertikal: 1.21

Unterschrift des Schützen

Meyton Elektronik

Ergebnis: **410.1** (391)
 Serien: 103.2 101.3 102.2 103.4
 Zähler: 31 9 0 0 0 0 0 0 0 0
 Innenzehner: 28
 weiteste: 360 (13), 355 (5), 318 (29)
 beste Teiler 23.3 (40.) 33.2 (15.) 70.1 (9.)
 Trefferlage 0.02 mm links, 0.07 mm hoch
 Streuwert 1.38, horizontal: 1.64, vertikal: 1.05

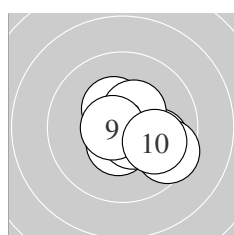
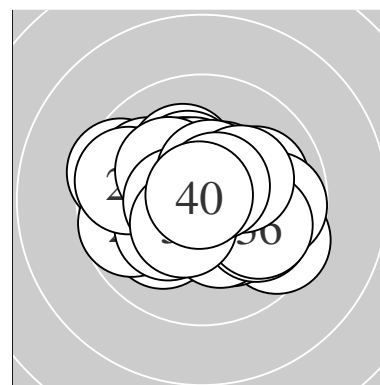

Serie 1:
 10.6 * 9.9 ↘ 10.6 * 10.5 * 9.5 ↘
 10.6 * 10.4 * 10.4 * 10.7 * 10.0 ↘
 beste Teiler 70.1 (9.) 88.5 (1.) 98.3 (6.)
 Trefferlage 0.76 mm rechts, 0.16 mm tief
 Streuwert 1.23, horizontal: 1.38, vertikal: 1.06

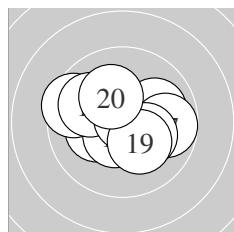

Serie 2:
 10.2 * 10.5 * 9.5 ↖ 9.9 ↖ 10.8 *
 10.0 → 9.8 → 10.2 * 10.2 * 10.2 *
 beste Teiler 33.2 (15.) 107.0 (12.) 180.8 (19.)
 Trefferlage 0.05 mm links, 0.12 mm hoch
 Streuwert 1.65, horizontal: 2.07, vertikal: 1.07

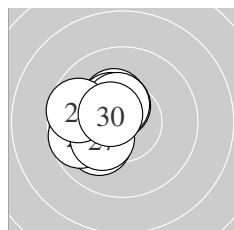

Serie 3:
 10.3 * 10.5 * 10.4 * 10.4 * 10.1 ↗
 9.7 ← 10.2 * 10.4 * 9.7 ← 10.5 *
 beste Teiler 101.2 (30.) 118.8 (22.) 126.5 (28.)
 Trefferlage 1.26 mm links, 0.40 mm hoch
 Streuwert 1.07, horizontal: 1.01, vertikal: 1.13

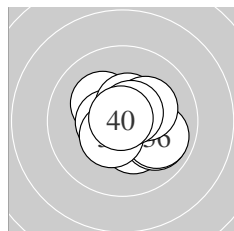

Serie 4:
 10.2 * 10.3 * 10.5 * 9.9 ↘ 10.5 *
 9.9 ↘ 10.2 * 10.4 * 10.6 * 10.9 *
 beste Teiler 23.3 (40.) 82.7 (39.) 105.1 (33.)
 Trefferlage 0.46 mm rechts, 0.07 mm tief
 Streuwert 1.18, horizontal: 1.33, vertikal: 1.02

Unterschrift des Schützen

Meyton Elektronik