

Ergebnis:	612.8	(582)
Serien:	103.6	101.3 100.8 104.5 103.8 98.8
Zähler:	42	18 0 0 0 0 0 0 0 0
Innenzehner:	38	
weiteste:	426	(55), 382 (52), 368 (23)
beste Teiler	3.0	(5.) 30.0 (41.) 33.9 (47.)
Trefferlage	0.11 mm	links, 0.69 mm hoch
Streuwert	1.44,	horizontal: 1.50, vertikal: 1.37

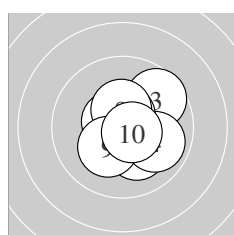

Serie 1:

10.5 *	10.2 *	9.7 ↗	9.9 ↘	10.9 *
10.6 *	10.6 *	10.4 *	10.2 *	10.6 *
beste Teiler	3.0 (5.)	77.8 (10.)	87.6 (7.)	
Trefferlage	0.43 mm rechts, 0.08 mm tief			
Streuwert	1.24, horizontal: 1.23, vertikal: 1.25			

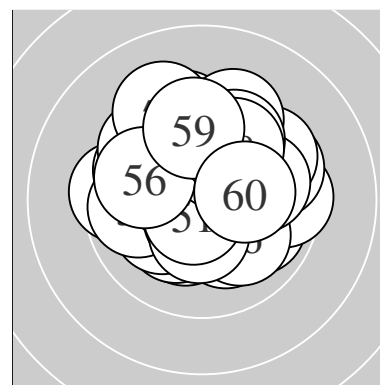
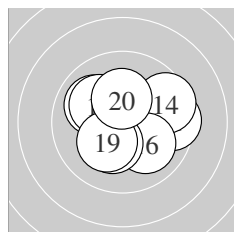

Serie 2:

9.5 →	10.6 *	10.7 *	9.6 ↗	10.0 ↘
10.0 ↘	10.1 ↖	10.3 *	10.2 *	10.3 *
beste Teiler	62.0 (13.)	82.2 (12.)	172.6 (18.)	
Trefferlage	0.24 mm rechts, 0.00 mm			
Streuwert	1.68, horizontal: 1.96, vertikal: 1.33			

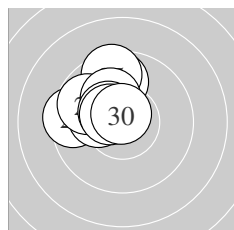

Serie 3:

10.2 *	9.8 ↑	9.5 ←	10.2 *	9.5 ↑
9.8 ↖	10.2 *	10.4 *	10.5 *	10.7 *
beste Teiler	61.9 (30.)	110.7 (29.)	131.6 (28.)	
Trefferlage	1.30 mm links, 1.38 mm hoch			
Streuwert	1.10, horizontal: 1.09, vertikal: 1.10			

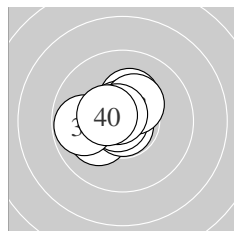

Serie 4:

10.3 *	10.5 *	10.6 *	10.1 ↖	10.8 *
10.8 *	9.8 ←	10.4 *	10.7 *	10.5 *
beste Teiler	35.0 (36.)	37.2 (35.)	64.8 (39.)	
Trefferlage	0.50 mm links, 0.37 mm hoch			
Streuwert	0.99, horizontal: 1.13, vertikal: 0.82			

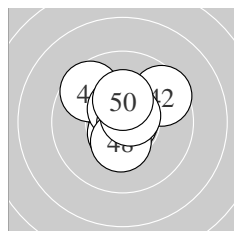

Serie 5:

10.8 *	9.6 ↗	10.5 *	9.6 ↘	10.6 *
10.5 *	10.8 *	10.4 *	10.7 *	10.3 *
beste Teiler	30.0 (41.)	33.9 (47.)	73.8 (49.)	
Trefferlage	0.00 mm, 0.62 mm hoch			
Streuwert	1.24, horizontal: 1.29, vertikal: 1.19			

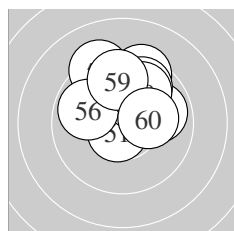

Serie 6:

10.7 *	9.4 ↑	10.2 *	9.9 →	9.2 ↑
9.9 ↖	9.7 ↑	9.9 ↑	9.7 ↑	10.2 *
beste Teiler	73.5 (51.)	193.1 (60.)	198.4 (53.)	
Trefferlage	0.44 mm rechts, 1.89 mm hoch			
Streuwert	1.57, horizontal: 1.65, vertikal: 1.49			

Meyton Elektronik

ISSF AR Women – Wertung – Frauen

StandNr: 121

Juriga, Nadja #275

StartNr: 18

8. Dezember 2018 10:15

Salzburger LV

Unterschrift des Schützen

Meyton Elektronik

Ergebnis:	609.0	(584)							
Serien:	101.8	102.4	101.0	102.3	98.5	103.0			
Zähler:	44	16	0	0	0	0	0	0	0
Innenzehner:	32								
weiteste:	418 (46), 380 (50), 377 (3)								
beste Teiler	30.0 (53.)	38.1 (1.)	55.9 (5.)						
Trefferlage	0.33 mm rechts, 0.16 mm hoch								
Streuwert	1.56, horizontal: 1.84, vertikal: 1.23								

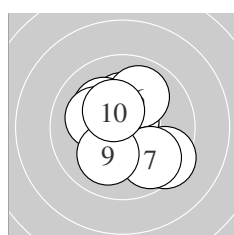
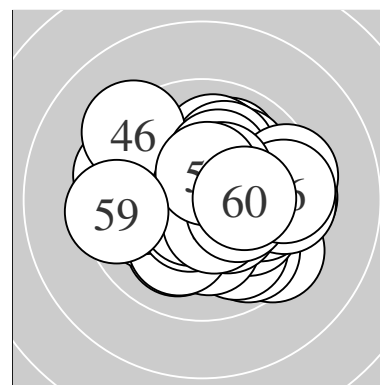

Serie 1:	10.8 *	10.3 *	9.4 ↘	10.2 *	10.7 *
	10.0 ↗	9.8 ↘	10.1 ←	10.1 ↙	10.4 *
beste Teiler	38.1 (1.)	55.9 (5.)	136.9 (10.)		
Trefferlage	0.15 mm rechts, 0.16 mm hoch				
Streuwert	1.61, horizontal: 1.56, vertikal: 1.67				

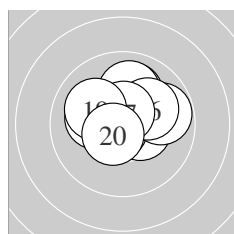

Serie 2:	10.0 ↗	10.4 *	10.7 *	9.8 →	10.0 ↑
	10.1 ↘	10.6 *	10.2 *	10.1 ↖	10.5 *
beste Teiler	56.2 (13.)	86.2 (17.)	101.1 (20.)		
Trefferlage	0.20 mm rechts, 0.73 mm hoch				
Streuwert	1.31, horizontal: 1.53, vertikal: 1.04				

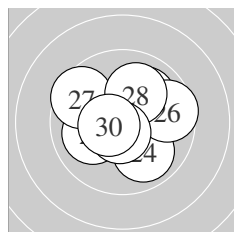

Serie 3:	10.4 *	10.0 ←	10.4 *	9.9 ↘	10.0 ↗
	9.6 →	9.6 ↖	10.0 ↑	10.6 *	10.5 *
beste Teiler	78.5 (29.)	101.6 (30.)	128.1 (23.)		
Trefferlage	0.30 mm rechts, 0.35 mm hoch				
Streuwert	1.64, horizontal: 1.89, vertikal: 1.36				

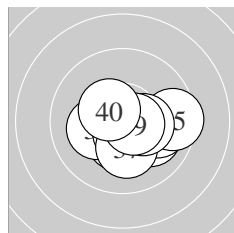

Serie 4:	10.4 *	10.2 *	10.1 ↘	9.9 →	9.5 →
	10.6 *	10.2 *	10.3 *	10.6 *	10.5 *
beste Teiler	82.9 (39.)	84.3 (36.)	125.6 (40.)		
Trefferlage	0.76 mm rechts, 0.56 mm tief				
Streuwert	1.30, horizontal: 1.66, vertikal: 0.76				

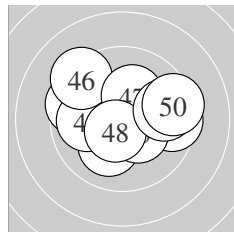

Serie 5:	9.5 →	9.5 ←	10.1 ↙	9.9 ←	10.4 *
	9.3 ↖	10.2 *	10.5 *	9.7 →	9.4 →
beste Teiler	101.3 (48.)	145.4 (45.)	182.0 (47.)		
Trefferlage	0.16 mm rechts, 0.34 mm hoch				
Streuwert	2.14, horizontal: 2.68, vertikal: 1.42				

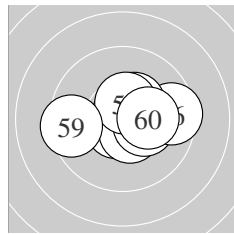

Serie 6:	10.7 *	10.6 *	10.8 *	10.5 *	10.3 *
	9.5 →	10.4 *	10.5 *	9.5 ←	10.2 *
beste Teiler	30.0 (53.)	57.5 (51.)	76.6 (52.)		
Trefferlage	0.42 mm rechts, 0.00 mm				
Streuwert	1.42, horizontal: 1.87, vertikal: 0.73				

Meyton Elektronik

ISSF AR Women – Wertung – Frauen

StandNr: 122

Groeneboom, Iris #276

StartNr: 19

8. Dezember 2018 10:08

NED

Unterschrift des Schützen

Meyton Elektronik

Ergebnis: **585.8** (559)

Serien: 99.6 96.3 97.3 97.2 96.9 98.5

Zähler: 25 30 4 1 0 0 0 0 0 0

Innenzehner: 20

weiteste: 783 (60), 709 (45), 544 (21)

beste Teiler 42.3 (43.) 42.7 (30.) 49.0 (6.)

Trefferlage 0.04 mm rechts, 0.93 mm hoch

Streuwert 2.32, horizontal: 2.79, vertikal: 1.73

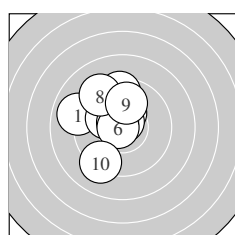
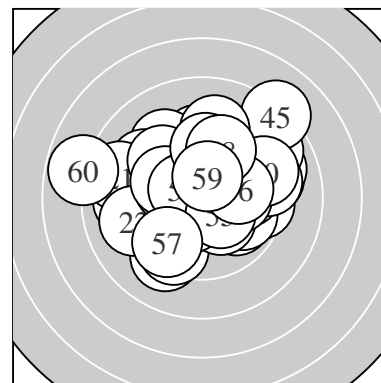

Serie 1:

9.0 ↖	10.3 *	10.2 *	10.7 *	10.7 *
10.8 *	9.5 ↑	9.3 ↘	9.9 ↑	9.2 ↙

beste Teiler 49.0 (6.) 59.4 (4.) 74.2 (5.)

Trefferlage 1.18 mm links, 1.09 mm hoch

Streuwert 1.89, horizontal: 1.64, vertikal: 2.11

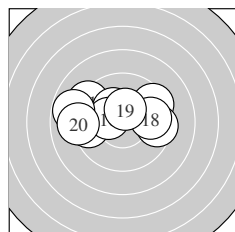

Serie 2:

9.2 ↖	9.5 ←	9.5 ↗	10.3 *	9.5 →
10.3 *	8.8 ←	9.7 →	10.4 *	9.1 ←

beste Teiler 140.8 (19.) 155.2 (16.) 175.3 (14.)

Trefferlage 0.96 mm links, 0.78 mm hoch

Streuwert 2.50, horizontal: 3.40, vertikal: 0.96

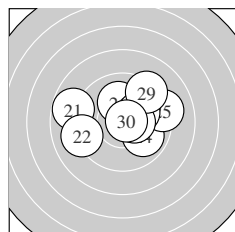

Serie 3:

8.8 ↖	9.1 ←	9.6 ↗	9.9 ↘	9.2 →
10.1 ↑	10.1 ↗	10.4 *	9.3 ↗	10.8 *

beste Teiler 42.7 (30.) 126.0 (28.) 202.7 (27.)

Trefferlage 0.54 mm rechts, 0.78 mm hoch

Streuwert 2.45, horizontal: 3.12, vertikal: 1.49

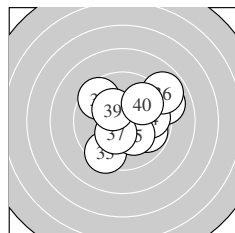

Serie 4:

9.0 →	9.8 ↘	9.4 ↙	9.8 →	10.2 *
8.9 ↗	10.4 *	9.6 ↘	10.3 *	9.8 ↗

beste Teiler 146.4 (37.) 160.3 (39.) 185.1 (35.)

Trefferlage 1.13 mm rechts, 0.36 mm hoch

Streuwert 2.30, horizontal: 2.52, vertikal: 2.05

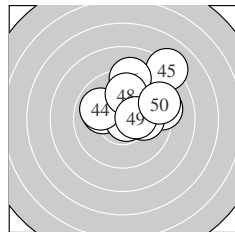

Serie 5:

10.1 ↖	9.2 →	10.8 *	9.9 ↖	8.1 ↗
9.2 ↑	10.1 →	9.9 ↑	10.4 *	9.2 →

beste Teiler 42.3 (43.) 143.6 (49.) 220.4 (41.)

Trefferlage 1.36 mm rechts, 1.68 mm hoch

Streuwert 2.19, horizontal: 2.46, vertikal: 1.87

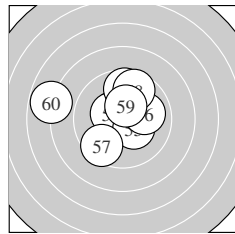

Serie 6:

10.5 *	10.3 *	10.4 *	9.7 ↑	10.3 *
10.0 →	9.5 ↙	9.6 ↑	10.4 *	7.8 ←

beste Teiler 116.7 (51.) 134.1 (53.) 143.0 (59.)

Trefferlage 0.59 mm links, 0.91 mm hoch

Streuwert 2.36, horizontal: 2.80, vertikal: 1.80

ISSF AR Women – Wertung – Frauen

StandNr: 123

Moser, Arinette #220

StartNr: 20

8. Dezember 2018 10:14

Liechtensein

Unterschrift des Schützen

Meyton Elektronik

Ergebnis: **622.5** (594)^{QF}
 Serien: 103.8 104.0 102.5 105.0 103.9 103.3
 Zähler: 54 6 0 0 0 0 0 0 0
 Innenzehner: 47
 weiteste: 485 (23), 466 (56), 308 (47)
 beste Teiler 20.8 (31.) 34.4 (38.) 35.5 (13.)
 Trefferlage 0.03 mm rechts, 0.07 mm tief
 Streuwert 1.22, horizontal: 1.34, vertikal: 1.08

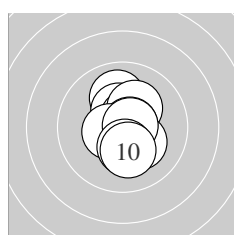
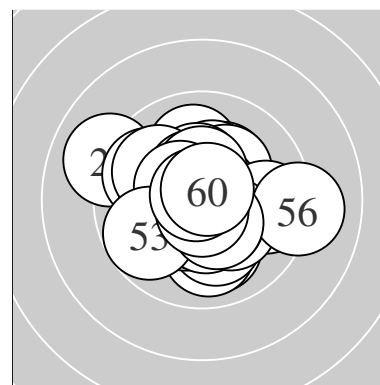

Serie 1:
 10.0 ↑ 10.4 * 10.6 * 10.2 * 10.2 *
 10.7 * 10.5 * 10.7 * 10.3 * 10.2 *
 beste Teiler 60.7 (6.) 62.1 (8.) 87.3 (3.)
 Trefferlage 0.27 mm rechts, 0.12 mm hoch
 Streuwert 1.11, horizontal: 0.70, vertikal: 1.40

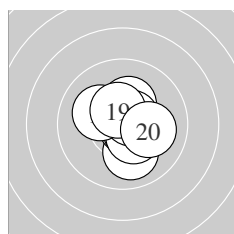

Serie 2:
 10.0 ↓ 10.6 * 10.8 * 10.6 * 10.3 *
 10.4 * 10.6 * 10.1 ↖ 10.5 * 10.1 →
 beste Teiler 35.5 (13.) 77.2 (12.) 81.8 (14.)
 Trefferlage 0.42 mm rechts, 0.00 mm
 Streuwert 1.06, horizontal: 0.99, vertikal: 1.12

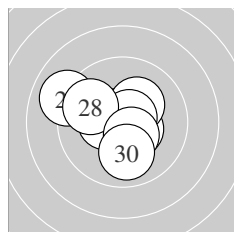

Serie 3:
 10.6 * 10.5 * 9.0 ↖ 10.8 * 10.4 *
 10.2 * 10.7 * 9.8 ↖ 10.5 * 10.0 ↓
 beste Teiler 42.7 (24.) 64.6 (27.) 83.0 (21.)
 Trefferlage 0.56 mm links, 0.17 mm hoch
 Streuwert 1.56, horizontal: 1.80, vertikal: 1.27

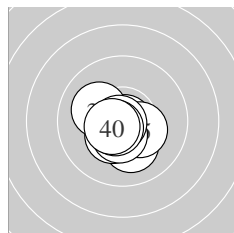

Serie 4:
 10.9 * 10.7 * 10.1 ↓ 10.4 * 10.3 *
 10.5 * 10.1 ↖ 10.8 * 10.6 * 10.6 *
 beste Teiler 20.8 (31.) 34.4 (38.) 61.0 (32.)
 Trefferlage 0.29 mm links, 0.56 mm tief
 Streuwert 0.82, horizontal: 0.89, vertikal: 0.75

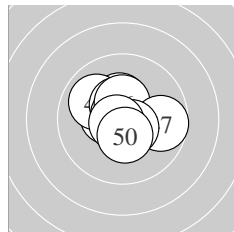

Serie 5:
 10.5 * 10.4 * 9.9 ↖ 10.5 * 10.8 *
 10.4 * 9.7 → 10.6 * 10.7 * 10.4 *
 beste Teiler 48.7 (45.) 57.1 (49.) 95.4 (48.)
 Trefferlage 0.09 mm links, 0.32 mm hoch
 Streuwert 1.18, horizontal: 1.35, vertikal: 0.98

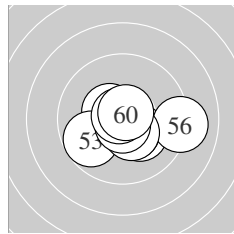

Serie 6:
 10.5 * 10.6 * 9.8 ↖ 10.2 * 10.4 *
 9.1 → 10.4 * 10.8 * 10.8 * 10.7 *
 beste Teiler 37.5 (59.) 50.0 (58.) 56.7 (60.)
 Trefferlage 0.45 mm rechts, 0.50 mm tief
 Streuwert 1.41, horizontal: 1.84, vertikal: 0.75

Meyton Elektronik

ISSF AR Women – Wertung – Frauen

StandNr: 124

Brazdova, Lucie #277

StartNr: 21

8. Dezember 2018 10:08

CZE

QF – Schütze hat sich fürs Finale qualifiziert

Unterschrift des Schützen

Meyton Elektronik

Ergebnis:	591.3	(565)							
Serien:	96.6	98.2	98.1	99.1	102.7	96.6			
Zähler:	28	29	3	0	0	0	0	0	0
Innenzehner:	19								
weiteste:	734 (56), 554 (34), 522 (15)								
beste Teiler	4.2 (45.) 61.0 (29.) 100.0 (14.)								
Trefferlage	0.19 mm links, 0.29 mm hoch								
Streuwert	2.14, horizontal: 2.36, vertikal: 1.89								

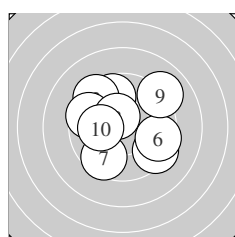
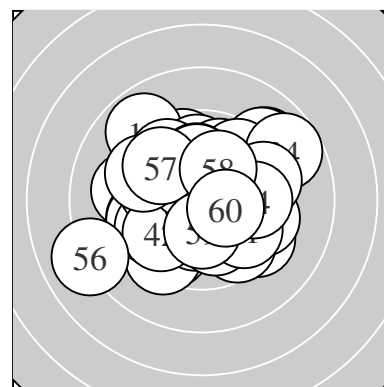

Serie 1:

9.8 ↖	9.7 ↗	9.4 ↘	9.6 ↖	9.4 ↘
9.5 →	9.6 ↙	10.5 *	9.0 ↗	10.1 ←
beste Teiler	118.5 (8.) 214.0 (10.) 289.5 (1.)			
Trefferlage	0.36 mm links, 0.61 mm hoch			
Streuwert	2.47, horizontal: 2.75, vertikal: 2.16			

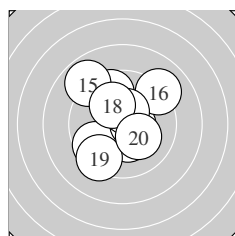

Serie 2:

10.3 *	9.6 ↙	9.6 ↗	10.6 *	8.9 ↘
9.1 ↗	10.4 *	10.1 ↘	9.4 ↙	10.2 *
beste Teiler	100.0 (14.) 128.1 (17.) 154.9 (11.)			
Trefferlage	0.35 mm links, 0.52 mm hoch			
Streuwert	2.31, horizontal: 2.12, vertikal: 2.49			

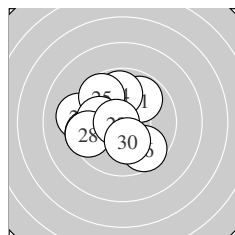

Serie 3:

9.8 ↗	9.2 ←	9.5 ←	9.9 ↑	9.7 ↘
9.6 ↘	10.0 ←	9.5 ←	10.7 *	10.2 *
beste Teiler	61.0 (29.) 188.9 (30.) 226.3 (27.)			
Trefferlage	1.19 mm links, 0.16 mm hoch			
Streuwert	2.03, horizontal: 2.19, vertikal: 1.86			

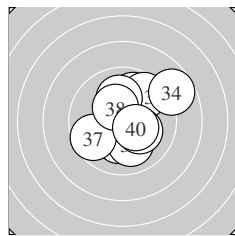

Serie 4:

10.2 *	9.9 ↑	9.7 ↗	8.7 ↗	10.0 ↓
10.1 ↑	9.6 ↙	10.3 *	10.2 *	10.4 *
beste Teiler	142.2 (40.) 151.1 (38.) 191.2 (39.)			
Trefferlage	0.73 mm rechts, 0.41 mm hoch			
Streuwert	2.03, horizontal: 2.02, vertikal: 2.04			

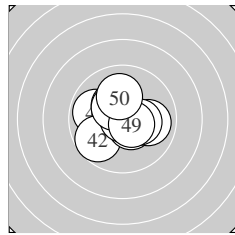

Serie 5:

9.9 ↖	9.7 ↙	10.3 *	10.5 *	10.9 *
10.0 →	10.4 *	10.3 *	10.6 *	10.1 ↑
beste Teiler	4.2 (45.) 100.8 (49.) 110.4 (44.)			
Trefferlage	0.11 mm links, 0.14 mm hoch			
Streuwert	1.43, horizontal: 1.63, vertikal: 1.19			

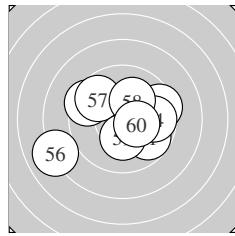

Serie 6:

9.7 ↘	10.0 →	9.4 →	9.7 →	9.4 ↖
8.0 ↙	9.7 ↘	10.1 ↑	10.2 *	10.4 *
beste Teiler	145.1 (60.) 177.0 (59.) 203.9 (58.)			
Trefferlage	0.13 mm rechts, 0.07 mm tief			
Streuwert	2.64, horizontal: 3.28, vertikal: 1.78			

Meyton Elektronik

ISSF AR Women – Wertung – Frauen

StandNr: 125

Schlichtherle, Vanessa #81

StartNr: 22

8. Dezember 2018 10:14

T – SG Walchsee

Unterschrift des Schützen

Meyton Elektronik

Ergebnis:	606.6	(580)
Serien:	98.7	101.0 102.0 103.4 100.0 101.5
Zähler:	40	20 0 0 0 0 0 0 0 0
Innenzehner:	30	
weiteste:	439 (60), 414 (42), 406 (8)	
beste Teiler	18.7 (35.)	33.5 (46.) 47.6 (33.)
Trefferlage	0.56 mm rechts,	0.24 mm hoch
Streuwert	1.62, horizontal:	1.70, vertikal: 1.55

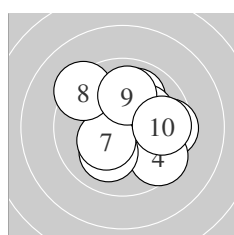
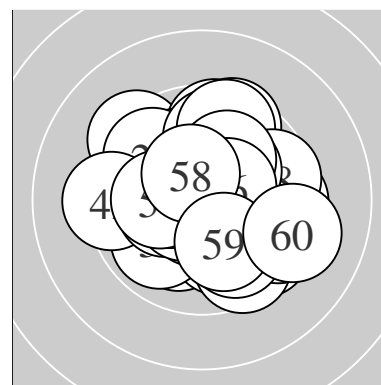

Serie 1:	10.0 ↗	9.5 →	10.0 →	9.5 ↘	10.1 ↙
	10.2 *	10.3 *	9.3 ↘	10.0 ↑	9.8 →
beste Teiler	160.5 (7.)	198.2 (6.)	218.9 (5.)		
Trefferlage	0.93 mm rechts, 0.34 mm hoch				
Streuwert	1.96, horizontal: 2.14, vertikal: 1.76				

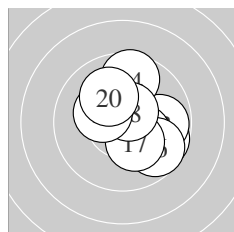

Serie 2:	9.7 ↘	10.7 *	9.8 →	9.6 ↑	10.3 *
	9.7 ↘	10.2 *	10.6 *	10.3 *	10.1 ↘
beste Teiler	66.4 (12.)	93.2 (18.)	166.8 (19.)		
Trefferlage	0.86 mm rechts, 0.15 mm hoch				
Streuwert	1.59, horizontal: 1.56, vertikal: 1.63				

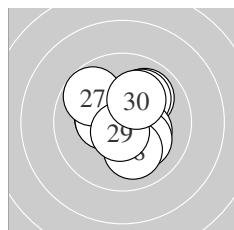

Serie 3:	10.4 *	10.0 ↗	10.0 ↗	10.3 *	10.4 *
	10.2 *	9.8 ↘	10.1 ↓	10.6 *	10.2 *
beste Teiler	76.6 (29.)	137.8 (25.)	145.5 (21.)		
Trefferlage	0.27 mm rechts, 0.29 mm hoch				
Streuwert	1.47, horizontal: 1.47, vertikal: 1.48				

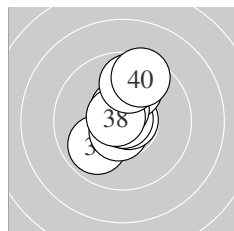

Serie 4:	9.9 ↙	10.6 *	10.8 *	10.7 *	10.9 *
	9.9 ↑	10.6 *	10.7 *	9.8 ↑	9.5 ↑
beste Teiler	18.7 (35.)	47.6 (33.)	61.0 (38.)		
Trefferlage	0.00 mm , 0.81 mm hoch				
Streuwert	1.31, horizontal: 0.89, vertikal: 1.62				

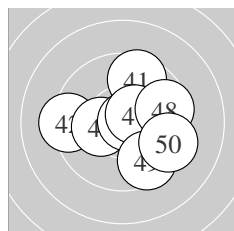

Serie 5:	9.6 ↑	9.3 ←	10.4 *	10.5 *	10.3 *
	10.8 *	10.5 *	9.6 →	9.6 ↘	9.4 ↘
beste Teiler	33.5 (46.)	109.6 (47.)	112.0 (44.)		
Trefferlage	0.75 mm rechts, 0.00 mm				
Streuwert	1.94, horizontal: 2.24, vertikal: 1.60				

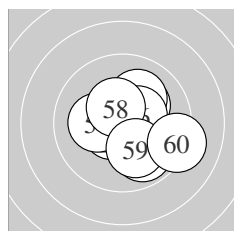

Serie 6:	10.2 *	9.9 ↘	10.1 ↗	10.6 *	10.4 *
	10.4 *	10.2 *	10.4 *	10.1 ↓	9.2 →
beste Teiler	98.1 (54.)	128.7 (56.)	130.7 (58.)		
Trefferlage	0.56 mm rechts, 0.11 mm tief				
Streuwert	1.61, horizontal: 1.78, vertikal: 1.42				

ISSF AR Women – Wertung – Frauen

StandNr: 126

Kathrein, Barbara #278

StartNr: 23

8. Dezember 2018 9:47

T – SG Kaunertal

Unterschrift des Schützen

Meyton Elektronik

Ergebnis: **593.9** (564)

Serien: 93.8 98.4 102.2 100.1 99.2 100.2

Zähler: 30 25 4 1 0 0 0 0 0 0

Innenzehner: 25

weiteste: 779 (12), 592 (3), 571 (1)

beste Teiler 30.0 (50.) 73.0 (25.) 75.0 (15.)

Trefferlage 0.33 mm links, 0.42 mm hoch

Streuwert 2.13, horizontal: 2.47, vertikal: 1.72

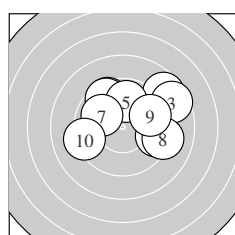
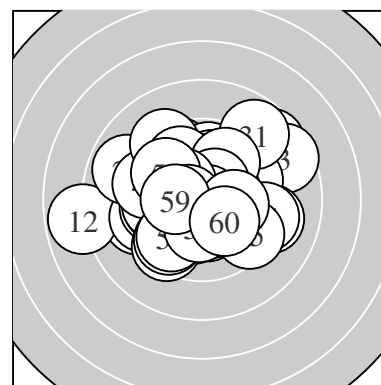

Serie 1:

8.7 ↗	9.6 ↘	8.6 ↗	9.6 ↘	9.8 ↑
9.5 →	9.9 ↖	9.2 →	9.7 →	9.2 ←

beste Teiler 256.6 (7.) 279.8 (5.) 323.0 (9.)

Trefferlage 1.12 mm rechts, 1.43 mm hoch

Streuwert 2.76, horizontal: 3.38, vertikal: 1.94

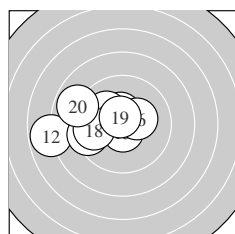

Serie 2:

10.4 *	7.8 ←	10.5 *	9.4 ←	10.7 *
10.3 *	10.1 ↖	9.7 ←	10.6 *	8.9 ↖

beste Teiler 75.0 (15.) 81.5 (19.) 121.2 (13.)

Trefferlage 2.10 mm links, 0.28 mm hoch

Streuwert 2.10, horizontal: 2.76, vertikal: 1.12

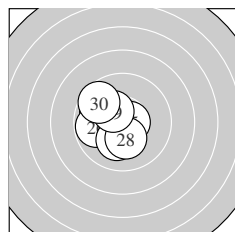

Serie 3:

9.9 ↖	10.6 *	10.4 *	10.4 *	10.7 *
9.8 ←	10.2 *	10.3 *	10.3 *	9.6 ↖

beste Teiler 73.0 (25.) 86.2 (22.) 137.0 (24.)

Trefferlage 1.11 mm links, 0.06 mm tief

Streuwert 1.26, horizontal: 1.19, vertikal: 1.32

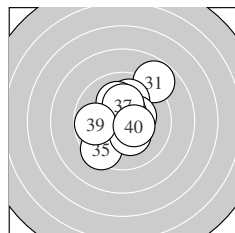

Serie 4:

8.8 ↗	10.0 ↑	10.1 ↘	10.4 *	9.4 ↘
10.6 *	10.3 *	10.3 *	9.8 ←	10.4 *

beste Teiler 86.5 (36.) 133.1 (40.) 149.0 (34.)

Trefferlage 0.20 mm rechts, 0.62 mm hoch

Streuwert 1.95, horizontal: 1.82, vertikal: 2.07

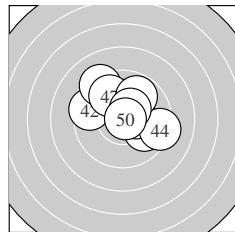

Serie 5:

9.9 ↖	9.5 ↖	10.4 *	9.3 →	9.2 ↘
10.1 ↑	9.8 ↘	9.8 ↗	10.4 *	10.8 *

beste Teiler 30.0 (50.) 134.8 (49.) 145.4 (43.)

Trefferlage 0.31 mm rechts, 1.04 mm hoch

Streuwert 1.96, horizontal: 2.26, vertikal: 1.61

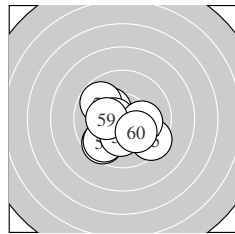

Serie 6:

9.6 ↘	10.3 *	9.7 ↘	9.8 ↖	9.4 ↖
10.6 *	10.1 →	10.2 *	10.3 *	10.2 *

beste Teiler 92.0 (56.) 172.0 (59.) 174.6 (52.)

Trefferlage 0.41 mm links, 0.76 mm tief

Streuwert 1.74, horizontal: 1.94, vertikal: 1.51

Meyton Elektronik

ISSF AR Women – Wertung – Frauen

StandNr: 127

Höbl, Tanja #279

StartNr: 24

8. Dezember 2018 9:51

KLSV

Unterschrift des Schützen

Meyton Elektronik

Ergebnis:	627.6	(595) ^{QF}					
Serien:	104.3	104.9	105.2	104.7	104.9	103.6	
Zähler:	55	5	0	0	0	0	0
Innenzehner:	50						
weiteste:	365 (23), 292 (3), 284 (54)						
beste Teiler	3.1 (29.) 17.0 (48.) 21.0 (27.)						
Trefferlage	0.13 mm rechts, 0.15 mm hoch						
Streuwert	1.04, horizontal: 1.23, vertikal: 0.80						

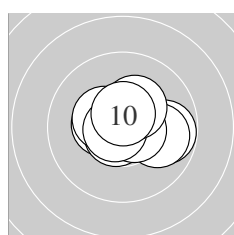
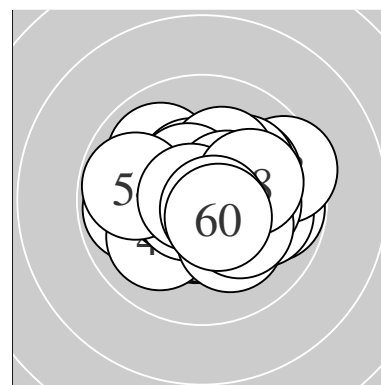

Serie 1:					
	10.4 *	10.7 *	9.8 →	10.8 *	10.0 →
	10.4 *	10.6 *	10.7 *	10.3 *	10.6 *
beste Teiler	29.4 (4.) 55.6 (8.) 67.9 (2.)				
Trefferlage	0.31 mm rechts, 0.12 mm hoch				
Streuwert	1.12, horizontal: 1.44, vertikal: 0.65				

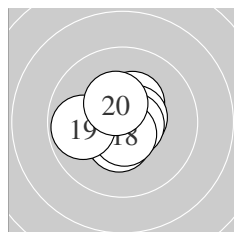

Serie 2:					
	10.8 *	10.7 *	10.5 *	10.4 *	10.4 *
	10.6 *	10.7 *	10.6 *	9.8 ←	10.4 *
beste Teiler	40.0 (11.) 68.1 (17.) 70.6 (12.)				
Trefferlage	0.22 mm links, 0.06 mm hoch				
Streuwert	0.97, horizontal: 1.05, vertikal: 0.88				

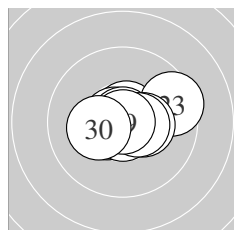

Serie 3:					
	10.7 *	10.7 *	9.5 →	10.5 *	10.4 *
	10.8 *	10.9 *	10.5 *	10.9 *	10.3 *
beste Teiler	3.1 (29.) 21.0 (27.) 49.0 (26.)				
Trefferlage	0.29 mm rechts, 0.06 mm hoch				
Streuwert	1.08, horizontal: 1.43, vertikal: 0.55				

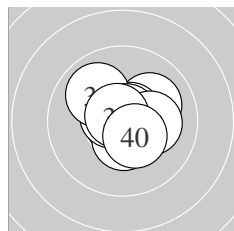

Serie 4:					
	10.8 *	10.1 ↗	10.5 *	10.6 *	10.7 *
	9.9 ↘	10.8 *	10.2 *	10.7 *	10.4 *
beste Teiler	44.4 (37.) 48.0 (31.) 55.1 (39.)				
Trefferlage	0.21 mm rechts, 0.21 mm hoch				
Streuwert	1.03, horizontal: 1.15, vertikal: 0.90				

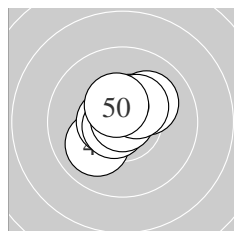

Serie 5:					
	10.5 *	10.6 *	10.0 ↙	10.6 *	10.6 *
	10.7 *	10.1 ↗	10.9 *	10.4 *	10.5 *
beste Teiler	17.0 (48.) 66.1 (46.) 78.7 (44.)				
Trefferlage	0.16 mm links, 0.34 mm hoch				
Streuwert	0.96, horizontal: 1.00, vertikal: 0.91				

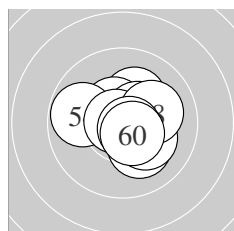

Serie 6:					
	10.2 *	10.2 *	10.5 *	9.8 ←	10.5 *
	10.2 *	10.8 *	10.1 →	10.7 *	10.6 *
beste Teiler	47.2 (57.) 61.8 (59.) 99.7 (60.)				
Trefferlage	0.39 mm rechts, 0.09 mm hoch				
Streuwert	1.21, horizontal: 1.38, vertikal: 1.02				

Meyton Elektronik

ISSF AR Women – Wertung – Frauen

StandNr: 128

Vognarova, Gabriela #229

StartNr: 25

8. Dezember 2018 10:01

CZE

QF – Schütze hat sich fürs Finale qualifiziert

Unterschrift des Schützen

Meyton Elektronik

Ergebnis: **608.3** (579)

Serien: 102.0 100.1 101.8 101.1 101.5 101.8

Zähler: 40 19 1 0 0 0 0 0 0

Innenzehner: 34

weiteste: 662 (36), 444 (11), 406 (44)

beste Teiler 18.6 (42.) 42.7 (4.) 50.2 (39.)

Trefferlage 0.64 mm rechts, 0.69 mm hoch

Streuwert 1.51, horizontal: 1.75, vertikal: 1.23

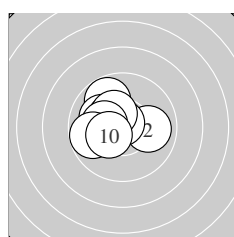
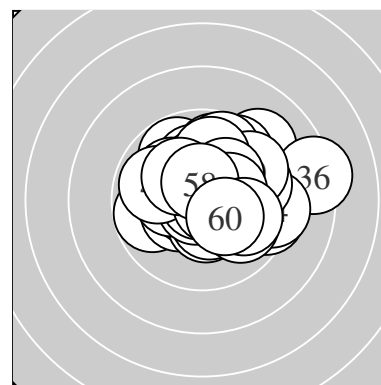

Serie 1:

9.8 ↘	10.0 →	10.3 *	10.8 *	10.1 ↘
10.4 *	10.3 *	10.2 *	9.8 ←	10.3 *

beste Teiler 42.7 (4.) 146.4 (6.) 151.3 (10.)

Trefferlage 1.05 mm links, 0.53 mm hoch

Streuwert 1.23, horizontal: 1.43, vertikal: 0.99

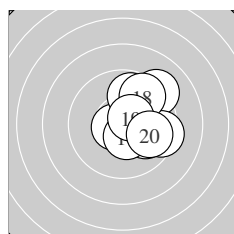

Serie 2:

9.2 ↗	10.6 *	9.4 →	10.0 ↘	10.6 *
10.5 *	9.8 ↑	9.6 ↗	10.6 *	9.8 →

beste Teiler 83.2 (15.) 94.0 (12.) 100.6 (19.)

Trefferlage 1.53 mm rechts, 0.37 mm hoch

Streuwert 1.60, horizontal: 1.42, vertikal: 1.76

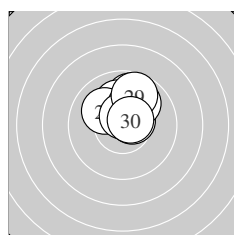

Serie 3:

9.8 ↑	10.1 ↑	10.6 *	10.1 ↘	10.3 *
10.1 ↑	10.6 *	9.9 ↗	9.7 ↑	10.6 *

beste Teiler 89.0 (27.) 91.5 (30.) 100.7 (23.)

Trefferlage 0.43 mm rechts, 1.63 mm hoch

Streuwert 0.91, horizontal: 0.94, vertikal: 0.87

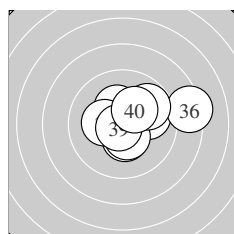

Serie 4:

9.9 →	10.4 *	10.7 *	10.4 *	10.3 *
8.3 →	9.8 ↗	10.3 *	10.8 *	10.2 *

beste Teiler 50.2 (39.) 68.0 (33.) 128.4 (34.)

Trefferlage 1.10 mm rechts, 0.43 mm hoch

Streuwert 1.80, horizontal: 2.28, vertikal: 1.13

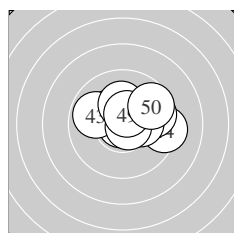

Serie 5:

10.3 *	10.9 *	9.9 ↖	9.3 →	9.7 →
10.3 *	10.2 *	10.7 *	10.5 *	9.7 ↗

beste Teiler 18.6 (42.) 61.3 (48.) 106.6 (49.)

Trefferlage 0.83 mm rechts, 0.67 mm hoch

Streuwert 1.56, horizontal: 2.04, vertikal: 0.83

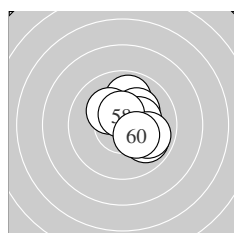

Serie 6:

10.2 *	9.9 ↑	10.2 *	10.2 *	9.9 ↘
10.4 *	10.3 *	10.5 *	9.9 →	10.3 *

beste Teiler 103.6 (58.) 150.6 (56.) 161.6 (57.)

Trefferlage 1.01 mm rechts, 0.51 mm hoch

Streuwert 1.23, horizontal: 1.11, vertikal: 1.35

Meyton Elektronik

ISSF AR Women – Wertung – Frauen

StandNr: 129

Wolf, Melissa #280

StartNr: 26

8. Dezember 2018 10:11

VSB

Unterschrift des Schützen

Meyton Elektronik

Ergebnis:	620.7	(590) ^{QF}					
Serien:	104.9	105.2	103.4	102.0	102.9	102.3	
Zähler:	50	10	0	0	0	0	0
Innenzehner:	46						
weiteste:	385 (40), 329 (59), 315 (45)						
beste Teiler	35.0 (32.) 36.1 (11.) 51.0 (1.)						
Trefferlage	0.15 mm links, 0.25 mm tief						
Streuwert	1.20, horizontal: 1.39, vertikal: 0.97						

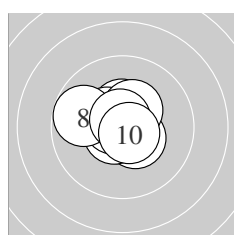
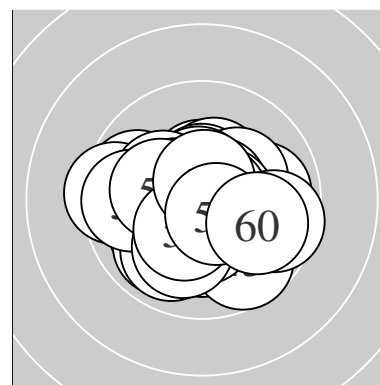

Serie 1:	10.7 *	10.4 *	10.5 *	10.4 *	10.6 *
	10.4 *	10.7 *	9.8 ←	10.7 *	10.7 *
beste Teiler	51.0 (1.) 58.8 (9.) 64.4 (10.)				
Trefferlage	0.36 mm links, 0.27 mm hoch				
Streuwert	0.94, horizontal: 1.09, vertikal: 0.77				

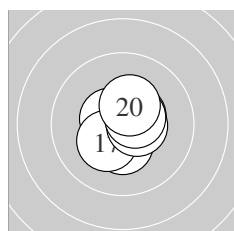

Serie 2:	10.8 *	10.6 *	10.5 *	10.6 *	10.4 *
	10.6 *	10.3 *	10.5 *	10.5 *	10.4 *
beste Teiler	36.1 (11.) 94.4 (14.) 95.8 (12.)				
Trefferlage	0.00 mm, 0.01 mm hoch				
Streuwert	0.87, horizontal: 0.86, vertikal: 0.87				

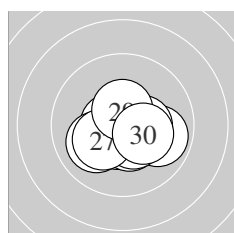

Serie 3:	10.5 *	9.9 →	10.6 *	10.5 *	10.5 *
	10.0 ←	10.2 *	10.4 *	10.5 *	10.3 *
beste Teiler	86.3 (23.) 107.2 (21.) 111.0 (29.)				
Trefferlage	0.21 mm rechts, 0.57 mm tief				
Streuwert	1.13, horizontal: 1.41, vertikal: 0.74				

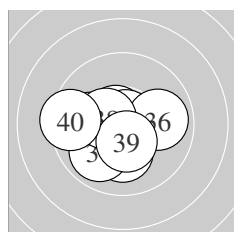

Serie 4:	10.6 *	10.8 *	10.0 ←	10.1 ↓	10.5 *
	9.9 →	9.9 ↙	10.4 *	10.4 *	9.4 ←
beste Teiler	35.0 (32.) 78.7 (31.) 115.4 (35.)				
Trefferlage	0.71 mm links, 0.42 mm tief				
Streuwert	1.43, horizontal: 1.73, vertikal: 1.03				

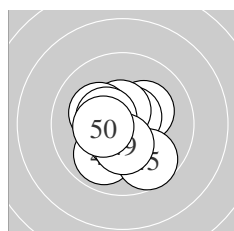

Serie 5:	9.9 ↙	10.5 *	10.2 *	10.6 *	9.7 ↘
	10.6 *	10.2 *	10.4 *	10.4 *	10.4 *
beste Teiler	82.3 (44.) 100.2 (46.) 107.2 (42.)				
Trefferlage	0.21 mm links, 0.37 mm tief				
Streuwert	1.30, horizontal: 1.25, vertikal: 1.35				

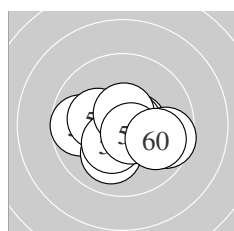

Serie 6:	9.7 ←	10.2 *	10.1 ↙	10.6 *	10.7 *
	10.3 *	10.6 *	10.6 *	9.6 →	9.9 →
beste Teiler	67.2 (55.) 84.4 (57.) 87.6 (58.)				
Trefferlage	0.13 mm rechts, 0.45 mm tief				
Streuwert	1.47, horizontal: 1.87, vertikal: 0.90				

Meyton Elektronik

ISSF AR Women – Wertung – Frauen

StandNr: 130

Pribitzer, Marlene #231

StartNr: 27

8. Dezember 2018 10:13

AUT

QF – Schütze hat sich fürs Finale qualifiziert

Unterschrift des Schützen

Meyton Elektronik

Ergebnis: **630.4** (598)^{QF}
 Serien: 105.1 105.9 104.3 105.8 105.3 104.0
 Zähler: 58 2 0 0 0 0 0 0 0
 Innenzehner: 54
 weiteste: 287 (23), 283 (51), 239 (41)
 beste Teiler 7.2 (11.) 20.0 (13.) 32.3 (57.)
 Trefferlage 0.32 mm links, 0.04 mm tief
 Streuwert 0.87, horizontal: 0.89, vertikal: 0.85

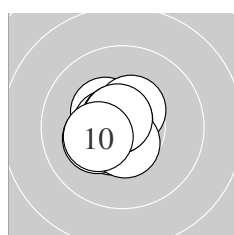
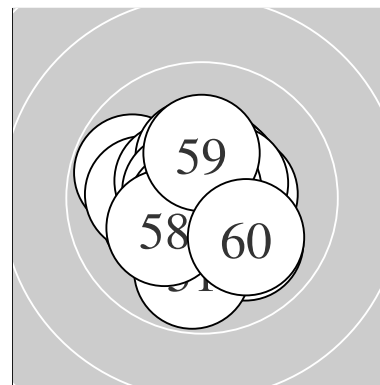

Serie 1:
 10.4 * 10.5 * 10.5 * 10.7 * 10.6 *
 10.2 * 10.5 * 10.7 * 10.7 * 10.3 *
 beste Teiler 53.8 (4.) 63.2 (9.) 64.5 (8.)
 Trefferlage 0.63 mm links, 0.05 mm hoch
 Streuwert 0.74, horizontal: 0.70, vertikal: 0.78

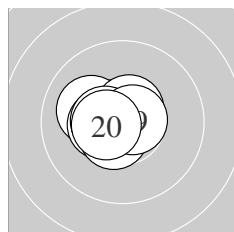

Serie 2:
 10.9 * 10.7 * 10.9 * 10.1 ↖ 10.4 *
 10.6 * 10.6 * 10.5 * 10.7 * 10.5 *
 beste Teiler 7.2 (11.) 20.0 (13.) 65.7 (19.)
 Trefferlage 0.57 mm links, 0.09 mm hoch
 Streuwert 0.68, horizontal: 0.82, vertikal: 0.49

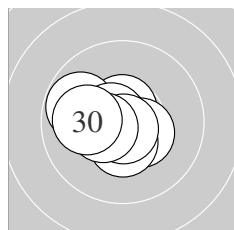

Serie 3:
 10.6 * 10.4 * 9.8 ↖ 10.5 * 10.4 *
 10.8 * 10.6 * 10.8 * 10.4 * 10.0 ←
 beste Teiler 44.4 (28.) 46.0 (26.) 78.1 (27.)
 Trefferlage 0.73 mm links, 0.09 mm tief
 Streuwert 0.94, horizontal: 1.14, vertikal: 0.69

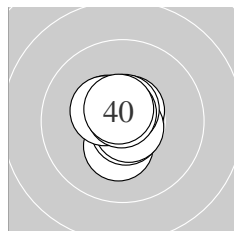

Serie 4:
 10.6 * 10.7 * 10.3 * 10.7 * 10.7 *
 10.6 * 10.5 * 10.4 * 10.7 * 10.6 *
 beste Teiler 52.4 (39.) 57.2 (35.) 62.6 (34.)
 Trefferlage 0.17 mm links, 0.08 mm hoch
 Streuwert 0.70, horizontal: 0.53, vertikal: 0.84

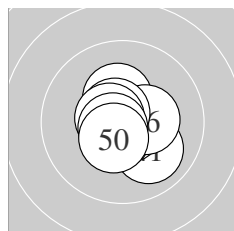

Serie 5:
 10.0 ↘ 10.7 * 10.3 * 10.8 * 10.6 *
 10.4 * 10.7 * 10.6 * 10.7 * 10.5 *
 beste Teiler 50.2 (44.) 53.1 (42.) 73.0 (49.)
 Trefferlage 0.01 mm links, 0.14 mm tief
 Streuwert 0.91, horizontal: 0.89, vertikal: 0.92

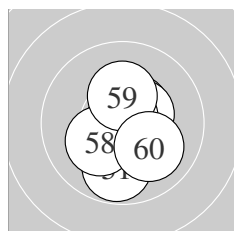

Serie 6:
 9.8 ↓ 10.6 * 10.7 * 10.5 * 10.6 *
 10.5 * 10.8 * 10.2 * 10.3 * 10.0 ↘
 beste Teiler 32.3 (57.) 58.6 (53.) 84.2 (55.)
 Trefferlage 0.15 mm rechts, 0.23 mm tief
 Streuwert 1.15, horizontal: 0.93, vertikal: 1.34

Meyton Elektronik

ISSF AR Women – Wertung – Frauen

StandNr: 132

Brabcova, Aneta #233

StartNr: 29

8. Dezember 2018 10:03

CZE

QF – Schütze hat sich fürs Finale qualifiziert

Unterschrift des Schützen

Meyton Elektronik

Ergebnis:	620.8	(594) ^{QF}							
Serien:	104.1	104.0	104.9	104.1	102.5	101.2			
Zähler:	54	6	0	0	0	0	0	0	0
Innenzehner:	46								
weiteste:	358 (55), 317 (41), 314 (57)								
beste Teiler	12.0 (2.) 15.2 (25.) 16.2 (22.)								
Trefferlage	0.33 mm rechts, 0.57 mm hoch								
Streuwert	1.11, horizontal: 1.18, vertikal: 1.05								

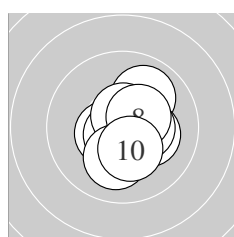
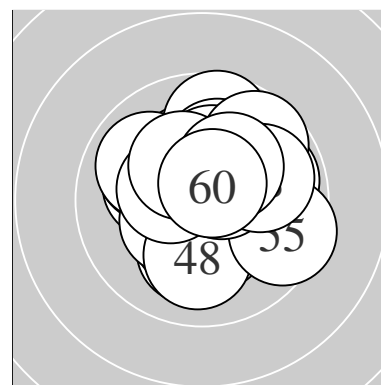

Serie 1:	10.0 ↗	10.9 *	10.5 *	10.7 *	10.2 *
	10.6 *	10.4 *	10.4 *	10.1 ↓	10.3 *
beste Teiler	12.0 (2.) 69.3 (4.) 81.0 (6.)				
Trefferlage	0.42 mm rechts, 0.16 mm tief				
Streuwert	1.07, horizontal: 0.96, vertikal: 1.16				

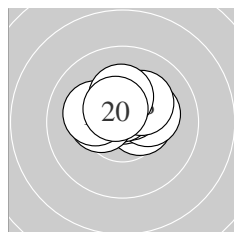

Serie 2:	10.5 *	10.7 *	10.2 *	10.5 *	10.6 *
	10.4 *	10.2 *	10.2 *	10.2 *	10.5 *
beste Teiler	73.0 (12.) 87.5 (15.) 104.2 (20.)				
Trefferlage	0.06 mm rechts, 0.78 mm hoch				
Streuwert	0.91, horizontal: 1.17, vertikal: 0.53				

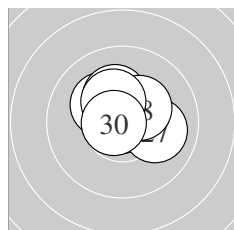

Serie 3:	10.2 *	10.9 *	10.2 *	10.6 *	10.9 *
	10.8 *	10.0 →	10.3 *	10.3 *	10.7 *
beste Teiler	15.2 (25.) 16.2 (22.) 41.1 (26.)				
Trefferlage	0.08 mm rechts, 0.59 mm hoch				
Streuwert	0.89, horizontal: 1.03, vertikal: 0.73				

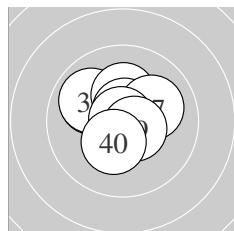

Serie 4:	10.6 *	10.0 ↖	9.9 ↖	10.8 *	10.2 *
	10.7 *	10.1 →	10.9 *	10.6 *	10.3 *
beste Teiler	16.4 (38.) 50.0 (34.) 73.3 (36.)				
Trefferlage	0.10 mm links, 0.52 mm hoch				
Streuwert	1.13, horizontal: 1.28, vertikal: 0.96				

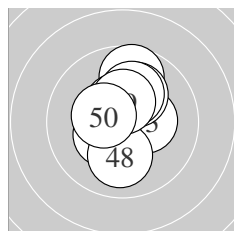

Serie 5:	9.7 ↑	10.6 *	10.3 *	10.5 *	10.1 ↗
	10.4 *	10.1 ↑	10.0 ↓	10.4 *	10.4 *
beste Teiler	100.2 (42.) 118.6 (44.) 137.5 (50.)				
Trefferlage	0.11 mm rechts, 0.77 mm hoch				
Streuwert	1.26, horizontal: 0.91, vertikal: 1.54				

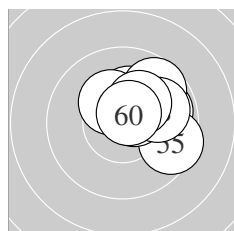

Serie 6:	10.3 *	10.3 *	10.3 *	9.9 →	9.5 →
	10.5 *	9.7 ↗	9.9 →	10.2 *	10.6 *
beste Teiler	81.3 (60.) 102.0 (56.) 164.3 (53.)				
Trefferlage	1.40 mm rechts, 0.92 mm hoch				
Streuwert	1.11, horizontal: 1.25, vertikal: 0.94				

ISSF AR Women – Wertung – Frauen

StandNr: 133

Zaisberger, Verena #152

StartNr: 30

8. Dezember 2018 10:00

AUT

QF – Schütze hat sich fürs Finale qualifiziert

Unterschrift des Schützen

Meyton Elektronik

Ergebnis:	610.0	(586)							
Serien:	101.7	101.4	98.0	104.5	103.4	101.0			
Zähler:	47	12	1	0	0	0	0	0	0
Innenzehner:	39								
weiteste:	555 (27), 448 (29), 418 (20)								
beste Teiler	11.0 (34.)	53.2 (44.)	54.4 (1.)						
Trefferlage	0.10 mm links, 0.66 mm tief								
Streuwert	1.51, horizontal: 1.44, vertikal: 1.58								

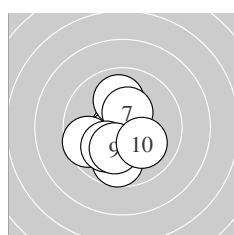
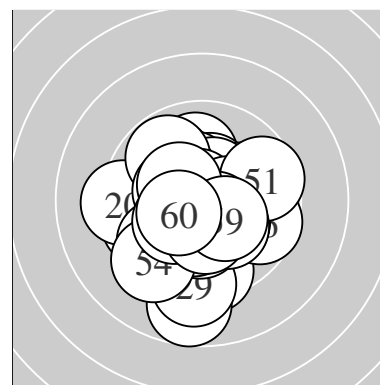

Serie 1:	10.7 *	10.5 *	10.4 *	10.0 ↑	9.7 ↓
	9.6 ←	10.4 *	10.1 ↗	10.2 *	10.1 ↘
beste Teiler	54.4 (1.)	117.5 (2.)	136.9 (7.)		
Trefferlage	0.64 mm links, 0.73 mm tief				
Streuwert	1.42, horizontal: 1.23, vertikal: 1.58				

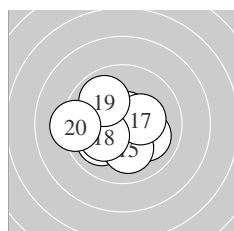

Serie 2:	10.0 ↘	10.7 *	10.0 ↖	10.3 *	10.1 ↓
	10.6 *	10.3 *	10.2 *	9.9 ↖	9.3 ←
beste Teiler	70.6 (12.)	83.2 (16.)	163.4 (17.)		
Trefferlage	0.55 mm links, 0.38 mm tief				
Streuwert	1.59, horizontal: 1.84, vertikal: 1.28				

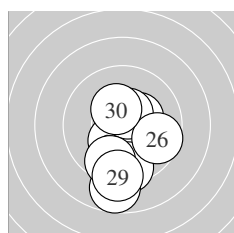

Serie 3:	10.1 ↘	10.3 *	10.3 *	10.5 *	9.4 ↓
	9.6 ↘	8.7 ↓	9.6 ↓	9.2 ↓	10.3 *
beste Teiler	111.4 (24.)	151.7 (30.)	152.1 (22.)		
Trefferlage	0.37 mm rechts, 1.73 mm tief				
Streuwert	1.95, horizontal: 1.37, vertikal: 2.40				

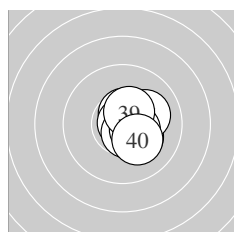

Serie 4:	10.5 *	10.6 *	10.4 *	10.9 *	10.2 *
	10.1 →	10.6 *	10.5 *	10.5 *	10.2 *
beste Teiler	11.0 (34.)	82.7 (37.)	92.5 (32.)		
Trefferlage	0.92 mm rechts, 0.00 mm				
Streuwert	0.77, horizontal: 0.64, vertikal: 0.88				

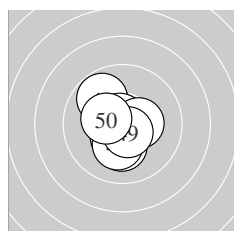

Serie 5:	10.2 *	9.8 ↖	10.2 *	10.7 *	10.6 *
	10.4 *	10.4 *	10.2 *	10.6 *	10.3 *
beste Teiler	53.2 (44.)	84.3 (49.)	88.7 (45.)		
Trefferlage	0.48 mm links, 0.15 mm tief				
Streuwert	1.15, horizontal: 0.95, vertikal: 1.32				

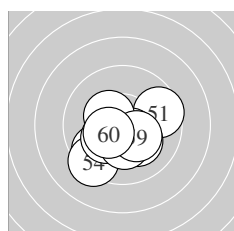

Serie 6:	9.6 →	10.6 *	9.7 ↖	9.3 ↖	10.2 *
	10.2 *	10.3 *	10.4 *	10.3 *	10.4 *
beste Teiler	100.4 (52.)	141.0 (60.)	144.2 (58.)		
Trefferlage	0.21 mm links, 1.01 mm tief				
Streuwert	1.58, horizontal: 1.83, vertikal: 1.28				

Meyton Elektronik

ISSF AR Women – Wertung – Frauen

StandNr: 135

Hainz, Janine #283

StartNr: 32

8. Dezember 2018 9:50

KLSV

Unterschrift des Schützen

Meyton Elektronik

Ergebnis:	619.0	(593)
Serien:	103.3	102.7 102.7 102.9 103.8 103.6
Zähler:	53	7 0 0 0 0 0 0 0 0
Innenzehner:	42	
weiteste:	322	(21), 299 (25), 279 (54)
beste Teiler	44.0	(43.) 54.0 (14.) 62.0 (28.)
Trefferlage	0.15 mm	links, 0.11 mm hoch
Streuwert	1.23,	horizontal: 1.40, vertikal: 1.04

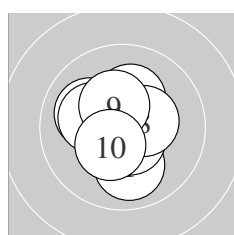
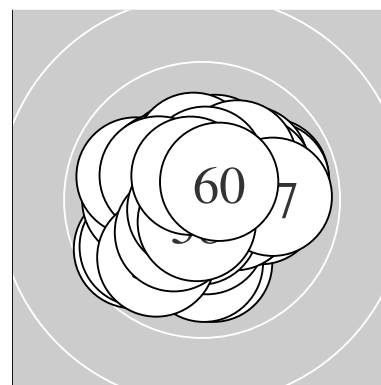

Serie 1:	10.0 ↓	10.6 *	10.0 ↖	10.2 *	10.6 *
	10.5 *	10.2 *	10.4 *	10.4 *	10.4 *
beste Teiler	91.5	(2.) 95.1 (5.)	102.6 (6.)		
Trefferlage	0.39 mm	links, 0.20 mm hoch			
Streuwert	1.18,	horizontal: 1.08, vertikal: 1.26			

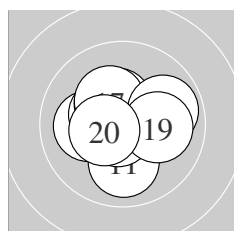

Serie 2:	10.0 ↓	10.4 *	10.1 ←	10.7 *	10.4 *
	10.3 *	10.3 *	9.9 →	10.1 →	10.5 *
beste Teiler	54.0	(14.) 122.3 (20.)	132.8 (15.)		
Trefferlage	0.19 mm	links, 0.19 mm hoch			
Streuwert	1.34,	horizontal: 1.49, vertikal: 1.17			

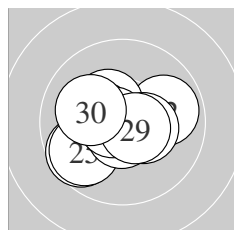

Serie 3:	9.7 ↙	9.9 →	10.4 *	10.4 *	9.8 ↘
	10.4 *	10.7 *	10.7 *	10.6 *	10.1 ↖
beste Teiler	62.0	(28.) 69.2 (27.)	88.1 (29.)		
Trefferlage	0.53 mm	links, 0.22 mm tief			
Streuwert	1.40,	horizontal: 1.70, vertikal: 1.02			

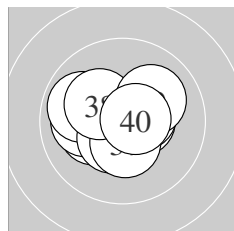

Serie 4:	10.2 *	10.0 ←	9.9 ↖	10.5 *	10.5 *
	10.5 *	10.4 *	10.2 *	10.1 ↗	10.6 *
beste Teiler	83.0	(40.) 110.0 (34.)	123.9 (36.)		
Trefferlage	0.36 mm	links, 0.08 mm hoch			
Streuwert	1.28,	horizontal: 1.59, vertikal: 0.88			

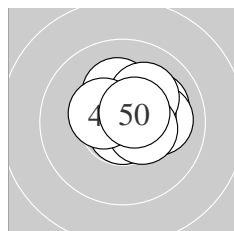

Serie 5:	10.1 ↗	10.1 →	10.8 *	10.5 *	10.2 *
	10.6 *	10.1 ↗	10.4 *	10.4 *	10.6 *
beste Teiler	44.0	(43.) 78.7 (46.)	96.0 (50.)		
Trefferlage	0.77 mm	rechts, 0.56 mm hoch			
Streuwert	0.91,	horizontal: 1.05, vertikal: 0.74			

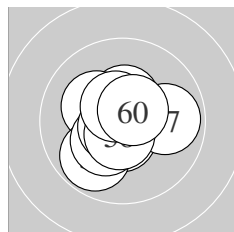

Serie 6:	10.4 *	10.2 *	10.6 *	9.8 ↙	10.3 *
	10.7 *	9.9 →	10.6 *	10.5 *	10.6 *
beste Teiler	70.4	(56.) 86.3 (58.)	94.7 (60.)		
Trefferlage	0.23 mm	links, 0.16 mm tief			
Streuwert	1.21,	horizontal: 1.27, vertikal: 1.14			

ISSF AR Women – Wertung – Frauen

StandNr: 136

Auer, Marie Theres #284

StartNr: 33

8. Dezember 2018 9:44

AUT

Unterschrift des Schützen

Meyton Elektronik

Ergebnis:	612.3	(584)						
Serien:	101.1	102.2	105.7	100.4	101.7	101.2		
Zähler:	44	16	0	0	0	0	0	0
Innenzehner:	33							
weiteste:	477 (35), 373 (20), 301 (1)							
beste Teiler	19.2 (30.)	42.0 (60.)	43.0 (22.)					
Trefferlage	0.22 mm links, 0.05 mm hoch							
Streuwert	1.48, horizontal: 1.46, vertikal: 1.50							

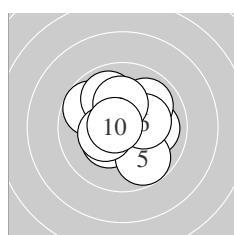
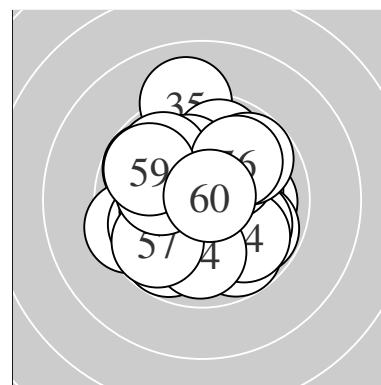

Serie 1:	9.7 ↖	10.3 *	10.0 →	9.9 ↗	9.8 ↘
	10.2 *	9.9 ↖	10.4 *	10.2 *	10.7 *
beste Teiler	65.9 (10.)	149.6 (8.)	153.4 (2.)		
Trefferlage	0.05 mm rechts, 0.39 mm hoch				
Streuwert	1.62, horizontal: 1.72, vertikal: 1.51				

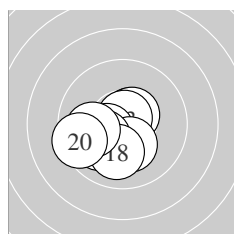

Serie 2:	10.6 *	10.5 *	10.7 *	10.4 *	10.0 ↙
	10.3 *	10.2 *	10.0 ↓	10.0 ←	9.5 ←
beste Teiler	52.4 (13.)	94.2 (11.)	106.7 (12.)		
Trefferlage	0.90 mm links, 0.69 mm tief				
Streuwert	1.28, horizontal: 1.46, vertikal: 1.06				

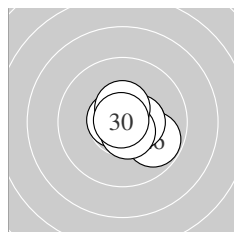

Serie 3:	10.7 *	10.8 *	10.5 *	10.7 *	10.7 *
	9.8 ↘	10.5 *	10.6 *	10.5 *	10.9 *
beste Teiler	19.2 (30.)	43.0 (22.)	58.2 (24.)		
Trefferlage	0.57 mm rechts, 0.03 mm tief				
Streuwert	0.79, horizontal: 0.90, vertikal: 0.67				

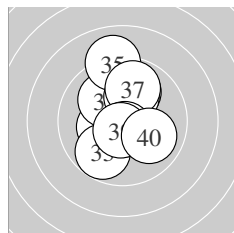

Serie 4:	10.0 ↑	10.3 *	9.8 ↙	10.1 ↘	9.0 ↑
	10.1 ↑	9.8 ↑	10.7 *	10.6 *	10.0 ↘
beste Teiler	68.4 (38.)	76.6 (39.)	157.1 (32.)		
Trefferlage	0.07 mm links, 0.78 mm hoch				
Streuwert	1.80, horizontal: 1.25, vertikal: 2.22				

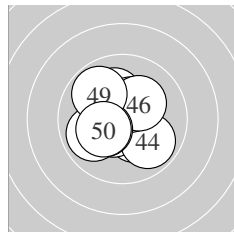

Serie 5:	10.3 *	10.5 *	10.1 ↖	9.9 ↘	10.4 *
	10.2 *	10.3 *	9.9 ↙	9.8 ↘	10.3 *
beste Teiler	113.3 (42.)	133.8 (45.)	160.6 (41.)		
Trefferlage	0.36 mm links, 0.03 mm tief				
Streuwert	1.48, horizontal: 1.51, vertikal: 1.45				

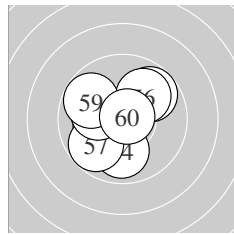

Serie 6:	10.2 *	10.2 *	10.6 *	9.9 ↓	9.8 ↗
	10.0 ↗	9.8 ↙	10.1 ←	9.8 ↖	10.8 *
beste Teiler	42.0 (60.)	97.9 (53.)	184.1 (51.)		
Trefferlage	0.62 mm links, 0.10 mm tief				
Streuwert	1.63, horizontal: 1.66, vertikal: 1.60				

Meyton Elektronik

ISSF AR Women – Wertung – Frauen

StandNr: 137

Rudolf, Lisa #285

StartNr: 34

8. Dezember 2018 9:50

SV Ottsdorf

Unterschrift des Schützen

Meyton Elektronik

Ergebnis: **617.7** (592)
 Serien: 101.8 103.2 103.2 102.7 104.3 102.5
 Zähler: 52 8 0 0 0 0 0 0 0
 Innenzehner: 40
 weiteste: 415 (5), 347 (55), 336 (37)
 beste Teiler 12.8 (52.) 14.1 (45.) 35.5 (13.)
 Trefferlage 0.30 mm links, 0.00 mm
 Streuwert 1.30, horizontal: 1.45, vertikal: 1.13

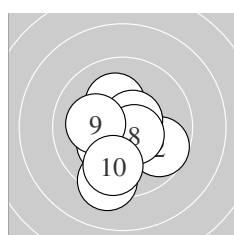
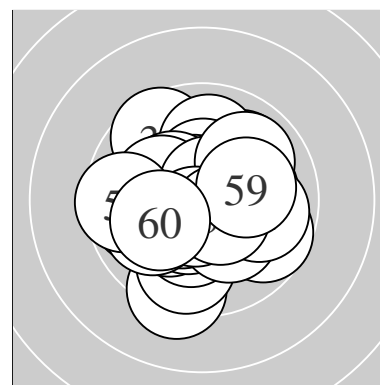

Serie 1:
 10.6 * 9.7 ↘ 10.7 * 10.2 * 9.3 ↓
 10.6 * 10.3 * 10.5 * 10.1 ← 9.8 ↓
 beste Teiler 69.5 (3.) 90.0 (1.) 91.2 (6.)
 Trefferlage 0.01 mm rechts, 0.80 mm tief
 Streuwert 1.55, horizontal: 1.40, vertikal: 1.69

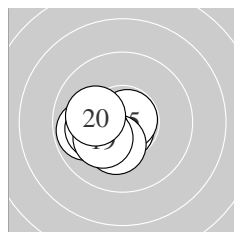

Serie 2:
 10.2 * 9.8 ← 10.8 * 10.7 * 10.8 *
 10.3 * 10.2 * 10.1 ← 10.2 * 10.1 ←
 beste Teiler 35.5 (13.) 40.7 (15.) 55.9 (14.)
 Trefferlage 1.22 mm links, 0.43 mm tief
 Streuwert 0.87, horizontal: 1.05, vertikal: 0.65

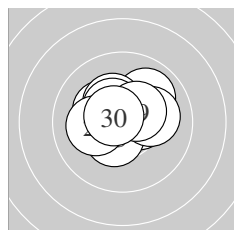

Serie 3:
 10.5 * 10.3 * 10.5 * 10.0 ↗ 10.3 *
 10.4 * 10.1 ← 10.1 → 10.4 * 10.6 *
 beste Teiler 81.0 (30.) 123.1 (21.) 125.3 (23.)
 Trefferlage 0.02 mm links, 0.56 mm hoch
 Streuwert 1.16, horizontal: 1.42, vertikal: 0.83

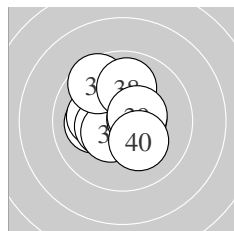

Serie 4:
 10.1 ← 10.2 * 10.7 * 10.4 * 10.5 *
 10.5 * 9.6 ↘ 10.0 ↑ 10.5 * 10.2 *
 beste Teiler 72.9 (33.) 106.9 (36.) 116.1 (39.)
 Trefferlage 0.38 mm links, 0.32 mm hoch
 Streuwert 1.37, horizontal: 1.39, vertikal: 1.35

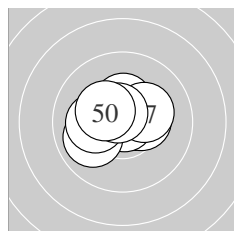

Serie 5:
 10.6 * 10.8 * 10.4 * 10.4 * 10.9 *
 10.0 ← 10.2 * 10.1 ← 10.6 * 10.3 *
 beste Teiler 14.1 (45.) 46.6 (42.) 76.9 (49.)
 Trefferlage 0.20 mm links, 0.30 mm hoch
 Streuwert 1.06, horizontal: 1.34, vertikal: 0.68

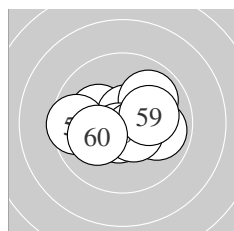

Serie 6:
 10.2 * 10.9 * 10.7 * 9.9 → 9.6 ←
 9.9 ↗ 10.6 * 10.5 * 10.1 → 10.1 ←
 beste Teiler 12.8 (52.) 69.3 (53.) 80.4 (57.)
 Trefferlage 0.02 mm rechts, 0.04 mm hoch
 Streuwert 1.49, horizontal: 1.94, vertikal: 0.83

Meyton Elektronik

ISSF AR Women – Wertung – Frauen

StandNr: 139

Sefer, Kata #287

StartNr: 36

8. Dezember 2018 10:07

BHSE–HUN

Unterschrift des Schützen

Meyton Elektronik

Ergebnis: **626.4** (595)^{QF}
 Serien: 104.4 104.1 104.5 104.5 103.8 105.1
 Zähler: 55 5 0 0 0 0 0 0 0
 Innenzehner: 53
 weiteste: 337 (9), 303 (41), 291 (23)
 beste Teiler 9.2 (29.) 14.8 (53.) 24.3 (28.)
 Trefferlage 0.05 mm links, 0.11 mm tief
 Streuwert 1.05, horizontal: 1.14, vertikal: 0.95

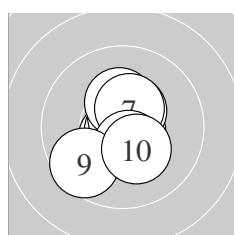
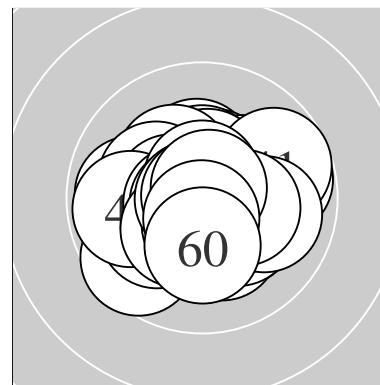

Serie 1:
 10.7 * 10.6 * 10.8 * 10.7 * 10.3 *
 10.5 * 10.4 * 10.5 * 9.6 ✓ 10.3 *
 beste Teiler 26.4 (3.) 57.0 (1.) 65.0 (4.)
 Trefferlage 0.06 mm links, 0.13 mm tief
 Streuwert 1.12, horizontal: 0.96, vertikal: 1.27

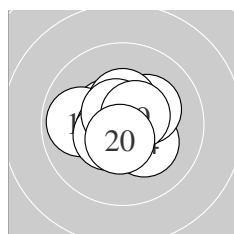

Serie 2:
 10.5 * 9.9 ← 10.6 * 10.2 * 10.5 *
 10.2 * 10.4 * 10.6 * 10.6 * 10.6 *
 beste Teiler 80.4 (18.) 85.6 (13.) 98.6 (20.)
 Trefferlage 0.22 mm links, 0.11 mm hoch
 Streuwert 1.08, horizontal: 1.26, vertikal: 0.87

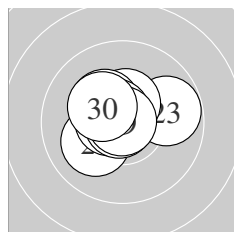

Serie 3:
 10.1 ✓ 10.4 * 9.8 → 10.5 * 10.6 *
 10.3 * 10.7 * 10.9 * 10.9 * 10.3 *
 beste Teiler 9.2 (29.) 24.3 (28.) 70.9 (27.)
 Trefferlage 0.38 mm links, 0.44 mm hoch
 Streuwert 1.05, horizontal: 1.28, vertikal: 0.76

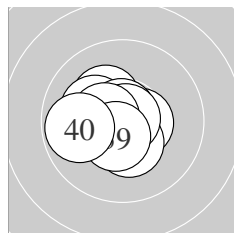

Serie 4:
 10.3 * 10.2 * 10.6 * 10.5 * 10.8 *
 10.4 * 10.9 * 10.5 * 10.5 * 9.8 ←
 beste Teiler 24.8 (37.) 49.8 (35.) 92.1 (33.)
 Trefferlage 0.59 mm links, 0.08 mm tief
 Streuwert 1.00, horizontal: 1.13, vertikal: 0.85

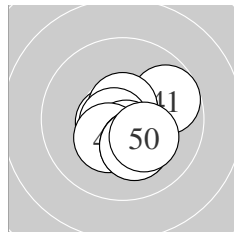

Serie 5:
 9.7 → 10.7 * 10.6 * 10.7 * 10.7 *
 10.5 * 10.3 * 10.2 * 10.2 * 10.2 *
 beste Teiler 54.1 (42.) 60.5 (45.) 75.0 (44.)
 Trefferlage 0.36 mm rechts, 0.47 mm tief
 Streuwert 1.08, horizontal: 1.12, vertikal: 1.05

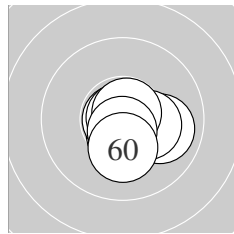

Serie 6:
 10.5 * 10.8 * 10.9 * 10.6 * 10.4 *
 10.0 → 10.3 * 10.8 * 10.6 * 10.2 *
 beste Teiler 14.8 (53.) 36.2 (52.) 46.8 (58.)
 Trefferlage 0.55 mm rechts, 0.54 mm tief
 Streuwert 0.77, horizontal: 0.89, vertikal: 0.64

Meyton Elektronik

ISSF AR Women – Wertung – Frauen

StandNr: 140

Mazurova, Nikola #225

StartNr: 37

8. Dezember 2018 10:13

CZE

QF – Schütze hat sich fürs Finale qualifiziert

Unterschrift des Schützen

Meyton Elektronik

Ergebnis:	617.4	(588)						
Serien:	103.1	102.4	102.1	104.2	102.1	103.5		
Zähler:	48	12	0	0	0	0	0	0
Innenzehner:	41							
weiteste:	443 (18), 358 (50), 349 (15)							
beste Teiler	12.0 (38.)	17.0 (58.)	26.0 (34.)					
Trefferlage	0.22 mm rechts, 0.41 mm hoch							
Streuwert	1.32, horizontal: 1.49, vertikal: 1.14							

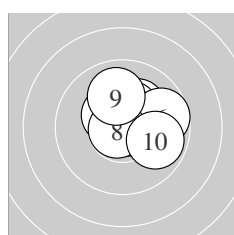
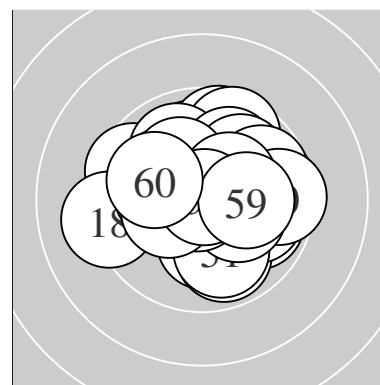

Serie 1:

10.2 *	10.8 *	10.4 *	10.4 *	10.5 *
9.7 →	10.4 *	10.8 *	10.0 ↑	9.9 →
beste Teiler	45.8 (8.)	46.0 (2.)	103.0 (5.)	
Trefferlage	0.54 mm rechts, 0.78 mm hoch			
Streuwert	1.18, horizontal: 1.36, vertikal: 0.96			

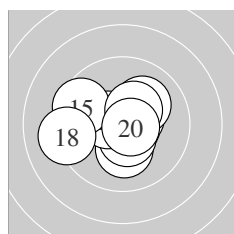

Serie 2:

10.7 *	10.2 *	10.5 *	10.5 *	9.6 ↖
10.5 *	10.1 ↗	9.2 ←	10.4 *	10.7 *
beste Teiler	67.0 (20.)	71.5 (11.)	110.4 (16.)	
Trefferlage	0.35 mm links, 0.03 mm hoch			
Streuwert	1.60, horizontal: 1.96, vertikal: 1.13			

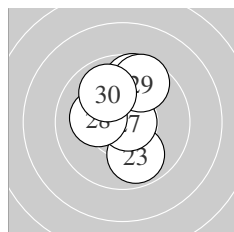

Serie 3:

10.5 *	10.5 *	9.9 ↓	10.4 *	9.7 ↑
10.6 *	10.8 *	10.2 *	9.6 ↗	9.9 ↘
beste Teiler	43.0 (27.)	91.2 (26.)	116.6 (22.)	
Trefferlage	0.18 mm links, 0.96 mm hoch			
Streuwert	1.40, horizontal: 1.11, vertikal: 1.64			

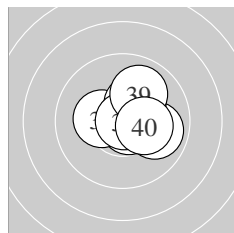

Serie 4:

10.7 *	10.3 *	9.9 →	10.8 *	10.7 *
10.3 *	10.3 *	10.9 *	10.0 ↗	10.3 *
beste Teiler	12.0 (38.)	26.0 (34.)	55.5 (35.)	
Trefferlage	0.71 mm rechts, 0.36 mm hoch			
Streuwert	1.00, horizontal: 1.09, vertikal: 0.90			

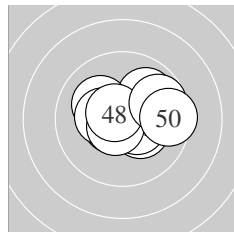

Serie 5:

10.6 *	9.9 ↗	10.3 *	10.5 *	10.1 ↖
10.3 *	10.6 *	10.6 *	9.7 →	9.5 →
beste Teiler	79.8 (48.)	81.3 (47.)	93.0 (41.)	
Trefferlage	0.54 mm rechts, 0.26 mm hoch			
Streuwert	1.45, horizontal: 1.84, vertikal: 0.88			

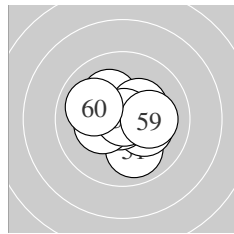

Serie 6:

10.0 ↓	10.2 *	10.7 *	10.2 *	10.8 *
10.3 *	10.3 *	10.9 *	10.1 →	10.0 ↖
beste Teiler	17.0 (58.)	27.2 (55.)	72.8 (53.)	
Trefferlage	0.11 mm rechts, 0.06 mm hoch			
Streuwert	1.26, horizontal: 1.41, vertikal: 1.10			

Meyton Elektronik

ISSF AR Women – Wertung – Frauen

StandNr: 141

Bánki, Dóra #288

StartNr: 38

8. Dezember 2018 9:52

BHSE–HUN

Unterschrift des Schützen

Meyton Elektronik

Ergebnis:	619.4	(590) ^{QF}
Serien:	103.2	102.5 105.3 103.0 104.1 101.3
Zähler:	50	10 0 0 0 0 0 0 0 0
Innenzehner:	42	
weiteste:	411	(54), 323 (18), 316 (55)
beste Teiler	29.1	(27.) 42.0 (26.) 45.6 (37.)
Trefferlage	0.17 mm	rechts, 0.00 mm
Streuwert	1.28,	horizontal: 1.35, vertikal: 1.20

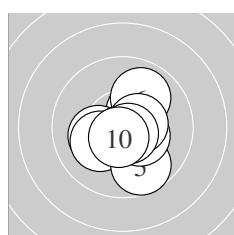
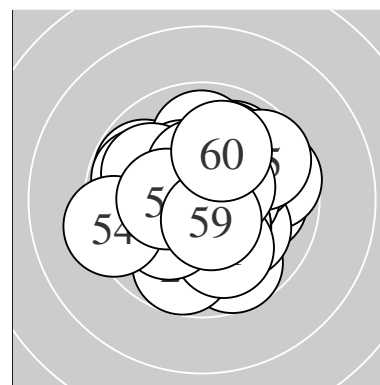

Serie 1:

10.3 *	10.2 *	10.7 *	10.2 *	9.7 ↘
9.9 ↗	10.4 *	10.5 *	10.7 *	10.6 *
beste Teiler	56.2 (3.)	63.0 (9.)	80.4 (10.)	
Trefferlage	0.28 mm rechts, 0.33 mm tief			
Streuwert	1.27, horizontal: 1.21, vertikal: 1.33			

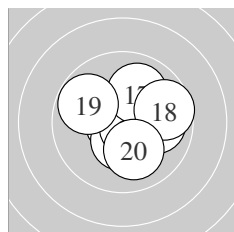

Serie 2:

10.7 *	10.6 *	10.0 →	10.4 *	10.5 *
10.7 *	10.0 ↗	9.7 →	9.8 ↖	10.1 ↘
beste Teiler	53.9 (11.)	62.4 (16.)	90.8 (12.)	
Trefferlage	0.66 mm rechts, 0.05 mm hoch			
Streuwert	1.40, horizontal: 1.57, vertikal: 1.22			

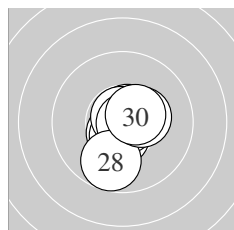

Serie 3:

10.5 *	10.7 *	10.6 *	10.5 *	10.7 *
10.8 *	10.8 *	9.8 ↓	10.4 *	10.5 *
beste Teiler	29.1 (27.)	42.0 (26.)	59.6 (22.)	
Trefferlage	0.28 mm rechts, 0.21 mm tief			
Streuwert	0.92, horizontal: 0.72, vertikal: 1.09			

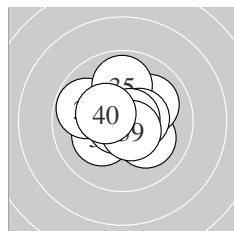

Serie 4:

10.2 *	9.8 ↖	10.1 ↘	10.0 ↗	9.9 ↑
10.5 *	10.8 *	10.7 *	10.6 *	10.4 *
beste Teiler	45.6 (37.)	55.6 (38.)	94.2 (39.)	
Trefferlage	0.01 mm rechts, 0.24 mm hoch			
Streuwert	1.35, horizontal: 1.51, vertikal: 1.17			

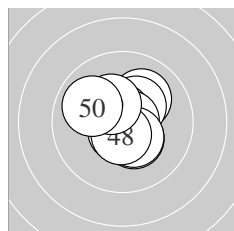

Serie 5:

10.1 ↗	10.3 *	10.7 *	10.4 *	10.6 *
10.8 *	10.4 *	10.6 *	10.3 *	9.9 ↖
beste Teiler	49.2 (46.)	66.2 (43.)	76.9 (45.)	
Trefferlage	0.08 mm rechts, 0.21 mm hoch			
Streuwert	1.10, horizontal: 1.08, vertikal: 1.13			

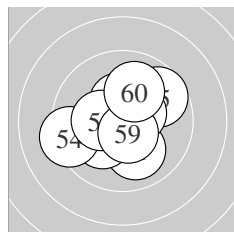

Serie 6:

10.0 ↘	10.3 *	10.2 *	9.3 ←	9.7 ↗
10.5 *	10.4 *	10.3 *	10.6 *	10.0 ↑
beste Teiler	97.9 (59.)	117.3 (56.)	137.2 (57.)	
Trefferlage	0.30 mm links, 0.00 mm			
Streuwert	1.67, horizontal: 1.88, vertikal: 1.44			

Meyton Elektronik

ISSF AR Women – Wertung – Frauen

StandNr: 142

Ungerank, Nadine #227

StartNr: 39

8. Dezember 2018 10:13

AUT

QF – Schütze hat sich fürs Finale qualifiziert

Unterschrift des Schützen

Meyton Elektronik

Ergebnis: **604.1** (575)

Serien: 103.2 99.9 99.9 100.5 101.5 99.1

Zähler: 38 19 3 0 0 0 0 0 0 0

Innenzehner: 33

weiteste: 631 (51), 510 (33), 501 (13)

beste Teiler 36.6 (54.) 40.3 (5.) 48.8 (34.)

Trefferlage 0.05 mm links, 0.11 mm tief

Streuwert 1.85, horizontal: 2.20, vertikal: 1.40

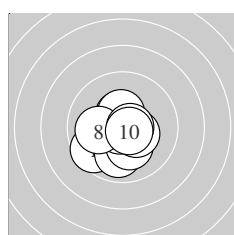
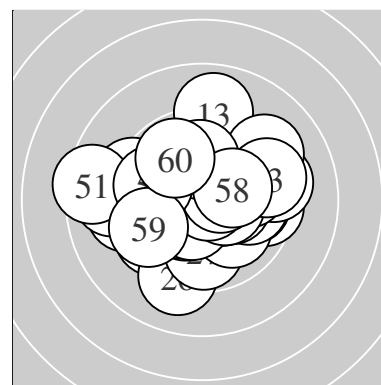

Serie 1:

9.6 ↙	9.9 ↓	10.5 *	10.2 *	10.8 *
10.4 *	10.4 *	10.0 ←	10.7 *	10.7 *

beste Teiler 40.3 (5.) 71.0 (9.) 71.6 (10.)

Trefferlage 0.28 mm links, 0.54 mm tief

Streuwert 1.28, horizontal: 1.29, vertikal: 1.27

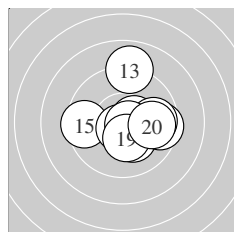

Serie 2:

10.2 *	9.5 →	8.9 ↑	10.5 *	9.5 ←
9.8 →	10.7 *	10.7 *	10.3 *	9.8 →

beste Teiler 59.6 (18.) 64.4 (17.) 112.0 (14.)

Trefferlage 0.89 mm rechts, 0.06 mm hoch

Streuwert 1.93, horizontal: 2.03, vertikal: 1.83

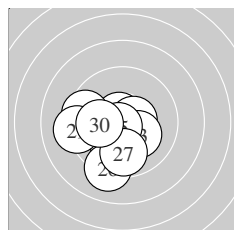

Serie 3:

10.7 *	10.5 *	10.2 *	10.1 ↓	10.7 *
9.1 ↓	9.8 ↓	9.5 ←	9.2 ←	10.1 ←

beste Teiler 55.8 (25.) 67.2 (21.) 104.9 (22.)

Trefferlage 1.04 mm links, 1.00 mm tief

Streuwert 1.75, horizontal: 1.86, vertikal: 1.63

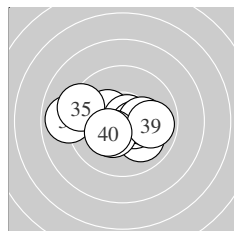

Serie 4:

10.0 ↘	10.3 *	8.9 ←	10.8 *	9.3 ↖
10.5 *	10.2 *	10.3 *	9.9 →	10.3 *

beste Teiler 48.8 (34.) 114.1 (36.) 151.8 (38.)

Trefferlage 0.50 mm links, 0.20 mm tief

Streuwert 1.91, horizontal: 2.55, vertikal: 0.90

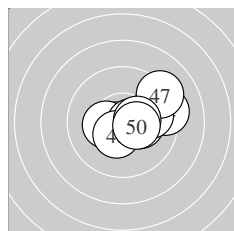

Serie 5:

10.7 *	10.3 *	10.3 *	9.3 →	10.6 *
9.9 →	9.2 ↗	10.4 *	10.4 *	10.4 *

beste Teiler 67.7 (41.) 77.1 (45.) 130.1 (48.)

Trefferlage 1.26 mm rechts, 0.20 mm hoch

Streuwert 1.48, horizontal: 1.83, vertikal: 1.03

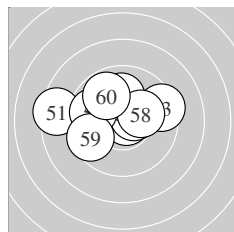

Serie 6:

8.4 ←	10.6 *	9.4 →	10.8 *	10.5 *
10.0 ↑	9.8 ←	10.2 *	9.6 ←	9.8 ↘

beste Teiler 36.6 (54.) 87.8 (52.) 111.6 (55.)

Trefferlage 0.64 mm links, 0.78 mm hoch

Streuwert 2.16, horizontal: 2.84, vertikal: 1.13

Meyton Elektronik

ISSF AR Women – Wertung – Frauen

StandNr: 143

Waibel, Daniela #289

StartNr: 40

8. Dezember 2018 10:09

VSB

Unterschrift des Schützen

Meyton Elektronik

Ergebnis: **619.8** (593)^{QF}
 Serien: 101.9 104.2 103.6 103.9 103.5 102.7
 Zähler: 53 7 0 0 0 0 0 0 0
 Innenzehner: 47
 weiteste: 430 (1), 338 (25), 273 (15)
 beste Teiler 13.8 (20.) 33.2 (50.) 44.9 (23.)
 Trefferlage 0.04 mm links, 0.11 mm hoch
 Streuwert 1.23, horizontal: 1.38, vertikal: 1.06

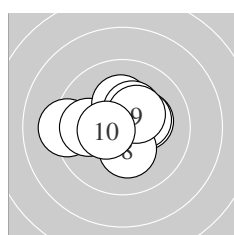
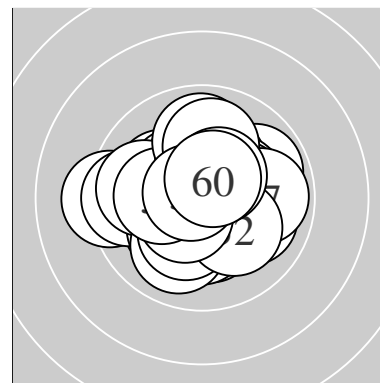

Serie 1:
 9.2 ← 9.9 ← 10.2 * 10.2 * 10.3 *
 10.7 * 10.3 * 10.3 * 10.4 * 10.4 *
 beste Teiler 56.2 (6.) 130.0 (10.) 146.4 (9.)
 Trefferlage 0.29 mm links, 0.26 mm hoch
 Streuwert 1.54, horizontal: 1.93, vertikal: 1.01

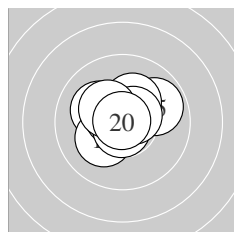

Serie 2:
 10.1 ↖ 10.2 * 10.5 * 10.6 * 9.9 ↗
 10.8 * 10.3 * 10.6 * 10.3 * 10.9 *
 beste Teiler 13.8 (20.) 50.6 (16.) 79.9 (14.)
 Trefferlage 0.19 mm links, 0.48 mm hoch
 Streuwert 1.08, horizontal: 1.28, vertikal: 0.83

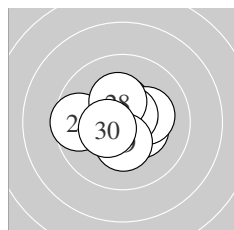

Serie 3:
 10.5 * 10.4 * 10.8 * 10.4 * 9.6 ←
 10.2 * 10.7 * 10.3 * 10.3 * 10.4 *
 beste Teiler 44.9 (23.) 72.8 (27.) 104.1 (21.)
 Trefferlage 0.01 mm links, 0.20 mm hoch
 Streuwert 1.22, horizontal: 1.46, vertikal: 0.92

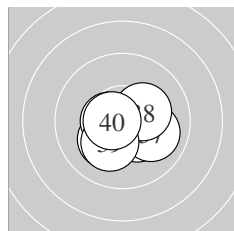

Serie 4:
 10.7 * 10.4 * 10.2 * 10.6 * 10.4 *
 10.5 * 10.0 ↘ 10.3 * 10.2 * 10.6 *
 beste Teiler 62.2 (31.) 82.0 (40.) 90.5 (34.)
 Trefferlage 0.28 mm rechts, 0.45 mm tief
 Streuwert 1.06, horizontal: 1.26, vertikal: 0.81

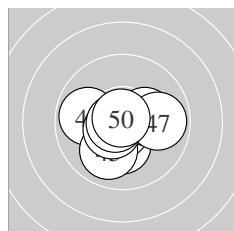

Serie 5:
 10.6 * 9.9 ← 10.2 * 10.7 * 10.0 ↙
 10.2 * 9.9 → 10.5 * 10.7 * 10.8 *
 beste Teiler 33.2 (50.) 58.8 (49.) 62.3 (44.)
 Trefferlage 0.00 mm , 0.39 mm tief
 Streuwert 1.26, horizontal: 1.52, vertikal: 0.93

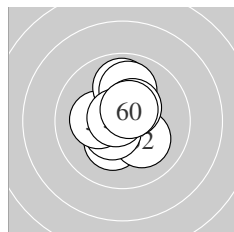

Serie 6:
 10.3 * 10.1 ↘ 10.5 * 10.2 * 10.1 ↑
 9.9 ↑ 10.0 ↑ 10.7 * 10.4 * 10.5 *
 beste Teiler 57.6 (58.) 102.0 (60.) 110.3 (53.)
 Trefferlage 0.07 mm links, 0.55 mm hoch
 Streuwert 1.26, horizontal: 0.95, vertikal: 1.51

Meyton Elektronik

ISSF AR Women – Wertung – Frauen

StandNr: 144

Auer, Katharina #13

StartNr: 41

8. Dezember 2018 9:32

T – SG Roppen

QF – Schütze hat sich fürs Finale qualifiziert

Unterschrift des Schützen

Meyton Elektronik

Ergebnis:	603.2	(575)
Serien:	97.2	99.9 101.1 101.1 102.4 101.5
Zähler:	35	25 0 0 0 0 0 0 0 0
Innenzehner:	30	
weiteste:	497	(54), 486 (37), 468 (7)
beste Teiler	17.4	(57.) 29.0 (52.) 44.4 (42.)
Trefferlage	0.20 mm	links, 0.16 mm tief
Streuwert	1.84,	horizontal: 2.22, vertikal: 1.36

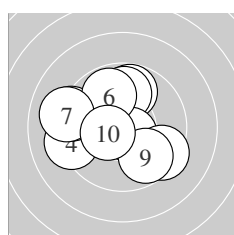
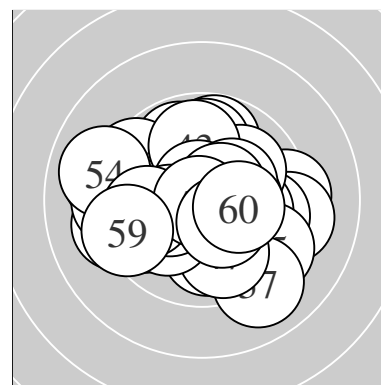

Serie 1:	9.8 ↑	9.9 ↑	10.6 *	9.2 ←	9.2 ←
	9.8 ↘	9.1 ←	9.4 ↘	9.8 ↘	10.4 *
beste Teiler	83.4	(3.) 130.3	(10.) 272.3	(2.)	
Trefferlage	0.88 mm	links, 0.36 mm	hoch		
Streuwert	2.36,	horizontal: 2.69,	vertikal: 1.98		

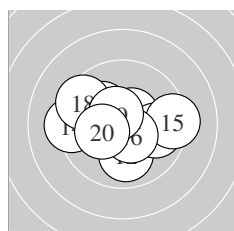

Serie 2:	10.5 *	10.0 ↓	9.9 →	9.3 ←	9.3 →
	10.5 *	10.1 ↘	9.5 ↘	10.6 *	10.2 *
beste Teiler	100.4	(19.) 102.5	(11.) 113.4	(16.)	
Trefferlage	0.28 mm	links, 0.02 mm	hoch		
Streuwert	1.99,	horizontal: 2.54,	vertikal: 1.23		

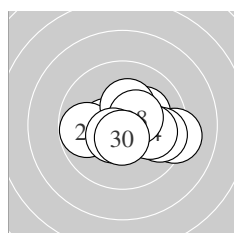

Serie 3:	10.2 *	9.2 →	9.7 →	10.0 →	10.4 *
	9.8 ←	10.3 *	10.5 *	10.5 *	10.5 *
beste Teiler	103.1	(30.) 115.3	(29.) 125.0	(28.)	
Trefferlage	0.76 mm	rechts, 0.14 mm	tief		
Streuwert	1.64,	horizontal: 2.15,	vertikal: 0.89		

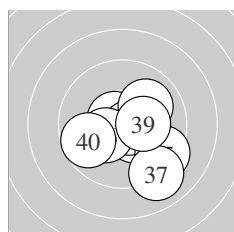

Serie 4:	10.8 *	10.4 *	10.6 *	10.7 *	9.3 ↘
	10.3 *	9.0 ↘	10.0 ↗	10.3 *	9.7 ←
beste Teiler	45.1	(31.) 64.4	(34.) 77.3	(33.)	
Trefferlage	0.61 mm	rechts, 0.84 mm	tief		
Streuwert	1.71,	horizontal: 1.89,	vertikal: 1.51		

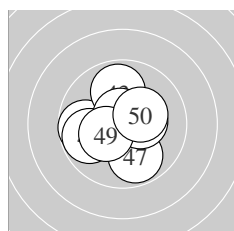

Serie 5:	9.7 ←	10.8 *	9.9 ↑	10.7 *	9.8 ←
	10.7 *	9.8 ↘	10.4 *	10.3 *	10.3 *
beste Teiler	44.4	(42.) 55.1	(44.) 70.6	(46.)	
Trefferlage	0.36 mm	links, 0.02 mm	tief		
Streuwert	1.48,	horizontal: 1.58,	vertikal: 1.37		

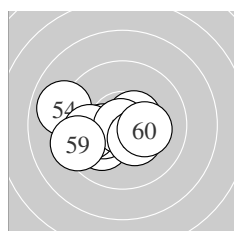

Serie 6:	10.1 ↗	10.8 *	10.3 *	9.0 ←	10.5 *
	9.9 ←	10.9 *	10.4 *	9.4 ←	10.2 *
beste Teiler	17.4	(57.) 29.0	(52.) 107.1	(55.)	
Trefferlage	1.08 mm	links, 0.39 mm	tief		
Streuwert	1.65,	horizontal: 2.16,	vertikal: 0.88		

Meyton Elektronik

ISSF AR Women – Wertung – Frauen

StandNr: 145

Babenko, Mariia #290

StartNr: 42

8. Dezember 2018 9:44

HSG München

Unterschrift des Schützen

Meyton Elektronik

Ergebnis: **612.6** (581)
 Serien: 101.9 102.7 103.7 101.8 103.0 99.5
 Zähler: 42 17 1 0 0 0 0 0 0
 Innenzehner: 36
 weiteste: 656 (57), 434 (12), 405 (31)
 beste Teiler 17.2 (24.) 31.0 (51.) 34.3 (39.)
 Trefferlage 0.36 mm rechts, 0.07 mm tief
 Streuwert 1.53, horizontal: 1.92, vertikal: 0.99

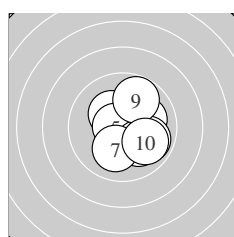
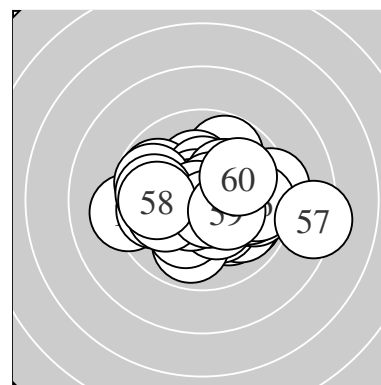

Serie 1:
 10.4 * 10.1 → 10.3 * 10.6 * 10.7 *
 10.1 ↘ 10.1 ↓ 9.9 ↘ 9.8 ↑ 9.9 ↘
 beste Teiler 68.3 (5.) 90.8 (4.) 137.6 (1.)
 Trefferlage 0.69 mm rechts, 0.09 mm tief
 Streuwert 1.45, horizontal: 1.35, vertikal: 1.55

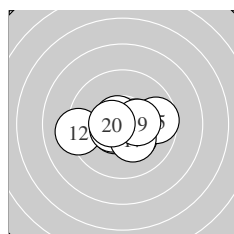

Serie 2:
 10.6 * 9.2 ← 10.5 * 10.3 * 9.7 →
 10.5 * 10.3 * 10.7 * 10.4 * 10.5 *
 beste Teiler 70.7 (18.) 95.9 (11.) 104.1 (20.)
 Trefferlage 0.05 mm rechts, 0.30 mm tief
 Streuwert 1.51, horizontal: 2.04, vertikal: 0.66

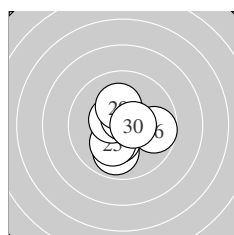

Serie 3:
 9.9 ↓ 10.8 * 10.3 * 10.9 * 10.2 *
 9.7 → 10.5 * 10.7 * 10.2 * 10.5 *
 beste Teiler 17.2 (24.) 49.7 (22.) 73.8 (28.)
 Trefferlage 0.07 mm rechts, 0.24 mm tief
 Streuwert 1.26, horizontal: 1.20, vertikal: 1.31

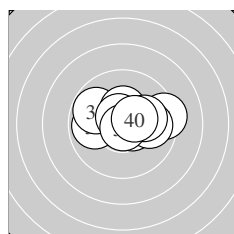

Serie 4:
 9.3 → 9.9 ← 10.6 * 9.8 ↖ 9.9 →
 10.4 * 10.1 → 10.6 * 10.8 * 10.4 *
 beste Teiler 34.3 (39.) 78.2 (38.) 98.4 (33.)
 Trefferlage 0.52 mm rechts, 0.42 mm hoch
 Streuwert 1.57, horizontal: 2.12, vertikal: 0.65

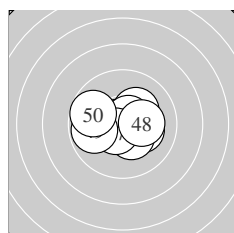

Serie 5:
 10.2 * 10.7 * 10.2 * 10.6 * 10.4 *
 10.6 * 10.6 * 10.2 * 9.8 ← 9.7 ←
 beste Teiler 59.4 (42.) 76.4 (46.) 79.0 (44.)
 Trefferlage 0.01 mm rechts, 0.04 mm tief
 Streuwert 1.33, horizontal: 1.70, vertikal: 0.80

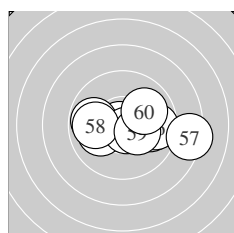

Serie 6:
 10.8 * 9.8 ← 10.1 ← 9.9 → 10.7 *
 9.7 → 8.3 → 9.9 ← 10.3 * 10.0 →
 beste Teiler 31.0 (51.) 64.6 (55.) 156.6 (59.)
 Trefferlage 0.83 mm rechts, 0.18 mm tief
 Streuwert 2.14, horizontal: 2.94, vertikal: 0.69

Meyton Elektronik

ISSF AR Women – Wertung – Frauen

StandNr: 147

Schachner, Christine #190

StartNr: 183

8. Dezember 2018 10:07

Salzburger LV

Unterschrift des Schützen

Meyton Elektronik