

Ergebnis:	387.2	(369)
Serien:	97.1	97.9 98.2 94.0
Zähler:	17	16 6 1 0 0 0 0 0 0
Innenzehner:	13	
weiteste:	903 (6),	732 (33), 697 (31)
beste Teiler	57.7 (7.)	73.1 (11.) 98.0 (25.)
Trefferlage	1.34 mm rechts, 0.90 mm tief	
Streuwert	2.44, horizontal: 3.02, vertikal: 1.66	

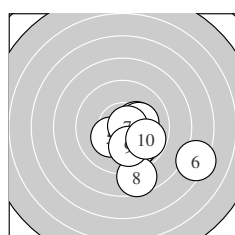

Serie 1:	9.9 ↘	10.3 *	10.2 *	9.9 ↘	10.3 *
	7.3 ↘	10.7 *	8.6 ↓	10.1 ↓	9.8 ↘
beste Teiler	57.7 (7.) 163.2 (2.) 173.2 (5.)				
Trefferlage	1.88 mm rechts, 1.69 mm tief				
Streuwert	2.22, horizontal: 2.46, vertikal: 1.94				

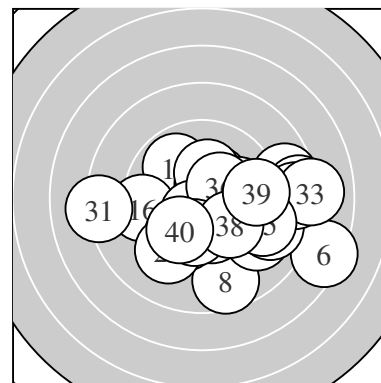
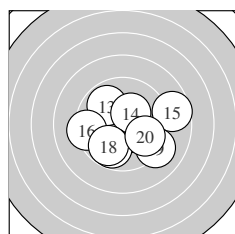

Serie 2:	10.7 *	10.5 *	9.9 ↘	10.3 *	8.7 →
	9.3 ←	9.8 ↓	9.8 ↓	9.1 ↘	9.8 ↘
beste Teiler	73.1 (11.) 121.2 (12.) 154.4 (14.)				
Trefferlage	0.48 mm rechts, 0.66 mm tief				
Streuwert	2.36, horizontal: 2.85, vertikal: 1.73				

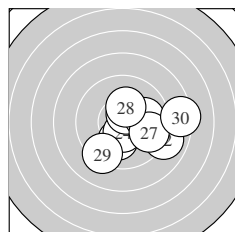

Serie 3:	10.4 *	9.0 ↘	10.1 ↓	10.5 *	10.6 *
	10.0 →	9.7 ↘	10.3 *	9.3 ↓	8.3 →
beste Teiler	98.0 (25.) 113.1 (24.) 136.5 (21.)				
Trefferlage	1.52 mm rechts, 0.48 mm tief				
Streuwert	2.20, horizontal: 2.61, vertikal: 1.70				

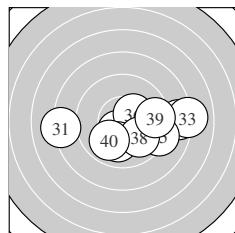

Serie 4:	8.2 ←	8.4 →	8.0 →	10.5 *	9.2 ↘
	10.4 *	10.0 ↓	9.9 ↘	9.5 →	9.9 ↓
beste Teiler	120.3 (34.) 143.9 (36.) 238.5 (37.)				
Trefferlage	1.48 mm rechts, 0.79 mm tief				
Streuwert	3.06, horizontal: 4.17, vertikal: 1.17				

Unterschrift des Schützen

Meyton Elektronik

Ergebnis:	394.6	(374)
Serien:	100.7	97.1 98.3 98.5
Zähler:	18	18 4 0 0 0 0 0 0 0
Innenzehner:	14	
weiteste:	565	(40), 533 (13), 526 (32)
beste Teiler	53.1	(38.) 63.7 (5.) 71.1 (35.)
Trefferlage	0.02 mm	rechts, 0.29 mm hoch
Streuwert	2.18,	horizontal: 2.26, vertikal: 2.08

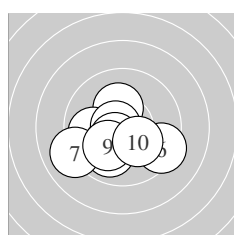
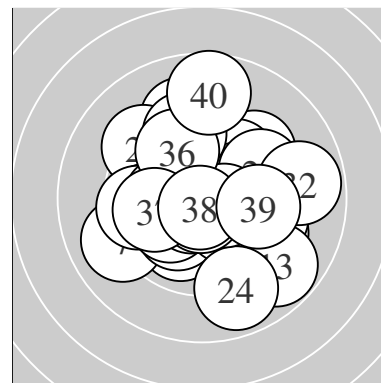

Serie 1:	10.3 *	9.9 ←	10.0 ✓	10.6 *	10.7 *
	9.4 ↘	9.0 ←	10.5 *	10.1 ✓	10.2 *
beste Teiler	63.7	(5.) 91.0 (4.)	116.6 (8.)		
Trefferlage	0.61 mm	links, 0.97 mm	tief		
Streuwert	1.70,	horizontal: 2.08,	vertikal: 1.21		

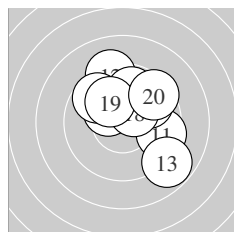

Serie 2:	9.5 ↘	9.2 ↑	8.8 ↘	9.8 ↑	10.3 *
	9.8 ↗	9.7 ↘	10.4 *	10.1 ↘	9.5 ↗
beste Teiler	138.6	(18.) 162.6 (15.)	213.7 (19.)		
Trefferlage	0.85 mm	rechts, 1.23 mm	hoch		
Streuwert	2.19,	horizontal: 2.21,	vertikal: 2.17		

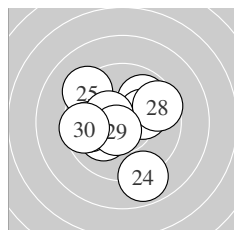

Serie 3:	9.9 ↗	10.1 ✓	10.2 *	8.9 ↘	9.3 ↘
	9.7 ←	10.4 *	9.6 ↗	10.6 *	9.6 ←
beste Teiler	92.0	(29.) 136.1 (27.)	194.4 (23.)		
Trefferlage	0.45 mm	links, 0.03 mm	tief		
Streuwert	2.27,	horizontal: 2.42,	vertikal: 2.11		

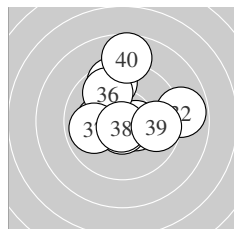

Serie 4:	10.5 *	8.8 →	10.2 *	9.5 ↑	10.7 *
	9.8 ↘	9.9 ←	10.7 *	9.7 →	8.7 ↑
beste Teiler	53.1	(38.) 71.1 (35.)	124.9 (31.)		
Trefferlage	0.28 mm	rechts, 0.96 mm	hoch		
Streuwert	2.27,	horizontal: 2.35,	vertikal: 2.18		

Unterschrift des Schützen

Meyton Elektronik

Ergebnis: **396.5** (378)
 Serien: 100.0 99.9 100.0 96.6
 Zähler: 20 18 2 0 0 0 0 0 0 0
 Innenzehner: 15
 weiteste: 717 (37), 519 (34), 484 (31)
 beste Teiler 47.1 (22.) 92.0 (36.) 92.4 (14.)
 Trefferlage 0.19 mm links, 0.40 mm tief
 Streuwert 2.11, horizontal: 2.23, vertikal: 1.98

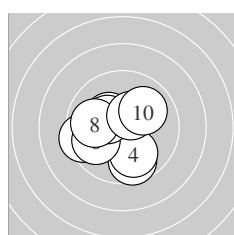
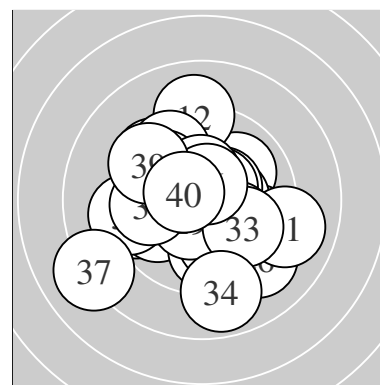

Serie 1:
 10.2 * 9.7 ↘ 9.4 ← 9.9 ↘ 10.3 *
 9.9 ← 10.3 * 9.9 ← 10.4 * 10.0 ↗
 beste Teiler 131.8 (9.) 156.9 (7.) 160.4 (5.)
 Trefferlage 0.85 mm links, 0.26 mm tief
 Streuwert 1.73, horizontal: 1.87, vertikal: 1.58

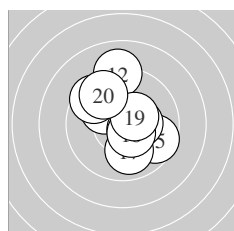

Serie 2:
 10.1 ↖ 9.1 ↑ 9.5 ↖ 10.6 * 9.6 ↘
 10.4 * 10.0 ↓ 10.5 * 10.4 * 9.7 ↖
 beste Teiler 92.4 (14.) 114.5 (18.) 130.3 (19.)
 Trefferlage 0.12 mm rechts, 0.67 mm hoch
 Streuwert 1.95, horizontal: 1.74, vertikal: 2.14

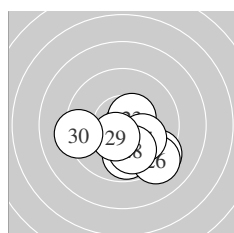

Serie 3:
 10.5 * 10.8 * 10.5 * 9.3 ↘ 9.8 ↓
 9.2 ↘ 10.1 ↘ 10.0 ↓ 10.5 * 9.3 ←
 beste Teiler 47.1 (22.) 110.2 (23.) 113.1 (21.)
 Trefferlage 0.64 mm rechts, 1.45 mm tief
 Streuwert 1.70, horizontal: 2.07, vertikal: 1.24

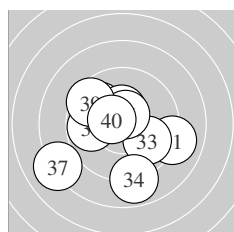

Serie 4:
 9.0 ↗ 9.9 ↖ 9.9 ↘ 8.9 ↓ 10.4 *
 10.6 * 8.1 ← 9.8 ← 9.5 ↖ 10.5 *
 beste Teiler 92.0 (36.) 109.7 (40.) 137.2 (35.)
 Trefferlage 0.69 mm links, 0.59 mm tief
 Streuwert 2.73, horizontal: 3.02, vertikal: 2.40

Unterschrift des Schützen

Meyton Elektronik

Ergebnis:	415.3	(395) ^{QF}							
Serien:	103.5	105.9	103.8	102.1					
Zähler:	35	5	0	0	0	0	0	0	0
Innenzehner:	32								
weiteste:	315 (35), 297 (30), 280 (3)								
beste Teiler	14.4 (40.) 29.8 (11.) 37.3 (15.)								
Trefferlage	0.11 mm rechts, 0.29 mm hoch								
Streuwert	1.14, horizontal: 1.20, vertikal: 1.07								

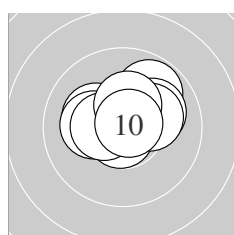
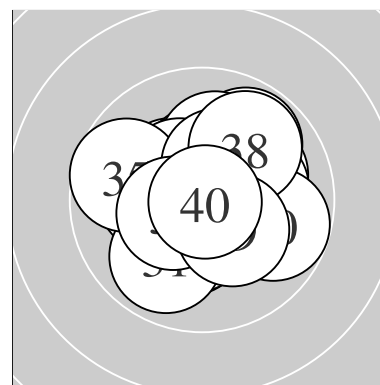

Serie 1:	10.8 *	10.5 *	9.8 ↗	10.2 *	10.1 ↗
	10.2 *	10.2 *	10.5 *	10.4 *	10.8 *
beste Teiler	48.5 (10.) 49.3 (1.) 120.4 (2.)				
Trefferlage	0.18 mm rechts, 0.69 mm hoch				
Streuwert	1.15, horizontal: 1.44, vertikal: 0.77				

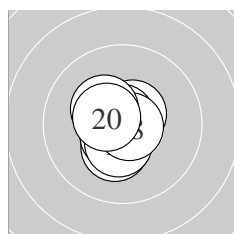

Serie 2:	10.8 *	10.3 *	10.6 *	10.6 *	10.8 *
	10.8 *	10.4 *	10.8 *	10.3 *	10.5 *
beste Teiler	29.8 (11.) 37.3 (15.) 41.4 (16.)				
Trefferlage	0.28 mm links, 0.05 mm tief				
Streuwert	0.73, horizontal: 0.59, vertikal: 0.85				

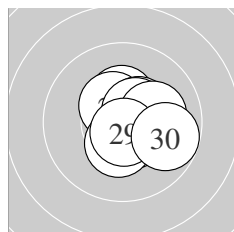

Serie 3:	10.4 *	10.4 *	10.5 *	10.4 *	10.5 *
	10.6 *	10.1 →	10.4 *	10.7 *	9.8 ↘
beste Teiler	67.6 (29.) 85.6 (26.) 108.3 (23.)				
Trefferlage	0.71 mm rechts, 0.00 mm				
Streuwert	1.03, horizontal: 1.06, vertikal: 1.00				

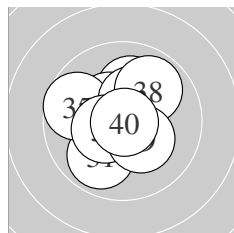

Serie 4:	9.9 ↙	10.2 *	10.1 ↑	10.4 *	9.7 ↖
	10.3 *	10.4 *	9.9 ↗	10.3 *	10.9 *
beste Teiler	14.4 (40.) 126.6 (37.) 133.1 (34.)				
Trefferlage	0.17 mm links, 0.52 mm hoch				
Streuwert	1.45, horizontal: 1.42, vertikal: 1.47				

QF – Schütze hat sich fürs Finale qualifiziert

Unterschrift des Schützen

Meyton Elektronik

Ergebnis: **412.2** (392)
 Serien: 104.9 103.6 101.6 102.1
 Zähler: 32 8 0 0 0 0 0 0 0 0
 Innenzehner: 30
 weiteste: 421 (39), 323 (34), 309 (22)
 beste Teiler 30.0 (18.) 41.1 (16.) 48.0 (2.)
 Trefferlage 0.46 mm links, 0.05 mm tief
 Streuwert 1.29, horizontal: 1.40, vertikal: 1.17

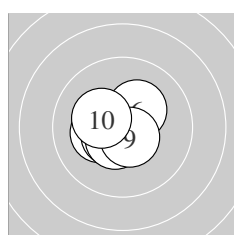
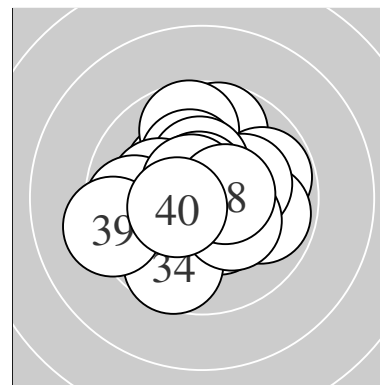

Serie 1:
 10.6 * 10.8 * 10.3 * 10.7 * 10.3 *
 10.3 * 10.5 * 10.5 * 10.6 * 10.3 *
 beste Teiler 48.0 (2.) 64.4 (4.) 89.8 (1.)
 Trefferlage 0.52 mm links, 0.02 mm hoch
 Streuwert 0.86, horizontal: 0.95, vertikal: 0.77

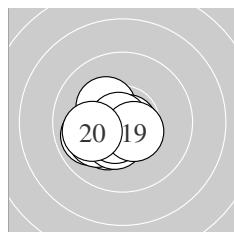

Serie 2:
 10.3 * 9.9 ← 10.1 ← 10.4 * 10.3 *
 10.8 * 10.5 * 10.8 * 10.5 * 10.0 ←
 beste Teiler 30.0 (18.) 41.1 (16.) 102.3 (17.)
 Trefferlage 0.91 mm links, 0.60 mm tief
 Streuwert 0.93, horizontal: 1.08, vertikal: 0.76

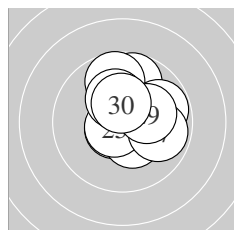

Serie 3:
 9.7 ↑ 9.7 ↑ 10.6 * 10.4 * 10.7 *
 9.8 → 9.9 → 10.2 * 10.2 * 10.4 *
 beste Teiler 71.8 (25.) 78.8 (23.) 141.8 (24.)
 Trefferlage 0.61 mm rechts, 0.79 mm hoch
 Streuwert 1.43, horizontal: 1.34, vertikal: 1.50

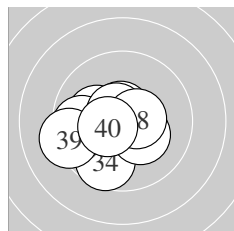

Serie 4:
 10.2 * 10.6 * 10.7 * 9.7 ↓ 9.7 ←
 10.3 * 10.6 * 10.5 * 9.3 ← 10.5 *
 beste Teiler 75.3 (33.) 77.6 (37.) 86.9 (32.)
 Trefferlage 1.04 mm links, 0.44 mm tief
 Streuwert 1.42, horizontal: 1.66, vertikal: 1.11

Unterschrift des Schützen

Meyton Elektronik

Ergebnis: **410.4** (391)
 Serien: 102.1 103.4 101.2 103.7
 Zähler: 31 9 0 0 0 0 0 0 0 0
 Innenzehner: 24
 weiteste: 369 (25), 364 (31), 352 (27)
 beste Teiler 50.6 (19.) 62.1 (12.) 62.3 (32.)
 Trefferlage 0.43 mm rechts, 0.08 mm hoch
 Streuwert 1.35, horizontal: 1.33, vertikal: 1.37

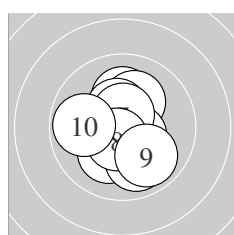
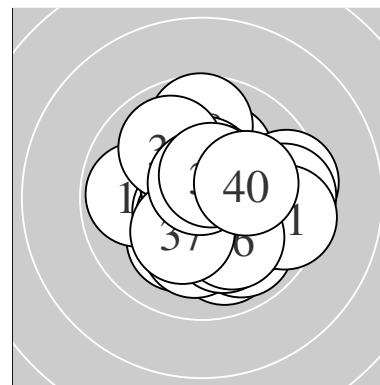

Serie 1:
 10.1 ↙ 10.1 ↑ 10.2 * 10.5 * 9.9 ↘
 10.4 * 10.6 * 10.6 * 9.9 ↘ 9.8 ←
 beste Teiler 91.0 (7.) 97.0 (8.) 110.9 (4.)
 Trefferlage 0.01 mm links, 0.14 mm tief
 Streuwert 1.45, horizontal: 1.26, vertikal: 1.63

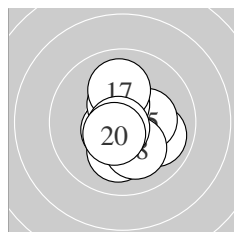

Serie 2:
 10.1 ↓ 10.7 * 10.6 * 9.9 ↘ 10.3 *
 10.4 * 10.0 ↑ 10.1 ↘ 10.8 * 10.5 *
 beste Teiler 50.6 (19.) 62.1 (12.) 93.6 (13.)
 Trefferlage 0.18 mm rechts, 0.31 mm tief
 Streuwert 1.20, horizontal: 1.07, vertikal: 1.32

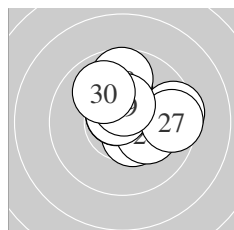

Serie 3:
 10.5 * 10.0 ↑ 10.7 * 10.2 * 9.5 →
 10.7 * 9.5 → 9.7 ↑ 10.5 * 9.9 ↘
 beste Teiler 69.4 (23.) 70.4 (26.) 119.0 (21.)
 Trefferlage 0.74 mm rechts, 0.90 mm hoch
 Streuwert 1.52, horizontal: 1.69, vertikal: 1.31

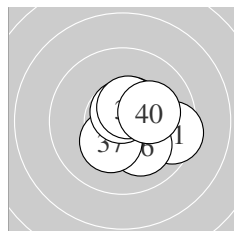

Serie 4:
 9.5 → 10.7 * 10.5 * 10.6 * 10.6 *
 10.1 ↘ 10.3 * 10.7 * 10.5 * 10.2 *
 beste Teiler 62.3 (32.) 65.6 (38.) 77.0 (35.)
 Trefferlage 0.83 mm rechts, 0.09 mm tief
 Streuwert 1.11, horizontal: 1.21, vertikal: 0.99

Unterschrift des Schützen

Ergebnis: **393.0** (376)
 Serien: 98.7 95.5 97.7 101.1
 Zähler: 19 18 3 0 0 0 0 0 0 0
 Innenzehner: 13
 weiteste: 585 (20), 552 (24), 550 (9)
 beste Teiler 45.1 (38.) 55.3 (32.) 76.6 (3.)
 Trefferlage 0.84 mm rechts, 1.32 mm hoch
 Streuwert 1.96, horizontal: 2.37, vertikal: 1.45

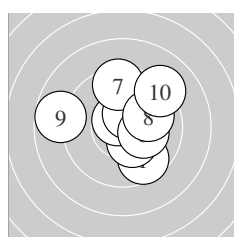
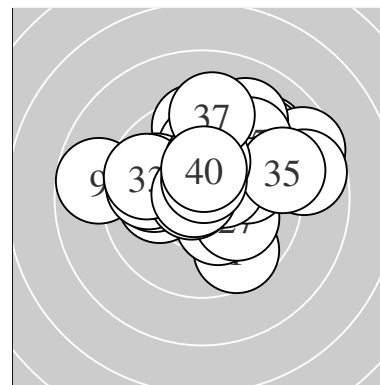

Serie 1:
 9.6 ↘ 10.3 * 10.6 * 10.2 * 10.4 *
 10.2 * 9.5 ↑ 10.0 → 8.8 ← 9.1 ↗
 beste Teiler 76.6 (3.) 127.9 (5.) 153.1 (2.)
 Trefferlage 0.59 mm rechts, 0.67 mm hoch
 Streuwert 2.18, horizontal: 2.42, vertikal: 1.91

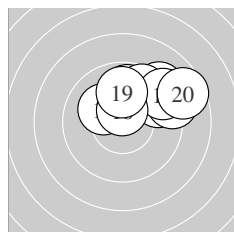

Serie 2:
 10.1 ↖ 9.2 ↗ 9.5 ↗ 9.8 ↑ 9.1 →
 9.6 ↗ 9.2 ↗ 10.5 * 9.9 ↑ 8.6 →
 beste Teiler 105.0 (18.) 201.6 (11.) 262.0 (19.)
 Trefferlage 1.97 mm rechts, 2.18 mm hoch
 Streuwert 1.68, horizontal: 2.26, vertikal: 0.72

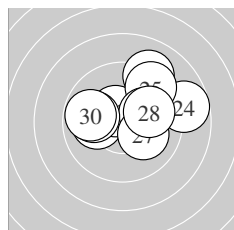

Serie 3:
 10.1 ← 10.5 * 9.1 ↗ 8.7 → 9.4 ↗
 10.1 → 10.1 ↘ 10.0 → 9.9 ← 9.8 ←
 beste Teiler 114.8 (22.) 206.3 (26.) 209.2 (27.)
 Trefferlage 0.79 mm rechts, 1.09 mm hoch
 Streuwert 2.17, horizontal: 2.70, vertikal: 1.47

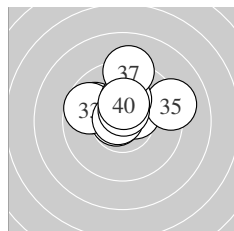

Serie 4:
 9.9 ↖ 10.7 * 9.7 ↖ 10.5 * 9.2 →
 10.2 * 9.2 ↑ 10.8 * 10.6 * 10.3 *
 beste Teiler 45.1 (38.) 55.3 (32.) 93.5 (39.)
 Trefferlage 0.00 mm , 1.33 mm hoch
 Streuwert 1.62, horizontal: 1.95, vertikal: 1.21

Unterschrift des Schützen

Meyton Elektronik

Ergebnis: **410.4** (392)
 Serien: 103.8 101.8 102.7 102.1
 Zähler: 32 8 0 0 0 0 0 0 0 0
 Innenzehner: 25
 weiteste: 409 (39), 335 (32), 319 (5)
 beste Teiler 6.0 (10.) 29.5 (40.) 54.1 (3.)
 Trefferlage 0.09 mm rechts, 0.15 mm hoch
 Streuwert 1.40, horizontal: 1.40, vertikal: 1.41

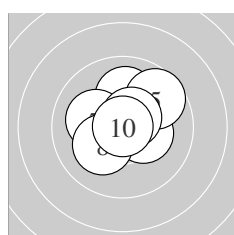
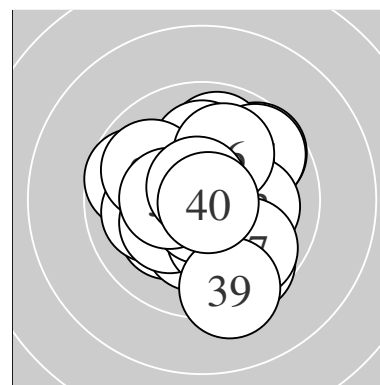

Serie 1:
 10.1 ↑ 10.5 * 10.7 * 10.3 * 9.7 ↗
 10.7 * 10.1 ← 10.2 * 10.6 * 10.9 *
 beste Teiler 6.0 (10.) 54.1 (3.) 69.6 (6.)
 Trefferlage 0.11 mm rechts, 0.46 mm hoch
 Streuwert 1.22, horizontal: 1.34, vertikal: 1.08

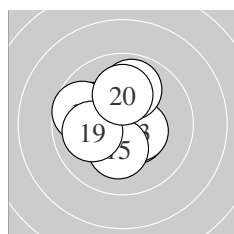

Serie 2:
 10.5 * 10.7 * 10.5 * 10.2 * 10.2 *
 9.9 ↑ 10.0 ← 9.7 ← 10.0 ← 10.1 ↑
 beste Teiler 69.8 (12.) 118.6 (11.) 124.8 (13.)
 Trefferlage 0.62 mm links, 0.26 mm hoch
 Streuwert 1.46, horizontal: 1.55, vertikal: 1.36

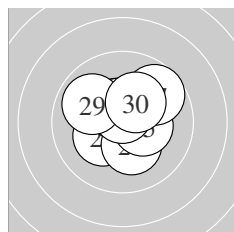

Serie 3:
 10.3 * 10.2 * 10.5 * 10.3 * 10.3 *
 10.5 * 9.7 ↗ 10.7 * 9.9 ↖ 10.3 *
 beste Teiler 67.0 (28.) 104.0 (26.) 110.9 (23.)
 Trefferlage 0.23 mm rechts, 0.55 mm hoch
 Streuwert 1.29, horizontal: 1.41, vertikal: 1.16

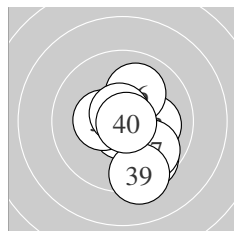

Serie 4:
 10.7 * 9.6 ↘ 10.1 → 10.4 * 10.7 *
 10.0 ↗ 9.8 ↘ 10.7 * 9.3 ↓ 10.8 *
 beste Teiler 29.5 (40.) 59.8 (35.) 60.0 (31.)
 Trefferlage 0.66 mm rechts, 0.65 mm tief
 Streuwert 1.51, horizontal: 1.17, vertikal: 1.78

Unterschrift des Schützen

Meyton Elektronik

Ergebnis: **405.3** (388)
 Serien: 100.7 100.7 103.1 100.8
 Zähler: 28 12 0 0 0 0 0 0 0 0
 Innenzehner: 22
 weiteste: 493 (2), 423 (19), 420 (15)
 beste Teiler 49.1 (16.) 51.8 (36.) 57.4 (29.)
 Trefferlage 0.05 mm links, 0.10 mm hoch
 Streuwert 1.67, horizontal: 1.78, vertikal: 1.56

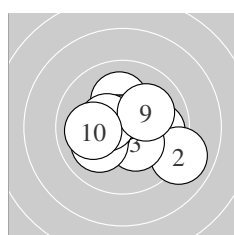
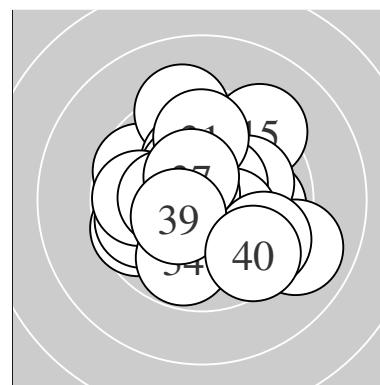

Serie 1:
 9.9 → 9.0 ↘ 10.3 * 10.5 * 10.3 *
 10.1 ← 10.1 ↑ 10.4 * 10.1 ↗ 10.0 ←
 beste Teiler 122.0 (4.) 127.7 (8.) 158.1 (3.)
 Trefferlage 0.26 mm rechts, 0.09 mm tief
 Streuwert 1.81, horizontal: 2.18, vertikal: 1.32

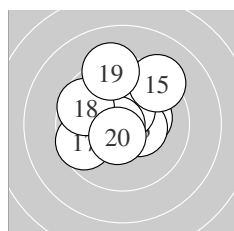

Serie 2:
 10.2 * 10.3 * 10.4 * 10.5 * 9.3 ↗
 10.8 * 9.6 ← 9.7 ↙ 9.3 ↑ 10.6 *
 beste Teiler 49.1 (16.) 100.7 (20.) 114.5 (14.)
 Trefferlage 0.09 mm links, 0.94 mm hoch
 Streuwert 1.81, horizontal: 1.87, vertikal: 1.75

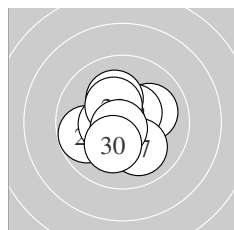

Serie 3:
 10.1 → 10.5 * 9.8 ← 10.7 * 10.2 *
 10.5 * 10.0 ↘ 10.4 * 10.7 * 10.2 *
 beste Teiler 57.4 (29.) 62.6 (24.) 112.6 (22.)
 Trefferlage 0.28 mm links, 0.03 mm tief
 Streuwert 1.32, horizontal: 1.38, vertikal: 1.26

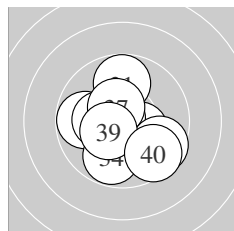

Serie 4:
 9.8 ↑ 9.8 ← 10.3 * 9.8 ↓ 10.3 *
 10.7 * 10.5 * 9.6 ↘ 10.4 * 9.6 ↘
 beste Teiler 51.8 (36.) 120.3 (37.) 135.6 (39.)
 Trefferlage 0.10 mm links, 0.41 mm tief
 Streuwert 1.77, horizontal: 1.82, vertikal: 1.72

Unterschrift des Schützen

Meyton Elektronik

Ergebnis: **420.9** (400)^{QF}
 Serien: 105.2 105.1 105.7 104.9
 Zähler: 40 0 0 0 0 0 0 0 0 0
 Innenzehner: 38
 weiteste: 229 (38), 202 (11), 177 (36)
 beste Teiler 39.0 (26.) 51.7 (40.) 52.0 (24.)
 Trefferlage 0.03 mm rechts, 0.01 mm tief
 Streuwert 0.84, horizontal: 0.90, vertikal: 0.77

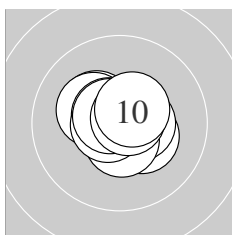
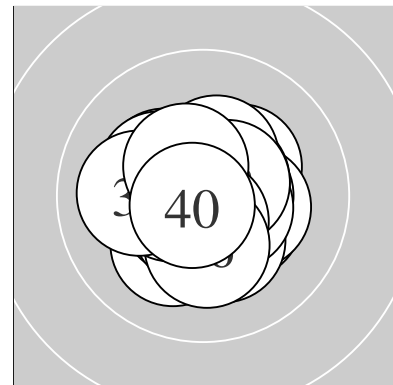

Serie 1:
 10.3 * 10.3 * 10.3 * 10.6 * 10.5 *
 10.6 * 10.7 * 10.7 * 10.7 * 10.5 *
 beste Teiler 58.8 (9.) 70.7 (7.) 70.8 (8.)
 Trefferlage 0.10 mm links, 0.18 mm hoch
 Streuwert 0.85, horizontal: 1.01, vertikal: 0.65

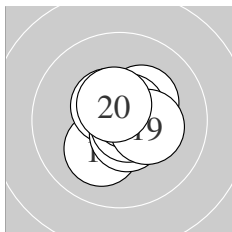

Serie 2:
 10.1 ✓ 10.5 * 10.6 * 10.3 * 10.6 *
 10.7 * 10.7 * 10.7 * 10.3 * 10.6 *
 beste Teiler 57.7 (17.) 73.5 (18.) 74.2 (16.)
 Trefferlage 0.36 mm rechts, 0.07 mm hoch
 Streuwert 0.86, horizontal: 0.84, vertikal: 0.88

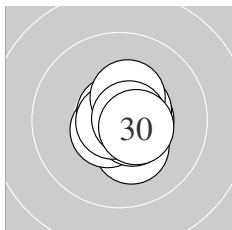

Serie 3:
 10.3 * 10.6 * 10.6 * 10.7 * 10.6 *
 10.8 * 10.5 * 10.4 * 10.7 * 10.5 *
 beste Teiler 39.0 (26.) 52.0 (24.) 57.8 (29.)
 Trefferlage 0.39 mm rechts, 0.07 mm tief
 Streuwert 0.71, horizontal: 0.63, vertikal: 0.79

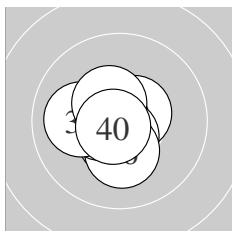

Serie 4:
 10.5 * 10.6 * 10.6 * 10.7 * 10.6 *
 10.2 * 10.5 * 10.0 ← 10.5 * 10.7 *
 beste Teiler 51.7 (40.) 67.7 (34.) 87.0 (35.)
 Trefferlage 0.51 mm links, 0.26 mm tief
 Streuwert 0.83, horizontal: 0.85, vertikal: 0.80

QF – Schütze hat sich fürs Finale qualifiziert

Unterschrift des Schützen

Meyton Elektronik

Ergebnis:	415.1	(398) ^{QF}							
Serien:	103.1	103.6	103.8	104.6					
Zähler:	38	2	0	0	0	0	0	0	0
Innenzehner:	32								
weiteste:	300 (8), 267 (40), 250 (22)								
beste Teiler	35.6 (28.)	47.4 (31.)	48.2 (5.)						
Trefferlage	0.32 mm rechts, 0.24 mm hoch								
Streuwert	1.10, horizontal: 1.30, vertikal: 0.85								

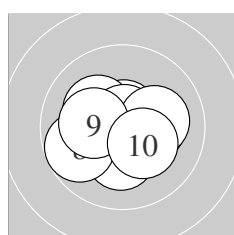
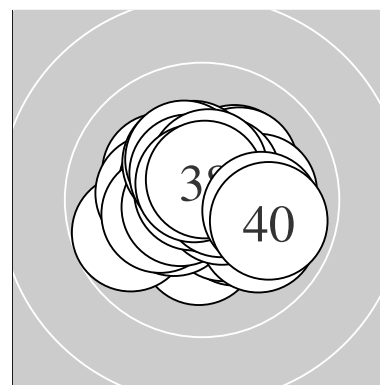

Serie 1:

10.6 *	10.7 *	10.2 *	10.2 *	10.8 *
10.2 *	10.1 →	9.8 ←	10.2 *	10.3 *
beste Teiler	48.2 (5.)	55.8 (2.)	77.3 (1.)	
Trefferlage	0.13 mm links, 0.14 mm tief			
Streuwert	1.29, horizontal: 1.57, vertikal: 0.94			

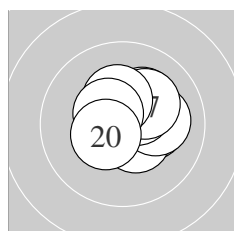

Serie 2:

10.2 *	10.2 *	10.5 *	10.7 *	10.1 →
10.4 *	10.2 *	10.3 *	10.5 *	10.5 *
beste Teiler	66.7 (14.)	114.4 (19.)	120.2 (13.)	
Trefferlage	0.58 mm rechts, 0.51 mm hoch			
Streuwert	0.99, horizontal: 1.12, vertikal: 0.83			

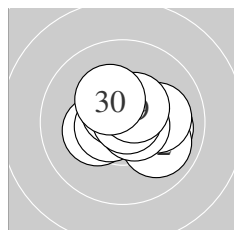

Serie 3:

10.0 →	10.0 ↘	10.3 *	10.6 *	10.1 →
10.6 *	10.6 *	10.8 *	10.5 *	10.3 *
beste Teiler	35.6 (28.)	79.4 (27.)	84.1 (26.)	
Trefferlage	0.47 mm rechts, 0.08 mm hoch			
Streuwert	1.13, horizontal: 1.39, vertikal: 0.80			

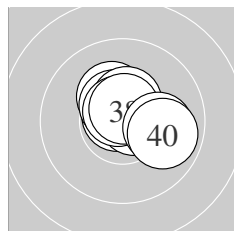

Serie 4:

10.8 *	10.7 *	10.3 *	10.6 *	10.5 *
10.5 *	10.7 *	10.6 *	10.0 →	9.9 →
beste Teiler	47.4 (31.)	69.7 (37.)	73.2 (32.)	
Trefferlage	0.37 mm rechts, 0.52 mm hoch			
Streuwert	0.96, horizontal: 1.15, vertikal: 0.73			

QF – Schütze hat sich fürs Finale qualifiziert

Unterschrift des Schützen

Meyton Elektronik

Ergebnis: **410.0** (391)
 Serien: 100.9 102.7 105.1 101.3
 Zähler: 31 9 0 0 0 0 0 0 0 0
 Innenzehner: 27
 weiteste: 433 (1), 320 (18), 306 (32)
 beste Teiler 26.2 (30.) 42.1 (28.) 55.3 (14.)
 Trefferlage 0.44 mm rechts, 0.02 mm hoch
 Streuwert 1.36, horizontal: 1.43, vertikal: 1.30

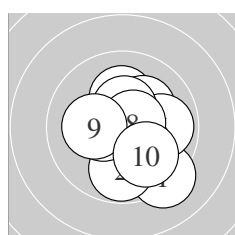
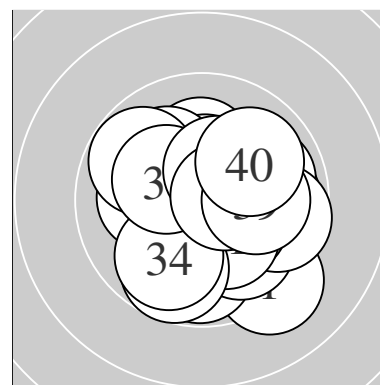

Serie 1:
 9.2 ↘ 9.8 ↓ 10.4 * 10.2 * 10.2 *
 9.9 → 10.4 * 10.6 * 10.2 * 10.0 ↘
 beste Teiler 78.3 (8.) 129.5 (7.) 133.3 (3.)
 Trefferlage 0.58 mm rechts, 0.31 mm tief
 Streuwert 1.69, horizontal: 1.57, vertikal: 1.80

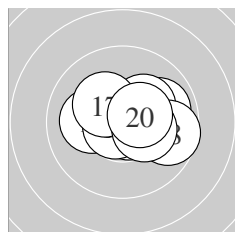

Serie 2:
 10.1 ← 10.4 * 9.9 → 10.7 * 10.2 *
 10.7 * 10.3 * 9.7 → 10.3 * 10.4 *
 beste Teiler 55.3 (14.) 58.6 (16.) 128.6 (20.)
 Trefferlage 0.74 mm rechts, 0.26 mm hoch
 Streuwert 1.25, horizontal: 1.62, vertikal: 0.71

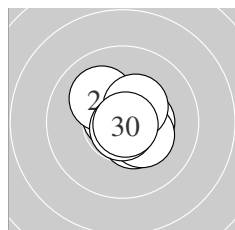

Serie 3:
 10.5 * 10.7 * 10.6 * 10.1 ↘ 10.4 *
 10.5 * 10.3 * 10.8 * 10.4 * 10.8 *
 beste Teiler 26.2 (30.) 42.1 (28.) 65.2 (22.)
 Trefferlage 0.28 mm rechts, 0.21 mm hoch
 Streuwert 0.87, horizontal: 0.90, vertikal: 0.85

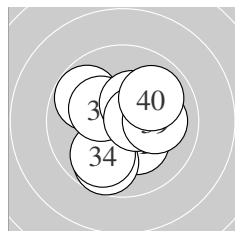

Serie 4:
 10.3 * 9.7 ↓ 10.3 * 9.9 ↙ 9.8 ↘
 10.3 * 10.4 * 10.6 * 10.1 → 9.9 ↗
 beste Teiler 95.3 (38.) 138.6 (37.) 155.2 (33.)
 Trefferlage 0.17 mm rechts, 0.06 mm tief
 Streuwert 1.62, horizontal: 1.64, vertikal: 1.60

Unterschrift des Schützen

Meyton Elektronik

Ergebnis: **397.3** (380)
 Serien: 99.5 99.3 100.6 97.9
 Zähler: 24 13 2 1 0 0 0 0 0 0
 Innenzehner: 18
 weiteste: 862 (14), 529 (33), 517 (6)
 beste Teiler 47.5 (20.) 51.4 (5.) 86.4 (21.)
 Trefferlage 0.47 mm links, 0.68 mm hoch
 Streuwert 2.06, horizontal: 2.48, vertikal: 1.54

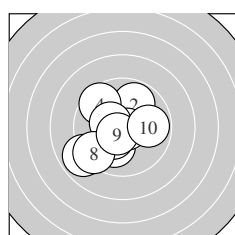
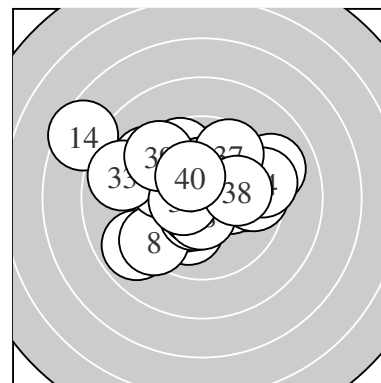

Serie 1:
 10.1 ↘ 9.8 ↗ 10.3 * 9.6 ↖ 10.7 *
 8.9 ↙ 10.4 * 9.3 ↗ 10.6 * 9.8 →
 beste Teiler 51.4 (5.) 91.8 (9.) 138.5 (7.)
 Trefferlage 0.90 mm links, 0.43 mm tief
 Streuwert 1.99, horizontal: 2.05, vertikal: 1.93

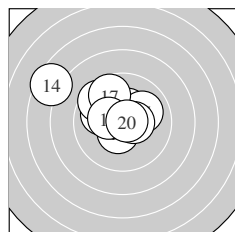

Serie 2:
 10.0 ↖ 9.6 ↖ 10.4 * 7.5 ↖ 10.0 →
 10.5 * 9.7 ↖ 10.5 * 10.3 * 10.8 *
 beste Teiler 47.5 (20.) 118.0 (18.) 122.2 (16.)
 Trefferlage 1.16 mm links, 1.18 mm hoch
 Streuwert 2.21, horizontal: 2.73, vertikal: 1.52

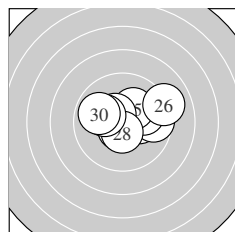

Serie 3:
 10.6 * 10.2 * 9.6 → 10.0 → 10.2 *
 9.0 → 10.5 * 10.5 * 10.1 ↖ 9.9 ↖
 beste Teiler 86.4 (21.) 107.1 (28.) 115.9 (27.)
 Trefferlage 0.71 mm rechts, 0.48 mm hoch
 Streuwert 1.72, horizontal: 2.25, vertikal: 0.93

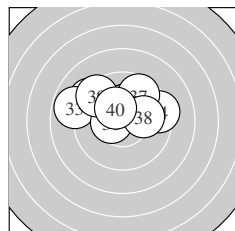

Serie 4:
 9.3 ↖ 10.3 * 8.8 ↖ 9.4 → 10.3 *
 10.5 * 9.6 ↗ 10.0 → 9.4 ↖ 10.3 *
 beste Teiler 119.8 (36.) 158.4 (40.) 161.2 (32.)
 Trefferlage 0.56 mm links, 1.52 mm hoch
 Streuwert 2.05, horizontal: 2.75, vertikal: 0.94

Unterschrift des Schützen

Meyton Elektronik

Ergebnis: **412.3** (393)^{QF}
 Serien: 100.0 104.6 103.8 103.9
 Zähler: 35 3 2 0 0 0 0 0 0 0
 Innenzehner: 31
 weiteste: 509 (39), 504 (2), 387 (6)
 beste Teiler 16.5 (16.) 33.9 (22.) 38.9 (35.)
 Trefferlage 0.23 mm links, 0.36 mm tief
 Streuwert 1.37, horizontal: 1.55, vertikal: 1.15

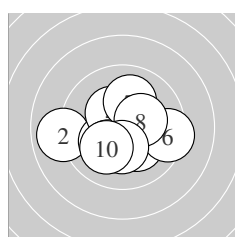
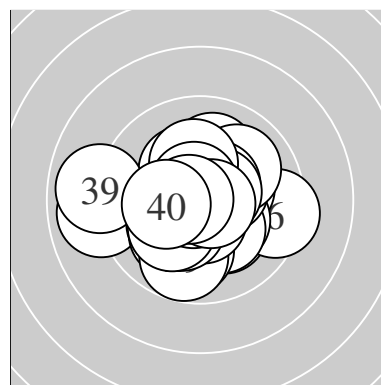

Serie 1:
 10.2 * 8.9 ← 10.2 * 10.4 * 10.1 ↘
 9.4 → 10.1 ↑ 10.3 * 10.3 * 10.1 ↘
 beste Teiler 150.6 (4.) 163.9 (8.) 168.1 (9.)
 Trefferlage 0.28 mm links, 0.50 mm tief
 Streuwert 1.91, horizontal: 2.34, vertikal: 1.36

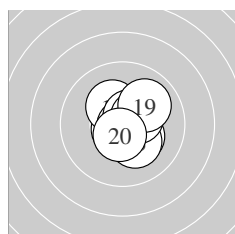

Serie 2:
 10.6 * 10.3 * 10.2 * 10.7 * 10.3 *
 10.9 * 10.6 * 10.4 * 10.0 ↗ 10.6 *
 beste Teiler 16.5 (16.) 58.7 (14.) 88.5 (17.)
 Trefferlage 0.53 mm rechts, 0.00 mm
 Streuwert 0.96, horizontal: 0.87, vertikal: 1.04

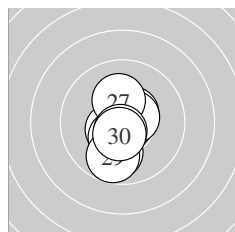

Serie 3:
 10.5 * 10.8 * 9.9 ↓ 10.5 * 10.6 *
 10.4 * 10.2 * 10.6 * 9.8 ↓ 10.5 *
 beste Teiler 33.9 (22.) 78.3 (28.) 96.1 (25.)
 Trefferlage 0.17 mm links, 0.62 mm tief
 Streuwert 1.11, horizontal: 0.63, vertikal: 1.43

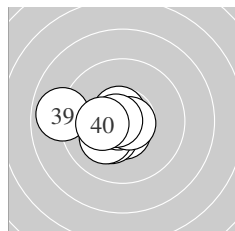

Serie 4:
 10.7 * 10.6 * 10.3 * 10.2 * 10.8 *
 10.7 * 10.7 * 10.7 * 8.9 ← 10.3 *
 beste Teiler 38.9 (35.) 56.0 (38.) 58.1 (37.)
 Trefferlage 1.02 mm links, 0.30 mm tief
 Streuwert 1.22, horizontal: 1.57, vertikal: 0.71

QF – Schütze hat sich fürs Finale qualifiziert

Unterschrift des Schützen

Meyton Elektronik

Ergebnis: **406.7** (390)
 Serien: 101.1 99.6 103.4 102.6
 Zähler: 31 8 1 0 0 0 0 0 0
 Innenzehner: 24
 weiteste: 646 (12), 499 (36), 430 (3)
 beste Teiler 46.6 (28.) 62.2 (15.) 67.4 (29.)
 Trefferlage 0.22 mm rechts, 0.65 mm hoch
 Streuwert 1.61, horizontal: 1.75, vertikal: 1.45

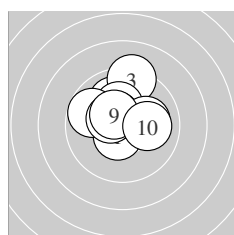
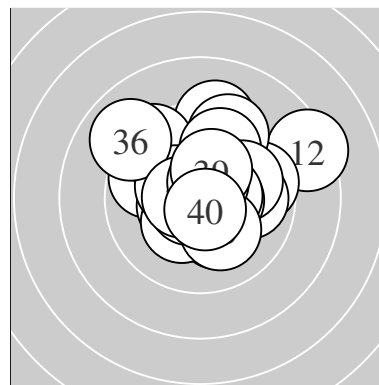

Serie 1:
 10.5 * 10.0 ↖ 9.2 ↑ 10.2 * 9.7 ↖
 10.5 * 10.1 → 10.4 * 10.5 * 10.0 →
 beste Teiler 106.0 (1.) 107.4 (6.) 124.4 (9.)
 Trefferlage 0.17 mm links, 1.10 mm hoch
 Streuwert 1.47, horizontal: 1.53, vertikal: 1.41

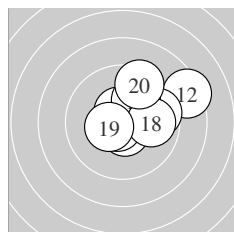

Serie 2:
 10.6 * 8.4 ↗ 10.1 ↗ 9.6 → 10.7 *
 10.5 * 10.0 ↗ 9.9 → 10.4 * 9.4 ↑
 beste Teiler 62.2 (15.) 90.7 (11.) 104.1 (16.)
 Trefferlage 1.40 mm rechts, 0.96 mm hoch
 Streuwert 1.81, horizontal: 2.11, vertikal: 1.44

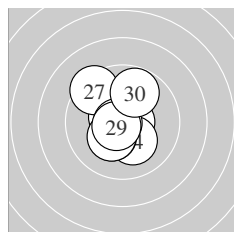

Serie 3:
 10.6 * 10.7 * 10.6 * 10.2 * 10.3 *
 10.3 * 9.4 ↖ 10.8 * 10.7 * 9.8 ↑
 beste Teiler 46.6 (28.) 67.4 (29.) 71.0 (22.)
 Trefferlage 0.43 mm links, 0.07 mm hoch
 Streuwert 1.37, horizontal: 1.11, vertikal: 1.59

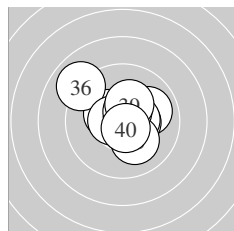

Serie 4:
 10.0 → 10.4 * 10.5 * 10.4 * 10.1 ↘
 9.0 ↖ 10.6 * 10.6 * 10.3 * 10.7 *
 beste Teiler 69.8 (40.) 96.1 (37.) 97.4 (38.)
 Trefferlage 0.11 mm rechts, 0.48 mm hoch
 Streuwert 1.55, horizontal: 1.75, vertikal: 1.32

Unterschrift des Schützen

Meyton Elektronik

Ergebnis: **411.7** (395)
 Serien: 103.2 103.3 104.3 100.9
 Zähler: 35 5 0 0 0 0 0 0 0 0
 Innenzehner: 28
 weiteste: 408 (29), 398 (37), 383 (11)
 beste Teiler 15.1 (24.) 27.8 (26.) 48.8 (4.)
 Trefferlage 0.22 mm rechts, 0.04 mm hoch
 Streuwert 1.36, horizontal: 1.16, vertikal: 1.53

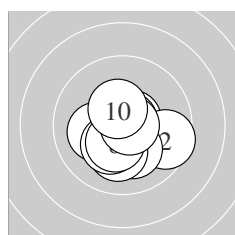
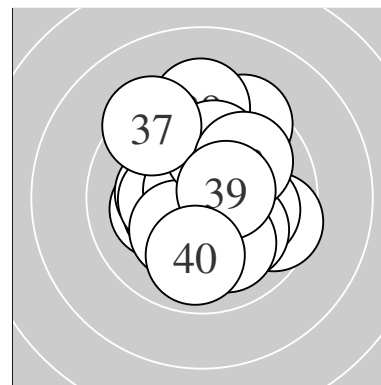

Serie 1:
 10.6 * 9.6 ↘ 10.1 ← 10.8 * 10.2 *
 10.1 ↓ 10.3 * 10.4 * 10.7 * 10.4 *
 beste Teiler 48.8 (4.) 53.0 (9.) 79.4 (1.)
 Trefferlage 0.14 mm rechts, 0.62 mm tief
 Streuwert 1.23, horizontal: 1.38, vertikal: 1.07

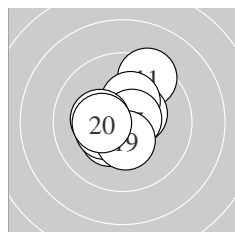

Serie 2:
 9.4 ↗ 10.4 * 10.7 * 10.3 * 10.7 *
 10.4 * 10.3 * 10.4 * 10.4 * 10.3 *
 beste Teiler 65.4 (13.) 74.9 (15.) 130.7 (12.)
 Trefferlage 0.08 mm links, 0.35 mm hoch
 Streuwert 1.30, horizontal: 1.24, vertikal: 1.37

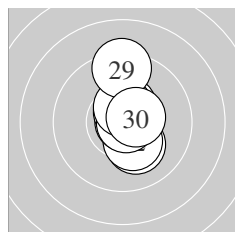

Serie 3:
 10.2 * 10.3 * 10.7 * 10.9 * 10.6 *
 10.8 * 10.5 * 10.5 * 9.3 ↑ 10.5 *
 beste Teiler 15.1 (24.) 27.8 (26.) 55.0 (23.)
 Trefferlage 0.40 mm rechts, 0.46 mm hoch
 Streuwert 1.16, horizontal: 0.40, vertikal: 1.59

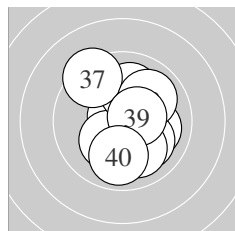

Serie 4:
 10.0 → 10.7 * 10.1 ↘ 10.2 * 10.0 ↘
 10.1 ↑ 9.4 ↘ 10.0 ↗ 10.5 * 9.9 ↓
 beste Teiler 54.8 (32.) 114.1 (39.) 178.8 (34.)
 Trefferlage 0.44 mm rechts, 0.02 mm tief
 Streuwert 1.71, horizontal: 1.44, vertikal: 1.94

Unterschrift des Schützen

Meyton Elektronik

Ergebnis: **416.2** (396)^{QF}
 Serien: 103.3 104.6 103.4 104.9
 Zähler: 36 4 0 0 0 0 0 0 0 0
 Innenzehner: 34
 weiteste: 338 (4), 300 (3), 292 (32)
 beste Teiler 24.0 (37.) 35.0 (6.) 39.5 (36.)
 Trefferlage 0.24 mm links, 0.18 mm hoch
 Streuwert 1.11, horizontal: 1.21, vertikal: 0.99

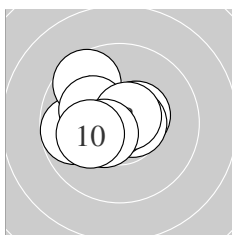
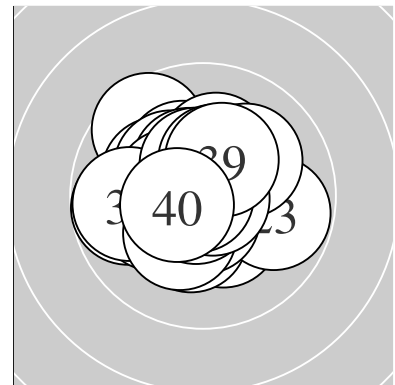

Serie 1:
 10.5 * 10.5 * 9.8 ← 9.6 ↖ 10.6 *
 10.8 * 10.2 * 10.7 * 10.5 * 10.1 ←
 beste Teiler 35.0 (6.) 68.6 (8.) 86.0 (5.)
 Trefferlage 0.67 mm links, 0.31 mm hoch
 Streuwert 1.26, horizontal: 1.49, vertikal: 0.97

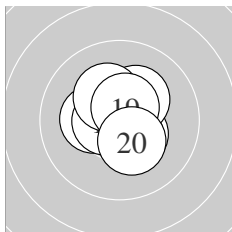

Serie 2:
 10.5 * 10.4 * 10.8 * 10.5 * 10.3 *
 10.3 * 10.6 * 10.3 * 10.6 * 10.3 *
 beste Teiler 41.1 (13.) 90.1 (17.) 92.3 (19.)
 Trefferlage 0.09 mm rechts, 0.15 mm hoch
 Streuwert 0.98, horizontal: 0.92, vertikal: 1.03

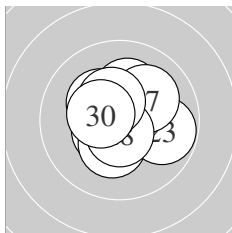

Serie 3:
 10.5 * 10.3 * 9.8 → 10.3 * 10.2 *
 10.8 * 10.1 ↗ 10.6 * 10.4 * 10.4 *
 beste Teiler 40.6 (26.) 83.0 (28.) 116.2 (21.)
 Trefferlage 0.02 mm rechts, 0.19 mm hoch
 Streuwert 1.24, horizontal: 1.31, vertikal: 1.16

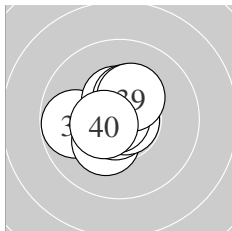

Serie 4:
 10.8 * 9.8 ← 10.4 * 10.3 * 10.7 *
 10.8 * 10.9 * 10.4 * 10.3 * 10.5 *
 beste Teiler 24.0 (37.) 39.5 (36.) 43.1 (31.)
 Trefferlage 0.43 mm links, 0.10 mm hoch
 Streuwert 0.99, horizontal: 1.04, vertikal: 0.95

QF – Schütze hat sich fürs Finale qualifiziert

Unterschrift des Schützen

Meyton Elektronik

Ergebnis: **410.1** (389)
 Serien: 103.7 101.2 101.9 103.3
 Zähler: 29 11 0 0 0 0 0 0 0 0
 Innenzehner: 29
 weiteste: 419 (22), 375 (31), 370 (15)
 beste Teiler 35.7 (34.) 44.0 (39.) 50.0 (32.)
 Trefferlage 0.19 mm links, 0.23 mm hoch
 Streuwert 1.43, horizontal: 1.55, vertikal: 1.30

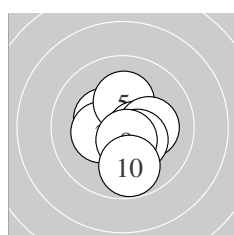
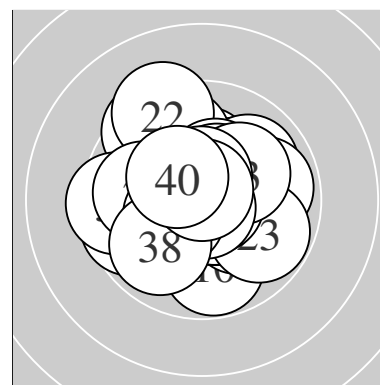

Serie 1:
 10.4 * 10.7 * 10.3 * 10.6 * 10.2 *
 10.5 * 10.2 * 10.4 * 10.6 * 9.8 ↓
 beste Teiler 57.7 (2.) 96.2 (4.) 98.3 (9.)
 Trefferlage 0.21 mm rechts, 0.24 mm tief
 Streuwert 1.17, horizontal: 1.10, vertikal: 1.24

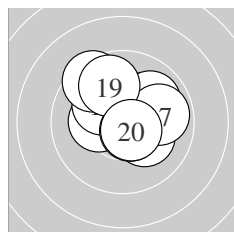

Serie 2:
 10.3 * 10.2 * 10.2 * 10.2 * 9.5 ↗
 9.9 ↗ 9.9 → 10.6 * 9.8 ↗ 10.6 *
 beste Teiler 83.5 (18.) 86.3 (20.) 174.1 (11.)
 Trefferlage 0.25 mm rechts, 0.82 mm hoch
 Streuwert 1.56, horizontal: 1.72, vertikal: 1.38

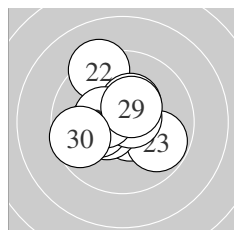

Serie 3:
 10.6 * 9.3 ↖ 9.8 ↘ 10.4 * 10.5 *
 10.2 * 10.7 * 10.4 * 10.4 * 9.6 ←
 beste Teiler 72.0 (27.) 81.4 (21.) 125.8 (25.)
 Trefferlage 0.42 mm links, 0.30 mm hoch
 Streuwert 1.60, horizontal: 1.67, vertikal: 1.52

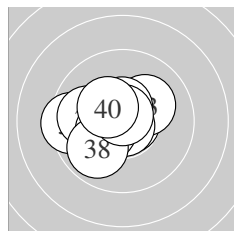

Serie 4:
 9.5 ← 10.8 * 10.2 * 10.8 * 9.9 ←
 10.4 * 10.6 * 9.9 ↙ 10.8 * 10.4 *
 beste Teiler 35.7 (34.) 44.0 (39.) 50.0 (32.)
 Trefferlage 0.82 mm links, 0.07 mm hoch
 Streuwert 1.31, horizontal: 1.59, vertikal: 0.94

Unterschrift des Schützen

Meyton Elektronik

Ergebnis: **394.9** (376)
 Serien: 99.3 99.2 97.4 99.0
 Zähler: 18 20 2 0 0 0 0 0 0 0
 Innenzehner: 10
 weiteste: 640 (23), 527 (20), 457 (5)
 beste Teiler 55.8 (3.) 56.5 (9.) 61.9 (14.)
 Trefferlage 0.31 mm links, 0.49 mm hoch
 Streuwert 2.10, horizontal: 2.46, vertikal: 1.67

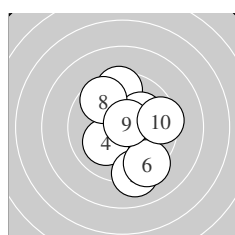
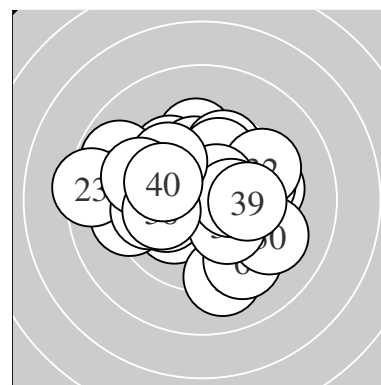

Serie 1:
 10.6 * 9.5 ↑ 10.7 * 10.1 ↙ 9.1 ↓
 9.3 ↘ 10.1 ↗ 9.7 ↘ 10.7 * 9.5 →
 beste Teiler 55.8 (3.) 56.5 (9.) 96.5 (1.)
 Trefferlage 0.64 mm rechts, 0.20 mm tief
 Streuwert 2.12, horizontal: 1.68, vertikal: 2.48

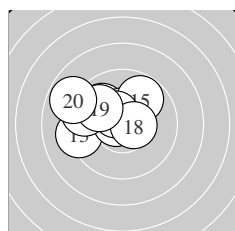

Serie 2:
 9.9 ↘ 10.5 * 9.2 ← 10.7 * 9.8 ↗
 10.5 * 9.4 ← 10.5 * 9.9 ↘ 8.8 ↘
 beste Teiler 61.9 (14.) 105.4 (18.) 113.4 (16.)
 Trefferlage 1.54 mm links, 1.01 mm hoch
 Streuwert 1.71, horizontal: 2.17, vertikal: 1.07

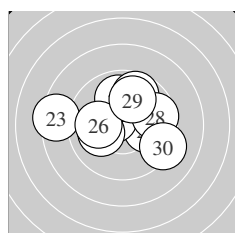

Serie 3:
 10.0 → 10.5 * 8.4 ← 9.9 ↑ 10.1 ←
 10.0 ← 9.7 ↑ 9.7 → 9.9 ↑ 9.2 ↘
 beste Teiler 102.0 (22.) 217.9 (25.) 231.0 (26.)
 Trefferlage 0.05 mm links, 0.69 mm hoch
 Streuwert 2.43, horizontal: 3.04, vertikal: 1.58

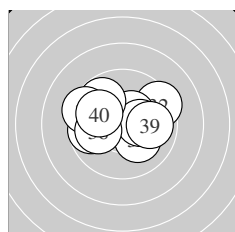

Serie 4:
 10.1 ↘ 9.4 ↗ 9.7 ← 10.4 * 10.3 *
 9.8 ↘ 9.4 ← 10.0 ← 9.9 → 10.0 ↘
 beste Teiler 126.1 (34.) 167.3 (35.) 202.9 (31.)
 Trefferlage 0.31 mm links, 0.47 mm hoch
 Streuwert 1.99, horizontal: 2.56, vertikal: 1.18

Unterschrift des Schützen

Meyton Elektronik

Ergebnis: **397.2** (379)
 Serien: 99.4 99.6 98.9 99.3
 Zähler: 21 17 2 0 0 0 0 0 0 0
 Innenzehner: 12
 weiteste: 659 (24), 594 (14), 421 (2)
 beste Teiler 66.8 (19.) 92.9 (25.) 94.6 (33.)
 Trefferlage 0.19 mm links, 0.24 mm hoch
 Streuwert 2.01, horizontal: 2.12, vertikal: 1.89

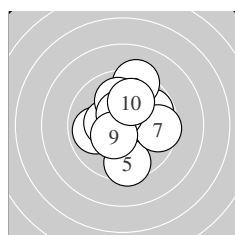
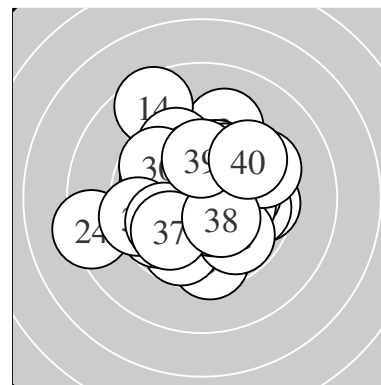

Serie 1:
 9.8 ↗ 9.3 ↑ 9.9 ← 10.4 * 9.5 ↓
 10.0 ↑ 9.6 → 10.5 * 10.4 * 10.0 ↑
 beste Teiler 109.8 (8.) 126.2 (9.) 148.6 (4.)
 Trefferlage 0.29 mm rechts, 0.58 mm hoch
 Streuwert 1.97, horizontal: 1.81, vertikal: 2.11

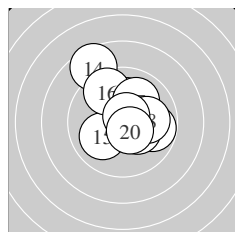

Serie 2:
 9.8 → 10.3 * 10.1 ↑ 8.6 ↘ 10.0 ↙
 9.6 ↘ 10.0 ↗ 10.0 → 10.7 * 10.5 *
 beste Teiler 66.8 (19.) 105.5 (20.) 164.8 (12.)
 Trefferlage 0.30 mm rechts, 0.94 mm hoch
 Streuwert 1.97, horizontal: 1.84, vertikal: 2.08

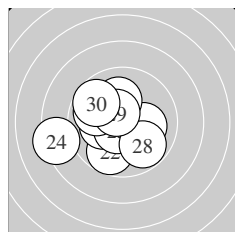

Serie 3:
 10.1 → 9.7 ↓ 10.2 * 8.3 ← 10.6 *
 9.9 ↖ 10.1 ↑ 9.8 ↘ 10.5 * 9.7 ↗
 beste Teiler 92.9 (25.) 106.7 (29.) 192.0 (23.)
 Trefferlage 1.20 mm links, 0.24 mm tief
 Streuwert 2.06, horizontal: 2.39, vertikal: 1.67

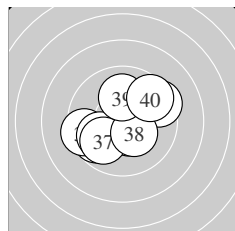

Serie 4:
 9.7 ↙ 9.4 ← 10.6 * 10.5 * 9.4 ↗
 9.9 ↙ 9.9 ↙ 10.3 * 10.0 ↑ 9.6 ↗
 beste Teiler 94.6 (33.) 123.4 (34.) 158.4 (38.)
 Trefferlage 0.19 mm links, 0.29 mm tief
 Streuwert 2.01, horizontal: 2.31, vertikal: 1.65

Unterschrift des Schützen

Meyton Elektronik

Ergebnis:	413.1	(392) ^{QF}
Serien:	103.9	103.0 104.9 101.3
Zähler:	32	8 0 0 0 0 0 0 0 0
Innenzehner:	29	
weiteste:	411 (40), 396 (35), 364 (14)	
beste Teiler	2.0 (5.)	6.0 (2.) 20.2 (12.)
Trefferlage	0.08 mm rechts, 0.09 mm hoch	
Streuwert	1.35, horizontal: 1.59, vertikal: 1.06	

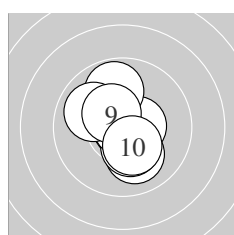
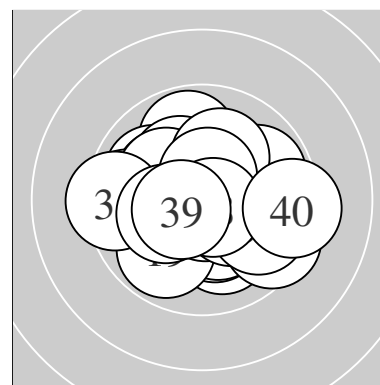

Serie 1:	10.1 ↘	10.9 *	10.3 *	10.7 *	10.9 *
	10.5 *	9.8 ↑	10.0 ↖	10.4 *	10.3 *
beste Teiler	2.0 (5.) 6.0 (2.) 51.9 (4.)				
Trefferlage	0.01 mm rechts, 0.02 mm tief				
Streuwert	1.23, horizontal: 1.00, vertikal: 1.42				

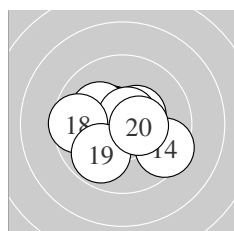

Serie 2:	10.5 *	10.9 *	10.7 *	9.5 ↘	10.2 *
	10.5 *	10.7 *	9.6 ←	9.9 ↙	10.5 *
beste Teiler	20.2 (12.) 57.0 (13.) 67.9 (17.)				
Trefferlage	0.21 mm links, 0.07 mm tief				
Streuwert	1.51, horizontal: 1.84, vertikal: 1.08				

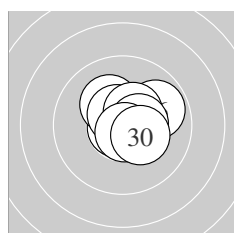

Serie 3:	10.8 *	10.7 *	10.2 *	10.8 *	10.6 *
	9.9 ↗	10.4 *	10.5 *	10.7 *	10.3 *
beste Teiler	45.2 (24.) 47.0 (21.) 56.0 (29.)				
Trefferlage	0.50 mm rechts, 0.31 mm hoch				
Streuwert	0.92, horizontal: 1.02, vertikal: 0.79				

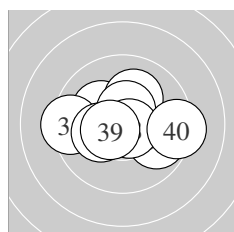

Serie 4:	9.8 ↘	10.6 *	10.2 *	10.1 ↗	9.4 ←
	10.2 *	10.5 *	10.7 *	10.5 *	9.3 →
beste Teiler	60.4 (38.) 78.8 (32.) 104.6 (39.)				
Trefferlage	0.02 mm rechts, 0.17 mm hoch				
Streuwert	1.74, horizontal: 2.27, vertikal: 0.96				

QF – Schütze hat sich fürs Finale qualifiziert

Unterschrift des Schützen

Meyton Elektronik

Ergebnis: **416.7** (395)^{QF}
 Serien: 105.2 103.2 103.1 105.2
 Zähler: 35 5 0 0 0 0 0 0 0 0
 Innenzehner: 32
 weiteste: 393 (29), 314 (18), 283 (27)
 beste Teiler 20.0 (1.) 37.7 (4.) 43.1 (40.)
 Trefferlage 0.15 mm links, 0.27 mm hoch
 Streuwert 1.09, horizontal: 1.13, vertikal: 1.06

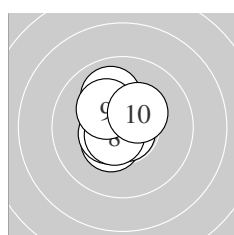
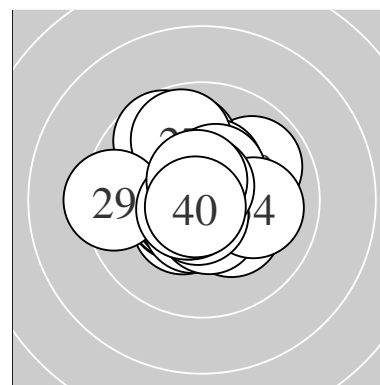

Serie 1:
 10.9 * 10.8 * 10.4 * 10.8 * 10.5 *
 10.0 † 10.7 * 10.6 * 10.2 * 10.3 *
 beste Teiler 20.0 (1.) 37.7 (4.) 44.0 (2.)
 Trefferlage 0.40 mm links, 0.26 mm hoch
 Streuwert 0.88, horizontal: 0.70, vertikal: 1.02

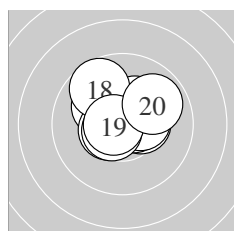

Serie 2:
 10.1 † 10.3 * 10.4 * 10.6 * 10.4 *
 10.5 * 10.6 * 9.7 † 10.7 * 9.9 †
 beste Teiler 67.2 (19.) 83.8 (14.) 93.2 (17.)
 Trefferlage 0.08 mm rechts, 0.62 mm hoch
 Streuwert 1.22, horizontal: 1.39, vertikal: 1.02

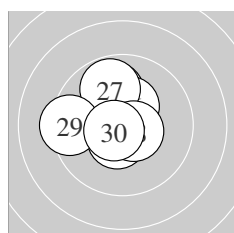

Serie 3:
 9.9 † 10.6 * 10.7 * 10.6 * 10.5 *
 10.4 * 9.8 † 10.6 * 9.4 † 10.6 *
 beste Teiler 53.7 (23.) 76.0 (30.) 76.3 (24.)
 Trefferlage 0.58 mm links, 0.38 mm hoch
 Streuwert 1.32, horizontal: 1.31, vertikal: 1.32

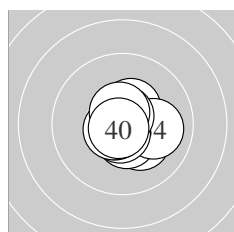

Serie 4:
 10.4 * 10.2 * 10.5 * 10.0 † 10.7 *
 10.7 * 10.7 * 10.6 * 10.6 * 10.8 *
 beste Teiler 43.1 (40.) 61.5 (37.) 67.0 (36.)
 Trefferlage 0.26 mm rechts, 0.17 mm tief
 Streuwert 0.86, horizontal: 0.92, vertikal: 0.79

QF – Schütze hat sich fürs Finale qualifiziert

Unterschrift des Schützen

Meyton Elektronik

Ergebnis:	402.5	(383)
Serien:	97.5	102.5 102.0 100.5
Zähler:	26	12 1 1 0 0 0 0 0 0
Innenzehner:	21	
weiteste:	787	(6), 536 (40), 497 (5)
beste Teiler	13.6	(15.) 46.9 (33.) 56.0 (18.)
Trefferlage	0.47 mm	rechts, 0.68 mm hoch
Streuwert	1.81,	horizontal: 1.98, vertikal: 1.63

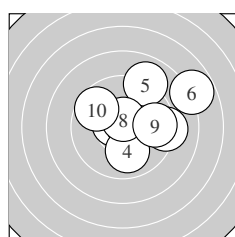
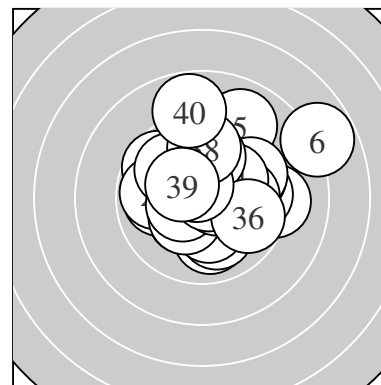

Serie 1:	10.6 *	10.3 *	10.7 *	10.0 ↓	9.0 ↗
	7.8 ↘	9.2 →	10.6 *	9.6 →	9.7 ↖
beste Teiler	59.4	(3.) 80.3	(8.) 92.0	(1.)	
Trefferlage	1.62 mm	rechts, 0.91 mm	hoch		
Streuwert	2.39,	horizontal: 2.78,	vertikal: 1.93		

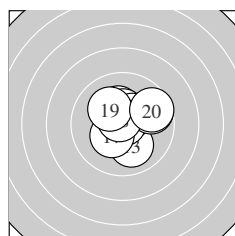

Serie 2:	10.3 *	10.4 *	10.0 ↓	10.4 *	10.9 *
	9.7 ↘	10.3 *	10.7 *	10.2 *	9.6 →
beste Teiler	13.6	(15.) 56.0	(18.) 131.6	(14.)	
Trefferlage	0.47 mm	rechts, 0.53 mm	hoch		
Streuwert	1.38,	horizontal: 1.48,	vertikal: 1.27		

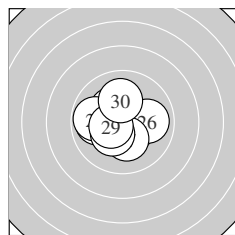

Serie 3:	10.4 *	9.9 ←	10.3 *	10.5 *	9.8 ←
	10.0 →	10.2 *	10.3 *	10.5 *	10.1 ↑
beste Teiler	123.2	(24.) 124.9	(29.) 128.8	(21.)	
Trefferlage	0.43 mm	links, 0.13 mm	tief		
Streuwert	1.42,	horizontal: 1.62,	vertikal: 1.19		

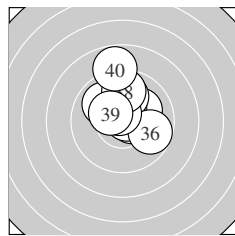

Serie 4:	10.6 *	9.9 ↖	10.8 *	10.1 ↗	9.9 ↑
	9.7 ↘	10.6 *	9.7 ↑	10.4 *	8.8 ↑
beste Teiler	46.9	(33.) 84.6	(37.) 94.1	(31.)	
Trefferlage	0.22 mm	rechts, 1.43 mm	hoch		
Streuwert	1.62,	horizontal: 1.39,	vertikal: 1.82		

Unterschrift des Schützen

Meyton Elektronik

Ergebnis: **403.9** (386)
 Serien: 99.4 101.1 101.0 102.4
 Zähler: 26 14 0 0 0 0 0 0 0 0
 Innenzehner: 19
 weiteste: 395 (9), 370 (28), 369 (11)
 beste Teiler 25.0 (10.) 30.0 (34.) 70.2 (16.)
 Trefferlage 0.20 mm links, 0.10 mm tief
 Streuwert 1.70, horizontal: 1.80, vertikal: 1.58

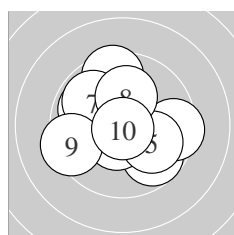
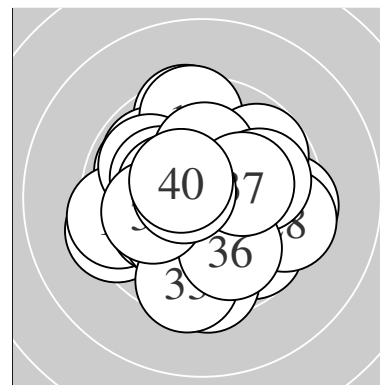

Serie 1:
 9.7 ↘ 10.5 * 9.9 ↖ 9.5 → 10.0 ↘
 9.5 ↑ 9.9 ↗ 10.1 ↑ 9.4 ← 10.9 *
 beste Teiler 25.0 (10.) 109.3 (2.) 206.6 (8.)
 Trefferlage 0.11 mm links, 0.20 mm hoch
 Streuwert 2.07, horizontal: 2.29, vertikal: 1.81

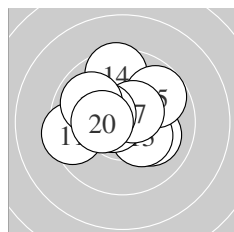

Serie 2:
 9.5 ← 10.1 ↘ 10.3 * 9.5 ↑ 9.8 ↗
 10.7 * 10.5 * 10.4 * 9.9 ↖ 10.4 *
 beste Teiler 70.2 (16.) 106.7 (17.) 140.5 (18.)
 Trefferlage 0.32 mm links, 0.54 mm hoch
 Streuwert 1.69, horizontal: 1.94, vertikal: 1.41

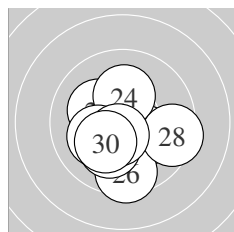

Serie 3:
 10.3 * 10.2 * 10.3 * 10.2 * 10.1 ↖
 9.5 ↓ 10.1 ↙ 9.5 → 10.6 * 10.2 *
 beste Teiler 98.6 (29.) 160.3 (21.) 172.7 (23.)
 Trefferlage 0.19 mm links, 0.88 mm tief
 Streuwert 1.57, horizontal: 1.67, vertikal: 1.46

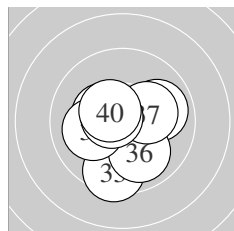

Serie 4:
 9.9 → 10.4 * 9.5 ↓ 10.8 * 10.4 *
 10.0 ↘ 10.2 * 10.1 ← 10.6 * 10.5 *
 beste Teiler 30.0 (34.) 82.8 (39.) 117.2 (40.)
 Trefferlage 0.19 mm links, 0.27 mm tief
 Streuwert 1.49, horizontal: 1.51, vertikal: 1.47

Unterschrift des Schützen

Meyton Elektronik

Ergebnis: **417.3** (399)^{QF}
 Serien: 103.9 105.1 104.7 103.6
 Zähler: 39 1 0 0 0 0 0 0 0 0
 Innenzehner: 34
 weiteste: 266 (6), 244 (8), 236 (23)
 beste Teiler 19.6 (25.) 42.7 (14.) 50.9 (20.)
 Trefferlage 0.10 mm links, 0.24 mm hoch
 Streuwert 1.02, horizontal: 1.08, vertikal: 0.96

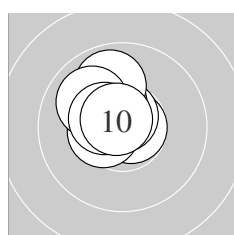
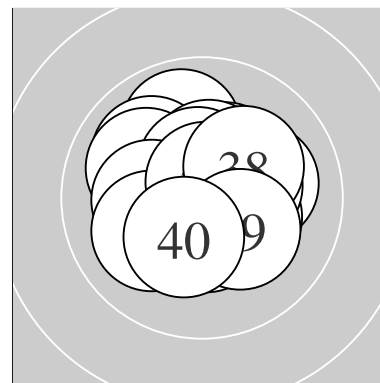

Serie 1:
 10.7 * 10.1 ↖ 10.7 * 10.3 * 10.5 *
 9.9 ↗ 10.5 * 10.0 ↖ 10.5 * 10.7 *
 beste Teiler 52.0 (1.) 62.6 (10.) 69.0 (3.)
 Trefferlage 0.79 mm links, 0.90 mm hoch
 Streuwert 0.78, horizontal: 0.72, vertikal: 0.84

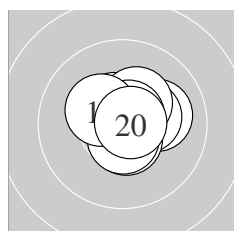

Serie 2:
 10.1 → 10.5 * 10.4 * 10.8 * 10.3 *
 10.7 * 10.6 * 10.6 * 10.3 * 10.8 *
 beste Teiler 42.7 (14.) 50.9 (20.) 61.4 (16.)
 Trefferlage 0.34 mm rechts, 0.33 mm hoch
 Streuwert 0.86, horizontal: 0.97, vertikal: 0.73

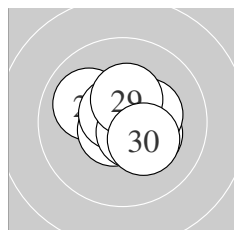

Serie 3:
 10.5 * 10.3 * 10.0 ↖ 10.7 * 10.9 *
 10.7 * 10.6 * 10.3 * 10.4 * 10.3 *
 beste Teiler 19.6 (25.) 71.4 (26.) 74.4 (24.)
 Trefferlage 0.28 mm rechts, 0.14 mm hoch
 Streuwert 0.99, horizontal: 1.11, vertikal: 0.84

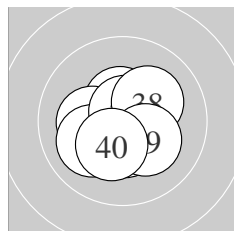

Serie 4:
 10.5 * 10.7 * 10.3 * 10.4 * 10.2 *
 10.1 ↙ 10.7 * 10.2 * 10.2 * 10.3 *
 beste Teiler 60.6 (37.) 64.9 (32.) 115.1 (31.)
 Trefferlage 0.25 mm links, 0.40 mm tief
 Streuwert 1.12, horizontal: 1.20, vertikal: 1.03

QF – Schütze hat sich fürs Finale qualifiziert

Unterschrift des Schützen

Meyton Elektronik