

Ergebnis:	<b>403.3</b>	(385)
Serien:	101.3	101.2 99.5 101.3
Zaehler:	25	15 0 0 0 0 0 0 0 0
Innenzehner:	19	
weiteste:	450	(22), 446 (33), 441 (5)
beste Teiler	30.2	(26.) 62.3 (20.) 67.5 (8.)
Trefferlage	1.03	mm links, 0.38 mm hoch
Streuwert	1.57,	horizontal: 1.53, vertikal: 1.62

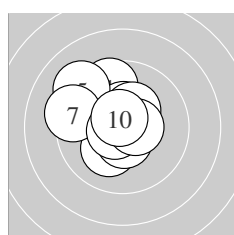

Serie 1:	9.6 ↗	10.2 *	10.5 *	10.4 *	9.2 ↘
	10.3 *	9.3 ↖	10.7 *	10.5 *	10.6 *
beste Teiler	67.5	(8.) 77.1 (10.)	101.7 (3.)		
Trefferlage	0.81	mm links, 0.77 mm hoch			
Streuwert	1.60,	horizontal: 1.62, vertikal: 1.58			

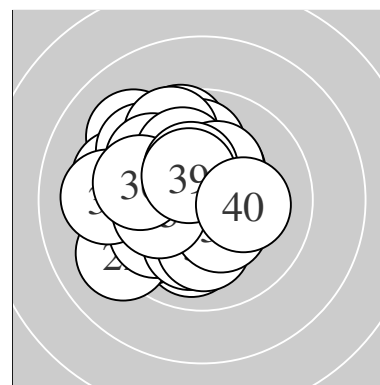
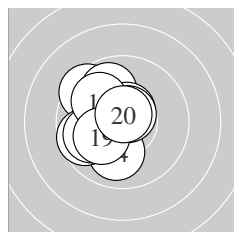

Serie 2:	9.5 ↘	9.9 ↗	10.6 *	10.0 ↓	9.7 ↖
	9.9 ↖	10.7 *	10.0 ↘	10.2 *	10.7 *
beste Teiler	62.3	(20.) 75.1 (17.)	96.2 (13.)		
Trefferlage	1.24	mm links, 0.30 mm hoch			
Streuwert	1.47,	horizontal: 1.29, vertikal: 1.63			

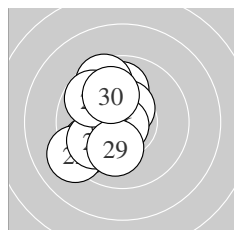

Serie 3:	9.7 ↖	9.2 ↖	9.9 ↑	10.5 *	9.9 ↖
	10.8 *	9.6 ↘	9.8 ↘	10.1 ↓	10.0 ↗
beste Teiler	30.2	(26.) 112.3 (24.)	210.1 (29.)		
Trefferlage	1.38	mm links, 0.27 mm hoch			
Streuwert	1.76,	horizontal: 1.30, vertikal: 2.12			

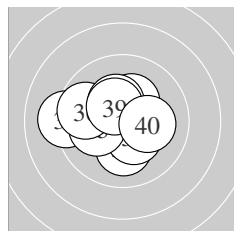

Serie 4:	10.1 ↓	10.6 *	9.2 ↖	10.4 *	10.1 ↖
	9.7 ↖	10.3 *	10.3 *	10.4 *	10.2 *
beste Teiler	93.0	(32.) 130.6 (39.)	148.6 (34.)		
Trefferlage	0.67	mm links, 0.19 mm hoch			
Streuwert	1.61,	horizontal: 1.94, vertikal: 1.20			

Unterschrift des Schuetzen

Meyton Elektronik

Ergebnis: **416.0** (395)  
 Serien: 104.3 102.7 105.2 103.8  
 Zaehler: 35 5 0 0 0 0 0 0 0 0  
 Innenzehner: 32  
 weiteste: 366 (19), 282 (31), 274 (38)  
 beste Teiler 12.5 (28.) 40.5 (3.) 41.1 (9.)  
 Trefferlage 0.07 mm rechts, 0.13 mm hoch  
 Streuwert 1.13, horizontal: 1.32, vertikal: 0.90

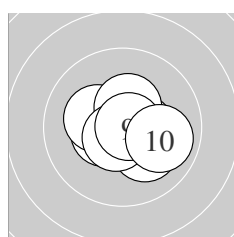
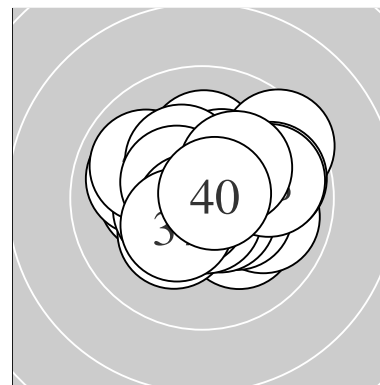

Serie 1:  
 10.5 \* 10.5 \* 10.8 \* 10.5 \* 10.1 ↘  
 10.2 \* 10.4 \* 10.6 \* 10.8 \* 9.9 ↘  
 beste Teiler 40.5 (3.) 41.1 (9.) 80.9 (8.)  
 Trefferlage 0.33 mm rechts, 0.14 mm tief  
 Streuwert 1.05, horizontal: 1.28, vertikal: 0.74

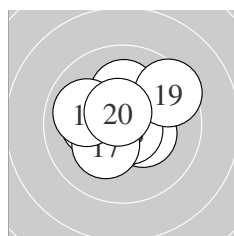

Serie 2:  
 10.4 \* 10.2 \* 10.5 \* 10.5 \* 10.1 ↑  
 10.7 \* 10.2 \* 10.0 ← 9.5 ↗ 10.6 \*  
 beste Teiler 59.3 (16.) 84.8 (20.) 107.1 (13.)  
 Trefferlage 0.25 mm links, 0.23 mm hoch  
 Streuwert 1.39, horizontal: 1.59, vertikal: 1.17

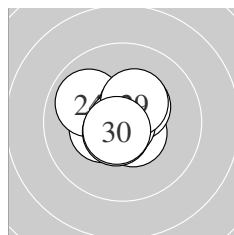

Serie 3:  
 10.6 \* 10.8 \* 10.4 \* 9.9 ↖ 10.6 \*  
 10.5 \* 10.4 \* 10.9 \* 10.4 \* 10.7 \*  
 beste Teiler 12.5 (28.) 47.0 (22.) 67.4 (30.)  
 Trefferlage 0.16 mm links, 0.17 mm hoch  
 Streuwert 0.94, horizontal: 1.01, vertikal: 0.86

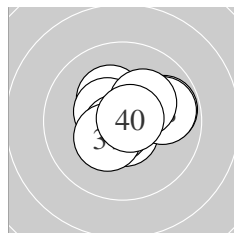

Serie 4:  
 9.8 → 10.3 \* 10.6 \* 10.7 \* 10.5 \*  
 10.7 \* 10.4 \* 9.9 → 10.2 \* 10.7 \*  
 beste Teiler 51.0 (34.) 53.1 (40.) 64.5 (36.)  
 Trefferlage 0.35 mm rechts, 0.26 mm hoch  
 Streuwert 1.17, horizontal: 1.43, vertikal: 0.85

Unterschrift des Schuetzen

**ISSF AR Women – Probe – Frauen**

**StartNr: 80**

StandNr: 106

23. Januar 2017 14:29

**Auer, Katharina** #70804311

T – SG Roppen

Ergebnis: **0.0** (0)<sub>DNS</sub>  
Serien:  
Zähler: 0 0 0 0 0 0 0 0 0 0  
Innenzehner: 0  
weiteste:  
~~beste~~ Teiler – Schütze ist nicht zum Wettkampf angetreten  
Trefferlage 0.00 mm , 0.00 mm  
Streuwert  
Unterschrift des Schuetzen

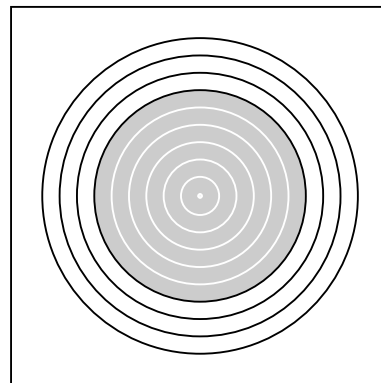

Meyton Elektronik

Ergebnis: **414.6** (393)  
 Serien: 104.7 103.9 104.0 102.0  
 Zaehler: 33 7 0 0 0 0 0 0 0 0  
 Innenzehner: 32  
 weiteste: 337 (32), 324 (22), 307 (36)  
 beste Teiler 3.0 (7.) 21.0 (21.) 26.2 (31.)  
 Trefferlage 0.07 mm links, 0.12 mm hoch  
 Streuwert 1.22, horizontal: 1.20, vertikal: 1.24

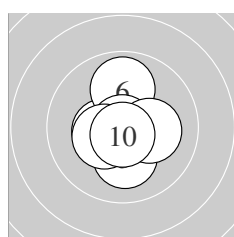
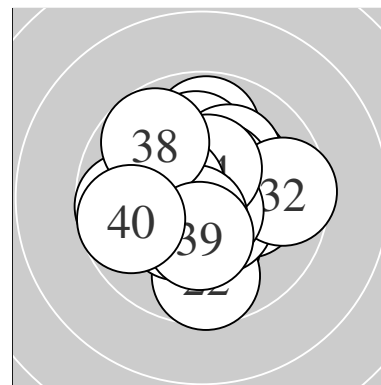

Serie 1:  
 10.5 \*                      10.7 \*                      10.2 \*                      10.8 \*                      10.4 \*  
 9.9 ↑                      10.9 \*                      10.2 \*                      10.4 \*                      10.7 \*  
 beste Teiler 3.0 (7.) 37.0 (4.) 52.0 (10.)  
 Trefferlage 0.18 mm rechts, 0.11 mm tief  
 Streuwert 1.06, horizontal: 0.98, vertikal: 1.13

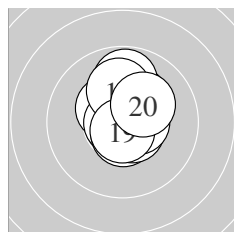

Serie 2:  
 10.4 \*                      10.8 \*                      10.2 \*                      9.8 ↑                      10.6 \*  
 10.6 \*                      10.5 \*                      10.1 ↑                      10.7 \*                      10.2 \*  
 beste Teiler 45.1 (12.) 58.0 (19.) 84.1 (15.)  
 Trefferlage 0.25 mm rechts, 0.67 mm hoch  
 Streuwert 1.04, horizontal: 0.75, vertikal: 1.27

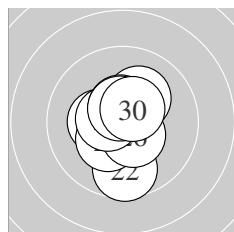

Serie 3:  
 10.9 \*                      9.7 ↓                      10.3 \*                      10.2 \*                      10.3 \*  
 10.5 \*                      10.5 \*                      10.5 \*                      10.6 \*                      10.5 \*  
 beste Teiler 21.0 (21.) 95.7 (29.) 103.0 (28.)  
 Trefferlage 0.14 mm links, 0.05 mm tief  
 Streuwert 1.18, horizontal: 0.86, vertikal: 1.42

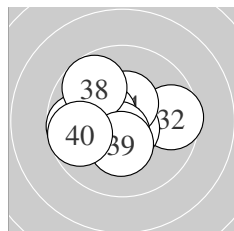

Serie 4:  
 10.8 \*                      9.6 →                      10.7 \*                      10.5 \*                      10.4 \*  
 9.7 ←                      10.6 \*                      9.7 ↘                      10.3 \*                      9.7 ←  
 beste Teiler 26.2 (31.) 60.5 (33.) 93.7 (37.)  
 Trefferlage 0.60 mm links, 0.00 mm  
 Streuwert 1.54, horizontal: 1.87, vertikal: 1.13

Unterschrift des Schuetzen

Ergebnis: **413.8** (398)  
 Serien: 103.4 102.9 103.3 104.2  
 Zaehler: 38 2 0 0 0 0 0 0 0 0  
 Innenzehner: 30  
 weiteste: 321 (13), 268 (9), 247 (15)  
 beste Teiler 37.1 (37.) 45.2 (40.) 52.1 (10.)  
 Trefferlage 0.17 mm rechts, 0.08 mm hoch  
 Streuwert 1.19, horizontal: 1.10, vertikal: 1.27

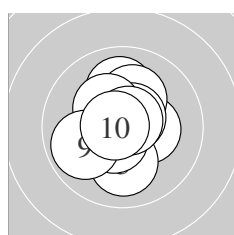
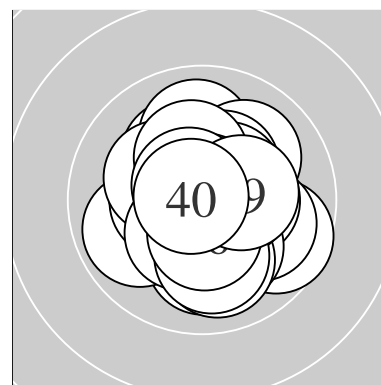

Serie 1:  
 10.0 ↑                      10.3 \*                      10.1 ↓                      10.6 \*                      10.2 \*  
 10.6 \*                      10.3 \*                      10.7 \*                      9.9 ←                      10.7 \*  
 beste Teiler 52.1 (10.) 55.9 (8.) 85.7 (6.)  
 Trefferlage 0.15 mm links, 0.23 mm hoch  
 Streuwert 1.25, horizontal: 1.08, vertikal: 1.39

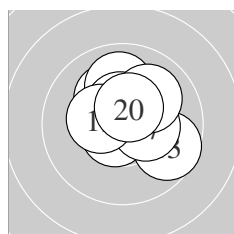

Serie 2:  
 10.2 \*                      10.6 \*                      9.7 ↘                      10.7 \*                      10.0 ↑  
 10.5 \*                      10.3 \*                      10.0 ↗                      10.4 \*                      10.5 \*  
 beste Teiler 72.1 (14.) 92.7 (12.) 116.4 (20.)  
 Trefferlage 0.27 mm rechts, 0.71 mm hoch  
 Streuwert 1.26, horizontal: 1.34, vertikal: 1.17

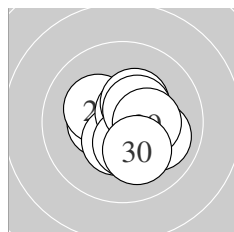

Serie 3:  
 10.4 \*                      10.2 \*                      10.4 \*                      10.6 \*                      10.0 →  
 10.4 \*                      10.4 \*                      10.5 \*                      10.3 \*                      10.1 ↓  
 beste Teiler 77.4 (24.) 124.8 (28.) 128.4 (23.)  
 Trefferlage 0.38 mm rechts, 0.18 mm tief  
 Streuwert 1.15, horizontal: 1.22, vertikal: 1.08

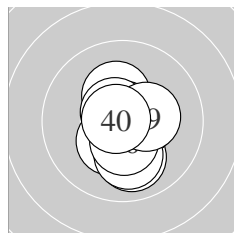

Serie 4:  
 10.0 ↓                      10.4 \*                      10.3 \*                      10.5 \*                      10.1 ↓  
 10.4 \*                      10.8 \*                      10.6 \*                      10.3 \*                      10.8 \*  
 beste Teiler 37.1 (37.) 45.2 (40.) 77.2 (38.)  
 Trefferlage 0.18 mm rechts, 0.40 mm tief  
 Streuwert 1.07, horizontal: 0.77, vertikal: 1.30

Unterschrift des Schuetzen

Meyton Elektronik

Ergebnis: **418.7** (400)<sup>QF</sup>  
 Serien: 103.9 104.4 105.1 105.3  
 Zaehler: 40 0 0 0 0 0 0 0 0 0  
 Innenzehner: 34  
 weiteste: 237 (34), 226 (1), 225 (10)  
 beste Teiler 25.0 (32.) 33.5 (14.) 51.0 (9.)  
 Trefferlage 0.19 mm links, 0.10 mm tief  
 Streuwert 0.95, horizontal: 0.96, vertikal: 0.95

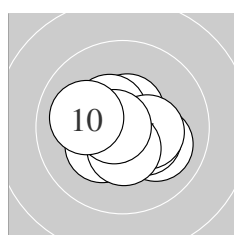
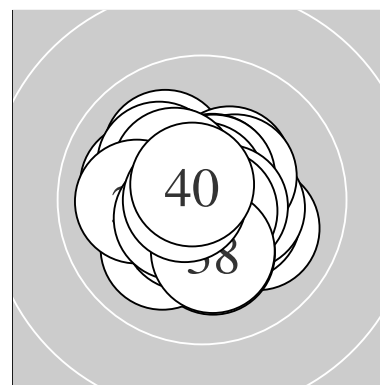

Serie 1:  
 10.0 ↘ 10.7 \* 10.4 \* 10.3 \* 10.5 \*  
 10.5 \* 10.3 \* 10.4 \* 10.7 \* 10.1 ←  
 beste Teiler 51.0 (9.) 74.6 (2.) 101.9 (5.)  
 Trefferlage 0.03 mm rechts, 0.11 mm tief  
 Streuwert 1.12, horizontal: 1.30, vertikal: 0.89

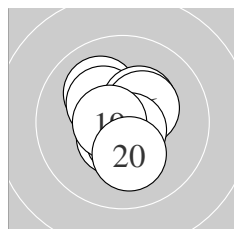

Serie 2:  
 10.1 ↖ 10.3 \* 10.3 \* 10.8 \* 10.5 \*  
 10.4 \* 10.5 \* 10.7 \* 10.6 \* 10.2 \*  
 beste Teiler 33.5 (14.) 62.3 (18.) 79.0 (19.)  
 Trefferlage 0.09 mm links, 0.02 mm hoch  
 Streuwert 1.03, horizontal: 0.87, vertikal: 1.17

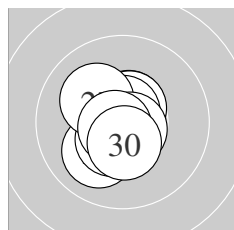

Serie 3:  
 10.1 ↗ 10.6 \* 10.5 \* 10.6 \* 10.7 \*  
 10.7 \* 10.1 ↖ 10.7 \* 10.7 \* 10.4 \*  
 beste Teiler 57.4 (29.) 58.0 (25.) 62.2 (28.)  
 Trefferlage 0.27 mm links, 0.18 mm tief  
 Streuwert 0.90, horizontal: 0.74, vertikal: 1.03

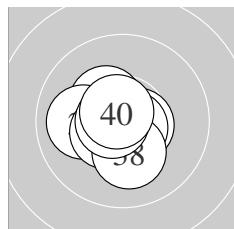

Serie 4:  
 10.6 \* 10.9 \* 10.4 \* 10.0 ← 10.6 \*  
 10.5 \* 10.7 \* 10.2 \* 10.7 \* 10.7 \*  
 beste Teiler 25.0 (32.) 63.0 (39.) 63.2 (37.)  
 Trefferlage 0.43 mm links, 0.14 mm tief  
 Streuwert 0.86, horizontal: 0.93, vertikal: 0.79

QF – Schütze hat sich fürs Finale qualifiziert

Unterschrift des Schuetzen

Meyton Elektronik

Ergebnis: **415.2** (398)  
 Serien: 102.8 104.7 104.6 103.1  
 Zaehler: 38 2 0 0 0 0 0 0 0 0  
 Innenzehner: 32  
 weiteste: 373 (4), 297 (37), 244 (38)  
 beste Teiler 17.6 (27.) 31.1 (12.) 40.7 (18.)  
 Trefferlage 0.14 mm rechts, 0.31 mm hoch  
 Streuwert 1.13, horizontal: 1.34, vertikal: 0.88

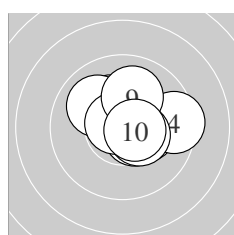
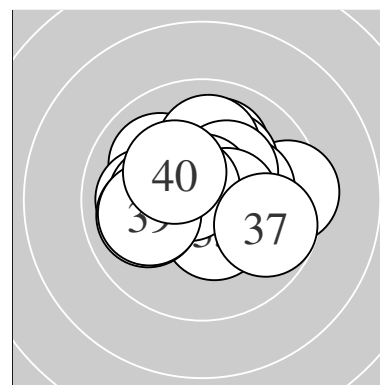

Serie 1:  
 10.3 \*                      10.5 \*                      10.2 \*                      9.5 →                      10.6 \*  
 10.0 ↘                      10.4 \*                      10.7 \*                      10.0 ↑                      10.6 \*  
 beste Teiler 57.8 (8.) 88.7 (5.) 91.6 (10.)  
 Trefferlage 0.52 mm rechts, 0.49 mm hoch  
 Streuwert 1.30, horizontal: 1.56, vertikal: 0.97

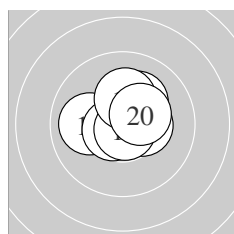

Serie 2:  
 10.7 \*                      10.8 \*                      10.6 \*                      10.0 ←                      10.6 \*  
 10.4 \*                      10.2 \*                      10.8 \*                      10.2 \*                      10.4 \*  
 beste Teiler 31.1 (12.) 40.7 (18.) 65.0 (11.)  
 Trefferlage 0.12 mm rechts, 0.28 mm hoch  
 Streuwert 1.00, horizontal: 1.15, vertikal: 0.82

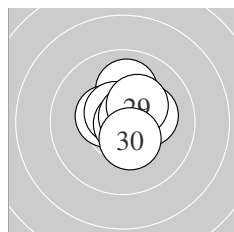

Serie 3:  
 10.0 ↑                      10.8 \*                      10.3 \*                      10.4 \*                      10.6 \*  
 10.2 \*                      10.9 \*                      10.7 \*                      10.3 \*                      10.4 \*  
 beste Teiler 17.6 (27.) 42.4 (22.) 63.4 (28.)  
 Trefferlage 0.40 mm rechts, 0.55 mm hoch  
 Streuwert 0.88, horizontal: 0.85, vertikal: 0.91

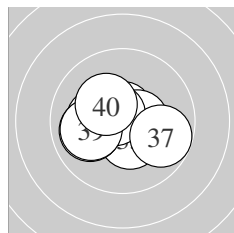

Serie 4:  
 10.5 \*                      10.7 \*                      10.2 \*                      10.5 \*                      10.4 \*  
 10.7 \*                      9.8 →                      10.0 ←                      10.0 ←                      10.3 \*  
 beste Teiler 62.0 (32.) 74.8 (36.) 107.0 (34.)  
 Trefferlage 0.49 mm links, 0.05 mm tief  
 Streuwert 1.28, horizontal: 1.62, vertikal: 0.82

Unterschrift des Schuetzen

Meyton Elektronik

Ergebnis: **411.2** (391)  
 Serien: 102.5 102.2 103.0 103.5  
 Zaehler: 31 9 0 0 0 0 0 0 0 0  
 Innenzehner: 28  
 weiteste: 346 (33), 327 (20), 306 (2)  
 beste Teiler 31.9 (39.) 70.2 (36.) 70.4 (3.)  
 Trefferlage 0.33 mm rechts, 0.22 mm tief  
 Streuwert 1.30, horizontal: 1.36, vertikal: 1.24

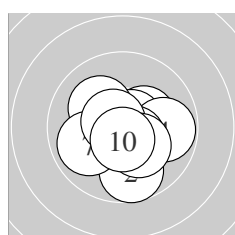
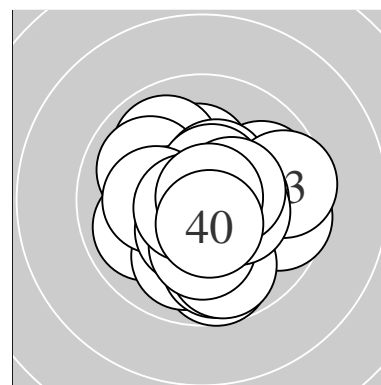

Serie 1:  
 10.3 \*                      9.7 ↓                      10.7 \*                      9.8 →                      10.1 ↖  
 10.5 \*                      9.9 ↙                      10.6 \*                      10.3 \*                      10.6 \*  
 beste Teiler 70.4 (3.) 77.1 (8.) 86.0 (10.)  
 Trefferlage 0.28 mm rechts, 0.44 mm tief  
 Streuwert 1.37, horizontal: 1.50, vertikal: 1.24

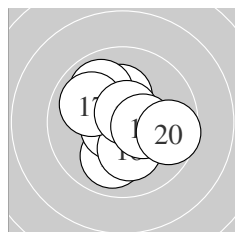

Serie 2:  
 10.6 \*                      10.2 \*                      10.0 ↓                      9.9 ↖                      10.6 \*  
 10.2 \*                      10.0 ↖                      10.7 \*                      10.4 \*                      9.6 →  
 beste Teiler 70.7 (18.) 78.2 (15.) 84.8 (11.)  
 Trefferlage 0.00 mm , 0.10 mm hoch  
 Streuwert 1.50, horizontal: 1.51, vertikal: 1.48

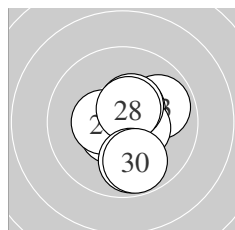

Serie 3:  
 10.6 \*                      10.4 \*                      9.9 ↗                      10.5 \*                      10.5 \*  
 10.4 \*                      10.4 \*                      10.6 \*                      9.9 ↓                      9.8 ↓  
 beste Teiler 100.0 (21.) 100.7 (28.) 115.2 (24.)  
 Trefferlage 0.58 mm rechts, 0.17 mm tief  
 Streuwert 1.27, horizontal: 1.04, vertikal: 1.46

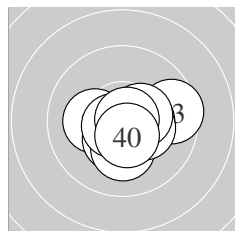

Serie 4:  
 10.2 \*                      10.4 \*                      9.6 →                      10.4 \*                      10.2 \*  
 10.7 \*                      10.3 \*                      10.4 \*                      10.8 \*                      10.5 \*  
 beste Teiler 31.9 (39.) 70.2 (36.) 104.6 (40.)  
 Trefferlage 0.49 mm rechts, 0.38 mm tief  
 Streuwert 1.18, horizontal: 1.46, vertikal: 0.80

Unterschrift des Schuetzen

Meyton Elektronik



Ergebnis: **407.8** (387)  
 Serien: 101.7 102.0 100.1 104.0  
 Zaehler: 28 11 1 0 0 0 0 0 0 0  
 Innenzehner: 24  
 weiteste: 560 (29), 405 (10), 365 (34)  
 beste Teiler 30.4 (27.) 39.6 (6.) 41.0 (16.)  
 Trefferlage 0.06 mm rechts, 0.21 mm tief  
 Streuwert 1.58, horizontal: 1.88, vertikal: 1.20

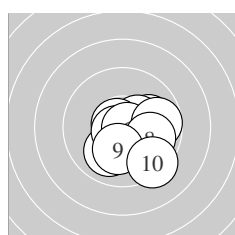
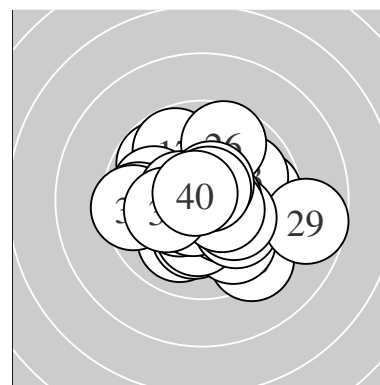

Serie 1:  
 10.0 → 10.4 \* 10.7 \* 10.0 ✓ 10.7 \*  
 10.8 \* 9.7 → 9.9 → 10.2 \* 9.3 ↘  
 beste Teiler 39.6 (6.) 59.0 (3.) 62.6 (5.)  
 Trefferlage 0.94 mm rechts, 0.66 mm tief  
 Streuwert 1.44, horizontal: 1.57, vertikal: 1.30

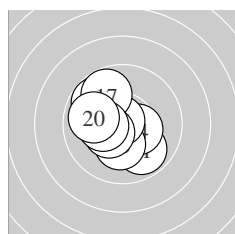

Serie 2:  
 9.9 ↘ 10.5 \* 9.8 ↖ 10.4 \* 10.2 \*  
 10.8 \* 9.8 ↖ 10.4 \* 10.3 \* 9.9 ←  
 beste Teiler 41.0 (16.) 109.1 (12.) 138.2 (14.)  
 Trefferlage 0.72 mm links, 0.09 mm tief  
 Streuwert 1.45, horizontal: 1.40, vertikal: 1.51

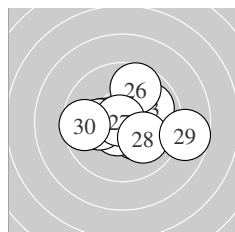

Serie 3:  
 10.3 \* 10.3 \* 9.9 ↗ 10.6 \* 10.1 ←  
 9.7 ↑ 10.8 \* 10.1 ↘ 8.7 → 9.6 ←  
 beste Teiler 30.4 (27.) 85.4 (24.) 157.8 (22.)  
 Trefferlage 0.41 mm rechts, 0.05 mm tief  
 Streuwert 2.01, horizontal: 2.53, vertikal: 1.30

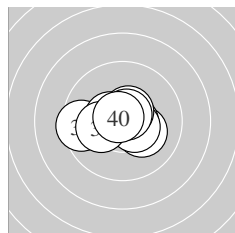

Serie 4:  
 10.2 \* 10.6 \* 10.4 \* 9.5 ← 10.5 \*  
 10.5 \* 10.2 \* 10.6 \* 10.7 \* 10.8 \*  
 beste Teiler 50.9 (40.) 66.3 (39.) 92.1 (32.)  
 Trefferlage 0.38 mm links, 0.03 mm tief  
 Streuwert 1.21, horizontal: 1.62, vertikal: 0.56

Unterschrift des Schuetzen

Meyton Elektronik

Ergebnis:	<b>417.5</b>	(399) <sup>QF</sup>
Serien:	104.4	103.9 105.4 103.8
Zaehler:	39	1 0 0 0 0 0 0 0 0
Innenzehner:	36	
weiteste:	252	(2), 217 (12), 216 (3)
beste Teiler	39.4	(22.) 45.7 (25.) 50.0 (8.)
Trefferlage	0.06 mm	rechts, 0.37 mm hoch
Streuwert	0.97,	horizontal: 1.05, vertikal: 0.89

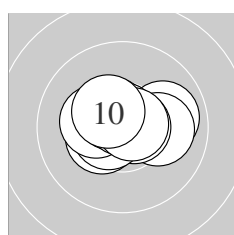
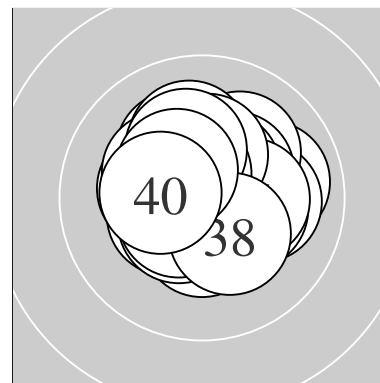

Serie 1:				
	10.4 *	9.9 →	10.1 →	10.7 *
	10.3 *	10.5 *	10.8 *	10.6 *
beste Teiler	50.0	(8.) 59.7 (9.)	71.0 (4.)	
Trefferlage	0.06 mm	rechts, 0.23 mm	hoch	
Streuwert	1.05,	horizontal: 1.40,	vertikal: 0.51	

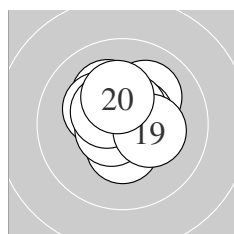

Serie 2:				
	10.2 *	10.1 ↗	10.4 *	10.6 *
	10.6 *	10.6 *	10.5 *	10.3 *
beste Teiler	76.0	(16.) 95.7 (17.)	100.7 (14.)	
Trefferlage	0.00 mm	, 0.59 mm	hoch	
Streuwert	1.05,	horizontal: 1.06,	vertikal: 1.03	

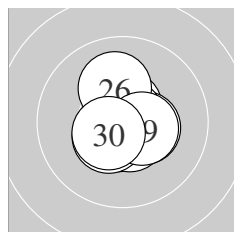

Serie 3:				
	10.6 *	10.8 *	10.6 *	10.4 *
	10.1 ↑	10.6 *	10.5 *	10.5 *
beste Teiler	39.4	(22.) 45.7 (25.)	82.2 (23.)	
Trefferlage	0.11 mm	rechts, 0.02 mm	tief	
Streuwert	0.86,	horizontal: 0.75,	vertikal: 0.95	

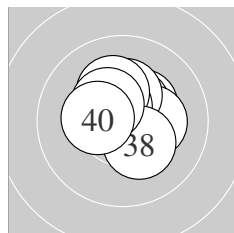

Serie 4:				
	10.4 *	10.5 *	10.5 *	10.3 *
	10.6 *	10.2 *	10.3 *	10.3 *
beste Teiler	98.8	(36.) 117.3 (32.)	124.3 (33.)	
Trefferlage	0.06 mm	rechts, 0.71 mm	hoch	
Streuwert	0.97,	horizontal: 1.04,	vertikal: 0.90	

QF – Schütze hat sich fürs Finale qualifiziert

Unterschrift des Schuetzen

Meyton Elektronik

Ergebnis: **414.5** (398)  
 Serien: 104.5 103.6 103.3 103.1  
 Zaehler: 38 2 0 0 0 0 0 0 0 0  
 Innenzehner: 29  
 weiteste: 330 (34), 280 (27), 248 (1)  
 beste Teiler 10.0 (9.) 48.5 (7.) 54.5 (20.)  
 Trefferlage 0.12 mm links, 0.14 mm tief  
 Streuwert 1.16, horizontal: 1.42, vertikal: 0.81

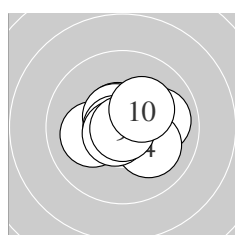
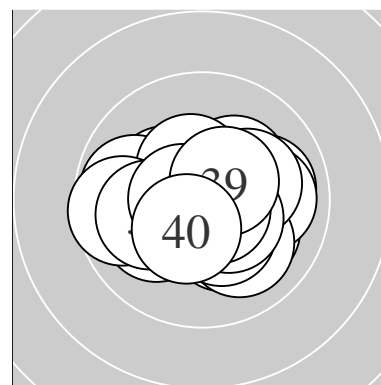

Serie 1:  
 10.0 →                      10.1 ←                      10.5 \*                      10.1 ↘                      10.6 \*  
 10.6 \*                      10.8 \*                      10.7 \*                      10.9 \*                      10.2 \*  
 beste Teiler 10.0 (9.) 48.5 (7.) 66.8 (8.)  
 Trefferlage 0.26 mm rechts, 0.04 mm hoch  
 Streuwert 1.09, horizontal: 1.34, vertikal: 0.74

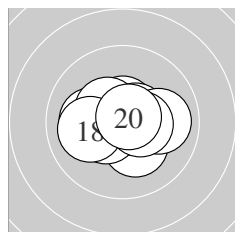

Serie 2:  
 10.6 \*                      10.1 ←                      10.4 \*                      10.3 \*                      10.6 \*  
 10.0 →                      10.4 \*                      10.0 ←                      10.5 \*                      10.7 \*  
 beste Teiler 54.5 (20.) 91.0 (11.) 97.9 (15.)  
 Trefferlage 0.06 mm links, 0.00 mm  
 Streuwert 1.19, horizontal: 1.52, vertikal: 0.73

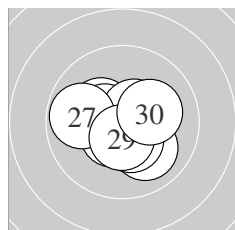

Serie 3:  
 10.0 ↘                      10.3 \*                      10.4 \*                      10.5 \*                      10.7 \*  
 10.5 \*                      9.8 ←                      10.4 \*                      10.5 \*                      10.2 \*  
 beste Teiler 75.0 (25.) 105.5 (26.) 106.1 (29.)  
 Trefferlage 0.14 mm links, 0.26 mm tief  
 Streuwert 1.21, horizontal: 1.43, vertikal: 0.95

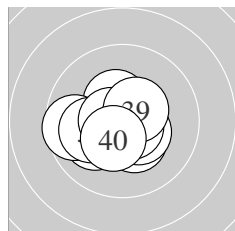

Serie 4:  
 10.1 ←                      10.3 \*                      10.4 \*                      9.6 ←                      10.1 ←  
 10.4 \*                      10.6 \*                      10.7 \*                      10.5 \*                      10.4 \*  
 beste Teiler 68.5 (38.) 79.1 (37.) 118.5 (39.)  
 Trefferlage 0.57 mm links, 0.37 mm tief  
 Streuwert 1.20, horizontal: 1.48, vertikal: 0.85

Unterschrift des Schuetzen

Meyton Elektronik

Ergebnis: **411.8** (390)  
 Serien: 101.5 104.4 104.0 101.9  
 Zaehler: 30 10 0 0 0 0 0 0 0 0  
 Innenzehner: 25  
 weiteste: 336 (6), 303 (9), 299 (29)  
 beste Teiler 21.9 (13.) 31.0 (21.) 32.2 (18.)  
 Trefferlage 0.16 mm links, 0.08 mm hoch  
 Streuwert 1.35, horizontal: 1.55, vertikal: 1.12

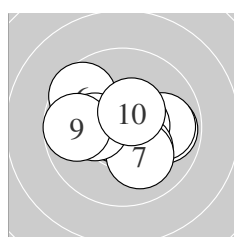
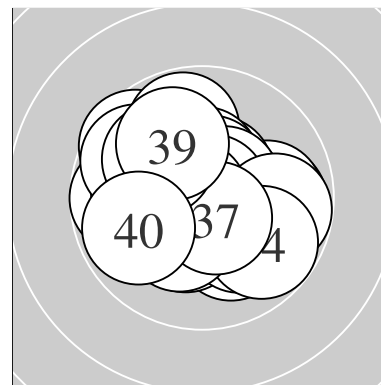

Serie 1:  
 9.9 → 9.9 → 10.8 \* 10.6 \* 10.2 \*  
 9.6 ↘ 10.1 ↘ 10.2 \* 9.7 ← 10.5 \*  
 beste Teiler 34.0 (3.) 89.5 (4.) 117.8 (10.)  
 Trefferlage 0.12 mm rechts, 0.03 mm tief  
 Streuwert 1.64, horizontal: 2.04, vertikal: 1.09

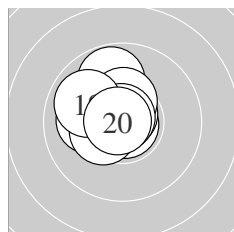

Serie 2:  
 10.6 \* 10.1 ← 10.9 \* 9.8 ↑ 10.7 \*  
 10.4 \* 10.4 \* 10.8 \* 9.9 ↘ 10.8 \*  
 beste Teiler 21.9 (13.) 32.2 (18.) 34.9 (20.)  
 Trefferlage 0.68 mm links, 0.66 mm hoch  
 Streuwert 0.94, horizontal: 0.93, vertikal: 0.96

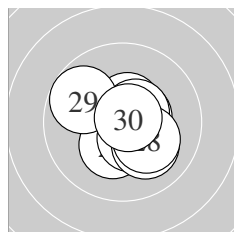

Serie 3:  
 10.8 \* 10.3 \* 10.5 \* 10.5 \* 10.5 \*  
 10.1 ↘ 10.5 \* 10.2 \* 9.8 ↘ 10.8 \*  
 beste Teiler 31.0 (21.) 47.0 (30.) 105.4 (27.)  
 Trefferlage 0.26 mm rechts, 0.15 mm tief  
 Streuwert 1.16, horizontal: 1.23, vertikal: 1.09

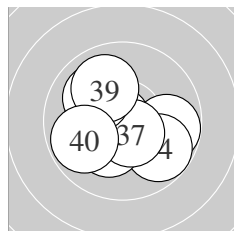

Serie 4:  
 9.8 → 10.3 \* 10.8 \* 9.8 ↘ 10.5 \*  
 10.3 \* 10.6 \* 10.0 ↘ 10.0 ↘ 9.8 ←  
 beste Teiler 41.5 (33.) 96.5 (37.) 125.2 (35.)  
 Trefferlage 0.37 mm links, 0.15 mm tief  
 Streuwert 1.56, horizontal: 1.79, vertikal: 1.27

Unterschrift des Schuetzen

Ergebnis: **416.9** (397)<sup>QF</sup>  
 Serien: 102.3 103.8 104.2 106.6  
 Zaehler: 37 3 0 0 0 0 0 0 0 0  
 Innenzehner: 32  
 weiteste: 378 (7), 350 (15), 325 (10)  
 beste Teiler 10.2 (37.) 11.4 (18.) 19.1 (23.)  
 Trefferlage 0.15 mm rechts, 0.02 mm hoch  
 Streuwert 1.13, horizontal: 1.29, vertikal: 0.94

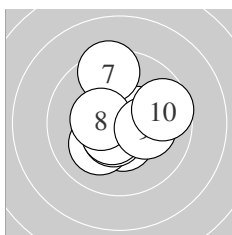
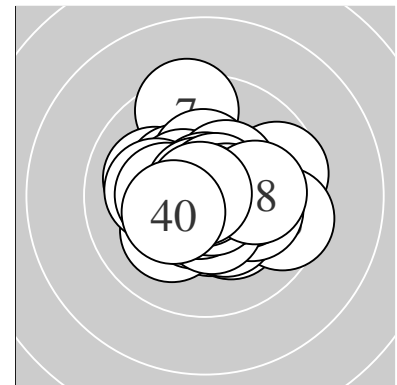

Serie 1:  
 10.5 \* 10.4 \* 10.5 \* 10.1 ✓ 10.5 \*  
 10.6 \* 9.4 ↑ 10.4 \* 10.2 \* 9.7 →  
 beste Teiler 92.4 (6.) 101.0 (5.) 110.0 (1.)  
 Trefferlage 0.14 mm rechts, 0.16 mm hoch  
 Streuwert 1.50, horizontal: 1.48, vertikal: 1.52

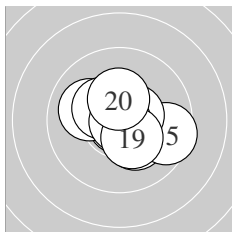

Serie 2:  
 10.9 \* 10.0 ← 10.4 \* 10.2 \* 9.6 →  
 10.7 \* 10.5 \* 10.9 \* 10.3 \* 10.3 \*  
 beste Teiler 11.4 (18.) 21.5 (11.) 58.0 (16.)  
 Trefferlage 0.34 mm rechts, 0.04 mm tief  
 Streuwert 1.24, horizontal: 1.48, vertikal: 0.95

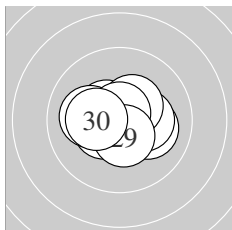

Serie 3:  
 10.4 \* 10.5 \* 10.9 \* 10.1 → 10.3 \*  
 10.4 \* 10.1 ← 10.7 \* 10.5 \* 10.3 \*  
 beste Teiler 19.1 (23.) 51.0 (28.) 115.1 (22.)  
 Trefferlage 0.08 mm links, 0.03 mm hoch  
 Streuwert 1.08, horizontal: 1.39, vertikal: 0.65

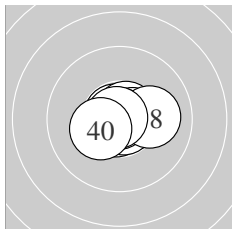

Serie 4:  
 10.8 \* 10.8 \* 10.7 \* 10.7 \* 10.6 \*  
 10.8 \* 10.9 \* 10.1 → 10.9 \* 10.3 \*  
 beste Teiler 10.2 (37.) 24.1 (39.) 36.1 (31.)  
 Trefferlage 0.19 mm rechts, 0.03 mm tief  
 Streuwert 0.70, horizontal: 0.93, vertikal: 0.36

QF – Schütze hat sich fürs Finale qualifiziert

Unterschrift des Schuetzen

Meyton Elektronik

Ergebnis: **415.8** (397)  
 Serien: 104.2 104.0 103.7 103.9  
 Zaehler: 37 3 0 0 0 0 0 0 0 0  
 Innenzehner: 34  
 weiteste: 429 (28), 267 (16), 256 (4)  
 beste Teiler 12.0 (29.) 18.4 (9.) 25.0 (30.)  
 Trefferlage 0.02 mm rechts, 0.06 mm hoch  
 Streuwert 1.14, horizontal: 1.31, vertikal: 0.95

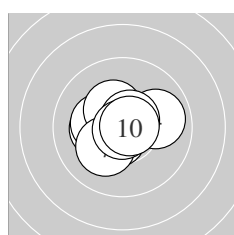
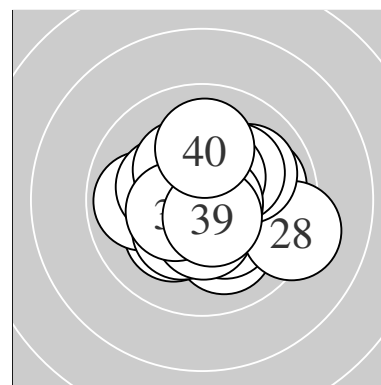

Serie 1:  
 10.4 \*                      10.2 \*                      10.3 \*                      9.9 →                      10.6 \*  
 10.4 \*                      10.2 \*                      10.6 \*                      10.9 \*                      10.7 \*  
 beste Teiler 18.4 (9.) 51.7 (10.) 77.0 (8.)  
 Trefferlage 0.35 mm links, 0.10 mm hoch  
 Streuwert 1.07, horizontal: 1.30, vertikal: 0.79

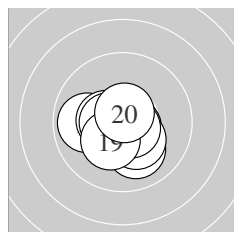

Serie 2:  
 10.1 ↘                      10.6 \*                      10.6 \*                      10.3 \*                      10.6 \*  
 9.9 ←                      10.4 \*                      10.5 \*                      10.3 \*                      10.7 \*  
 beste Teiler 71.3 (20.) 76.4 (15.) 78.3 (12.)  
 Trefferlage 0.29 mm links, 0.56 mm tief  
 Streuwert 1.03, horizontal: 1.20, vertikal: 0.83

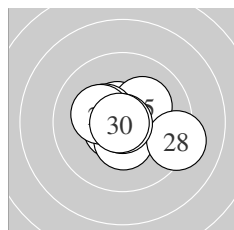

Serie 3:  
 10.6 \*                      10.4 \*                      10.3 \*                      10.6 \*                      10.2 \*  
 10.4 \*                      10.2 \*                      9.2 →                      10.9 \*                      10.9 \*  
 beste Teiler 12.0 (29.) 25.0 (30.) 86.6 (21.)  
 Trefferlage 0.27 mm rechts, 0.05 mm hoch  
 Streuwert 1.35, horizontal: 1.68, vertikal: 0.91

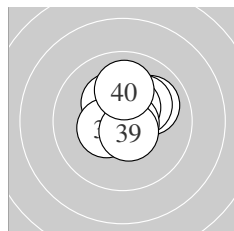

Serie 4:  
 10.7 \*                      10.5 \*                      10.0 ↗                      10.2 \*                      10.5 \*  
 10.7 \*                      10.3 \*                      10.4 \*                      10.6 \*                      10.0 ↑  
 beste Teiler 53.4 (36.) 61.4 (31.) 89.6 (39.)  
 Trefferlage 0.46 mm rechts, 0.64 mm hoch  
 Streuwert 0.97, horizontal: 0.98, vertikal: 0.96

Unterschrift des Schuetzen

Meyton Elektronik

Ergebnis: **413.5** (394)  
 Serien: 103.2 102.2 103.5 104.6  
 Zaehler: 34 6 0 0 0 0 0 0 0 0  
 Innenzehner: 29  
 weiteste: 330 (17), 299 (33), 290 (9)  
 beste Teiler 35.3 (19.) 49.8 (29.) 51.4 (13.)  
 Trefferlage 0.02 mm rechts, 0.20 mm hoch  
 Streuwert 1.24, horizontal: 1.52, vertikal: 0.87

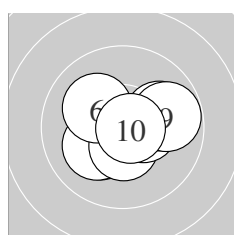
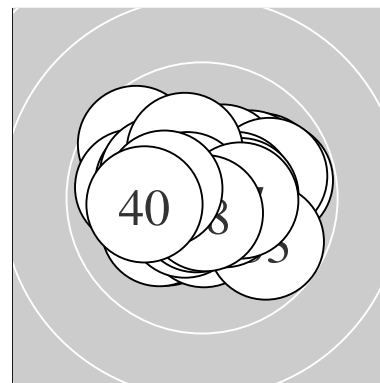

Serie 1:  
 10.7 \*                      10.7 \*                      10.2 \*                      10.1 ↙                      10.5 \*  
 10.1 ↘                      10.4 \*                      10.0 →                      9.8 →                      10.7 \*  
 beste Teiler 51.6 (10.) 66.0 (2.) 74.0 (1.)  
 Trefferlage 0.23 mm rechts, 0.18 mm tief  
 Streuwert 1.29, horizontal: 1.60, vertikal: 0.86

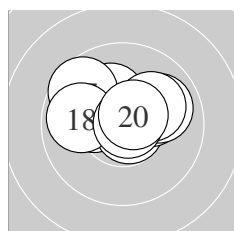

Serie 2:  
 10.2 \*                      10.2 \*                      10.7 \*                      10.2 \*                      9.9 →  
 10.1 →                      9.6 ↘                      9.9 ←                      10.8 \*                      10.6 \*  
 beste Teiler 35.3 (19.) 51.4 (13.) 91.4 (20.)  
 Trefferlage 0.04 mm links, 0.79 mm hoch  
 Streuwert 1.39, horizontal: 1.83, vertikal: 0.73

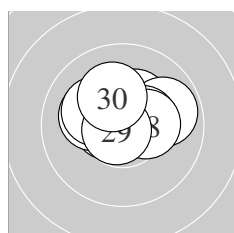

Serie 3:  
 10.6 \*                      10.2 \*                      10.3 \*                      9.9 →                      10.4 \*  
 10.5 \*                      10.2 \*                      10.4 \*                      10.8 \*                      10.2 \*  
 beste Teiler 49.8 (29.) 93.0 (21.) 113.4 (26.)  
 Trefferlage 0.01 mm links, 0.64 mm hoch  
 Streuwert 1.14, horizontal: 1.48, vertikal: 0.65

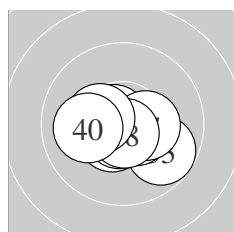

Serie 4:  
 10.7 \*                      10.5 \*                      9.8 ↘                      10.7 \*                      10.7 \*  
 10.6 \*                      10.4 \*                      10.7 \*                      10.4 \*                      10.1 ←  
 beste Teiler 60.0 (38.) 64.4 (34.) 66.7 (35.)  
 Trefferlage 0.06 mm links, 0.44 mm tief  
 Streuwert 1.06, horizontal: 1.38, vertikal: 0.59

Unterschrift des Schuetzen

Meyton Elektronik

Ergebnis: **412.2** (394)  
 Serien: 103.9 103.2 101.6 103.5  
 Zaehler: 34 6 0 0 0 0 0 0 0 0  
 Innenzehner: 30  
 weiteste: 331 (30), 315 (24), 302 (25)  
 beste Teiler 56.0 (26.) 66.8 (20.) 69.1 (40.)  
 Trefferlage 0.36 mm rechts, 0.77 mm hoch  
 Streuwert 1.12, horizontal: 1.17, vertikal: 1.07

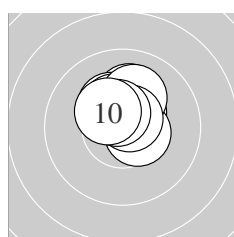
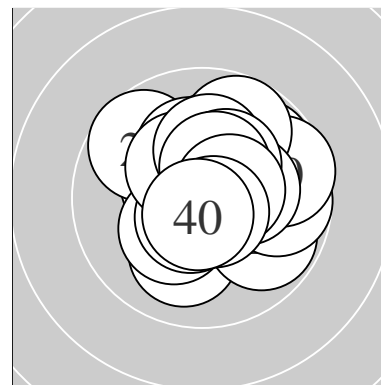

Serie 1:  
 10.5 \*                    10.1 ↑                    10.5 \*                    10.4 \*                    10.3 \*  
 10.4 \*                    10.1 ↑                    10.7 \*                    10.5 \*                    10.4 \*  
 beste Teiler 75.4 (8.) 102.5 (9.) 107.9 (3.)  
 Trefferlage 0.01 mm rechts, 1.12 mm hoch  
 Streuwert 0.71, horizontal: 0.73, vertikal: 0.69

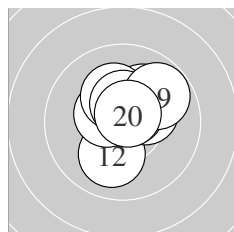

Serie 2:  
 10.5 \*                    10.0 ↓                    10.1 ↗                    10.5 \*                    10.3 \*  
 10.2 \*                    10.6 \*                    10.5 \*                    9.8 ↘                    10.7 \*  
 beste Teiler 66.8 (20.) 90.4 (17.) 105.4 (11.)  
 Trefferlage 0.33 mm rechts, 0.77 mm hoch  
 Streuwert 1.11, horizontal: 1.10, vertikal: 1.13

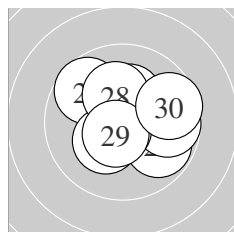

Serie 3:  
 9.8 ↘                    10.3 \*                    10.7 \*                    9.7 ↘                    9.7 →  
 10.7 \*                    10.3 \*                    10.2 \*                    10.6 \*                    9.6 →  
 beste Teiler 56.0 (26.) 71.8 (23.) 91.0 (29.)  
 Trefferlage 0.46 mm rechts, 0.31 mm hoch  
 Streuwert 1.59, horizontal: 1.83, vertikal: 1.32

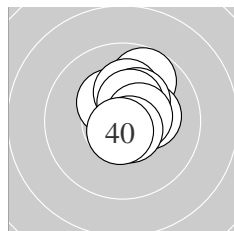

Serie 4:  
 10.3 \*                    10.3 \*                    9.8 ↑                    10.2 \*                    10.3 \*  
 10.3 \*                    10.4 \*                    10.5 \*                    10.7 \*                    10.7 \*  
 beste Teiler 69.1 (40.) 72.4 (39.) 115.5 (38.)  
 Trefferlage 0.66 mm rechts, 0.88 mm hoch  
 Streuwert 0.92, horizontal: 0.77, vertikal: 1.05

Unterschrift des Schuetzen

Meyton Elektronik



Ergebnis: **413.5** (394)  
 Serien: 103.7 102.3 103.6 103.9  
 Zaehler: 34 6 0 0 0 0 0 0 0 0  
 Innenzehner: 28  
 weiteste: 344 (18), 330 (39), 315 (22)  
 beste Teiler 13.1 (1.) 30.4 (36.) 31.0 (2.)  
 Trefferlage 0.20 mm rechts, 0.06 mm hoch  
 Streuwert 1.26, horizontal: 1.22, vertikal: 1.29

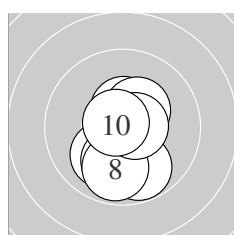
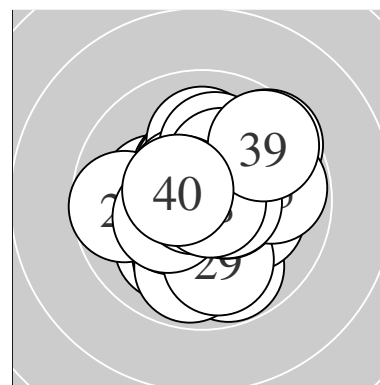

Serie 1:  
 10.9 \* 10.8 \* 10.5 \* 10.1 ✓ 10.4 \*  
 10.0 ↓ 9.8 ↓ 9.9 ↓ 10.6 \* 10.7 \*  
 beste Teiler 13.1 (1.) 31.0 (2.) 54.0 (10.)  
 Trefferlage 0.01 mm rechts, 0.70 mm tief  
 Streuwert 1.20, horizontal: 0.77, vertikal: 1.52

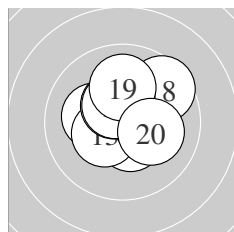

Serie 2:  
 10.2 \* 10.5 \* 10.4 \* 10.3 \* 10.3 \*  
 10.4 \* 10.5 \* 9.6 ↗ 10.0 ↑ 10.1 →  
 beste Teiler 120.3 (12.) 124.4 (17.) 126.5 (16.)  
 Trefferlage 0.30 mm rechts, 0.61 mm hoch  
 Streuwert 1.34, horizontal: 1.43, vertikal: 1.23

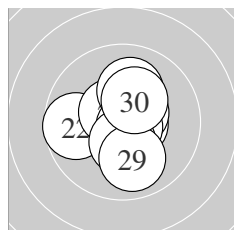

Serie 3:  
 10.7 \* 9.7 ← 10.6 \* 10.1 ↑ 10.6 \*  
 10.5 \* 10.7 \* 10.4 \* 10.0 ↓ 10.3 \*  
 beste Teiler 55.2 (27.) 67.4 (21.) 83.0 (25.)  
 Trefferlage 0.04 mm links, 0.06 mm hoch  
 Streuwert 1.27, horizontal: 1.23, vertikal: 1.30

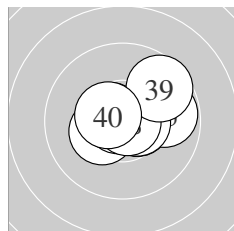

Serie 4:  
 10.3 \* 10.6 \* 10.6 \* 10.3 \* 9.8 →  
 10.8 \* 10.6 \* 10.8 \* 9.6 ↗ 10.5 \*  
 beste Teiler 30.4 (36.) 34.9 (38.) 89.1 (32.)  
 Trefferlage 0.56 mm rechts, 0.28 mm hoch  
 Streuwert 1.15, horizontal: 1.44, vertikal: 0.76

Unterschrift des Schuetzen

Meyton Elektronik

Ergebnis: **414.7** (398)  
 Serien: 103.6 103.6 103.5 104.0  
 Zaehler: 38 2 0 0 0 0 0 0 0 0  
 Innenzehner: 31  
 weiteste: 313 (11), 267 (7), 250 (23)  
 beste Teiler 52.3 (15.) 59.4 (24.) 63.6 (38.)  
 Trefferlage 0.20 mm rechts, 0.04 mm tief  
 Streuwert 1.15, horizontal: 1.33, vertikal: 0.94

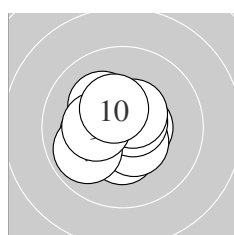
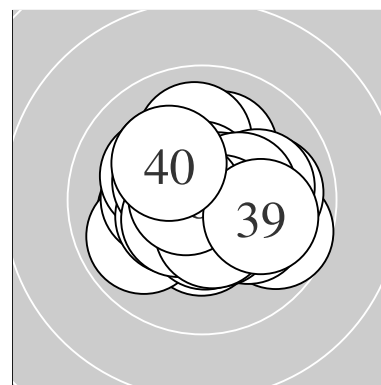

Serie 1:  
 10.5 \*                      10.4 \*                      10.5 \*                      10.2 \*                      10.7 \*  
 10.5 \*                      9.9 ↙                      10.2 \*                      10.3 \*                      10.4 \*  
 beste Teiler 75.1 (5.) 103.0 (1.) 110.6 (6.)  
 Trefferlage 0.45 mm links, 0.05 mm tief  
 Streuwert 1.14, horizontal: 1.24, vertikal: 1.03

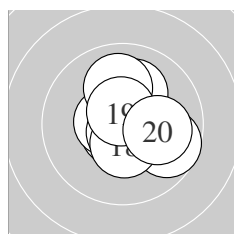

Serie 2:  
 9.7 ↘                      10.7 \*                      10.6 \*                      10.7 \*                      10.7 \*  
 10.1 ↑                      10.0 ↑                      10.5 \*                      10.6 \*                      10.0 →  
 beste Teiler 52.3 (15.) 67.8 (12.) 75.1 (14.)  
 Trefferlage 0.40 mm rechts, 0.22 mm hoch  
 Streuwert 1.24, horizontal: 1.23, vertikal: 1.25

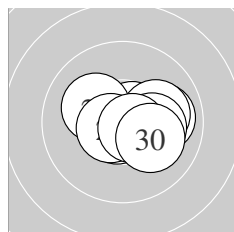

Serie 3:  
 10.7 \*                      10.2 \*                      10.0 →                      10.7 \*                      10.1 →  
 10.2 \*                      10.6 \*                      10.2 \*                      10.7 \*                      10.1 ↘  
 beste Teiler 59.4 (24.) 74.0 (21.) 74.9 (29.)  
 Trefferlage 0.85 mm rechts, 0.10 mm tief  
 Streuwert 1.09, horizontal: 1.42, vertikal: 0.61

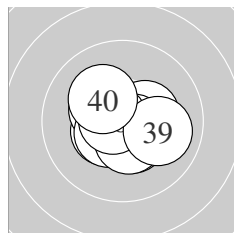

Serie 4:  
 10.4 \*                      10.4 \*                      10.6 \*                      10.4 \*                      10.4 \*  
 10.5 \*                      10.4 \*                      10.7 \*                      10.0 →                      10.2 \*  
 beste Teiler 63.6 (38.) 85.4 (33.) 118.5 (36.)  
 Trefferlage 0.02 mm rechts, 0.22 mm tief  
 Streuwert 1.07, horizontal: 1.26, vertikal: 0.86

Unterschrift des Schuetzen

Meyton Elektronik

Ergebnis: **403.5** (385)  
 Serien: 100.6 103.2 101.8 97.9  
 Zaehler: 28 9 3 0 0 0 0 0 0 0  
 Innenzehner: 23  
 weiteste: 559 (36), 547 (33), 502 (32)  
 beste Teiler 58.1 (7.) 59.3 (12.) 67.4 (27.)  
 Trefferlage 0.26 mm rechts, 0.16 mm tief  
 Streuwert 1.79, horizontal: 1.93, vertikal: 1.63

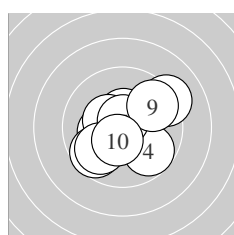
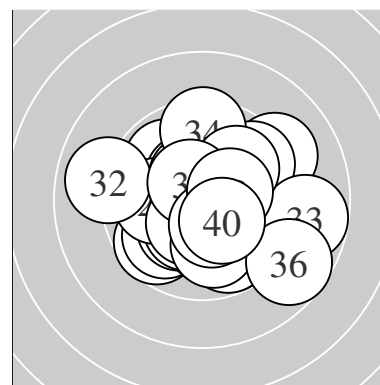

Serie 1:  
 10.5 \*                      10.3 \*                      9.7 ↙                      9.7 ↘                      10.4 \*  
 9.9 ↙                      10.7 \*                      9.2 ↗                      9.7 ↗                      10.5 \*  
 beste Teiler 58.1 (7.) 113.2 (1.) 122.0 (10.)  
 Trefferlage 0.10 mm rechts, 0.10 mm tief  
 Streuwert 1.89, horizontal: 2.12, vertikal: 1.64

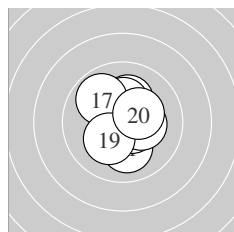

Serie 2:  
 10.1 ↓                      10.7 \*                      10.2 \*                      10.3 \*                      10.6 \*  
 10.6 \*                      9.9 ↘                      10.3 \*                      10.2 \*                      10.3 \*  
 beste Teiler 59.3 (12.) 93.2 (16.) 95.8 (15.)  
 Trefferlage 0.25 mm rechts, 0.22 mm hoch  
 Streuwert 1.25, horizontal: 1.08, vertikal: 1.40

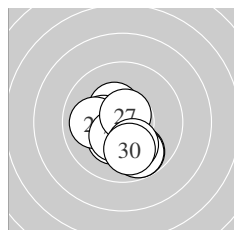

Serie 3:  
 10.4 \*                      9.8 ↘                      10.3 \*                      10.3 \*                      10.0 ←  
 10.4 \*                      10.7 \*                      9.8 ↘                      10.1 ↓                      10.0 ↓  
 beste Teiler 67.4 (27.) 137.5 (26.) 142.5 (21.)  
 Trefferlage 0.18 mm links, 1.02 mm tief  
 Streuwert 1.35, horizontal: 1.29, vertikal: 1.40

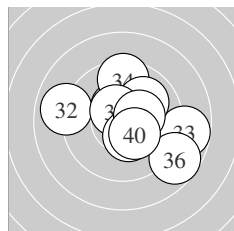

Serie 4:  
 10.4 \*                      8.9 ←                      8.8 →                      9.5 ↑                      10.0 ↗  
 8.7 ↘                      10.5 \*                      10.4 \*                      10.3 \*                      10.4 \*  
 beste Teiler 109.5 (37.) 132.5 (31.) 138.7 (38.)  
 Trefferlage 0.87 mm rechts, 0.23 mm hoch  
 Streuwert 2.44, horizontal: 2.86, vertikal: 1.92

Unterschrift des Schuetzen

Meyton Elektronik

Ergebnis: **414.9** (396)  
 Serien: 103.7 103.7 102.9 104.6  
 Zaehler: 36 4 0 0 0 0 0 0 0 0  
 Innenzehner: 31  
 weiteste: 458 (23), 321 (20), 275 (37)  
 beste Teiler 32.5 (8.) 38.3 (22.) 47.0 (4.)  
 Trefferlage 0.23 mm links, 0.07 mm hoch  
 Streuwert 1.20, horizontal: 1.34, vertikal: 1.04

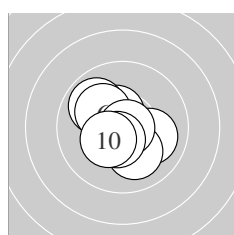
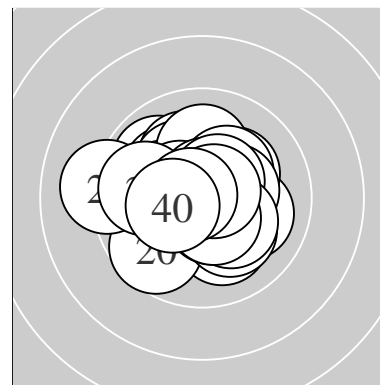

Serie 1:  
 10.5 \*                      10.5 \*                      9.9 ↘                      10.8 \*                      10.0 →  
 10.2 \*                      10.1 ↓                      10.8 \*                      10.5 \*                      10.4 \*  
 beste Teiler 32.5 (8.) 47.0 (4.) 107.9 (9.)  
 Trefferlage 0.15 mm links, 0.20 mm tief  
 Streuwert 1.22, horizontal: 1.27, vertikal: 1.17

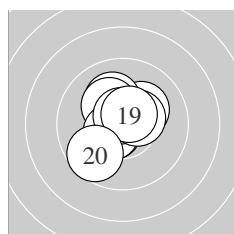

Serie 2:  
 10.2 \*                      10.1 ↗                      10.7 \*                      10.6 \*                      10.2 \*  
 10.5 \*                      10.7 \*                      10.4 \*                      10.6 \*                      9.7 ↙  
 beste Teiler 55.9 (13.) 67.8 (17.) 94.5 (19.)  
 Trefferlage 0.32 mm links, 0.28 mm hoch  
 Streuwert 1.18, horizontal: 1.11, vertikal: 1.24

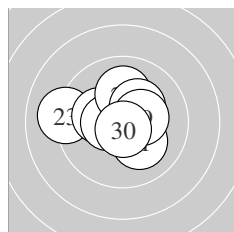

Serie 3:  
 10.1 ↘                      10.8 \*                      9.1 ←                      10.2 \*                      10.7 \*  
 10.5 \*                      10.1 ↑                      10.3 \*                      10.4 \*                      10.7 \*  
 beste Teiler 38.3 (22.) 57.2 (30.) 71.4 (25.)  
 Trefferlage 0.28 mm links, 0.28 mm hoch  
 Streuwert 1.48, horizontal: 1.83, vertikal: 1.02

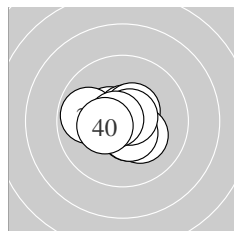

Serie 4:  
 10.5 \*                      10.7 \*                      10.5 \*                      10.2 \*                      10.5 \*  
 10.5 \*                      9.9 ←                      10.7 \*                      10.7 \*                      10.4 \*  
 beste Teiler 57.7 (39.) 64.4 (38.) 66.4 (32.)  
 Trefferlage 0.18 mm links, 0.05 mm tief  
 Streuwert 1.02, horizontal: 1.24, vertikal: 0.73

Unterschrift des Schuetzen

Meyton Elektronik

Ergebnis: **411.9** (394)  
 Serien: 102.4 102.4 102.0 105.1  
 Zaehler: 34 6 0 0 0 0 0 0 0 0  
 Innenzehner: 28  
 weiteste: 432 (1), 369 (10), 324 (14)  
 beste Teiler 6.3 (3.) 16.6 (35.) 18.1 (9.)  
 Trefferlage 0.20 mm links, 0.40 mm hoch  
 Streuwert 1.31, horizontal: 1.34, vertikal: 1.27

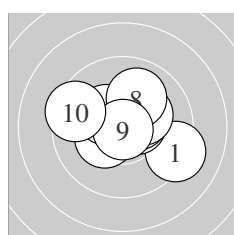
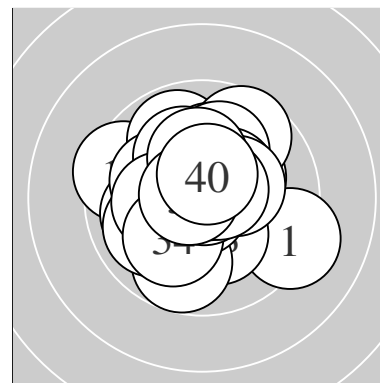

Serie 1:  
 9.2 ↘ 10.5 \* 10.9 \* 10.5 \* 10.3 \*  
 10.3 \* 10.3 \* 10.0 ↑ 10.9 \* 9.5 ↙  
 beste Teiler 6.3 (3.) 18.1 (9.) 103.1 (2.)  
 Trefferlage 0.26 mm rechts, 0.31 mm hoch  
 Streuwert 1.61, horizontal: 2.00, vertikal: 1.10

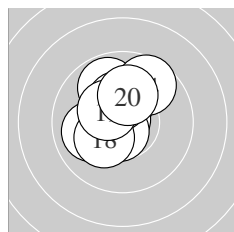

Serie 2:  
 10.4 \* 9.8 ↖ 10.8 \* 9.7 ↗ 10.7 \*  
 10.3 \* 10.0 ← 10.2 \* 10.4 \* 10.1 ↑  
 beste Teiler 26.2 (13.) 73.5 (15.) 126.0 (11.)  
 Trefferlage 0.45 mm links, 0.86 mm hoch  
 Streuwert 1.26, horizontal: 1.10, vertikal: 1.40

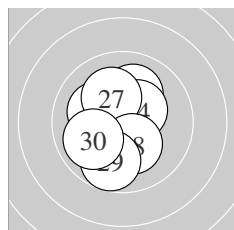

Serie 3:  
 10.4 \* 10.5 \* 10.1 ↑ 10.4 \* 10.4 \*  
 10.1 ↖ 10.2 \* 10.2 \* 9.8 ↓ 9.9 ↙  
 beste Teiler 103.0 (22.) 126.0 (25.) 141.3 (24.)  
 Trefferlage 0.48 mm links, 0.23 mm hoch  
 Streuwert 1.41, horizontal: 1.13, vertikal: 1.64

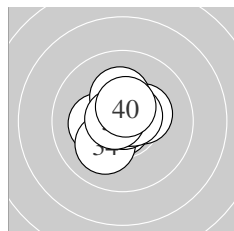

Serie 4:  
 10.2 \* 10.8 \* 10.3 \* 10.1 ✓ 10.9 \*  
 10.8 \* 10.6 \* 10.2 \* 10.7 \* 10.5 \*  
 beste Teiler 16.6 (35.) 38.9 (32.) 47.5 (36.)  
 Trefferlage 0.12 mm links, 0.21 mm hoch  
 Streuwert 0.93, horizontal: 0.94, vertikal: 0.91

Unterschrift des Schuetzen

Meyton Elektronik

Ergebnis: **405.5** (387)  
 Serien: 101.7 100.4 100.7 102.7  
 Zaehler: 27 13 0 0 0 0 0 0 0 0  
 Innenzehner: 20  
 weiteste: 403 (30), 375 (26), 367 (16)  
 beste Teiler 21.5 (38.) 49.6 (1.) 75.4 (31.)  
 Trefferlage 0.23 mm links, 0.34 mm tief  
 Streuwert 1.58, horizontal: 1.69, vertikal: 1.46

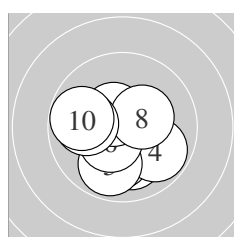
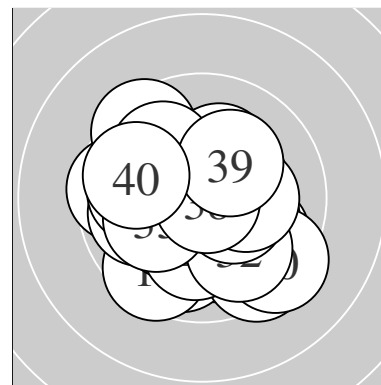

Serie 1:  
 10.8 \* 10.1 ↘ 10.1 ↓ 9.8 ↘ 9.9 ↓  
 10.5 \* 10.5 \* 10.3 \* 9.9 ← 9.8 ←  
 beste Teiler 49.6 (1.) 109.8 (7.) 124.5 (6.)  
 Trefferlage 0.33 mm links, 0.65 mm tief  
 Streuwert 1.48, horizontal: 1.60, vertikal: 1.35

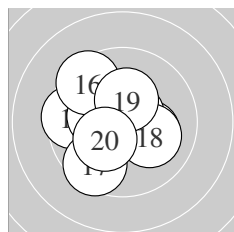

Serie 2:  
 10.0 ↘ 9.6 ← 10.2 \* 10.6 \* 10.3 \*  
 9.5 ↘ 9.5 ↙ 10.1 ↘ 10.3 \* 10.3 \*  
 beste Teiler 85.0 (14.) 158.3 (19.) 172.4 (15.)  
 Trefferlage 0.79 mm links, 0.15 mm hoch  
 Streuwert 1.75, horizontal: 1.83, vertikal: 1.66

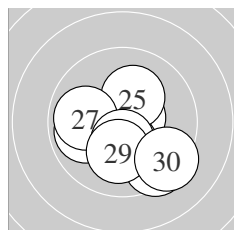

Serie 3:  
 10.6 \* 9.9 ← 10.5 \* 10.3 \* 10.2 \*  
 9.5 ↘ 9.9 ← 10.4 \* 10.1 ↓ 9.3 ↘  
 beste Teiler 83.9 (21.) 119.9 (23.) 136.0 (28.)  
 Trefferlage 0.12 mm rechts, 0.99 mm tief  
 Streuwert 1.64, horizontal: 1.81, vertikal: 1.45

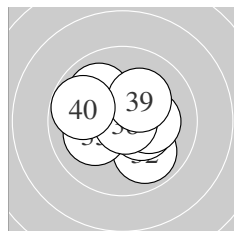

Serie 4:  
 10.7 \* 9.9 ↘ 10.1 ← 10.5 \* 10.0 ↘  
 10.4 \* 10.2 \* 10.9 \* 10.2 \* 9.8 ←  
 beste Teiler 21.5 (38.) 75.4 (31.) 115.2 (34.)  
 Trefferlage 0.04 mm rechts, 0.10 mm hoch  
 Streuwert 1.43, horizontal: 1.61, vertikal: 1.22

Unterschrift des Schuetzen

Meyton Elektronik

Ergebnis:	<b>398.1</b>	(381)
Serien:	99.1	100.6 99.9 98.5
Zaehler:	24	13 3 0 0 0 0 0 0 0
Innenzehner:	14	
weiteste:	631 (33), 578 (31), 534 (20)	
beste Teiler	11.3 (8.)	26.0 (29.) 71.4 (21.)
Trefferlage	0.15 mm rechts,	0.18 mm hoch
Streuwert	2.04, horizontal:	2.08, vertikal: 1.99

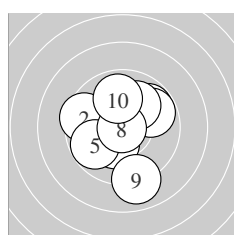
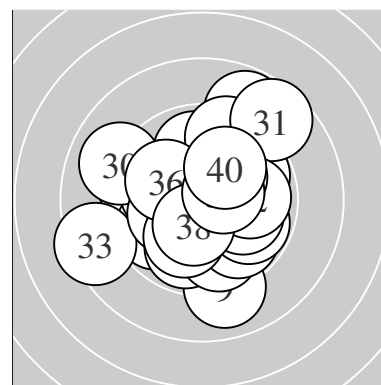

Serie 1:	10.1 ↑	9.5 ←	9.8 ↗	10.3 *	9.8 ↙
	9.8 ↘	10.0 ↗	10.9 *	9.0 ↓	9.9 ↑
beste Teiler	11.3 (8.)	169.5 (4.)	203.8 (1.)		
Trefferlage	0.04 mm rechts, 0.25 mm hoch				
Streuwert	2.12, horizontal: 1.95, vertikal: 2.29				

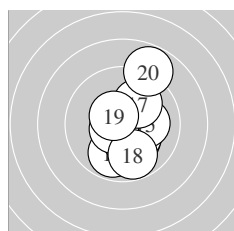

Serie 2:	9.9 ↓	10.4 *	10.2 *	10.3 *	10.1 →
	10.6 *	10.0 ↗	9.8 ↓	10.5 *	8.8 ↗
beste Teiler	90.8 (16.)	110.3 (19.)	128.7 (12.)		
Trefferlage	0.70 mm rechts, 0.20 mm tief				
Streuwert	1.81, horizontal: 1.20, vertikal: 2.27				

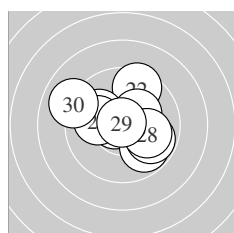

Serie 3:	10.7 *	9.5 ↑	10.3 *	10.0 ↖	9.8 ↘
	9.8 ↘	10.0 ←	10.0 →	10.8 *	9.0 ↖
beste Teiler	26.0 (29.)	71.4 (21.)	168.8 (23.)		
Trefferlage	0.02 mm links, 0.41 mm hoch				
Streuwert	1.99, horizontal: 2.33, vertikal: 1.58				

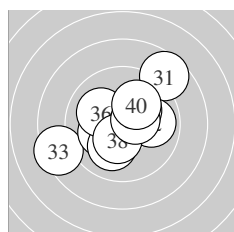

Serie 4:	8.6 ↗	9.9 →	8.4 ↙	10.2 *	10.1 ↓
	10.1 ↖	10.2 *	10.4 *	10.5 *	10.1 ↗
beste Teiler	123.0 (39.)	142.6 (38.)	181.7 (37.)		
Trefferlage	0.09 mm links, 0.24 mm hoch				
Streuwert	2.41, horizontal: 2.75, vertikal: 2.02				

Unterschrift des Schuetzen

Meyton Elektronik

**ISSF AR Women – Probe – Frauen**

StandNr: 127

**Embacher, Sonja** #70804708

**StartNr: 101**

23. Januar 2017 14:38

T – Sportschützen Söll

Ergebnis: **0.0** (0)<sub>DNS</sub>  
Serien:  
Zähler: 0 0 0 0 0 0 0 0 0 0  
Innenzehner: 0  
weiteste:  
~~beste Teiler~~ – Schütze ist nicht zum Wettkampf angetreten  
Trefferlage 0.00 mm , 0.00 mm  
Streuwert  
Unterschrift des Schuetzen

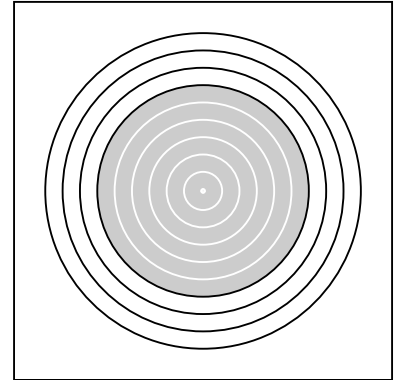



Ergebnis: **403.5** (383)  
 Serien: 101.2 99.9 101.8 100.6  
 Zaehler: 23 17 0 0 0 0 0 0 0 0  
 Innenzehner: 17  
 weiteste: 367 (14), 358 (37), 354 (32)  
 beste Teiler 48.0 (1.) 56.4 (24.) 60.7 (12.)  
 Trefferlage 0.25 mm rechts, 0.50 mm hoch  
 Streuwert 1.64, horizontal: 1.92, vertikal: 1.31

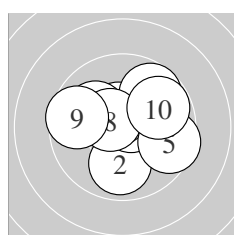
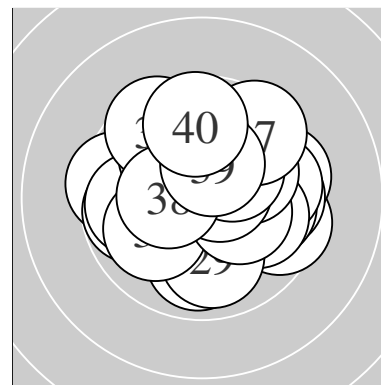

Serie 1:  
 10.8 \*                      9.9 ↓                      10.7 \*                      10.5 \*                      9.6 →  
 10.1 ↖                      9.7 ↗                      10.5 \*                      9.6 ←                      9.8 →  
 beste Teiler 48.0 (1.) 74.6 (3.) 102.2 (8.)  
 Trefferlage 0.23 mm rechts, 0.39 mm hoch  
 Streuwert 1.73, horizontal: 2.03, vertikal: 1.36

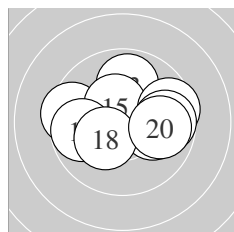

Serie 2:  
 10.1 →                      10.7 \*                      9.9 ↑                      9.5 ←                      10.4 \*  
 9.8 ←                      9.6 →                      10.3 \*                      9.7 →                      9.9 →  
 beste Teiler 60.7 (12.) 131.1 (15.) 169.0 (18.)  
 Trefferlage 0.30 mm rechts, 0.34 mm hoch  
 Streuwert 1.90, horizontal: 2.46, vertikal: 1.10

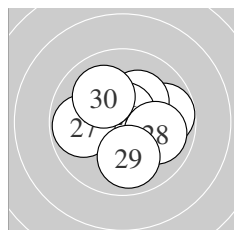

Serie 3:  
 10.4 \*                      9.8 →                      10.3 \*                      10.7 \*                      10.2 \*  
 10.7 \*                      9.8 ←                      10.0 →                      9.9 ↓                      10.0 ↘  
 beste Teiler 56.4 (24.) 61.0 (26.) 130.0 (21.)  
 Trefferlage 0.21 mm rechts, 0.17 mm hoch  
 Streuwert 1.53, horizontal: 1.80, vertikal: 1.20

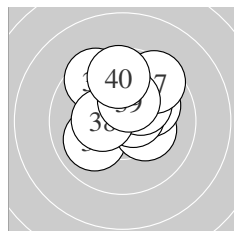

Serie 4:  
 10.0 ↙                      9.5 ↘                      10.3 \*                      10.1 ↗                      10.6 \*  
 10.2 \*                      9.5 ↗                      10.4 \*                      10.3 \*                      9.7 ↑  
 beste Teiler 85.0 (35.) 143.2 (38.) 152.7 (39.)  
 Trefferlage 0.26 mm rechts, 1.12 mm hoch  
 Streuwert 1.56, horizontal: 1.60, vertikal: 1.53

Unterschrift des Schuetzen

Meyton Elektronik

Ergebnis: **417.3** (397)<sup>QF</sup>  
 Serien: 105.0 103.8 104.7 103.8  
 Zaehler: 37 3 0 0 0 0 0 0 0 0  
 Innenzehner: 32  
 weiteste: 301 (32), 295 (16), 254 (35)  
 beste Teiler 7.0 (13.) 8.9 (4.) 42.0 (10.)  
 Trefferlage 0.13 mm links, 0.22 mm hoch  
 Streuwert 1.05, horizontal: 1.04, vertikal: 1.05

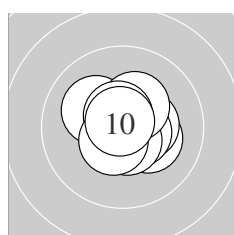
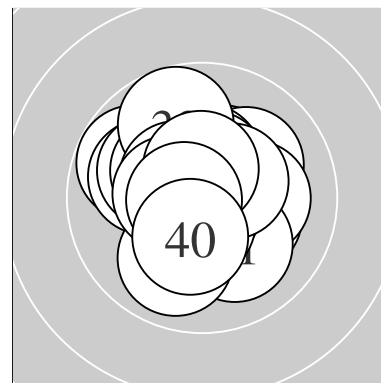

Serie 1:  
 10.2 \* 10.4 \* 10.6 \* 10.9 \* 10.1 ↘  
 10.6 \* 10.3 \* 10.6 \* 10.5 \* 10.8 \*  
 beste Teiler 8.9 (4.) 42.0 (10.) 79.4 (8.)  
 Trefferlage 0.22 mm rechts, 0.08 mm hoch  
 Streuwert 0.91, horizontal: 1.01, vertikal: 0.80

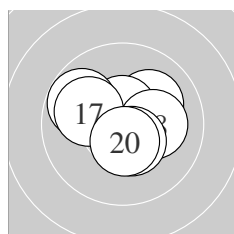

Serie 2:  
 10.5 \* 10.7 \* 10.9 \* 10.1 ↗ 10.6 \*  
 9.8 ↙ 10.0 ↙ 10.2 \* 10.5 \* 10.5 \*  
 beste Teiler 7.0 (13.) 53.1 (12.) 90.0 (15.)  
 Trefferlage 0.04 mm links, 0.16 mm hoch  
 Streuwert 1.23, horizontal: 1.46, vertikal: 0.96

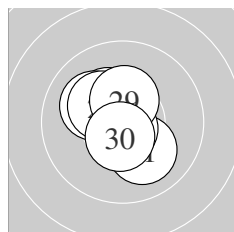

Serie 3:  
 10.1 ↘ 10.3 \* 10.6 \* 10.8 \* 10.7 \*  
 10.1 ↘ 10.8 \* 10.3 \* 10.4 \* 10.6 \*  
 beste Teiler 42.1 (27.) 43.3 (24.) 69.2 (25.)  
 Trefferlage 0.35 mm links, 0.34 mm hoch  
 Streuwert 0.96, horizontal: 0.86, vertikal: 1.06

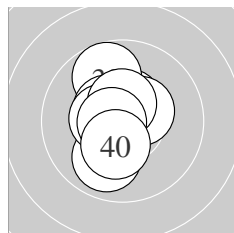

Serie 4:  
 10.5 \* 9.7 ↗ 10.8 \* 10.5 \* 9.9 ↙  
 10.5 \* 10.4 \* 10.5 \* 10.7 \* 10.3 \*  
 beste Teiler 44.5 (33.) 70.4 (39.) 113.1 (38.)  
 Trefferlage 0.37 mm links, 0.30 mm hoch  
 Streuwert 1.15, horizontal: 0.77, vertikal: 1.43

QF – Schütze hat sich fürs Finale qualifiziert

Unterschrift des Schuetzen

Meyton Elektronik

Ergebnis:	<b>417.1</b>	(399) <sup>QF</sup>
Serien:	104.2	106.0 104.3 102.6
Zaehler:	39	1 0 0 0 0 0 0 0 0
Innenzehner:	33	
weiteste:	256 (29), 244 (32), 229 (3)	
beste Teiler	12.0 (22.)	42.7 (30.) 44.5 (2.)
Trefferlage	0.11 mm rechts,	0.13 mm tief
Streuwert	1.04, horizontal:	1.17, vertikal: 0.89

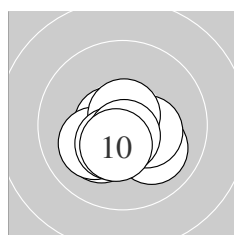
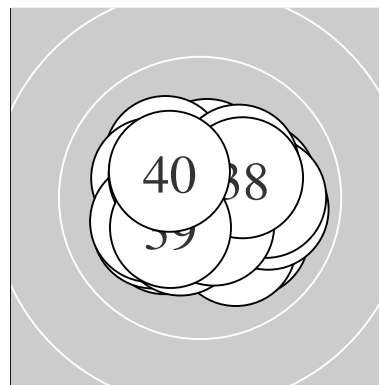

Serie 1:	10.2 *	10.8 *	10.0 ↘	10.6 *	10.1 ↙
	10.3 *	10.7 *	10.4 *	10.7 *	10.4 *
beste Teiler	44.5 (2.)	62.6 (7.)	66.6 (9.)		
Trefferlage	0.11 mm links, 0.68 mm tief				
Streuwert	0.93, horizontal: 1.12, vertikal: 0.69				

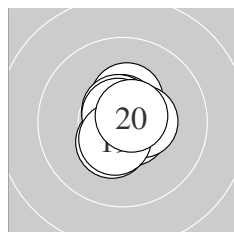

Serie 2:	10.7 *	10.4 *	10.7 *	10.7 *	10.7 *
	10.4 *	10.7 *	10.5 *	10.5 *	10.7 *
beste Teiler	54.7 (17.)	65.9 (11.)	67.4 (20.)		
Trefferlage	0.14 mm rechts, 0.08 mm hoch				
Streuwert	0.72, horizontal: 0.59, vertikal: 0.83				

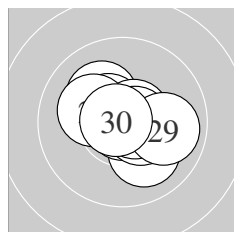

Serie 3:	10.1 ↘	10.9 *	10.2 *	10.5 *	10.6 *
	10.5 *	10.2 *	10.6 *	9.9 →	10.8 *
beste Teiler	12.0 (22.)	42.7 (30.)	77.0 (28.)		
Trefferlage	0.20 mm rechts, 0.07 mm hoch				
Streuwert	1.13, horizontal: 1.33, vertikal: 0.89				

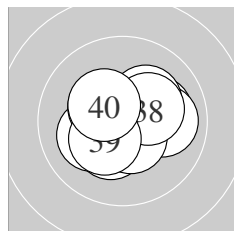

Serie 4:	10.1 →	10.0 →	10.3 *	10.1 ↙	10.4 *
	10.2 *	10.5 *	10.3 *	10.3 *	10.4 *
beste Teiler	113.1 (37.)	143.0 (35.)	150.9 (40.)		
Trefferlage	0.20 mm rechts, 0.00 mm				
Streuwert	1.32, horizontal: 1.58, vertikal: 1.00				

QF – Schütze hat sich fürs Finale qualifiziert

Unterschrift des Schuetzen

Meyton Elektronik

Ergebnis:	<b>395.5</b>	(378)
Serien:	103.5	97.4 100.3 94.3
Zaehler:	24	11 4 1 0 0 0 0 0 0
Innenzehner:	14	
weiteste:	824 (33), 750 (38), 633 (18)	
beste Teiler	22.3 (3.)	25.4 (23.) 35.3 (21.)
Trefferlage	0.84 mm rechts,	0.61 mm tief
Streuwert	2.23, horizontal:	2.89, vertikal: 1.29

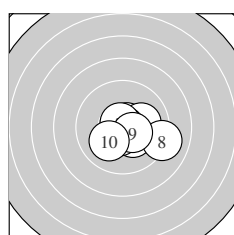
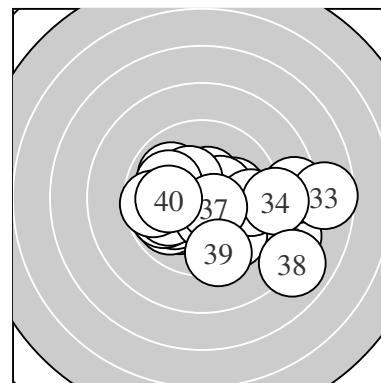

Serie 1:	10.7 *	10.1 →	10.9 *	10.3 *	10.7 *
	10.5 *	10.7 *	9.1 →	10.4 *	10.1 ↙
beste Teiler	22.3 (3.)	56.4 (7.)	59.4 (5.)		
Trefferlage	0.77 mm rechts, 0.46 mm tief				
Streuwert	1.28, horizontal: 1.61, vertikal: 0.81				

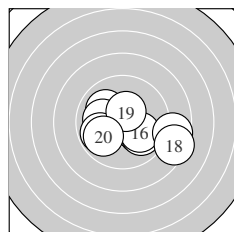

Serie 2:	10.1 ↘	10.0 ↘	10.0 ←	9.9 ↘	9.8 ↙
	10.1 ↘	8.7 →	8.4 →	10.5 *	9.9 ↙
beste Teiler	125.8 (19.)	212.7 (11.)	223.6 (16.)		
Trefferlage	0.87 mm rechts, 0.74 mm tief				
Streuwert	2.40, horizontal: 3.13, vertikal: 1.29				

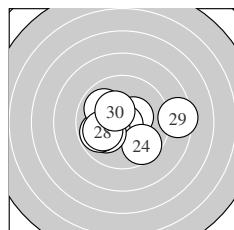

Serie 3:	10.8 *	10.4 *	10.9 *	9.6 ↘	10.1 ↙
	9.8 ↙	9.9 ↘	10.0 ←	8.5 →	10.3 *
beste Teiler	25.4 (23.)	35.3 (21.)	135.5 (22.)		
Trefferlage	0.02 mm rechts, 0.24 mm tief				
Streuwert	2.09, horizontal: 2.68, vertikal: 1.24				

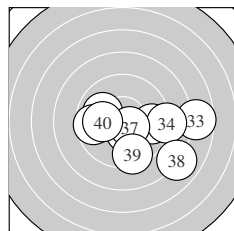

Serie 4:	10.0 ↘	9.6 →	7.7 →	9.0 →	9.6 ←
	10.4 *	10.5 *	8.0 ↘	9.4 ↓	10.1 ←
beste Teiler	101.0 (37.)	132.5 (36.)	225.1 (40.)		
Trefferlage	1.70 mm rechts, 0.99 mm tief				
Streuwert	2.99, horizontal: 3.86, vertikal: 1.72				

Unterschrift des Schuetzen

Meyton Elektronik

Ergebnis: **403.3** (383)  
 Serien: 100.7 100.6 98.7 103.3  
 Zaehler: 23 17 0 0 0 0 0 0 0 0  
 Innenzehner: 21  
 weiteste: 455 (24), 449 (17), 408 (30)  
 beste Teiler 16.1 (40.) 44.2 (19.) 52.6 (27.)  
 Trefferlage 0.24 mm rechts, 0.06 mm hoch  
 Streuwert 1.75, horizontal: 1.91, vertikal: 1.57

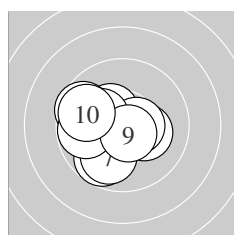
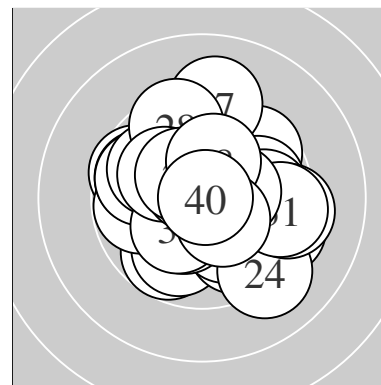

Serie 1:  
 10.2 \* 10.4 \* 9.7 ↙ 10.5 \* 9.6 ↖  
 10.2 \* 9.9 ↘ 9.8 ← 10.6 \* 9.8 ↖  
 beste Teiler 79.0 (9.) 109.1 (4.) 140.1 (2.)  
 Trefferlage 1.09 mm links, 0.27 mm tief  
 Streuwert 1.54, horizontal: 1.70, vertikal: 1.35

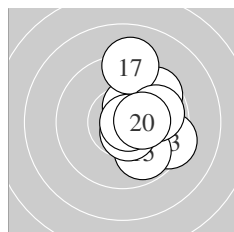

Serie 2:  
 10.4 \* 10.6 \* 9.4 → 9.6 ↗ 9.8 ↘  
 10.6 \* 9.2 ↑ 9.9 → 10.8 \* 10.3 \*  
 beste Teiler 44.2 (19.) 92.2 (12.) 92.6 (16.)  
 Trefferlage 1.49 mm rechts, 0.40 mm hoch  
 Streuwert 1.55, horizontal: 1.10, vertikal: 1.90

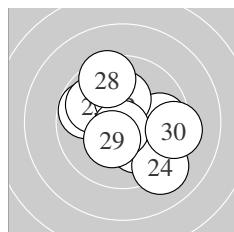

Serie 3:  
 9.8 ↖ 9.8 → 10.1 ↘ 9.1 ↘ 9.9 ↖  
 10.2 \* 10.7 \* 9.5 ↖ 10.3 \* 9.3 →  
 beste Teiler 52.6 (27.) 158.4 (29.) 181.0 (26.)  
 Trefferlage 0.37 mm rechts, 0.01 mm tief  
 Streuwert 2.16, horizontal: 2.33, vertikal: 1.97

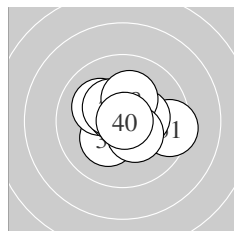

Serie 4:  
 9.5 → 10.6 \* 10.3 \* 10.3 \* 10.1 ↖  
 10.6 \* 10.4 \* 10.2 \* 10.4 \* 10.9 \*  
 beste Teiler 16.1 (40.) 82.0 (36.) 85.5 (32.)  
 Trefferlage 0.19 mm rechts, 0.14 mm hoch  
 Streuwert 1.33, horizontal: 1.59, vertikal: 1.01

Unterschrift des Schuetzen

Ergebnis: **418.6** (399)<sup>QF</sup>  
 Serien: 104.5 104.7 105.2 104.2  
 Zaehler: 39 1 0 0 0 0 0 0 0 0  
 Innenzehner: 36  
 weiteste: 277 (39), 243 (16), 209 (6)  
 beste Teiler 5.6 (7.) 12.0 (11.) 14.8 (21.)  
 Trefferlage 0.10 mm rechts, 0.10 mm hoch  
 Streuwert 0.95, horizontal: 1.13, vertikal: 0.71

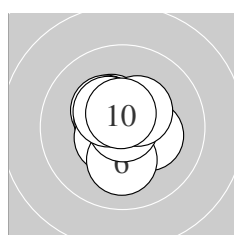
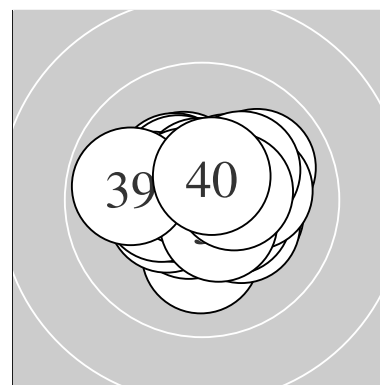

Serie 1:  
 10.4 \*                      10.3 \*                      10.6 \*                      10.5 \*                      10.3 \*  
 10.1 ↓                      10.9 \*                      10.4 \*                      10.4 \*                      10.6 \*  
 beste Teiler 5.6 (7.) 88.6 (10.) 92.3 (3.)  
 Trefferlage 0.19 mm links, 0.22 mm hoch  
 Streuwert 0.97, horizontal: 0.89, vertikal: 1.05

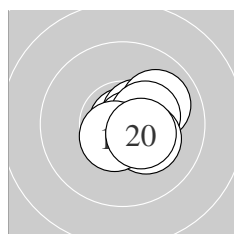

Serie 2:  
 10.9 \*                      10.6 \*                      10.5 \*                      10.5 \*                      10.7 \*  
 10.0 ↗                      10.3 \*                      10.2 \*                      10.6 \*                      10.4 \*  
 beste Teiler 12.0 (11.) 51.4 (15.) 76.0 (12.)  
 Trefferlage 0.91 mm rechts, 0.00 mm  
 Streuwert 0.71, horizontal: 0.75, vertikal: 0.67

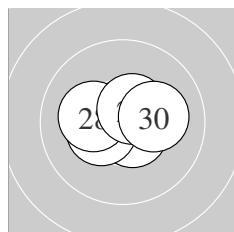

Serie 3:  
 10.9 \*                      10.5 \*                      10.6 \*                      10.8 \*                      10.6 \*  
 10.6 \*                      10.4 \*                      10.2 \*                      10.5 \*                      10.1 →  
 beste Teiler 14.8 (21.) 42.4 (24.) 82.2 (23.)  
 Trefferlage 0.11 mm links, 0.02 mm tief  
 Streuwert 0.90, horizontal: 1.17, vertikal: 0.49

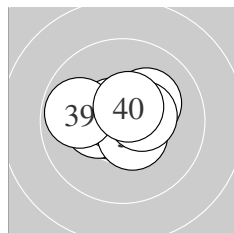

Serie 4:  
 10.5 \*                      10.6 \*                      10.7 \*                      10.3 \*                      10.2 \*  
 10.6 \*                      10.5 \*                      10.4 \*                      9.8 ←                      10.6 \*  
 beste Teiler 72.1 (33.) 80.4 (36.) 96.1 (32.)  
 Trefferlage 0.19 mm links, 0.22 mm hoch  
 Streuwert 1.05, horizontal: 1.36, vertikal: 0.58

QF – Schütze hat sich fürs Finale qualifiziert

Unterschrift des Schuetzen

Meyton Elektronik

Ergebnis:	<b>416.0</b>	(395) <sup>QF</sup>
Serien:	101.5	105.1 104.3 105.1
Zaehler:	35	5 0 0 0 0 0 0 0 0
Innenzehner:	30	
weiteste:	341	(3), 304 (35), 298 (9)
beste Teiler	10.0	(40.) 28.1 (19.) 43.1 (31.)
Trefferlage	0.22 mm	links, 0.13 mm hoch
Streuwert	1.13,	horizontal: 1.20, vertikal: 1.06

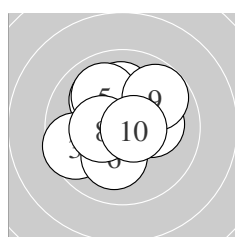
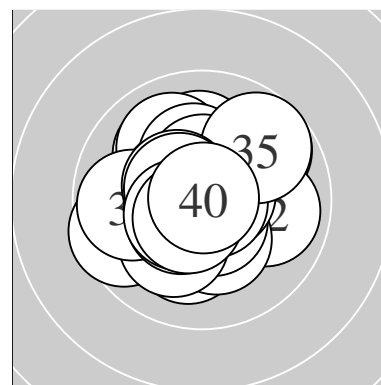

Serie 1:	10.0 ↘	10.1 ↑	9.6 ↙	10.6 *	10.0 ↖
	10.1 ↓	10.2 *	10.4 *	9.8 ↗	10.7 *
beste Teiler	74.8	(10.) 100.1 (4.)	138.5 (8.)		
Trefferlage	0.37 mm	links, 0.42 mm	hoch		
Streuwert	1.58,	horizontal: 1.64, vertikal: 1.51			

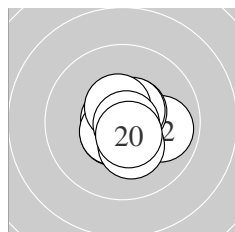

Serie 2:	10.7 *	9.9 →	10.5 *	10.6 *	10.6 *
	10.6 *	10.5 *	10.3 *	10.8 *	10.6 *
beste Teiler	28.1	(19.) 62.2 (11.)	92.6 (16.)		
Trefferlage	0.29 mm	rechts, 0.16 mm	tief		
Streuwert	0.90,	horizontal: 0.97, vertikal: 0.83			

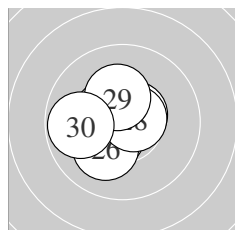

Serie 3:	10.5 *	10.6 *	10.6 *	10.5 *	10.7 *
	10.1 ↙	10.6 *	10.6 *	10.3 *	9.8 ←
beste Teiler	71.1	(25.) 77.7 (28.)	79.0 (23.)		
Trefferlage	0.54 mm	links, 0.06 mm	hoch		
Streuwert	1.01,	horizontal: 1.10, vertikal: 0.92			

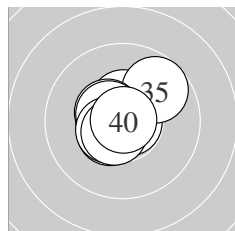

Serie 4:	10.8 *	10.5 *	10.5 *	10.6 *	9.7 ↗
	10.5 *	10.5 *	10.5 *	10.6 *	10.9 *
beste Teiler	10.0	(40.) 43.1 (31.)	92.0 (34.)		
Trefferlage	0.24 mm	links, 0.22 mm	hoch		
Streuwert	0.96,	horizontal: 1.00, vertikal: 0.91			

QF – Schütze hat sich fürs Finale qualifiziert

Unterschrift des Schuetzen

Meyton Elektronik

Ergebnis: **412.7** (393)  
 Serien: 102.1 103.6 104.3 102.7  
 Zaehler: 33 7 0 0 0 0 0 0 0 0  
 Innenzehner: 29  
 weiteste: 338 (38), 331 (37), 307 (39)  
 beste Teiler 16.4 (36.) 50.6 (21.) 68.1 (11.)  
 Trefferlage 0.29 mm rechts, 0.15 mm hoch  
 Streuwert 1.26, horizontal: 1.36, vertikal: 1.15

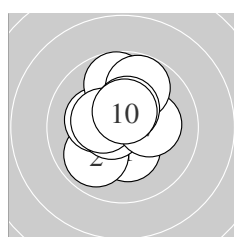
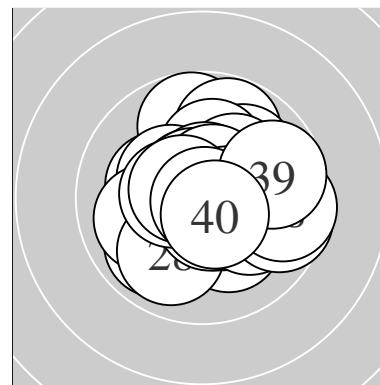

Serie 1:  
 10.3 \* 9.9 ↙ 10.2 \* 10.6 \* 9.8 ↑  
 10.4 \* 10.2 \* 9.8 ↑ 10.4 \* 10.5 \*  
 beste Teiler 76.0 (4.) 109.8 (10.) 131.7 (9.)  
 Trefferlage 0.24 mm links, 0.58 mm hoch  
 Streuwert 1.40, horizontal: 1.22, vertikal: 1.57

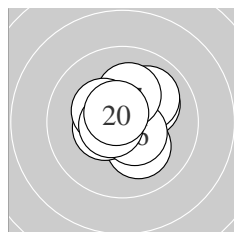

Serie 2:  
 10.7 \* 10.2 \* 10.1 ↗ 10.4 \* 10.0 ↗  
 10.5 \* 10.2 \* 10.3 \* 10.6 \* 10.6 \*  
 beste Teiler 68.1 (11.) 76.8 (20.) 82.7 (19.)  
 Trefferlage 0.15 mm rechts, 0.26 mm hoch  
 Streuwert 1.15, horizontal: 1.16, vertikal: 1.14

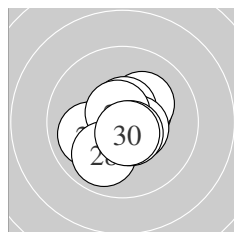

Serie 3:  
 10.8 \* 10.4 \* 10.2 \* 10.6 \* 10.5 \*  
 10.0 ← 10.7 \* 9.9 ↙ 10.6 \* 10.6 \*  
 beste Teiler 50.6 (21.) 74.7 (27.) 83.3 (30.)  
 Trefferlage 0.10 mm rechts, 0.14 mm tief  
 Streuwert 1.09, horizontal: 1.13, vertikal: 1.06

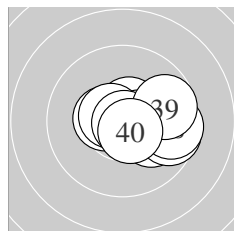

Serie 4:  
 10.5 \* 10.6 \* 10.5 \* 10.1 ↘ 10.6 \*  
 10.9 \* 9.6 → 9.6 → 9.7 → 10.6 \*  
 beste Teiler 16.4 (36.) 87.0 (40.) 88.6 (35.)  
 Trefferlage 1.16 mm rechts, 0.07 mm tief  
 Streuwert 1.25, horizontal: 1.64, vertikal: 0.66

Unterschrift des Schuetzen



Ergebnis: **410.5** (394)  
 Serien: 104.0 103.2 101.0 102.3  
 Zaehler: 34 6 0 0 0 0 0 0 0 0  
 Innenzehner: 29  
 weiteste: 427 (20), 418 (27), 388 (24)  
 beste Teiler 22.6 (12.) 55.0 (17.) 57.2 (15.)  
 Trefferlage 0.07 mm links, 0.05 mm hoch  
 Streuwert 1.41, horizontal: 1.52, vertikal: 1.29

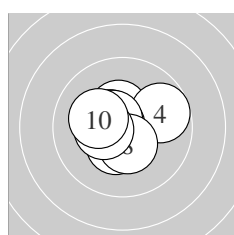
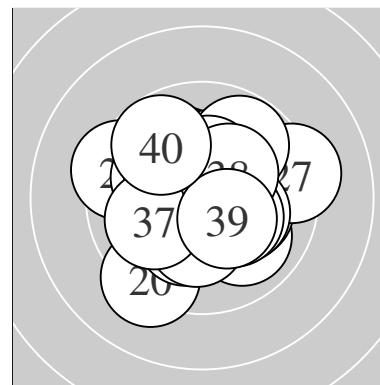

Serie 1:  
 10.4 \*                      10.7 \*                      10.4 \*                      9.7 ↗                      10.7 \*  
 10.5 \*                      10.6 \*                      10.4 \*                      10.4 \*                      10.2 \*  
 beste Teiler 58.6 (5.) 66.4 (2.) 91.0 (7.)  
 Trefferlage 0.29 mm links, 0.08 mm hoch  
 Streuwert 1.11, horizontal: 1.28, vertikal: 0.92

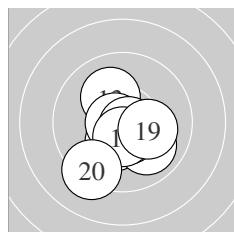

Serie 2:  
 10.3 \*                      10.9 \*                      10.1 ↖                      10.0 ↘                      10.7 \*  
 10.6 \*                      10.7 \*                      10.5 \*                      10.2 \*                      9.2 ↙  
 beste Teiler 22.6 (12.) 55.0 (17.) 57.2 (15.)  
 Trefferlage 0.00 mm , 0.79 mm tief  
 Streuwert 1.33, horizontal: 1.26, vertikal: 1.39

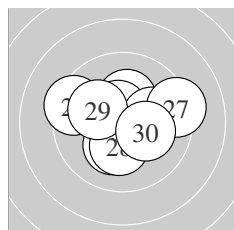

Serie 3:  
 10.2 \*                      10.3 \*                      10.6 \*                      9.4 ↖                      10.6 \*  
 10.1 →                      9.3 →                      10.2 \*                      10.1 ↖                      10.2 \*  
 beste Teiler 80.7 (23.) 96.2 (25.) 174.9 (22.)  
 Trefferlage 0.11 mm rechts, 0.28 mm hoch  
 Streuwert 1.76, horizontal: 2.16, vertikal: 1.24

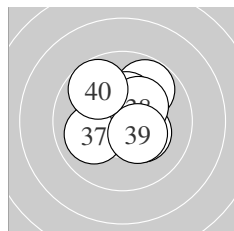

Serie 4:  
 10.5 \*                      10.4 \*                      9.8 ↗                      10.4 \*                      10.5 \*  
 10.3 \*                      10.0 ↖                      10.3 \*                      10.4 \*                      9.7 ↘  
 beste Teiler 102.8 (31.) 114.6 (35.) 138.9 (32.)  
 Trefferlage 0.10 mm links, 0.64 mm hoch  
 Streuwert 1.35, horizontal: 1.43, vertikal: 1.27

Unterschrift des Schuetzen

Meyton Elektronik

Ergebnis: **416.7** (397)<sup>QF</sup>  
 Serien: 103.3 104.3 104.0 105.1  
 Zaehler: 37 3 0 0 0 0 0 0 0 0  
 Innenzehner: 35  
 weiteste: 345 (8), 301 (27), 277 (15)  
 beste Teiler 15.8 (37.) 34.0 (20.) 41.2 (10.)  
 Trefferlage 0.06 mm links, 0.47 mm tief  
 Streuwert 1.04, horizontal: 1.25, vertikal: 0.77

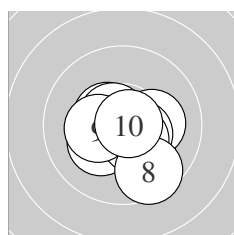
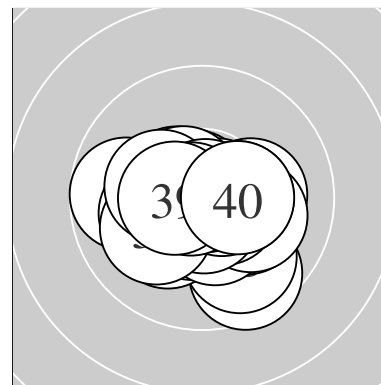

Serie 1:  
 10.5 \*                      10.2 \*                      10.6 \*                      10.2 \*                      10.2 \*  
 10.5 \*                      10.4 \*                      9.6 ↘                      10.3 \*                      10.8 \*  
 beste Teiler 41.2 (10.) 84.3 (3.) 117.8 (1.)  
 Trefferlage 0.25 mm rechts, 0.58 mm tief  
 Streuwert 1.21, horizontal: 1.32, vertikal: 1.08

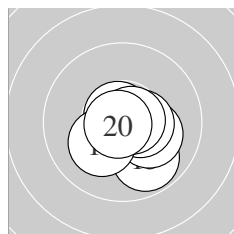

Serie 2:  
 10.5 \*                      10.5 \*                      10.4 \*                      10.7 \*                      9.8 ↘  
 10.2 \*                      10.5 \*                      10.7 \*                      10.2 \*                      10.8 \*  
 beste Teiler 34.0 (20.) 55.2 (14.) 59.2 (18.)  
 Trefferlage 0.25 mm rechts, 0.68 mm tief  
 Streuwert 0.96, horizontal: 1.08, vertikal: 0.81

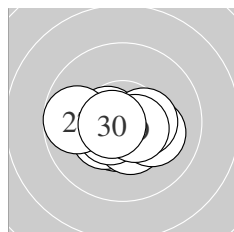

Serie 3:  
 10.5 \*                      10.6 \*                      10.4 \*                      10.4 \*                      10.6 \*  
 10.1 →                      9.7 ←                      10.4 \*                      10.6 \*                      10.7 \*  
 beste Teiler 71.5 (30.) 93.0 (29.) 98.7 (22.)  
 Trefferlage 0.23 mm links, 0.46 mm tief  
 Streuwert 1.08, horizontal: 1.45, vertikal: 0.49

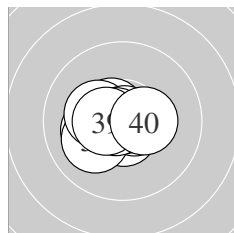

Serie 4:  
 10.7 \*                      10.2 \*                      10.6 \*                      10.1 ↙                      10.3 \*  
 10.6 \*                      10.9 \*                      10.8 \*                      10.5 \*                      10.4 \*  
 beste Teiler 15.8 (37.) 44.1 (38.) 75.4 (31.)  
 Trefferlage 0.51 mm links, 0.15 mm tief  
 Streuwert 0.88, horizontal: 1.12, vertikal: 0.55

QF – Schütze hat sich fürs Finale qualifiziert

Unterschrift des Schuetzen

Meyton Elektronik

Ergebnis: **412.5** (394)

Serien: 104.8 102.5 102.7 102.5

Zaehler: 34 6 0 0 0 0 0 0 0 0

Innenzehner: 30

weiteste: 346 (31), 300 (17), 293 (23)

beste Teiler 20.0 (39.) 56.0 (2.) 57.0 (12.)

Trefferlage 0.26 mm rechts, 0.19 mm hoch

Streuwert 1.26, horizontal: 1.36, vertikal: 1.16

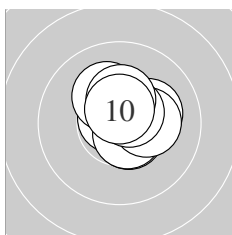
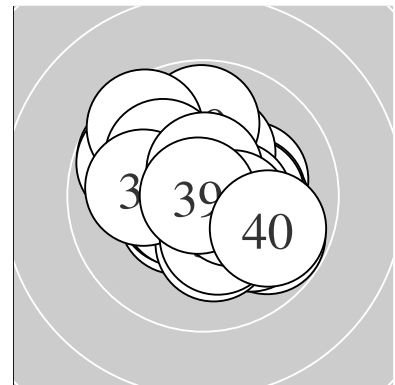

Serie 1:

10.6 *	10.7 *	10.2 *	10.7 *	10.2 *
10.6 *	10.3 *	10.6 *	10.3 *	10.6 *

beste Teiler 56.0 (2.) 75.7 (4.) 85.8 (6.)

Trefferlage 0.47 mm rechts, 0.41 mm hoch

Streuwert 0.85, horizontal: 0.85, vertikal: 0.85

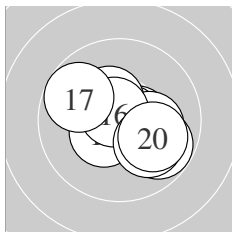

Serie 2:

10.5 *	10.7 *	10.4 *	10.2 *	10.4 *
10.7 *	9.8 ↘	9.8 ↘	10.0 ↘	10.0 ↘

beste Teiler 57.0 (12.) 63.2 (16.) 107.0 (11.)

Trefferlage 0.53 mm rechts, 0.20 mm tief

Streuwert 1.39, horizontal: 1.66, vertikal: 1.05

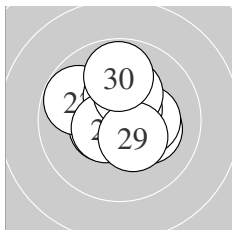

Serie 3:

10.2 *	10.5 *	9.8 ↘	10.3 *	10.3 *
10.6 *	10.6 *	10.2 *	10.4 *	9.8 ↑

beste Teiler 86.0 (26.) 100.3 (27.) 110.6 (22.)

Trefferlage 0.06 mm rechts, 0.54 mm hoch

Streuwert 1.30, horizontal: 1.34, vertikal: 1.25

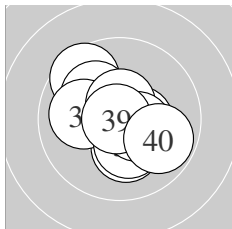

Serie 4:

9.6 ↘	10.1 ↘	10.2 *	10.5 *	10.0 ←
10.6 *	10.3 *	10.5 *	10.9 *	9.8 ↘

beste Teiler 20.0 (39.) 98.1 (36.) 120.7 (34.)

Trefferlage 0.04 mm links, 0.01 mm hoch

Streuwert 1.50, horizontal: 1.58, vertikal: 1.41

Unterschrift des Schuetzen

Meyton Elektronik

Ergebnis: **404.9** (386)  
 Serien: 99.4 100.9 102.3 102.3  
 Zaehler: 27 12 1 0 0 0 0 0 0 0  
 Innenzehner: 20  
 weiteste: 598 (9), 494 (12), 410 (38)  
 beste Teiler 29.6 (4.) 48.1 (21.) 70.0 (32.)  
 Trefferlage 0.32 mm links, 0.44 mm hoch  
 Streuwert 1.66, horizontal: 1.91, vertikal: 1.37

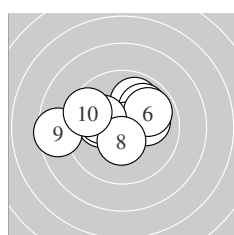
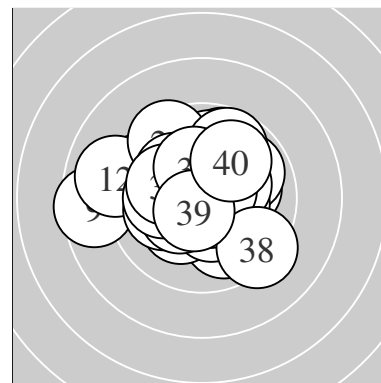

Serie 1:  
 10.2 \* 9.9 ↗ 9.9 ↗ 10.8 \* 10.1 →  
 9.9 ↗ 10.1 ↖ 10.4 \* 8.6 ← 9.5 ↖  
 beste Teiler 29.6 (4.) 126.4 (8.) 199.6 (1.)  
 Trefferlage 0.54 mm links, 0.68 mm hoch  
 Streuwert 2.06, horizontal: 2.70, vertikal: 1.09

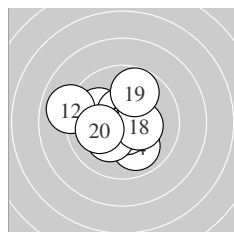

Serie 2:  
 10.0 ↖ 9.0 ↖ 10.6 \* 9.9 ↘ 10.6 \*  
 10.4 \* 10.2 \* 10.3 \* 9.8 ↗ 10.1 ←  
 beste Teiler 81.9 (15.) 92.6 (13.) 135.9 (16.)  
 Trefferlage 0.49 mm links, 0.01 mm hoch  
 Streuwert 1.78, horizontal: 2.06, vertikal: 1.44

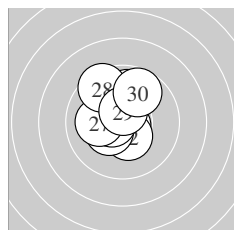

Serie 3:  
 10.8 \* 10.4 \* 10.4 \* 10.4 \* 10.6 \*  
 9.9 ↑ 10.1 ← 9.5 ↘ 10.5 \* 9.7 ↗  
 beste Teiler 48.1 (21.) 99.1 (25.) 102.1 (29.)  
 Trefferlage 0.47 mm links, 0.73 mm hoch  
 Streuwert 1.39, horizontal: 1.17, vertikal: 1.58

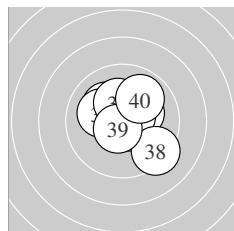

Serie 4:  
 10.2 \* 10.7 \* 10.5 \* 10.1 ↖ 10.6 \*  
 10.1 ↖ 10.3 \* 9.3 ↘ 10.6 \* 9.9 ↗  
 beste Teiler 70.0 (32.) 84.0 (39.) 90.4 (35.)  
 Trefferlage 0.21 mm rechts, 0.34 mm hoch  
 Streuwert 1.49, horizontal: 1.58, vertikal: 1.40

Unterschrift des Schuetzen

Meyton Elektronik

Ergebnis: **414.4** (398)  
 Serien: 102.1 104.4 102.8 105.1  
 Zaehler: 38 2 0 0 0 0 0 0 0 0  
 Innenzehner: 30  
 weiteste: 285 (28), 266 (8), 242 (5)  
 beste Teiler 22.2 (30.) 48.4 (29.) 50.2 (19.)  
 Trefferlage 0.34 mm rechts, 0.41 mm hoch  
 Streuwert 1.09, horizontal: 1.24, vertikal: 0.92

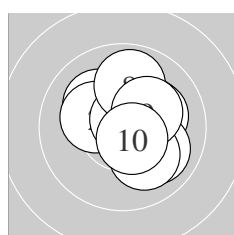
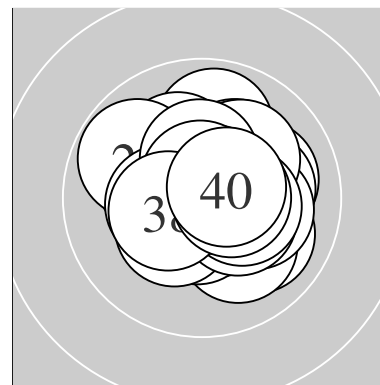

Serie 1:  
 10.1 ↘                      10.2 \*                      10.2 \*                      10.1 →                      10.0 ↘  
 10.7 \*                      10.1 ↘                      9.9 ↑                      10.2 \*                      10.6 \*  
 beste Teiler 53.1 (6.) 93.0 (10.) 179.5 (9.)  
 Trefferlage 0.64 mm rechts, 0.38 mm hoch  
 Streuwert 1.32, horizontal: 1.34, vertikal: 1.31

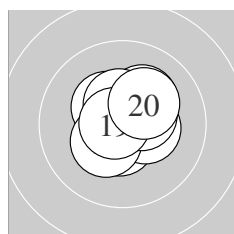

Serie 2:  
 10.6 \*                      10.2 \*                      10.5 \*                      10.4 \*                      10.4 \*  
 10.4 \*                      10.5 \*                      10.4 \*                      10.8 \*                      10.2 \*  
 beste Teiler 50.2 (19.) 86.9 (11.) 102.5 (13.)  
 Trefferlage 0.28 mm rechts, 0.39 mm hoch  
 Streuwert 0.96, horizontal: 0.98, vertikal: 0.94

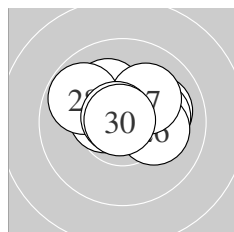

Serie 3:  
 10.0 →                      10.1 →                      10.5 \*                      10.3 \*                      10.2 \*  
 10.1 →                      10.1 ↗                      9.8 ↖                      10.8 \*                      10.9 \*  
 beste Teiler 22.2 (30.) 48.4 (29.) 115.5 (23.)  
 Trefferlage 0.14 mm rechts, 0.71 mm hoch  
 Streuwert 1.26, horizontal: 1.64, vertikal: 0.71

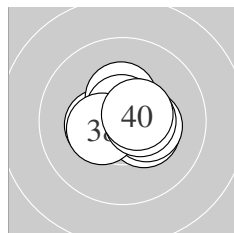

Serie 4:  
 10.3 \*                      10.4 \*                      10.4 \*                      10.3 \*                      10.8 \*  
 10.7 \*                      10.7 \*                      10.4 \*                      10.5 \*                      10.6 \*  
 beste Teiler 50.9 (35.) 65.9 (36.) 67.3 (37.)  
 Trefferlage 0.29 mm rechts, 0.14 mm hoch  
 Streuwert 0.85, horizontal: 1.02, vertikal: 0.64

Unterschrift des Schuetzen

Meyton Elektronik