

Ergebnis:	601.3	(573)						
Serien:	103.2	101.7	101.1	97.2	96.8	101.3		
Zähler:	35	23	2	0	0	0	0	0
Innenzehner:	31							
weiteste:	695 (49), 597 (31), 465 (4)							
beste Teiler	27.1 (9.) 72.0 (12.) 86.7 (14.)							
Trefferlage	0.50 mm links, 1.18 mm hoch							
Streuwert	1.69, horizontal: 1.72, vertikal: 1.66							

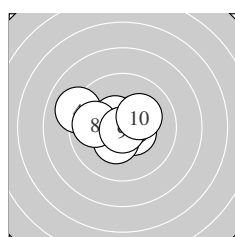

Serie 1:	10.6 *	10.5 *	10.6 *	9.1 ↖	10.6 *
	10.4 *	10.5 *	9.9 ←	10.8 *	10.2 *
beste Teiler	27.1 (9.) 90.6 (3.) 92.3 (1.)				
Trefferlage	0.34 mm links, 0.32 mm hoch				
Streuwert	1.45, horizontal: 1.87, vertikal: 0.85				

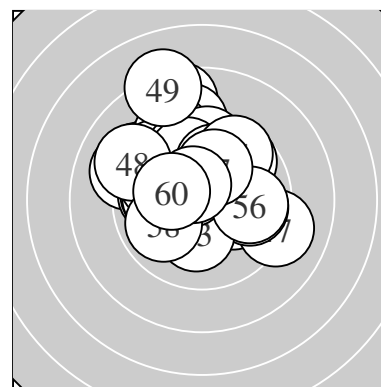
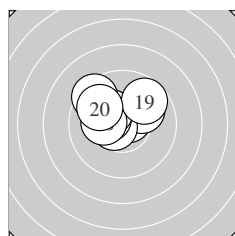

Serie 2:	10.5 *	10.7 *	10.0 ↗	10.6 *	10.4 *
	10.3 *	9.4 ↘	10.2 *	9.7 ↗	9.9 ↘
beste Teiler	72.0 (12.) 86.7 (14.) 108.4 (11.)				
Trefferlage	0.62 mm links, 1.07 mm hoch				
Streuwert	1.34, horizontal: 1.66, vertikal: 0.92				

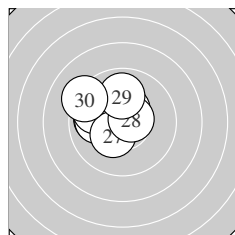

Serie 3:	10.5 *	9.9 ←	10.0 ←	10.4 *	9.8 ↖
	10.5 *	10.3 *	10.6 *	9.9 ↑	9.2 ↖
beste Teiler	88.2 (28.) 106.6 (26.) 122.7 (21.)				
Trefferlage	1.09 mm links, 0.88 mm hoch				
Streuwert	1.37, horizontal: 1.60, vertikal: 1.09				

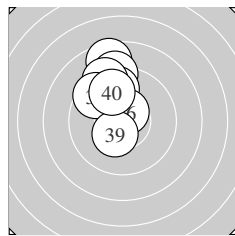

Serie 4:	8.6 ↑	10.0 ↑	10.3 *	9.1 ↑	9.7 ↑
	10.6 *	9.2 ↘	9.5 ↘	10.4 *	9.8 ↘
beste Teiler	96.2 (36.) 145.2 (39.) 154.4 (33.)				
Trefferlage	0.96 mm links, 2.61 mm hoch				
Streuwert	1.51, horizontal: 0.79, vertikal: 1.99				

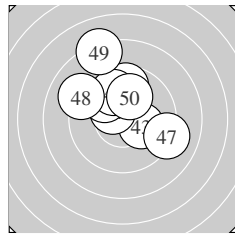

Serie 5:	9.7 ↑	10.2 *	10.2 *	10.5 *	9.9 ↖
	9.9 ↘	9.1 →	9.1 ↖	8.2 ↘	10.0 ↑
beste Teiler	122.4 (44.) 183.0 (42.) 193.5 (43.)				
Trefferlage	0.35 mm links, 1.87 mm hoch				
Streuwert	2.27, horizontal: 2.31, vertikal: 2.23				

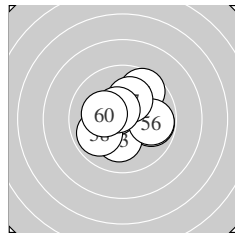

Serie 6:	10.5 *	9.8 →	10.2 *	9.6 ↗	10.6 *
	9.8 →	10.2 *	9.9 ↖	10.5 *	10.2 *
beste Teiler	96.2 (55.) 104.1 (59.) 118.6 (51.)				
Trefferlage	0.33 mm rechts, 0.35 mm hoch				
Streuwert	1.60, horizontal: 1.77, vertikal: 1.41				

Meyton Elektronik

ISSF AR Women – Wertung – Frauen

StandNr: 101

Wolf, Melissa #280

StartNr: 95

21. Januar 2019 13:36

VSB

Unterschrift des Schützen

Meyton Elektronik

Ergebnis:	623.4	(596)
Serien:	103.5	105.3 103.7 103.5 105.7 101.7
Zähler:	56	4 0 0 0 0 0 0 0 0
Innenzehner:	46	
weiteste:	367	(58), 302 (28), 288 (59)
beste Teiler	5.3	(11.) 23.6 (25.) 30.6 (50.)
Trefferlage	0.34	mm links, 0.10 mm hoch
Streuwert	1.12,	horizontal: 1.17, vertikal: 1.06

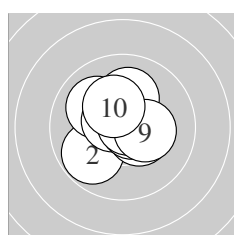
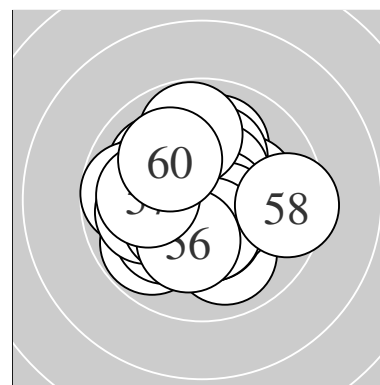

Serie 1:	10.5 *	9.8 ↙	10.0 ↘	10.6 *	10.4 *
	10.7 *	10.8 *	10.1 ↑	10.3 *	10.3 *
beste Teiler	46.1	(7.) 67.2 (6.)	86.8 (4.)		
Trefferlage	0.22	mm links, 0.27 mm hoch			
Streuwert	1.21,	horizontal: 1.28, vertikal: 1.15			

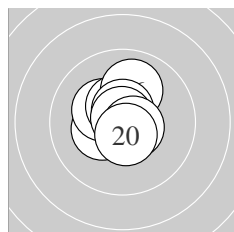

Serie 2:	10.9 *	10.3 *	10.7 *	10.3 *	10.5 *
	10.0 ↑	10.6 *	10.8 *	10.6 *	10.6 *
beste Teiler	5.3	(11.) 32.5 (18.)	52.3 (13.)		
Trefferlage	0.19	mm links, 0.42 mm hoch			
Streuwert	0.84,	horizontal: 0.75, vertikal: 0.93			

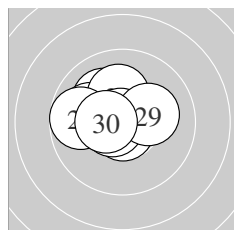

Serie 3:	10.1 ↘	10.0 ←	10.2 *	10.8 *	10.9 *
	10.7 *	10.6 *	9.7 ←	10.2 *	10.5 *
beste Teiler	23.6	(25.) 33.3 (24.)	55.0 (26.)		
Trefferlage	0.68	mm links, 0.44 mm hoch			
Streuwert	1.12,	horizontal: 1.38, vertikal: 0.78			

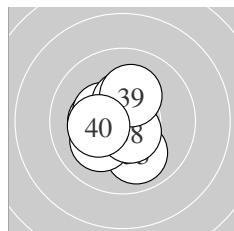

Serie 4:	10.7 *	10.3 *	10.0 ↘	10.6 *	10.4 *
	10.4 *	10.1 ↙	10.6 *	10.2 *	10.2 *
beste Teiler	75.0	(31.) 81.8 (34.)	94.8 (38.)		
Trefferlage	0.56	mm links, 0.17 mm tief			
Streuwert	1.13,	horizontal: 1.04, vertikal: 1.21			

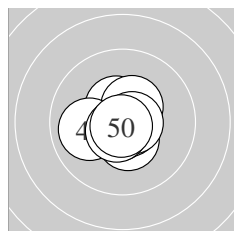

Serie 5:	10.8 *	10.4 *	10.5 *	10.7 *	10.8 *
	10.4 *	10.7 *	10.0 ←	10.6 *	10.8 *
beste Teiler	30.6	(50.) 42.2 (41.)	46.8 (45.)		
Trefferlage	0.19	mm links, 0.13 mm tief			
Streuwert	0.82,	horizontal: 0.89, vertikal: 0.74			

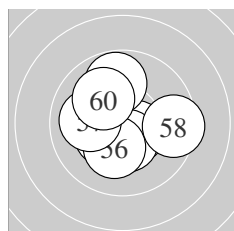

Serie 6:	10.5 *	10.4 *	10.3 *	10.5 *	10.4 *
	10.2 *	10.0 ←	9.5 →	9.8 ↑	10.1 ↘
beste Teiler	109.5	(54.) 114.2 (51.)	131.2 (55.)		
Trefferlage	0.20	mm links, 0.19 mm tief			
Streuwert	1.55,	horizontal: 1.64, vertikal: 1.45			

Meyton Elektronik

ISSF AR Women – Wertung – Frauen

StandNr: 102

Demjen, Peskova Daniela #70811321

StartNr: 96

21. Januar 2019 13:39

Police Sports Center Slovakia

Unterschrift des Schützen

Meyton Elektronik

Ergebnis: **613.5** (588)

Serien: 102.0 103.1 102.8 102.4 101.3 101.9

Zähler: 48 12 0 0 0 0 0 0 0

Innenzehner: 37

weiteste: 422 (53), 414 (43), 323 (9)

beste Teiler 42.0 (5.) 46.0 (42.) 51.8 (24.)

Trefferlage 0.14 mm rechts, 0.30 mm hoch

Streuwert 1.42, horizontal: 1.46, vertikal: 1.38

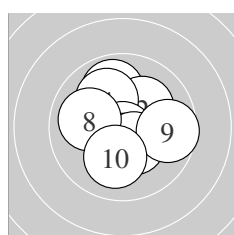
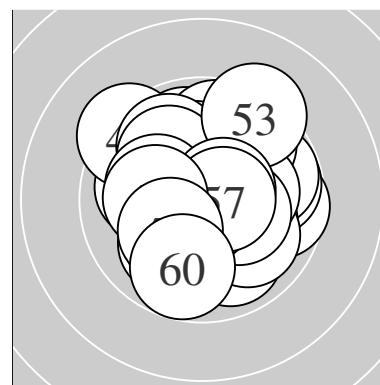

Serie 1:

9.9 ↗	10.2 *	10.4 *	10.1 ↘	10.8 *
10.4 *	10.4 *	10.0 ←	9.7 →	10.1 ↓

beste Teiler 42.0 (5.) 126.0 (6.) 140.0 (7.)

Trefferlage 0.03 mm links, 0.21 mm hoch

Streuwert 1.53, horizontal: 1.55, vertikal: 1.51

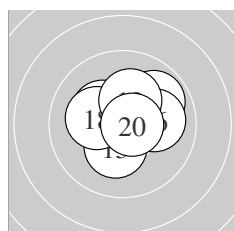

Serie 2:

10.2 *	10.7 *	10.3 *	10.3 *	9.9 ↗
10.0 →	10.6 *	10.2 *	10.2 *	10.7 *

beste Teiler 56.0 (12.) 68.1 (20.) 90.4 (17.)

Trefferlage 0.44 mm rechts, 0.48 mm hoch

Streuwert 1.20, horizontal: 1.42, vertikal: 0.93

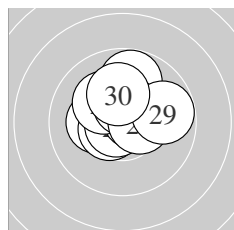

Serie 3:

10.2 *	9.8 ↑	10.5 *	10.7 *	10.6 *
10.2 *	10.4 *	10.5 *	9.8 →	10.1 ↑

beste Teiler 51.8 (24.) 85.0 (25.) 105.1 (23.)

Trefferlage 0.07 mm rechts, 0.77 mm hoch

Streuwert 1.23, horizontal: 1.36, vertikal: 1.09

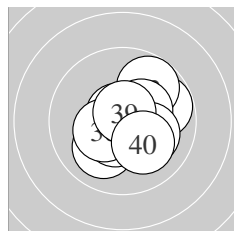

Serie 4:

9.8 →	9.8 ↗	10.7 *	10.3 *	10.1 ↘
10.0 ↙	10.5 *	10.4 *	10.7 *	10.1 ↘

beste Teiler 58.8 (33.) 64.3 (39.) 114.0 (37.)

Trefferlage 0.57 mm rechts, 0.07 mm tief

Streuwert 1.39, horizontal: 1.44, vertikal: 1.33

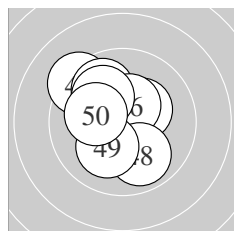

Serie 5:

10.4 *	10.8 *	9.3 ↘	10.3 *	9.9 ↘
10.4 *	10.0 ↘	9.9 ↓	10.1 ↙	10.2 *

beste Teiler 46.0 (42.) 128.3 (46.) 140.2 (41.)

Trefferlage 0.69 mm links, 0.63 mm hoch

Streuwert 1.53, horizontal: 1.40, vertikal: 1.65

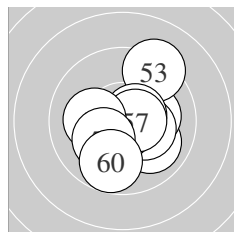

Serie 6:

10.0 ↘	10.2 *	9.3 ↗	10.3 *	10.7 *
10.6 *	10.6 *	10.2 *	10.2 *	9.8 ↓

beste Teiler 52.0 (55.) 90.0 (57.) 98.8 (56.)

Trefferlage 0.52 mm rechts, 0.22 mm tief

Streuwert 1.59, horizontal: 1.50, vertikal: 1.68

ISSF AR Women – Wertung – Frauen

StandNr: 103

Auer, Katharina #13

StartNr: 97

21. Januar 2019 13:06

T – SG Roppen

Unterschrift des Schützen

Meyton Elektronik

Ergebnis:	620.2	(593)							
Serien:	102.7	105.8	102.6	102.9	101.9	104.3			
Zähler:	53	7	0	0	0	0	0	0	0
Innenzehner:	45								
weiteste:	345 (9),	286 (46),	281 (49)						
beste Teiler	13.6 (18.)	18.0 (15.)	47.0 (14.)						
Trefferlage	0.17 mm links, 0.18 mm tief								
Streuwert	1.19, horizontal: 1.13, vertikal: 1.25								

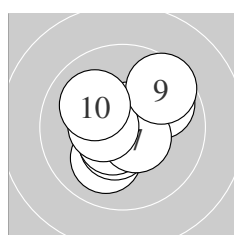
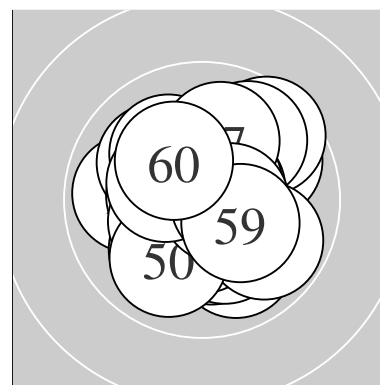

Serie 1:					
	9.8 ↗	10.3 *	10.1 ↘	10.7 *	10.5 *
	10.6 *	10.5 *	10.5 *	9.6 ↗	10.1 ↖
beste Teiler	69.8 (4.) 99.6 (6.) 105.6 (7.)				
Trefferlage	0.00 mm , 0.00 mm				
Streuwert	1.45, horizontal: 1.46, vertikal: 1.44				

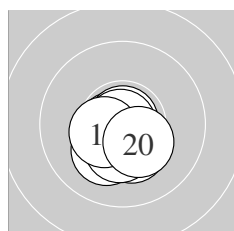

Serie 2:					
	10.3 *	10.2 *	10.7 *	10.8 *	10.9 *
	10.7 *	10.4 *	10.9 *	10.5 *	10.4 *
beste Teiler	13.6 (18.) 18.0 (15.) 47.0 (14.)				
Trefferlage	0.15 mm links, 0.73 mm tief				
Streuwert	0.65, horizontal: 0.66, vertikal: 0.65				

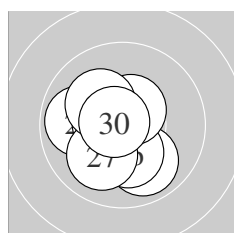

Serie 3:					
	10.3 *	9.9 ↘	9.9 ←	10.6 *	10.3 *
	10.2 *	10.0 ↘	10.5 *	10.2 *	10.7 *
beste Teiler	56.6 (30.) 94.0 (24.) 109.1 (28.)				
Trefferlage	0.65 mm links, 0.58 mm tief				
Streuwert	1.21, horizontal: 1.13, vertikal: 1.27				

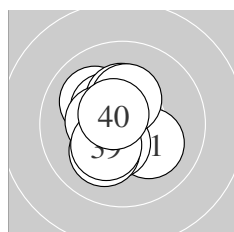

Serie 4:					
	10.1 ↘	10.4 *	10.0 ↖	10.4 *	10.3 *
	10.3 *	10.1 ↘	10.4 *	10.3 *	10.6 *
beste Teiler	85.6 (40.) 131.1 (32.) 141.0 (38.)				
Trefferlage	0.56 mm links, 0.09 mm hoch				
Streuwert	1.17, horizontal: 0.99, vertikal: 1.33				

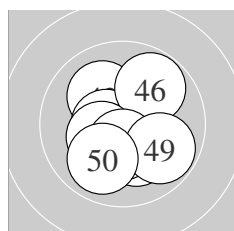

Serie 5:					
	10.2 *	10.1 ↖	10.5 *	10.4 *	10.5 *
	9.8 ↗	10.3 *	10.4 *	9.8 ↘	9.9 ↘
beste Teiler	103.1 (43.) 116.8 (45.) 130.0 (48.)				
Trefferlage	0.02 mm links, 0.51 mm tief				
Streuwert	1.43, horizontal: 1.40, vertikal: 1.46				

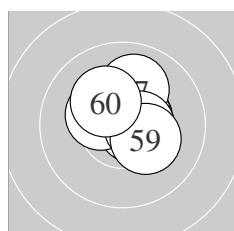

Serie 6:					
	10.7 *	10.5 *	10.7 *	10.6 *	10.5 *
	10.3 *	10.0 ↑	10.5 *	10.3 *	10.2 *
beste Teiler	68.6 (51.) 74.1 (53.) 86.8 (54.)				
Trefferlage	0.34 mm rechts, 0.59 mm hoch				
Streuwert	0.90, horizontal: 0.92, vertikal: 0.87				

Meyton Elektronik

ISSF AR Women – Wertung – Frauen

StandNr: 104

Guignard, Silvia #70811322

StartNr: 98

21. Januar 2019 13:36

SUI

Unterschrift des Schützen

Meyton Elektronik

Ergebnis:	597.3	(570)
Serien:	100.0 98.3 96.7 102.8 101.3 98.2	
Zähler:	34 22 4 0 0 0 0 0 0 0	
Innenzehner:	28	
weiteste:	629 (24), 580 (25), 527 (7)	
beste Teiler	33.9 (33.) 45.6 (50.) 57.5 (36.)	
Trefferlage	0.04 mm rechts, 0.57 mm hoch	
Streuwert	2.01, horizontal: 2.39, vertikal: 1.54	

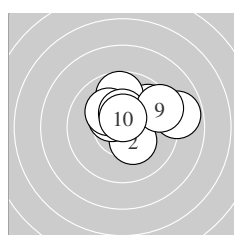
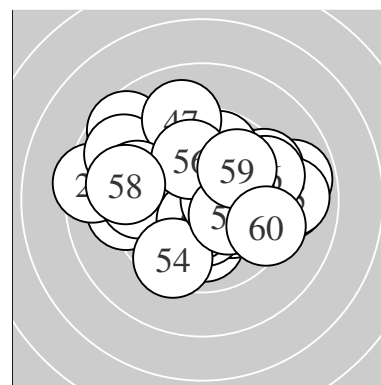

Serie 1:	9.8 ↗	10.3 *	10.4 *	10.4 *	9.7 ↑
	10.2 *	8.8 →	10.4 *	9.4 ↗	10.6 *
beste Teiler	88.0 (10.)	135.0 (8.)	135.3 (4.)		
Trefferlage	0.95 mm rechts, 1.24 mm hoch				
Streuwert	1.66, horizontal: 2.09, vertikal: 1.08				

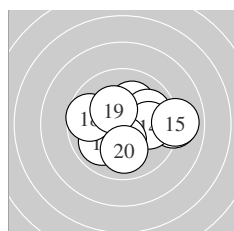

Serie 2:	9.0 →	10.1 ↗	9.9 ↗	10.0 →	9.0 →
	10.4 *	9.9 ↙	9.7 ←	10.3 *	10.0 ↓
beste Teiler	147.0 (16.)	161.5 (19.)	202.1 (12.)		
Trefferlage	0.97 mm rechts, 0.05 mm tief				
Streuwert	2.14, horizontal: 2.68, vertikal: 1.39				

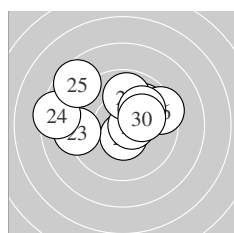

Serie 3:	9.9 ↗	10.5 *	9.2 ←	8.4 ←	8.6 ↖
	9.4 →	10.6 *	9.9 ↑	10.0 ↗	10.2 *
beste Teiler	86.0 (27.)	107.3 (22.)	193.7 (30.)		
Trefferlage	0.44 mm links, 1.11 mm hoch				
Streuwert	2.56, horizontal: 3.29, vertikal: 1.49				

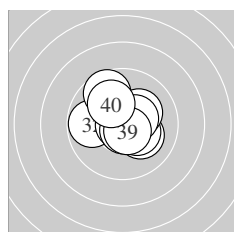

Serie 4:	10.2 *	9.8 ←	10.8 *	9.7 ↖	10.3 *
	10.7 *	10.2 *	10.4 *	10.6 *	10.1 ↖
beste Teiler	33.9 (33.)	57.5 (36.)	78.8 (39.)		
Trefferlage	0.05 mm rechts, 0.33 mm hoch				
Streuwert	1.39, horizontal: 1.50, vertikal: 1.28				

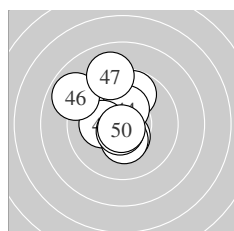

Serie 5:	9.8 ↑	10.5 *	10.5 *	10.4 *	10.2 *
	8.9 ↖	9.1 ↑	10.4 *	10.7 *	10.8 *
beste Teiler	45.6 (50.)	72.4 (49.)	121.2 (43.)		
Trefferlage	0.68 mm links, 0.85 mm hoch				
Streuwert	1.78, horizontal: 1.55, vertikal: 1.98				

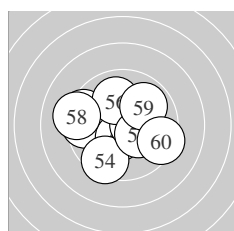

Serie 6:	9.4 ↖	9.5 ←	10.5 *	9.5 ↓	10.5 *
	10.0 ↑	10.3 *	9.2 ←	9.9 ↗	9.4 →
beste Teiler	103.0 (55.)	120.6 (53.)	171.5 (57.)		
Trefferlage	0.60 mm links, 0.06 mm tief				
Streuwert	2.24, horizontal: 2.69, vertikal: 1.68				

Meyton Elektronik

ISSF AR Women – Wertung – Frauen

StandNr: 105

Moser, Arinette #220

StartNr: 99

21. Januar 2019 13:48

VLSV

Unterschrift des Schützen

Meyton Elektronik

Ergebnis: **628.4** (597)^{QF}

Serien: 103.9 105.0 105.1 104.5 104.6 105.3

Zähler: 57 3 0 0 0 0 0 0 0 0

Innenzehner: 54

weiteste: 325 (12), 324 (10), 294 (4)

beste Teiler 11.4 (13.) 14.5 (18.) 22.0 (30.)

Trefferlage 0.00 mm , 0.00 mm

Streuwert 0.98, horizontal: 1.04, vertikal: 0.92

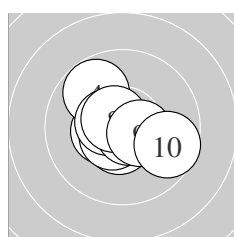
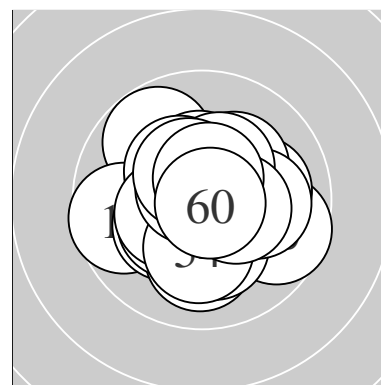

Serie 1:

10.5 *	10.4 *	10.6 *	9.8 ↖	10.6 *
10.5 *	10.7 *	10.6 *	10.5 *	9.7 ↗

beste Teiler 53.4 (7.) 79.2 (8.) 94.7 (5.)

Trefferlage 0.20 mm links, 0.07 mm tief

Streuwert 1.22, horizontal: 1.42, vertikal: 1.00

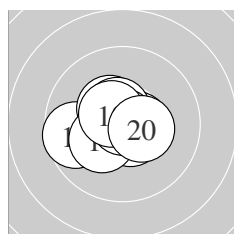

Serie 2:

10.6 *	9.7 ←	10.9 *	10.4 *	10.6 *
10.3 *	10.6 *	10.9 *	10.6 *	10.4 *

beste Teiler 11.4 (13.) 14.5 (18.) 81.5 (15.)

Trefferlage 0.38 mm links, 0.00 mm

Streuwert 1.03, horizontal: 1.28, vertikal: 0.71

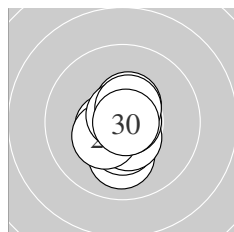

Serie 3:

10.5 *	10.0 ↓	10.4 *	10.5 *	10.5 *
10.3 *	10.7 *	10.8 *	10.5 *	10.9 *

beste Teiler 22.0 (30.) 38.4 (28.) 52.3 (27.)

Trefferlage 0.07 mm links, 0.33 mm tief

Streuwert 0.86, horizontal: 0.58, vertikal: 1.07

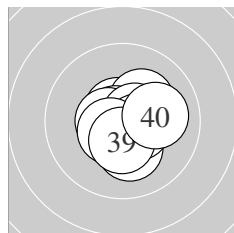

Serie 4:

10.6 *	10.2 *	10.8 *	10.6 *	10.6 *
10.2 *	10.5 *	10.5 *	10.4 *	10.1 →

beste Teiler 49.0 (33.) 78.2 (31.) 88.0 (35.)

Trefferlage 0.31 mm rechts, 0.14 mm tief

Streuwert 0.98, horizontal: 1.02, vertikal: 0.93

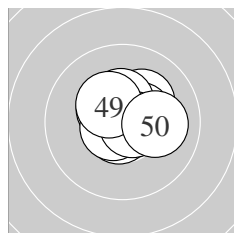

Serie 5:

10.7 *	10.5 *	10.7 *	10.4 *	10.2 *
10.5 *	10.4 *	10.7 *	10.4 *	10.1 →

beste Teiler 64.0 (41.) 67.9 (48.) 73.4 (43.)

Trefferlage 0.21 mm rechts, 0.51 mm hoch

Streuwert 0.92, horizontal: 1.05, vertikal: 0.77

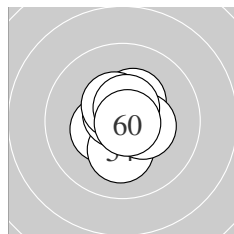

Serie 6:

10.4 *	10.6 *	10.7 *	10.2 *	10.7 *
10.4 *	10.5 *	10.4 *	10.6 *	10.8 *

beste Teiler 35.4 (60.) 52.6 (53.) 65.0 (55.)

Trefferlage 0.09 mm rechts, 0.02 mm tief

Streuwert 0.87, horizontal: 0.75, vertikal: 0.98

Meyton Elektronik

ISSF AR Women – Wertung – Frauen

StandNr: 106

Vinita, Bhardwaj #70811323

StartNr: 100

21. Januar 2019 13:36

IND

QF – Schütze hat sich fürs Finale qualifiziert

Unterschrift des Schützen

Meyton Elektronik

Ergebnis: **598.6** (571)
 Serien: 97.4 98.8 101.1 99.3 100.9 101.1
 Zähler: 31 29 0 0 0 0 0 0 0
 Innenzehner: 21
 weiteste: 471 (55), 449 (10), 443 (9)
 beste Teiler 42.5 (13.) 52.4 (6.) 52.7 (50.)
 Trefferlage 0.40 mm links, 0.14 mm hoch
 Streuwert 1.91, horizontal: 2.15, vertikal: 1.64

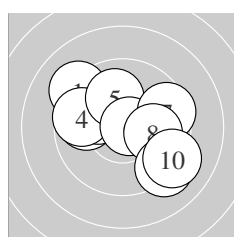
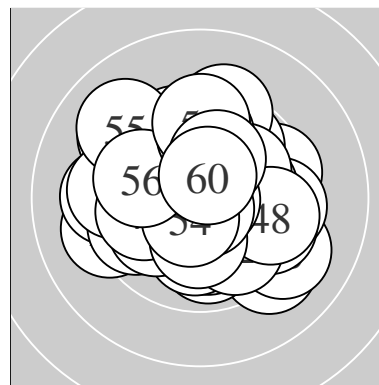

Serie 1:
 9.2 ↘ 9.8 ← 10.1 ↘ 9.7 ← 10.0 ↑
 10.7 * 9.5 → 10.0 → 9.2 ↘ 9.2 ↘
 beste Teiler 52.4 (6.) 209.2 (3.) 231.8 (5.)
 Trefferlage 0.14 mm rechts, 0.25 mm hoch
 Streuwert 2.42, horizontal: 2.87, vertikal: 1.85

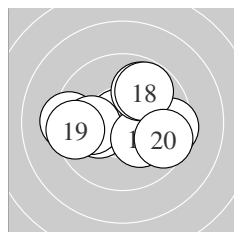

Serie 2:
 10.2 * 9.3 ← 10.8 * 10.0 ← 10.2 *
 9.9 ↑ 9.5 → 9.8 ↑ 9.5 ← 9.6 →
 beste Teiler 42.5 (13.) 180.4 (15.) 188.0 (11.)
 Trefferlage 0.11 mm links, 0.08 mm hoch
 Streuwert 2.15, horizontal: 2.75, vertikal: 1.29

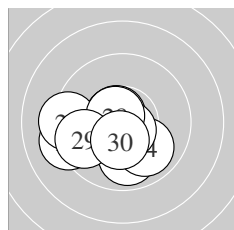

Serie 3:
 9.2 ← 10.6 * 9.9 ↓ 9.9 ↘ 10.7 *
 10.7 * 9.3 ← 10.7 * 9.7 ← 10.4 *
 beste Teiler 69.3 (26.) 73.0 (25.) 74.4 (28.)
 Trefferlage 1.07 mm links, 0.76 mm tief
 Streuwert 1.62, horizontal: 2.00, vertikal: 1.12

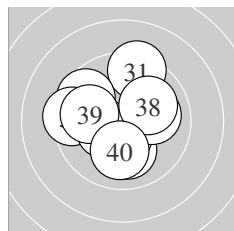

Serie 4:
 9.3 ↑ 9.6 ↘ 10.1 ↓ 10.5 * 9.4 ←
 10.4 * 10.0 → 10.0 → 9.9 ← 10.1 ↓
 beste Teiler 123.0 (34.) 146.6 (36.) 224.0 (33.)
 Trefferlage 0.51 mm links, 0.18 mm hoch
 Streuwert 1.98, horizontal: 2.08, vertikal: 1.88

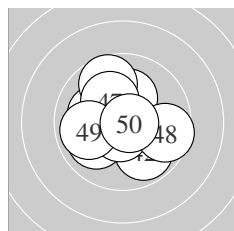

Serie 5:
 10.2 * 9.9 ↘ 10.1 ← 10.0 ← 9.7 ↑
 10.6 * 10.2 * 9.6 → 9.9 ← 10.7 *
 beste Teiler 52.7 (50.) 82.2 (46.) 187.9 (41.)
 Trefferlage 0.30 mm links, 0.10 mm hoch
 Streuwert 1.71, horizontal: 1.81, vertikal: 1.61

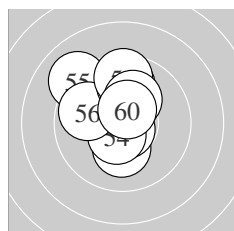

Serie 6:
 10.2 * 10.7 * 10.7 * 10.5 * 9.1 ↘
 9.8 ← 9.8 ↑ 9.6 ↑ 10.2 * 10.5 *
 beste Teiler 54.5 (52.) 70.2 (53.) 102.4 (54.)
 Trefferlage 0.56 mm links, 0.98 mm hoch
 Streuwert 1.63, horizontal: 1.39, vertikal: 1.85

ISSF AR Women – Wertung – Frauen

StandNr: 107

Callie, Siah Yong Xin #70811177

StartNr: 101

21. Januar 2019 13:38

SGP

Unterschrift des Schützen

Meyton Elektronik

Ergebnis:	601.2	(575)
Serien:	99.0	100.2 99.9 101.2 100.4 100.5
Zähler:	36 23 1 0 0 0 0 0 0	
Innenzehner:	26	
weiteste:	571 (43), 467 (45), 424 (18)	
beste Teiler	27.8 (36.) 58.0 (26.) 60.9 (8.)	
Trefferlage	0.31 mm links, 0.22 mm hoch	
Streuwert	1.84, horizontal: 1.98, vertikal: 1.69	

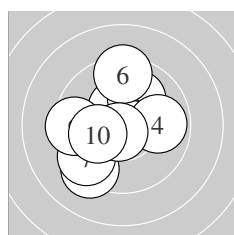
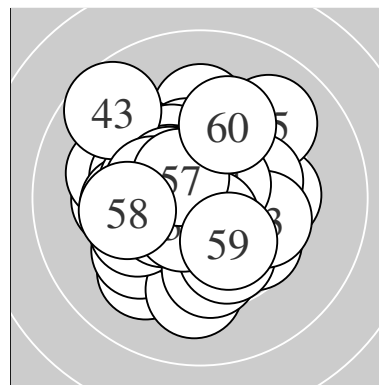

Serie 1:	10.2 *	10.4 *	10.0 ↗	9.9 →	9.3 ↙
	9.4 ↑	9.5 ↘	10.7 *	9.5 ←	10.1 ←
beste Teiler	60.9 (8.) 137.2 (2.) 184.0 (1.)				
Trefferlage	0.78 mm links, 0.21 mm hoch				
Streuwert	2.06, horizontal: 1.95, vertikal: 2.16				

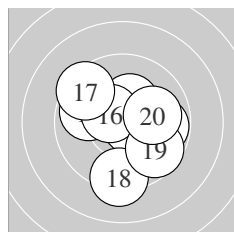

Serie 2:	9.8 →	10.5 *	10.7 *	10.3 *	9.9 ↖
	10.5 *	9.5 ↘	9.3 ↓	9.7 ↘	10.0 →
beste Teiler	73.6 (13.) 106.0 (12.) 117.0 (16.)				
Trefferlage	0.29 mm rechts, 0.01 mm tief				
Streuwert	1.95, horizontal: 2.01, vertikal: 1.89				

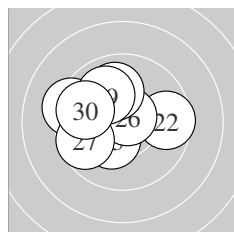

Serie 3:	10.4 *	9.6 →	10.3 *	9.3 ↖	10.2 *
	10.7 *	9.7 ↘	10.0 ↑	10.0 ↘	9.7 ↖
beste Teiler	58.0 (26.) 136.3 (21.) 161.2 (23.)				
Trefferlage	1.18 mm links, 0.46 mm hoch				
Streuwert	1.70, horizontal: 2.04, vertikal: 1.27				

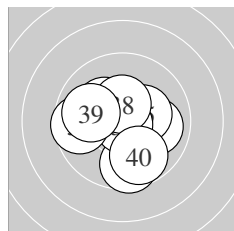

Serie 4:	10.2 *	10.6 *	10.0 →	9.6 ↓	10.3 *
	10.8 *	9.6 ←	10.4 *	9.9 ↖	9.8 ↘
beste Teiler	27.8 (36.) 83.6 (32.) 130.0 (38.)				
Trefferlage	0.19 mm links, 0.26 mm tief				
Streuwert	1.67, horizontal: 1.79, vertikal: 1.55				

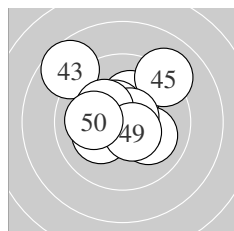

Serie 5:	10.2 *	10.5 *	8.7 ↘	10.2 *	9.1 ↗
	10.1 ↘	10.7 *	10.3 *	10.5 *	10.1 ←
beste Teiler	66.8 (47.) 106.7 (49.) 113.8 (42.)				
Trefferlage	0.28 mm links, 0.89 mm hoch				
Streuwert	1.95, horizontal: 2.13, vertikal: 1.76				

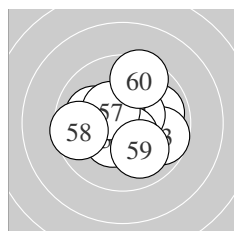

Serie 6:	9.9 →	10.0 ↖	9.7 ↘	10.5 *	10.5 *
	10.4 *	10.4 *	9.6 ←	10.0 ↘	9.5 ↗
beste Teiler	106.0 (55.) 120.2 (54.) 130.8 (57.)				
Trefferlage	0.23 mm rechts, 0.06 mm hoch				
Streuwert	1.79, horizontal: 2.01, vertikal: 1.53				

Meyton Elektronik

ISSF AR Women – Wertung – Frauen

StandNr: 108

Anlanger, Beatrice Carina #70811324

StartNr: 102

21. Januar 2019 13:23

OÖ – SV Laakirchen

Unterschrift des Schützen

Meyton Elektronik

Ergebnis:	626.8	(599)							
Serien:	105.0	104.0	104.0	103.7	104.7	105.4			
Zähler:	59	1	0	0	0	0	0	0	0
Innenzehner:	53								
weiteste:	273 (27), 239 (19), 230 (3)								
beste Teiler	14.4 (55.)	41.0 (43.)	41.8 (45.)						
Trefferlage	0.01 mm rechts, 0.15 mm hoch								
Streuwert	0.99, horizontal: 1.11, vertikal: 0.85								

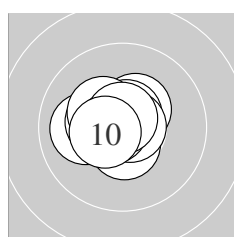
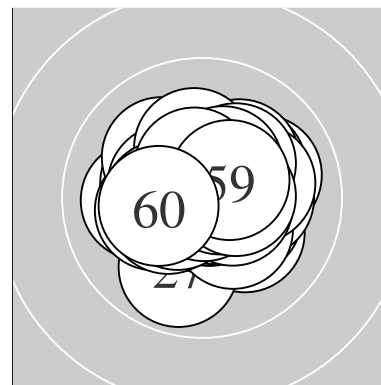

Serie 1:	10.4 *	10.5 *	10.0 ←	10.4 *	10.7 *
	10.8 *	10.3 *	10.7 *	10.7 *	10.5 *
beste Teiler	48.2 (6.) 56.3 (9.) 63.0 (8.)				
Trefferlage	0.50 mm links, 0.22 mm hoch				
Streuwert	0.83, horizontal: 0.98, vertikal: 0.64				

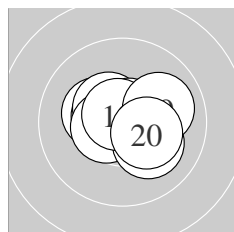

Serie 2:	10.3 *	10.5 *	10.5 *	10.5 *	10.1 ↘
	10.7 *	10.4 *	10.7 *	10.0 →	10.3 *
beste Teiler	57.1 (18.) 64.0 (16.) 103.8 (12.)				
Trefferlage	0.24 mm rechts, 0.10 mm hoch				
Streuwert	1.09, horizontal: 1.37, vertikal: 0.72				

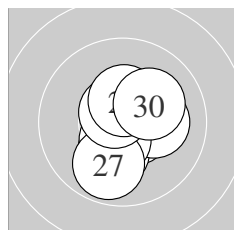

Serie 3:	10.6 *	10.8 *	10.6 *	10.2 *	10.2 *
	10.5 *	9.9 ↓	10.6 *	10.4 *	10.2 *
beste Teiler	48.3 (22.) 78.8 (28.) 81.8 (23.)				
Trefferlage	0.24 mm rechts, 0.17 mm tief				
Streuwert	1.15, horizontal: 0.96, vertikal: 1.31				

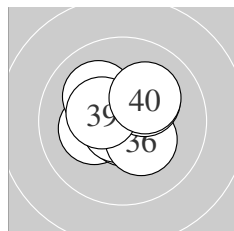

Serie 4:	10.6 *	10.2 *	10.7 *	10.3 *	10.8 *
	10.3 *	10.1 ↖	10.2 *	10.4 *	10.1 ↗
beste Teiler	46.0 (35.) 57.5 (33.) 82.2 (31.)				
Trefferlage	0.13 mm links, 0.33 mm hoch				
Streuwert	1.13, horizontal: 1.27, vertikal: 0.96				

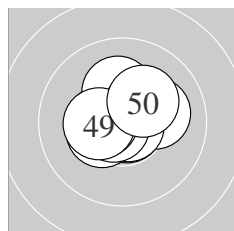

Serie 5:	10.7 *	10.4 *	10.8 *	10.1 →	10.8 *
	10.7 *	10.4 *	10.2 *	10.4 *	10.2 *
beste Teiler	41.0 (43.) 41.8 (45.) 61.7 (46.)				
Trefferlage	0.02 mm links, 0.23 mm hoch				
Streuwert	0.99, horizontal: 1.16, vertikal: 0.78				

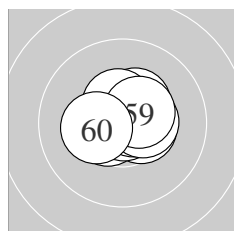

Serie 6:	10.5 *	10.5 *	10.7 *	10.4 *	10.9 *
	10.7 *	10.5 *	10.4 *	10.5 *	10.3 *
beste Teiler	14.4 (55.) 51.0 (53.) 68.2 (56.)				
Trefferlage	0.26 mm rechts, 0.20 mm hoch				
Streuwert	0.79, horizontal: 0.95, vertikal: 0.59				

Meyton Elektronik

ISSF AR Women – Wertung – Frauen

StandNr: 109

McIntosh, Seonaid #70811325

StartNr: 103

21. Januar 2019 13:38

GBR

Unterschrift des Schützen

Meyton Elektronik

Ergebnis: **626.6** (597)
 Serien: 104.1 104.1 104.6 104.0 104.1 105.7
 Zähler: 57 3 0 0 0 0 0 0 0 0
 Innenzehner: 55
 weiteste: 278 (10), 269 (36), 253 (37)
 beste Teiler 22.2 (59.) 26.6 (41.) 52.3 (17.)
 Trefferlage 0.01 mm rechts, 0.15 mm hoch
 Streuwert 0.98, horizontal: 1.12, vertikal: 0.82

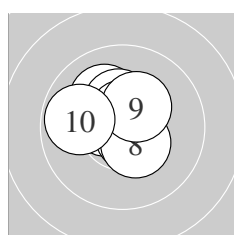
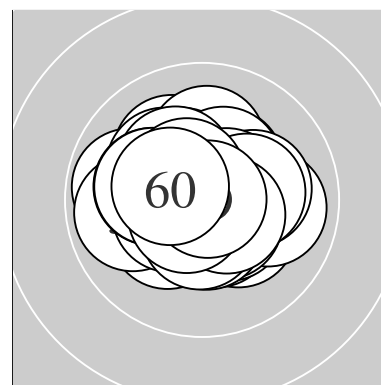

Serie 1:
 10.5 * 10.6 * 10.1 ↗ 10.4 * 10.6 *
 10.7 * 10.7 * 10.4 * 10.3 * 9.8 ←
 beste Teiler 55.5 (6.) 75.0 (7.) 79.3 (5.)
 Trefferlage 0.23 mm links, 0.52 mm hoch
 Streuwert 1.02, horizontal: 1.13, vertikal: 0.90

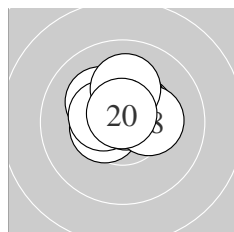

Serie 2:
 10.2 * 10.5 * 10.5 * 10.4 * 10.4 *
 10.3 * 10.7 * 10.3 * 10.1 ↑ 10.7 *
 beste Teiler 52.3 (17.) 55.3 (20.) 119.2 (12.)
 Trefferlage 0.03 mm links, 0.80 mm hoch
 Streuwert 0.88, horizontal: 1.00, vertikal: 0.74

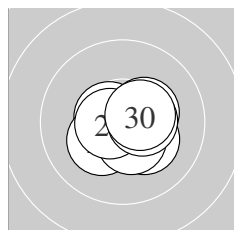

Serie 3:
 10.2 * 10.6 * 10.4 * 10.6 * 10.5 *
 10.3 * 10.5 * 10.6 * 10.4 * 10.5 *
 beste Teiler 81.6 (28.) 82.2 (24.) 92.1 (22.)
 Trefferlage 0.24 mm rechts, 0.34 mm tief
 Streuwert 0.90, horizontal: 1.07, vertikal: 0.71

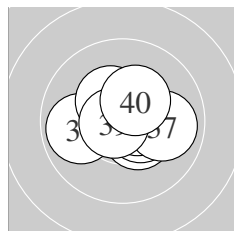

Serie 4:
 10.6 * 10.4 * 10.5 * 10.7 * 10.6 *
 9.9 ← 9.9 → 10.4 * 10.7 * 10.3 *
 beste Teiler 55.3 (39.) 55.5 (34.) 77.8 (31.)
 Trefferlage 0.29 mm rechts, 0.05 mm hoch
 Streuwert 1.12, horizontal: 1.40, vertikal: 0.76

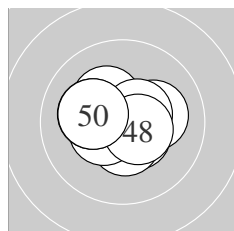

Serie 5:
 10.8 * 10.5 * 10.5 * 10.2 * 10.4 *
 10.3 * 10.5 * 10.5 * 10.2 * 10.2 *
 beste Teiler 26.6 (41.) 105.5 (47.) 108.6 (48.)
 Trefferlage 0.13 mm links, 0.03 mm hoch
 Streuwert 1.08, horizontal: 1.33, vertikal: 0.76

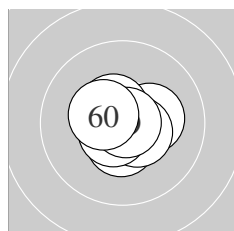

Serie 6:
 10.6 * 10.5 * 10.3 * 10.5 * 10.7 *
 10.5 * 10.7 * 10.6 * 10.9 * 10.4 *
 beste Teiler 22.2 (59.) 71.4 (55.) 72.6 (57.)
 Trefferlage 0.02 mm links, 0.13 mm tief
 Streuwert 0.77, horizontal: 0.91, vertikal: 0.60

Meyton Elektronik

ISSF AR Women – Wertung – Frauen

StandNr: 110

Karimova, Iuliia #70811326

StartNr: 104

21. Januar 2019 13:31

RUS

Unterschrift des Schützen

Meyton Elektronik

Ergebnis:	626.6	(597)							
Serien:	102.4	104.9	103.5	105.2	105.8	104.8			
Zähler:	57	3	0	0	0	0	0	0	0
Innenzehner:	52								
weiteste:	442	(8), 339	(54), 277	(23)					
beste Teiler	4.2	(35.)	6.7	(5.)	30.0	(38.)			
Trefferlage	0.06	mm rechts,	0.17	mm hoch					
Streuwert	1.06,	horizontal: 1.15,	vertikal: 0.96						

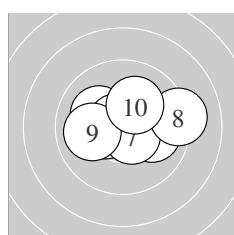
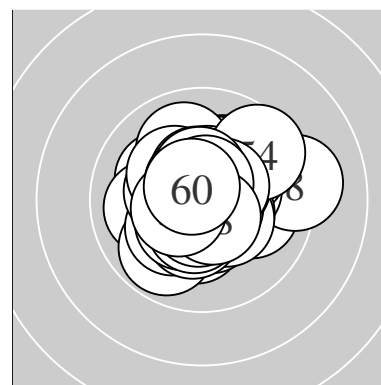

Serie 1:	10.1 ↖	10.3 *	10.4 *	10.0 →	10.9 *	
	10.7 *	10.6 *	9.2 →	10.0 ←	10.2 *	
beste Teiler	6.7	(5.)	58.8	(6.)	95.5	(7.)
Trefferlage	0.40	mm rechts,	0.21	mm hoch		
Streuwert	1.54,	horizontal: 2.05,	vertikal: 0.75			

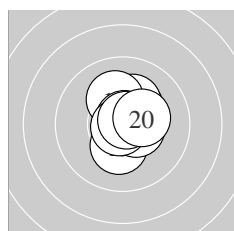

Serie 2:	10.7 *	10.3 *	10.2 *	10.2 *	10.3 *	
	10.8 *	10.5 *	10.8 *	10.8 *	10.3 *	
beste Teiler	33.3	(18.)	39.5	(16.)	43.1	(19.)
Trefferlage	0.39	mm rechts,	0.33	mm hoch		
Streuwert	0.90,	horizontal: 0.67,	vertikal: 1.08			

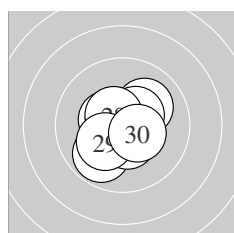

Serie 3:	10.1 ↗	10.4 *	9.8 ↙	10.4 *	10.6 *	
	10.6 *	10.5 *	10.5 *	10.2 *	10.4 *	
beste Teiler	77.2	(25.)	82.8	(26.)	102.6	(28.)
Trefferlage	0.10	mm links,	0.21	mm tief		
Streuwert	1.16,	horizontal: 1.17,	vertikal: 1.16			

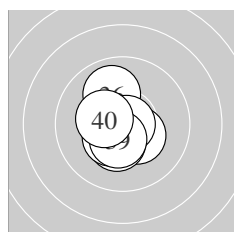

Serie 4:	10.4 *	10.7 *	10.4 *	10.4 *	10.9 *	
	10.0 ↕	10.7 *	10.8 *	10.5 *	10.4 *	
beste Teiler	4.2	(35.)	30.0	(38.)	55.9	(32.)
Trefferlage	0.36	mm links,	0.15	mm tief		
Streuwert	0.92,	horizontal: 0.71,	vertikal: 1.09			

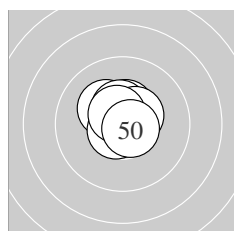

Serie 5:	10.7 *	10.8 *	10.5 *	10.2 *	10.6 *	
	10.5 *	10.5 *	10.7 *	10.6 *	10.7 *	
beste Teiler	46.3	(42.)	70.7	(48.)	71.1	(50.)
Trefferlage	0.06	mm links,	0.55	mm hoch		
Streuwert	0.66,	horizontal: 0.71,	vertikal: 0.60			

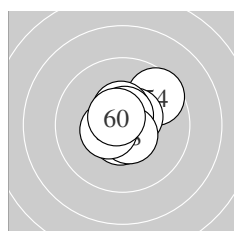

Serie 6:	10.6 *	10.7 *	10.6 *	9.6 ↗	10.5 *	
	10.5 *	10.6 *	10.6 *	10.5 *	10.6 *	
beste Teiler	56.6	(52.)	78.4	(60.)	78.6	(57.)
Trefferlage	0.09	mm rechts,	0.29	mm hoch		
Streuwert	1.01,	horizontal: 1.06,	vertikal: 0.97			

Meyton Elektronik

ISSF AR Women – Wertung – Frauen

StandNr: 111

Peer, Franziska #351

StartNr: 105

21. Januar 2019 13:26

AUT

Unterschrift des Schützen

Meyton Elektronik

Ergebnis: **628.5** (598)^{QF}
 Serien: 104.9 105.2 104.1 105.0 104.8 104.5
 Zähler: 58 2 0 0 0 0 0 0 0
 Innenzehner: 56
 weiteste: 279 (55), 251 (24), 250 (56)
 beste Teiler 24.1 (51.) 30.4 (12.) 30.5 (33.)
 Trefferlage 0.08 mm links, 0.24 mm hoch
 Streuwert 0.93, horizontal: 1.11, vertikal: 0.70

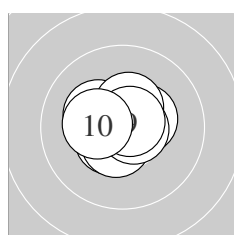
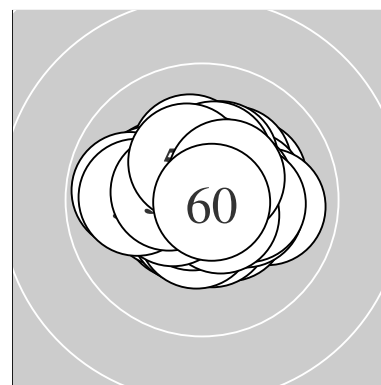

Serie 1:
 10.5 * 10.6 * 10.5 * 10.5 * 10.4 *
 10.3 * 10.7 * 10.4 * 10.7 * 10.3 *
 beste Teiler 59.8 (9.) 72.9 (7.) 79.1 (2.)
 Trefferlage 0.16 mm links, 0.24 mm hoch
 Streuwert 0.87, horizontal: 1.01, vertikal: 0.71

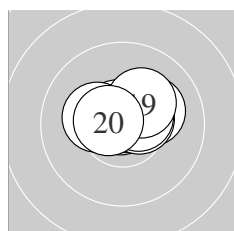

Serie 2:
 10.2 * 10.8 * 10.6 * 10.8 * 10.7 *
 10.3 * 10.5 * 10.5 * 10.2 * 10.6 *
 beste Teiler 30.4 (12.) 43.4 (14.) 68.6 (15.)
 Trefferlage 0.28 mm rechts, 0.57 mm hoch
 Streuwert 0.78, horizontal: 1.06, vertikal: 0.34

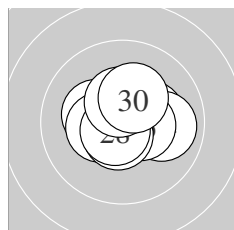

Serie 3:
 10.3 * 10.3 * 10.4 * 9.9 → 10.7 *
 10.5 * 10.6 * 10.7 * 10.4 * 10.3 *
 beste Teiler 64.3 (25.) 71.5 (28.) 86.9 (27.)
 Trefferlage 0.24 mm rechts, 0.20 mm hoch
 Streuwert 1.08, horizontal: 1.32, vertikal: 0.78

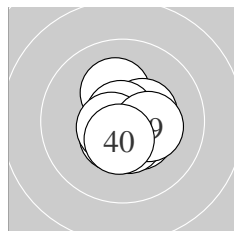

Serie 4:
 10.2 * 10.4 * 10.8 * 10.4 * 10.8 *
 10.5 * 10.5 * 10.6 * 10.3 * 10.5 *
 beste Teiler 30.5 (33.) 37.0 (35.) 82.3 (38.)
 Trefferlage 0.21 mm rechts, 0.19 mm tief
 Streuwert 0.88, horizontal: 0.83, vertikal: 0.94

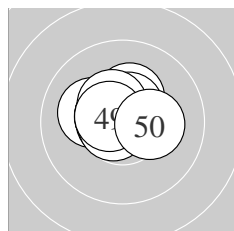

Serie 5:
 10.1 ← 10.3 * 10.7 * 10.6 * 10.6 *
 10.5 * 10.4 * 10.7 * 10.6 * 10.3 *
 beste Teiler 63.6 (48.) 74.0 (43.) 90.4 (49.)
 Trefferlage 0.38 mm links, 0.49 mm hoch
 Streuwert 0.81, horizontal: 1.00, vertikal: 0.57

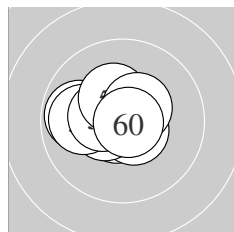

Serie 6:
 10.9 * 10.7 * 10.6 * 10.5 * 9.8 ←
 10.0 ← 10.4 * 10.3 * 10.5 * 10.8 *
 beste Teiler 24.1 (51.) 38.0 (60.) 58.4 (52.)
 Trefferlage 0.68 mm links, 0.17 mm hoch
 Streuwert 0.99, horizontal: 1.26, vertikal: 0.62

Meyton Elektronik

ISSF AR Women – Wertung – Frauen

StandNr: 112

Chandela, Arpuvi #70811327

StartNr: 106

21. Januar 2019 13:31

India

QF – Schütze hat sich fürs Finale qualifiziert

Unterschrift des Schützen

Meyton Elektronik

Ergebnis: **630.2** (599)^{QF}
 Serien: 105.0 105.2 105.4 104.4 106.4 103.8
 Zähler: 59 1 0 0 0 0 0 0 0
 Innenzehner: 58
 weiteste: 263 (51), 204 (39), 197 (49)
 beste Teiler 32.2 (46.) 41.1 (22.) 44.0 (47.)
 Trefferlage 0.18 mm rechts, 0.21 mm hoch
 Streuwert 0.86, horizontal: 0.91, vertikal: 0.81

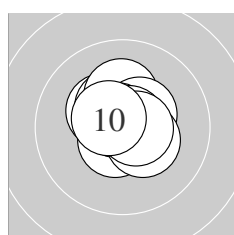
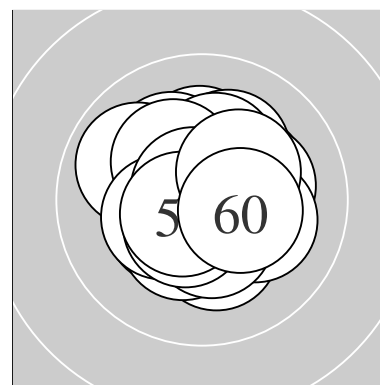

Serie 1:
 10.6 * 10.3 * 10.4 * 10.2 * 10.4 *
 10.7 * 10.4 * 10.8 * 10.6 * 10.6 *
 beste Teiler 44.6 (8.) 54.0 (6.) 80.3 (9.)
 Trefferlage 0.00 mm , 0.43 mm hoch
 Streuwert 0.83, horizontal: 0.82, vertikal: 0.83

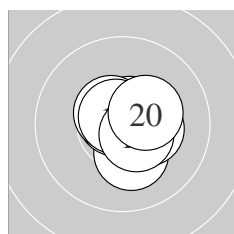

Serie 2:
 10.4 * 10.2 * 10.7 * 10.7 * 10.4 *
 10.7 * 10.6 * 10.7 * 10.5 * 10.3 *
 beste Teiler 54.2 (13.) 60.8 (18.) 72.8 (14.)
 Trefferlage 0.49 mm rechts, 0.04 mm hoch
 Streuwert 0.78, horizontal: 0.79, vertikal: 0.76

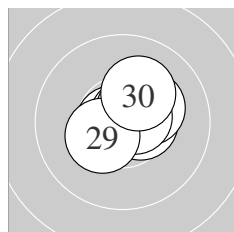

Serie 3:
 10.7 * 10.8 * 10.6 * 10.7 * 10.6 *
 10.5 * 10.3 * 10.6 * 10.4 * 10.2 *
 beste Teiler 41.1 (22.) 57.3 (21.) 70.2 (24.)
 Trefferlage 0.46 mm rechts, 0.38 mm hoch
 Streuwert 0.74, horizontal: 0.80, vertikal: 0.66

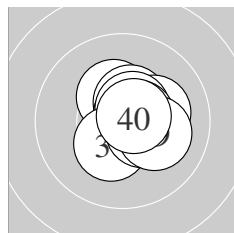

Serie 4:
 10.3 * 10.5 * 10.2 * 10.7 * 10.6 *
 10.3 * 10.6 * 10.4 * 10.1 → 10.7 *
 beste Teiler 60.8 (34.) 73.4 (40.) 92.6 (37.)
 Trefferlage 0.68 mm rechts, 0.20 mm hoch
 Streuwert 0.86, horizontal: 0.86, vertikal: 0.86

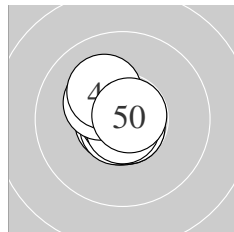

Serie 5:
 10.7 * 10.7 * 10.7 * 10.7 * 10.7 *
 10.8 * 10.8 * 10.3 * 10.2 * 10.8 *
 beste Teiler 32.2 (46.) 44.0 (47.) 45.6 (50.)
 Trefferlage 0.27 mm links, 0.02 mm hoch
 Streuwert 0.67, horizontal: 0.59, vertikal: 0.74

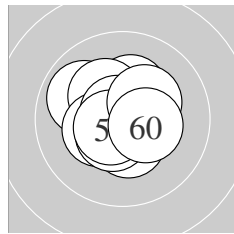

Serie 6:
 9.9 ↖ 10.3 * 10.3 * 10.4 * 10.3 *
 10.8 * 10.5 * 10.6 * 10.3 * 10.4 *
 beste Teiler 48.9 (56.) 87.4 (58.) 108.1 (57.)
 Trefferlage 0.28 mm links, 0.19 mm hoch
 Streuwert 1.12, horizontal: 1.18, vertikal: 1.06

Meyton Elektronik

ISSF AR Women – Wertung – Frauen

StandNr: 113

Hofmann, Olivia #222

StartNr: 107

21. Januar 2019 13:46

AUT

QF – Schütze hat sich fürs Finale qualifiziert

Unterschrift des Schützen

Meyton Elektronik

Ergebnis: **621.8** (594)

Serien: 101.2 102.5 103.8 104.8 105.3 104.2

Zähler: 54 6 0 0 0 0 0 0 0 0

Innenzehner: 48

weiteste: 490 (3), 361 (14), 342 (17)

beste Teiler 10.0 (56.) 28.1 (20.) 34.0 (41.)

Trefferlage 0.10 mm links, 0.20 mm hoch

Streuwert 1.22, horizontal: 1.51, vertikal: 0.84

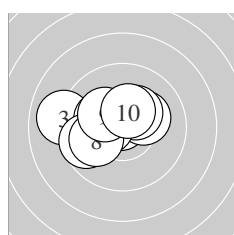
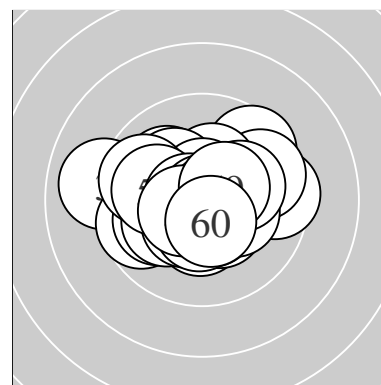

Serie 1:

10.8 *	10.2 *	9.0 ←	10.3 *	10.2 *
10.4 *	9.7 ←	10.0 ←	10.2 *	10.4 *

beste Teiler 36.6 (1.) 132.0 (6.) 140.4 (10.)

Trefferlage 1.15 mm links, 0.40 mm hoch

Streuwert 1.53, horizontal: 1.98, vertikal: 0.86

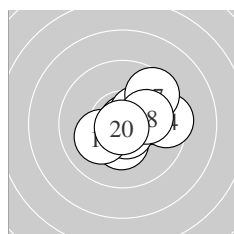

Serie 2:

10.8 *	10.2 *	10.3 *	9.5 →	10.7 *
10.4 *	9.6 ↗	10.1 →	10.1 ←	10.8 *

beste Teiler 28.1 (20.) 34.8 (11.) 67.9 (15.)

Trefferlage 0.96 mm rechts, 0.14 mm hoch

Streuwert 1.34, horizontal: 1.54, vertikal: 1.10

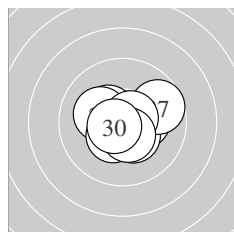

Serie 3:

10.7 *	10.4 *	10.2 *	10.3 *	10.4 *
10.4 *	9.7 →	10.6 *	10.5 *	10.6 *

beste Teiler 61.2 (21.) 76.0 (30.) 76.4 (28.)

Trefferlage 0.15 mm rechts, 0.05 mm tief

Streuwert 1.17, horizontal: 1.43, vertikal: 0.84

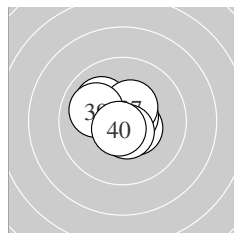

Serie 4:

10.5 *	10.5 *	10.6 *	10.6 *	10.8 *
10.1 ↘	10.4 *	10.6 *	10.0 ↘	10.7 *

beste Teiler 39.3 (35.) 70.2 (40.) 79.6 (34.)

Trefferlage 0.30 mm links, 0.35 mm hoch

Streuwert 0.94, horizontal: 1.07, vertikal: 0.79

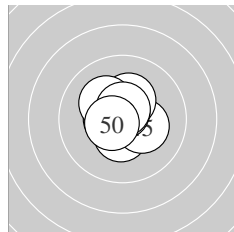

Serie 5:

10.8 *	10.8 *	10.4 *	10.6 *	10.3 *
10.3 *	10.2 *	10.7 *	10.6 *	10.6 *

beste Teiler 34.0 (41.) 42.5 (42.) 60.0 (48.)

Trefferlage 0.12 mm links, 0.23 mm hoch

Streuwert 0.85, horizontal: 0.85, vertikal: 0.86

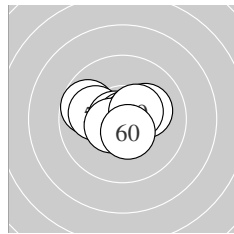

Serie 6:

10.6 *	9.7 ←	10.0 ←	10.7 *	10.2 *
10.9 *	10.7 *	10.5 *	10.4 *	10.5 *

beste Teiler 10.0 (56.) 53.0 (57.) 63.1 (54.)

Trefferlage 0.18 mm links, 0.15 mm hoch

Streuwert 1.13, horizontal: 1.48, vertikal: 0.61

Meyton Elektronik

ISSF AR Women – Wertung – Frauen

StandNr: 114

Martinez, Gabriela #70811328

StartNr: 108

21. Januar 2019 13:32

MEX

Unterschrift des Schützen

Meyton Elektronik

Ergebnis: **628.8** (597)^{QF}
 Serien: 105.5 104.0 103.6 104.2 105.8 105.7
 Zähler: 57 3 0 0 0 0 0 0 0
 Innenzehner: 54
 weiteste: 358 (24), 341 (31), 264 (27)
 beste Teiler 3.0 (49.) 18.4 (60.) 25.0 (3.)
 Trefferlage 0.01 mm links, 0.27 mm tief
 Streuwert 0.97, horizontal: 0.76, vertikal: 1.13

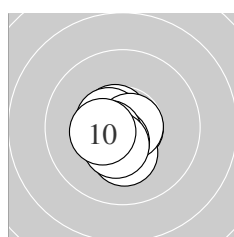
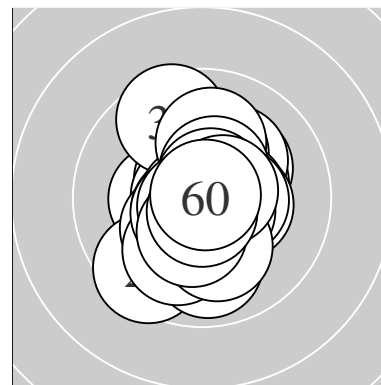

Serie 1:
 10.6 * 10.7 * 10.9 * 10.3 * 10.5 *
 10.7 * 10.5 * 10.5 * 10.4 * 10.4 *
 beste Teiler 25.0 (3.) 51.1 (6.) 51.4 (2.)
 Trefferlage 0.36 mm links, 0.35 mm tief
 Streuwert 0.69, horizontal: 0.62, vertikal: 0.76

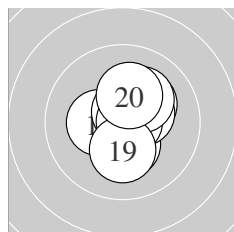

Serie 2:
 10.7 * 10.2 * 10.3 * 10.4 * 10.3 *
 10.7 * 10.8 * 10.2 * 10.2 * 10.2 *
 beste Teiler 46.2 (17.) 62.2 (11.) 71.3 (16.)
 Trefferlage 0.40 mm rechts, 0.30 mm hoch
 Streuwert 1.04, horizontal: 0.86, vertikal: 1.20

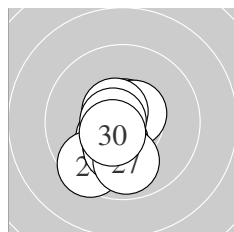

Serie 3:
 10.7 * 10.6 * 10.4 * 9.5 ✓ 10.4 *
 10.2 * 9.9 ↓ 10.6 * 10.7 * 10.6 *
 beste Teiler 65.2 (29.) 68.4 (21.) 89.6 (28.)
 Trefferlage 0.48 mm links, 0.83 mm tief
 Streuwert 1.09, horizontal: 0.78, vertikal: 1.33

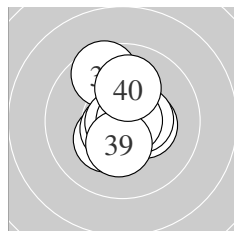

Serie 4:
 9.6 ↗ 10.4 * 10.8 * 10.3 * 10.6 *
 10.8 * 10.5 * 10.8 * 10.3 * 10.1 ↑
 beste Teiler 32.2 (36.) 34.6 (33.) 45.1 (38.)
 Trefferlage 0.02 mm links, 0.16 mm hoch
 Streuwert 1.21, horizontal: 0.90, vertikal: 1.46

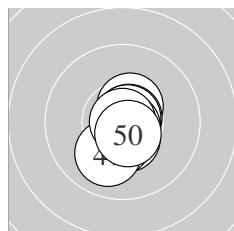

Serie 5:
 10.5 * 10.7 * 10.6 * 10.5 * 10.4 *
 10.8 * 10.0 ✓ 10.8 * 10.9 * 10.6 *
 beste Teiler 3.0 (49.) 43.4 (46.) 43.8 (48.)
 Trefferlage 0.10 mm rechts, 0.50 mm tief
 Streuwert 0.75, horizontal: 0.45, vertikal: 0.95

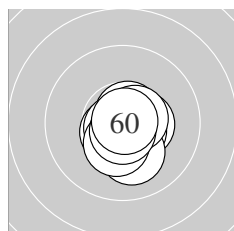

Serie 6:
 10.4 * 10.6 * 10.7 * 10.6 * 10.1 ↓
 10.7 * 10.4 * 10.6 * 10.7 * 10.9 *
 beste Teiler 18.4 (60.) 51.7 (56.) 55.0 (59.)
 Trefferlage 0.25 mm rechts, 0.44 mm tief
 Streuwert 0.70, horizontal: 0.63, vertikal: 0.76

Meyton Elektronik

ISSF AR Women – Wertung – Frauen

StandNr: 115

Moudgil, Anjum #70811329

StartNr: 109

21. Januar 2019 13:22

India

QF – Schütze hat sich fürs Finale qualifiziert

Unterschrift des Schützen

Meyton Elektronik

Ergebnis: **613.9** (592)

Serien: 102.0 103.1 102.7 102.6 102.3 101.2

Zähler: 52 8 0 0 0 0 0 0 0 0

Innenzehner: 40

weiteste: 488 (38), 416 (23), 415 (39)

beste Teiler 19.2 (34.) 41.8 (29.) 50.3 (31.)

Trefferlage 0.13 mm rechts, 0.26 mm hoch

Streuwert 1.43, horizontal: 1.58, vertikal: 1.26

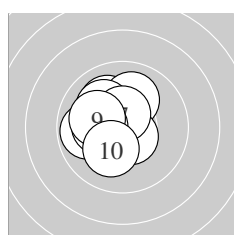
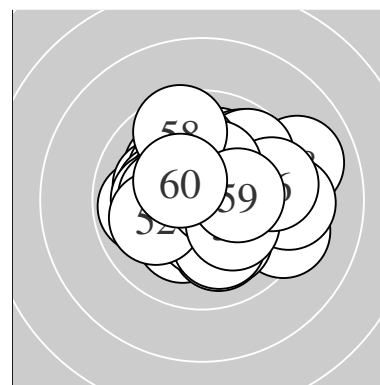

Serie 1:

10.1 ↘	10.0 ↑	10.1 ↘	10.6 *	10.4 *
9.8 ←	10.5 *	10.2 *	10.1 ↖	10.2 *

beste Teiler 96.0 (4.) 104.0 (7.) 145.3 (5.)

Trefferlage 1.02 mm links, 0.38 mm hoch

Streuwert 1.21, horizontal: 1.13, vertikal: 1.29

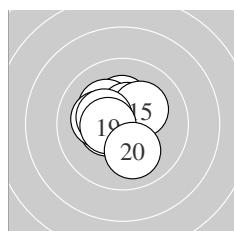

Serie 2:

10.3 *	10.3 *	10.2 *	10.5 *	10.2 *
10.5 *	10.2 *	10.3 *	10.5 *	10.1 ↓

beste Teiler 114.1 (14.) 116.6 (19.) 125.6 (16.)

Trefferlage 0.56 mm links, 0.49 mm hoch

Streuwert 1.11, horizontal: 1.11, vertikal: 1.12

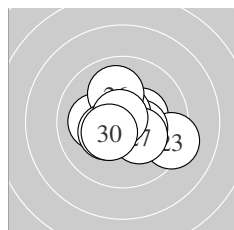

Serie 3:

10.1 ←	10.4 *	9.3 ↗	10.4 *	10.7 *
10.0 ↑	10.3 *	10.3 *	10.8 *	10.4 *

beste Teiler 41.8 (29.) 68.0 (25.) 133.4 (30.)

Trefferlage 0.26 mm rechts, 0.07 mm tief

Streuwert 1.46, horizontal: 1.75, vertikal: 1.09

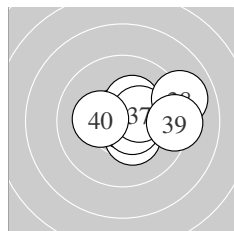

Serie 4:

10.8 *	10.7 *	10.4 *	10.9 *	10.3 *
10.6 *	10.4 *	9.0 ↗	9.3 →	10.2 *

beste Teiler 19.2 (34.) 50.3 (31.) 55.2 (32.)

Trefferlage 1.08 mm rechts, 0.24 mm hoch

Streuwert 1.49, horizontal: 1.92, vertikal: 0.87

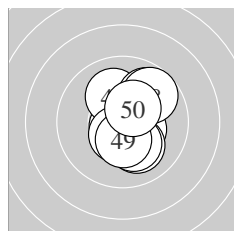

Serie 5:

10.4 *	10.7 *	10.1 ↖	10.1 ↓	9.8 ↗
10.5 *	10.2 *	9.7 ↗	10.4 *	10.4 *

beste Teiler 55.4 (42.) 108.6 (46.) 136.4 (50.)

Trefferlage 0.65 mm rechts, 0.05 mm hoch

Streuwert 1.35, horizontal: 1.01, vertikal: 1.62

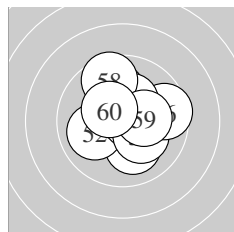

Serie 6:

10.1 ↓	10.0 ←	10.0 ↑	10.7 *	10.2 *
9.6 →	10.3 *	9.6 ↘	10.3 *	10.4 *

beste Teiler 61.6 (54.) 139.6 (60.) 168.7 (57.)

Trefferlage 0.37 mm rechts, 0.51 mm hoch

Streuwert 1.62, horizontal: 1.62, vertikal: 1.62

Meyton Elektronik

ISSF AR Women – Wertung – Frauen

StandNr: 116

Adams, Emma #70811330

StartNr: 110

21. Januar 2019 13:47

AUS

Unterschrift des Schützen

Meyton Elektronik

Ergebnis: **10.2** (10)
 Serien: 10.2
 Zähler: 1 0 0 0 0 0 0 0 0 0
 Innenzehner: 1
 weiteste: 181 (1)
 beste Teiler 181.8 (1.)
 Trefferlage 1.78 mm rechts, 0.37 mm hoch
 Streuwert

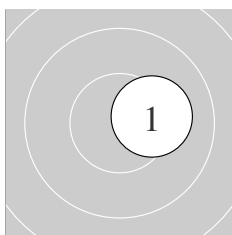
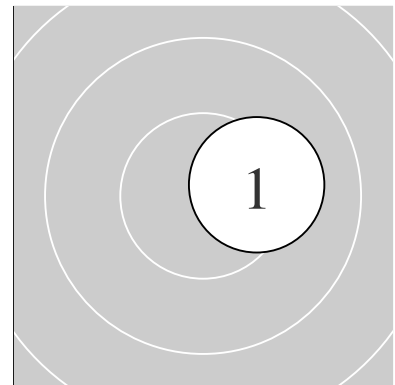

Serie 1:
 10.2 *
 beste Teiler 181.8 (1.)
 Trefferlage 1.78 mm rechts, 0.37 mm hoch
 Streuwert 0.00, horizontal: 0.00, vertikal: 0.00

Unterschrift des Schützen

Ergebnis: **619.1** (594)
 Serien: 103.6 101.1 104.2 103.2 102.9 104.1
 Zähler: 54 6 0 0 0 0 0 0 0
 Innenzehner: 46
 weiteste: 420 (19), 327 (20), 324 (45)
 beste Teiler 10.1 (54.) 41.1 (4.) 50.6 (30.)
 Trefferlage 0.06 mm rechts, 0.10 mm tief
 Streuwert 1.25, horizontal: 1.31, vertikal: 1.18

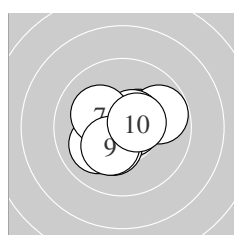
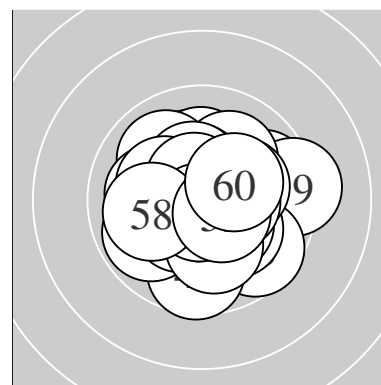

Serie 1:
 10.4 * 9.8 → 10.7 * 10.8 * 10.6 *
 10.0 ← 10.2 * 10.3 * 10.3 * 10.5 *
 beste Teiler 41.1 (4.) 64.0 (3.) 95.7 (5.)
 Trefferlage 0.08 mm rechts, 0.02 mm tief
 Streuwert 1.24, horizontal: 1.45, vertikal: 0.98

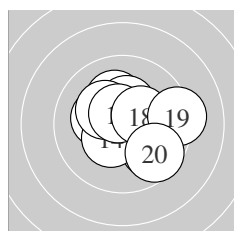

Serie 2:
 10.2 * 10.2 * 9.8 ↘ 10.4 * 10.4 *
 10.3 * 10.6 * 10.3 * 9.3 → 9.6 ↘
 beste Teiler 89.1 (17.) 137.6 (14.) 148.8 (15.)
 Trefferlage 0.54 mm rechts, 0.19 mm hoch
 Streuwert 1.67, horizontal: 1.91, vertikal: 1.39

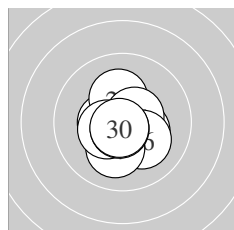

Serie 3:
 10.5 * 10.4 * 10.2 * 10.3 * 10.6 *
 10.2 * 10.1 ↓ 10.4 * 10.7 * 10.8 *
 beste Teiler 50.6 (30.) 55.9 (29.) 100.2 (25.)
 Trefferlage 0.04 mm rechts, 0.45 mm tief
 Streuwert 1.01, horizontal: 0.97, vertikal: 1.05

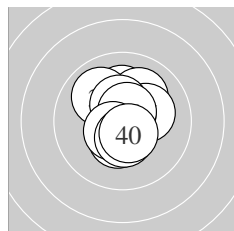

Serie 4:
 10.1 ↑ 10.1 ↗ 10.4 * 10.0 ↖ 10.2 *
 10.4 * 10.6 * 10.5 * 10.4 * 10.5 *
 beste Teiler 77.3 (37.) 103.3 (40.) 106.0 (38.)
 Trefferlage 0.08 mm rechts, 0.39 mm hoch
 Streuwert 1.18, horizontal: 0.97, vertikal: 1.36

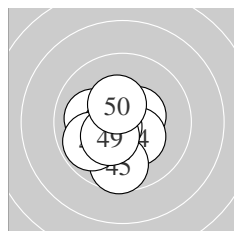

Serie 5:
 10.7 * 10.5 * 10.4 * 10.3 * 9.7 ↓
 10.1 ← 10.6 * 9.8 ← 10.4 * 10.4 *
 beste Teiler 59.2 (41.) 84.1 (47.) 116.8 (42.)
 Trefferlage 0.50 mm links, 0.59 mm tief
 Streuwert 1.24, horizontal: 1.17, vertikal: 1.32

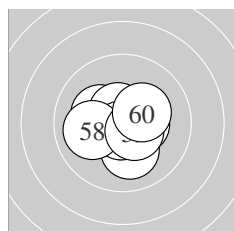

Serie 6:
 10.4 * 10.4 * 10.1 ↓ 10.9 * 10.2 *
 10.6 * 10.7 * 10.0 ← 10.5 * 10.3 *
 beste Teiler 10.1 (54.) 58.0 (57.) 90.4 (56.)
 Trefferlage 0.11 mm rechts, 0.10 mm tief
 Streuwert 1.11, horizontal: 1.29, vertikal: 0.88

Meyton Elektronik

ISSF AR Women – Wertung – Frauen

StandNr: 118

Brühlmann, Andrea #70811332

StartNr: 112

21. Januar 2019 13:48

SUI – TG

Unterschrift des Schützen

Meyton Elektronik

Ergebnis: **622.1** (594)

Serien: 102.2 104.0 104.0 101.8 105.5 104.6

Zähler: 54 6 0 0 0 0 0 0 0 0

Innenzehner: 47

weiteste: 332 (6), 300 (36), 299 (33)

beste Teiler 8.0 (25.) 18.3 (55.) 19.8 (50.)

Trefferlage 0.03 mm rechts, 0.10 mm hoch

Streuwert 1.17, horizontal: 1.17, vertikal: 1.17

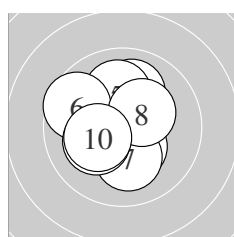
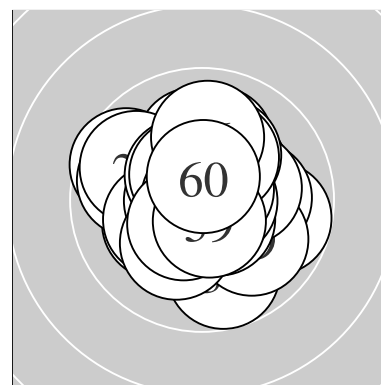

Serie 1:

10.0 ↑	10.4 *	10.8 *	10.5 *	10.1 ↑
9.6 ↖	10.1 ↓	10.3 *	10.2 *	10.2 *

beste Teiler 43.0 (3.) 102.6 (4.) 146.3 (2.)

Trefferlage 0.40 mm links, 0.34 mm hoch

Streuwert 1.41, horizontal: 1.33, vertikal: 1.48

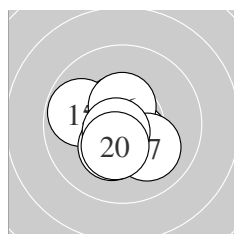

Serie 2:

10.7 *	10.5 *	10.6 *	10.5 *	9.8 ↖
10.5 *	10.1 ↘	10.3 *	10.7 *	10.3 *

beste Teiler 66.7 (19.) 67.1 (11.) 86.2 (13.)

Trefferlage 0.35 mm links, 0.20 mm tief

Streuwert 1.10, horizontal: 1.11, vertikal: 1.08

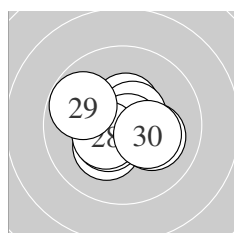

Serie 3:

10.2 *	10.5 *	10.5 *	10.1 ↗	10.9 *
10.6 *	10.8 *	10.4 *	9.8 ↖	10.2 *

beste Teiler 8.0 (25.) 39.8 (27.) 93.3 (26.)

Trefferlage 0.09 mm links, 0.12 mm tief

Streuwert 1.17, horizontal: 1.38, vertikal: 0.91

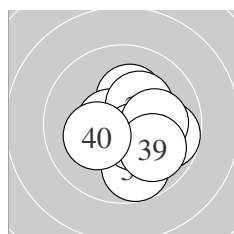

Serie 4:

10.2 *	10.4 *	9.8 ↗	10.6 *	10.3 *
9.8 ↓	10.5 *	10.1 →	9.9 ↘	10.2 *

beste Teiler 81.3 (34.) 118.1 (37.) 139.6 (32.)

Trefferlage 0.88 mm rechts, 0.27 mm tief

Streuwert 1.37, horizontal: 1.36, vertikal: 1.38

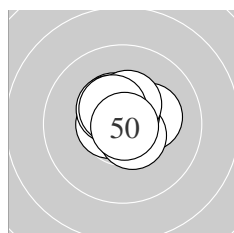

Serie 5:

10.8 *	10.6 *	10.4 *	10.2 *	10.4 *
10.6 *	10.7 *	10.4 *	10.5 *	10.9 *

beste Teiler 19.8 (50.) 49.3 (41.) 56.3 (47.)

Trefferlage 0.01 mm links, 0.49 mm hoch

Streuwert 0.73, horizontal: 0.81, vertikal: 0.65

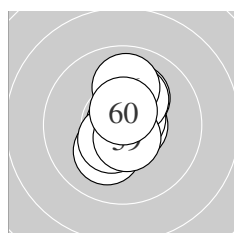

Serie 6:

10.7 *	10.2 *	10.7 *	10.2 *	10.9 *
10.0 ↑	10.2 *	10.5 *	10.6 *	10.6 *

beste Teiler 18.3 (55.) 74.0 (53.) 75.1 (51.)

Trefferlage 0.17 mm rechts, 0.38 mm hoch

Streuwert 1.06, horizontal: 0.65, vertikal: 1.35

Meyton Elektronik

ISSF AR Women – Wertung – Frauen

StandNr: 119

Molnar, Eliza #70811333

StartNr: 113

21. Januar 2019 13:46

ROU

Unterschrift des Schützen

Meyton Elektronik

Ergebnis: **625.6** (597)
 Serien: 104.3 104.5 104.9 105.0 104.2 102.7
 Zähler: 57 3 0 0 0 0 0 0 0 0
 Innenzehner: 53
 weiteste: 286 (49), 267 (19), 257 (57)
 beste Teiler 18.1 (45.) 34.7 (21.) 36.2 (14.)
 Trefferlage 0.02 mm links, 0.10 mm hoch
 Streuwert 1.04, horizontal: 0.92, vertikal: 1.14

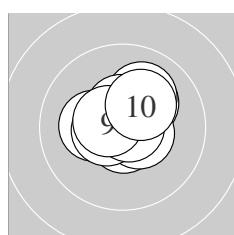
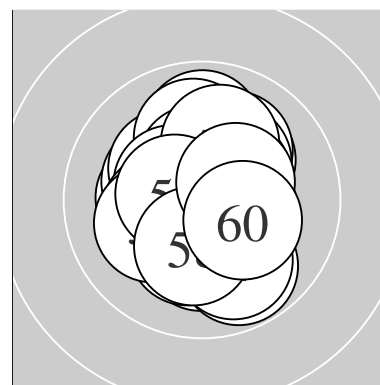

Serie 1:
 10.2 * 10.7 * 10.1 ↗ 10.5 * 10.5 *
 10.2 * 10.5 * 10.8 * 10.6 * 10.2 *
 beste Teiler 41.3 (8.) 66.3 (2.) 97.6 (9.)
 Trefferlage 0.13 mm rechts, 0.51 mm hoch
 Streuwert 0.99, horizontal: 1.08, vertikal: 0.89

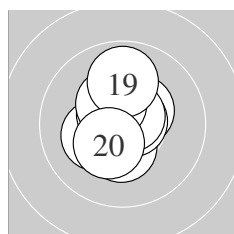

Serie 2:
 10.4 * 10.4 * 10.2 * 10.8 * 10.7 *
 10.6 * 10.7 * 10.4 * 9.9 ↑ 10.4 *
 beste Teiler 36.2 (14.) 61.6 (15.) 66.6 (17.)
 Trefferlage 0.20 mm links, 0.30 mm hoch
 Streuwert 1.03, horizontal: 0.79, vertikal: 1.22

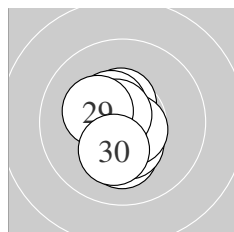

Serie 3:
 10.8 * 10.5 * 10.7 * 10.2 * 10.4 *
 10.6 * 10.5 * 10.7 * 10.3 * 10.2 *
 beste Teiler 34.7 (21.) 61.7 (28.) 71.1 (23.)
 Trefferlage 0.29 mm links, 0.22 mm tief
 Streuwert 0.92, horizontal: 0.62, vertikal: 1.14

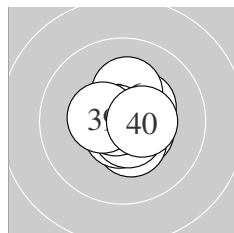

Serie 4:
 10.5 * 10.4 * 10.4 * 10.7 * 10.5 *
 10.2 * 10.6 * 10.8 * 10.4 * 10.5 *
 beste Teiler 43.2 (38.) 75.9 (34.) 79.6 (37.)
 Trefferlage 0.27 mm rechts, 0.06 mm hoch
 Streuwert 0.87, horizontal: 0.78, vertikal: 0.96

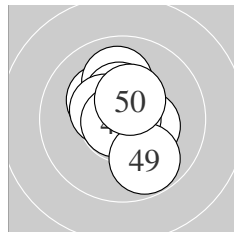

Serie 5:
 10.4 * 10.2 * 10.8 * 10.0 ↑ 10.9 *
 10.4 * 10.5 * 10.8 * 9.8 ↓ 10.4 *
 beste Teiler 18.1 (45.) 38.3 (43.) 43.0 (48.)
 Trefferlage 0.03 mm links, 0.36 mm hoch
 Streuwert 1.14, horizontal: 0.92, vertikal: 1.32

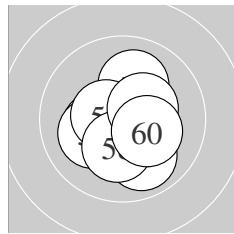

Serie 6:
 10.1 ↗ 10.6 * 10.3 * 10.3 * 10.1 ↖
 10.5 * 9.9 ↓ 10.2 * 10.4 * 10.3 *
 beste Teiler 97.9 (52.) 106.5 (56.) 143.5 (59.)
 Trefferlage 0.04 mm links, 0.43 mm tief
 Streuwert 1.28, horizontal: 1.31, vertikal: 1.24

Meyton Elektronik

ISSF AR Women – Wertung – Frauen

StandNr: 120

Pribitzer, Marlene #231

StartNr: 114

21. Januar 2019 13:48

AUT

Unterschrift des Schützen

Meyton Elektronik

Ergebnis:	621.5	(592)							
Serien:	101.8	104.5	104.4	102.7	104.6	103.5			
Zähler:	52	8	0	0	0	0	0	0	0
Innenzehner:	46								
weiteste:	358 (31), 322 (15), 314 (27)								
beste Teiler	6.4 (11.)	9.4 (17.)	12.0 (13.)						
Trefferlage	0.38 mm links, 0.42 mm hoch								
Streuwert	1.14, horizontal: 1.27, vertikal: 1.00								

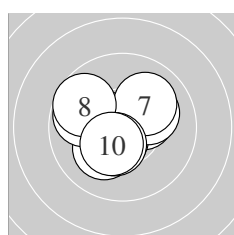
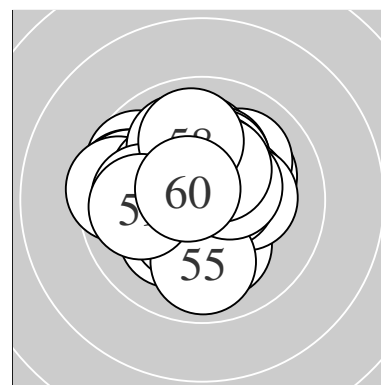

Serie 1:	10.3 *	10.2 *	10.3 *	9.8 ↖	10.6 *
	10.1 ↗	10.0 ↗	9.7 ↖	10.4 *	10.4 *
beste Teiler	92.1 (5.)	132.9 (9.)	142.2 (10.)		
Trefferlage	0.51 mm links, 0.14 mm hoch				
Streuwert	1.45, horizontal: 1.67, vertikal: 1.21				

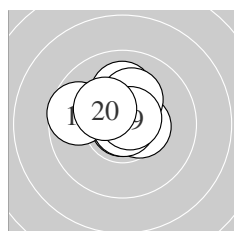

Serie 2:	10.9 *	10.3 *	10.9 *	10.1 ↑	9.7 ↖
	10.5 *	10.9 *	10.2 *	10.7 *	10.3 *
beste Teiler	6.4 (11.)	9.4 (17.)	12.0 (13.)		
Trefferlage	0.22 mm links, 0.77 mm hoch				
Streuwert	1.05, horizontal: 1.20, vertikal: 0.86				

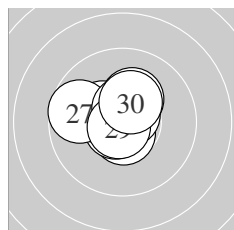

Serie 3:	10.6 *	10.7 *	10.4 *	10.7 *	10.3 *
	10.3 *	9.7 ↖	10.6 *	10.8 *	10.3 *
beste Teiler	44.2 (29.)	63.6 (22.)	66.8 (24.)		
Trefferlage	0.46 mm links, 0.50 mm hoch				
Streuwert	0.98, horizontal: 1.15, vertikal: 0.79				

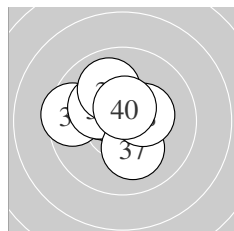

Serie 4:	9.5 ↖	10.5 *	10.3 *	10.9 *	10.3 *
	10.2 *	10.1 ↓	10.3 *	10.0 ↗	10.6 *
beste Teiler	22.0 (34.)	96.1 (40.)	113.4 (32.)		
Trefferlage	0.49 mm links, 0.58 mm hoch				
Streuwert	1.30, horizontal: 1.51, vertikal: 1.06				

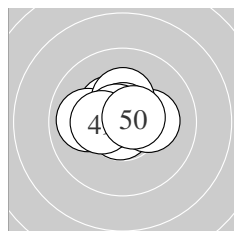

Serie 5:	10.8 *	10.5 *	10.2 *	10.4 *	10.0 ↖
	10.3 *	10.7 *	10.7 *	10.4 *	10.6 *
beste Teiler	47.5 (41.)	55.2 (47.)	60.8 (48.)		
Trefferlage	0.38 mm links, 0.44 mm hoch				
Streuwert	0.94, horizontal: 1.20, vertikal: 0.58				

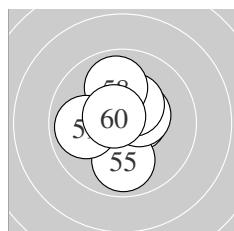

Serie 6:	10.6 *	10.5 *	10.6 *	10.7 *	9.9 ↓
	10.4 *	10.4 *	9.9 ↑	9.9 ↖	10.6 *
beste Teiler	63.6 (54.)	77.0 (60.)	79.0 (51.)		
Trefferlage	0.26 mm links, 0.07 mm hoch				
Streuwert	1.23, horizontal: 1.09, vertikal: 1.35				

ISSF AR Women – Wertung – Frauen

StandNr: 121

Vognarova, Gabriela #229

StartNr: 115

21. Januar 2019 13:43

CZE

Unterschrift des Schützen

Meyton Elektronik

Ergebnis: **616.7** (589)
 Serien: 102.1 103.6 102.1 103.5 102.2 103.2
 Zähler: 50 9 1 0 0 0 0 0 0
 Innenzehner: 36
 weiteste: 558 (52), 386 (32), 378 (41)
 beste Teiler 18.4 (23.) 33.3 (53.) 53.8 (18.)
 Trefferlage 0.45 mm rechts, 0.45 mm hoch
 Streuwert 1.32, horizontal: 1.38, vertikal: 1.26

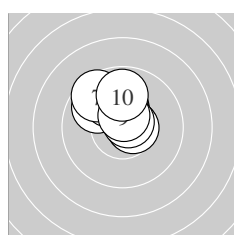
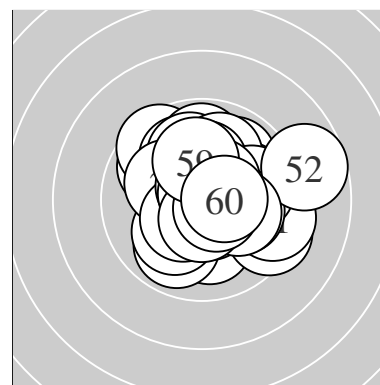

Serie 1:
 9.8 ↘ 10.3 * 10.3 * 10.6 * 9.9 ↘
 10.6 * 9.6 ↘ 10.7 * 10.5 * 9.8 ↑
 beste Teiler 67.2 (8.) 80.5 (4.) 90.0 (6.)
 Trefferlage 0.32 mm links, 1.42 mm hoch
 Streuwert 1.08, horizontal: 1.13, vertikal: 1.02

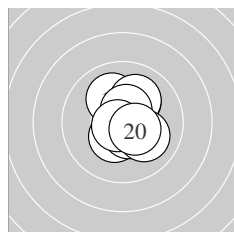

Serie 2:
 10.6 * 10.1 ↖ 10.1 ↗ 10.1 ↗ 10.4 *
 10.5 * 10.5 * 10.7 * 10.1 ↘ 10.5 *
 beste Teiler 53.8 (18.) 76.8 (11.) 104.7 (17.)
 Trefferlage 0.33 mm rechts, 0.17 mm hoch
 Streuwert 1.15, horizontal: 0.93, vertikal: 1.33

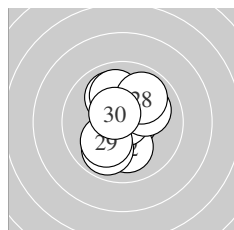

Serie 3:
 10.6 * 10.1 ↓ 10.9 * 10.1 ↗ 10.0 ↘
 9.9 ↙ 10.0 ↖ 9.9 ↗ 10.1 ↙ 10.5 *
 beste Teiler 18.4 (23.) 76.0 (21.) 101.9 (30.)
 Trefferlage 0.02 mm links, 0.23 mm hoch
 Streuwert 1.51, horizontal: 1.20, vertikal: 1.76

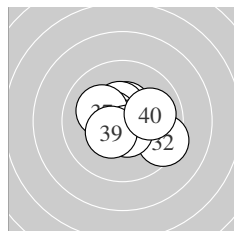

Serie 4:
 10.7 * 9.4 ↘ 10.5 * 10.5 * 10.5 *
 10.7 * 10.2 * 10.6 * 10.4 * 10.0 →
 beste Teiler 57.1 (31.) 63.6 (36.) 96.2 (38.)
 Trefferlage 0.29 mm rechts, 0.08 mm hoch
 Streuwert 1.32, horizontal: 1.59, vertikal: 1.00

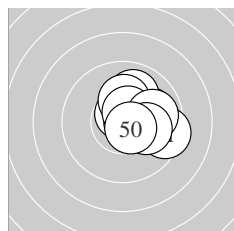

Serie 5:
 9.4 → 10.0 → 10.7 * 10.0 ↗ 10.7 *
 10.2 * 10.6 * 9.9 → 10.1 → 10.6 *
 beste Teiler 62.0 (45.) 73.0 (43.) 86.6 (50.)
 Trefferlage 1.31 mm rechts, 0.51 mm hoch
 Streuwert 1.15, horizontal: 1.24, vertikal: 1.04

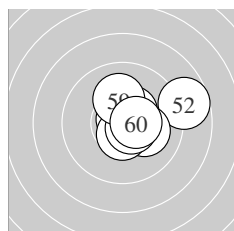

Serie 6:
 10.5 * 8.7 → 10.8 * 10.7 * 10.2 *
 10.5 * 10.6 * 10.6 * 10.1 ↑ 10.5 *
 beste Teiler 33.3 (53.) 73.9 (54.) 86.0 (58.)
 Trefferlage 1.11 mm rechts, 0.31 mm hoch
 Streuwert 1.34, horizontal: 1.61, vertikal: 0.99

Meyton Elektronik

ISSF AR Women – Wertung – Frauen

StandNr: 122

Hofstetter, Vanessa #70811334

StartNr: 116

21. Januar 2019 13:40

SUI

Unterschrift des Schützen

Meyton Elektronik

Ergebnis: **625.8** (598)
 Serien: 103.8 105.0 105.3 102.9 105.4 103.4
 Zähler: 58 2 0 0 0 0 0 0 0
 Innenzehner: 50
 weiteste: 284 (34), 260 (32), 243 (36)
 beste Teiler 41.1 (22.) 42.7 (21.) 51.2 (51.)
 Trefferlage 0.00 mm , 0.02 mm tief
 Streuwert 1.04, horizontal: 0.98, vertikal: 1.09

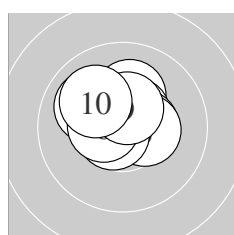
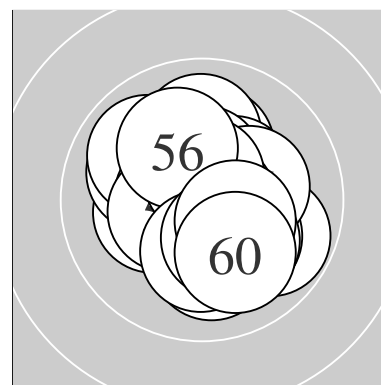

Serie 1:
 10.2 * 10.5 * 10.5 * 10.5 * 10.0 ↘
 10.4 * 10.7 * 10.5 * 10.5 * 10.0 ↘
 beste Teiler 70.4 (7.) 105.4 (3.) 109.3 (2.)
 Trefferlage 0.12 mm links, 0.74 mm hoch
 Streuwert 1.01, horizontal: 1.18, vertikal: 0.80

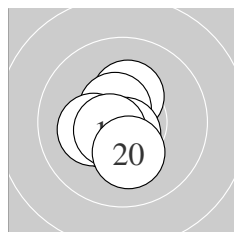

Serie 2:
 10.3 * 10.5 * 10.5 * 10.7 * 10.7 *
 10.6 * 10.7 * 10.2 * 10.6 * 10.2 *
 beste Teiler 71.8 (17.) 74.3 (15.) 74.6 (14.)
 Trefferlage 0.37 mm links, 0.33 mm tief
 Streuwert 0.85, horizontal: 0.65, vertikal: 1.02

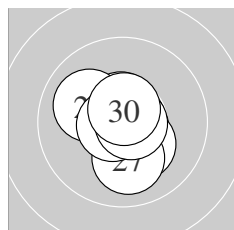

Serie 3:
 10.8 * 10.8 * 10.7 * 10.6 * 10.0 ↘
 10.3 * 10.1 ↓ 10.7 * 10.7 * 10.6 *
 beste Teiler 41.1 (22.) 42.7 (21.) 53.6 (29.)
 Trefferlage 0.01 mm rechts, 0.18 mm tief
 Streuwert 0.94, horizontal: 0.86, vertikal: 1.01

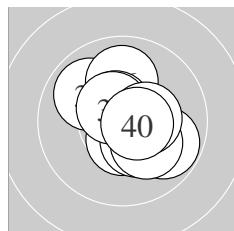

Serie 4:
 10.5 * 9.9 ↘ 10.4 * 9.8 ↘ 10.2 *
 10.0 ↑ 10.6 * 10.5 * 10.4 * 10.6 *
 beste Teiler 91.4 (40.) 96.6 (37.) 102.0 (38.)
 Trefferlage 0.40 mm rechts, 0.07 mm hoch
 Streuwert 1.32, horizontal: 1.30, vertikal: 1.35

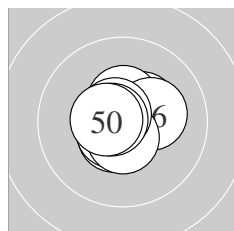

Serie 5:
 10.4 * 10.5 * 10.7 * 10.5 * 10.6 *
 10.2 * 10.6 * 10.7 * 10.7 * 10.5 *
 beste Teiler 67.8 (48.) 69.6 (49.) 72.3 (43.)
 Trefferlage 0.08 mm links, 0.14 mm hoch
 Streuwert 0.81, horizontal: 0.88, vertikal: 0.74

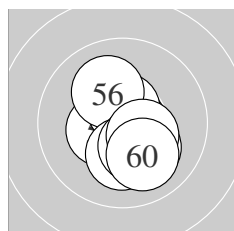

Serie 6:
 10.7 * 10.6 * 10.4 * 10.1 ↘ 10.6 *
 10.1 ↘ 10.2 * 10.3 * 10.4 * 10.0 ↘
 beste Teiler 51.2 (51.) 79.6 (52.) 85.2 (55.)
 Trefferlage 0.22 mm rechts, 0.57 mm tief
 Streuwert 1.10, horizontal: 0.94, vertikal: 1.24

ISSF AR Women – Wertung – Frauen

StandNr: 123

Vdovina, Daria #70811335

StartNr: 117

21. Januar 2019 13:28

RUS

Unterschrift des Schützen

Meyton Elektronik

Ergebnis:	630.5	(599) ^{QF}						
Serien:	104.8	105.2	106.3	104.7	104.8	104.7		
Zähler:	59	1	0	0	0	0	0	0
Innenzehner:	56							
weiteste:	266 (24), 225 (7), 219 (37)							
beste Teiler	21.2 (8.)	22.8 (29.)	26.1 (47.)					
Trefferlage	0.05 mm links, 0.15 mm hoch							
Streuwert	0.89, horizontal: 0.85, vertikal: 0.92							

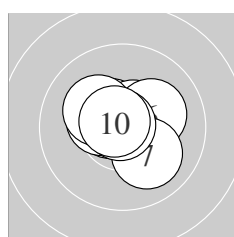
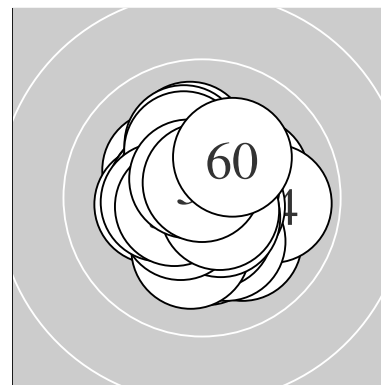

Serie 1:	10.6 *	10.5 *	10.4 *	10.6 *	10.6 *
	10.2 *	10.1 ↘	10.9 *	10.2 *	10.7 *
beste Teiler	21.2 (8.)	62.4 (10.)	80.6 (1.)		
Trefferlage	0.02 mm links, 0.31 mm hoch				
Streuwert	0.98, horizontal: 1.16, vertikal: 0.76				

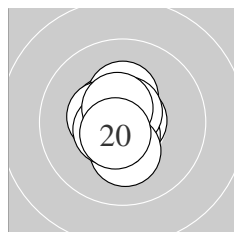

Serie 2:	10.5 *	10.7 *	10.6 *	10.3 *	10.7 *
	10.2 *	10.4 *	10.6 *	10.6 *	10.6 *
beste Teiler	55.9 (12.)	68.1 (15.)	82.0 (13.)		
Trefferlage	0.27 mm links, 0.04 mm hoch				
Streuwert	0.82, horizontal: 0.60, vertikal: 1.00				

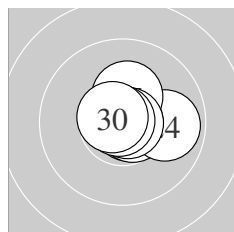

Serie 3:	10.8 *	10.7 *	10.6 *	9.9 →	10.8 *
	10.8 *	10.3 *	10.8 *	10.9 *	10.7 *
beste Teiler	22.8 (29.)	31.0 (26.)	33.5 (28.)		
Trefferlage	0.39 mm rechts, 0.26 mm hoch				
Streuwert	0.75, horizontal: 0.87, vertikal: 0.60				

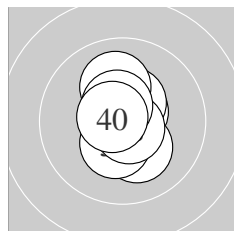

Serie 4:	10.6 *	10.6 *	10.5 *	10.4 *	10.2 *
	10.4 *	10.1 ↑	10.7 *	10.5 *	10.7 *
beste Teiler	60.8 (38.)	70.0 (40.)	77.3 (31.)		
Trefferlage	0.05 mm rechts, 0.13 mm hoch				
Streuwert	0.95, horizontal: 0.56, vertikal: 1.22				

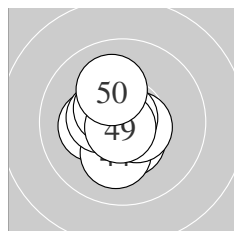

Serie 5:	10.4 *	10.8 *	10.2 *	10.2 *	10.4 *
	10.6 *	10.8 *	10.5 *	10.8 *	10.1 ↑
beste Teiler	26.1 (47.)	37.1 (49.)	45.2 (42.)		
Trefferlage	0.36 mm links, 0.09 mm tief				
Streuwert	0.96, horizontal: 0.84, vertikal: 1.08				

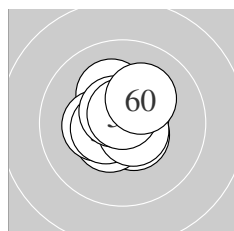

Serie 6:	10.2 *	10.5 *	10.5 *	10.3 *	10.6 *
	10.5 *	10.6 *	10.6 *	10.7 *	10.2 *
beste Teiler	58.0 (59.)	79.4 (55.)	82.4 (57.)		
Trefferlage	0.14 mm links, 0.24 mm hoch				
Streuwert	0.92, horizontal: 0.92, vertikal: 0.92				

Meyton Elektronik

ISSF AR Women – Wertung – Frauen

StandNr: 124

Galashina, Anastasiia #70811336

StartNr: 118

21. Januar 2019 13:46

RUS

QF – Schütze hat sich fürs Finale qualifiziert

Unterschrift des Schützen

Meyton Elektronik

Ergebnis:	628.2	(598)							
Serien:	105.4	104.3	105.1	104.4	104.3	104.7			
Zähler:	58	2	0	0	0	0	0	0	0
Innenzehner:	52								
weiteste:	291	(35),	256	(49),	222	(26)			
beste Teiler	5.3	(41.)	7.2	(37.)	10.1	(23.)			
Trefferlage	0.26 mm links, 0.05 mm hoch								
Streuwert	0.96, horizontal: 0.99, vertikal: 0.93								

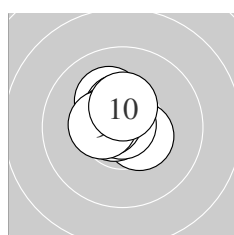
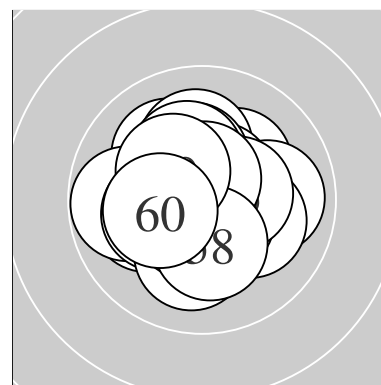

Serie 1:					
	10.2 *	10.5 *	10.6 *	10.7 *	10.5 *
	10.7 *	10.9 *	10.5 *	10.4 *	10.4 *
beste Teiler	16.7 (7.) 54.8 (4.) 55.0 (6.)				
Trefferlage	0.37 mm links, 0.53 mm hoch				
Streuwert	0.69, horizontal: 0.68, vertikal: 0.70				

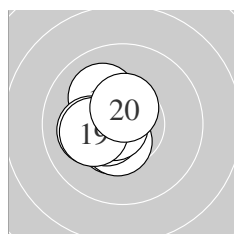

Serie 2:					
	10.5 *	10.5 *	10.5 *	10.7 *	10.5 *
	10.1 ↘	10.7 *	10.1 ←	10.2 *	10.5 *
beste Teiler	59.4 (17.) 70.0 (14.) 107.5 (20.)				
Trefferlage	0.90 mm links, 0.07 mm tief				
Streuwert	0.82, horizontal: 0.70, vertikal: 0.93				

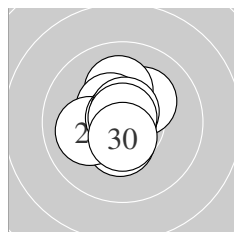

Serie 3:					
	10.2 *	10.1 ↑	10.9 *	10.5 *	10.4 *
	10.1 ←	10.8 *	10.7 *	10.8 *	10.6 *
beste Teiler	10.1 (23.) 30.0 (29.) 32.4 (27.)				
Trefferlage	0.21 mm links, 0.29 mm hoch				
Streuwert	0.96, horizontal: 0.86, vertikal: 1.05				

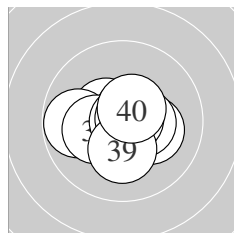

Serie 4:					
	10.2 *	10.5 *	10.5 *	10.7 *	9.8 ←
	10.2 *	10.9 *	10.8 *	10.2 *	10.6 *
beste Teiler	7.2 (37.) 46.8 (38.) 67.0 (34.)				
Trefferlage	0.11 mm links, 0.11 mm tief				
Streuwert	1.13, horizontal: 1.41, vertikal: 0.75				

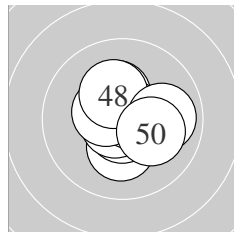

Serie 5:					
	10.9 *	10.2 *	10.7 *	10.3 *	10.7 *
	10.7 *	10.5 *	10.3 *	9.9 →	10.1 ↘
beste Teiler	5.3 (41.) 57.1 (46.) 57.4 (45.)				
Trefferlage	0.21 mm rechts, 0.05 mm hoch				
Streuwert	1.09, horizontal: 1.14, vertikal: 1.05				

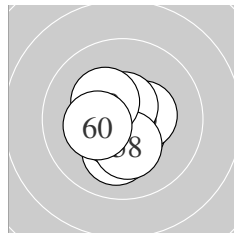

Serie 6:					
	10.1 ↓	10.7 *	10.6 *	10.6 *	10.8 *
	10.4 *	10.6 *	10.3 *	10.3 *	10.3 *
beste Teiler	40.6 (55.) 65.7 (52.) 83.2 (57.)				
Trefferlage	0.22 mm links, 0.37 mm tief				
Streuwert	0.94, horizontal: 0.86, vertikal: 1.02				

Meyton Elektronik

ISSF AR Women – Wertung – Frauen

StandNr: 125

Sagen, Maddalena #70811337

StartNr: 119

21. Januar 2019 13:46

USA

Unterschrift des Schützen

Meyton Elektronik

Ergebnis: **606.9** (578)

Serien: 99.7 101.1 100.9 102.4 100.8 102.0

Zähler: 40 18 2 0 0 0 0 0 0

Innenzehner: 30

weiteste: 532 (43), 509 (42), 480 (32)

beste Teiler 2.2 (49.) 7.6 (50.) 36.6 (39.)

Trefferlage 0.10 mm links, 0.39 mm tief

Streuwert 1.69, horizontal: 2.01, vertikal: 1.29

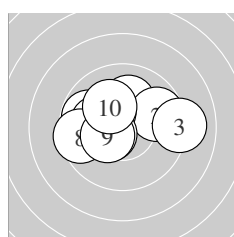
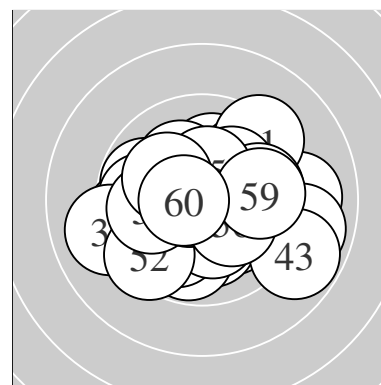

Serie 1:

10.1 ↑	9.7 →	9.1 →	10.3 *	10.5 *
9.8 ←	10.1 ←	9.5 ←	10.4 *	10.2 *

beste Teiler 120.3 (5.) 142.7 (9.) 169.1 (4.)

Trefferlage 0.49 mm links, 0.54 mm hoch

Streuwert 1.92, horizontal: 2.53, vertikal: 1.00

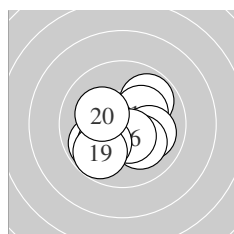

Serie 2:

9.8 ↗	10.2 *	10.0 ↘	10.5 *	10.1 ↘
10.5 *	9.9 ↙	10.1 ↙	9.8 ↙	10.2 *

beste Teiler 112.7 (16.) 115.8 (14.) 180.6 (12.)

Trefferlage 0.07 mm links, 0.50 mm tief

Streuwert 1.58, horizontal: 1.78, vertikal: 1.35

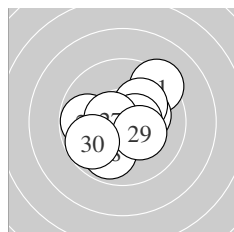

Serie 3:

9.3 ↗	10.2 *	10.1 ↗	10.4 *	10.5 *
9.8 ←	10.6 *	9.9 ↓	10.3 *	9.8 ↙

beste Teiler 99.7 (27.) 103.4 (25.) 147.7 (24.)

Trefferlage 0.04 mm rechts, 0.09 mm tief

Streuwert 1.76, horizontal: 1.93, vertikal: 1.58

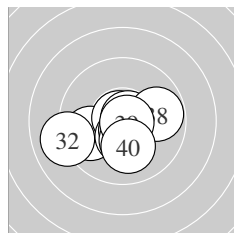

Serie 4:

9.8 ←	9.0 ←	10.8 *	10.8 *	10.4 *
10.6 *	10.3 *	9.8 →	10.8 *	10.1 ↓

beste Teiler 36.6 (39.) 40.4 (33.) 50.2 (34.)

Trefferlage 0.29 mm links, 0.71 mm tief

Streuwert 1.55, horizontal: 1.99, vertikal: 0.91

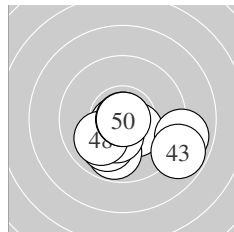

Serie 5:

10.4 *	8.9 →	8.8 ↘	10.7 *	9.8 ↓
10.0 ↙	10.4 *	10.0 ↙	10.9 *	10.9 *

beste Teiler 2.2 (49.) 7.6 (50.) 62.2 (44.)

Trefferlage 0.60 mm rechts, 1.32 mm tief

Streuwert 1.78, horizontal: 2.32, vertikal: 0.99

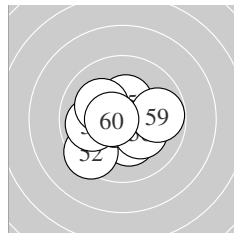

Serie 6:

10.3 *	9.4 ↙	10.6 *	10.7 *	10.4 *
10.2 *	9.9 ←	10.1 ↘	9.8 →	10.6 *

beste Teiler 63.6 (54.) 91.0 (60.) 96.6 (53.)

Trefferlage 0.39 mm links, 0.25 mm tief

Streuwert 1.52, horizontal: 1.74, vertikal: 1.27

Meyton Elektronik

ISSF AR Women – Wertung – Frauen

StandNr: 126

Mok, Rui Ping #70811165

StartNr: 120

21. Januar 2019 13:15

Singapore

Unterschrift des Schützen

Meyton Elektronik

Ergebnis:	630.6	(598) ^{QF}					
Serien:	105.2	105.3	105.6	104.7	105.4	104.4	
Zähler:	58	2	0	0	0	0	0
Innenzehner:	57						
weiteste:	265 (24), 253 (35), 220 (34)						
beste Teiler	30.1 (43.) 39.6 (50.) 40.1 (47.)						
Trefferlage	0.15 mm links, 0.21 mm hoch						
Streuwert	0.84, horizontal: 0.85, vertikal: 0.83						

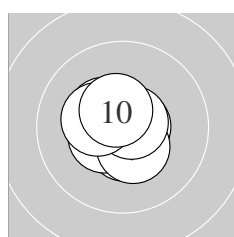
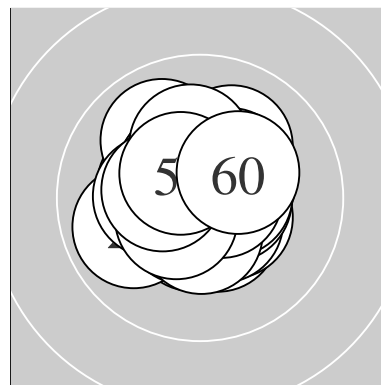

Serie 1:	10.7 *	10.7 *	10.5 *	10.5 *	10.5 *
	10.4 *	10.4 *	10.7 *	10.3 *	10.5 *
beste Teiler	54.0 (2.) 61.2 (8.) 70.1 (1.)				
Trefferlage	0.36 mm links, 0.03 mm hoch				
Streuwert	0.78, horizontal: 0.82, vertikal: 0.75				

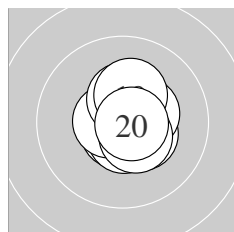

Serie 2:	10.7 *	10.7 *	10.6 *	10.4 *	10.4 *
	10.6 *	10.4 *	10.5 *	10.3 *	10.7 *
beste Teiler	56.0 (20.) 63.0 (11.) 67.1 (12.)				
Trefferlage	0.26 mm rechts, 0.04 mm hoch				
Streuwert	0.81, horizontal: 0.71, vertikal: 0.90				

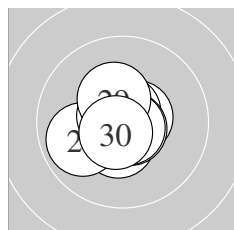

Serie 3:	10.7 *	10.6 *	10.5 *	9.9 ↙	10.7 *
	10.7 *	10.7 *	10.8 *	10.4 *	10.6 *
beste Teiler	50.2 (28.) 60.6 (26.) 60.9 (27.)				
Trefferlage	0.30 mm links, 0.06 mm tief				
Streuwert	0.85, horizontal: 0.89, vertikal: 0.81				

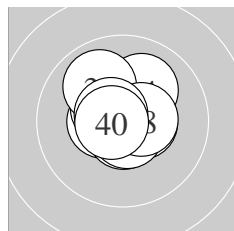

Serie 4:	10.5 *	10.7 *	10.5 *	10.1 ↗	9.9 ↖
	10.5 *	10.7 *	10.5 *	10.6 *	10.7 *
beste Teiler	67.6 (40.) 70.1 (32.) 70.7 (37.)				
Trefferlage	0.11 mm links, 0.37 mm hoch				
Streuwert	0.98, horizontal: 1.00, vertikal: 0.96				

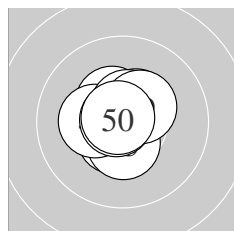

Serie 5:	10.4 *	10.4 *	10.8 *	10.5 *	10.4 *
	10.3 *	10.8 *	10.6 *	10.4 *	10.8 *
beste Teiler	30.1 (43.) 39.6 (50.) 40.1 (47.)				
Trefferlage	0.16 mm links, 0.22 mm hoch				
Streuwert	0.80, horizontal: 0.78, vertikal: 0.83				

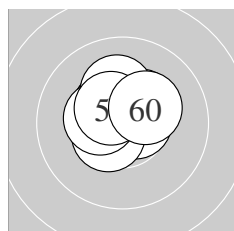

Serie 6:	10.6 *	10.4 *	10.6 *	10.4 *	10.5 *
	10.5 *	10.4 *	10.2 *	10.5 *	10.3 *
beste Teiler	77.1 (53.) 83.9 (51.) 113.5 (55.)				
Trefferlage	0.24 mm links, 0.65 mm hoch				
Streuwert	0.85, horizontal: 0.96, vertikal: 0.73				

Meyton Elektronik

ISSF AR Women – Wertung – Frauen

StandNr: 127

Brabcova, Aneta #233

StartNr: 121

21. Januar 2019 13:39

CZE

QF – Schütze hat sich fürs Finale qualifiziert

Unterschrift des Schützen

Meyton Elektronik

Ergebnis: **610.1** (584)
 Serien: 100.9 103.1 102.6 100.4 101.7 101.4
 Zähler: 45 14 1 0 0 0 0 0 0
 Innenzehner: 37
 weiteste: 533 (22), 481 (4), 434 (35)
 beste Teiler 13.1 (36.) 38.2 (19.) 39.4 (45.)
 Trefferlage 0.12 mm links, 0.08 mm tief
 Streuwert 1.63, horizontal: 1.96, vertikal: 1.20

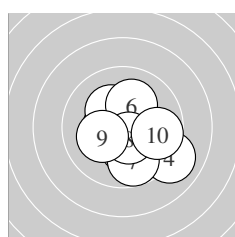
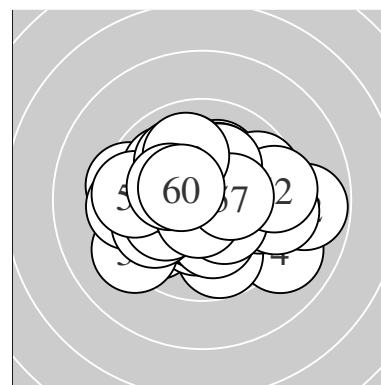

Serie 1:
 10.6 * 10.5 * 10.2 * 9.0 ↘ 10.3 *
 10.1 ↗ 9.8 ↓ 10.5 * 10.2 * 9.7 →
 beste Teiler 84.9 (1.) 107.9 (8.) 123.0 (2.)
 Trefferlage 0.57 mm rechts, 0.69 mm tief
 Streuwert 1.68, horizontal: 1.81, vertikal: 1.54

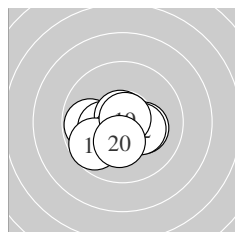

Serie 2:
 10.2 * 10.3 * 9.8 ← 10.3 * 10.5 *
 10.7 * 10.5 * 9.7 ↙ 10.8 * 10.3 *
 beste Teiler 38.2 (19.) 54.7 (16.) 102.6 (15.)
 Trefferlage 0.47 mm links, 0.65 mm tief
 Streuwert 1.19, horizontal: 1.49, vertikal: 0.77

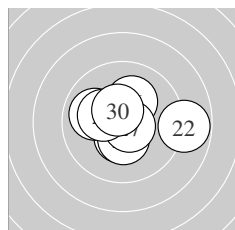

Serie 3:
 10.6 * 8.8 → 10.4 * 10.8 * 10.4 *
 10.2 * 10.7 * 10.0 ← 10.2 * 10.5 *
 beste Teiler 44.1 (24.) 69.1 (27.) 99.2 (21.)
 Trefferlage 0.13 mm rechts, 0.05 mm hoch
 Streuwert 1.63, horizontal: 2.08, vertikal: 1.01

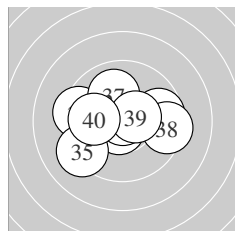

Serie 4:
 9.7 → 10.6 * 9.4 ← 10.7 * 9.2 ↙
 10.9 * 10.0 ↖ 9.4 → 10.5 * 10.0 ←
 beste Teiler 13.1 (36.) 72.9 (34.) 80.0 (32.)
 Trefferlage 0.20 mm links, 0.08 mm hoch
 Streuwert 2.01, horizontal: 2.56, vertikal: 1.23

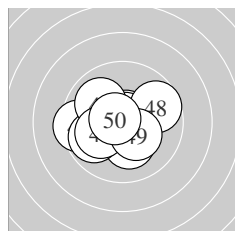

Serie 5:
 10.7 * 9.4 ← 10.2 * 9.8 ↙ 10.8 *
 10.0 ↘ 10.1 ← 9.7 → 10.3 * 10.7 *
 beste Teiler 39.4 (45.) 58.1 (41.) 72.6 (50.)
 Trefferlage 0.56 mm links, 0.14 mm tief
 Streuwert 1.61, horizontal: 1.97, vertikal: 1.13

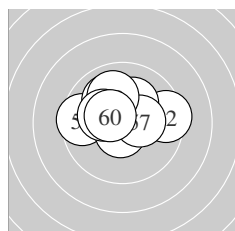

Serie 6:
 9.6 ← 9.4 → 10.0 ↖ 10.5 * 10.2 *
 10.6 * 10.4 * 10.0 ↖ 10.2 * 10.5 *
 beste Teiler 78.1 (56.) 116.6 (54.) 125.0 (60.)
 Trefferlage 0.20 mm links, 0.86 mm hoch
 Streuwert 1.54, horizontal: 1.98, vertikal: 0.92

Meyton Elektronik

ISSF AR Women – Wertung – Frauen

StandNr: 128

Ariana, Beh Yoke Ching #70811194

StartNr: 122

21. Januar 2019 13:06

SGP

Unterschrift des Schützen

Meyton Elektronik

Ergebnis: **629.7** (597)^{QF}
 Serien: 105.2 104.0 104.7 103.4 106.4 106.0
 Zähler: 57 3 0 0 0 0 0 0 0
 Innenzehner: 57
 weiteste: 387 (32), 316 (12), 251 (36)
 beste Teiler 5.3 (39.) 17.1 (19.) 26.0 (51.)
 Trefferlage 0.03 mm rechts, 0.14 mm tief
 Streuwert 0.92, horizontal: 0.94, vertikal: 0.91

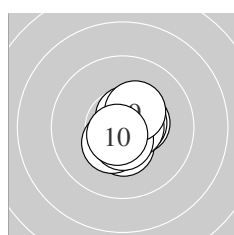
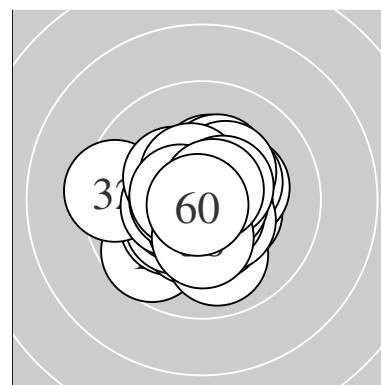

Serie 1:
 10.6 * 10.4 * 10.4 * 10.5 * 10.6 *
 10.4 * 10.6 * 10.6 * 10.4 * 10.7 *
 beste Teiler 68.8 (10.) 80.0 (7.) 80.9 (1.)
 Trefferlage 0.28 mm rechts, 0.24 mm tief
 Streuwert 0.78, horizontal: 0.68, vertikal: 0.87

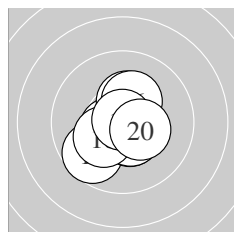

Serie 2:
 10.6 * 9.7 ↙ 10.5 * 10.6 * 10.3 *
 10.3 * 10.5 * 10.2 * 10.9 * 10.4 *
 beste Teiler 17.1 (19.) 98.4 (14.) 100.6 (11.)
 Trefferlage 0.01 mm links, 0.33 mm tief
 Streuwert 1.15, horizontal: 1.13, vertikal: 1.17

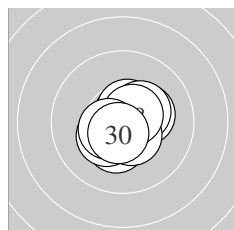

Serie 3:
 10.7 * 10.3 * 10.3 * 10.3 * 10.6 *
 10.3 * 10.5 * 10.6 * 10.5 * 10.6 *
 beste Teiler 56.5 (21.) 87.0 (30.) 91.0 (28.)
 Trefferlage 0.18 mm rechts, 0.14 mm tief
 Streuwert 0.92, horizontal: 0.93, vertikal: 0.90

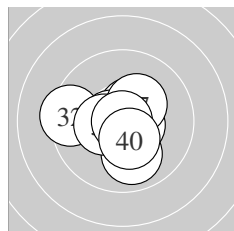

Serie 4:
 10.4 * 9.4 ← 10.5 * 10.6 * 10.6 *
 9.9 ↓ 10.3 * 10.4 * 10.9 * 10.4 *
 beste Teiler 5.3 (39.) 84.0 (35.) 93.6 (34.)
 Trefferlage 0.19 mm links, 0.28 mm tief
 Streuwert 1.31, horizontal: 1.49, vertikal: 1.10

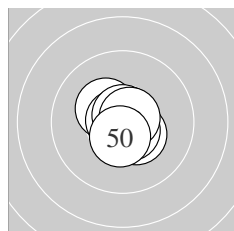

Serie 5:
 10.8 * 10.3 * 10.8 * 10.4 * 10.6 *
 10.8 * 10.7 * 10.8 * 10.7 * 10.5 *
 beste Teiler 32.0 (41.) 44.9 (43.) 49.7 (46.)
 Trefferlage 0.06 mm rechts, 0.04 mm tief
 Streuwert 0.65, horizontal: 0.62, vertikal: 0.67

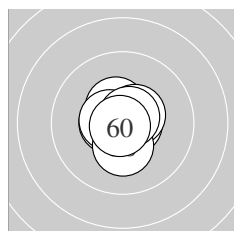

Serie 6:
 10.8 * 10.5 * 10.6 * 10.7 * 10.5 *
 10.5 * 10.6 * 10.3 * 10.7 * 10.8 *
 beste Teiler 26.0 (51.) 29.7 (60.) 65.1 (59.)
 Trefferlage 0.10 mm links, 0.16 mm hoch
 Streuwert 0.72, horizontal: 0.65, vertikal: 0.78

Meyton Elektronik

ISSF AR Women – Wertung – Frauen

StandNr: 129

Mazurova, Nikola #225

StartNr: 123

21. Januar 2019 13:44

CZE

QF – Schütze hat sich fürs Finale qualifiziert

Unterschrift des Schützen

Meyton Elektronik

Ergebnis:	629.5	(596) ^{QF}
Serien:	104.6	106.1 104.8 105.7 103.7 104.6
Zähler:	56	4 0 0 0 0 0 0 0 0
Innenzehner:	54	
weiteste:	284 (29), 266 (5), 265 (46)	
beste Teiler	8.0 (28.)	9.4 (30.) 10.4 (48.)
Trefferlage	0.14 mm rechts, 0.07 mm hoch	
Streuwert	0.95, horizontal: 1.13, vertikal: 0.72	

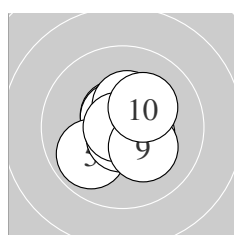
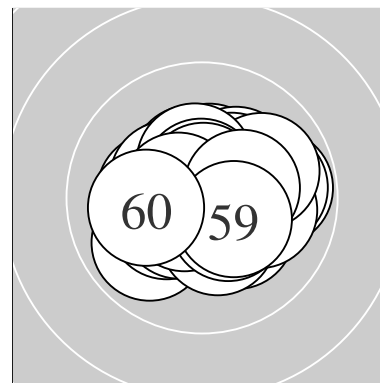

Serie 1:	10.7 *	10.6 *	10.6 *	10.5 *	9.9 ↙
	10.7 *	10.4 *	10.8 *	10.2 *	10.2 *
beste Teiler	30.0 (8.) 59.4 (1.) 64.9 (6.)				
Trefferlage	0.01 mm rechts, 0.02 mm tief				
Streuwert	1.04, horizontal: 1.04, vertikal: 1.05				

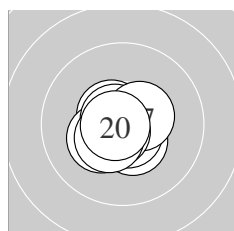

Serie 2:	10.8 *	10.6 *	10.3 *	10.5 *	10.7 *
	10.7 *	10.5 *	10.7 *	10.5 *	10.8 *
beste Teiler	44.5 (11.) 49.0 (20.) 59.0 (16.)				
Trefferlage	0.27 mm links, 0.25 mm tief				
Streuwert	0.69, horizontal: 0.75, vertikal: 0.61				

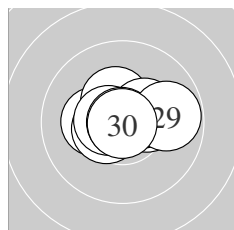

Serie 3:	10.3 *	10.8 *	10.3 *	10.4 *	10.5 *
	10.6 *	10.3 *	10.9 *	9.8 →	10.9 *
beste Teiler	8.0 (28.) 9.4 (30.) 48.0 (22.)				
Trefferlage	0.14 mm rechts, 0.27 mm hoch				
Streuwert	1.04, horizontal: 1.39, vertikal: 0.48				

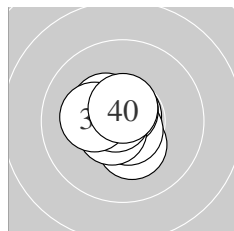

Serie 4:	10.7 *	10.3 *	10.8 *	10.7 *	10.7 *
	10.4 *	10.6 *	10.7 *	10.2 *	10.6 *
beste Teiler	43.6 (33.) 51.4 (38.) 53.3 (31.)				
Trefferlage	0.27 mm links, 0.00 mm				
Streuwert	0.76, horizontal: 0.74, vertikal: 0.77				

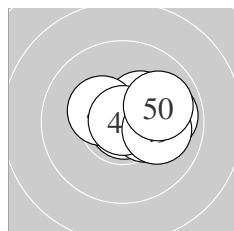

Serie 5:	10.9 *	10.8 *	10.2 *	10.3 *	10.4 *
	9.9 →	10.3 *	10.9 *	10.1 →	9.9 →
beste Teiler	10.4 (48.) 18.0 (41.) 32.3 (42.)				
Trefferlage	1.05 mm rechts, 0.31 mm hoch				
Streuwert	0.98, horizontal: 1.27, vertikal: 0.54				

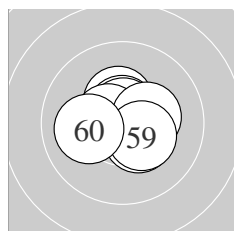

Serie 6:	10.4 *	10.5 *	10.4 *	10.6 *	10.6 *
	10.7 *	10.6 *	10.3 *	10.4 *	10.1 ←
beste Teiler	66.1 (56.) 82.0 (55.) 84.5 (54.)				
Trefferlage	0.22 mm rechts, 0.14 mm hoch				
Streuwert	0.97, horizontal: 1.14, vertikal: 0.75				

Meyton Elektronik

ISSF AR Women – Wertung – Frauen

StandNr: 130

Alison, Weisz #70811338

StartNr: 124

21. Januar 2019 13:48

USA

QF – Schütze hat sich fürs Finale qualifiziert

Unterschrift des Schützen

Meyton Elektronik

Ergebnis: **612.0** (584)

Serien: 103.3 102.4 102.5 101.0 103.1 99.7

Zähler: 44 16 0 0 0 0 0 0 0 0

Innenzehner: 34

weiteste: 447 (52), 344 (40), 323 (53)

beste Teiler 50.0 (30.) 72.0 (16.) 80.0 (38.)

Trefferlage 0.11 mm links, 0.40 mm hoch

Streuwert 1.45, horizontal: 1.58, vertikal: 1.31

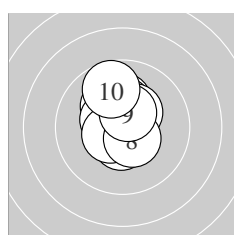
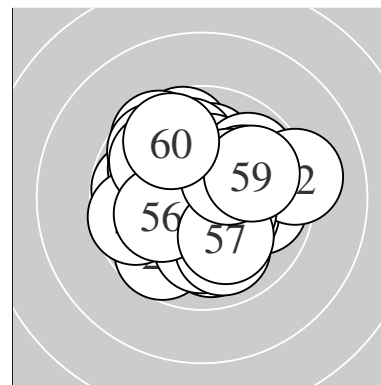

Serie 1:

10.2 *	10.5 *	10.2 *	10.5 *	10.3 *
10.4 *	10.5 *	10.5 *	10.5 *	9.7 ↑

beste Teiler 110.2 (7.) 112.5 (2.) 115.6 (8.)

Trefferlage 0.20 mm links, 0.86 mm hoch

Streuwert 1.09, horizontal: 0.76, vertikal: 1.34

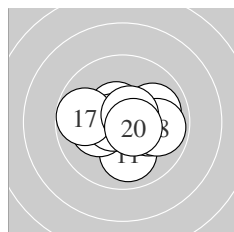

Serie 2:

10.0 ↓	10.1 →	10.0 →	10.5 *	10.2 *
10.7 *	9.8 ←	9.9 →	10.6 *	10.6 *

beste Teiler 72.0 (16.) 80.6 (19.) 93.0 (20.)

Trefferlage 0.28 mm rechts, 0.13 mm tief

Streuwert 1.46, horizontal: 1.82, vertikal: 0.96

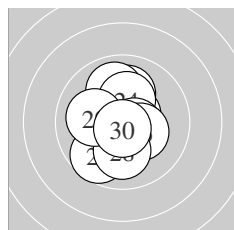

Serie 3:

10.1 ↑	10.6 *	9.9 ↑	10.3 *	10.6 *
10.3 *	9.7 ↙	10.1 ↓	10.1 ←	10.8 *

beste Teiler 50.0 (30.) 93.6 (22.) 97.8 (25.)

Trefferlage 0.10 mm links, 0.08 mm hoch

Streuwert 1.46, horizontal: 1.15, vertikal: 1.71

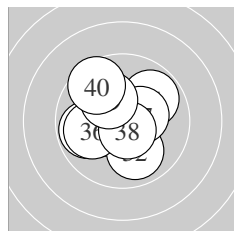

Serie 4:

10.2 *	9.9 ↓	9.8 ←	9.8 ↗	10.5 *
10.0 ←	10.4 *	10.6 *	10.2 *	9.6 ↘

beste Teiler 80.0 (38.) 122.8 (35.) 145.4 (37.)

Trefferlage 0.59 mm links, 0.26 mm hoch

Streuwert 1.63, horizontal: 1.72, vertikal: 1.53

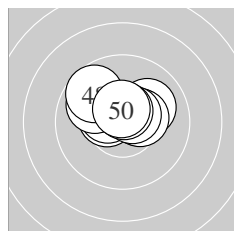

Serie 5:

10.1 ↗	10.4 *	10.5 *	10.4 *	10.4 *
10.6 *	9.9 ↘	9.7 ↘	10.6 *	10.5 *

beste Teiler 87.8 (49.) 95.2 (46.) 102.4 (50.)

Trefferlage 0.14 mm links, 0.87 mm hoch

Streuwert 1.13, horizontal: 1.49, vertikal: 0.59

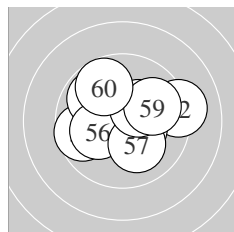

Serie 6:

10.4 *	9.2 →	9.7 ←	9.9 ↘	10.4 *
10.1 ←	10.1 ↓	10.3 *	9.9 →	9.7 ↘

beste Teiler 137.8 (51.) 138.1 (55.) 157.8 (58.)

Trefferlage 0.07 mm rechts, 0.44 mm hoch

Streuwert 1.92, horizontal: 2.34, vertikal: 1.39

ISSF AR Women – Wertung – Frauen

StandNr: 131

Olsavska, Ivana #70811339

StartNr: 125

21. Januar 2019 13:47

Police Sports Center Slovakia

Unterschrift des Schützen

Meyton Elektronik

Ergebnis: **626.1** (597)
 Serien: 103.8 104.0 104.1 104.1 104.4 105.7
 Zähler: 57 3 0 0 0 0 0 0 0
 Innenzehner: 52
 weiteste: 297 (2), 290 (40), 259 (19)
 beste Teiler 18.3 (58.) 31.0 (44.) 33.3 (41.)
 Trefferlage 0.00 mm , 0.40 mm hoch
 Streuwert 0.98, horizontal: 0.90, vertikal: 1.06

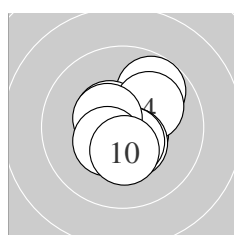
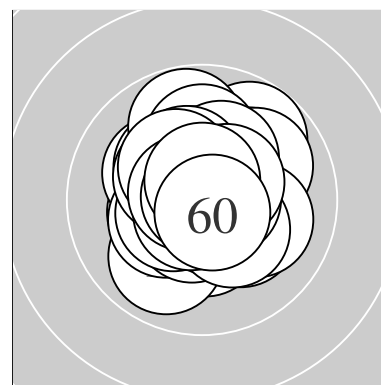

Serie 1:
 10.6 * 9.8 ↗ 10.5 * 10.1 ↗ 10.5 *
 10.5 * 10.5 * 10.5 * 10.4 * 10.4 *
 beste Teiler 85.9 (1.) 104.2 (7.) 108.4 (5.)
 Trefferlage 0.32 mm rechts, 0.07 mm tief
 Streuwert 1.14, horizontal: 1.02, vertikal: 1.26

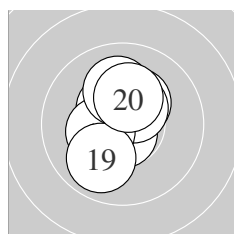

Serie 2:
 10.7 * 10.3 * 10.8 * 10.4 * 10.7 *
 10.5 * 10.3 * 10.1 ↑ 9.9 ↙ 10.3 *
 beste Teiler 42.4 (13.) 52.4 (11.) 59.0 (15.)
 Trefferlage 0.27 mm links, 0.44 mm hoch
 Streuwert 1.07, horizontal: 0.80, vertikal: 1.30

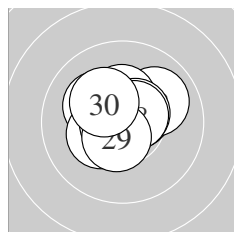

Serie 3:
 10.5 * 10.0 ↗ 10.4 * 10.2 * 10.6 *
 10.3 * 10.7 * 10.6 * 10.5 * 10.3 *
 beste Teiler 55.5 (27.) 84.3 (28.) 100.4 (25.)
 Trefferlage 0.07 mm links, 0.48 mm hoch
 Streuwert 1.04, horizontal: 1.19, vertikal: 0.86

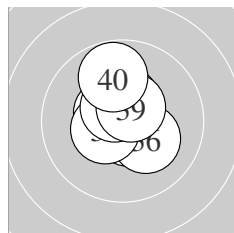

Serie 4:
 10.7 * 10.4 * 10.6 * 10.5 * 10.4 *
 10.2 * 10.5 * 10.5 * 10.5 * 9.8 ↑
 beste Teiler 73.2 (31.) 78.3 (33.) 102.0 (38.)
 Trefferlage 0.16 mm links, 0.53 mm hoch
 Streuwert 1.01, horizontal: 0.80, vertikal: 1.18

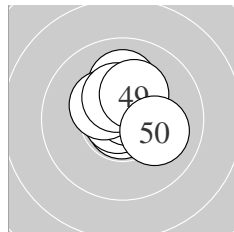

Serie 5:
 10.8 * 10.1 ↑ 10.4 * 10.8 * 10.5 *
 10.7 * 10.4 * 10.4 * 10.2 * 10.1 ↘
 beste Teiler 31.0 (44.) 33.3 (41.) 65.6 (46.)
 Trefferlage 0.14 mm rechts, 0.78 mm hoch
 Streuwert 0.91, horizontal: 0.89, vertikal: 0.93

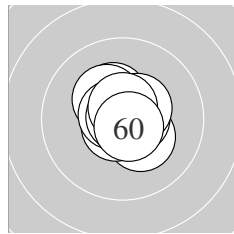

Serie 6:
 10.3 * 10.3 * 10.7 * 10.6 * 10.3 *
 10.5 * 10.7 * 10.9 * 10.7 * 10.7 *
 beste Teiler 18.3 (58.) 63.2 (60.) 64.4 (53.)
 Trefferlage 0.05 mm rechts, 0.24 mm hoch
 Streuwert 0.78, horizontal: 0.75, vertikal: 0.81

Meyton Elektronik

ISSF AR Women – Wertung – Frauen

StandNr: 132

Lustenberger, Petra #70811340

StartNr: 126

21. Januar 2019 13:28

SUI

Unterschrift des Schützen

Meyton Elektronik

Ergebnis: **624.7** (596)
 Serien: 105.2 102.7 103.2 104.7 106.0 102.9
 Zähler: 56 4 0 0 0 0 0 0 0
 Innenzehner: 49
 weiteste: 374 (13), 269 (24), 261 (12)
 beste Teiler 11.3 (46.) 14.8 (50.) 18.0 (33.)
 Trefferlage 0.23 mm links, 0.09 mm tief
 Streuwert 1.09, horizontal: 1.29, vertikal: 0.84

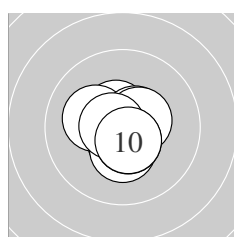
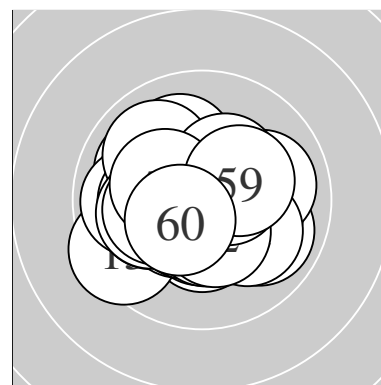

Serie 1:
 10.5 * 10.5 * 10.6 * 10.2 * 10.6 *
 10.4 * 10.5 * 10.6 * 10.7 * 10.6 *
 beste Teiler 71.3 (9.) 82.7 (3.) 96.7 (10.)
 Trefferlage 0.03 mm rechts, 0.13 mm tief
 Streuwert 0.86, horizontal: 0.87, vertikal: 0.85

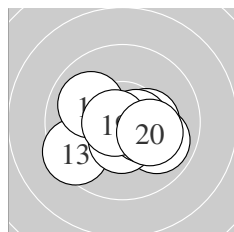

Serie 2:
 10.6 * 9.9 ↘ 9.5 ↙ 10.3 * 10.5 *
 10.4 * 10.0 ↖ 10.6 * 10.7 * 10.2 *
 beste Teiler 52.3 (19.) 78.2 (11.) 91.0 (18.)
 Trefferlage 0.25 mm rechts, 0.52 mm tief
 Streuwert 1.40, horizontal: 1.78, vertikal: 0.87

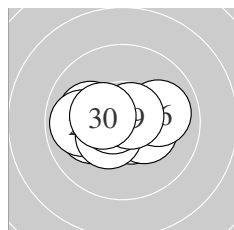

Serie 3:
 10.1 ← 10.6 * 10.1 ← 9.9 ← 10.3 *
 10.0 → 10.4 * 10.7 * 10.7 * 10.4 *
 beste Teiler 66.7 (28.) 68.4 (29.) 82.7 (22.)
 Trefferlage 0.48 mm links, 0.06 mm tief
 Streuwert 1.25, horizontal: 1.68, vertikal: 0.55

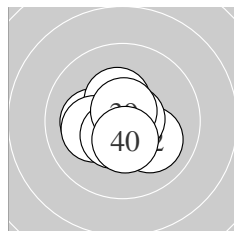

Serie 4:
 10.2 * 10.1 ↘ 10.9 * 10.6 * 10.4 *
 10.2 * 10.7 * 10.5 * 10.7 * 10.4 *
 beste Teiler 18.0 (33.) 63.5 (37.) 68.4 (39.)
 Trefferlage 0.19 mm links, 0.28 mm tief
 Streuwert 1.01, horizontal: 1.14, vertikal: 0.88

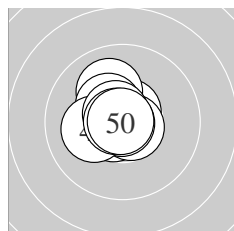

Serie 5:
 10.7 * 10.6 * 10.1 ↖ 10.4 * 10.7 *
 10.9 * 10.2 * 10.7 * 10.8 * 10.9 *
 beste Teiler 11.3 (46.) 14.8 (50.) 40.1 (49.)
 Trefferlage 0.45 mm links, 0.30 mm hoch
 Streuwert 0.75, horizontal: 0.71, vertikal: 0.79

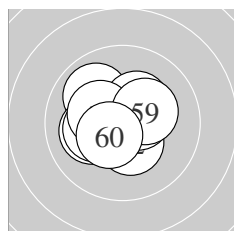

Serie 6:
 9.9 ↘ 10.4 * 10.4 * 10.5 * 10.1 ←
 10.3 * 10.2 * 10.3 * 10.3 * 10.5 *
 beste Teiler 110.8 (54.) 121.0 (60.) 139.8 (52.)
 Trefferlage 0.53 mm links, 0.12 mm hoch
 Streuwert 1.21, horizontal: 1.38, vertikal: 1.00

ISSF AR Women – Wertung – Frauen

StandNr: 133

Brazdova, Lucie #277

StartNr: 127

21. Januar 2019 13:44

CZE

Unterschrift des Schützen

Meyton Elektronik

Ergebnis: **619.3** (593)
 Serien: 101.8 104.0 103.4 104.2 103.7 102.2
 Zähler: 53 7 0 0 0 0 0 0 0
 Innenzehner: 43
 weiteste: 479 (10), 384 (53), 330 (59)
 beste Teiler 29.0 (46.) 30.4 (5.) 37.0 (26.)
 Trefferlage 0.00 mm , 0.07 mm tief
 Streuwert 1.29, horizontal: 1.17, vertikal: 1.40

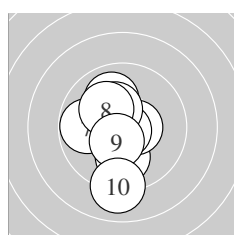
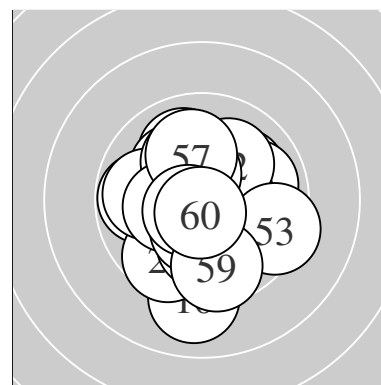

Serie 1:
 10.0 ↓ 10.7 * 10.0 ↗ 10.5 * 10.8 *
 10.3 * 9.8 ← 10.2 * 10.5 * 9.0 ↓
 beste Teiler 30.4 (5.) 70.2 (2.) 104.0 (4.)
 Trefferlage 0.47 mm links, 0.33 mm tief
 Streuwert 1.66, horizontal: 1.11, vertikal: 2.07

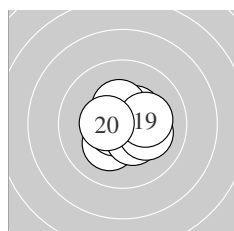

Serie 2:
 10.5 * 10.4 * 10.2 * 10.7 * 10.7 *
 10.4 * 10.4 * 10.1 ↘ 10.2 * 10.4 *
 beste Teiler 57.0 (15.) 70.8 (14.) 120.6 (11.)
 Trefferlage 0.14 mm rechts, 0.02 mm hoch
 Streuwert 1.07, horizontal: 1.16, vertikal: 0.98

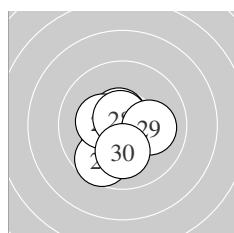

Serie 3:
 10.6 * 10.3 * 10.2 * 9.7 ↙ 10.6 *
 10.8 * 10.3 * 10.7 * 10.1 → 10.1 ↓
 beste Teiler 37.0 (26.) 61.0 (28.) 82.7 (25.)
 Trefferlage 0.31 mm links, 0.70 mm tief
 Streuwert 1.17, horizontal: 1.12, vertikal: 1.22

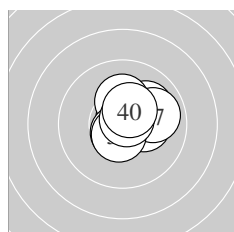

Serie 4:
 10.8 * 10.7 * 10.0 ↗ 10.3 * 10.2 *
 10.6 * 9.9 → 10.6 * 10.7 * 10.4 *
 beste Teiler 44.5 (31.) 51.7 (39.) 60.5 (32.)
 Trefferlage 0.66 mm rechts, 0.41 mm hoch
 Streuwert 0.94, horizontal: 1.00, vertikal: 0.88

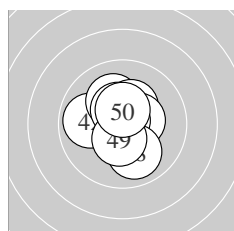

Serie 5:
 10.7 * 9.9 ← 10.1 ↗ 10.3 * 10.4 *
 10.8 * 10.5 * 10.0 ↓ 10.5 * 10.5 *
 beste Teiler 29.0 (46.) 54.5 (41.) 116.0 (50.)
 Trefferlage 0.12 mm links, 0.35 mm hoch
 Streuwert 1.17, horizontal: 1.09, vertikal: 1.25

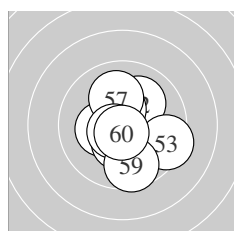

Serie 6:
 10.7 * 10.1 ↗ 9.4 ↘ 10.4 * 10.3 *
 10.4 * 10.0 ↗ 10.6 * 9.6 ↓ 10.7 *
 beste Teiler 59.0 (51.) 63.6 (60.) 86.2 (58.)
 Trefferlage 0.16 mm rechts, 0.18 mm tief
 Streuwert 1.55, horizontal: 1.43, vertikal: 1.66

Meyton Elektronik

ISSF AR Women – Wertung – Frauen

StandNr: 134

Ungerank, Nadine #227

StartNr: 128

21. Januar 2019 13:37

AUT

Unterschrift des Schützen

Meyton Elektronik

Ergebnis:	627.0	(596)					
Serien:	104.4	106.2	105.3	104.9	102.7	103.5	
Zähler:	56	4	0	0	0	0	0
Innenzehner:	51						
weiteste:	424 (46), 274 (60), 263 (28)						
beste Teiler	36.4 (25.) 38.0 (59.) 41.1 (40.)						
Trefferlage	0.18 mm links, 0.07 mm hoch						
Streuwert	1.02, horizontal: 1.14, vertikal: 0.89						

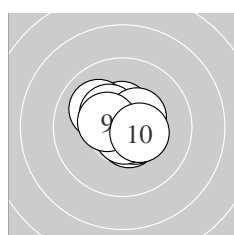
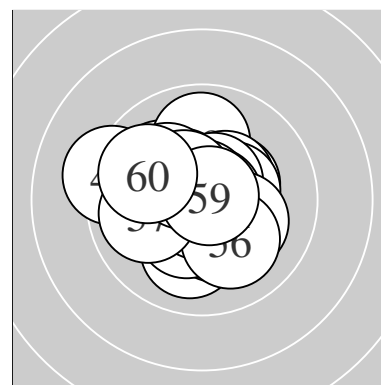

Serie 1:	10.6 *	10.5 *	10.4 *	10.5 *	10.7 *
	10.0 ↖	10.4 *	10.4 *	10.5 *	10.4 *
beste Teiler	56.5 (5.) 95.0 (1.) 107.7 (2.)				
Trefferlage	0.12 mm links, 0.34 mm hoch				
Streuwert	0.97, horizontal: 1.08, vertikal: 0.85				

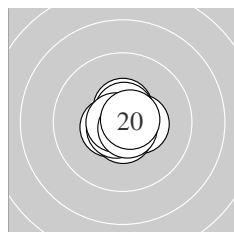

Serie 2:	10.4 *	10.5 *	10.5 *	10.8 *	10.6 *
	10.6 *	10.7 *	10.7 *	10.7 *	10.7 *
beste Teiler	47.7 (14.) 53.0 (18.) 59.8 (19.)				
Trefferlage	0.02 mm rechts, 0.08 mm tief				
Streuwert	0.62, horizontal: 0.63, vertikal: 0.61				

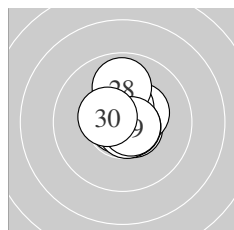

Serie 3:	10.6 *	10.4 *	10.7 *	10.5 *	10.8 *
	10.5 *	10.7 *	9.9 ↑	10.7 *	10.5 *
beste Teiler	36.4 (25.) 59.9 (27.) 70.6 (29.)				
Trefferlage	0.18 mm rechts, 0.41 mm hoch				
Streuwert	0.86, horizontal: 0.71, vertikal: 0.99				

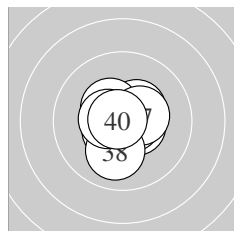

Serie 4:	10.5 *	10.7 *	10.7 *	10.4 *	10.4 *
	10.5 *	10.4 *	10.0 ↓	10.5 *	10.8 *
beste Teiler	41.1 (40.) 53.0 (32.) 69.2 (33.)				
Trefferlage	0.07 mm rechts, 0.07 mm tief				
Streuwert	0.92, horizontal: 0.93, vertikal: 0.91				

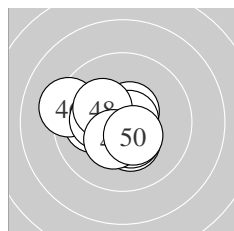

Serie 5:	10.3 *	10.6 *	10.4 *	10.8 *	10.1 ←
	9.3 ←	10.2 *	10.2 *	10.4 *	10.4 *
beste Teiler	50.2 (44.) 95.9 (42.) 128.8 (50.)				
Trefferlage	0.72 mm links, 0.18 mm tief				
Streuwert	1.36, horizontal: 1.64, vertikal: 1.01				

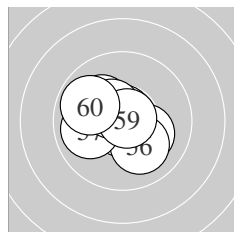

Serie 6:	10.2 *	10.4 *	10.8 *	10.8 *	10.1 ↖
	10.1 ↘	9.9 ←	10.5 *	10.8 *	9.9 ↖
beste Teiler	38.0 (59.) 47.5 (53.) 50.0 (54.)				
Trefferlage	0.56 mm links, 0.01 mm hoch				
Streuwert	1.24, horizontal: 1.45, vertikal: 0.99				

Meyton Elektronik

ISSF AR Women – Wertung – Frauen

StandNr: 135

Mary, Tucker #70811224

StartNr: 129

21. Januar 2019 13:35

USA

Unterschrift des Schützen

Meyton Elektronik

Ergebnis:	610.8	(584)
Serien:	102.8	101.8 102.4 101.4 101.6 100.8
Zähler:	44	16 0 0 0 0 0 0 0 0
Innenzehner:	31	
weiteste:	406	(60), 376 (15), 365 (50)
beste Teiler	19.9	(11.) 23.1 (59.) 42.7 (8.)
Trefferlage	0.28 mm	links, 0.31 mm hoch
Streuwert	1.50,	horizontal: 1.77, vertikal: 1.18

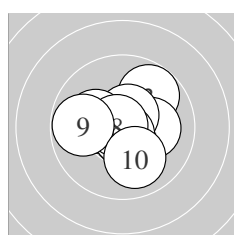
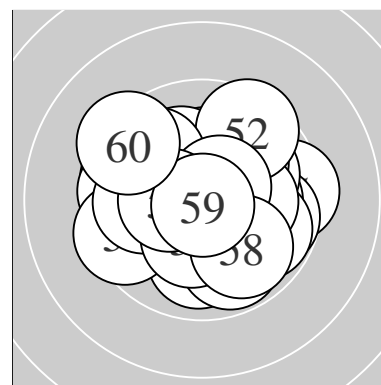

Serie 1:	10.1 ←	10.7 *	9.8 ↗	10.2 *	10.6 *
	10.1 ←	10.7 *	10.8 *	9.8 ←	10.0 ↓
beste Teiler	42.7	(8.) 56.5 (7.)	59.6 (2.)		
Trefferlage	0.19 mm	links, 0.08 mm hoch			
Streuwert	1.42,	horizontal: 1.65, vertikal: 1.15			

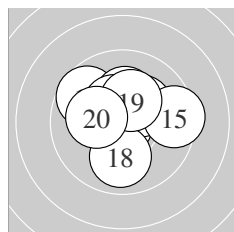

Serie 2:	10.9 *	9.7 ↖	10.2 *	10.2 *	9.4 →
	10.5 *	10.4 *	10.0 ↓	10.3 *	10.2 *
beste Teiler	19.9	(11.) 101.3 (16.)	136.0 (17.)		
Trefferlage	0.02 mm	links, 0.63 mm hoch			
Streuwert	1.53,	horizontal: 1.75, vertikal: 1.29			

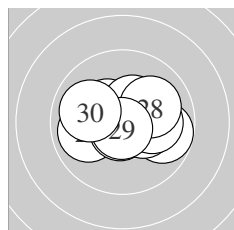

Serie 3:	9.9 ←	10.7 *	10.4 *	9.8 →	10.3 *
	10.4 *	10.1 →	10.0 ↗	10.8 *	10.0 ←
beste Teiler	46.5	(29.) 58.8 (22.)	137.3 (26.)		
Trefferlage	0.30 mm	rechts, 0.11 mm hoch			
Streuwert	1.44,	horizontal: 1.88, vertikal: 0.79			

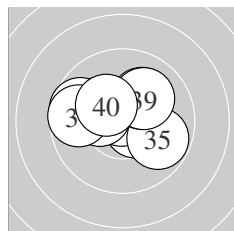

Serie 4:	10.1 ↖	10.5 *	9.7 ↖	10.8 *	9.8 →
	10.3 *	9.7 ←	10.1 ↗	10.1 ↗	10.3 *
beste Teiler	42.9	(34.) 102.4 (32.)	164.7 (40.)		
Trefferlage	0.47 mm	links, 0.57 mm hoch			
Streuwert	1.57,	horizontal: 2.03, vertikal: 0.90			

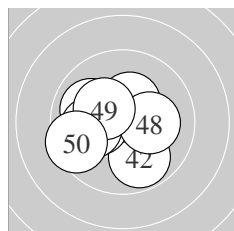

Serie 5:	10.6 *	9.8 ↓	10.6 *	10.4 *	10.0 ↖
	10.2 *	10.0 ←	10.2 *	10.3 *	9.5 ←
beste Teiler	79.5	(41.) 83.6 (43.)	147.4 (44.)		
Trefferlage	0.69 mm	links, 0.08 mm tief			
Streuwert	1.51,	horizontal: 1.77, vertikal: 1.20			

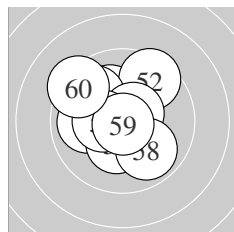

Serie 6:	10.1 ↖	9.5 ↗	9.9 ↖	9.9 ←	10.3 *
	10.6 *	10.4 *	9.9 ↓	10.9 *	9.3 ↖
beste Teiler	23.1	(59.) 95.2 (56.)	142.0 (57.)		
Trefferlage	0.60 mm	links, 0.57 mm hoch			
Streuwert	1.72,	horizontal: 1.76, vertikal: 1.68			

Meyton Elektronik

ISSF AR Women – Wertung – Frauen

StandNr: 137

Baumgartner, Joelle #70811341

StartNr: 131

21. Januar 2019 13:41

SUI – ZH

Unterschrift des Schützen

Meyton Elektronik

Ergebnis: **619.7** (591)
 Serien: 103.5 103.5 103.8 102.8 102.4 103.7
 Zähler: 51 9 0 0 0 0 0 0 0
 Innenzehner: 41
 weiteste: 385 (55), 354 (35), 333 (41)
 beste Teiler 12.0 (33.) 38.4 (21.) 38.8 (58.)
 Trefferlage 0.30 mm rechts, 0.19 mm hoch
 Streuwert 1.24, horizontal: 1.41, vertikal: 1.05

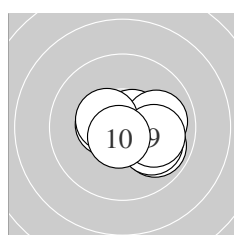
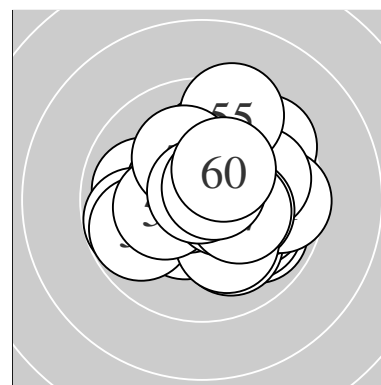

Serie 1:
 10.6 * 10.6 * 9.9 ↘ 10.5 * 10.7 *
 10.0 → 10.0 ↘ 10.5 * 10.0 → 10.7 *
 beste Teiler 54.7 (5.) 74.0 (10.) 82.9 (2.)
 Trefferlage 0.77 mm rechts, 0.31 mm tief
 Streuwert 1.12, horizontal: 1.43, vertikal: 0.68

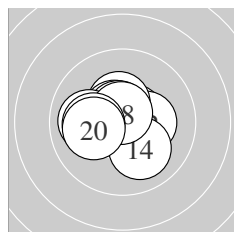

Serie 2:
 10.6 * 10.3 * 10.4 * 10.1 ↘ 10.6 *
 10.6 * 10.0 ← 10.7 * 10.1 ← 10.1 ←
 beste Teiler 65.7 (18.) 79.3 (16.) 87.6 (11.)
 Trefferlage 0.42 mm links, 0.15 mm hoch
 Streuwert 1.18, horizontal: 1.41, vertikal: 0.89

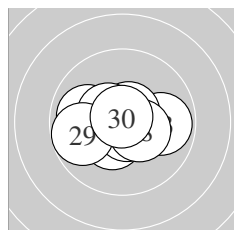

Serie 3:
 10.8 * 10.4 * 9.9 → 10.6 * 10.7 *
 9.9 ← 10.5 * 10.4 * 9.8 ← 10.8 *
 beste Teiler 38.4 (21.) 39.8 (30.) 65.7 (25.)
 Trefferlage 0.25 mm links, 0.16 mm tief
 Streuwert 1.26, horizontal: 1.65, vertikal: 0.65

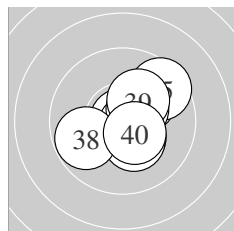

Serie 4:
 10.4 * 10.3 * 10.9 * 10.1 ↗ 9.5 ↗
 10.7 * 10.4 * 9.8 ← 10.2 * 10.5 *
 beste Teiler 12.0 (33.) 59.5 (36.) 122.3 (40.)
 Trefferlage 0.67 mm rechts, 0.11 mm hoch
 Streuwert 1.34, horizontal: 1.37, vertikal: 1.32

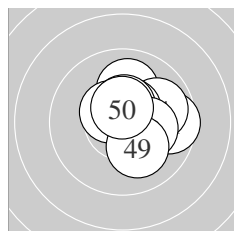

Serie 5:
 9.6 → 10.0 ↑ 10.6 * 9.9 → 10.5 *
 10.5 * 10.5 * 10.2 * 10.1 ↘ 10.5 *
 beste Teiler 78.9 (43.) 102.7 (45.) 103.0 (50.)
 Trefferlage 0.88 mm rechts, 0.55 mm hoch
 Streuwert 1.19, horizontal: 1.28, vertikal: 1.09

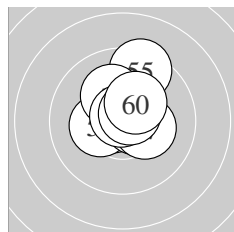

Serie 6:
 10.7 * 10.4 * 10.3 * 10.6 * 9.4 ↑
 10.2 * 10.3 * 10.8 * 10.7 * 10.3 *
 beste Teiler 38.8 (58.) 62.0 (51.) 73.5 (59.)
 Trefferlage 0.16 mm rechts, 0.80 mm hoch
 Streuwert 1.16, horizontal: 1.03, vertikal: 1.27

Meyton Elektronik

ISSF AR Women – Wertung – Frauen

StandNr: 138

Hyblerova, Jana #70811342

StartNr: 132

21. Januar 2019 13:41

Police Sports Center Slovakia

Unterschrift des Schützen

Meyton Elektronik

Ergebnis: **620.6** (592)
 Serien: 104.5 103.1 105.1 102.9 102.3 102.7
 Zähler: 52 8 0 0 0 0 0 0 0
 Innenzehner: 45
 weiteste: 375 (17), 375 (44), 366 (59)
 beste Teiler 5.0 (29.) 12.0 (37.) 33.2 (3.)
 Trefferlage 0.19 mm rechts, 0.11 mm hoch
 Streuwert 1.26, horizontal: 1.29, vertikal: 1.23

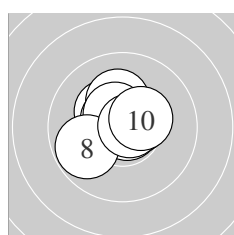
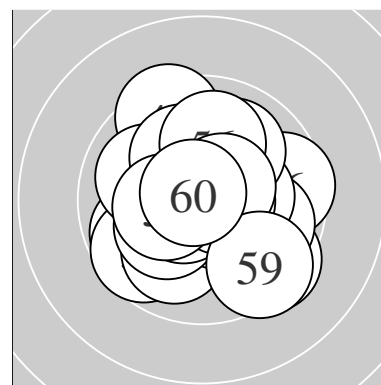

Serie 1:
 10.5 * 10.3 * 10.8 * 10.2 * 10.6 *
 10.6 * 10.5 * 9.8 ↙ 10.8 * 10.4 *
 beste Teiler 33.2 (3.) 50.9 (9.) 90.8 (5.)
 Trefferlage 0.33 mm links, 0.42 mm hoch
 Streuwert 1.00, horizontal: 1.13, vertikal: 0.84

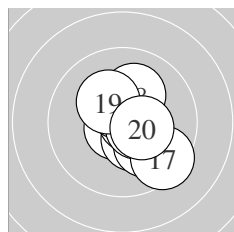

Serie 2:
 10.7 * 10.4 * 10.7 * 10.5 * 10.0 ↘
 10.5 * 9.5 ↘ 10.1 ↑ 10.3 * 10.4 *
 beste Teiler 54.1 (13.) 61.7 (11.) 106.3 (14.)
 Trefferlage 0.71 mm rechts, 0.20 mm tief
 Streuwert 1.25, horizontal: 1.10, vertikal: 1.38

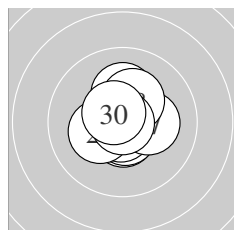

Serie 3:
 10.2 * 10.6 * 10.6 * 10.7 * 10.7 *
 10.3 * 10.2 * 10.3 * 10.9 * 10.6 *
 beste Teiler 5.0 (29.) 57.2 (25.) 74.8 (24.)
 Trefferlage 0.07 mm rechts, 0.17 mm hoch
 Streuwert 0.93, horizontal: 0.86, vertikal: 1.00

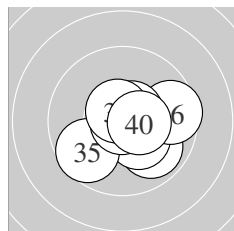

Serie 4:
 10.8 * 10.0 → 9.9 ↘ 10.3 * 9.7 ↙
 9.6 → 10.9 * 10.6 * 10.6 * 10.5 *
 beste Teiler 12.0 (37.) 45.1 (31.) 78.7 (39.)
 Trefferlage 0.80 mm rechts, 0.37 mm tief
 Streuwert 1.36, horizontal: 1.64, vertikal: 0.99

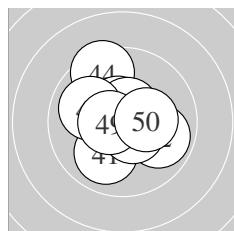

Serie 5:
 10.0 ↙ 9.9 ↘ 10.3 * 9.5 ↗ 10.5 *
 10.6 * 10.0 ↙ 10.6 * 10.6 * 10.3 *
 beste Teiler 91.0 (49.) 95.6 (46.) 99.0 (48.)
 Trefferlage 0.16 mm links, 0.41 mm hoch
 Streuwert 1.51, horizontal: 1.47, vertikal: 1.54

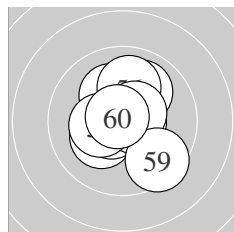

Serie 6:
 10.2 * 10.6 * 10.2 * 10.6 * 10.0 ↗
 10.0 ↑ 10.5 * 10.3 * 9.5 ↘ 10.8 *
 beste Teiler 48.4 (60.) 84.2 (54.) 89.0 (52.)
 Trefferlage 0.08 mm rechts, 0.24 mm hoch
 Streuwert 1.43, horizontal: 1.30, vertikal: 1.56

Meyton Elektronik

ISSF AR Women – Wertung – Frauen

StandNr: 139

Shimizu, Ayano #70811343

StartNr: 133

21. Januar 2019 13:37

JPN

Unterschrift des Schützen

Meyton Elektronik

Ergebnis:	617.5	(590)						
Serien:	104.1	101.8	102.3	103.0	102.1	104.2		
Zähler:	50	10	0	0	0	0	0	0
Innenzehner:	42							
weiteste:	480 (16), 473 (48), 423 (23)							
beste Teiler	23.7 (30.) 46.0 (14.) 47.2 (33.)							
Trefferlage	0.03 mm rechts, 0.38 mm hoch							
Streuwert	1.36, horizontal: 1.57, vertikal: 1.11							

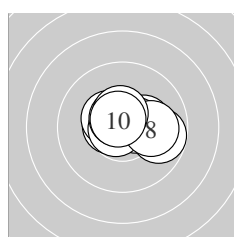
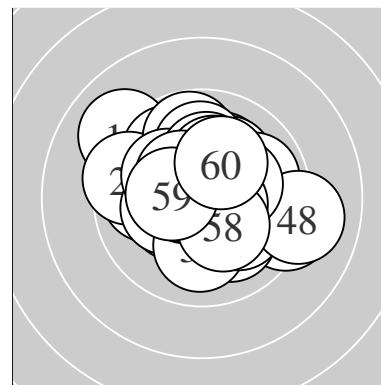

Serie 1:	10.3 *	10.5 *	10.6 *	9.8 →	10.4 *
	10.7 *	10.6 *	10.0 →	10.5 *	10.7 *
beste Teiler	55.3 (6.) 74.7 (10.) 85.4 (7.)				
Trefferlage	0.42 mm rechts, 0.28 mm hoch				
Streuwert	1.08, horizontal: 1.44, vertikal: 0.52				

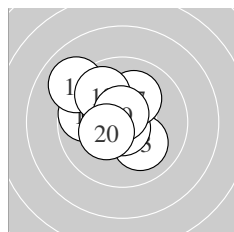

Serie 2:	9.7 ←	10.7 *	10.1 ↘	10.8 *	10.5 *
	9.0 ↘	10.1 ↑	9.9 ↘	10.7 *	10.3 *
beste Teiler	46.0 (14.) 69.2 (19.) 74.5 (12.)				
Trefferlage	0.91 mm links, 0.64 mm hoch				
Streuwert	1.52, horizontal: 1.60, vertikal: 1.43				

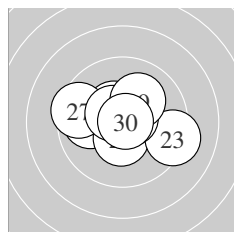

Serie 3:	9.9 ←	10.4 *	9.3 →	10.7 *	10.6 *
	10.4 *	9.5 ←	10.5 *	10.1 ↑	10.9 *
beste Teiler	23.7 (30.) 71.5 (24.) 86.8 (25.)				
Trefferlage	0.17 mm links, 0.32 mm hoch				
Streuwert	1.61, horizontal: 2.06, vertikal: 0.98				

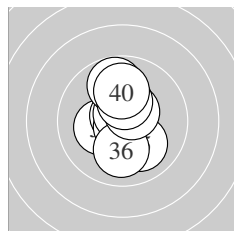

Serie 4:	10.2 *	10.7 *	10.8 *	10.7 *	10.0 ↘
	10.0 ↓	9.8 ↑	10.5 *	10.3 *	10.0 ↑
beste Teiler	47.2 (33.) 60.1 (32.) 61.3 (34.)				
Trefferlage	0.08 mm links, 0.36 mm hoch				
Streuwert	1.32, horizontal: 0.81, vertikal: 1.68				

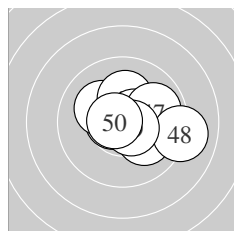

Serie 5:	10.2 *	10.6 *	10.2 *	10.2 *	10.1 ↘
	10.5 *	9.9 →	9.1 →	10.6 *	10.7 *
beste Teiler	65.7 (50.) 78.1 (42.) 84.8 (49.)				
Trefferlage	0.61 mm rechts, 0.28 mm hoch				
Streuwert	1.55, horizontal: 1.95, vertikal: 0.99				

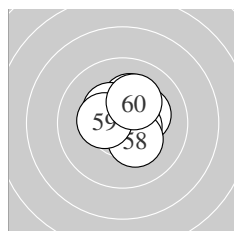

Serie 6:	10.5 *	10.7 *	10.2 *	10.2 *	10.4 *
	10.7 *	10.6 *	10.3 *	10.4 *	10.2 *
beste Teiler	55.7 (52.) 58.2 (56.) 97.7 (57.)				
Trefferlage	0.36 mm rechts, 0.42 mm hoch				
Streuwert	0.97, horizontal: 1.01, vertikal: 0.92				

Meyton Elektronik

ISSF AR Women – Wertung – Frauen

StandNr: 140

Holzmann, Nadine #338

StartNr: 134

21. Januar 2019 13:39

T – SG Matrei

Unterschrift des Schützen

Meyton Elektronik

Ergebnis:	624.0	(596)							
Serien:	103.1	104.0	103.7	105.6	104.4	103.2			
Zähler:	56	4	0	0	0	0	0	0	0
Innenzehner:	47								
weiteste:	313 (10),	276 (8),	275 (22)						
beste Teiler	42.7 (2.)	46.0 (16.)	46.0 (21.)						
Trefferlage	0.30 mm links, 0.42 mm tief								
Streuwert	1.03, horizontal: 1.04, vertikal: 1.02								

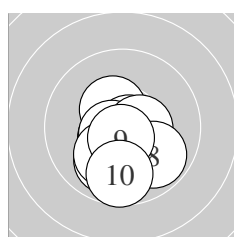
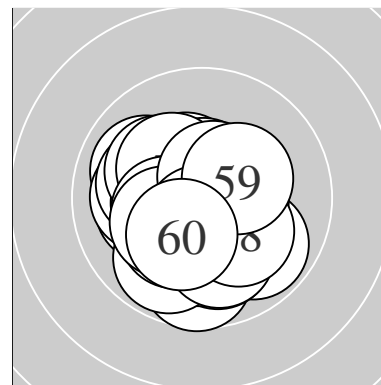

Serie 1:

10.4 *	10.8 *	10.5 *	10.6 *	10.5 *
10.0 ↙	10.1 ↙	9.8 ↘	10.7 *	9.7 ↓
beste Teiler	42.7 (2.)	72.8 (9.)	83.5 (4.)	
Trefferlage	0.09 mm links, 0.98 mm tief			
Streuwert	1.15, horizontal: 1.02, vertikal: 1.27			

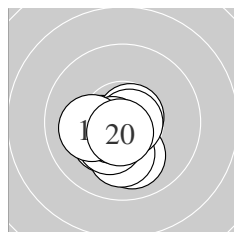

Serie 2:

10.0 ↓	10.3 *	10.1 ↓	10.4 *	10.7 *
10.8 *	10.3 *	10.6 *	10.1 ←	10.7 *
beste Teiler	46.0 (16.)	62.9 (15.)	71.0 (20.)	
Trefferlage	0.48 mm links, 0.85 mm tief			
Streuwert	0.88, horizontal: 0.91, vertikal: 0.84			

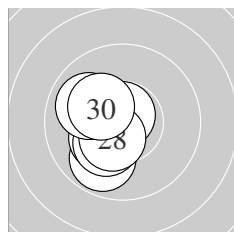

Serie 3:

10.8 *	9.9 ↙	10.6 *	10.5 *	10.3 *
10.8 *	10.2 *	10.5 *	9.9 ↘	10.2 *
beste Teiler	46.0 (21.)	48.2 (26.)	76.1 (23.)	
Trefferlage	1.06 mm links, 0.33 mm tief			
Streuwert	0.91, horizontal: 0.62, vertikal: 1.13			

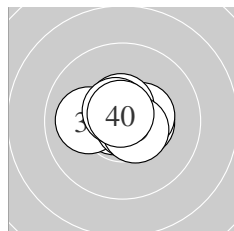

Serie 4:

10.7 *	10.5 *	10.7 *	10.0 ←	10.8 *
10.4 *	10.6 *	10.6 *	10.5 *	10.8 *
beste Teiler	48.0 (35.)	50.9 (40.)	55.0 (31.)	
Trefferlage	0.08 mm rechts, 0.16 mm hoch			
Streuwert	0.82, horizontal: 1.06, vertikal: 0.45			

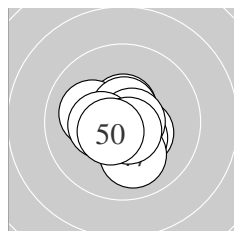

Serie 5:

10.6 *	10.4 *	10.4 *	10.1 ↘	10.6 *
10.7 *	10.0 ↓	10.4 *	10.7 *	10.5 *
beste Teiler	62.0 (46.)	69.3 (49.)	79.6 (45.)	
Trefferlage	0.04 mm links, 0.30 mm tief			
Streuwert	1.00, horizontal: 1.05, vertikal: 0.96			

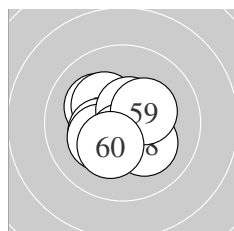

Serie 6:

10.1 ↘	10.3 *	10.3 *	10.3 *	10.2 *
10.6 *	10.6 *	10.2 *	10.3 *	10.3 *
beste Teiler	93.1 (57.)	96.6 (56.)	153.9 (54.)	
Trefferlage	0.20 mm links, 0.24 mm tief			
Streuwert	1.19, horizontal: 1.28, vertikal: 1.09			

ISSF AR Women – Wertung – Frauen

StandNr: 141

Sadangi, Shriyanak #70811344

StartNr: 135

21. Januar 2019 13:40

IND

Unterschrift des Schützen

Meyton Elektronik

Ergebnis:	604.9	(577)							
Serien:	100.5	100.3	102.2	99.8	101.0	101.1			
Zähler:	39	19	2	0	0	0	0	0	0
Innenzehner:	30								
weiteste:	568 (33), 508 (34), 400 (2)								
beste Teiler	16.5 (32.)	58.2 (14.)	62.4 (38.)						
Trefferlage	0.13 mm rechts, 0.13 mm hoch								
Streuwert	1.76, horizontal: 2.13, vertikal: 1.28								

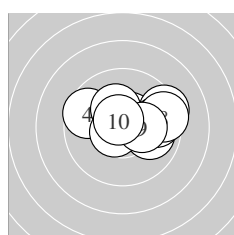
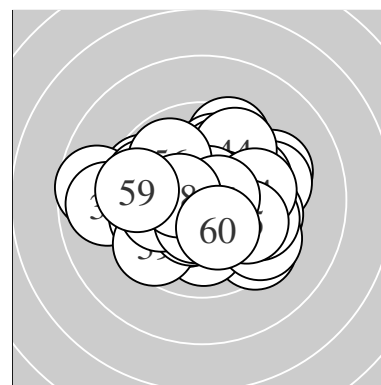

Serie 1:

10.5 *	9.4 ↗	10.0 →	9.6 ↘	10.3 *
9.7 →	10.6 *	9.4 →	10.3 *	10.7 *

beste Teiler 74.7 (10.) 82.4 (7.) 108.2 (1.)
 Trefferlage 1.03 mm rechts, 0.62 mm hoch
 Streuwert 1.68, horizontal: 2.24, vertikal: 0.78

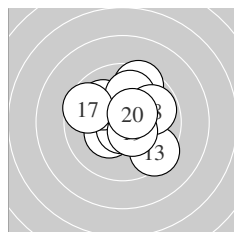

Serie 2:

9.5 ↗	10.3 *	9.4 ↘	10.7 *	10.0 ↘
10.0 ↗	9.6 ↘	9.8 →	10.5 *	10.5 *

beste Teiler 58.2 (14.) 115.5 (20.) 119.6 (19.)
 Trefferlage 0.30 mm rechts, 0.54 mm hoch
 Streuwert 1.82, horizontal: 1.88, vertikal: 1.76

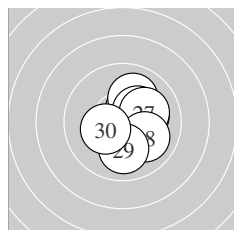

Serie 3:

10.4 *	10.0 ↗	10.4 *	10.2 *	10.3 *
10.5 *	10.1 →	10.0 ↘	10.0 ↓	10.3 *

beste Teiler 107.8 (26.) 136.8 (21.) 138.1 (23.)
 Trefferlage 0.91 mm rechts, 0.08 mm hoch
 Streuwert 1.23, horizontal: 1.08, vertikal: 1.36

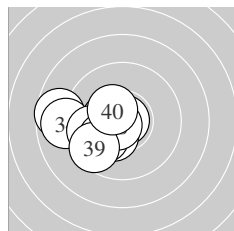

Serie 4:

10.4 *	10.9 *	8.7 ←	8.9 ←	9.8 ←
10.3 *	10.1 ↖	10.7 *	9.6 ↖	10.4 *

beste Teiler 16.5 (32.) 62.4 (38.) 135.9 (40.)
 Trefferlage 2.12 mm links, 0.46 mm tief
 Streuwert 1.55, horizontal: 1.93, vertikal: 1.05

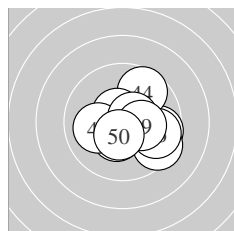

Serie 5:

9.6 →	9.5 ↘	10.4 *	9.7 ↗	10.6 *
9.7 →	10.1 ←	10.6 *	10.3 *	10.5 *

beste Teiler 91.2 (45.) 100.6 (48.) 119.6 (50.)
 Trefferlage 1.01 mm rechts, 0.32 mm tief
 Streuwert 1.62, horizontal: 1.85, vertikal: 1.34

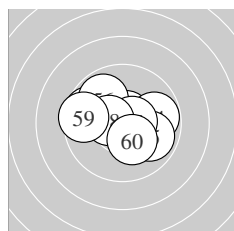

Serie 6:

10.7 *	9.7 ↘	10.2 *	9.8 →	9.9 →
9.9 ↘	10.6 *	10.5 *	9.5 ←	10.3 *

beste Teiler 72.4 (51.) 87.1 (57.) 123.1 (58.)
 Trefferlage 0.35 mm links, 0.36 mm hoch
 Streuwert 1.69, horizontal: 2.15, vertikal: 1.06

Meyton Elektronik

ISSF AR Women – Wertung – Frauen

StandNr: 142

Edlyn, Nadra Mohammed Sophian #70811186

StartNr: 136

21. Januar 2019 13:42

SGP

Unterschrift des Schützen

Meyton Elektronik

Ergebnis:	626.6	(598)					
Serien:	104.7	104.6	105.7	103.8	104.0	103.8	
Zähler:	58	2	0	0	0	0	0
Innenzehner:	53						
weiteste:	308 (39), 274 (41), 247 (3)						
beste Teiler	37.1 (50.) 39.3 (5.) 42.1 (37.)						
Trefferlage	0.21 mm links, 0.16 mm hoch						
Streuwert	1.00, horizontal: 0.96, vertikal: 1.03						

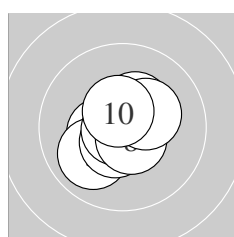
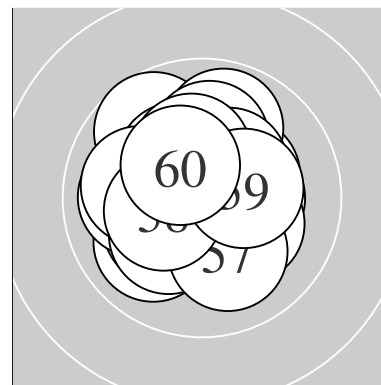

Serie 1:	10.5 *	10.4 *	10.0 ↙	10.5 *	10.8 *
	10.4 *	10.7 *	10.6 *	10.3 *	10.5 *
beste Teiler	39.3 (5.) 63.1 (7.) 89.2 (8.)				
Trefferlage	0.01 mm rechts, 0.02 mm tief				
Streuwert	0.98, horizontal: 1.04, vertikal: 0.92				

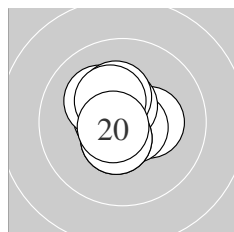

Serie 2:	10.3 *	10.7 *	10.5 *	10.6 *	10.5 *
	10.2 *	10.5 *	10.3 *	10.3 *	10.7 *
beste Teiler	67.0 (20.) 69.3 (12.) 88.8 (14.)				
Trefferlage	0.27 mm links, 0.28 mm hoch				
Streuwert	0.92, horizontal: 0.85, vertikal: 0.98				

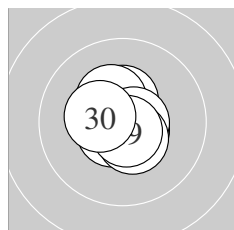

Serie 3:	10.4 *	10.6 *	10.7 *	10.8 *	10.6 *
	10.3 *	10.7 *	10.5 *	10.7 *	10.4 *
beste Teiler	48.8 (24.) 62.2 (29.) 62.4 (23.)				
Trefferlage	0.11 mm links, 0.12 mm hoch				
Streuwert	0.76, horizontal: 0.70, vertikal: 0.81				

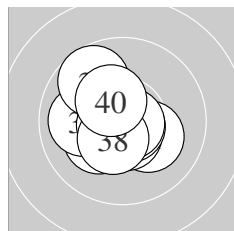

Serie 4:	10.2 *	10.2 *	10.0 ←	10.6 *	10.7 *
	10.7 *	10.8 *	10.5 *	9.7 ↘	10.4 *
beste Teiler	42.1 (37.) 55.4 (36.) 69.6 (35.)				
Trefferlage	0.50 mm links, 0.09 mm tief				
Streuwert	1.18, horizontal: 1.21, vertikal: 1.15				

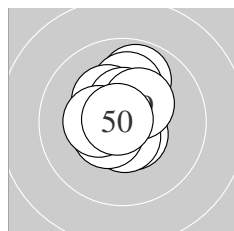

Serie 5:	9.9 ↑	10.6 *	10.1 ↑	10.3 *	10.6 *
	10.5 *	10.5 *	10.4 *	10.3 *	10.8 *
beste Teiler	37.1 (50.) 93.0 (45.) 98.2 (42.)				
Trefferlage	0.08 mm links, 0.63 mm hoch				
Streuwert	1.06, horizontal: 0.83, vertikal: 1.25				

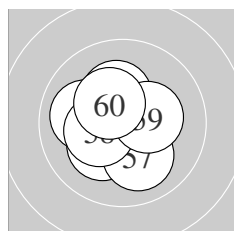

Serie 6:	10.7 *	10.7 *	10.8 *	10.0 ←	10.3 *
	10.2 *	10.1 ↘	10.3 *	10.3 *	10.4 *
beste Teiler	42.8 (53.) 56.8 (51.) 57.3 (52.)				
Trefferlage	0.33 mm links, 0.04 mm hoch				
Streuwert	1.15, horizontal: 1.18, vertikal: 1.12				

Meyton Elektronik

ISSF AR Women – Wertung – Frauen

StandNr: 143

Sajjanar, Meghana Mallikarjun #70811345

StartNr: 137

21. Januar 2019 13:51

India

Unterschrift des Schützen

Meyton Elektronik

Ergebnis: **619.9** (592)

Serien: 102.7 102.9 105.1 103.1 103.7 102.4

Zähler: 52 8 0 0 0 0 0 0 0

Innenzehner: 45

weiteste: 335 (6), 327 (54), 310 (48)

beste Teiler 36.2 (26.) 40.7 (52.) 51.0 (3.)

Trefferlage 0.16 mm rechts, 0.07 mm tief

Streuwert 1.22, horizontal: 1.39, vertikal: 1.03

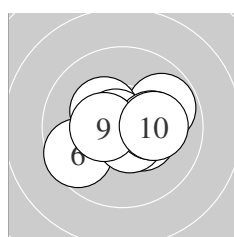
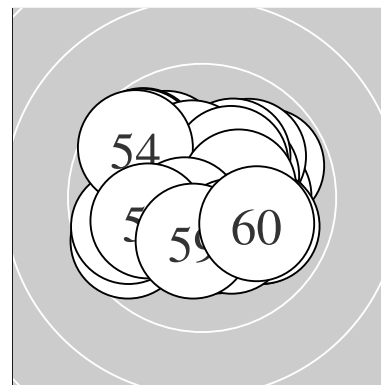

Serie 1:

9.8 ↗	10.3 *	10.7 *	10.5 *	10.4 *
9.6 ↙	10.6 *	10.2 *	10.5 *	10.1 →

beste Teiler 51.0 (3.) 86.8 (7.) 107.3 (4.)

Trefferlage 0.13 mm rechts, 0.03 mm tief

Streuwert 1.39, horizontal: 1.77, vertikal: 0.85

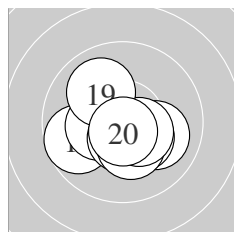

Serie 2:

9.7 ↙	10.5 *	10.0 ↘	10.3 *	10.5 *
10.4 *	10.3 *	10.5 *	10.0 ↘	10.7 *

beste Teiler 61.0 (20.) 101.5 (12.) 104.1 (15.)

Trefferlage 0.19 mm links, 0.47 mm tief

Streuwert 1.27, horizontal: 1.50, vertikal: 0.98

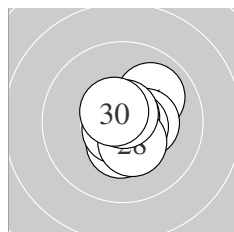

Serie 3:

10.0 ↗	10.4 *	10.4 *	10.5 *	10.6 *
10.8 *	10.7 *	10.4 *	10.7 *	10.6 *

beste Teiler 36.2 (26.) 53.6 (29.) 61.7 (27.)

Trefferlage 0.43 mm rechts, 0.12 mm tief

Streuwert 0.86, horizontal: 0.77, vertikal: 0.95

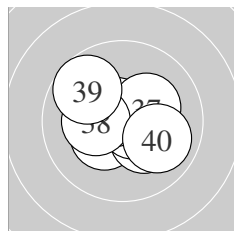

Serie 4:

10.3 *	10.6 *	10.5 *	10.2 *	10.7 *
10.7 *	10.2 *	10.3 *	9.7 ↘	9.9 ↘

beste Teiler 73.8 (36.) 75.8 (35.) 98.2 (32.)

Trefferlage 0.22 mm rechts, 0.03 mm hoch

Streuwert 1.31, horizontal: 1.54, vertikal: 1.02

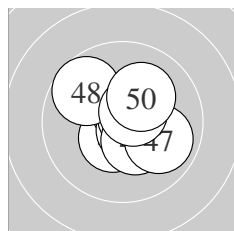

Serie 5:

10.5 *	10.6 *	10.7 *	10.7 *	10.5 *
10.4 *	9.9 ↘	9.7 ↘	10.6 *	10.1 ↗

beste Teiler 69.3 (44.) 73.5 (43.) 86.6 (42.)

Trefferlage 0.44 mm rechts, 0.16 mm hoch

Streuwert 1.19, horizontal: 1.24, vertikal: 1.14

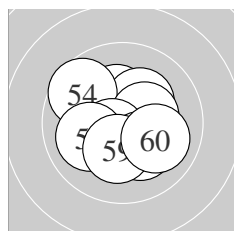

Serie 6:

10.3 *	10.8 *	10.2 *	9.6 ↘	10.4 *
10.6 *	10.2 *	10.0 ↙	10.3 *	10.0 ↘

beste Teiler 40.7 (52.) 94.7 (56.) 149.3 (55.)

Trefferlage 0.03 mm links, 0.00 mm

Streuwert 1.44, horizontal: 1.54, vertikal: 1.33

Meyton Elektronik

ISSF AR Women – Wertung – Frauen

StandNr: 144

Auer, Marie–Theres #352

StartNr: 138

21. Januar 2019 13:37

AUT

Unterschrift des Schützen

Meyton Elektronik

Ergebnis: **624.7** (595)
 Serien: 103.7 105.0 105.3 104.7 102.2 103.8
 Zähler: 55 5 0 0 0 0 0 0 0 0
 Innenzehner: 50
 weiteste: 317 (4), 309 (45), 296 (41)
 beste Teiler 19.1 (13.) 22.0 (35.) 42.2 (10.)
 Trefferlage 0.01 mm links, 0.03 mm tief
 Streuwert 1.09, horizontal: 1.14, vertikal: 1.04

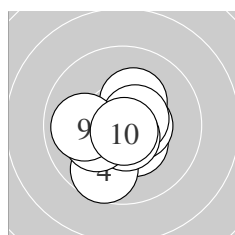
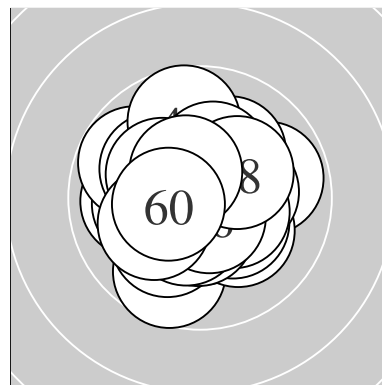

Serie 1:
 10.4 * 10.5 * 10.7 * 9.7 ↙ 10.3 *
 10.6 * 10.6 * 10.2 * 9.9 ← 10.8 *
 beste Teiler 42.2 (10.) 59.4 (3.) 82.2 (7.)
 Trefferlage 0.14 mm links, 0.37 mm tief
 Streuwert 1.21, horizontal: 1.23, vertikal: 1.20

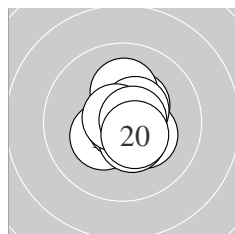

Serie 2:
 10.3 * 10.4 * 10.9 * 10.2 * 10.3 *
 10.5 * 10.5 * 10.7 * 10.7 * 10.5 *
 beste Teiler 19.1 (13.) 52.6 (18.) 69.4 (19.)
 Trefferlage 0.35 mm rechts, 0.05 mm hoch
 Streuwert 0.91, horizontal: 0.79, vertikal: 1.02

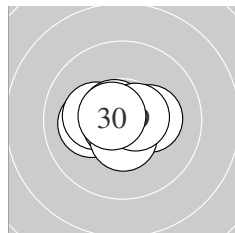

Serie 3:
 10.7 * 10.7 * 10.1 ← 10.2 * 10.3 *
 10.8 * 10.7 * 10.5 * 10.6 * 10.7 *
 beste Teiler 48.7 (26.) 52.3 (22.) 66.0 (21.)
 Trefferlage 0.16 mm links, 0.03 mm tief
 Streuwert 0.89, horizontal: 1.18, vertikal: 0.45

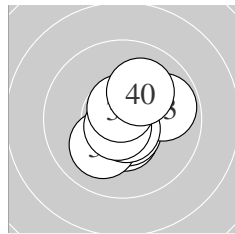

Serie 4:
 10.5 * 10.6 * 9.8 → 10.6 * 10.9 *
 10.1 ↘ 10.7 * 10.7 * 10.7 * 10.1 ↗
 beste Teiler 22.0 (35.) 59.0 (38.) 68.7 (37.)
 Trefferlage 0.24 mm rechts, 0.25 mm tief
 Streuwert 1.06, horizontal: 1.06, vertikal: 1.06

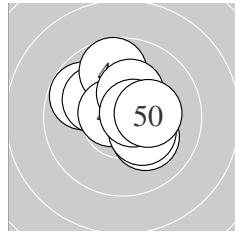

Serie 5:
 9.8 ↖ 10.2 * 10.2 * 10.1 ↖ 9.7 ↑
 10.6 * 10.3 * 10.3 * 10.7 * 10.3 *
 beste Teiler 75.6 (49.) 77.2 (46.) 162.4 (47.)
 Trefferlage 0.12 mm links, 0.70 mm hoch
 Streuwert 1.38, horizontal: 1.49, vertikal: 1.27

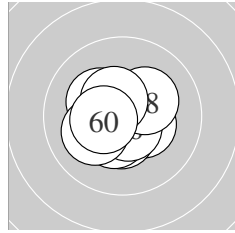

Serie 6:
 10.6 * 10.4 * 10.4 * 10.4 * 10.2 *
 10.6 * 10.1 ← 10.2 * 10.5 * 10.4 *
 beste Teiler 83.6 (56.) 84.7 (51.) 118.5 (59.)
 Trefferlage 0.22 mm links, 0.28 mm tief
 Streuwert 1.04, horizontal: 1.14, vertikal: 0.93

Meyton Elektronik

ISSF AR Women – Wertung – Frauen

StandNr: 145

Bordet, Jade #70811346

StartNr: 139

21. Januar 2019 13:30

FRA

Unterschrift des Schützen

Meyton Elektronik

Ergebnis: **618.4** (595)

Serien: 102.3 102.2 103.5 102.5 104.0 103.9

Zähler: 55 5 0 0 0 0 0 0 0 0

Innenzehner: 41

weiteste: 350 (16), 297 (36), 277 (11)

beste Teiler 54.0 (44.) 70.2 (26.) 73.4 (30.)

Trefferlage 0.25 mm rechts, 0.08 mm hoch

Streuwert 1.23, horizontal: 1.32, vertikal: 1.12

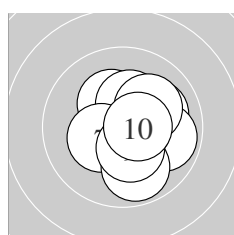
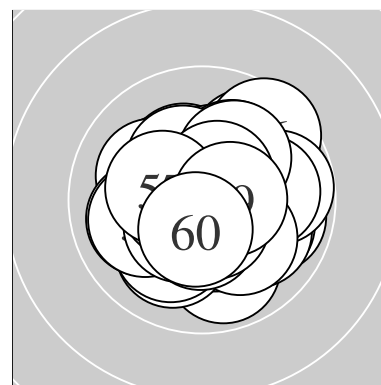

Serie 1:

10.4 *	10.3 *	10.3 *	10.1 →	9.9 →
10.1 ↗	10.3 *	9.9 ↓	10.4 *	10.6 *

beste Teiler 100.0 (10.) 142.8 (1.) 144.3 (9.)

Trefferlage 0.76 mm rechts, 0.14 mm tief

Streuwert 1.32, horizontal: 1.21, vertikal: 1.41

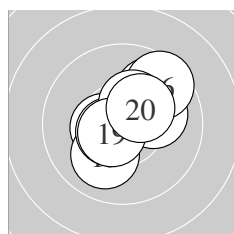

Serie 2:

9.8 ↗	10.5 *	10.0 ↙	10.1 →	10.3 *
9.6 ↗	10.6 *	10.4 *	10.6 *	10.3 *

beste Teiler 88.4 (19.) 96.3 (17.) 122.1 (12.)

Trefferlage 0.52 mm rechts, 0.55 mm hoch

Streuwert 1.38, horizontal: 1.38, vertikal: 1.37

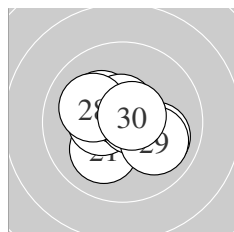

Serie 3:

10.1 ↙	10.0 →	10.2 *	10.4 *	10.7 *
10.7 *	10.6 *	10.1 ↖	10.0 →	10.7 *

beste Teiler 70.2 (26.) 73.4 (30.) 75.8 (25.)

Trefferlage 0.05 mm links, 0.04 mm hoch

Streuwert 1.25, horizontal: 1.45, vertikal: 1.01

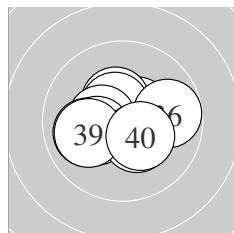

Serie 4:

10.5 *	10.4 *	10.5 *	10.4 *	10.0 ←
9.8 →	10.2 *	10.4 *	10.0 ←	10.3 *

beste Teiler 107.3 (33.) 113.4 (31.) 136.9 (32.)

Trefferlage 0.26 mm links, 0.07 mm tief

Streuwert 1.36, horizontal: 1.71, vertikal: 0.88

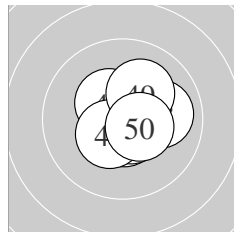

Serie 5:

10.5 *	10.2 *	10.6 *	10.7 *	10.6 *
10.4 *	10.4 *	10.0 →	10.1 ↗	10.5 *

beste Teiler 54.0 (44.) 88.2 (45.) 88.8 (43.)

Trefferlage 0.46 mm rechts, 0.19 mm hoch

Streuwert 1.02, horizontal: 1.09, vertikal: 0.95

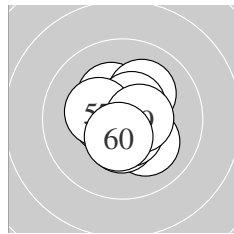

Serie 6:

10.3 *	10.1 ↗	10.1 ↘	10.5 *	10.4 *
10.6 *	10.3 *	10.6 *	10.5 *	10.5 *

beste Teiler 96.6 (58.) 97.1 (56.) 104.2 (54.)

Trefferlage 0.12 mm rechts, 0.03 mm tief

Streuwert 1.09, horizontal: 1.02, vertikal: 1.15

Meyton Elektronik

ISSF AR Women – Wertung – Frauen

StandNr: 146

Züger, Muriel #70811347

StartNr: 140

21. Januar 2019 13:46

SUI – SZ

Unterschrift des Schützen

Meyton Elektronik

Ergebnis: **623.3** (593)
 Serien: 103.7 104.0 104.8 104.3 103.0 103.5
 Zähler: 53 7 0 0 0 0 0 0 0
 Innenzehner: 47
 weiteste: 324 (14), 316 (23), 305 (3)
 beste Teiler 26.2 (40.) 35.2 (4.) 37.8 (12.)
 Trefferlage 0.09 mm rechts, 0.32 mm hoch
 Streuwert 1.13, horizontal: 1.20, vertikal: 1.05

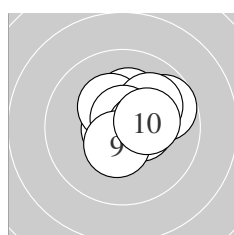
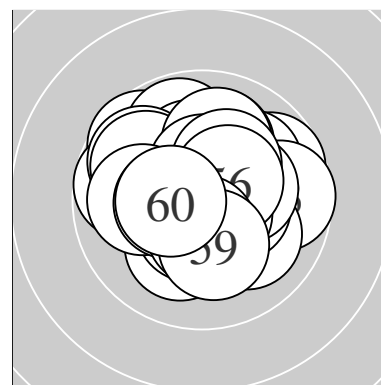

Serie 1:
 10.7 * 10.2 * 9.7 ↗ 10.8 * 10.3 *
 10.0 ↗ 10.7 * 10.5 * 10.5 * 10.3 *
 beste Teiler 35.2 (4.) 56.7 (1.) 58.2 (7.)
 Trefferlage 0.61 mm rechts, 0.51 mm hoch
 Streuwert 1.07, horizontal: 1.18, vertikal: 0.95

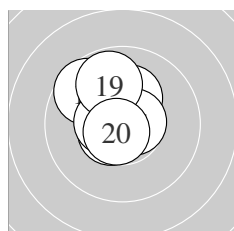

Serie 2:
 10.4 * 10.8 * 10.6 * 9.7 ↘ 10.2 *
 10.6 * 10.7 * 10.5 * 9.8 ↗ 10.7 *
 beste Teiler 37.8 (12.) 66.0 (20.) 73.5 (17.)
 Trefferlage 0.40 mm links, 0.84 mm hoch
 Streuwert 1.03, horizontal: 0.93, vertikal: 1.12

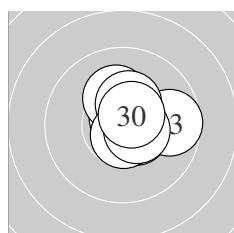

Serie 3:
 10.6 * 10.6 * 9.7 → 10.8 * 10.2 *
 10.7 * 10.4 * 10.7 * 10.5 * 10.6 *
 beste Teiler 48.0 (24.) 68.3 (28.) 75.6 (26.)
 Trefferlage 0.66 mm rechts, 0.37 mm hoch
 Streuwert 0.91, horizontal: 0.98, vertikal: 0.83

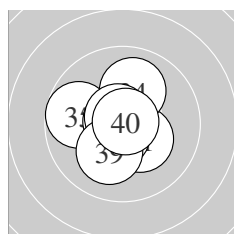

Serie 4:
 10.3 * 10.5 * 10.6 * 10.0 ↑ 9.7 ←
 10.8 * 10.8 * 10.7 * 10.1 ↓ 10.8 *
 beste Teiler 26.2 (40.) 44.5 (36.) 47.1 (37.)
 Trefferlage 0.39 mm links, 0.05 mm tief
 Streuwert 1.12, horizontal: 1.10, vertikal: 1.14

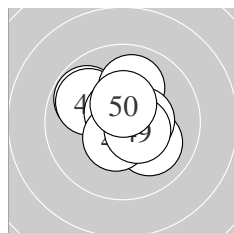

Serie 5:
 9.8 ↘ 9.9 ↘ 10.0 ↑ 10.7 * 10.0 ↘
 10.4 * 10.7 * 10.5 * 10.5 * 10.5 *
 beste Teiler 64.0 (47.) 69.4 (44.) 113.6 (49.)
 Trefferlage 0.02 mm links, 0.37 mm hoch
 Streuwert 1.32, horizontal: 1.40, vertikal: 1.23

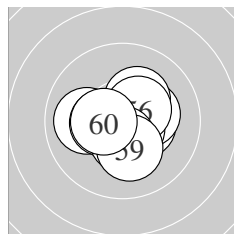

Serie 6:
 10.0 ← 10.4 * 10.3 * 10.6 * 10.3 *
 10.4 * 10.4 * 10.5 * 10.2 * 10.4 *
 beste Teiler 80.7 (54.) 124.0 (58.) 127.0 (60.)
 Trefferlage 0.10 mm rechts, 0.13 mm tief
 Streuwert 1.16, horizontal: 1.35, vertikal: 0.94

Meyton Elektronik

ISSF AR Women – Wertung – Frauen

StandNr: 147

Emily, Stith #70811348

StartNr: 141

21. Januar 2019 13:36

USA

Unterschrift des Schützen

Meyton Elektronik