

Ergebnis:	625.3	(594)							
Serien:	104.4	101.7	104.2	103.5	106.2	105.3			
Zähler:	54	6	0	0	0	0	0	0	0
Innenzehner:	50								
weiteste:	426 (14), 293 (36), 287 (32)								
beste Teiler	31.3 (48.)	36.0 (2.)	36.2 (42.)						
Trefferlage	0.08 mm links, 0.30 mm hoch								
Streuwert	1.08, horizontal: 1.15, vertikal: 1.00								

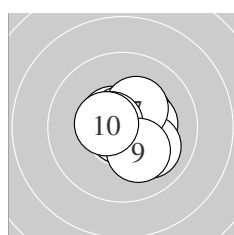

Serie 1:	10.4 *	10.8 *	10.3 *	10.0 ↘	10.6 *
	10.7 *	10.3 *	10.6 *	10.2 *	10.5 *
beste Teiler	36.0 (2.)	61.8 (6.)	84.4 (8.)		
Trefferlage	0.39 mm rechts, 0.06 mm hoch				
Streuwert	1.01, horizontal: 1.09, vertikal: 0.92				

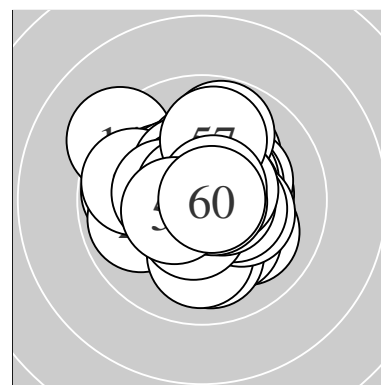
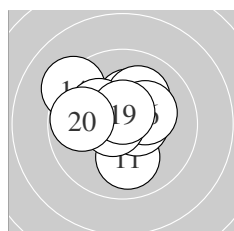

Serie 2:	10.0 ↓	10.6 *	10.3 *	9.2 ↘	10.1 ↗
	10.2 *	10.2 *	10.7 *	10.6 *	9.8 ←
beste Teiler	68.0 (18.)	84.0 (19.)	99.0 (12.)		
Trefferlage	0.42 mm links, 0.65 mm hoch				
Streuwert	1.53, horizontal: 1.71, vertikal: 1.32				

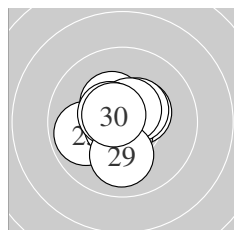

Serie 3:	10.4 *	10.7 *	9.9 ←	10.4 *	10.7 *
	10.4 *	10.6 *	10.5 *	10.0 ↓	10.6 *
beste Teiler	54.0 (25.)	73.6 (22.)	80.2 (30.)		
Trefferlage	0.28 mm links, 0.06 mm hoch				
Streuwert	1.08, horizontal: 1.08, vertikal: 1.09				

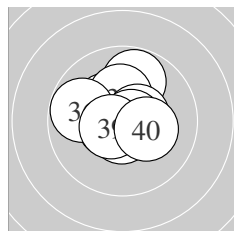

Serie 4:	10.6 *	9.8 ↑	10.6 *	10.3 *	10.3 *
	9.8 ←	10.5 *	10.7 *	10.6 *	10.3 *
beste Teiler	60.0 (38.)	76.2 (31.)	89.4 (39.)		
Trefferlage	0.18 mm links, 0.47 mm hoch				
Streuwert	1.22, horizontal: 1.31, vertikal: 1.13				

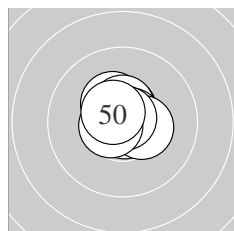

Serie 5:	10.4 *	10.8 *	10.6 *	10.5 *	10.8 *
	10.7 *	10.4 *	10.8 *	10.6 *	10.6 *
beste Teiler	31.3 (48.)	36.2 (42.)	46.8 (45.)		
Trefferlage	0.03 mm links, 0.32 mm hoch				
Streuwert	0.64, horizontal: 0.67, vertikal: 0.61				

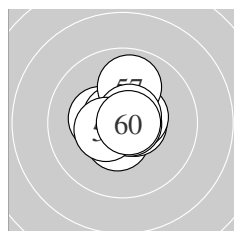

Serie 6:	10.5 *	10.6 *	10.5 *	10.3 *	10.8 *
	10.7 *	9.9 ↑	10.7 *	10.5 *	10.8 *
beste Teiler	41.0 (60.)	49.6 (55.)	66.4 (58.)		
Trefferlage	0.00 mm, 0.24 mm hoch				
Streuwert	0.90, horizontal: 0.86, vertikal: 0.94				

ISSF AR Women – Wertung – Frauen

StandNr: 101

Mazurova, Nikola #225

StartNr: 1

22. Januar 2019 9:54

CZE

Unterschrift des Schützen

Meyton Elektronik

Ergebnis:	622.6	(594)							
Serien:	103.8	102.8	104.3	103.0	104.2	104.5			
Zähler:	54	6	0	0	0	0	0	0	0
Innenzehner:	48								
weiteste:	416 (36), 415 (20), 310 (40)								
beste Teiler	3.6 (32.) 13.3 (38.) 38.0 (26.)								
Trefferlage	0.00 mm , 0.14 mm hoch								
Streuwert	1.18, horizontal: 1.32, vertikal: 1.02								

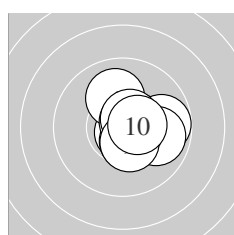
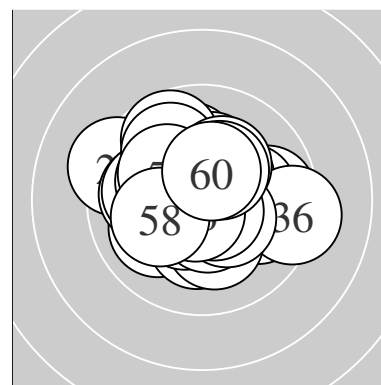

Serie 1:

10.8 *	10.5 *	10.5 *	10.0 ↑	9.8 →
10.7 *	10.6 *	9.9 →	10.5 *	10.5 *
beste Teiler	40.5 (1.) 62.3 (6.) 84.2 (7.)			
Trefferlage	0.92 mm rechts, 0.07 mm hoch			
Streuwert	1.02, horizontal: 1.07, vertikal: 0.97			

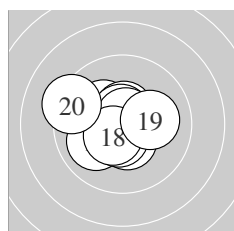

Serie 2:

10.0 ↙	10.4 *	10.2 *	10.5 *	10.5 *
10.6 *	10.7 *	10.5 *	10.1 →	9.3 ↖
beste Teiler	56.3 (17.) 79.0 (16.) 101.4 (14.)			
Trefferlage	0.56 mm links, 0.08 mm hoch			
Streuwert	1.36, horizontal: 1.60, vertikal: 1.07			

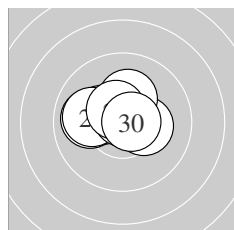

Serie 3:

10.8 *	10.3 *	10.7 *	10.0 ←	10.0 ←
10.8 *	10.3 *	10.2 *	10.5 *	10.7 *
beste Teiler	38.0 (26.) 43.5 (21.) 64.0 (23.)			
Trefferlage	0.38 mm links, 0.48 mm hoch			
Streuwert	1.02, horizontal: 1.34, vertikal: 0.56			

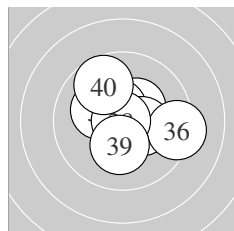

Serie 4:

10.4 *	10.9 *	10.5 *	10.6 *	10.3 *
9.3 →	10.2 *	10.9 *	10.2 *	9.7 ↖
beste Teiler	3.6 (32.) 13.3 (38.) 93.6 (34.)			
Trefferlage	0.27 mm rechts, 0.18 mm hoch			
Streuwert	1.48, horizontal: 1.65, vertikal: 1.27			

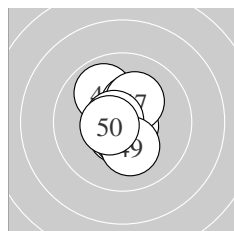

Serie 5:

10.6 *	10.5 *	10.5 *	10.7 *	9.9 ↖
10.4 *	10.2 *	10.7 *	10.2 *	10.5 *
beste Teiler	56.0 (44.) 66.7 (48.) 95.4 (41.)			
Trefferlage	0.15 mm links, 0.18 mm hoch			
Streuwert	1.06, horizontal: 0.78, vertikal: 1.28			

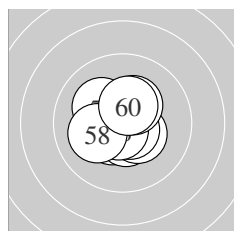

Serie 6:

10.7 *	10.5 *	10.5 *	10.4 *	10.7 *
10.7 *	10.2 *	10.1 ↙	10.3 *	10.4 *
beste Teiler	60.9 (51.) 63.0 (56.) 75.7 (55.)			
Trefferlage	0.09 mm links, 0.12 mm tief			
Streuwert	1.01, horizontal: 1.02, vertikal: 0.99			

Meyton Elektronik

ISSF AR Women – Wertung – Frauen

StandNr: 102

Züger, Muriel #70811347

StartNr: 2

22. Januar 2019 9:55

SUI – SZ

Unterschrift des Schützen

Meyton Elektronik

Ergebnis:	628.2	(597) ^{QF}							
Serien:	102.9	103.1	105.6	105.1	105.2	106.3			
Zähler:	57	3	0	0	0	0	0	0	0
Innenzehner:	55								
weiteste:	350 (6), 309 (2), 264 (7)								
beste Teiler	7.0 (56.)	9.8 (50.)	37.9 (24.)						
Trefferlage	0.14 mm links, 0.18 mm hoch								
Streuwert	0.96, horizontal: 1.04, vertikal: 0.88								

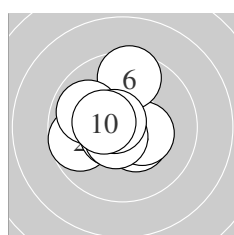
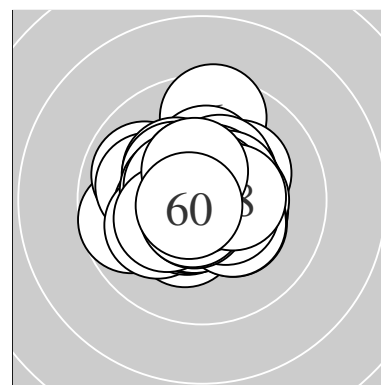

Serie 1:	10.4 *	9.7 ←	10.6 *	10.4 *	10.6 *
	9.6 ↑	9.9 ↖	10.6 *	10.7 *	10.4 *
beste Teiler	70.4 (9.) 81.8 (8.) 88.3 (3.)				
Trefferlage	0.49 mm links, 0.17 mm hoch				
Streuwert	1.39, horizontal: 1.45, vertikal: 1.32				

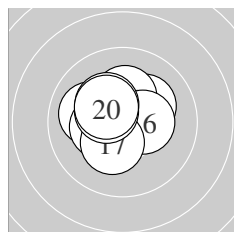

Serie 2:	10.2 *	10.0 ↖	10.3 *	10.6 *	10.3 *
	10.4 *	10.3 *	10.3 *	10.4 *	10.3 *
beste Teiler	76.9 (14.) 136.1 (19.) 142.0 (16.)				
Trefferlage	0.44 mm links, 0.54 mm hoch				
Streuwert	1.10, horizontal: 1.25, vertikal: 0.91				

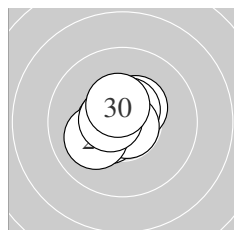

Serie 3:	10.5 *	10.4 *	10.6 *	10.8 *	10.6 *
	10.7 *	10.8 *	10.1 ↖	10.6 *	10.5 *
beste Teiler	37.9 (24.) 43.8 (27.) 60.5 (26.)				
Trefferlage	0.39 mm links, 0.13 mm hoch				
Streuwert	0.79, horizontal: 0.84, vertikal: 0.74				

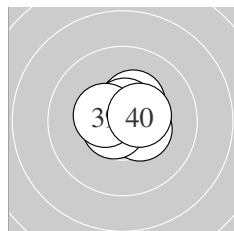

Serie 4:	10.5 *	10.4 *	10.8 *	10.4 *	10.5 *
	10.7 *	10.3 *	10.6 *	10.4 *	10.5 *
beste Teiler	46.0 (33.) 72.6 (36.) 78.6 (38.)				
Trefferlage	0.34 mm rechts, 0.50 mm hoch				
Streuwert	0.74, horizontal: 0.83, vertikal: 0.64				

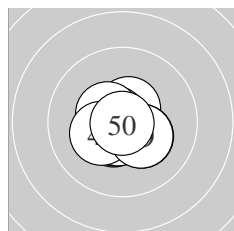

Serie 5:	10.5 *	10.7 *	10.5 *	10.5 *	10.3 *
	10.6 *	10.6 *	10.3 *	10.3 *	10.9 *
beste Teiler	9.8 (50.) 59.4 (42.) 89.3 (47.)				
Trefferlage	0.15 mm links, 0.36 mm tief				
Streuwert	0.83, horizontal: 0.93, vertikal: 0.73				

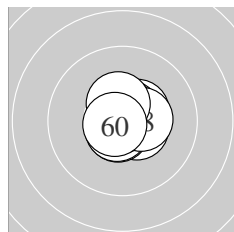

Serie 6:	10.5 *	10.5 *	10.7 *	10.7 *	10.7 *
	10.9 *	10.7 *	10.4 *	10.5 *	10.7 *
beste Teiler	7.0 (56.) 60.0 (60.) 65.0 (57.)				
Trefferlage	0.25 mm rechts, 0.11 mm hoch				
Streuwert	0.65, horizontal: 0.68, vertikal: 0.62				

Meyton Elektronik

ISSF AR Women – Wertung – Frauen

StandNr: 103

Vinita, Bhardwaj #70811323

StartNr: 3

22. Januar 2019 9:40

IND

QF – Schütze hat sich fürs Finale qualifiziert

Unterschrift des Schützen

Meyton Elektronik

Ergebnis:	624.4	(596)							
Serien:	104.1	103.8	104.9	103.5	104.3	103.8			
Zähler:	56	4	0	0	0	0	0	0	0
Innenzehner:	50								
weiteste:	368	(33),	317	(40),	293	(18)			
beste Teiler	1.4	(31.)	22.0	(58.)	27.2	(34.)			
Trefferlage	0.25	mm links,	0.06	mm hoch					
Streuwert	1.08,	horizontal:	1.16,	vertikal:	0.99				

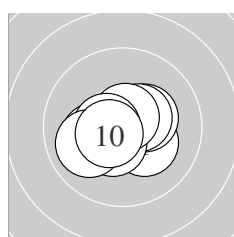
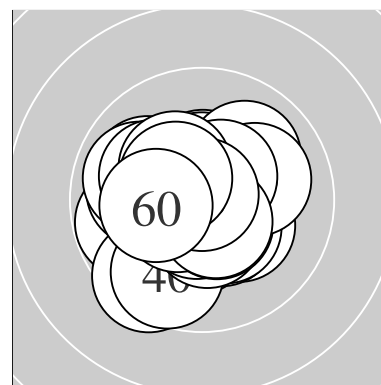

Serie 1:

10.2 *	10.3 *	10.6 *	10.5 *	10.2 *
10.5 *	10.7 *	10.5 *	10.0 ←	10.6 *
beste Teiler	67.4 (7.)	79.6 (3.)	98.8 (10.)	
Trefferlage	0.33 mm links, 0.24 mm tief			
Streuwert	1.05, horizontal: 1.30, vertikal: 0.70			

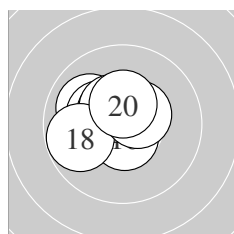

Serie 2:

10.6 *	10.6 *	10.0 ↘	10.3 *	10.5 *
10.6 *	10.5 *	9.8 ←	10.5 *	10.4 *
beste Teiler	83.1 (16.)	99.6 (12.)	100.8 (11.)	
Trefferlage	0.57 mm links, 0.55 mm hoch			
Streuwert	1.04, horizontal: 1.25, vertikal: 0.77			

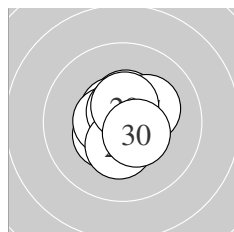

Serie 3:

10.5 *	10.6 *	10.4 *	10.5 *	10.7 *
10.7 *	10.2 *	10.3 *	10.5 *	10.5 *
beste Teiler	70.0 (25.)	71.8 (26.)	93.2 (22.)	
Trefferlage	0.04 mm rechts, 0.16 mm hoch			
Streuwert	0.89, horizontal: 0.85, vertikal: 0.92			

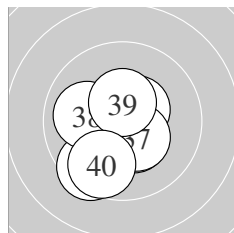

Serie 4:

10.9 *	10.8 *	9.5 ↙	10.8 *	10.4 *
10.5 *	10.4 *	10.0 ←	10.5 *	9.7 ↙
beste Teiler	1.4 (31.)	27.2 (34.)	37.6 (32.)	
Trefferlage	0.31 mm links, 0.57 mm tief			
Streuwert	1.33, horizontal: 1.22, vertikal: 1.44			

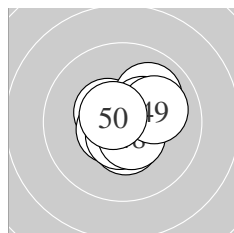

Serie 5:

10.4 *	10.5 *	10.0 ↗	10.6 *	10.7 *
10.3 *	10.6 *	10.5 *	10.1 →	10.6 *
beste Teiler	55.3 (45.)	76.2 (50.)	91.4 (47.)	
Trefferlage	0.37 mm rechts, 0.06 mm hoch			
Streuwert	1.01, horizontal: 1.07, vertikal: 0.95			

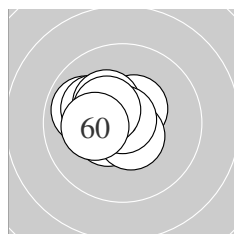

Serie 6:

10.5 *	10.5 *	10.5 *	10.5 *	9.9 ←
10.1 ↘	10.3 *	10.9 *	10.4 *	10.2 *
beste Teiler	22.0 (58.)	102.0 (54.)	103.0 (51.)	
Trefferlage	0.73 mm links, 0.42 mm hoch			
Streuwert	0.97, horizontal: 1.16, vertikal: 0.74			

Meyton Elektronik

ISSF AR Women – Wertung – Frauen

StandNr: 104

Gomez, Judith #70811331

StartNr: 4

22. Januar 2019 9:16

FRA

Unterschrift des Schützen

Meyton Elektronik

Ergebnis:	629.2	(598) ^{QF}						
Serien:	104.3	106.2	105.7	104.1	104.7	104.2		
Zähler:	58	2	0	0	0	0	0	0
Innenzehner:	55							
weiteste:	268 (31), 254 (46), 221 (7)							
beste Teiler	17.4 (28.) 19.7 (42.) 32.4 (29.)							
Trefferlage	0.11 mm rechts, 0.04 mm hoch							
Streuwert	0.92, horizontal: 0.91, vertikal: 0.94							

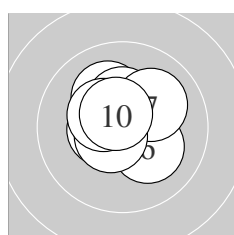
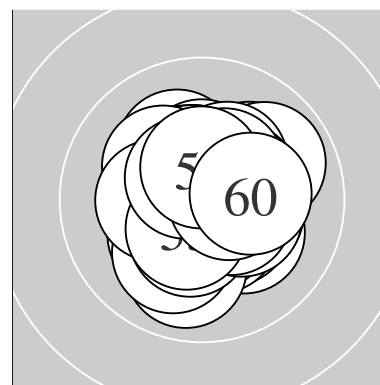

Serie 1:	10.8 *	10.6 *	10.5 *	10.1 ↖	10.4 *
	10.2 *	10.1 ↗	10.6 *	10.4 *	10.6 *
beste Teiler	45.3 (1.) 90.6 (8.) 91.6 (2.)				
Trefferlage	0.14 mm links, 0.53 mm hoch				
Streuwert	1.00, horizontal: 1.04, vertikal: 0.96				

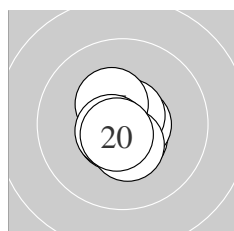

Serie 2:	10.6 *	10.7 *	10.6 *	10.7 *	10.8 *
	10.7 *	10.4 *	10.4 *	10.6 *	10.7 *
beste Teiler	42.0 (15.) 64.0 (16.) 73.4 (20.)				
Trefferlage	0.05 mm links, 0.29 mm tief				
Streuwert	0.63, horizontal: 0.53, vertikal: 0.72				

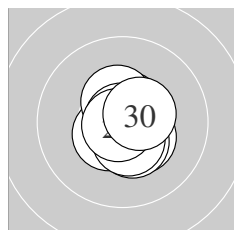

Serie 3:	10.7 *	10.4 *	10.6 *	10.5 *	10.4 *
	10.4 *	10.5 *	10.9 *	10.8 *	10.5 *
beste Teiler	17.4 (28.) 32.4 (29.) 52.0 (21.)				
Trefferlage	0.17 mm rechts, 0.08 mm tief				
Streuwert	0.75, horizontal: 0.61, vertikal: 0.87				

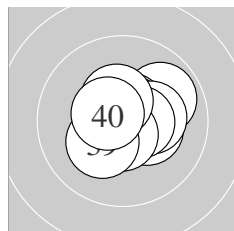

Serie 4:	9.9 ↗	10.3 *	10.6 *	10.7 *	10.3 *
	10.6 *	10.6 *	10.4 *	10.2 *	10.5 *
beste Teiler	71.4 (34.) 83.2 (37.) 83.7 (33.)				
Trefferlage	0.47 mm rechts, 0.19 mm hoch				
Streuwert	1.02, horizontal: 1.16, vertikal: 0.86				

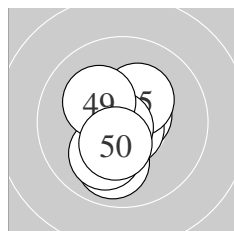

Serie 5:	10.6 *	10.9 *	10.8 *	10.7 *	10.3 *
	9.9 ↓	10.8 *	10.1 ↙	10.2 *	10.4 *
beste Teiler	19.7 (42.) 48.8 (47.) 50.0 (43.)				
Trefferlage	0.24 mm links, 0.28 mm tief				
Streuwert	1.05, horizontal: 0.75, vertikal: 1.28				

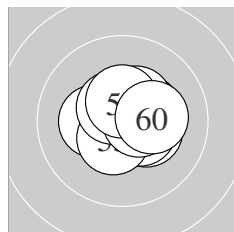

Serie 6:	10.3 *	10.4 *	10.3 *	10.5 *	10.5 *
	10.5 *	10.6 *	10.4 *	10.5 *	10.2 *
beste Teiler	100.0 (57.) 101.6 (56.) 118.9 (54.)				
Trefferlage	0.46 mm rechts, 0.18 mm hoch				
Streuwert	0.96, horizontal: 1.13, vertikal: 0.76				

Meyton Elektronik

ISSF AR Women – Wertung – Frauen

StandNr: 105

Peer, Franziska #351

StartNr: 5

22. Januar 2019 9:33

AUT

QF – Schütze hat sich fürs Finale qualifiziert

Unterschrift des Schützen

Meyton Elektronik

Ergebnis: **630.3** (597)^{QF}
 Serien: 106.1 103.4 105.4 105.7 104.9 104.8
 Zähler: 57 3 0 0 0 0 0 0 0 0
 Innenzehner: 53
 weiteste: 383 (19), 323 (18), 256 (54)
 beste Teiler 8.0 (33.) 10.0 (39.) 11.0 (44.)
 Trefferlage 0.10 mm links, 0.02 mm hoch
 Streuwert 0.96, horizontal: 1.11, vertikal: 0.77

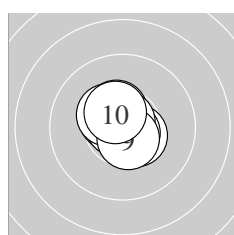
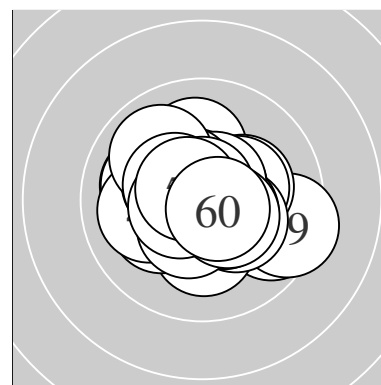

Serie 1:
 10.5 * 10.8 * 10.5 * 10.5 * 10.7 *
 10.8 * 10.8 * 10.4 * 10.6 * 10.5 *
 beste Teiler 37.0 (2.) 39.0 (7.) 46.4 (6.)
 Trefferlage 0.18 mm links, 0.25 mm hoch
 Streuwert 0.67, horizontal: 0.65, vertikal: 0.69

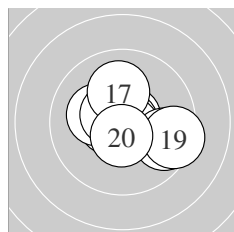

Serie 2:
 10.7 * 10.8 * 10.6 * 10.7 * 10.2 *
 10.6 * 10.1 ↑ 9.7 ↘ 9.4 → 10.6 *
 beste Teiler 31.0 (12.) 59.4 (14.) 60.2 (11.)
 Trefferlage 0.39 mm rechts, 0.02 mm tief
 Streuwert 1.40, horizontal: 1.71, vertikal: 1.01

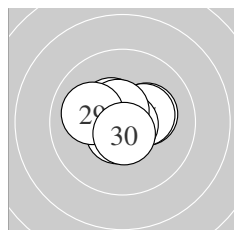

Serie 3:
 10.2 * 10.5 * 10.9 * 10.8 * 10.3 *
 10.6 * 10.8 * 10.6 * 10.1 ← 10.6 *
 beste Teiler 14.7 (23.) 35.7 (27.) 37.0 (24.)
 Trefferlage 0.00 mm , 0.22 mm hoch
 Streuwert 0.90, horizontal: 1.11, vertikal: 0.62

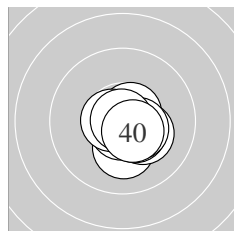

Serie 4:
 10.2 * 10.7 * 10.9 * 10.3 * 10.6 *
 10.6 * 10.5 * 10.5 * 10.9 * 10.5 *
 beste Teiler 8.0 (33.) 10.0 (39.) 57.0 (32.)
 Trefferlage 0.39 mm rechts, 0.47 mm tief
 Streuwert 0.67, horizontal: 0.67, vertikal: 0.68

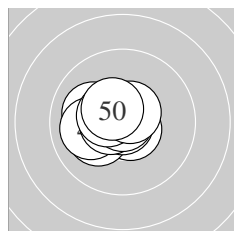

Serie 5:
 10.6 * 10.2 * 10.1 ← 10.9 * 10.0 ←
 10.6 * 10.9 * 10.5 * 10.6 * 10.5 *
 beste Teiler 11.0 (44.) 13.0 (47.) 77.1 (41.)
 Trefferlage 0.77 mm links, 0.07 mm hoch
 Streuwert 0.86, horizontal: 1.05, vertikal: 0.61

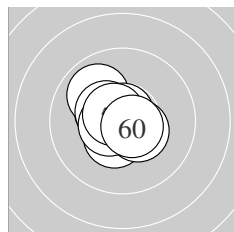

Serie 6:
 10.7 * 10.4 * 10.4 * 9.9 ↘ 10.4 *
 10.4 * 10.6 * 10.8 * 10.6 * 10.6 *
 beste Teiler 48.0 (58.) 62.2 (51.) 78.3 (60.)
 Trefferlage 0.48 mm links, 0.11 mm hoch
 Streuwert 0.89, horizontal: 0.89, vertikal: 0.88

Meyton Elektronik

ISSF AR Women – Wertung – Frauen

StandNr: 106

Chandela, Arpuvi #70811327

StartNr: 6

22. Januar 2019 9:44

India

QF – Schütze hat sich fürs Finale qualifiziert

Unterschrift des Schützen

Meyton Elektronik

Ergebnis:	619.5	(593)						
Serien:	102.7	104.2	104.6	103.3	103.2	101.5		
Zähler:	53	7	0	0	0	0	0	0
Innenzehner:	45							
weiteste:	495 (60), 356 (50), 315 (2)							
beste Teiler	23.4 (53.) 36.4 (58.) 43.2 (27.)							
Trefferlage	0.13 mm rechts, 0.17 mm hoch							
Streuwert	1.26, horizontal: 1.27, vertikal: 1.26							

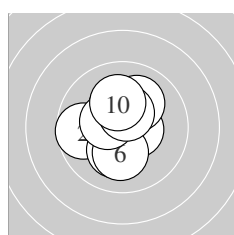
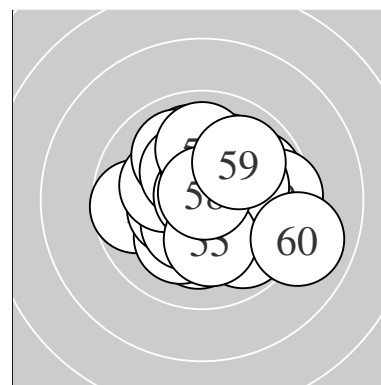

Serie 1:	10.5 *	9.7 ←	10.2 *	10.1 ↗	10.7 *
	10.1 ↓	10.3 *	10.4 *	10.5 *	10.2 *
beste Teiler	57.3 (5.) 106.7 (1.) 116.9 (9.)				
Trefferlage	0.38 mm links, 0.32 mm hoch				
Streuwert	1.32, horizontal: 1.21, vertikal: 1.42				

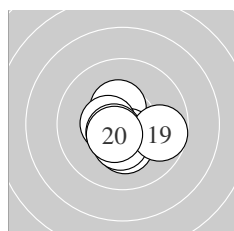

Serie 2:	10.5 *	10.8 *	10.4 *	10.5 *	10.5 *
	10.3 *	10.4 *	10.6 *	9.7 →	10.5 *
beste Teiler	46.6 (12.) 93.4 (18.) 101.0 (11.)				
Trefferlage	0.01 mm links, 0.53 mm tief				
Streuwert	1.03, horizontal: 1.18, vertikal: 0.85				

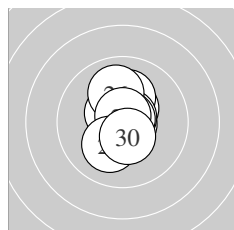

Serie 3:	10.4 *	10.7 *	10.2 *	10.7 *	10.5 *
	10.0 ↑	10.8 *	10.7 *	10.1 ↙	10.5 *
beste Teiler	43.2 (27.) 51.0 (28.) 53.4 (22.)				
Trefferlage	0.04 mm rechts, 0.41 mm hoch				
Streuwert	0.99, horizontal: 0.61, vertikal: 1.26				

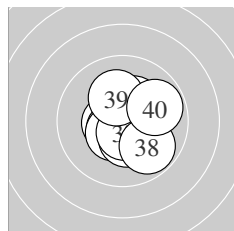

Serie 4:	10.5 *	10.6 *	10.6 *	10.5 *	10.4 *
	10.3 *	10.6 *	9.8 ↘	10.2 *	9.8 →
beste Teiler	82.7 (33.) 89.9 (37.) 92.6 (32.)				
Trefferlage	0.35 mm rechts, 0.11 mm tief				
Streuwert	1.24, horizontal: 1.19, vertikal: 1.29				

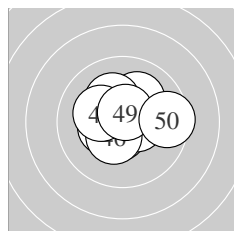

Serie 5:	10.7 *	10.6 *	10.5 *	10.1 ↗	10.4 *
	10.4 *	10.2 *	10.2 *	10.6 *	9.5 →
beste Teiler	61.2 (41.) 80.3 (49.) 92.0 (42.)				
Trefferlage	0.07 mm rechts, 0.30 mm hoch				
Streuwert	1.29, horizontal: 1.54, vertikal: 0.98				

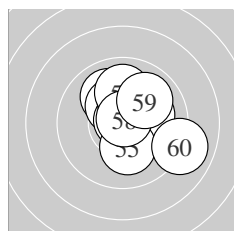

Serie 6:	10.0 ↖	10.3 *	10.9 *	10.1 →	10.2 *
	10.3 *	10.0 ↑	10.8 *	9.9 ↗	9.0 →
beste Teiler	23.4 (53.) 36.4 (58.) 155.3 (52.)				
Trefferlage	0.70 mm rechts, 0.68 mm hoch				
Streuwert	1.61, horizontal: 1.67, vertikal: 1.54				

Meyton Elektronik

ISSF AR Women – Wertung – Frauen

StandNr: 107

Molnar, Eliza #70811333

StartNr: 7

22. Januar 2019 9:57

ROU

Unterschrift des Schützen

Meyton Elektronik

Ergebnis:	620.2	(591)					
Serien:	103.0	103.7	104.3	102.3	104.3	102.6	
Zähler:	51	9	0	0	0	0	0
Innenzehner:	45						
weiteste:	390 (53), 381 (54), 327 (34)						
beste Teiler	6.7 (24.) 28.1 (51.) 33.9 (57.)						
Trefferlage	0.24 mm links, 0.18 mm hoch						
Streuwert	1.23, horizontal: 1.47, vertikal: 0.92						

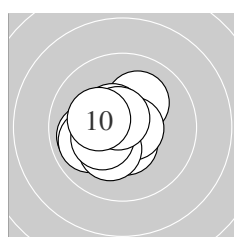
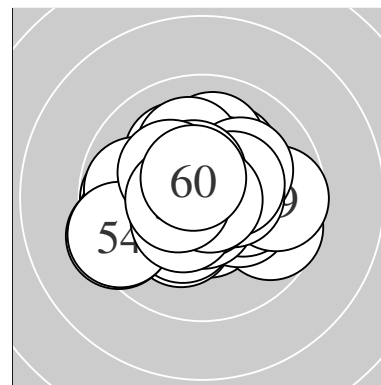

Serie 1:	10.1 ↗	10.5 *	10.7 *	9.9 ←	9.9 ←
	10.2 *	10.3 *	10.5 *	10.7 *	10.2 *
beste Teiler	68.5 (3.) 70.6 (9.) 110.6 (8.)				
Trefferlage	0.78 mm links, 0.13 mm tief				
Streuwert	1.13, horizontal: 1.21, vertikal: 1.05				

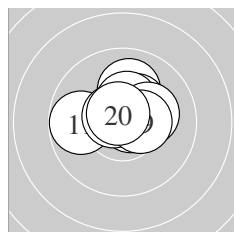

Serie 2:	9.8 ←	10.6 *	10.0 ↑	10.3 *	10.7 *
	10.6 *	10.4 *	10.2 *	10.4 *	10.7 *
beste Teiler	58.5 (15.) 68.8 (20.) 76.5 (16.)				
Trefferlage	0.13 mm rechts, 0.73 mm hoch				
Streuwert	1.05, horizontal: 1.30, vertikal: 0.72				

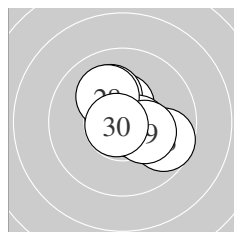

Serie 3:	10.7 *	10.7 *	9.7 ↘	10.9 *	10.5 *
	10.1 ↘	10.5 *	10.1 ↘	10.3 *	10.8 *
beste Teiler	6.7 (24.) 47.8 (30.) 60.1 (22.)				
Trefferlage	0.33 mm rechts, 0.24 mm hoch				
Streuwert	1.14, horizontal: 1.22, vertikal: 1.05				

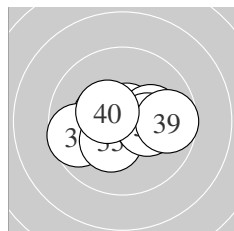

Serie 4:	10.7 *	10.4 *	10.6 *	9.6 ←	10.3 *
	10.2 *	10.2 *	10.2 *	9.7 →	10.4 *
beste Teiler	51.9 (31.) 98.0 (33.) 126.5 (40.)				
Trefferlage	0.17 mm rechts, 0.10 mm tief				
Streuwert	1.46, horizontal: 1.96, vertikal: 0.64				

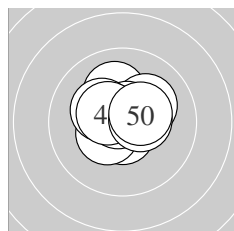

Serie 5:	10.1 ↘	10.1 ↗	10.7 *	10.6 *	10.4 *
	10.8 *	10.3 *	10.5 *	10.4 *	10.4 *
beste Teiler	48.1 (46.) 71.5 (43.) 77.0 (44.)				
Trefferlage	0.00 mm , 0.48 mm hoch				
Streuwert	0.98, horizontal: 1.10, vertikal: 0.85				

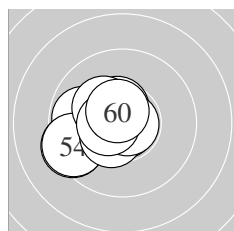

Serie 6:	10.8 *	9.8 ←	9.4 ←	9.4 ←	10.5 *
	10.5 *	10.8 *	10.3 *	10.5 *	10.6 *
beste Teiler	28.1 (51.) 33.9 (57.) 92.7 (60.)				
Trefferlage	1.33 mm links, 0.11 mm tief				
Streuwert	1.24, horizontal: 1.44, vertikal: 1.00				

Meyton Elektronik

ISSF AR Women – Wertung – Frauen

StandNr: 108

Auer, Marie–Theres #352

StartNr: 8

22. Januar 2019 9:38

AUT

Unterschrift des Schützen

Meyton Elektronik

Ergebnis:	599.6	(571)
Serien:	102.0 102.3 100.6 100.6 97.0 97.1	
Zähler:	34 23 3 0 0 0 0 0 0 0	
Innenzehner:	29	
weiteste:	537 (54), 510 (32), 508 (45)	
beste Teiler	43.4 (39.) 49.7 (20.) 58.5 (6.)	
Trefferlage	0.09 mm links, 0.90 mm hoch	
Streuwert	1.85, horizontal: 2.28, vertikal: 1.27	

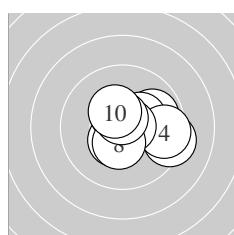
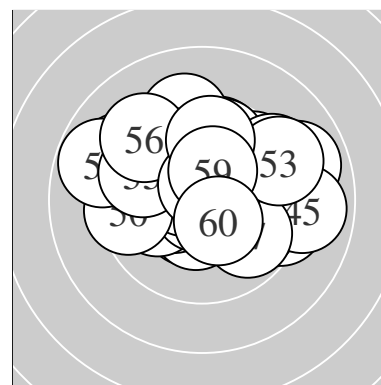

Serie 1:	9.9 →	9.3 →	10.3 *	9.5 →	10.4 *
	10.7 *	10.5 *	10.4 *	10.6 *	10.4 *
beste Teiler	58.5 (6.)	77.5 (9.)	123.0 (7.)		
Trefferlage	0.97 mm rechts, 0.10 mm hoch				
Streuwert	1.45, horizontal: 1.78, vertikal: 1.01				

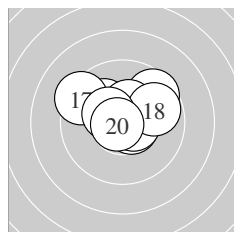

Serie 2:	10.7 *	10.1 ↖	10.6 *	10.6 *	9.6 ↗
	10.4 *	9.3 ↖	9.8 →	10.4 *	10.8 *
beste Teiler	49.7 (20.)	71.0 (11.)	87.1 (13.)		
Trefferlage	0.10 mm rechts, 0.85 mm hoch				
Streuwert	1.48, horizontal: 1.87, vertikal: 0.94				

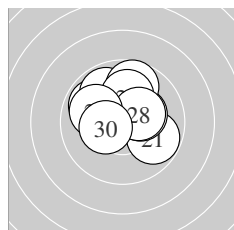

Serie 3:	9.8 ↘	9.9 ↖	10.2 *	9.9 ↖	10.3 *
	9.7 ↑	10.1 ↑	10.3 *	10.0 ↖	10.4 *
beste Teiler	149.6 (30.)	153.3 (28.)	165.3 (25.)		
Trefferlage	0.22 mm links, 1.06 mm hoch				
Streuwert	1.54, horizontal: 1.76, vertikal: 1.29				

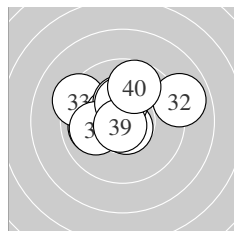

Serie 4:	10.0 ←	8.9 →	9.3 ↖	10.5 *	10.7 *
	10.3 *	10.0 ←	10.4 *	10.8 *	9.7 ↑
beste Teiler	43.4 (39.)	64.0 (35.)	106.0 (34.)		
Trefferlage	0.37 mm links, 0.79 mm hoch				
Streuwert	1.86, horizontal: 2.30, vertikal: 1.26				

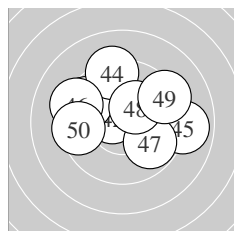

Serie 5:	10.5 *	10.6 *	9.6 ↖	9.3 ↑	8.9 →
	9.3 ↖	9.8 ↘	10.3 *	9.3 →	9.4 ←
beste Teiler	95.2 (42.)	120.4 (41.)	165.0 (48.)		
Trefferlage	0.06 mm links, 0.94 mm hoch				
Streuwert	2.46, horizontal: 3.07, vertikal: 1.62				

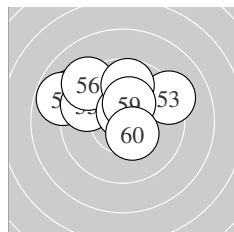

Serie 6:	10.2 *	9.1 ↖	9.2 →	8.8 ↖	9.6 ↖
	9.2 ↖	10.6 *	9.7 ↑	10.3 *	10.4 *
beste Teiler	77.0 (57.)	134.0 (60.)	157.5 (59.)		
Trefferlage	0.98 mm links, 1.66 mm hoch				
Streuwert	2.10, horizontal: 2.71, vertikal: 1.19				

Meyton Elektronik

ISSF AR Women – Wertung – Frauen

StandNr: 109

Wolf, Melissa #280

StartNr: 9

22. Januar 2019 9:38

VSB

Unterschrift des Schützen

Meyton Elektronik

Ergebnis:	622.2	(596)					
Serien:	104.7	104.8	103.8	103.9	102.3	102.7	
Zähler:	56	4	0	0	0	0	
Innenzehner:	49						
weiteste:	362 (44), 292 (42), 292 (50)						
beste Teiler	30.3 (32.) 32.2 (11.) 39.5 (49.)						
Trefferlage	0.21 mm links, 0.00 mm						
Streuwert	1.14, horizontal: 1.03, vertikal: 1.23						

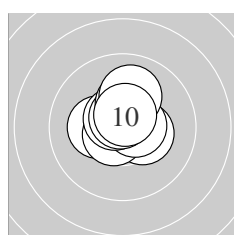
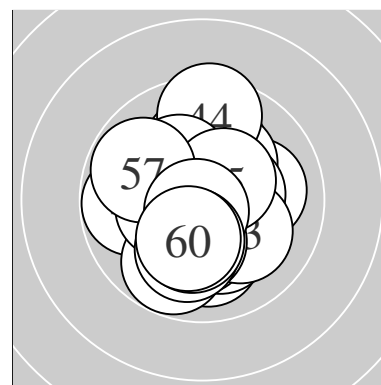

Serie 1:	10.3 *	10.6 *	10.4 *	10.6 *	10.6 *
	10.6 *	10.7 *	10.3 *	10.0 ↑	10.6 *
beste Teiler	71.0 (7.) 81.0 (4.) 82.7 (6.)				
Trefferlage	0.06 mm rechts, 0.59 mm hoch				
Streuwert	0.88, horizontal: 0.89, vertikal: 0.87				

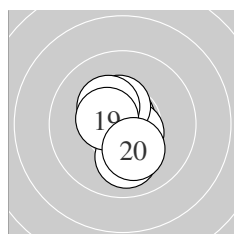

Serie 2:	10.8 *	10.5 *	10.7 *	10.8 *	10.0 ↓
	10.6 *	10.4 *	10.3 *	10.5 *	10.2 *
beste Teiler	32.2 (11.) 46.3 (14.) 55.4 (13.)				
Trefferlage	0.19 mm links, 0.03 mm tief				
Streuwert	0.98, horizontal: 0.69, vertikal: 1.20				

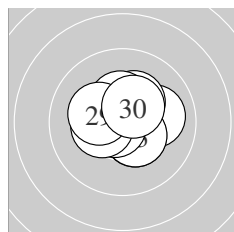

Serie 3:	10.0 →	10.4 *	10.4 *	10.3 *	10.4 *
	10.6 *	10.7 *	10.4 *	10.2 *	10.4 *
beste Teiler	61.7 (27.) 96.2 (26.) 131.5 (22.)				
Trefferlage	0.08 mm rechts, 0.28 mm hoch				
Streuwert	1.08, horizontal: 1.24, vertikal: 0.89				

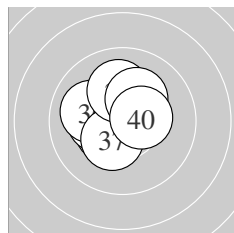

Serie 4:	10.7 *	10.8 *	10.4 *	10.6 *	10.3 *
	10.0 ↖	10.4 *	10.1 ↑	10.2 *	10.4 *
beste Teiler	30.3 (32.) 67.6 (31.) 89.4 (34.)				
Trefferlage	0.43 mm links, 0.34 mm hoch				
Streuwert	1.07, horizontal: 1.12, vertikal: 1.01				

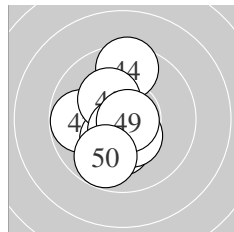

Serie 5:	10.6 *	9.8 ←	10.3 *	9.5 ↑	10.3 *
	10.2 *	10.6 *	10.4 *	10.8 *	9.8 ↘
beste Teiler	39.5 (49.) 81.9 (47.) 82.5 (41.)				
Trefferlage	0.49 mm links, 0.39 mm tief				
Streuwert	1.46, horizontal: 1.05, vertikal: 1.78				

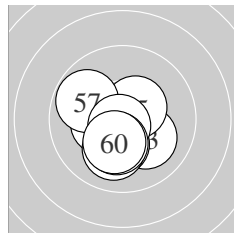

Serie 6:	10.3 *	10.6 *	10.1 ↘	10.2 *	10.5 *
	10.1 ↓	9.8 ↖	10.7 *	10.2 *	10.2 *
beste Teiler	54.5 (58.) 84.5 (52.) 123.9 (55.)				
Trefferlage	0.28 mm links, 0.76 mm tief				
Streuwert	1.18, horizontal: 1.20, vertikal: 1.17				

Meyton Elektronik

ISSF AR Women – Wertung – Frauen

StandNr: 110

Guignard, Silvia #70811322

StartNr: 10

22. Januar 2019 9:54

SUI

Unterschrift des Schützen

Meyton Elektronik

Ergebnis:	626.9	(598)					
Serien:	105.6	104.6	104.7	103.3	104.4	104.3	
Zähler:	58	2	0	0	0	0	0
Innenzehner:	50						
weiteste:	269 (24), 261 (32), 239 (46)						
beste Teiler	20.1 (1.) 41.0 (16.) 42.2 (50.)						
Trefferlage	0.10 mm links, 0.12 mm hoch						
Streuwert	0.99, horizontal: 0.95, vertikal: 1.02						

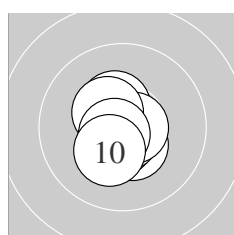
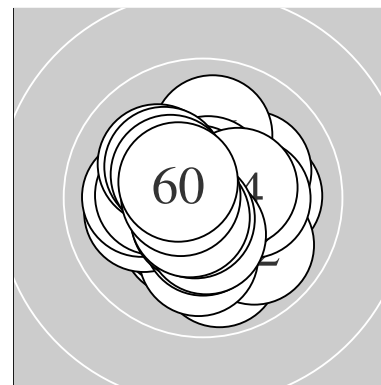

Serie 1:	10.9 *	10.4 *	10.5 *	10.4 *	10.6 *
	10.7 *	10.7 *	10.4 *	10.7 *	10.3 *
beste Teiler	20.1 (1.) 51.6 (6.) 63.1 (7.)				
Trefferlage	0.17 mm links, 0.32 mm tief				
Streuwert	0.73, horizontal: 0.55, vertikal: 0.88				

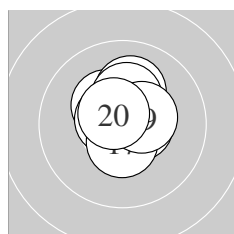

Serie 2:	10.4 *	10.6 *	10.3 *	10.6 *	10.1 ↑
	10.8 *	10.5 *	10.3 *	10.4 *	10.6 *
beste Teiler	41.0 (16.) 82.6 (14.) 86.5 (20.)				
Trefferlage	0.03 mm rechts, 0.61 mm hoch				
Streuwert	0.84, horizontal: 0.74, vertikal: 0.92				

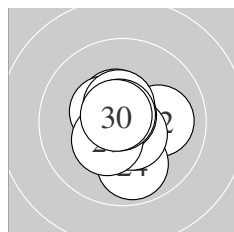

Serie 3:	10.5 *	10.1 →	10.4 *	9.9 ↓	10.6 *
	10.8 *	10.4 *	10.5 *	10.8 *	10.7 *
beste Teiler	42.7 (26.) 48.8 (29.) 58.0 (30.)				
Trefferlage	0.00 mm, 0.03 mm tief				
Streuwert	1.06, horizontal: 0.96, vertikal: 1.15				

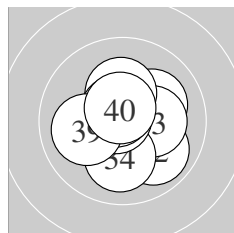

Serie 4:	10.1 ↗	9.9 ↘	10.2 *	10.1 ↓	10.6 *
	10.3 *	10.8 *	10.7 *	10.0 ←	10.6 *
beste Teiler	45.6 (37.) 73.7 (38.) 83.5 (40.)				
Trefferlage	0.17 mm rechts, 0.06 mm hoch				
Streuwert	1.28, horizontal: 1.31, vertikal: 1.25				

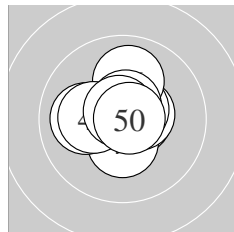

Serie 5:	10.6 *	10.4 *	10.5 *	10.6 *	10.0 ←
	10.0 ↑	10.6 *	10.2 *	10.7 *	10.8 *
beste Teiler	42.2 (50.) 53.7 (49.) 83.0 (41.)				
Trefferlage	0.08 mm links, 0.33 mm hoch				
Streuwert	1.03, horizontal: 1.11, vertikal: 0.94				

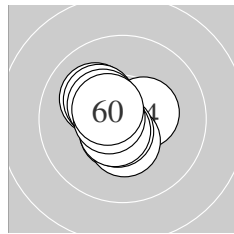

Serie 6:	10.1 ↖	10.6 *	10.2 *	10.4 *	10.4 *
	10.3 *	10.6 *	10.6 *	10.6 *	10.5 *
beste Teiler	83.5 (57.) 84.2 (59.) 88.7 (58.)				
Trefferlage	0.60 mm links, 0.06 mm hoch				
Streuwert	0.91, horizontal: 0.87, vertikal: 0.95				

Meyton Elektronik

ISSF AR Women – Wertung – Frauen

StandNr: 111

McIntosh, Seonaid #70811325

StartNr: 11

22. Januar 2019 9:46

GBR

Unterschrift des Schützen

Meyton Elektronik

Ergebnis:	627.6	(596)					
Serien:	103.9	105.8	105.8	104.4	104.2	103.5	
Zähler:	56	4	0	0	0	0	0
Innenzehner:	52						
weiteste:	369 (58), 329 (47), 303 (1)						
beste Teiler	9.0 (28.) 12.3 (12.) 23.0 (53.)						
Trefferlage	0.18 mm rechts, 0.15 mm hoch						
Streuwert	1.01, horizontal: 1.10, vertikal: 0.92						

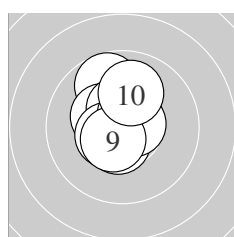
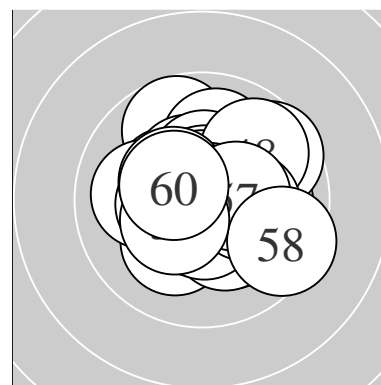

Serie 1:

9.7 ↗	10.3 *	10.4 *	10.8 *	10.5 *
10.5 *	10.6 *	10.6 *	10.5 *	10.0 ↑
beste Teiler	38.6 (4.) 76.2 (8.) 92.9 (7.)			
Trefferlage	0.24 mm links, 0.59 mm hoch			
Streuwert	1.05, horizontal: 0.76, vertikal: 1.28			

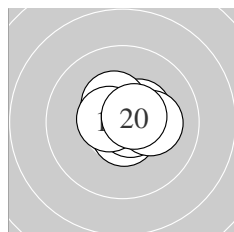

Serie 2:

10.4 *	10.9 *	10.8 *	10.6 *	10.7 *
10.6 *	10.2 *	10.4 *	10.6 *	10.6 *
beste Teiler	12.3 (12.) 45.0 (13.) 57.5 (15.)			
Trefferlage	0.25 mm rechts, 0.18 mm hoch			
Streuwert	0.75, horizontal: 0.88, vertikal: 0.59			

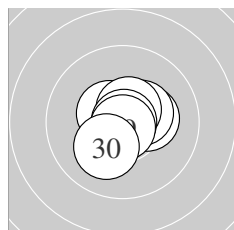

Serie 3:

10.7 *	10.5 *	10.8 *	10.7 *	10.3 *
10.4 *	10.6 *	10.9 *	10.8 *	10.1 ↘
beste Teiler	9.0 (28.) 38.0 (29.) 39.0 (23.)			
Trefferlage	0.18 mm rechts, 0.03 mm hoch			
Streuwert	0.80, horizontal: 0.88, vertikal: 0.71			

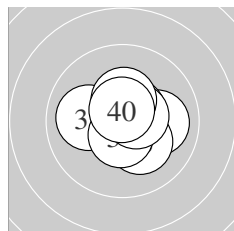

Serie 4:

10.0 ←	10.8 *	10.0 →	10.6 *	10.2 *
10.6 *	10.6 *	10.6 *	10.4 *	10.6 *
beste Teiler	46.0 (32.) 77.2 (40.) 83.8 (37.)			
Trefferlage	0.33 mm rechts, 0.20 mm hoch			
Streuwert	1.03, horizontal: 1.19, vertikal: 0.85			

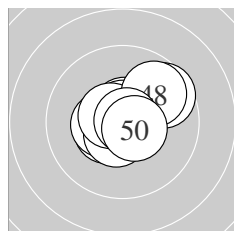

Serie 5:

10.6 *	10.5 *	10.4 *	10.7 *	10.6 *
10.6 *	9.6 ↗	9.8 ↗	10.8 *	10.6 *
beste Teiler	29.7 (49.) 62.0 (44.) 82.7 (41.)			
Trefferlage	0.24 mm rechts, 0.36 mm hoch			
Streuwert	1.16, horizontal: 1.33, vertikal: 0.96			

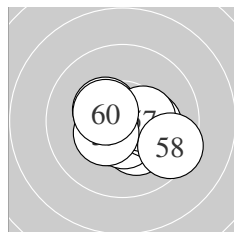

Serie 6:

10.4 *	10.3 *	10.9 *	10.5 *	10.5 *
10.2 *	10.4 *	9.5 ↘	10.4 *	10.4 *
beste Teiler	23.0 (53.) 103.4 (55.) 111.1 (54.)			
Trefferlage	0.31 mm rechts, 0.45 mm tief			
Streuwert	1.23, horizontal: 1.51, vertikal: 0.85			

Meyton Elektronik

ISSF AR Women – Wertung – Frauen

StandNr: 112

Moudgil, Anjum #70811329

StartNr: 12

22. Januar 2019 9:41

IND

Unterschrift des Schützen

Meyton Elektronik

Ergebnis: **615.0** (586)
 Serien: 102.3 103.3 101.7 103.0 102.3 102.4
 Zähler: 46 14 0 0 0 0 0 0 0
 Innenzehner: 41
 weiteste: 400 (13), 384 (25), 384 (39)
 beste Teiler 23.0 (9.) 26.0 (21.) 49.2 (19.)
 Trefferlage 0.27 mm links, 0.20 mm hoch
 Streuwert 1.41, horizontal: 1.50, vertikal: 1.31

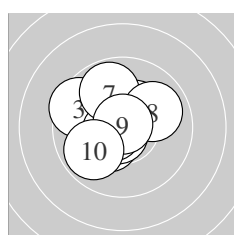
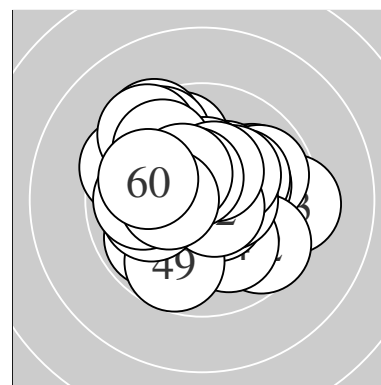

Serie 1:
 10.3 * 10.4 * 9.5 ↖ 10.3 * 10.7 *
 10.6 * 9.8 ↗ 9.9 ↘ 10.9 * 9.9 ↙
 beste Teiler 23.0 (9.) 60.4 (5.) 84.8 (6.)
 Trefferlage 0.69 mm links, 0.29 mm hoch
 Streuwert 1.44, horizontal: 1.54, vertikal: 1.32

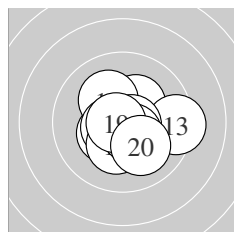

Serie 2:
 10.4 * 10.3 * 9.4 → 10.2 * 10.6 *
 10.7 * 10.3 * 10.5 * 10.8 * 10.1 ↘
 beste Teiler 49.2 (19.) 68.6 (16.) 98.0 (15.)
 Trefferlage 0.35 mm rechts, 0.29 mm tief
 Streuwert 1.36, horizontal: 1.58, vertikal: 1.11

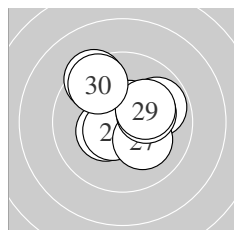

Serie 3:
 10.8 * 9.8 ↘ 10.5 * 10.4 * 9.4 ↖
 10.6 * 10.2 * 10.2 * 10.2 * 9.6 ↖
 beste Teiler 26.0 (21.) 96.5 (26.) 101.2 (23.)
 Trefferlage 0.20 mm rechts, 0.68 mm hoch
 Streuwert 1.57, horizontal: 1.66, vertikal: 1.48

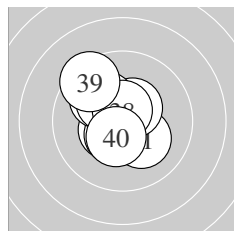

Serie 4:
 10.2 * 10.5 * 10.7 * 10.5 * 10.5 *
 10.0 ↖ 10.2 * 10.6 * 9.4 ↖ 10.4 *
 beste Teiler 63.1 (33.) 81.0 (38.) 119.5 (35.)
 Trefferlage 0.59 mm links, 0.42 mm hoch
 Streuwert 1.29, horizontal: 1.14, vertikal: 1.42

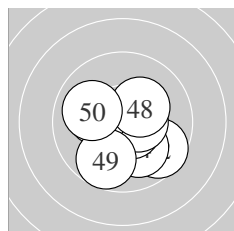

Serie 5:
 10.8 * 9.6 ↘ 10.5 * 10.1 ↘ 10.6 *
 10.5 * 10.2 * 10.3 * 9.7 ↙ 10.0 ↖
 beste Teiler 50.7 (41.) 81.6 (45.) 101.2 (43.)
 Trefferlage 0.17 mm rechts, 0.60 mm tief
 Streuwert 1.44, horizontal: 1.57, vertikal: 1.29

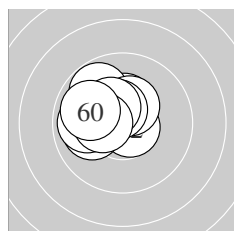

Serie 6:
 10.4 * 10.7 * 10.0 ← 9.8 ↖ 10.4 *
 9.9 ← 10.5 * 10.4 * 10.4 * 9.9 ↖
 beste Teiler 64.0 (52.) 107.9 (57.) 138.5 (55.)
 Trefferlage 1.06 mm links, 0.73 mm hoch
 Streuwert 1.08, horizontal: 1.23, vertikal: 0.90

Meyton Elektronik

ISSF AR Women – Wertung – Frauen

StandNr: 113

Auer, Katharina #13

StartNr: 13

22. Januar 2019 9:18

T – SG Roppen

Unterschrift des Schützen

Meyton Elektronik

Ergebnis:	626.4	(597)							
Serien:	105.0	103.9	104.1	104.6	104.6	104.2			
Zähler:	57	3	0	0	0	0	0	0	0
Innenzehner:	50								
weiteste:	309 (22), 276 (12), 272 (56)								
beste Teiler	2.8 (8.)	22.0 (60.)	32.2 (6.)						
Trefferlage	0.19 mm links, 0.02 mm hoch								
Streuwert	1.02, horizontal: 1.22, vertikal: 0.77								

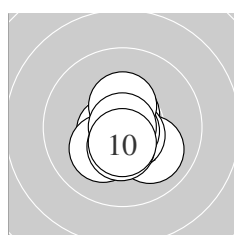
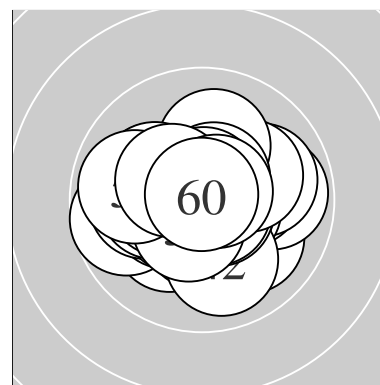

Serie 1:	10.6 *	10.0 ↘	10.6 *	10.2 *	10.6 *
	10.8 *	10.4 *	10.9 *	10.4 *	10.5 *
beste Teiler	2.8 (8.) 32.2 (6.) 77.1 (5.)				
Trefferlage	0.05 mm rechts, 0.39 mm tief				
Streuwert	0.89, horizontal: 0.81, vertikal: 0.96				

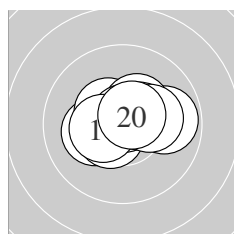

Serie 2:	10.2 *	9.8 →	10.5 *	10.5 *	10.4 *
	10.8 *	10.4 *	10.5 *	10.2 *	10.6 *
beste Teiler	38.8 (16.) 85.5 (20.) 104.9 (14.)				
Trefferlage	0.24 mm rechts, 0.26 mm hoch				
Streuwert	1.11, horizontal: 1.46, vertikal: 0.57				

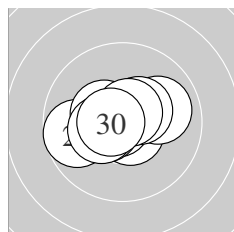

Serie 3:	10.6 *	9.7 ←	10.0 →	10.4 *	10.8 *
	10.5 *	10.4 *	10.4 *	10.7 *	10.6 *
beste Teiler	36.4 (25.) 74.0 (29.) 78.0 (30.)				
Trefferlage	0.36 mm links, 0.03 mm hoch				
Streuwert	1.14, horizontal: 1.50, vertikal: 0.60				

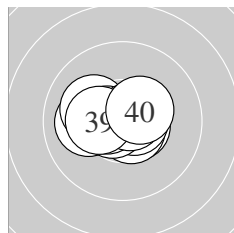

Serie 4:	10.6 *	10.1 ←	10.6 *	10.6 *	10.7 *
	10.1 ↖	10.5 *	10.7 *	10.3 *	10.4 *
beste Teiler	56.9 (38.) 69.2 (35.) 77.0 (34.)				
Trefferlage	0.35 mm links, 0.07 mm hoch				
Streuwert	0.95, horizontal: 1.27, vertikal: 0.44				

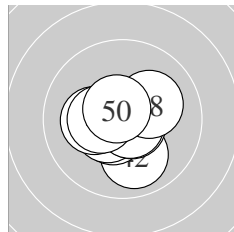

Serie 5:	10.7 *	10.0 ↓	10.6 *	10.5 *	10.7 *
	10.7 *	10.2 *	10.2 *	10.4 *	10.6 *
beste Teiler	55.6 (41.) 61.0 (46.) 72.7 (45.)				
Trefferlage	0.11 mm links, 0.33 mm tief				
Streuwert	1.02, horizontal: 1.12, vertikal: 0.90				

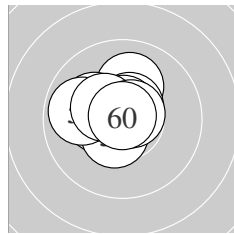

Serie 6:	10.1 ↑	10.3 *	10.6 *	10.5 *	10.1 ↖
	9.9 ←	10.7 *	10.4 *	10.7 *	10.9 *
beste Teiler	22.0 (60.) 64.2 (57.) 65.5 (59.)				
Trefferlage	0.62 mm links, 0.53 mm hoch				
Streuwert	0.97, horizontal: 1.13, vertikal: 0.79				

ISSF AR Women – Wertung – Frauen

StandNr: 114

Brazdova, Lucie #277

StartNr: 14

22. Januar 2019 9:54

CZE

Unterschrift des Schützen

Meyton Elektronik

Ergebnis:	626.0	(598)							
Serien:	103.9	104.9	104.7	103.8	103.4	105.3			
Zähler:	58	2	0	0	0	0	0	0	0
Innenzehner:	52								
weiteste:	256 (25), 252 (6), 250 (9)								
beste Teiler	21.0 (14.)	27.1 (1.)	33.3 (57.)						
Trefferlage	0.01 mm links, 0.15 mm hoch								
Streuwert	1.01, horizontal: 1.00, vertikal: 1.03								

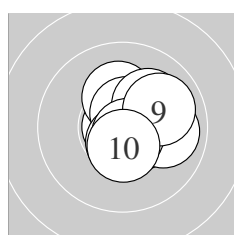
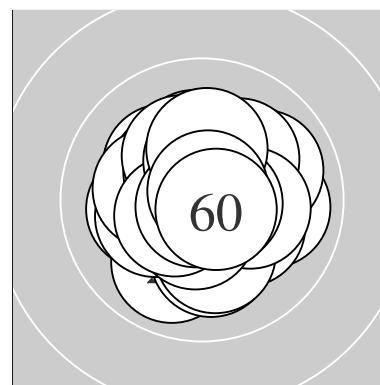

Serie 1:	10.8 *	10.2 *	10.6 *	10.5 *	10.1 ↗
	9.9 →	10.6 *	10.7 *	10.0 ↗	10.5 *
beste Teiler	27.1 (1.) 57.4 (8.) 89.7 (3.)				
Trefferlage	0.73 mm rechts, 0.19 mm hoch				
Streuwert	1.03, horizontal: 1.04, vertikal: 1.03				

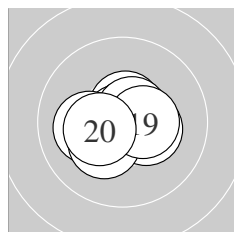

Serie 2:	10.6 *	10.3 *	10.8 *	10.9 *	10.5 *
	10.6 *	10.1 ←	10.3 *	10.4 *	10.4 *
beste Teiler	21.0 (14.) 43.4 (13.) 80.6 (16.)				
Trefferlage	0.21 mm links, 0.10 mm tief				
Streuwert	0.94, horizontal: 1.17, vertikal: 0.62				

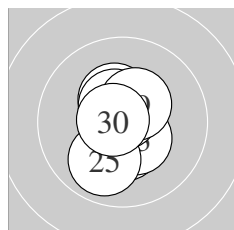

Serie 3:	10.4 *	10.7 *	10.4 *	10.6 *	9.9 ↘
	10.7 *	10.4 *	10.5 *	10.4 *	10.7 *
beste Teiler	57.1 (26.) 61.6 (30.) 75.1 (22.)				
Trefferlage	0.12 mm links, 0.10 mm hoch				
Streuwert	0.98, horizontal: 0.61, vertikal: 1.24				

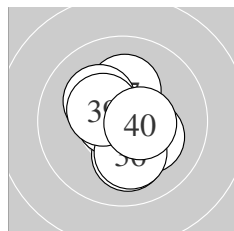

Serie 4:	10.6 *	10.1 ↓	10.8 *	10.2 *	10.7 *
	10.1 ↓	10.2 *	10.2 *	10.4 *	10.5 *
beste Teiler	36.2 (33.) 65.9 (35.) 78.0 (31.)				
Trefferlage	0.09 mm rechts, 0.22 mm tief				
Streuwert	1.13, horizontal: 0.95, vertikal: 1.28				

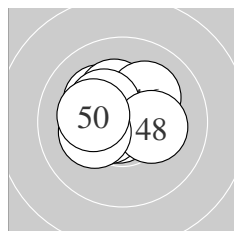

Serie 5:	10.8 *	10.5 *	10.2 *	10.6 *	10.3 *
	10.1 ↗	10.3 *	10.2 *	10.2 *	10.2 *
beste Teiler	37.0 (41.) 99.0 (44.) 121.7 (42.)				
Trefferlage	0.43 mm links, 0.55 mm hoch				
Streuwert	1.08, horizontal: 1.25, vertikal: 0.88				

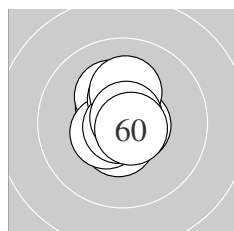

Serie 6:	10.5 *	10.2 *	10.5 *	10.5 *	10.4 *
	10.7 *	10.8 *	10.2 *	10.8 *	10.7 *
beste Teiler	33.3 (57.) 39.6 (59.) 62.6 (60.)				
Trefferlage	0.11 mm links, 0.39 mm hoch				
Streuwert	0.84, horizontal: 0.57, vertikal: 1.04				

ISSF AR Women – Wertung – Frauen

StandNr: 116

Sadangi, Shriyanak #70811344

StartNr: 15

22. Januar 2019 9:54

India

Unterschrift des Schützen

Meyton Elektronik

Ergebnis:	624.1	(596)					
Serien:	104.0	104.1	105.9	101.4	104.2	104.5	
Zähler:	56	4	0	0	0	0	0
Innenzehner:	50						
weiteste:	422 (32), 366 (40), 300 (31)						
beste Teiler	8.0 (58.) 34.0 (22.) 35.0 (27.)						
Trefferlage	0.23 mm links, 0.05 mm hoch						
Streuwert	1.13, horizontal: 1.34, vertikal: 0.86						

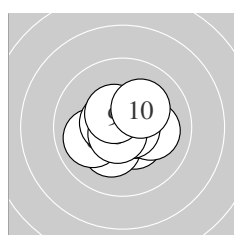
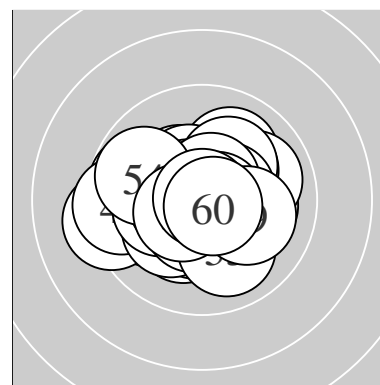

Serie 1:					
	10.4 *	10.3 *	10.6 *	10.1 →	10.7 *
	10.0 ←	10.5 *	10.7 *	10.5 *	10.2 *
beste Teiler	60.6 (5.) 63.4 (8.) 96.7 (3.)				
Trefferlage	0.07 mm rechts, 0.15 mm tief				
Streuwert	1.13, horizontal: 1.33, vertikal: 0.89				

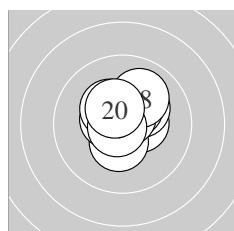

Serie 2:					
	10.4 *	10.4 *	10.2 *	10.5 *	10.4 *
	10.3 *	10.7 *	10.0 ↗	10.8 *	10.4 *
beste Teiler	47.8 (19.) 66.6 (17.) 108.5 (14.)				
Trefferlage	0.17 mm rechts, 0.62 mm hoch				
Streuwert	0.96, horizontal: 0.96, vertikal: 0.95				

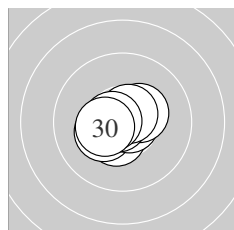

Serie 3:					
	10.7 *	10.8 *	10.5 *	10.3 *	10.7 *
	10.4 *	10.8 *	10.7 *	10.6 *	10.4 *
beste Teiler	34.0 (22.) 35.0 (27.) 51.7 (25.)				
Trefferlage	0.22 mm links, 0.12 mm tief				
Streuwert	0.72, horizontal: 0.86, vertikal: 0.55				

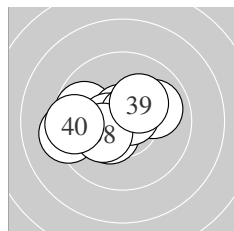

Serie 4:					
	9.8 ↖	9.3 ←	10.7 *	10.5 *	10.4 *
	10.0 →	10.7 *	10.3 *	10.2 *	9.5 ←
beste Teiler	55.9 (33.) 67.0 (37.) 107.6 (34.)				
Trefferlage	1.02 mm links, 0.07 mm hoch				
Streuwert	1.60, horizontal: 2.11, vertikal: 0.84				

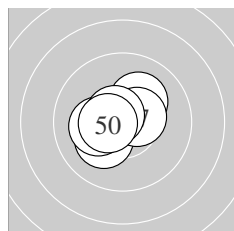

Serie 5:					
	10.4 *	10.6 *	10.6 *	10.4 *	10.2 *
	10.2 *	10.5 *	10.2 *	10.6 *	10.5 *
beste Teiler	78.6 (49.) 84.4 (42.) 89.1 (43.)				
Trefferlage	0.49 mm links, 0.13 mm hoch				
Streuwert	0.98, horizontal: 1.12, vertikal: 0.80				

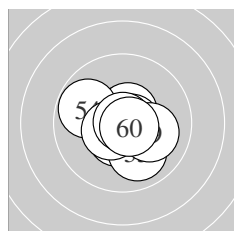

Serie 6:					
	10.5 *	10.7 *	10.6 *	9.8 ↖	10.0 ↓
	10.5 *	10.7 *	10.9 *	10.1 →	10.7 *
beste Teiler	8.0 (58.) 57.3 (60.) 64.1 (57.)				
Trefferlage	0.08 mm rechts, 0.21 mm tief				
Streuwert	1.12, horizontal: 1.25, vertikal: 0.97				

ISSF AR Women – Wertung – Frauen

StandNr: 118

Alison, Weisz #70811338

StartNr: 16

22. Januar 2019 9:59

USA

Unterschrift des Schützen

Meyton Elektronik

Ergebnis: **620.0** (590)
 Serien: 102.9 104.5 101.8 103.7 103.4 103.7
 Zähler: 50 10 0 0 0 0 0 0 0
 Innenzehner: 45
 weiteste: 329 (3), 322 (2), 317 (1)
 beste Teiler 7.2 (10.) 18.2 (45.) 28.1 (7.)
 Trefferlage 0.03 mm rechts, 0.00 mm
 Streuwert 1.25, horizontal: 1.27, vertikal: 1.23

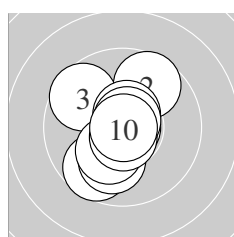
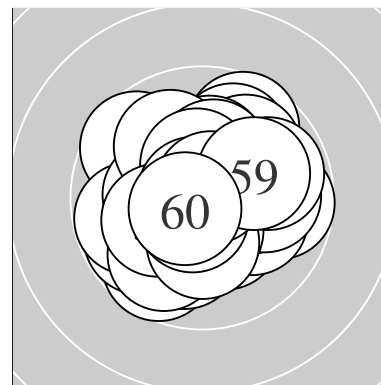

Serie 1:
 9.7 ↙ 9.7 ↗ 9.6 ↘ 10.6 * 10.0 ↙
 10.2 * 10.8 * 10.7 * 10.7 * 10.9 *
 beste Teiler 7.2 (10.) 28.1 (7.) 52.6 (9.)
 Trefferlage 0.33 mm links, 0.10 mm tief
 Streuwert 1.49, horizontal: 1.20, vertikal: 1.74

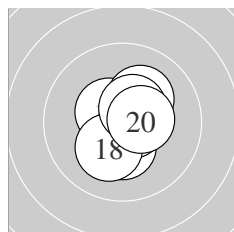

Serie 2:
 10.6 * 10.4 * 10.5 * 10.2 * 10.3 *
 10.7 * 10.6 * 10.2 * 10.5 * 10.5 *
 beste Teiler 60.4 (16.) 76.6 (11.) 93.8 (17.)
 Trefferlage 0.15 mm rechts, 0.15 mm tief
 Streuwert 0.99, horizontal: 0.83, vertikal: 1.12

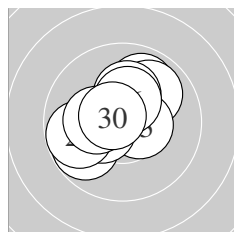

Serie 3:
 9.9 ↗ 9.9 ↗ 10.5 * 10.2 * 9.8 ↙
 10.4 * 10.4 * 9.8 ← 10.3 * 10.6 *
 beste Teiler 79.9 (30.) 113.6 (23.) 144.2 (27.)
 Trefferlage 0.43 mm links, 0.49 mm hoch
 Streuwert 1.47, horizontal: 1.62, vertikal: 1.32

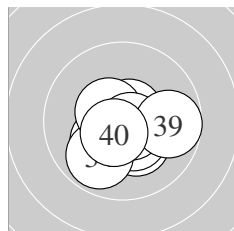

Serie 4:
 10.3 * 10.2 * 10.4 * 9.9 ↙ 10.7 *
 10.7 * 10.5 * 10.7 * 9.7 → 10.6 *
 beste Teiler 51.0 (36.) 63.5 (38.) 69.0 (35.)
 Trefferlage 0.08 mm rechts, 0.61 mm tief
 Streuwert 1.15, horizontal: 1.35, vertikal: 0.92

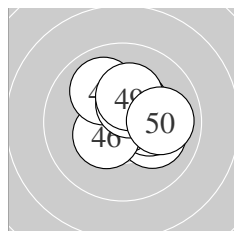

Serie 5:
 10.7 * 10.4 * 10.1 ↘ 10.2 * 10.9 *
 10.4 * 10.0 ↘ 10.4 * 10.3 * 10.0 →
 beste Teiler 18.2 (45.) 67.3 (41.) 127.5 (48.)
 Trefferlage 0.52 mm rechts, 0.51 mm hoch
 Streuwert 1.14, horizontal: 1.28, vertikal: 0.99

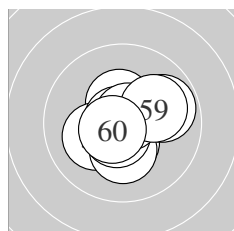

Serie 6:
 10.4 * 10.2 * 10.4 * 10.8 * 9.8 →
 10.2 * 10.6 * 10.7 * 10.0 → 10.6 *
 beste Teiler 37.2 (54.) 53.9 (58.) 80.4 (60.)
 Trefferlage 0.18 mm rechts, 0.12 mm tief
 Streuwert 1.17, horizontal: 1.28, vertikal: 1.05

Meyton Elektronik

ISSF AR Women – Wertung – Frauen

StandNr: 119

Brühlmann, Andrea #70811332

StartNr: 17

22. Januar 2019 9:58

SUI – TG

Unterschrift des Schützen

Meyton Elektronik

Ergebnis:	627.8	(596) ^{QF}							
Serien:	105.3	104.2	104.2	104.7	104.9	104.5			
Zähler:	56	4	0	0	0	0	0	0	0
Innenzehner:	52								
weiteste:	379 (18), 315 (28), 266 (32)								
beste Teiler	13.0 (60.)	35.0 (10.)	38.1 (25.)						
Trefferlage	0.03 mm rechts, 0.04 mm tief								
Streuwert	1.00, horizontal: 0.97, vertikal: 1.03								

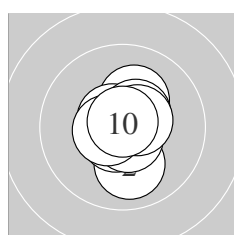
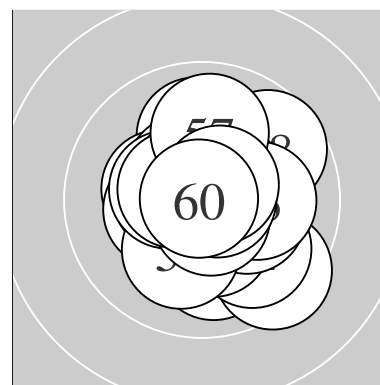

Serie 1:	10.2 *	10.0 ↓	10.6 *	10.7 *	10.7 *
	10.5 *	10.7 *	10.5 *	10.6 *	10.8 *
beste Teiler	35.0 (10.)	51.3 (4.)	71.1 (7.)		
Trefferlage	0.08 mm rechts, 0.02 mm tief				
Streuwert	0.89, horizontal: 0.67, vertikal: 1.07				

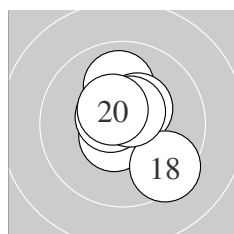

Serie 2:	10.7 *	10.0 ↑	10.4 *	10.7 *	10.7 *
	10.6 *	10.6 *	9.4 ↘	10.6 *	10.5 *
beste Teiler	51.2 (14.)	55.3 (11.)	75.1 (15.)		
Trefferlage	0.06 mm rechts, 0.19 mm hoch				
Streuwert	1.22, horizontal: 1.07, vertikal: 1.35				

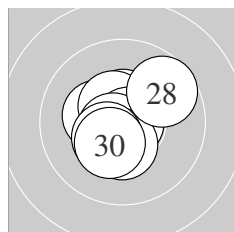

Serie 3:	10.5 *	10.3 *	10.5 *	10.6 *	10.8 *
	10.7 *	10.4 *	9.7 ↗	10.4 *	10.3 *
beste Teiler	38.1 (25.)	72.1 (26.)	87.0 (24.)		
Trefferlage	0.21 mm links, 0.04 mm tief				
Streuwert	1.12, horizontal: 1.11, vertikal: 1.13				

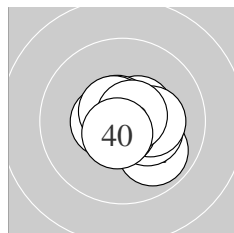

Serie 4:	10.5 *	9.9 ↘	10.3 *	10.5 *	10.2 *
	10.7 *	10.7 *	10.6 *	10.7 *	10.6 *
beste Teiler	55.3 (36.)	68.6 (39.)	72.8 (37.)		
Trefferlage	0.44 mm rechts, 0.15 mm tief				
Streuwert	0.94, horizontal: 1.07, vertikal: 0.80				

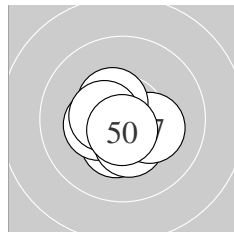

Serie 5:	10.7 *	10.3 *	10.8 *	10.5 *	10.3 *
	10.4 *	10.2 *	10.5 *	10.5 *	10.7 *
beste Teiler	46.0 (43.)	70.0 (50.)	75.4 (41.)		
Trefferlage	0.17 mm links, 0.44 mm tief				
Streuwert	0.85, horizontal: 0.97, vertikal: 0.72				

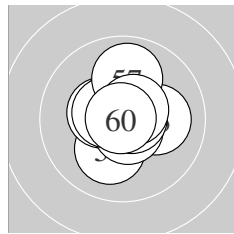

Serie 6:	10.1 ↓	10.4 *	10.1 →	10.6 *	10.7 *
	10.5 *	9.9 ↑	10.7 *	10.6 *	10.9 *
beste Teiler	13.0 (60.)	58.3 (58.)	71.5 (55.)		
Trefferlage	0.03 mm rechts, 0.23 mm hoch				
Streuwert	1.06, horizontal: 0.99, vertikal: 1.12				

Meyton Elektronik

ISSF AR Women – Wertung – Frauen

StandNr: 120

Bordet, Jade #70811346

StartNr: 18

22. Januar 2019 9:41

FRA

QF – Schütze hat sich fürs Finale qualifiziert

Unterschrift des Schützen

Meyton Elektronik

Ergebnis: **621.6** (593)

Serien: 104.8 103.4 104.6 103.6 103.4 101.8

Zähler: 53 7 0 0 0 0 0 0 0 0

Innenzehner: 43

weiteste: 359 (12), 337 (47), 324 (37)

beste Teiler 10.8 (9.) 11.0 (24.) 42.0 (28.)

Trefferlage 0.18 mm rechts, 0.08 mm hoch

Streuwert 1.20, horizontal: 1.30, vertikal: 1.08

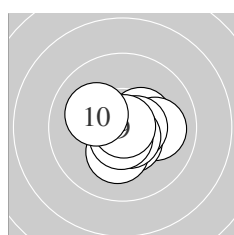
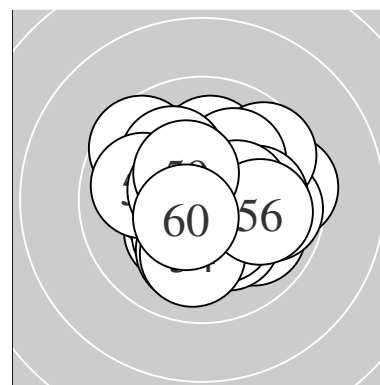

Serie 1:

10.4 *	10.0 →	10.5 *	10.6 *	10.2 *
10.6 *	10.8 *	10.7 *	10.9 *	10.1 ↖

beste Teiler 10.8 (9.) 50.4 (7.) 75.6 (8.)

Trefferlage 0.32 mm rechts, 0.32 mm tief

Streuwert 0.95, horizontal: 1.10, vertikal: 0.78

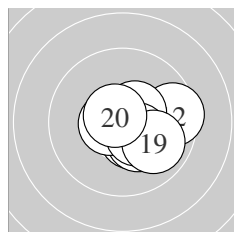

Serie 2:

10.5 *	9.5 →	10.3 *	10.7 *	10.3 *
10.5 *	10.6 *	10.4 *	9.9 ↘	10.7 *

beste Teiler 70.9 (20.) 72.1 (14.) 90.6 (17.)

Trefferlage 0.96 mm rechts, 0.36 mm tief

Streuwert 1.08, horizontal: 1.26, vertikal: 0.86

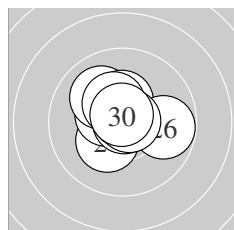

Serie 3:

10.3 *	10.5 *	10.0 ↖	10.9 *	10.4 *
9.8 →	10.4 *	10.8 *	10.8 *	10.7 *

beste Teiler 11.0 (24.) 42.0 (28.) 46.8 (29.)

Trefferlage 0.09 mm links, 0.43 mm hoch

Streuwert 1.08, horizontal: 1.23, vertikal: 0.91

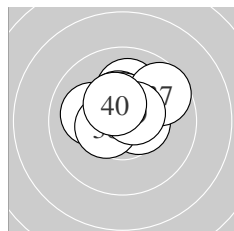

Serie 4:

10.8 *	10.1 ↖	10.1 ↑	10.5 *	10.4 *
10.5 *	9.7 ↗	10.5 *	10.6 *	10.4 *

beste Teiler 45.9 (31.) 96.8 (39.) 114.6 (34.)

Trefferlage 0.03 mm rechts, 0.86 mm hoch

Streuwert 1.10, horizontal: 1.31, vertikal: 0.84

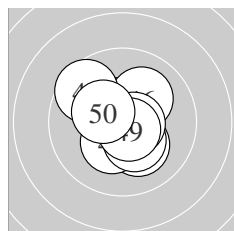

Serie 5:

10.8 *	10.5 *	10.2 *	10.3 *	10.3 *
10.1 ↗	9.6 ↖	10.6 *	10.7 *	10.3 *

beste Teiler 47.6 (41.) 69.5 (49.) 79.0 (48.)

Trefferlage 0.03 mm links, 0.02 mm hoch

Streuwert 1.28, horizontal: 1.25, vertikal: 1.31

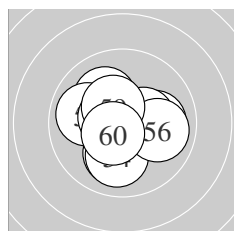

Serie 6:

10.1 ↓	10.0 →	10.1 ↖	10.0 ↓	10.4 *
9.9 →	9.9 ←	10.5 *	10.4 *	10.5 *

beste Teiler 101.1 (60.) 101.6 (58.) 132.7 (59.)

Trefferlage 0.08 mm links, 0.14 mm tief

Streuwert 1.47, horizontal: 1.61, vertikal: 1.31

Meyton Elektronik

ISSF AR Women – Wertung – Frauen

StandNr: 121

Shimizu, Ayano #70811343

StartNr: 19

22. Januar 2019 9:50

JPN

Unterschrift des Schützen

Meyton Elektronik

Ergebnis:	621.5	(594)
Serien:	102.5	103.8 104.2 102.6 104.6 103.8
Zähler:	54	6 0 0 0 0 0 0 0 0
Innenzehner:	48	
weiteste:	341	(9), 323 (37), 285 (2)
beste Teiler	7.0	(12.) 25.3 (24.) 44.1 (28.)
Trefferlage	0.04 mm links, 0.25 mm hoch	
Streuwert	1.17, horizontal: 1.21, vertikal: 1.13	

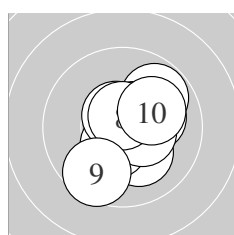
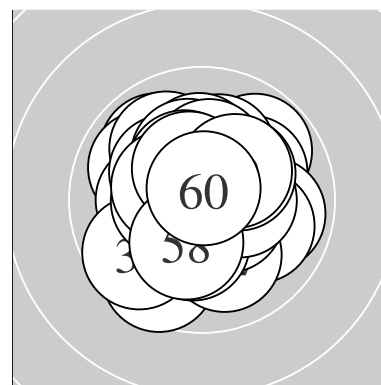

Serie 1:

10.2 *	9.8 ↗	10.5 *	10.1 →	10.5 *
10.6 *	10.4 *	10.7 *	9.6 ↘	10.1 ↗
beste Teiler	75.0 (8.) 88.6 (6.) 105.3 (5.)			
Trefferlage	0.63 mm rechts, 0.01 mm tief			
Streuwert	1.38, horizontal: 1.27, vertikal: 1.49			

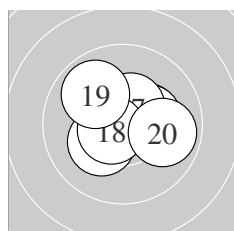

Serie 2:

10.3 *	10.9 *	10.3 *	10.7 *	10.2 *
10.5 *	10.5 *	10.6 *	9.9 ↘	9.9 →
beste Teiler	7.0 (12.) 63.2 (14.) 82.2 (18.)			
Trefferlage	0.14 mm rechts, 0.33 mm hoch			
Streuwert	1.19, horizontal: 1.41, vertikal: 0.91			

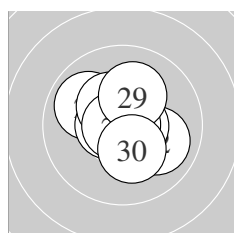

Serie 3:

10.6 *	10.0 ↘	10.6 *	10.9 *	9.9 ↘
10.6 *	10.4 *	10.8 *	10.1 ↑	10.3 *
beste Teiler	25.3 (24.) 44.1 (28.) 78.4 (21.)			
Trefferlage	0.07 mm rechts, 0.22 mm hoch			
Streuwert	1.14, horizontal: 1.22, vertikal: 1.06			

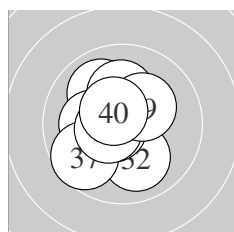

Serie 4:

10.4 *	10.0 ↓	10.0 ↘	10.2 *	10.7 *
10.2 *	9.7 ↗	10.6 *	10.3 *	10.5 *
beste Teiler	70.0 (35.) 98.3 (38.) 103.4 (40.)			
Trefferlage	0.72 mm links, 0.12 mm hoch			
Streuwert	1.32, horizontal: 1.18, vertikal: 1.45			

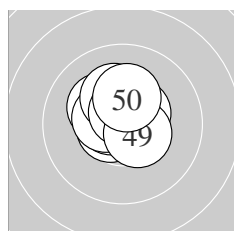

Serie 5:

10.6 *	10.6 *	10.6 *	10.2 *	10.5 *
10.2 *	10.5 *	10.6 *	10.5 *	10.3 *
beste Teiler	78.0 (48.) 79.1 (43.) 83.4 (41.)			
Trefferlage	0.32 mm links, 0.61 mm hoch			
Streuwert	0.81, horizontal: 0.84, vertikal: 0.77			

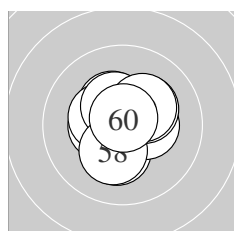

Serie 6:

10.3 *	10.4 *	10.4 *	10.4 *	10.4 *
10.2 *	10.4 *	10.2 *	10.3 *	10.8 *
beste Teiler	46.3 (60.) 134.4 (57.) 135.1 (52.)			
Trefferlage	0.06 mm links, 0.22 mm hoch			
Streuwert	1.11, horizontal: 1.10, vertikal: 1.12			

Meyton Elektronik

ISSF AR Women – Wertung – Frauen

StandNr: 122

Demjen, Peskova Daniela #70811321

StartNr: 20

22. Januar 2019 9:55

Police Sports Center Slovakia

Unterschrift des Schützen

Meyton Elektronik

Ergebnis:	623.0	(594)					
Serien:	103.0	103.1	103.8	105.6	103.7	103.8	
Zähler:	54	6	0	0	0	0	0
Innenzehner:	52						
weiteste:	457 (17), 333 (41), 311 (20)						
beste Teiler	6.3 (35.) 29.2 (56.) 40.3 (47.)						
Trefferlage	0.12 mm rechts, 0.46 mm hoch						
Streuwert	1.12, horizontal: 1.23, vertikal: 0.98						

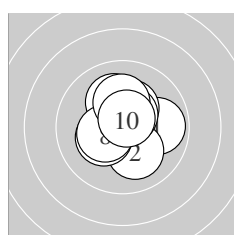
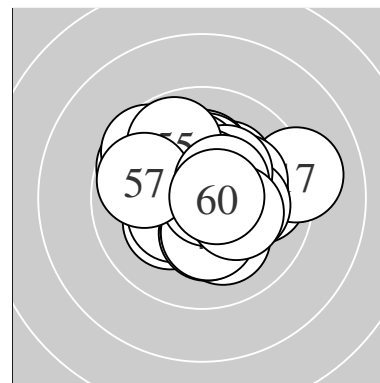

Serie 1:	9.9 →	10.1 ↘	10.3 *	10.5 *	10.3 *
	10.5 *	10.1 ↗	10.4 *	10.2 *	10.7 *
beste Teiler	74.7 (10.) 103.3 (6.) 112.2 (4.)				
Trefferlage	0.12 mm rechts, 0.50 mm hoch				
Streuwert	1.24, horizontal: 1.22, vertikal: 1.26				

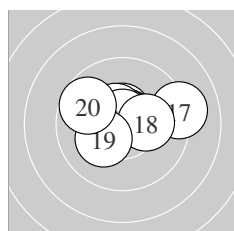

Serie 2:	10.6 *	10.7 *	10.7 *	10.7 *	10.5 *
	10.7 *	9.1 →	10.2 *	10.2 *	9.7 ↖
beste Teiler	51.0 (16.) 53.2 (12.) 60.4 (13.)				
Trefferlage	0.18 mm rechts, 0.56 mm hoch				
Streuwert	1.44, horizontal: 1.92, vertikal: 0.71				

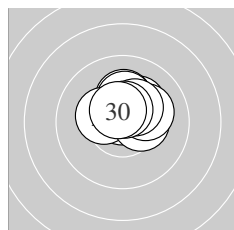

Serie 3:	10.2 *	10.2 *	10.8 *	10.2 *	10.3 *
	10.4 *	10.2 *	10.4 *	10.6 *	10.5 *
beste Teiler	45.5 (23.) 98.9 (29.) 101.0 (30.)				
Trefferlage	0.38 mm rechts, 0.98 mm hoch				
Streuwert	0.81, horizontal: 0.97, vertikal: 0.60				

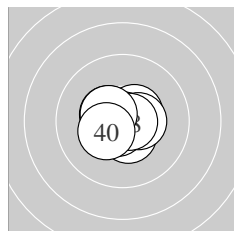

Serie 4:	10.4 *	10.5 *	10.5 *	10.5 *	10.9 *
	10.5 *	10.7 *	10.7 *	10.5 *	10.4 *
beste Teiler	6.3 (35.) 51.3 (38.) 68.4 (37.)				
Trefferlage	0.19 mm links, 0.04 mm tief				
Streuwert	0.79, horizontal: 0.94, vertikal: 0.59				

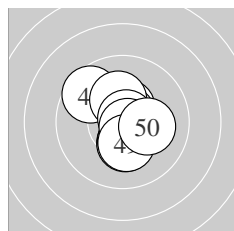

Serie 5:	9.6 ↖	10.5 *	10.3 *	10.4 *	10.7 *
	10.2 *	10.8 *	10.7 *	10.3 *	10.2 *
beste Teiler	40.3 (47.) 55.1 (48.) 68.8 (45.)				
Trefferlage	0.11 mm rechts, 0.04 mm hoch				
Streuwert	1.25, horizontal: 1.09, vertikal: 1.39				

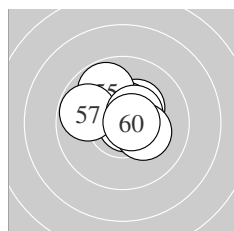

Serie 6:	10.3 *	10.6 *	10.6 *	10.5 *	9.8 ↗
	10.8 *	9.8 ↖	10.5 *	10.2 *	10.7 *
beste Teiler	29.2 (56.) 70.2 (60.) 88.1 (52.)				
Trefferlage	0.11 mm rechts, 0.74 mm hoch				
Streuwert	1.08, horizontal: 1.26, vertikal: 0.86				

Meyton Elektronik

ISSF AR Women – Wertung – Frauen

StandNr: 123

Lustenberger, Petra #70811340

StartNr: 21

22. Januar 2019 10:00

SUI

Unterschrift des Schützen

Meyton Elektronik

Ergebnis:	622.0	(593)					
Serien:	104.3	104.3	102.2	105.2	102.6	103.4	
Zähler:	53	7	0	0	0	0	0
Innenzehner:	49						
weiteste:	405 (23), 382 (49), 326 (59)						
beste Teiler	33.2 (60.) 39.3 (8.) 39.9 (40.)						
Trefferlage	0.10 mm rechts, 0.19 mm hoch						
Streuwert	1.20, horizontal: 1.39, vertikal: 0.98						

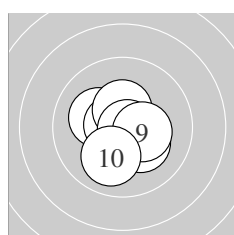
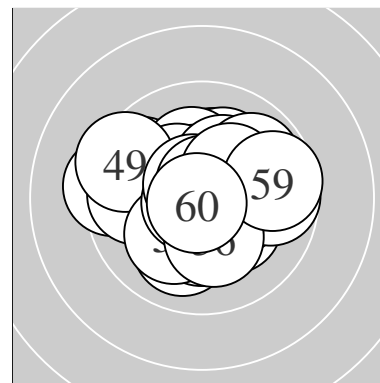

Serie 1:					
	10.4 *	10.2 *	10.7 *	10.7 *	10.4 *
	10.2 *	10.6 *	10.8 *	10.3 *	10.0 ↙
beste Teiler	39.3 (8.) 57.7 (4.) 70.3 (3.)				
Trefferlage	0.04 mm rechts, 0.34 mm tief				
Streuwert	1.02, horizontal: 1.05, vertikal: 0.99				

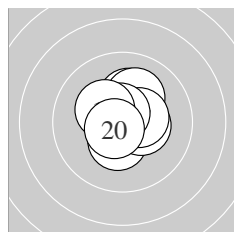

Serie 2:					
	10.7 *	10.4 *	10.5 *	10.4 *	10.2 *
	10.1 ↗	10.4 *	10.7 *	10.3 *	10.6 *
beste Teiler	59.6 (11.) 71.5 (18.) 79.0 (20.)				
Trefferlage	0.30 mm rechts, 0.37 mm hoch				
Streuwert	0.96, horizontal: 0.90, vertikal: 1.02				

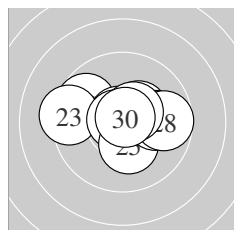

Serie 3:					
	9.7 ↖	10.7 *	9.3 ←	10.8 *	10.3 *
	10.4 *	10.0 →	9.7 →	10.5 *	10.8 *
beste Teiler	40.7 (30.) 48.8 (24.) 53.5 (22.)				
Trefferlage	0.06 mm rechts, 0.31 mm hoch				
Streuwert	1.62, horizontal: 2.16, vertikal: 0.79				

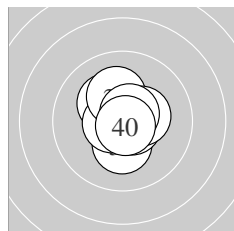

Serie 4:					
	10.3 *	10.7 *	10.7 *	10.6 *	10.2 *
	10.6 *	10.2 *	10.4 *	10.7 *	10.8 *
beste Teiler	39.9 (40.) 71.8 (32.) 75.0 (39.)				
Trefferlage	0.04 mm rechts, 0.23 mm hoch				
Streuwert	0.89, horizontal: 0.80, vertikal: 0.97				

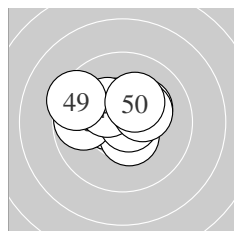

Serie 5:					
	10.5 *	10.5 *	10.2 *	10.5 *	9.8 ←
	10.8 *	10.3 *	10.3 *	9.4 ↖	10.3 *
beste Teiler	46.0 (46.) 105.2 (42.) 111.3 (41.)				
Trefferlage	0.40 mm links, 0.63 mm hoch				
Streuwert	1.36, horizontal: 1.74, vertikal: 0.81				

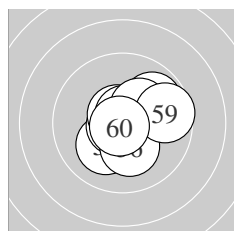

Serie 6:					
	9.9 ↗	10.1 ↙	10.7 *	10.7 *	10.4 *
	10.2 *	10.7 *	10.3 *	9.6 →	10.8 *
beste Teiler	33.2 (60.) 52.9 (53.) 60.1 (57.)				
Trefferlage	0.54 mm rechts, 0.04 mm tief				
Streuwert	1.27, horizontal: 1.34, vertikal: 1.19				

ISSF AR Women – Wertung – Frauen

StandNr: 124

Hofmann, Olivia #222

StartNr: 22

22. Januar 2019 9:54

AUT

Unterschrift des Schützen

Meyton Elektronik

Ergebnis:	625.9	(595)							
Serien:	104.4	104.6	104.9	104.0	103.9	104.1			
Zähler:	55	5	0	0	0	0	0	0	0
Innenzehner:	51								
weiteste:	412 (12),	301 (6),	281 (40)						
beste Teiler	5.0 (11.)	18.8 (37.)	24.3 (15.)						
Trefferlage	0.24 mm links, 0.19 mm hoch								
Streuwert	1.06, horizontal: 1.19, vertikal: 0.91								

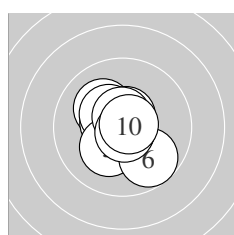
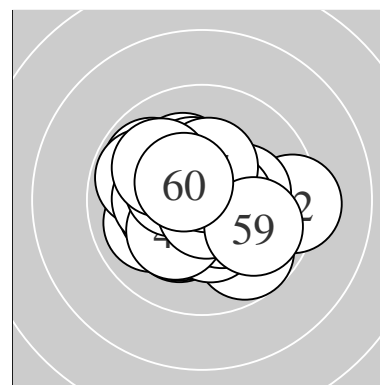

Serie 1:	10.1 ↘	10.5 *	10.4 *	10.6 *	10.2 *
	9.7 ↘	10.8 *	10.6 *	10.8 *	10.7 *
beste Teiler	30.8 (7.) 43.3 (9.) 51.8 (10.)				
Trefferlage	0.16 mm links, 0.02 mm hoch				
Streuwert	1.10, horizontal: 1.02, vertikal: 1.17				

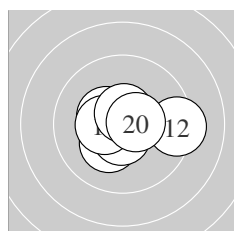

Serie 2:	10.9 *	9.3 →	10.8 *	10.4 *	10.9 *
	10.2 *	10.6 *	10.4 *	10.6 *	10.5 *
beste Teiler	5.0 (11.) 24.3 (15.) 39.8 (13.)				
Trefferlage	0.10 mm rechts, 0.12 mm tief				
Streuwert	1.21, horizontal: 1.58, vertikal: 0.66				

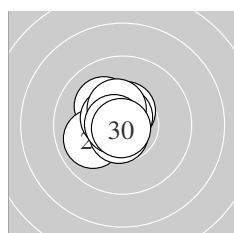

Serie 3:	10.5 *	10.4 *	10.1 ↘	10.0 ↙	10.5 *
	10.7 *	10.4 *	10.7 *	10.7 *	10.9 *
beste Teiler	25.9 (30.) 62.0 (26.) 65.3 (29.)				
Trefferlage	0.66 mm links, 0.40 mm hoch				
Streuwert	0.80, horizontal: 0.75, vertikal: 0.84				

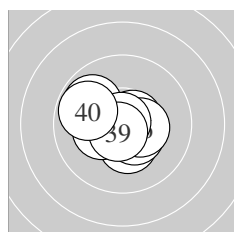

Serie 4:	10.6 *	10.6 *	10.3 *	9.9 ↘	10.5 *
	10.4 *	10.9 *	10.3 *	10.7 *	9.8 ↙
beste Teiler	18.8 (37.) 67.7 (39.) 83.3 (32.)				
Trefferlage	0.26 mm links, 0.08 mm tief				
Streuwert	1.18, horizontal: 1.42, vertikal: 0.88				

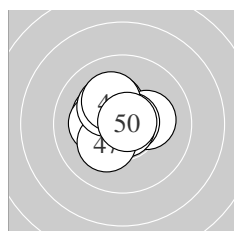

Serie 5:	10.3 *	10.3 *	10.2 *	10.2 *	10.7 *
	10.8 *	10.2 *	10.2 *	10.2 *	10.8 *
beste Teiler	33.0 (46.) 38.4 (50.) 57.9 (45.)				
Trefferlage	0.45 mm links, 0.41 mm hoch				
Streuwert	1.04, horizontal: 1.15, vertikal: 0.92				

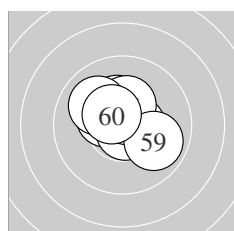

Serie 6:	10.3 *	10.6 *	10.4 *	10.7 *	10.8 *
	10.6 *	10.3 *	10.0 ↘	9.9 ↘	10.5 *
beste Teiler	47.4 (55.) 51.8 (54.) 80.9 (56.)				
Trefferlage	0.04 mm links, 0.54 mm hoch				
Streuwert	1.05, horizontal: 1.19, vertikal: 0.90				

ISSF AR Women – Wertung – Frauen

StandNr: 102

Vognarova, Gabriela #229

StartNr: 45

22. Januar 2019 11:44

CZE

Unterschrift des Schützen

Meyton Elektronik

Ergebnis:	629.9	(600) ^{QF}
Serien:	104.4	105.4 105.3 104.8 105.1 104.9
Zähler:	60	0 0 0 0 0 0 0 0 0
Innenzehner:	56	
weiteste:	229 (21), 218 (39), 214 (16)	
beste Teiler	9.2 (59.)	30.1 (25.) 32.5 (35.)
Trefferlage	0.09 mm rechts, 0.05 mm hoch	
Streuwert	0.88, horizontal: 0.90, vertikal: 0.86	

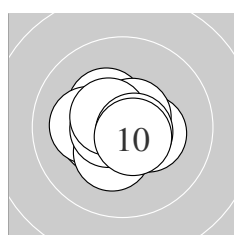
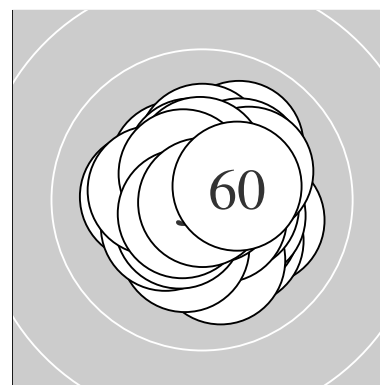

Serie 1:	10.3 *	10.4 *	10.3 *	10.6 *	10.1 ←
	10.3 *	10.6 *	10.5 *	10.7 *	10.6 *
beste Teiler	72.2 (9.) 82.0 (4.) 82.0 (10.)				
Trefferlage	0.32 mm links, 0.06 mm tief				
Streuwert	0.93, horizontal: 1.09, vertikal: 0.74				

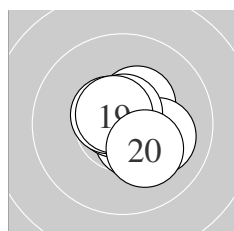

Serie 2:	10.5 *	10.4 *	10.8 *	10.7 *	10.7 *
	10.1 →	10.6 *	10.7 *	10.7 *	10.2 *
beste Teiler	48.9 (13.) 55.2 (15.) 64.4 (14.)				
Trefferlage	0.22 mm rechts, 0.09 mm hoch				
Streuwert	0.87, horizontal: 0.93, vertikal: 0.80				

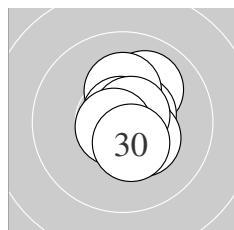

Serie 3:	10.0 ↗	10.6 *	10.7 *	10.2 *	10.8 *
	10.4 *	10.8 *	10.7 *	10.7 *	10.4 *
beste Teiler	30.1 (25.) 42.4 (27.) 58.1 (29.)				
Trefferlage	0.43 mm rechts, 0.29 mm hoch				
Streuwert	0.82, horizontal: 0.58, vertikal: 1.00				

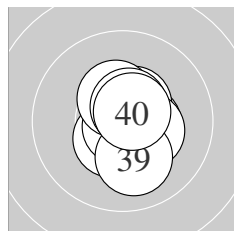

Serie 4:	10.5 *	10.4 *	10.5 *	10.5 *	10.8 *
	10.4 *	10.4 *	10.6 *	10.1 ↓	10.6 *
beste Teiler	32.5 (35.) 77.7 (40.) 90.4 (38.)				
Trefferlage	0.42 mm rechts, 0.17 mm tief				
Streuwert	0.89, horizontal: 0.64, vertikal: 1.09				

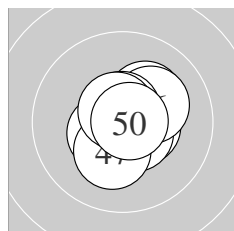

Serie 5:	10.7 *	10.5 *	10.5 *	10.6 *	10.2 *
	10.2 *	10.2 *	10.7 *	10.7 *	10.8 *
beste Teiler	40.3 (50.) 58.4 (41.) 69.1 (48.)				
Trefferlage	0.37 mm rechts, 0.06 mm hoch				
Streuwert	0.88, horizontal: 0.86, vertikal: 0.89				

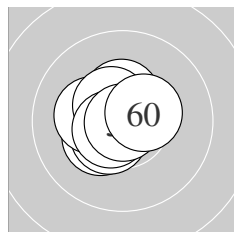

Serie 6:	10.4 *	10.3 *	10.3 *	10.5 *	10.8 *
	10.2 *	10.5 *	10.6 *	10.9 *	10.4 *
beste Teiler	9.2 (59.) 33.3 (55.) 84.0 (58.)				
Trefferlage	0.54 mm links, 0.13 mm hoch				
Streuwert	0.81, horizontal: 0.89, vertikal: 0.73				

Meyton Elektronik

ISSF AR Women – Wertung – Frauen

StandNr: 103

Galashina, Anastasiia #70811336

StartNr: 46

22. Januar 2019 11:51

RUS

QF – Schütze hat sich fürs Finale qualifiziert

Unterschrift des Schützen

Meyton Elektronik

Ergebnis:	626.4	(598)					
Serien:	105.0	104.9	103.8	103.7	104.8	104.2	
Zähler:	58	2	0	0	0	0	0
Innenzehner:	51						
weiteste:	271 (24), 261 (44), 248 (34)						
beste Teiler	17.7 (21.) 23.2 (13.) 26.4 (58.)						
Trefferlage	0.27 mm links, 0.28 mm hoch						
Streuwert	1.00, horizontal: 1.09, vertikal: 0.89						

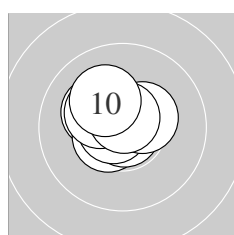
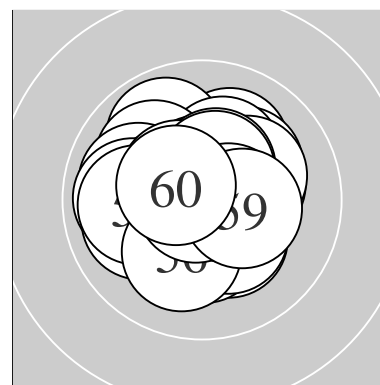

Serie 1:					
	10.4 *	10.2 *	10.5 *	10.8 *	10.8 *
	10.7 *	10.4 *	10.3 *	10.7 *	10.2 *
beste Teiler	27.3 (5.) 33.2 (4.) 58.1 (6.)				
Trefferlage	0.51 mm links, 0.46 mm hoch				
Streuwert	0.79, horizontal: 0.90, vertikal: 0.65				

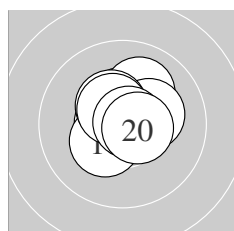

Serie 2:					
	10.6 *	10.4 *	10.9 *	10.1 ↗	10.3 *
	10.3 *	10.4 *	10.5 *	10.8 *	10.6 *
beste Teiler	23.2 (13.) 40.1 (19.) 78.6 (11.)				
Trefferlage	0.09 mm rechts, 0.47 mm hoch				
Streuwert	0.90, horizontal: 0.91, vertikal: 0.88				

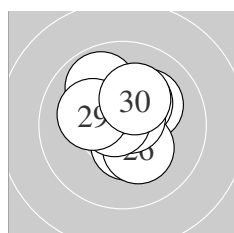

Serie 3:					
	10.9 *	10.1 ↗	10.5 *	9.9 ↘	10.3 *
	10.3 *	10.7 *	10.7 *	10.2 *	10.2 *
beste Teiler	17.7 (21.) 55.9 (28.) 65.1 (27.)				
Trefferlage	0.11 mm rechts, 0.52 mm hoch				
Streuwert	1.15, horizontal: 1.08, vertikal: 1.21				

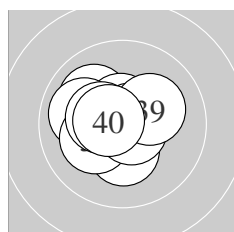

Serie 4:					
	10.3 *	10.0 ↘	10.6 *	10.0 ↖	10.7 *
	10.2 *	10.4 *	10.7 *	10.2 *	10.6 *
beste Teiler	64.0 (38.) 65.5 (35.) 90.7 (40.)				
Trefferlage	0.53 mm links, 0.21 mm hoch				
Streuwert	1.13, horizontal: 1.30, vertikal: 0.93				

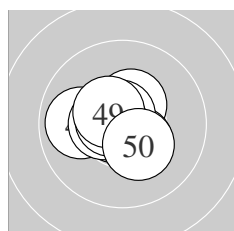

Serie 5:					
	10.7 *	10.4 *	10.8 *	9.9 ←	10.4 *
	10.7 *	10.5 *	10.6 *	10.5 *	10.3 *
beste Teiler	50.6 (43.) 55.3 (46.) 72.3 (41.)				
Trefferlage	0.36 mm links, 0.09 mm hoch				
Streuwert	0.95, horizontal: 1.08, vertikal: 0.80				

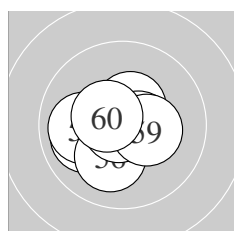

Serie 6:					
	10.7 *	10.7 *	10.5 *	10.0 ←	10.0 ←
	10.1 ↘	10.6 *	10.8 *	10.3 *	10.5 *
beste Teiler	26.4 (58.) 73.2 (52.) 75.1 (51.)				
Trefferlage	0.43 mm links, 0.08 mm tief				
Streuwert	1.09, horizontal: 1.28, vertikal: 0.85				

Meyton Elektronik

ISSF AR Women – Wertung – Frauen

StandNr: 104

Sagen, Maddalena #70811337

StartNr: 47

22. Januar 2019 11:48

USA

Unterschrift des Schützen

Meyton Elektronik

Ergebnis:	630.4	(599) ^{QF}						
Serien:	105.6	104.3	105.6	104.7	105.0	105.2		
Zähler:	59	1	0	0	0	0	0	0
Innenzehner:	58							
weiteste:	368 (13), 229 (38), 200 (18)							
beste Teiler	19.1 (59.)	28.4 (11.)	39.1 (57.)					
Trefferlage	0.13 mm rechts, 0.14 mm tief							
Streuwert	0.88, horizontal: 0.99, vertikal: 0.76							

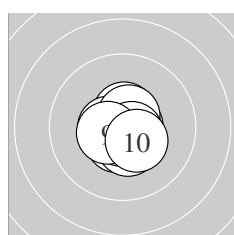
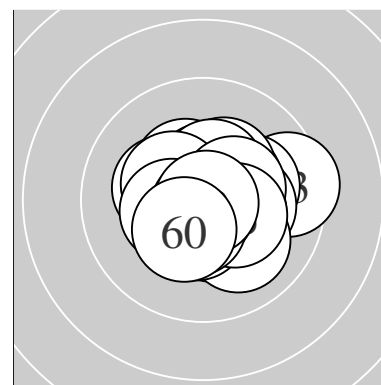

Serie 1:	10.7 *	10.5 *	10.6 *	10.4 *	10.7 *
	10.6 *	10.6 *	10.6 *	10.5 *	10.4 *
beste Teiler	56.0 (5.)	65.4 (1.)	76.8 (8.)		
Trefferlage	0.06 mm rechts, 0.27 mm tief				
Streuwert	0.72, horizontal: 0.70, vertikal: 0.75				

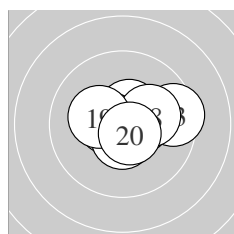

Serie 2:	10.8 *	10.7 *	9.5 →	10.5 *	10.5 *
	10.6 *	10.6 *	10.2 *	10.3 *	10.6 *
beste Teiler	28.4 (11.)	74.4 (12.)	84.2 (20.)		
Trefferlage	0.42 mm rechts, 0.18 mm hoch				
Streuwert	1.17, horizontal: 1.53, vertikal: 0.61				

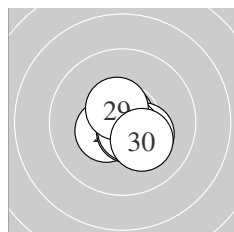

Serie 3:	10.6 *	10.7 *	10.8 *	10.3 *	10.7 *
	10.4 *	10.7 *	10.7 *	10.5 *	10.2 *
beste Teiler	40.0 (23.)	53.9 (25.)	65.4 (22.)		
Trefferlage	0.20 mm rechts, 0.39 mm tief				
Streuwert	0.75, horizontal: 0.84, vertikal: 0.64				

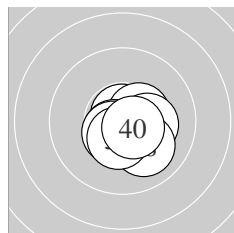

Serie 4:	10.8 *	10.4 *	10.5 *	10.2 *	10.6 *
	10.6 *	10.5 *	10.0 ↘	10.5 *	10.6 *
beste Teiler	40.4 (31.)	87.9 (40.)	92.9 (35.)		
Trefferlage	0.39 mm rechts, 0.64 mm tief				
Streuwert	0.80, horizontal: 0.88, vertikal: 0.71				

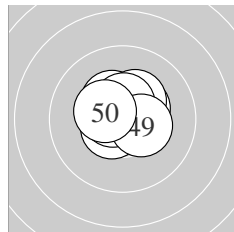

Serie 5:	10.4 *	10.7 *	10.6 *	10.6 *	10.4 *
	10.3 *	10.7 *	10.5 *	10.4 *	10.4 *
beste Teiler	65.9 (42.)	73.6 (47.)	79.1 (44.)		
Trefferlage	0.13 mm links, 0.42 mm hoch				
Streuwert	0.82, horizontal: 0.94, vertikal: 0.68				

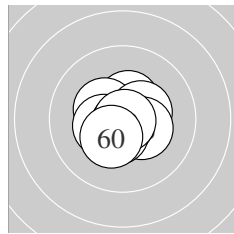

Serie 6:	10.7 *	10.4 *	10.4 *	10.4 *	10.4 *
	10.3 *	10.8 *	10.5 *	10.9 *	10.4 *
beste Teiler	19.1 (59.)	39.1 (57.)	68.1 (51.)		
Trefferlage	0.13 mm links, 0.15 mm tief				
Streuwert	0.87, horizontal: 0.96, vertikal: 0.78				

Meyton Elektronik

ISSF AR Women – Wertung – Frauen

StandNr: 105

Karimova, Iuliia #70811326

StartNr: 48

22. Januar 2019 11:25

RUS

QF – Schütze hat sich fürs Finale qualifiziert

Unterschrift des Schützen

Meyton Elektronik

Ergebnis: **622.8** (596)
 Serien: 104.4 105.3 102.1 101.7 104.2 105.1
 Zähler: 56 4 0 0 0 0 0 0 0
 Innenzehner: 48
 weiteste: 358 (39), 302 (25), 301 (27)
 beste Teiler 16.4 (59.) 55.4 (58.) 60.4 (15.)
 Trefferlage 0.16 mm rechts, 0.10 mm hoch
 Streuwert 1.13, horizontal: 1.27, vertikal: 0.97

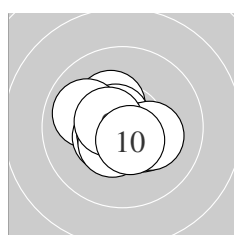
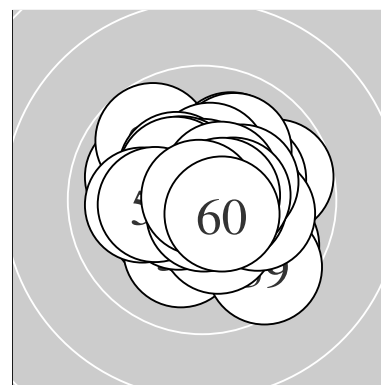

Serie 1:
 10.3 * 10.7 * 10.0 ↖ 10.4 * 10.2 *
 10.5 * 10.6 * 10.5 * 10.6 * 10.6 *
 beste Teiler 72.4 (2.) 85.5 (7.) 97.2 (10.)
 Trefferlage 0.33 mm links, 0.08 mm tief
 Streuwert 1.03, horizontal: 1.20, vertikal: 0.84

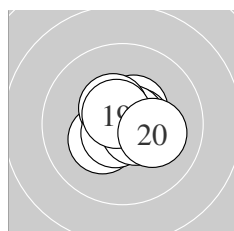

Serie 2:
 10.7 * 10.5 * 10.6 * 10.3 * 10.7 *
 10.5 * 10.7 * 10.6 * 10.6 * 10.1 →
 beste Teiler 60.4 (15.) 68.8 (11.) 75.4 (17.)
 Trefferlage 0.25 mm rechts, 0.10 mm hoch
 Streuwert 0.84, horizontal: 0.95, vertikal: 0.71

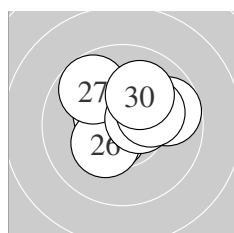

Serie 3:
 10.6 * 10.4 * 10.5 * 10.1 ↗ 9.7 →
 10.3 * 9.7 ↘ 10.5 * 10.2 * 10.1 ↗
 beste Teiler 92.6 (21.) 115.6 (23.) 116.1 (28.)
 Trefferlage 0.31 mm rechts, 0.72 mm hoch
 Streuwert 1.37, horizontal: 1.63, vertikal: 1.04

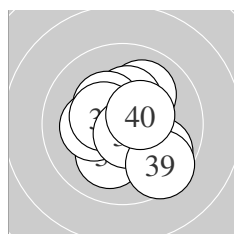

Serie 4:
 10.0 ↗ 10.3 * 10.3 * 10.1 ↓ 10.2 *
 10.4 * 9.8 ↘ 10.7 * 9.5 ↘ 10.4 *
 beste Teiler 71.1 (38.) 129.2 (40.) 132.7 (36.)
 Trefferlage 0.28 mm rechts, 0.13 mm tief
 Streuwert 1.54, horizontal: 1.50, vertikal: 1.57

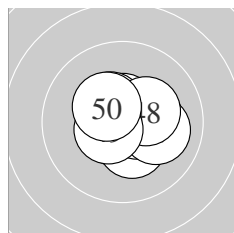

Serie 5:
 10.7 * 10.6 * 10.4 * 10.3 * 10.3 *
 10.6 * 10.1 → 10.3 * 10.5 * 10.4 *
 beste Teiler 75.1 (41.) 92.0 (42.) 95.5 (46.)
 Trefferlage 0.38 mm rechts, 0.05 mm hoch
 Streuwert 1.02, horizontal: 1.17, vertikal: 0.84

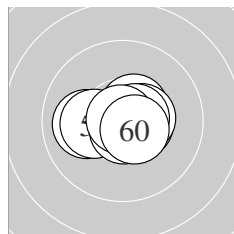

Serie 6:
 10.0 ← 10.2 * 10.5 * 10.5 * 10.6 *
 10.5 * 10.6 * 10.7 * 10.9 * 10.6 *
 beste Teiler 16.4 (59.) 55.4 (58.) 79.7 (55.)
 Trefferlage 0.11 mm rechts, 0.03 mm tief
 Streuwert 0.92, horizontal: 1.23, vertikal: 0.40

Meyton Elektronik

ISSF AR Women – Wertung – Frauen

StandNr: 106

Ungerank, Nadine #227

StartNr: 49

22. Januar 2019 11:35

AUT

Unterschrift des Schützen

Meyton Elektronik

Ergebnis:	617.1	(592)
Serien:	102.9	103.0 103.4 101.8 103.7 102.3
Zähler:	52	8 0 0 0 0 0 0 0 0
Innenzehner:	40	
weiteste:	355	(18), 300 (29), 298 (56)
beste Teiler	38.9	(21.) 44.0 (37.) 46.5 (44.)
Trefferlage	0.12 mm	rechts, 0.06 mm hoch
Streuwert	1.29,	horizontal: 1.47, vertikal: 1.08

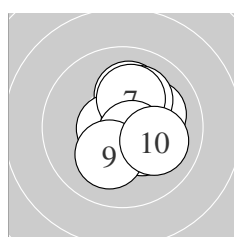
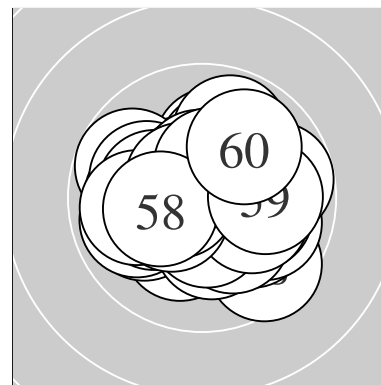

Serie 1:	10.1 →	10.1 ↑	10.6 *	10.3 *	10.6 *
	10.1 ↗	10.2 *	10.6 *	10.2 *	10.1 ↘
beste Teiler	77.4	(3.) 79.5 (8.)	99.9 (5.)		
Trefferlage	0.70 mm	rechts, 0.28 mm	hoch		
Streuwert	1.17,	horizontal: 0.97,	vertikal: 1.34		

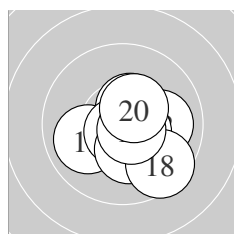

Serie 2:	10.4 *	10.0 →	10.0 ←	10.5 *	10.5 *
	10.7 *	10.3 *	9.5 ↘	10.7 *	10.4 *
beste Teiler	56.4	(16.) 67.9 (19.)	106.0 (14.)		
Trefferlage	0.60 mm	rechts, 0.56 mm	tief		
Streuwert	1.23,	horizontal: 1.32,	vertikal: 1.13		

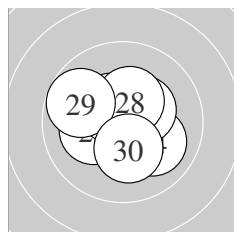

Serie 3:	10.8 *	10.5 *	10.6 *	10.0 ↘	10.2 *
	10.4 *	10.5 *	10.4 *	9.8 ↖	10.2 *
beste Teiler	38.9	(21.) 91.9 (23.)	119.8 (22.)		
Trefferlage	0.24 mm	links, 0.18 mm	hoch		
Streuwert	1.26,	horizontal: 1.42,	vertikal: 1.08		

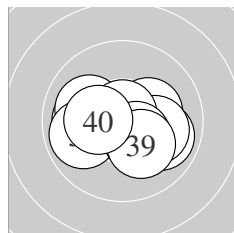

Serie 4:	10.0 ←	10.0 ↖	9.9 ↗	10.2 *	9.9 ←
	10.1 →	10.8 *	10.4 *	10.2 *	10.3 *
beste Teiler	44.0	(37.) 130.9 (38.)	159.2 (40.)		
Trefferlage	0.03 mm	links, 0.29 mm	tief		
Streuwert	1.49,	horizontal: 1.96,	vertikal: 0.78		

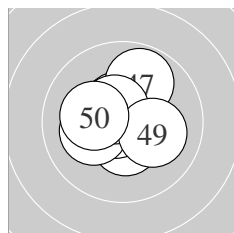

Serie 5:	10.5 *	10.5 *	10.4 *	10.8 *	10.6 *
	10.2 *	9.8 ↗	10.6 *	10.1 →	10.2 *
beste Teiler	46.5	(44.) 89.8 (45.)	97.0 (48.)		
Trefferlage	0.30 mm	links, 0.35 mm	hoch		
Streuwert	1.13,	horizontal: 1.18,	vertikal: 1.08		

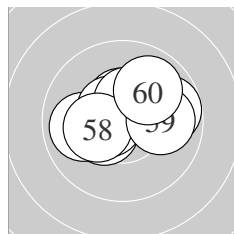

Serie 6:	10.4 *	10.5 *	9.9 ←	10.6 *	10.5 *
	9.8 →	10.4 *	10.3 *	10.0 →	9.9 ↗
beste Teiler	94.5	(54.) 103.3 (55.)	120.5 (52.)		
Trefferlage	0.02 mm	rechts, 0.44 mm	hoch		
Streuwert	1.42,	horizontal: 1.81,	vertikal: 0.88		

Meyton Elektronik

ISSF AR Women – Wertung – Frauen

StandNr: 108

Hyblerova, Jana #70811342

StartNr: 51

22. Januar 2019 11:46

Police Sports Center Slovakia

Unterschrift des Schützen

Meyton Elektronik

Ergebnis:	631.6	(597) ^{QF}							
Serien:	105.8	106.4	104.7	105.7	104.0	105.0			
Zähler:	57	3	0	0	0	0	0	0	0
Innenzehner:	57								
weiteste:	276 (21), 265 (58), 262 (29)								
beste Teiler	6.3 (36.) 12.5 (27.) 26.3 (12.)								
Trefferlage	0.13 mm links, 0.20 mm hoch								
Streuwert	0.85, horizontal: 0.90, vertikal: 0.78								

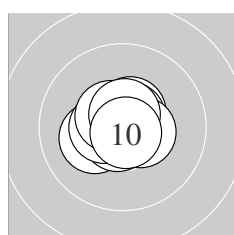
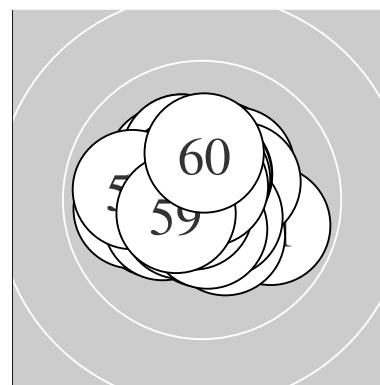

Serie 1:					
	10.2 *	10.5 *	10.7 *	10.8 *	10.7 *
	10.5 *	10.5 *	10.5 *	10.6 *	10.8 *
beste Teiler	40.3 (10.) 46.0 (4.) 62.7 (5.)				
Trefferlage	0.16 mm links, 0.15 mm hoch				
Streuwert	0.73, horizontal: 0.85, vertikal: 0.60				

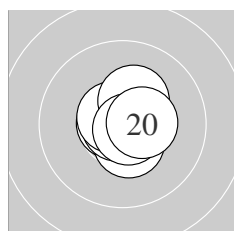

Serie 2:					
	10.6 *	10.8 *	10.7 *	10.8 *	10.5 *
	10.8 *	10.6 *	10.3 *	10.8 *	10.5 *
beste Teiler	26.3 (12.) 33.9 (16.) 46.4 (14.)				
Trefferlage	0.17 mm rechts, 0.05 mm hoch				
Streuwert	0.64, horizontal: 0.63, vertikal: 0.66				

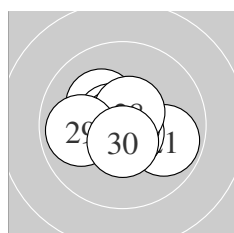

Serie 3:					
	9.8 ↘	10.7 *	10.2 *	10.7 *	10.6 *
	10.8 *	10.9 *	10.6 *	9.9 ←	10.5 *
beste Teiler	12.5 (27.) 34.2 (26.) 59.2 (24.)				
Trefferlage	0.20 mm links, 0.05 mm tief				
Streuwert	1.08, horizontal: 1.34, vertikal: 0.73				

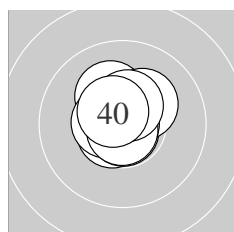

Serie 4:					
	10.6 *	10.8 *	10.5 *	10.2 *	10.2 *
	10.9 *	10.6 *	10.8 *	10.5 *	10.6 *
beste Teiler	6.3 (36.) 35.1 (38.) 40.1 (32.)				
Trefferlage	0.07 mm links, 0.46 mm hoch				
Streuwert	0.74, horizontal: 0.69, vertikal: 0.79				

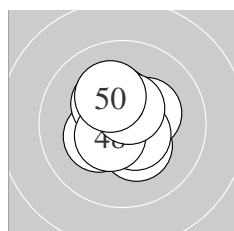

Serie 5:					
	10.7 *	10.3 *	10.3 *	10.4 *	10.3 *
	10.3 *	10.5 *	10.5 *	10.5 *	10.2 *
beste Teiler	57.3 (41.) 102.9 (47.) 104.9 (49.)				
Trefferlage	0.11 mm links, 0.29 mm hoch				
Streuwert	1.02, horizontal: 0.96, vertikal: 1.08				

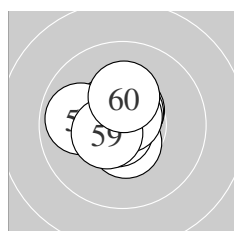

Serie 6:					
	10.6 *	10.5 *	10.7 *	10.8 *	10.6 *
	10.5 *	10.7 *	9.9 ←	10.5 *	10.2 *
beste Teiler	50.3 (54.) 56.3 (57.) 69.1 (53.)				
Trefferlage	0.41 mm links, 0.31 mm hoch				
Streuwert	0.88, horizontal: 0.92, vertikal: 0.84				

ISSF AR Women – Wertung – Frauen

StandNr: 109

Brabcova, Aneta #233

StartNr: 52

22. Januar 2019 11:43

CZE

QF – Schütze hat sich fürs Finale qualifiziert

Unterschrift des Schützen

Meyton Elektronik

Ergebnis:	629.2	(597) ^{QF}							
Serien:	103.9	103.6	105.0	104.5	106.1	106.1			
Zähler:	57	3	0	0	0	0	0	0	0
Innenzehner:	49								
weiteste:	402 (35), 265 (9), 257 (17)								
beste Teiler	8.0 (39.)	21.8 (14.)	26.1 (7.)						
Trefferlage	0.03 mm links, 0.16 mm hoch								
Streuwert	1.00, horizontal: 0.93, vertikal: 1.07								

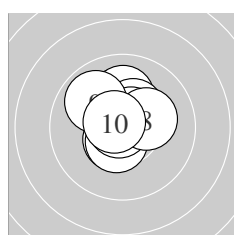
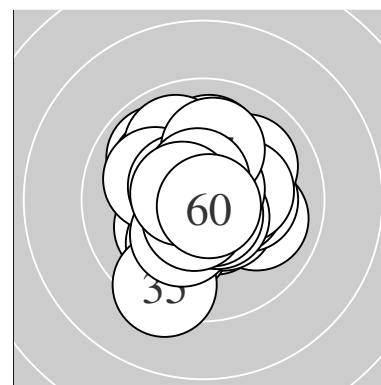

Serie 1:	10.2 *	10.1 ↑	10.4 *	10.6 *	10.5 *
	10.5 *	10.8 *	10.2 *	9.9 ↘	10.7 *
beste Teiler	26.1 (7.) 71.0 (10.) 89.1 (4.)				
Trefferlage	0.11 mm links, 0.69 mm hoch				
Streuwert	1.06, horizontal: 0.98, vertikal: 1.13				

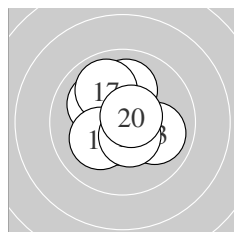

Serie 2:	10.1 ↘	10.0 ↑	10.0 ↘	10.9 *	10.7 *
	10.6 *	9.9 ↘	10.2 *	10.5 *	10.7 *
beste Teiler	21.8 (14.) 61.0 (15.) 74.8 (20.)				
Trefferlage	0.17 mm links, 0.27 mm hoch				
Streuwert	1.26, horizontal: 1.21, vertikal: 1.30				

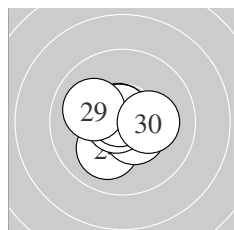

Serie 3:	10.7 *	10.7 *	10.5 *	10.1 ↙	10.7 *
	10.5 *	10.8 *	10.7 *	10.1 ↘	10.2 *
beste Teiler	44.0 (27.) 52.8 (28.) 61.7 (25.)				
Trefferlage	0.30 mm links, 0.16 mm tief				
Streuwert	0.95, horizontal: 1.05, vertikal: 0.84				

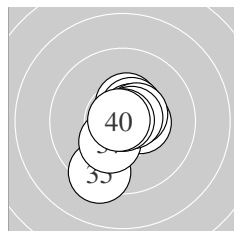

Serie 4:	10.5 *	10.5 *	10.6 *	10.4 *	9.3 ↙
	10.5 *	10.3 *	10.7 *	10.9 *	10.8 *
beste Teiler	8.0 (39.) 27.8 (40.) 69.6 (38.)				
Trefferlage	0.16 mm rechts, 0.18 mm tief				
Streuwert	1.19, horizontal: 0.90, vertikal: 1.42				

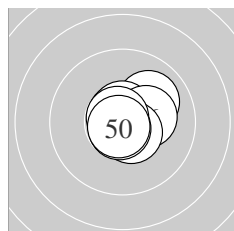

Serie 5:	10.8 *	10.7 *	10.7 *	10.0 ↗	10.7 *
	10.3 *	10.6 *	10.7 *	10.8 *	10.8 *
beste Teiler	43.2 (50.) 46.0 (41.) 48.9 (49.)				
Trefferlage	0.39 mm rechts, 0.14 mm hoch				
Streuwert	0.74, horizontal: 0.80, vertikal: 0.66				

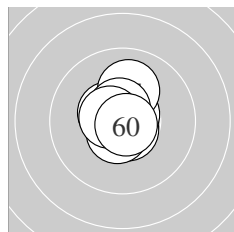

Serie 6:	10.7 *	10.5 *	10.8 *	10.7 *	10.7 *
	10.6 *	10.1 ↑	10.6 *	10.6 *	10.8 *
beste Teiler	36.7 (60.) 37.4 (53.) 57.6 (54.)				
Trefferlage	0.19 mm links, 0.22 mm hoch				
Streuwert	0.72, horizontal: 0.53, vertikal: 0.87				

Meyton Elektronik

ISSF AR Women – Wertung – Frauen

StandNr: 111

Vdovina, Daria #70811335

StartNr: 54

22. Januar 2019 11:34

RUS

QF – Schütze hat sich fürs Finale qualifiziert

Unterschrift des Schützen

Meyton Elektronik

Ergebnis: **606.9** (582)

Serien: 98.3 102.2 100.2 102.8 100.7 102.7

Zähler: 43 16 1 0 0 0 0 0 0 0

Innenzehner: 30

weiteste: 547 (18), 491 (6), 420 (43)

beste Teiler 14.1 (34.) 46.0 (26.) 59.1 (15.)

Trefferlage 0.20 mm rechts, 0.61 mm hoch

Streuwert 1.63, horizontal: 2.02, vertikal: 1.11

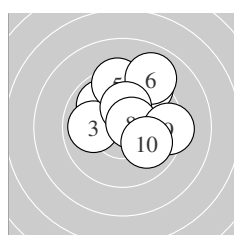
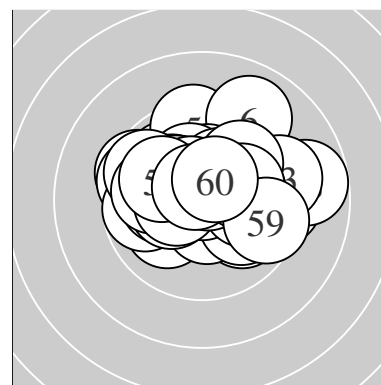

Serie 1:

10.6 *	9.9 ↘	9.9 ←	9.3 ↗	9.4 ↑
9.0 ↗	10.3 *	10.6 *	9.3 →	10.0 ↘

beste Teiler 86.3 (8.) 99.8 (1.) 174.2 (7.)

Trefferlage 0.79 mm rechts, 1.44 mm hoch

Streuwert 1.95, horizontal: 2.01, vertikal: 1.89

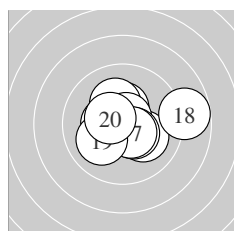

Serie 2:

10.4 *	10.1 ↘	10.4 *	10.2 *	10.7 *
10.5 *	10.5 *	8.8 →	10.1 ↙	10.5 *

beste Teiler 59.1 (15.) 103.2 (17.) 119.8 (20.)

Trefferlage 0.43 mm rechts, 0.13 mm hoch

Streuwert 1.66, horizontal: 2.08, vertikal: 1.07

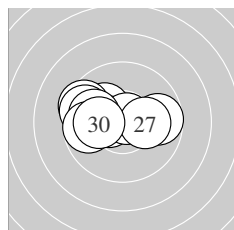

Serie 3:

10.2 *	9.5 ↖	9.7 →	10.5 *	9.6 ↖
10.8 *	10.2 *	9.9 ←	9.7 ←	10.1 ←

beste Teiler 46.0 (26.) 117.0 (24.) 196.1 (27.)

Trefferlage 1.15 mm links, 0.42 mm hoch

Streuwert 1.64, horizontal: 2.24, vertikal: 0.61

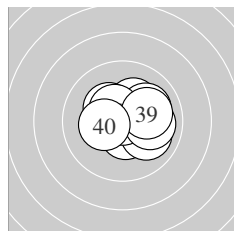

Serie 4:

10.5 *	10.2 *	10.0 ↘	10.9 *	10.3 *
10.0 ↗	10.0 →	10.5 *	10.1 →	10.3 *

beste Teiler 14.1 (34.) 114.0 (31.) 118.0 (38.)

Trefferlage 0.62 mm rechts, 0.26 mm hoch

Streuwert 1.25, horizontal: 1.49, vertikal: 0.95

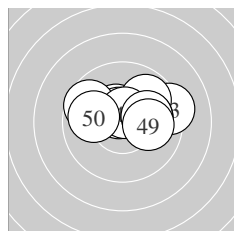

Serie 5:

10.5 *	10.6 *	9.3 →	9.7 ↖	9.8 ↗
10.1 →	10.6 *	10.1 →	10.1 →	9.9 ←

beste Teiler 83.4 (47.) 85.6 (42.) 120.8 (41.)

Trefferlage 0.64 mm rechts, 0.82 mm hoch

Streuwert 1.65, horizontal: 2.25, vertikal: 0.60

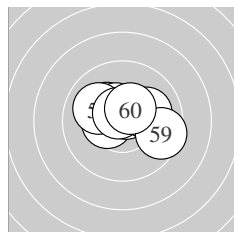

Serie 6:

10.2 *	10.3 *	10.4 *	10.7 *	10.5 *
10.1 →	10.0 ↖	10.6 *	9.5 →	10.4 *

beste Teiler 71.5 (54.) 77.8 (58.) 122.1 (55.)

Trefferlage 0.09 mm links, 0.58 mm hoch

Streuwert 1.32, horizontal: 1.73, vertikal: 0.70

ISSF AR Women – Wertung – Frauen

StandNr: 112

Olsavska, Ivana #70811339

StartNr: 55

22. Januar 2019 11:55

Police Sports Center Slovakia

Unterschrift des Schützen

Meyton Elektronik

Ergebnis:	623.2	(596)					
Serien:	103.6	105.0	104.5	104.3	102.9	102.9	
Zähler:	56	4	0	0	0	0	0
Innenzehner:	48						
weiteste:	335 (50), 322 (10), 276 (59)						
beste Teiler	28.1 (51.) 31.7 (4.) 46.1 (12.)						
Trefferlage	0.09 mm links, 0.19 mm hoch						
Streuwert	1.11, horizontal: 1.02, vertikal: 1.19						

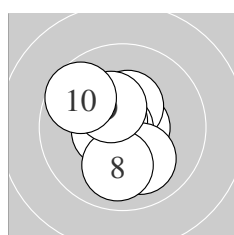
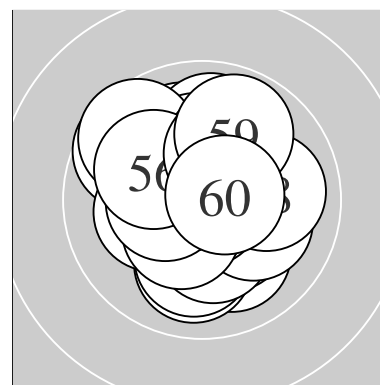

Serie 1:					
	10.4 *	10.7 *	10.4 *	10.8 *	10.6 *
	10.6 *	10.0 ↘	10.0 ↓	10.4 *	9.7 ↖
beste Teiler	31.7 (4.) 74.0 (2.) 77.8 (5.)				
Trefferlage	0.35 mm links, 0.11 mm tief				
Streuwert	1.24, horizontal: 1.04, vertikal: 1.42				

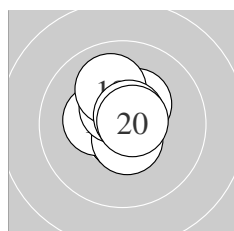

Serie 2:					
	10.4 *	10.8 *	10.7 *	10.3 *	10.3 *
	10.6 *	10.5 *	10.0 ↗	10.7 *	10.7 *
beste Teiler	46.1 (12.) 65.1 (20.) 66.0 (13.)				
Trefferlage	0.01 mm rechts, 0.54 mm hoch				
Streuwert	0.84, horizontal: 0.75, vertikal: 0.92				

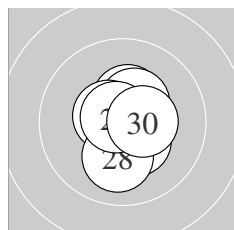

Serie 3:					
	10.4 *	10.4 *	10.4 *	10.6 *	10.4 *
	10.6 *	10.4 *	10.1 ↓	10.7 *	10.5 *
beste Teiler	52.2 (29.) 80.5 (24.) 98.0 (26.)				
Trefferlage	0.24 mm rechts, 0.34 mm tief				
Streuwert	0.95, horizontal: 0.65, vertikal: 1.17				

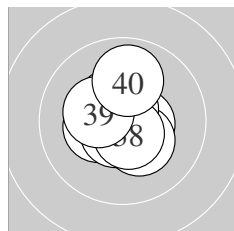

Serie 4:					
	10.5 *	10.3 *	10.7 *	10.5 *	10.6 *
	10.3 *	10.6 *	10.6 *	10.3 *	9.9 ↑
beste Teiler	59.6 (33.) 77.0 (35.) 80.9 (37.)				
Trefferlage	0.14 mm links, 0.11 mm hoch				
Streuwert	1.02, horizontal: 0.91, vertikal: 1.13				

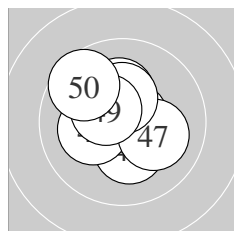

Serie 5:					
	10.2 *	10.3 *	10.7 *	10.7 *	10.3 *
	10.2 *	10.1 ↘	10.4 *	10.4 *	9.6 ↖
beste Teiler	66.1 (43.) 66.3 (44.) 130.0 (49.)				
Trefferlage	0.45 mm links, 0.41 mm hoch				
Streuwert	1.28, horizontal: 1.32, vertikal: 1.24				

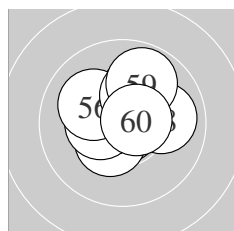

Serie 6:					
	10.8 *	10.1 ↗	10.5 *	10.4 *	10.4 *
	10.1 ↖	10.2 *	10.0 →	9.8 ↑	10.6 *
beste Teiler	28.1 (51.) 88.0 (60.) 105.0 (53.)				
Trefferlage	0.15 mm rechts, 0.54 mm hoch				
Streuwert	1.26, horizontal: 1.31, vertikal: 1.21				

Meyton Elektronik

ISSF AR Women – Wertung – Frauen

StandNr: 113

Sajjanar, Meghana Mallikarjun #70811345

StartNr: 56

22. Januar 2019 11:54

IND

Unterschrift des Schützen

Meyton Elektronik

Ergebnis: **618.1** (587)
 Serien: 103.5 103.1 102.6 101.8 103.7 103.4
 Zähler: 47 13 0 0 0 0 0 0 0
 Innenzehner: 39
 weiteste: 374 (58), 347 (27), 311 (43)
 beste Teiler 8.0 (53.) 40.2 (57.) 41.3 (2.)
 Trefferlage 0.11 mm links, 0.04 mm hoch
 Streuwert 1.32, horizontal: 1.55, vertikal: 1.05

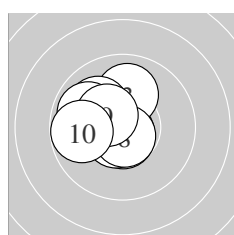
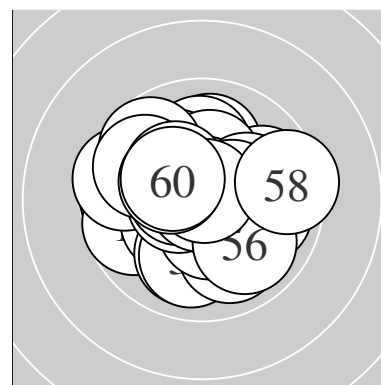

Serie 1:
 10.7 * 10.8 * 10.0 ↑ 10.0 ↘ 10.6 *
 10.6 * 9.9 ↖ 10.7 * 10.4 * 9.8 ←
 beste Teiler 41.3 (2.) 64.3 (8.) 75.1 (1.)
 Trefferlage 0.87 mm links, 0.22 mm hoch
 Streuwert 1.13, horizontal: 1.16, vertikal: 1.10

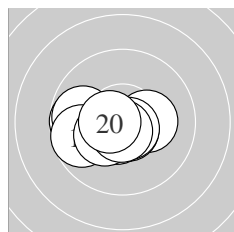

Serie 2:
 10.3 * 10.7 * 10.6 * 9.7 ← 9.8 ←
 9.7 ← 10.7 * 10.3 * 10.7 * 10.6 *
 beste Teiler 60.9 (17.) 64.6 (19.) 67.9 (12.)
 Trefferlage 0.90 mm links, 0.38 mm tief
 Streuwert 1.20, horizontal: 1.62, vertikal: 0.48

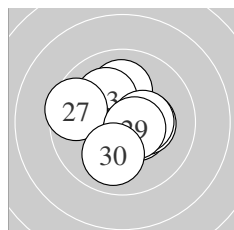

Serie 3:
 10.6 * 10.1 ↑ 10.1 ↘ 10.5 * 10.4 *
 10.3 * 9.6 ← 10.4 * 10.6 * 10.0 ↓
 beste Teiler 85.5 (21.) 96.1 (29.) 115.4 (24.)
 Trefferlage 0.13 mm links, 0.07 mm hoch
 Streuwert 1.42, horizontal: 1.49, vertikal: 1.36

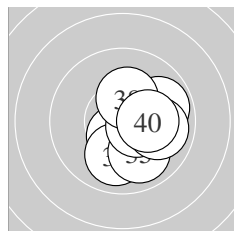

Serie 4:
 10.0 → 10.6 * 10.5 * 10.0 ↓ 9.9 ↘
 9.9 → 10.5 * 10.3 * 9.9 → 10.2 *
 beste Teiler 81.2 (32.) 109.1 (37.) 112.8 (33.)
 Trefferlage 1.18 mm rechts, 0.33 mm tief
 Streuwert 1.22, horizontal: 1.14, vertikal: 1.29

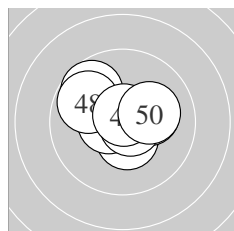

Serie 5:
 10.6 * 10.5 * 9.7 ↘ 10.2 * 10.7 *
 10.6 * 10.7 * 9.8 ↘ 10.8 * 10.1 →
 beste Teiler 50.8 (49.) 58.1 (45.) 60.7 (47.)
 Trefferlage 0.09 mm links, 0.34 mm hoch
 Streuwert 1.26, horizontal: 1.49, vertikal: 0.98

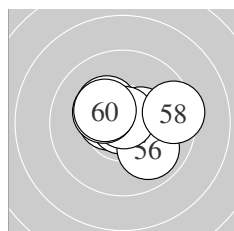

Serie 6:
 10.5 * 10.5 * 10.9 * 10.3 * 10.4 *
 9.9 ↘ 10.8 * 9.5 → 10.3 * 10.3 *
 beste Teiler 8.0 (53.) 40.2 (57.) 102.2 (51.)
 Trefferlage 0.12 mm rechts, 0.34 mm hoch
 Streuwert 1.31, horizontal: 1.66, vertikal: 0.83

Meyton Elektronik

ISSF AR Women – Wertung – Frauen

StandNr: 114

Baumgartner, Joelle #70811341

StartNr: 57

22. Januar 2019 11:41

SUI – ZH

Unterschrift des Schützen

Meyton Elektronik

Ergebnis:	625.4	(594)					
Serien:	104.5	105.4	102.8	104.1	104.6	104.0	
Zähler:	54	6	0	0	0	0	0
Innenzehner:	48						
weiteste:	371 (35), 295 (48), 289 (23)						
beste Teiler	16.1 (38.) 16.6 (52.) 29.5 (2.)						
Trefferlage	0.50 mm links, 0.06 mm hoch						
Streuwert	1.05, horizontal: 1.07, vertikal: 1.02						

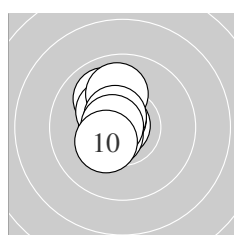
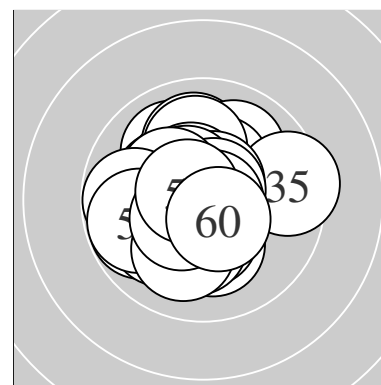

Serie 1:	10.0 ↘	10.8 *	10.6 *	10.6 *	10.3 *
	10.6 *	10.0 ↑	10.6 *	10.7 *	10.3 *
beste Teiler	29.5 (2.) 75.5 (9.) 80.7 (6.)				
Trefferlage	0.78 mm links, 0.55 mm hoch				
Streuwert	0.80, horizontal: 0.35, vertikal: 1.07				

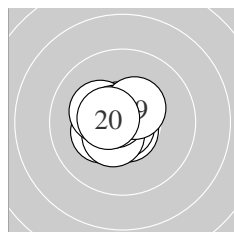

Serie 2:	10.6 *	10.3 *	10.7 *	10.8 *	10.5 *
	10.7 *	10.2 *	10.7 *	10.4 *	10.5 *
beste Teiler	32.3 (14.) 68.8 (18.) 69.7 (13.)				
Trefferlage	0.53 mm links, 0.00 mm				
Streuwert	0.74, horizontal: 0.78, vertikal: 0.70				

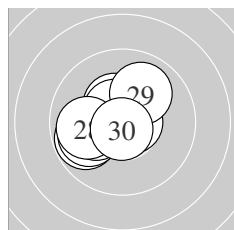

Serie 3:	10.5 *	10.7 *	9.8 ↙	9.9 ↙	10.4 *
	10.2 *	10.6 *	9.9 ↙	10.0 ↗	10.8 *
beste Teiler	50.4 (30.) 64.0 (22.) 100.6 (27.)				
Trefferlage	0.80 mm links, 0.16 mm hoch				
Streuwert	1.29, horizontal: 1.48, vertikal: 1.06				

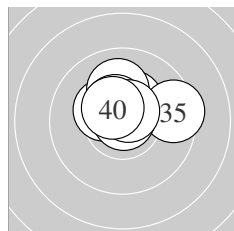

Serie 4:	10.8 *	10.3 *	10.3 *	10.0 ↑	9.5 →
	10.7 *	10.5 *	10.9 *	10.6 *	10.5 *
beste Teiler	16.1 (38.) 48.0 (31.) 52.7 (36.)				
Trefferlage	0.21 mm rechts, 0.89 mm hoch				
Streuwert	1.03, horizontal: 1.34, vertikal: 0.59				

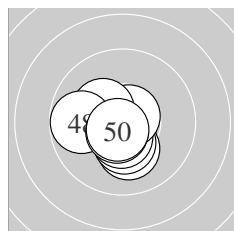

Serie 5:	10.7 *	10.7 *	10.2 *	10.4 *	10.5 *
	10.7 *	10.3 *	9.8 ←	10.6 *	10.7 *
beste Teiler	53.7 (41.) 61.5 (46.) 62.5 (42.)				
Trefferlage	0.44 mm links, 0.46 mm tief				
Streuwert	0.96, horizontal: 1.03, vertikal: 0.89				

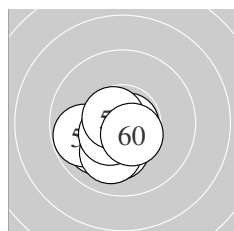

Serie 6:	10.0 ↙	10.9 *	9.8 ↙	10.2 *	10.8 *
	10.7 *	10.0 ↘	10.5 *	10.6 *	10.5 *
beste Teiler	16.6 (52.) 38.0 (55.) 67.0 (56.)				
Trefferlage	0.70 mm links, 0.78 mm tief				
Streuwert	0.92, horizontal: 1.00, vertikal: 0.83				

Meyton Elektronik

ISSF AR Women – Wertung – Frauen

StandNr: 115

Pribitzer, Marlene #231

StartNr: 58

22. Januar 2019 11:55

AUT

Unterschrift des Schützen

Meyton Elektronik

Ergebnis:	615.9	(589)							
Serien:	101.4	104.7	102.9	102.8	101.9	102.2			
Zähler:	49	11	0	0	0	0	0	0	0
Innenzehner:	36								
weiteste:	418 (49), 375 (7), 351 (29)								
beste Teiler	10.0 (20.) 21.6 (27.) 21.9 (17.)								
Trefferlage	0.11 mm rechts, 0.29 mm hoch								
Streuwert	1.37, horizontal: 1.58, vertikal: 1.12								

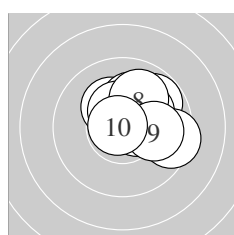
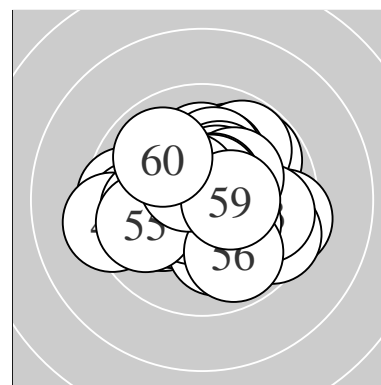

Serie 1:					
	10.5 *	10.2 *	10.1 ↑	9.8 ↗	10.4 *
	10.1 ↗	9.5 →	10.0 ↑	10.0 →	10.8 *
beste Teiler	40.1 (10.) 106.1 (1.) 129.3 (5.)				
Trefferlage	1.11 mm rechts, 0.87 mm hoch				
Streuwert	1.25, horizontal: 1.44, vertikal: 1.04				

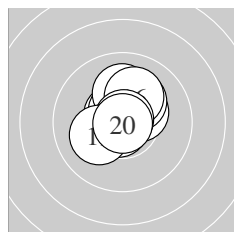

Serie 2:					
	10.4 *	10.6 *	10.6 *	10.2 *	10.1 ↑
	10.1 ↑	10.9 *	10.8 *	10.1 ←	10.9 *
beste Teiler	10.0 (20.) 21.9 (17.) 50.6 (18.)				
Trefferlage	0.01 mm rechts, 0.65 mm hoch				
Streuwert	0.96, horizontal: 0.90, vertikal: 1.01				

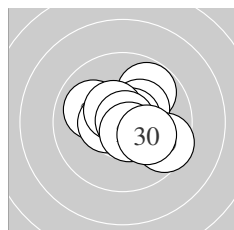

Serie 3:					
	10.0 ↖	10.5 *	9.8 ↗	10.3 *	10.7 *
	10.5 *	10.9 *	10.6 *	9.5 →	10.1 ↘
beste Teiler	21.6 (27.) 70.2 (25.) 88.7 (28.)				
Trefferlage	0.53 mm rechts, 0.21 mm hoch				
Streuwert	1.38, horizontal: 1.59, vertikal: 1.12				

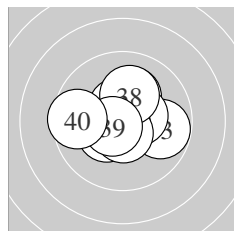

Serie 4:					
	10.5 *	10.2 *	9.8 →	10.4 *	10.5 *
	10.5 *	10.6 *	10.1 ↑	10.6 *	9.6 ←
beste Teiler	85.8 (39.) 91.1 (37.) 107.2 (35.)				
Trefferlage	0.06 mm rechts, 0.31 mm hoch				
Streuwert	1.39, horizontal: 1.67, vertikal: 1.04				

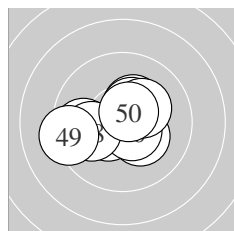

Serie 5:					
	10.3 *	10.3 *	9.8 ←	10.4 *	10.4 *
	10.6 *	10.2 *	10.0 ←	9.3 ←	10.6 *
beste Teiler	89.6 (50.) 98.3 (46.) 128.7 (45.)				
Trefferlage	0.50 mm links, 0.03 mm tief				
Streuwert	1.55, horizontal: 1.97, vertikal: 0.97				

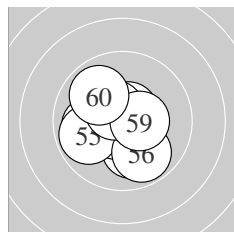

Serie 6:					
	10.1 ↓	10.3 *	10.6 *	10.0 ←	9.9 ←
	9.8 ↓	10.6 *	10.6 *	10.4 *	9.9 ↘
beste Teiler	78.5 (53.) 82.4 (57.) 100.8 (58.)				
Trefferlage	0.53 mm links, 0.23 mm tief				
Streuwert	1.41, horizontal: 1.47, vertikal: 1.35				

Meyton Elektronik

ISSF AR Women – Wertung – Frauen

StandNr: 116

Adams, Emma #70811330

StartNr: 59

22. Januar 2019 11:49

Australia

Unterschrift des Schützen

Meyton Elektronik

Ergebnis:	586.3	(559)
Serien:	100.4 95.2 95.2 101.1 98.1 96.3	
Zähler:	27 25 8 0 0 0 0 0 0	
Innenzehner:	17	
weiteste:	706 (27), 597 (15), 589 (55)	
beste Teiler	45.0 (31.) 48.2 (10.) 62.0 (23.)	
Trefferlage	0.16 mm rechts, 0.06 mm hoch	
Streuwert	2.38, horizontal: 2.51, vertikal: 2.24	

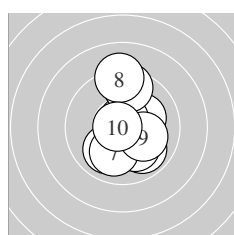
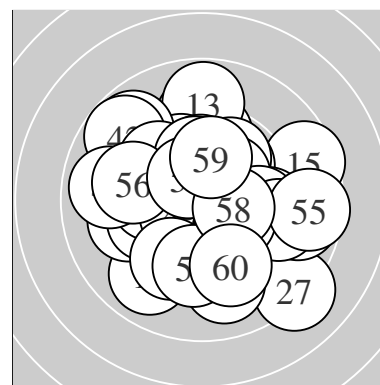

Serie 1:

10.2 *	10.0 ↙	9.9 ↘	10.7 *	10.1 ↘
9.5 ↑	10.0 ↘	9.1 ↑	10.1 ↘	10.8 *
beste Teiler	48.2 (10.)	68.6 (4.)	193.2 (1.)	
Trefferlage	0.43 mm rechts, 0.08 mm hoch			
Streuwert	1.88, horizontal: 1.18, vertikal: 2.39			

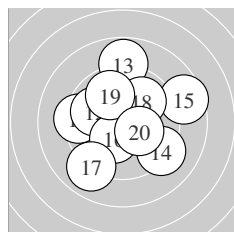

Serie 2:

9.3 ←	9.9 ↖	8.8 ↑	9.2 ↘	8.6 →
10.3 *	9.0 ↙	9.9 ↗	9.9 ↗	10.3 *
beste Teiler	169.4 (16.)	172.2 (20.)	256.8 (18.)	
Trefferlage	0.10 mm rechts, 0.40 mm hoch			
Streuwert	2.89, horizontal: 3.02, vertikal: 2.75			

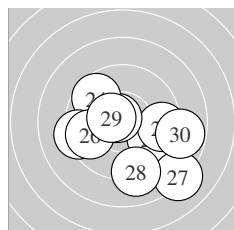

Serie 3:

9.8 ↘	9.5 →	10.7 *	9.7 ↖	9.3 ←
9.7 ←	8.1 ↘	9.1 ↓	10.5 *	8.8 →
beste Teiler	62.0 (23.)	110.4 (29.)	300.7 (21.)	
Trefferlage	0.68 mm rechts, 1.16 mm tief			
Streuwert	2.83, horizontal: 3.37, vertikal: 2.17			

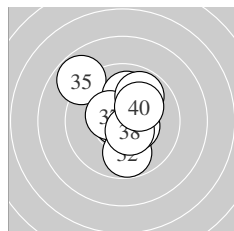

Serie 4:

10.8 *	9.8 ↓	10.5 *	10.2 *	8.8 ↖
10.0 ↑	10.4 *	10.5 *	9.9 ↗	10.2 *
beste Teiler	45.0 (31.)	108.6 (38.)	124.4 (33.)	
Trefferlage	0.15 mm rechts, 0.73 mm hoch			
Streuwert	1.76, horizontal: 1.63, vertikal: 1.89			

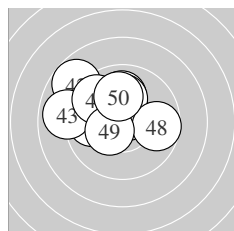

Serie 5:

9.8 ←	8.8 ↖	8.9 ←	10.7 *	9.7 ↖
10.0 ↑	10.1 ↑	9.7 →	10.4 *	10.0 ↑
beste Teiler	68.6 (44.)	142.2 (49.)	214.0 (47.)	
Trefferlage	1.25 mm links, 1.25 mm hoch			
Streuwert	1.98, horizontal: 2.41, vertikal: 1.42			

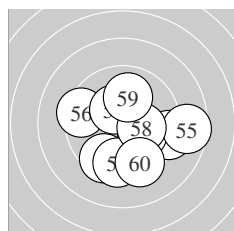

Serie 6:

9.2 →	10.1 ↘	9.5 ↙	9.5 ↓	8.6 →
9.4 ←	10.4 *	10.2 *	10.0 ↑	9.4 ↓
beste Teiler	145.9 (57.)	178.2 (58.)	208.8 (52.)	
Trefferlage	0.89 mm rechts, 0.90 mm tief			
Streuwert	2.47, horizontal: 2.81, vertikal: 2.08			

ISSF AR Women – Wertung – Frauen

StandNr: 117

Anlanger, Beatrice Carina #70811324

StartNr: 60

22. Januar 2019 11:38

OÖ – SV Laakirchen

Unterschrift des Schützen

Meyton Elektronik

Ergebnis: **620.5** (590)

Serien: 102.3 103.4 105.9 101.2 103.5 104.2

Zähler: 50 10 0 0 0 0 0 0 0

Innenzehner: 42

weiteste: 337 (37), 335 (40), 332 (10)

beste Teiler 10.0 (30.) 19.4 (9.) 35.7 (57.)

Trefferlage 0.01 mm links, 0.04 mm hoch

Streuwert 1.26, horizontal: 1.38, vertikal: 1.11

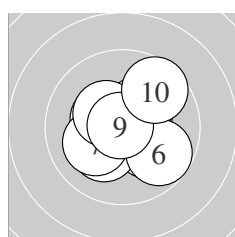
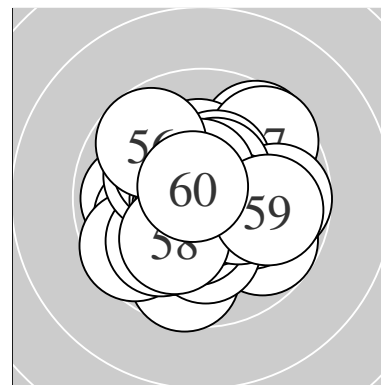

Serie 1:

10.4 *	10.4 *	10.4 *	10.1 ↘	10.2 *
9.8 ↘	10.1 ↙	10.4 *	10.9 *	9.6 ↗

beste Teiler 19.4 (9.) 142.4 (3.) 144.3 (8.)

Trefferlage 0.28 mm rechts, 0.06 mm hoch

Streuwert 1.50, horizontal: 1.60, vertikal: 1.38

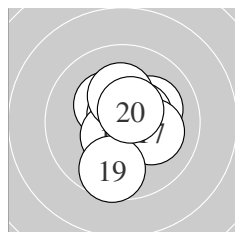

Serie 2:

10.1 ↗	10.7 *	10.3 *	10.7 *	10.5 *
10.5 *	10.1 ↘	10.2 *	9.7 ↓	10.6 *

beste Teiler 54.7 (14.) 59.0 (12.) 99.0 (20.)

Trefferlage 0.33 mm rechts, 0.09 mm hoch

Streuwert 1.24, horizontal: 1.05, vertikal: 1.40

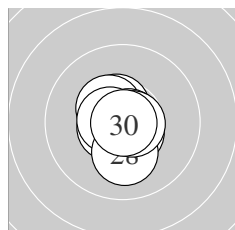

Serie 3:

10.7 *	10.5 *	10.4 *	10.6 *	10.6 *
10.8 *	10.6 *	10.1 ↓	10.7 *	10.9 *

beste Teiler 10.0 (30.) 39.0 (26.) 54.1 (21.)

Trefferlage 0.17 mm links, 0.10 mm tief

Streuwert 0.74, horizontal: 0.61, vertikal: 0.86

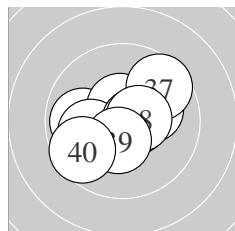

Serie 4:

9.9 ↙	10.1 ↗	9.9 ↙	10.6 *	10.0 ↙
10.6 *	9.6 ↗	10.5 *	10.4 *	9.6 ↙

beste Teiler 82.0 (36.) 99.6 (34.) 110.1 (38.)

Trefferlage 0.42 mm links, 0.05 mm tief

Streuwert 1.64, horizontal: 1.98, vertikal: 1.22

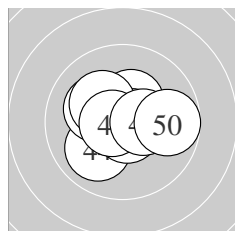

Serie 5:

10.4 *	10.7 *	10.5 *	10.0 ↗	10.7 *
10.2 *	10.2 *	10.7 *	10.4 *	9.7 →

beste Teiler 62.2 (45.) 63.0 (42.) 70.5 (48.)

Trefferlage 0.06 mm links, 0.11 mm hoch

Streuwert 1.26, horizontal: 1.54, vertikal: 0.90

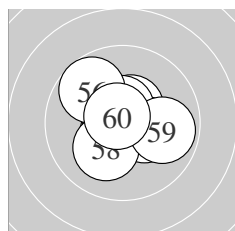

Serie 6:

10.7 *	10.5 *	10.3 *	10.8 *	10.6 *
9.7 ↘	10.8 *	10.2 *	9.9 →	10.7 *

beste Teiler 35.7 (57.) 46.0 (54.) 59.6 (60.)

Trefferlage 0.03 mm links, 0.15 mm hoch

Streuwert 1.21, horizontal: 1.33, vertikal: 1.07

ISSF AR Women – Wertung – Frauen

StandNr: 118

Hofstetter, Vanessa #70811334

StartNr: 61

22. Januar 2019 11:35

SUI

Unterschrift des Schützen

Meyton Elektronik

Ergebnis: **623.7** (594)
 Serien: 103.1 104.9 103.9 103.9 103.6 104.3
 Zähler: 54 6 0 0 0 0 0 0 0
 Innenzehner: 50
 weiteste: 480 (3), 370 (11), 355 (23)
 beste Teiler 26.4 (1.) 30.4 (16.) 35.0 (14.)
 Trefferlage 0.13 mm links, 0.05 mm tief
 Streuwert 1.18, horizontal: 1.44, vertikal: 0.84

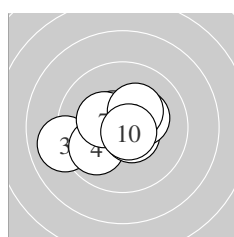
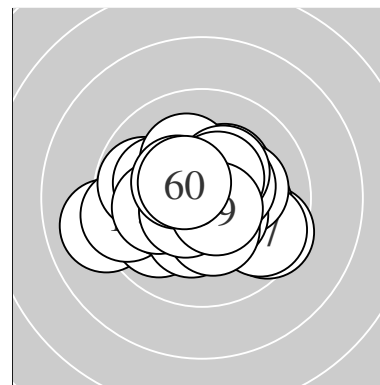

Serie 1:
 10.8 * 10.6 * 9.0 ← 9.9 ↙ 10.6 *
 10.6 * 10.3 * 10.3 * 10.3 * 10.7 *
 beste Teiler 26.4 (1.) 62.0 (10.) 86.0 (2.)
 Trefferlage 0.58 mm links, 0.05 mm tief
 Streuwert 1.45, horizontal: 1.82, vertikal: 0.94

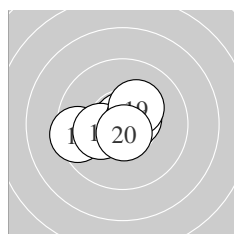

Serie 2:
 9.5 ← 10.5 * 10.7 * 10.8 * 10.8 *
 10.8 * 10.2 * 10.6 * 10.3 * 10.7 *
 beste Teiler 30.4 (16.) 35.0 (14.) 43.1 (15.)
 Trefferlage 0.37 mm links, 0.03 mm tief
 Streuwert 1.10, horizontal: 1.43, vertikal: 0.64

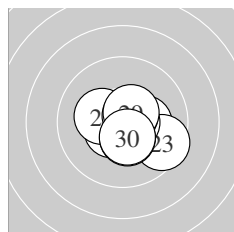

Serie 3:
 10.3 * 10.6 * 9.5 ↘ 10.5 * 10.3 *
 10.7 * 10.6 * 10.4 * 10.5 * 10.5 *
 beste Teiler 75.0 (26.) 78.7 (27.) 81.2 (22.)
 Trefferlage 0.46 mm rechts, 0.37 mm tief
 Streuwert 1.11, horizontal: 1.34, vertikal: 0.83

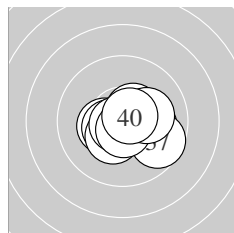

Serie 4:
 10.5 * 10.4 * 10.5 * 10.1 → 10.4 *
 10.7 * 9.7 ↘ 10.7 * 10.2 * 10.7 *
 beste Teiler 53.0 (36.) 69.4 (38.) 71.0 (40.)
 Trefferlage 0.46 mm rechts, 0.33 mm tief
 Streuwert 1.15, horizontal: 1.45, vertikal: 0.73

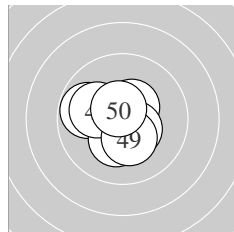

Serie 5:
 10.5 * 10.1 ← 10.5 * 10.7 * 10.7 *
 9.8 ← 10.3 * 10.1 ← 10.3 * 10.6 *
 beste Teiler 60.0 (45.) 73.6 (44.) 88.0 (50.)
 Trefferlage 0.66 mm links, 0.03 mm hoch
 Streuwert 1.14, horizontal: 1.28, vertikal: 0.98

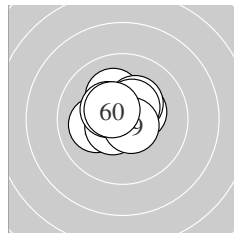

Serie 6:
 10.4 * 10.2 * 10.1 ← 10.5 * 10.3 *
 10.4 * 10.8 * 10.5 * 10.6 * 10.5 *
 beste Teiler 39.8 (57.) 85.6 (59.) 101.0 (54.)
 Trefferlage 0.15 mm links, 0.46 mm hoch
 Streuwert 0.98, horizontal: 1.12, vertikal: 0.81

Meyton Elektronik

ISSF AR Women – Wertung – Frauen

StandNr: 144

Martinez, Gabriela #70811328

StartNr: 86

22. Januar 2019 11:38

MEX

Unterschrift des Schützen

Meyton Elektronik

Ergebnis:	617.2	(587)					
Serien:	103.1	102.3	102.3	103.7	103.0	102.8	
Zähler:	48	11	1	0	0	0	0
Innenzehner:	40						
weiteste:	524 (27), 377 (3), 344 (33)						
beste Teiler	25.1 (48.) 39.6 (25.) 42.2 (35.)						
Trefferlage	0.18 mm links, 0.54 mm hoch						
Streuwert	1.33, horizontal: 1.44, vertikal: 1.21						

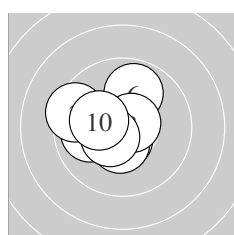
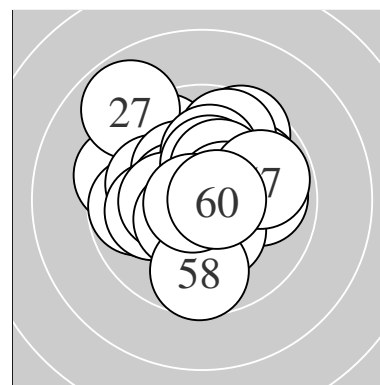

Serie 1:	10.0 ←	10.8 *	9.4 ↖	10.6 *	10.6 *
	9.9 ↑	10.4 *	10.7 *	10.5 *	10.2 *
beste Teiler	43.4 (2.) 72.4 (8.) 92.0 (4.)				
Trefferlage	0.83 mm links, 0.18 mm hoch				
Streuwert	1.28, horizontal: 1.42, vertikal: 1.12				

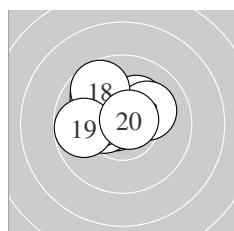

Serie 2:	10.2 *	10.7 *	10.1 ↗	10.6 *	10.4 *
	9.9 ↘	10.2 *	9.7 ↘	9.8 ←	10.7 *
beste Teiler	55.0 (12.) 59.6 (20.) 96.7 (14.)				
Trefferlage	0.76 mm links, 0.83 mm hoch				
Streuwert	1.25, horizontal: 1.49, vertikal: 0.95				

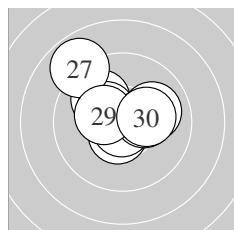

Serie 3:	10.0 ↘	10.8 *	10.3 *	10.6 *	10.8 *
	10.0 →	8.9 ↘	10.3 *	10.4 *	10.2 *
beste Teiler	39.6 (25.) 47.1 (22.) 100.0 (24.)				
Trefferlage	0.28 mm links, 0.75 mm hoch				
Streuwert	1.57, horizontal: 1.75, vertikal: 1.38				

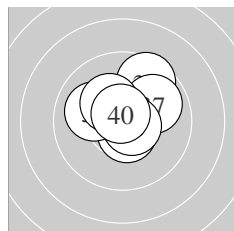

Serie 4:	10.6 *	10.5 *	9.6 ↑	10.7 *	10.8 *
	10.0 ↖	9.9 ↗	10.6 *	10.3 *	10.7 *
beste Teiler	42.2 (35.) 54.1 (34.) 57.9 (40.)				
Trefferlage	0.22 mm rechts, 0.74 mm hoch				
Streuwert	1.17, horizontal: 1.26, vertikal: 1.07				

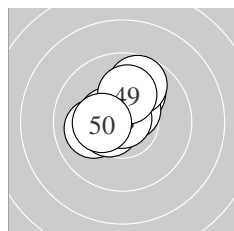

Serie 5:	10.4 *	10.0 ↑	10.1 ←	10.5 *	10.5 *
	9.7 ↑	10.5 *	10.9 *	10.1 ↑	10.3 *
beste Teiler	25.1 (48.) 107.7 (47.) 112.6 (45.)				
Trefferlage	0.21 mm links, 0.89 mm hoch				
Streuwert	1.17, horizontal: 1.17, vertikal: 1.16				

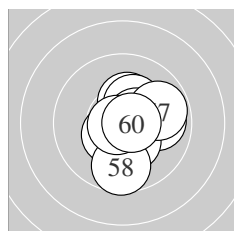

Serie 6:	10.3 *	9.9 →	10.5 *	10.3 *	10.3 *
	10.5 *	9.8 →	9.7 ↓	10.8 *	10.7 *
beste Teiler	45.5 (59.) 67.0 (60.) 111.7 (56.)				
Trefferlage	0.73 mm rechts, 0.11 mm tief				
Streuwert	1.31, horizontal: 1.16, vertikal: 1.44				

Meyton Elektronik

ISSF AR Women – Wertung – Frauen

StandNr: 145

Kowplos, Katarina #70811180

StartNr: 87

22. Januar 2019 11:26

AUS

Unterschrift des Schützen

Meyton Elektronik

Ergebnis:	622.3	(595)					
Serien:	104.3	104.0	104.5	104.6	103.4	101.5	
Zähler:	55	5	0	0	0	0	0
Innenzehner:	47						
weiteste:	305 (16), 301 (39), 282 (60)						
beste Teiler	40.0 (18.) 45.2 (24.) 47.3 (27.)						
Trefferlage	0.08 mm rechts, 0.36 mm hoch						
Streuwert	1.12, horizontal: 1.14, vertikal: 1.10						

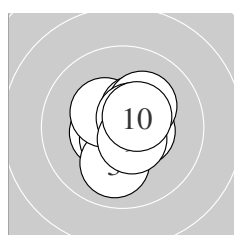
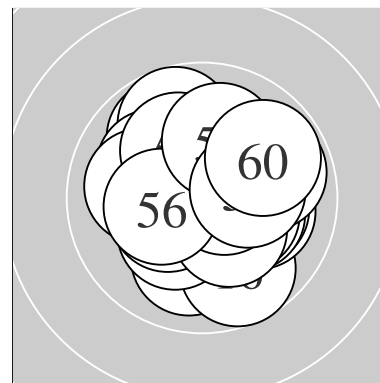

Serie 1:	10.5 *	10.6 *	10.0 ↓	10.5 *	10.4 *
	10.4 *	10.2 *	10.6 *	10.6 *	10.5 *
beste Teiler	81.4 (8.) 92.4 (2.) 98.2 (9.)				
Trefferlage	0.19 mm rechts, 0.03 mm hoch				
Streuwert	1.04, horizontal: 0.94, vertikal: 1.13				

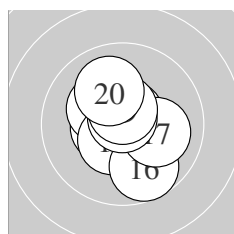

Serie 2:	10.5 *	10.3 *	10.8 *	10.7 *	10.5 *
	9.7 ↘	10.1 →	10.8 *	10.6 *	10.0 ↗
beste Teiler	40.0 (18.) 48.0 (13.) 69.2 (14.)				
Trefferlage	0.01 mm links, 0.10 mm hoch				
Streuwert	1.22, horizontal: 1.11, vertikal: 1.33				

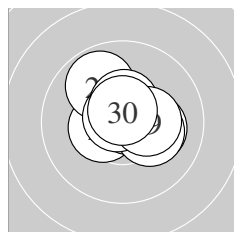

Serie 3:	10.2 *	10.7 *	10.4 *	10.8 *	10.2 *
	9.9 ↘	10.8 *	10.5 *	10.3 *	10.7 *
beste Teiler	45.2 (24.) 47.3 (27.) 62.3 (22.)				
Trefferlage	0.20 mm rechts, 0.34 mm hoch				
Streuwert	1.06, horizontal: 1.21, vertikal: 0.88				

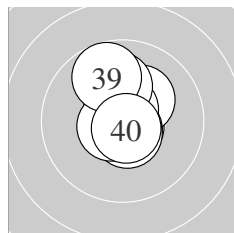

Serie 4:	10.7 *	10.2 *	10.7 *	10.7 *	10.7 *
	10.6 *	10.0 ↑	10.6 *	9.7 ↗	10.7 *
beste Teiler	52.3 (40.) 56.0 (31.) 63.2 (33.)				
Trefferlage	0.01 mm rechts, 0.52 mm hoch				
Streuwert	1.00, horizontal: 0.63, vertikal: 1.27				

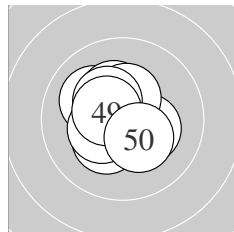

Serie 5:	10.5 *	10.3 *	10.1 ↘	10.3 *	10.3 *
	10.4 *	10.4 *	10.3 *	10.5 *	10.3 *
beste Teiler	114.7 (41.) 115.8 (49.) 137.1 (46.)				
Trefferlage	0.43 mm links, 0.31 mm hoch				
Streuwert	1.10, horizontal: 1.08, vertikal: 1.12				

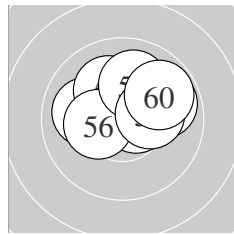

Serie 6:	10.4 *	10.0 ←	10.3 *	10.6 *	10.1 ↗
	10.3 *	10.0 ↑	9.8 →	10.2 *	9.8 →
beste Teiler	87.0 (54.) 126.2 (51.) 153.1 (53.)				
Trefferlage	0.55 mm rechts, 0.86 mm hoch				
Streuwert	1.31, horizontal: 1.66, vertikal: 0.82				

Meyton Elektronik

ISSF AR Women – Wertung – Frauen

StandNr: 146

Gambara, Barbaro #70811361

StartNr: 88

22. Januar 2019 11:46

ITA

Unterschrift des Schützen

Meyton Elektronik