

Ergebnis: **410.7** (393)
 Serien: 102.8 103.3 104.2 100.4
 Zähler: 34 5 1 0 0 0 0 0 0 0
 Innenzehner: 28
 weiteste: 508 (39), 427 (38), 362 (36)
 beste Teiler 12.0 (24.) 35.3 (34.) 54.9 (4.)
 Trefferlage 0.04 mm rechts, 0.48 mm hoch
 Streuwert 1.39, horizontal: 1.63, vertikal: 1.10

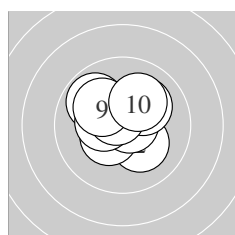

Serie 1:
 9.8 ↘ 10.2 * 10.4 * 10.7 * 10.4 *
 10.4 * 10.1 ↗ 10.6 * 10.1 ↘ 10.1 ↗
 beste Teiler 54.9 (4.) 84.8 (8.) 127.0 (5.)
 Trefferlage 0.27 mm links, 0.62 mm hoch
 Streuwert 1.22, horizontal: 1.34, vertikal: 1.09

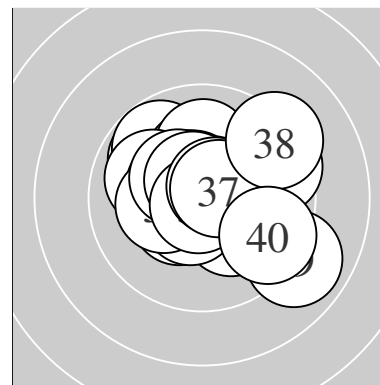
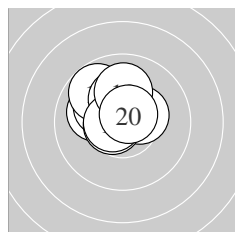

Serie 2:
 10.4 * 10.1 ↖ 10.2 * 9.8 ↘ 10.6 *
 10.2 * 10.7 * 10.6 * 10.0 ↑ 10.7 *
 beste Teiler 71.4 (17.) 75.8 (20.) 77.1 (18.)
 Trefferlage 0.57 mm links, 0.98 mm hoch
 Streuwert 0.99, horizontal: 1.08, vertikal: 0.89

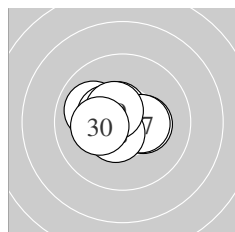

Serie 3:
 10.0 ↖ 10.6 * 10.4 * 10.9 * 10.3 *
 10.4 * 10.4 * 10.5 * 10.5 * 10.2 *
 beste Teiler 12.0 (24.) 95.7 (22.) 101.0 (28.)
 Trefferlage 0.54 mm links, 0.14 mm hoch
 Streuwert 0.99, horizontal: 1.26, vertikal: 0.62

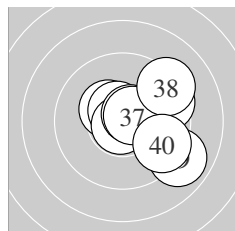

Serie 4:
 10.4 * 10.6 * 10.2 * 10.8 * 10.6 *
 9.5 ↗ 10.6 * 9.2 ↗ 8.9 ↘ 9.6 ↘
 beste Teiler 35.3 (34.) 81.3 (35.) 88.1 (37.)
 Trefferlage 1.54 mm rechts, 0.19 mm hoch
 Streuwert 1.72, horizontal: 1.87, vertikal: 1.55

Unterschrift des Schützen

Meyton Elektronik

Ergebnis: **405.0** (386)
 Serien: 97.2 101.6 103.4 102.8
 Zähler: 28 10 2 0 0 0 0 0 0 0
 Innenzehner: 22
 weiteste: 515 (1), 506 (2), 431 (9)
 beste Teiler 7.2 (22.) 37.6 (17.) 67.7 (25.)
 Trefferlage 0.53 mm links, 0.19 mm tief
 Streuwert 1.67, horizontal: 2.05, vertikal: 1.16

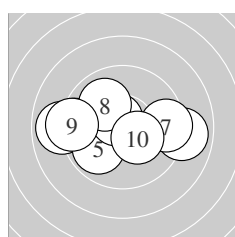
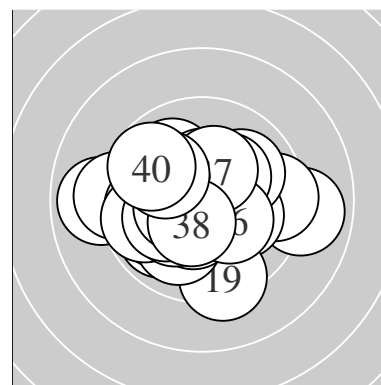

Serie 1:
 8.9 ← 8.9 → 10.6 * 9.3 ← 9.9 ↙
 10.6 * 9.5 → 10.0 ↘ 9.2 ← 10.3 *
 beste Teiler 76.8 (3.) 82.6 (6.) 154.2 (10.)
 Trefferlage 0.82 mm links, 0.06 mm tief
 Streuwert 2.48, horizontal: 3.38, vertikal: 0.97

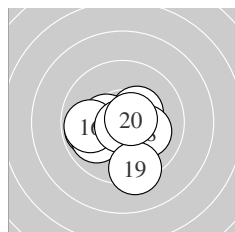

Serie 2:
 10.4 * 9.8 ← 10.4 * 9.9 ↙ 10.4 *
 9.8 ← 10.8 * 10.1 → 9.3 ↓ 10.7 *
 beste Teiler 37.6 (17.) 75.6 (20.) 134.4 (11.)
 Trefferlage 0.55 mm links, 0.65 mm tief
 Streuwert 1.52, horizontal: 1.73, vertikal: 1.28

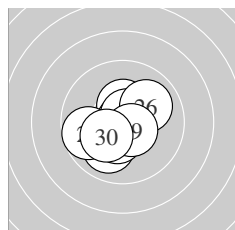

Serie 3:
 10.4 * 10.9 * 10.5 * 10.0 ↙ 10.7 *
 10.0 ↗ 10.4 * 9.7 ← 10.6 * 10.2 *
 beste Teiler 7.2 (22.) 67.7 (25.) 100.4 (29.)
 Trefferlage 0.34 mm links, 0.35 mm tief
 Streuwert 1.25, horizontal: 1.33, vertikal: 1.17

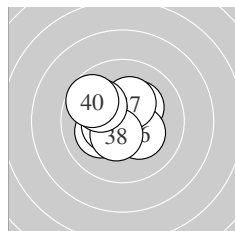

Serie 4:
 10.1 ← 10.3 * 10.4 * 10.5 * 10.7 *
 10.3 * 10.3 * 10.5 * 10.0 ↘ 9.7 ↘
 beste Teiler 74.8 (35.) 107.0 (34.) 125.7 (38.)
 Trefferlage 0.44 mm links, 0.27 mm hoch
 Streuwert 1.29, horizontal: 1.40, vertikal: 1.17

Unterschrift des Schützen

Meyton Elektronik

Ergebnis: **418.0** (400)^{QF}
 Serien: 104.7 104.5 104.2 104.6
 Zähler: 40 0 0 0 0 0 0 0 0 0
 Innenzehner: 38
 weiteste: 224 (18), 207 (37), 199 (7)
 beste Teiler 40.3 (10.) 41.1 (22.) 45.6 (38.)
 Trefferlage 0.20 mm rechts, 0.09 mm hoch
 Streuwert 0.95, horizontal: 1.05, vertikal: 0.84

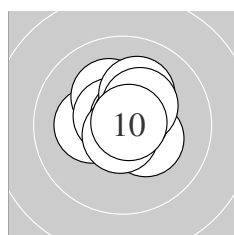
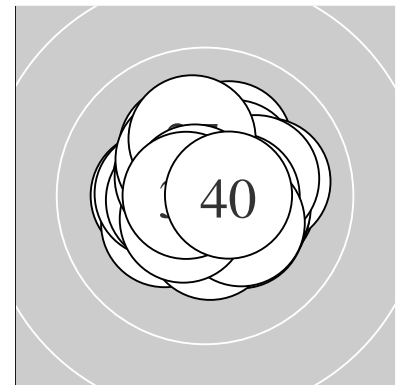

Serie 1:
 10.2 * 10.2 * 10.3 * 10.6 * 10.7 *
 10.7 * 10.2 * 10.3 * 10.7 * 10.8 *
 beste Teiler 40.3 (10.) 53.4 (5.) 60.6 (9.)
 Trefferlage 0.10 mm rechts, 0.47 mm hoch
 Streuwert 0.92, horizontal: 0.96, vertikal: 0.87

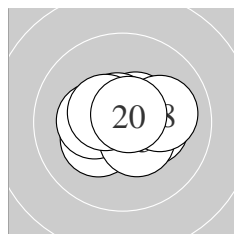

Serie 2:
 10.3 * 10.7 * 10.3 * 10.3 * 10.4 *
 10.5 * 10.7 * 10.1 → 10.5 * 10.7 *
 beste Teiler 57.6 (20.) 70.4 (12.) 73.3 (17.)
 Trefferlage 0.20 mm rechts, 0.08 mm hoch
 Streuwert 1.01, horizontal: 1.29, vertikal: 0.64

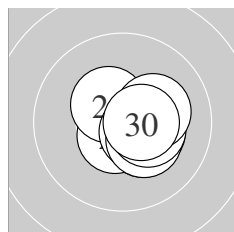

Serie 3:
 10.3 * 10.8 * 10.6 * 10.3 * 10.4 *
 10.5 * 10.3 * 10.3 * 10.2 * 10.5 *
 beste Teiler 41.1 (22.) 89.5 (23.) 103.7 (26.)
 Trefferlage 0.83 mm rechts, 0.27 mm tief
 Streuwert 0.78, horizontal: 0.86, vertikal: 0.68

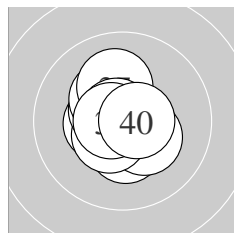

Serie 4:
 10.4 * 10.4 * 10.3 * 10.5 * 10.5 *
 10.3 * 10.1 ↑ 10.8 * 10.7 * 10.6 *
 beste Teiler 45.6 (38.) 67.0 (39.) 83.0 (40.)
 Trefferlage 0.31 mm links, 0.09 mm hoch
 Streuwert 0.94, horizontal: 0.82, vertikal: 1.04

QF – Schütze hat sich fürs Finale qualifiziert

Unterschrift des Schützen

Meyton Elektronik

Ergebnis: **414.9** (398)^{QF}
 Serien: 104.4 104.3 103.0 103.2
 Zähler: 38 2 0 0 0 0 0 0 0 0
 Innenzehner: 33
 weiteste: 456 (31), 359 (16), 246 (34)
 beste Teiler 8.4 (11.) 13.0 (18.) 56.8 (22.)
 Trefferlage 0.24 mm links, 0.17 mm hoch
 Streuwert 1.19, horizontal: 1.32, vertikal: 1.04

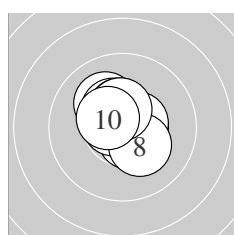
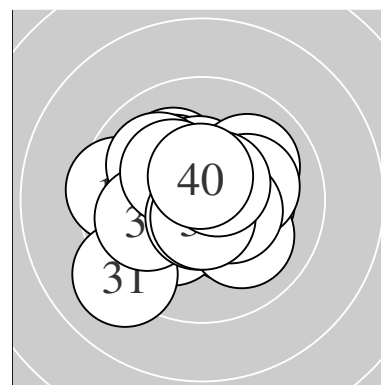

Serie 1:
 10.5 * 10.1 ↘ 10.4 * 10.5 * 10.6 *
 10.4 * 10.7 * 10.3 * 10.4 * 10.5 *
 beste Teiler 67.0 (7.) 89.3 (5.) 101.1 (1.)
 Trefferlage 0.02 mm links, 0.46 mm hoch
 Streuwert 0.93, horizontal: 0.90, vertikal: 0.95

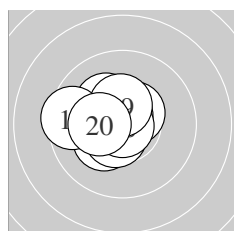

Serie 2:
 10.9 * 10.3 * 10.6 * 10.2 * 10.5 *
 9.5 ← 10.7 * 10.9 * 10.4 * 10.3 *
 beste Teiler 8.4 (11.) 13.0 (18.) 61.6 (17.)
 Trefferlage 0.76 mm links, 0.25 mm hoch
 Streuwert 1.05, horizontal: 1.23, vertikal: 0.83

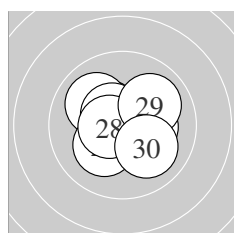

Serie 3:
 10.4 * 10.7 * 10.0 ↘ 10.3 * 10.5 *
 10.2 * 10.3 * 10.6 * 10.0 ↗ 10.0 ↘
 beste Teiler 56.8 (22.) 93.7 (28.) 106.0 (25.)
 Trefferlage 0.08 mm rechts, 0.16 mm hoch
 Streuwert 1.30, horizontal: 1.47, vertikal: 1.09

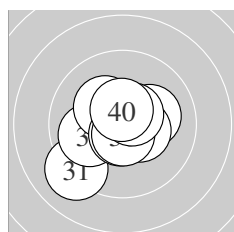

Serie 4:
 9.1 ↙ 10.2 * 10.7 * 10.0 ← 10.4 *
 10.3 * 10.7 * 10.7 * 10.6 * 10.5 *
 beste Teiler 72.1 (33.) 73.1 (38.) 74.9 (37.)
 Trefferlage 0.27 mm links, 0.18 mm tief
 Streuwert 1.45, horizontal: 1.60, vertikal: 1.29

QF – Schütze hat sich fürs Finale qualifiziert

Unterschrift des Schützen

Meyton Elektronik

Ergebnis: **413.0** (394)^{QF}
 Serien: 102.8 103.4 103.5 103.3
 Zähler: 34 6 0 0 0 0 0 0 0 0
 Innenzehner: 30
 weiteste: 341 (33), 339 (40), 328 (8)
 beste Teiler 4.1 (16.) 21.1 (39.) 47.6 (5.)
 Trefferlage 0.02 mm rechts, 0.20 mm tief
 Streuwert 1.28, horizontal: 1.40, vertikal: 1.14

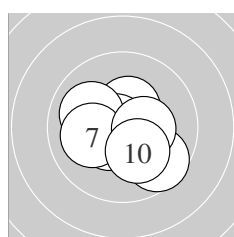
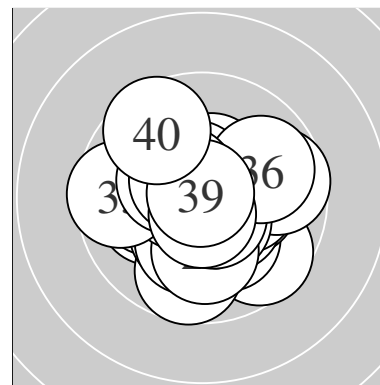

Serie 1:
 10.2 * 10.6 * 10.5 * 10.4 * 10.8 *
 10.0 ↖ 10.1 ← 9.6 ↘ 10.4 * 10.2 *
 beste Teiler 47.6 (5.) 93.9 (2.) 119.2 (3.)
 Trefferlage 0.19 mm rechts, 0.38 mm tief
 Streuwert 1.36, horizontal: 1.55, vertikal: 1.13

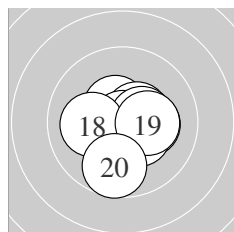

Serie 2:
 10.2 * 10.5 * 10.4 * 10.4 * 10.5 *
 10.9 * 10.4 * 10.1 ← 10.3 * 9.7 ↓
 beste Teiler 4.1 (16.) 113.1 (12.) 113.7 (15.)
 Trefferlage 0.27 mm rechts, 0.33 mm tief
 Streuwert 1.21, horizontal: 1.31, vertikal: 1.11

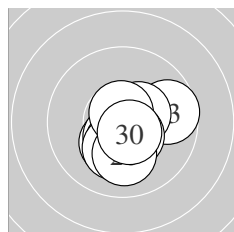

Serie 3:
 10.3 * 10.5 * 9.7 → 10.5 * 10.5 *
 10.4 * 10.2 * 10.1 ↓ 10.7 * 10.6 *
 beste Teiler 64.7 (29.) 85.7 (30.) 113.6 (22.)
 Trefferlage 0.31 mm rechts, 0.75 mm tief
 Streuwert 1.11, horizontal: 1.16, vertikal: 1.05

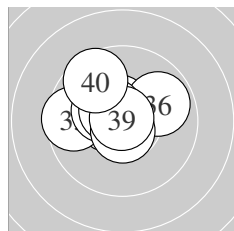

Serie 4:
 10.7 * 10.6 * 9.6 ← 10.3 * 10.5 *
 9.9 → 10.5 * 10.7 * 10.9 * 9.6 ↘
 beste Teiler 21.1 (39.) 68.0 (38.) 70.9 (31.)
 Trefferlage 0.69 mm links, 0.65 mm hoch
 Streuwert 1.25, horizontal: 1.50, vertikal: 0.93

QF – Schütze hat sich fürs Finale qualifiziert

Unterschrift des Schützen

Meyton Elektronik

Ergebnis: **414.1** (393)^{QF}
 Serien: 103.3 104.4 105.4 101.0
 Zähler: 33 7 0 0 0 0 0 0 0 0
 Innenzehner: 30
 weiteste: 419 (39), 356 (5), 285 (38)
 beste Teiler 19.1 (22.) 31.2 (20.) 33.0 (16.)
 Trefferlage 0.04 mm links, 0.11 mm hoch
 Streuwert 1.26, horizontal: 1.34, vertikal: 1.17

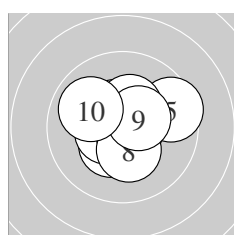
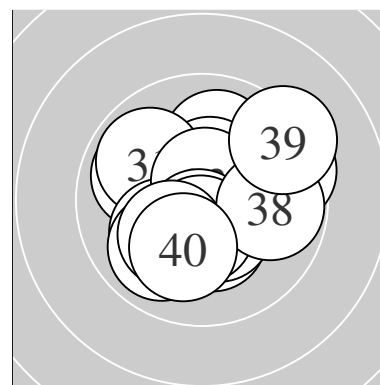

Serie 1:
 10.4 * 10.7 * 10.5 * 10.7 * 9.5 →
 10.5 * 10.4 * 10.3 * 10.4 * 9.9 ↖
 beste Teiler 63.2 (4.) 67.0 (2.) 113.6 (3.)
 Trefferlage 0.17 mm rechts, 0.19 mm hoch
 Streuwert 1.31, horizontal: 1.50, vertikal: 1.08

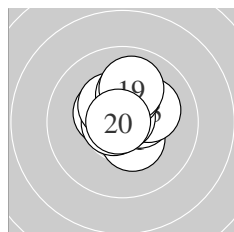

Serie 2:
 10.4 * 10.5 * 10.2 * 10.4 * 10.7 *
 10.8 * 10.4 * 10.2 * 10.0 ↑ 10.8 *
 beste Teiler 31.2 (20.) 33.0 (16.) 62.3 (15.)
 Trefferlage 0.16 mm rechts, 0.64 mm hoch
 Streuwert 0.97, horizontal: 0.94, vertikal: 1.00

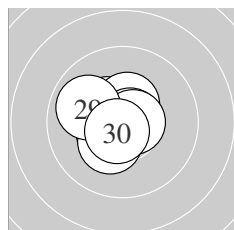

Serie 3:
 10.5 * 10.9 * 10.4 * 10.8 * 10.5 *
 10.7 * 10.7 * 10.3 * 9.9 ↖ 10.7 *
 beste Teiler 19.1 (22.) 46.8 (24.) 53.3 (26.)
 Trefferlage 0.38 mm links, 0.04 mm hoch
 Streuwert 0.90, horizontal: 0.96, vertikal: 0.83

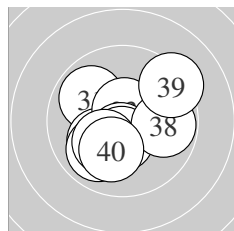

Serie 4:
 9.9 ↖ 10.1 ↙ 10.6 * 10.6 * 10.5 *
 9.9 ↙ 10.2 * 9.8 → 9.3 ↗ 10.1 ↙
 beste Teiler 76.9 (33.) 97.8 (34.) 123.1 (35.)
 Trefferlage 0.13 mm links, 0.43 mm tief
 Streuwert 1.72, horizontal: 1.88, vertikal: 1.55

QF – Schütze hat sich fürs Finale qualifiziert

Unterschrift des Schützen

Meyton Elektronik

Ergebnis: **413.8** (396)^{QF}
 Serien: 104.0 103.4 102.4 104.0
 Zähler: 36 4 0 0 0 0 0 0 0 0
 Innenzehner: 29
 weiteste: 324 (15), 292 (29), 286 (28)
 beste Teiler 15.8 (23.) 62.9 (24.) 63.2 (20.)
 Trefferlage 0.32 mm rechts, 0.13 mm hoch
 Streuwert 1.19, horizontal: 1.27, vertikal: 1.11

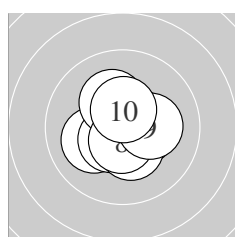
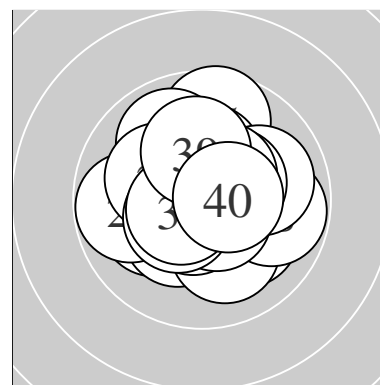

Serie 1:
 10.4 * 10.1 ← 10.5 * 10.4 * 10.6 *
 10.5 * 10.2 * 10.6 * 10.2 * 10.5 *
 beste Teiler 84.8 (5.) 89.2 (8.) 105.1 (6.)
 Trefferlage 0.09 mm rechts, 0.02 mm hoch
 Streuwert 1.07, horizontal: 1.09, vertikal: 1.04

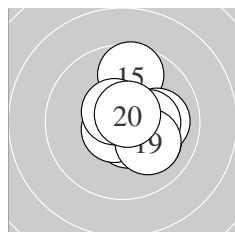

Serie 2:
 10.6 * 10.7 * 10.1 ↘ 10.6 * 9.7 ↑
 10.6 * 10.0 → 10.3 * 10.1 ↘ 10.7 *
 beste Teiler 63.2 (20.) 74.4 (12.) 89.8 (16.)
 Trefferlage 0.84 mm rechts, 0.10 mm hoch
 Streuwert 1.17, horizontal: 1.00, vertikal: 1.31

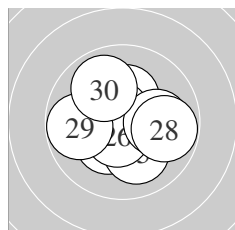

Serie 3:
 10.3 * 10.3 * 10.9 * 10.7 * 10.1 ↓
 10.6 * 10.0 → 9.8 → 9.8 ← 9.9 ↖
 beste Teiler 15.8 (23.) 62.9 (24.) 88.6 (26.)
 Trefferlage 0.05 mm rechts, 0.04 mm tief
 Streuwert 1.49, horizontal: 1.68, vertikal: 1.28

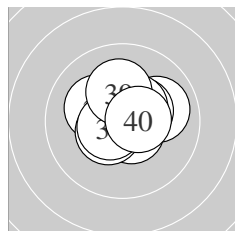

Serie 4:
 10.0 → 10.4 * 10.2 * 10.5 * 10.6 *
 10.5 * 10.5 * 10.6 * 10.2 * 10.5 *
 beste Teiler 88.4 (35.) 93.5 (38.) 101.1 (34.)
 Trefferlage 0.29 mm rechts, 0.43 mm hoch
 Streuwert 1.05, horizontal: 1.22, vertikal: 0.84

QF – Schütze hat sich fürs Finale qualifiziert

Unterschrift des Schützen

Meyton Elektronik

Ergebnis: **395.5** (378)
 Serien: 99.6 98.4 95.5 102.0
 Zähler: 20 18 2 0 0 0 0 0 0 0
 Innenzehner: 16
 weiteste: 669 (27), 557 (19), 496 (22)
 beste Teiler 64.8 (8.) 74.0 (34.) 79.2 (6.)
 Trefferlage 0.14 mm rechts, 0.40 mm hoch
 Streuwert 2.13, horizontal: 2.56, vertikal: 1.58

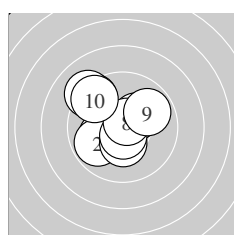
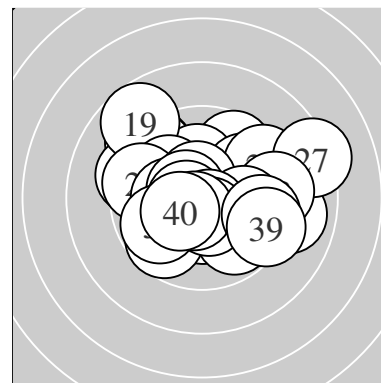

Serie 1:
 10.1 ↙ 9.8 ↙ 9.4 ↘ 10.3 * 10.3 *
 10.6 * 9.1 ↘ 10.7 * 9.9 ↗ 9.4 ↘
 beste Teiler 64.8 (8.) 79.2 (6.) 152.1 (4.)
 Trefferlage 0.88 mm links, 0.70 mm hoch
 Streuwert 1.88, horizontal: 1.95, vertikal: 1.80

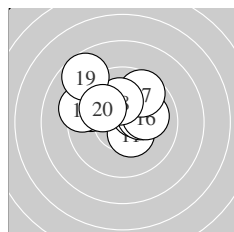

Serie 2:
 10.4 * 10.4 * 9.6 ↘ 9.3 ↘ 10.2 *
 10.0 → 9.6 ↗ 10.2 * 8.7 ↘ 10.0 ↘
 beste Teiler 133.0 (11.) 143.3 (12.) 181.1 (15.)
 Trefferlage 0.49 mm links, 1.38 mm hoch
 Streuwert 1.96, horizontal: 2.38, vertikal: 1.43

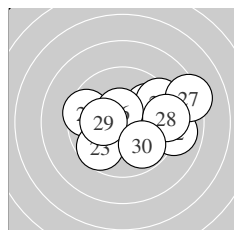

Serie 3:
 9.5 ↖ 9.0 → 9.7 ↙ 9.8 ↗ 9.4 ↗
 10.5 * 8.3 → 9.3 → 10.2 * 9.8 ↘
 beste Teiler 103.1 (26.) 182.0 (29.) 278.1 (24.)
 Trefferlage 1.53 mm rechts, 0.25 mm hoch
 Streuwert 2.60, horizontal: 3.30, vertikal: 1.60

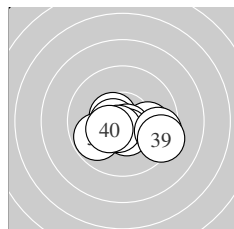

Serie 4:
 10.5 * 10.0 → 10.6 * 10.7 * 10.5 *
 10.6 * 9.8 ↙ 9.6 → 9.3 ↘ 10.4 *
 beste Teiler 74.0 (34.) 86.6 (36.) 90.7 (33.)
 Trefferlage 0.42 mm rechts, 0.73 mm tief
 Streuwert 1.52, horizontal: 2.06, vertikal: 0.62

Unterschrift des Schützen

Meyton Elektronik

Ergebnis:	412.3	(394) ^{QF}
Serien:	102.5	104.4 101.5 103.9
Zähler:	34	6 0 0 0 0 0 0 0 0
Innenzehner:	27	
weiteste:	350 (29),	323 (4), 302 (16)
beste Teiler	1.4 (14.)	20.0 (11.) 34.0 (34.)
Trefferlage	0.33 mm rechts, 0.17 mm hoch	
Streuwert	1.28, horizontal: 1.50, vertikal: 1.01	

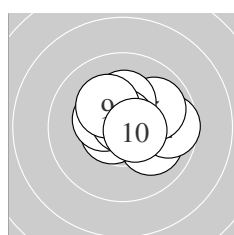
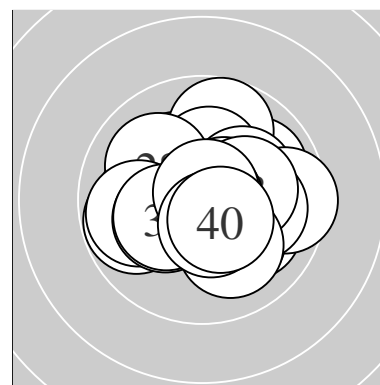

Serie 1:	10.0 ↘	10.6 *	10.1 ↗	9.7 →	9.9 ↗
	10.2 *	10.4 *	10.8 *	10.2 *	10.6 *
beste Teiler	45.0 (8.) 80.5 (2.) 90.7 (10.)				
Trefferlage	0.70 mm rechts, 0.49 mm hoch				
Streuwert	1.27, horizontal: 1.54, vertikal: 0.92				

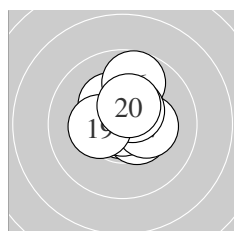

Serie 2:	10.9 *	10.5 *	10.3 *	10.9 *	10.6 *
	9.7 ↑	10.3 *	10.5 *	10.3 *	10.4 *
beste Teiler	1.4 (14.) 20.0 (11.) 83.7 (15.)				
Trefferlage	0.28 mm rechts, 0.58 mm hoch				
Streuwert	1.01, horizontal: 0.96, vertikal: 1.07				

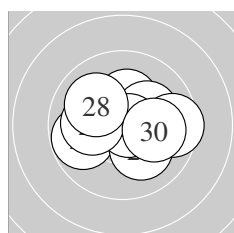

Serie 3:	10.3 *	10.2 *	9.8 ←	10.5 *	10.1 ↘
	10.8 *	10.1 ←	10.0 ↘	9.6 →	10.1 →
beste Teiler	43.1 (26.) 110.9 (24.) 172.4 (21.)				
Trefferlage	0.36 mm rechts, 0.07 mm hoch				
Streuwert	1.61, horizontal: 2.04, vertikal: 1.03				

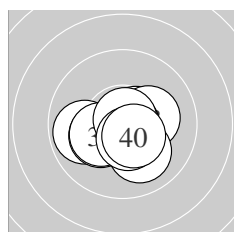

Serie 4:	10.5 *	9.9 ←	10.2 *	10.8 *	10.3 *
	10.3 *	10.1 ↘	10.8 *	10.5 *	10.5 *
beste Teiler	34.0 (34.) 36.2 (38.) 101.6 (31.)				
Trefferlage	0.01 mm links, 0.47 mm tief				
Streuwert	1.14, horizontal: 1.43, vertikal: 0.76				

QF – Schütze hat sich fürs Finale qualifiziert

Unterschrift des Schützen

Meyton Elektronik

Ergebnis: **394.0** (374)
 Serien: 97.5 99.4 99.8 97.3
 Zähler: 19 16 5 0 0 0 0 0 0 0
 Innenzehner: 15
 weiteste: 699 (39), 639 (25), 605 (26)
 beste Teiler 26.2 (9.) 37.1 (20.) 45.3 (31.)
 Trefferlage 0.65 mm rechts, 0.25 mm hoch
 Streuwert 2.26, horizontal: 2.70, vertikal: 1.72

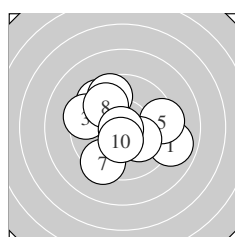
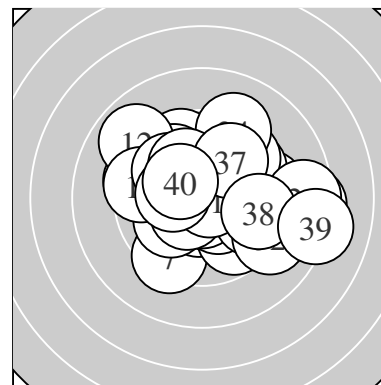

Serie 1:
 8.9 ↘ 9.6 ↘ 9.4 ↖ 9.6 ↗ 9.4 →
 10.1 ↘ 9.4 ↙ 9.9 ↘ 10.8 * 10.4 *
 beste Teiler 26.2 (9.) 128.4 (10.) 202.6 (6.)
 Trefferlage 0.09 mm links, 0.16 mm hoch
 Streuwert 2.44, horizontal: 2.75, vertikal: 2.09

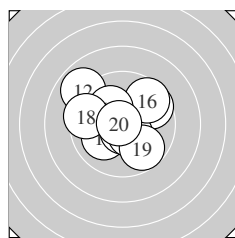

Serie 2:
 9.6 ↗ 8.9 ↘ 10.0 ↙ 10.7 * 10.4 *
 9.6 ↗ 10.2 * 9.5 ↖ 9.7 ↘ 10.8 *
 beste Teiler 37.1 (20.) 73.0 (14.) 130.8 (15.)
 Trefferlage 0.30 mm links, 0.44 mm hoch
 Streuwert 2.11, horizontal: 2.37, vertikal: 1.82

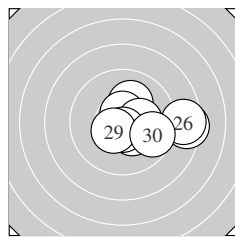

Serie 3:
 10.1 ↗ 10.4 * 10.7 * 10.6 * 8.4 →
 8.5 → 10.3 * 10.6 * 10.5 * 9.7 ↘
 beste Teiler 65.9 (23.) 76.0 (28.) 83.0 (24.)
 Trefferlage 1.77 mm rechts, 0.20 mm tief
 Streuwert 1.95, horizontal: 2.58, vertikal: 0.96

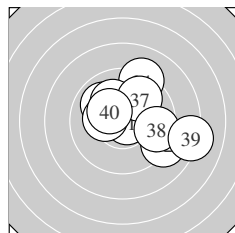

Serie 4:
 10.8 * 9.1 ↘ 9.9 ↘ 9.2 ↗ 10.3 *
 10.1 ↘ 9.8 ↗ 9.6 → 8.2 → 10.3 *
 beste Teiler 45.3 (31.) 162.8 (40.) 175.5 (35.)
 Trefferlage 1.22 mm rechts, 0.60 mm hoch
 Streuwert 2.46, horizontal: 2.88, vertikal: 1.94

Unterschrift des Schützen

Ergebnis: **402.1** (384)
 Serien: 100.0 100.4 98.8 102.9
 Zähler: 24 16 0 0 0 0 0 0 0 0
 Innenzehner: 18
 weiteste: 382 (24), 361 (6), 361 (13)
 beste Teiler 92.5 (34.) 95.9 (30.) 112.6 (32.)
 Trefferlage 0.11 mm links, 0.31 mm tief
 Streuwert 1.70, horizontal: 1.73, vertikal: 1.68

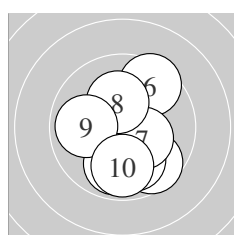
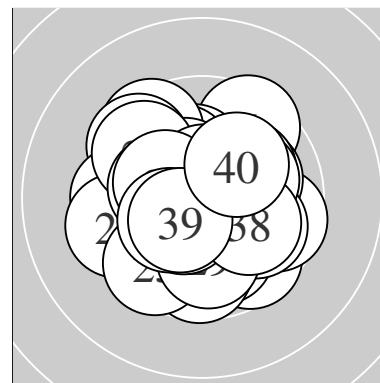

Serie 1:
 10.3 * 9.6 ↘ 10.0 ↓ 9.9 ↓ 10.5 *
 9.5 ↗ 10.3 * 10.2 * 9.9 ← 9.8 ↓
 beste Teiler 120.6 (5.) 160.7 (7.) 175.1 (1.)
 Trefferlage 0.48 mm rechts, 0.81 mm tief
 Streuwert 1.71, horizontal: 1.41, vertikal: 1.97

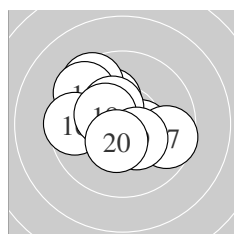

Serie 2:
 10.4 * 10.2 * 9.5 ↘ 9.5 ↘ 10.4 *
 9.6 ← 9.6 → 10.4 * 10.4 * 10.4 *
 beste Teiler 129.6 (20.) 134.2 (11.) 140.4 (15.)
 Trefferlage 0.62 mm links, 0.51 mm hoch
 Streuwert 1.75, horizontal: 1.99, vertikal: 1.47

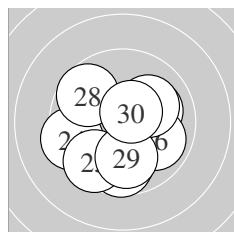

Serie 3:
 10.1 → 9.8 ↓ 9.7 ↓ 9.4 ← 9.6 ↗
 9.9 ↘ 10.1 ↗ 9.7 ↘ 9.9 ↓ 10.6 *
 beste Teiler 95.9 (30.) 215.6 (27.) 224.1 (21.)
 Trefferlage 0.11 mm links, 0.91 mm tief
 Streuwert 1.97, horizontal: 2.03, vertikal: 1.92

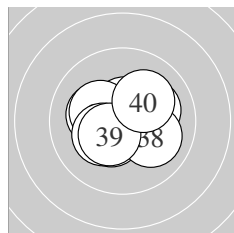

Serie 4:
 10.4 * 10.5 * 10.2 * 10.6 * 10.1 →
 10.3 * 10.3 * 10.0 ↘ 10.4 * 10.1 ↗
 beste Teiler 92.5 (34.) 112.6 (32.) 131.2 (31.)
 Trefferlage 0.19 mm links, 0.03 mm tief
 Streuwert 1.26, horizontal: 1.49, vertikal: 0.98

Unterschrift des Schützen

Meyton Elektronik

Ergebnis: **384.5** (364)
 Serien: 100.1 95.0 96.7 92.7
 Zähler: 12 21 6 1 0 0 0 0 0 0
 Innenzehner: 11
 weiteste: 960 (38), 660 (8), 611 (12)
 beste Teiler 35.0 (3.) 36.1 (1.) 41.4 (9.)
 Trefferlage 0.67 mm links, 0.23 mm tief
 Streuwert 2.72, horizontal: 3.02, vertikal: 2.37

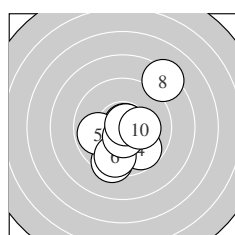
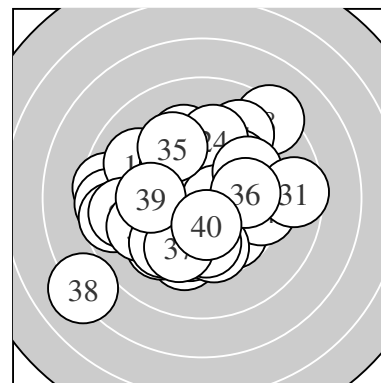

Serie 1:
 10.8 * 9.4 ↓ 10.8 * 9.7 ↘ 9.9 ←
 9.7 ↓ 10.5 * 8.3 ↗ 10.8 * 10.2 *
 beste Teiler 35.0 (3.) 36.1 (1.) 41.4 (9.)
 Trefferlage 0.44 mm rechts, 0.56 mm tief
 Streuwert 2.17, horizontal: 1.91, vertikal: 2.40

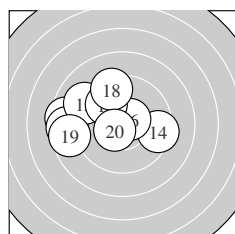

Serie 2:
 10.4 * 8.5 ← 8.6 ← 9.4 → 9.1 ↖
 10.6 * 9.9 ↘ 9.4 ↑ 8.6 ← 10.5 *
 beste Teiler 92.3 (16.) 107.0 (20.) 127.0 (11.)
 Trefferlage 2.17 mm links, 0.72 mm hoch
 Streuwert 2.56, horizontal: 3.25, vertikal: 1.59

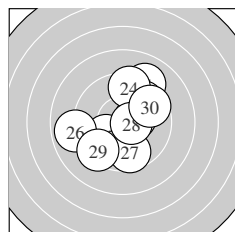

Serie 3:
 9.1 ↗ 9.7 ↗ 10.4 * 9.4 ↑ 10.0 ↘
 8.9 ← 9.6 ↓ 10.6 * 9.4 ↙ 9.6 ↗
 beste Teiler 94.0 (28.) 140.8 (23.) 228.3 (25.)
 Trefferlage 0.17 mm rechts, 0.33 mm hoch
 Streuwert 2.55, horizontal: 2.54, vertikal: 2.56

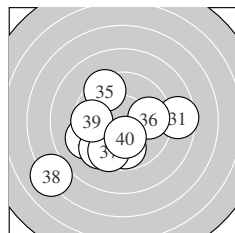

Serie 4:
 8.6 → 9.8 ↓ 9.2 ← 9.4 ↙ 9.4 ↖
 9.8 → 9.6 ↓ 7.1 ← 9.6 ← 10.2 *
 beste Teiler 176.2 (40.) 280.8 (36.) 288.2 (32.)
 Trefferlage 1.14 mm links, 1.43 mm tief
 Streuwert 3.19, horizontal: 3.74, vertikal: 2.52

Unterschrift des Schützen

Meyton Elektronik

Ergebnis: **408.0** (390)
 Serien: 103.2 100.1 100.7 104.0
 Zähler: 31 8 1 0 0 0 0 0 0 0
 Innenzehner: 27
 weiteste: 540 (22), 464 (20), 398 (15)
 beste Teiler 47.4 (34.) 55.0 (3.) 61.8 (36.)
 Trefferlage 0.50 mm rechts, 0.11 mm tief
 Streuwert 1.51, horizontal: 1.75, vertikal: 1.23

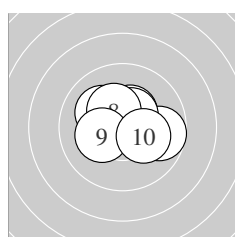
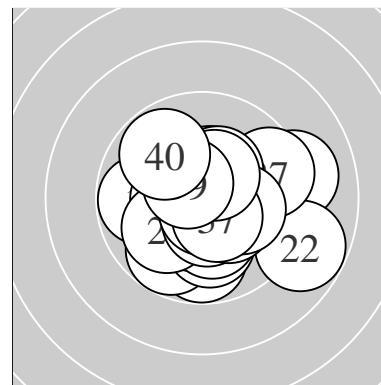

Serie 1:
 10.5 * 10.1 ↖ 10.7 * 10.4 * 10.6 *
 9.7 → 10.5 * 10.3 * 10.2 * 10.2 *
 beste Teiler 55.0 (3.) 78.3 (5.) 120.1 (1.)
 Trefferlage 0.25 mm rechts, 0.53 mm hoch
 Streuwert 1.18, horizontal: 1.44, vertikal: 0.84

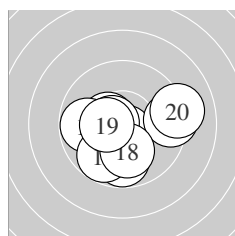

Serie 2:
 9.8 ↓ 10.4 * 10.7 * 9.8 ← 9.4 →
 9.8 ↙ 10.6 * 10.1 ↓ 10.4 * 9.1 →
 beste Teiler 70.8 (13.) 87.6 (17.) 128.0 (12.)
 Trefferlage 0.12 mm rechts, 0.65 mm tief
 Streuwert 1.95, horizontal: 2.38, vertikal: 1.40

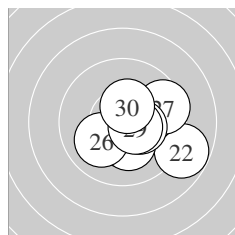

Serie 3:
 10.4 * 8.8 ↘ 10.4 * 10.2 * 10.1 →
 10.0 ↙ 9.5 → 10.4 * 10.5 * 10.4 *
 beste Teiler 112.3 (29.) 128.0 (23.) 136.4 (30.)
 Trefferlage 1.28 mm rechts, 0.46 mm tief
 Streuwert 1.59, horizontal: 1.86, vertikal: 1.27

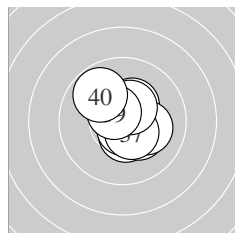

Serie 4:
 10.5 * 10.3 * 10.3 * 10.8 * 10.2 *
 10.7 * 10.5 * 10.4 * 10.5 * 9.8 ↖
 beste Teiler 47.4 (34.) 61.8 (36.) 101.1 (39.)
 Trefferlage 0.34 mm rechts, 0.14 mm hoch
 Streuwert 1.10, horizontal: 1.04, vertikal: 1.15

Unterschrift des Schützen

Meyton Elektronik

Ergebnis: **411.8** (393)^{QF}
 Serien: 105.0 101.8 100.9 104.1
 Zähler: 34 5 1 0 0 0 0 0 0 0
 Innenzehner: 31
 weiteste: 544 (29), 418 (24), 317 (25)
 beste Teiler 70.0 (10.) 73.9 (40.) 75.8 (33.)
 Trefferlage 0.25 mm rechts, 0.17 mm tief
 Streuwert 1.34, horizontal: 1.64, vertikal: 0.94

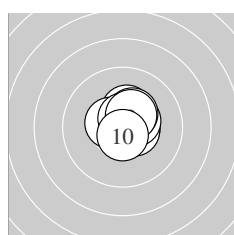
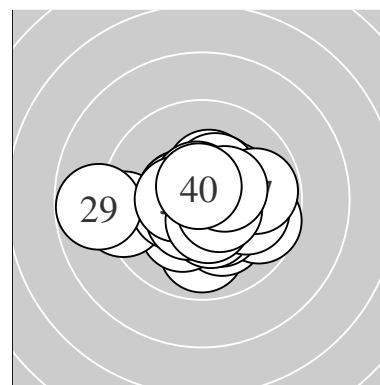

Serie 1:
 10.5 * 10.4 * 10.5 * 10.5 * 10.5 *
 10.5 * 10.4 * 10.6 * 10.4 * 10.7 *
 beste Teiler 70.0 (10.) 77.4 (8.) 101.2 (4.)
 Trefferlage 0.46 mm rechts, 0.51 mm hoch
 Streuwert 0.68, horizontal: 0.66, vertikal: 0.69

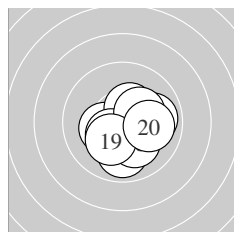

Serie 2:
 10.3 * 10.3 * 9.9 ↓ 9.9 → 10.4 *
 10.1 ↘ 10.4 * 10.3 * 10.2 * 10.0 →
 beste Teiler 135.0 (15.) 147.8 (17.) 155.4 (11.)
 Trefferlage 0.58 mm rechts, 0.60 mm tief
 Streuwert 1.32, horizontal: 1.45, vertikal: 1.18

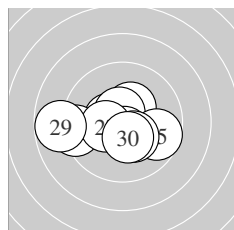

Serie 3:
 10.5 * 10.4 * 10.6 * 9.3 ← 9.7 →
 10.6 * 10.3 * 10.3 * 8.8 ← 10.4 *
 beste Teiler 86.6 (23.) 88.2 (26.) 118.6 (21.)
 Trefferlage 0.72 mm links, 0.36 mm tief
 Streuwert 1.86, horizontal: 2.48, vertikal: 0.89

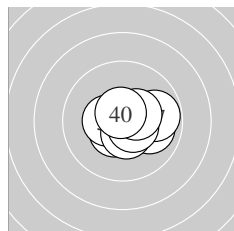

Serie 4:
 10.5 * 10.4 * 10.7 * 10.6 * 10.0 →
 10.5 * 9.8 → 10.5 * 10.4 * 10.7 *
 beste Teiler 73.9 (40.) 75.8 (33.) 99.7 (34.)
 Trefferlage 0.68 mm rechts, 0.22 mm tief
 Streuwert 1.00, horizontal: 1.26, vertikal: 0.63

QF – Schütze hat sich fürs Finale qualifiziert

Unterschrift des Schützen

Meyton Elektronik

Ergebnis:	401.5	(385)
Serien:	101.2	103.1 98.1 99.1
Zähler:	25	15 0 0 0 0 0 0 0 0
Innenzehner:	17	
weiteste:	486 (25),	484 (22), 479 (33)
beste Teiler	52.4 (16.)	55.0 (26.) 63.0 (37.)
Trefferlage	0.28 mm rechts, 0.32 mm hoch	
Streuwert	1.84, horizontal: 2.12, vertikal: 1.50	

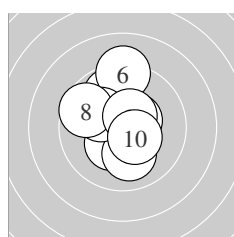
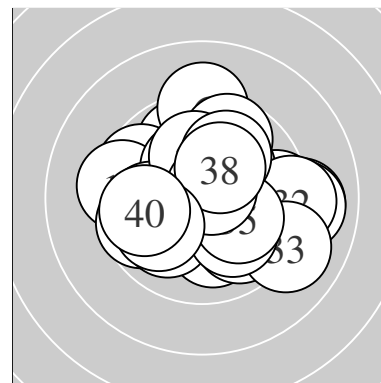

Serie 1:	9.8 ↗	10.5 *	10.7 *	10.3 *	10.1 ↓
	9.2 ↑	10.1 ↖	9.6 ↖	10.5 *	10.4 *
beste Teiler	71.1 (3.) 109.0 (9.) 116.7 (2.)				
Trefferlage	0.28 mm links, 0.63 mm hoch				
Streuwert	1.68, horizontal: 1.35, vertikal: 1.95				

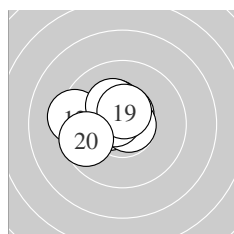

Serie 2:	10.6 *	10.5 *	9.4 ←	10.5 *	10.3 *
	10.7 *	10.6 *	10.3 *	10.5 *	9.7 ←
beste Teiler	52.4 (16.) 77.8 (17.) 86.9 (11.)				
Trefferlage	0.91 mm links, 0.56 mm hoch				
Streuwert	1.19, horizontal: 1.46, vertikal: 0.82				

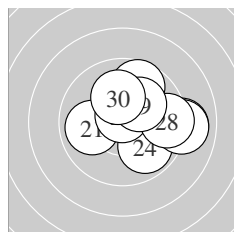

Serie 3:	9.9 ←	9.0 →	10.1 ↗	9.9 ↘	9.0 →
	10.7 *	9.7 ↗	9.5 →	10.2 *	10.1 ↑
beste Teiler	55.0 (26.) 200.8 (29.) 203.4 (23.)				
Trefferlage	1.58 mm rechts, 0.58 mm hoch				
Streuwert	1.96, horizontal: 2.34, vertikal: 1.47				

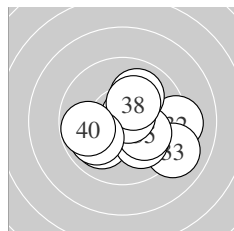

Serie 4:	10.0 ↙	9.2 →	9.0 ↘	10.1 ↘	10.1 ↘
	10.0 ↗	10.7 *	10.3 *	9.9 ↙	9.8 ←
beste Teiler	63.0 (37.) 173.5 (38.) 205.4 (35.)				
Trefferlage	0.77 mm rechts, 0.49 mm tief				
Streuwert	2.01, horizontal: 2.45, vertikal: 1.45				

Unterschrift des Schützen

Meyton Elektronik

Ergebnis: **408.1** (392)
 Serien: 100.9 101.9 102.1 103.2
 Zähler: 32 8 0 0 0 0 0 0 0 0
 Innenzehner: 24
 weiteste: 401 (1), 379 (5), 339 (40)
 beste Teiler 46.0 (17.) 46.0 (27.) 75.7 (3.)
 Trefferlage 0.09 mm rechts, 0.35 mm hoch
 Streuwert 1.45, horizontal: 1.70, vertikal: 1.13

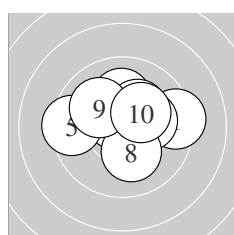
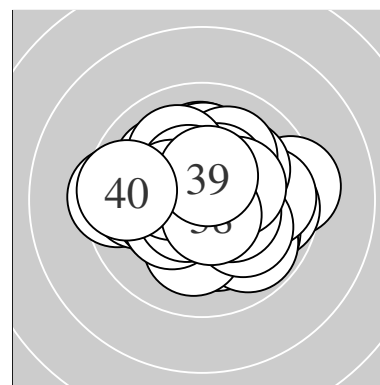

Serie 1:
 9.3 → 10.4 * 10.7 * 10.1 ↑ 9.4 ←
 10.3 * 10.2 * 10.2 * 10.0 ↘ 10.3 *
 beste Teiler 75.7 (3.) 140.8 (2.) 172.5 (6.)
 Trefferlage 0.23 mm rechts, 0.73 mm hoch
 Streuwert 1.67, horizontal: 2.11, vertikal: 1.08

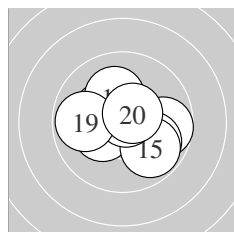

Serie 2:
 10.3 * 10.3 * 9.7 → 9.9 ↘ 9.8 ↘
 10.5 * 10.8 * 10.2 * 9.8 ← 10.6 *
 beste Teiler 46.0 (17.) 99.1 (20.) 109.3 (16.)
 Trefferlage 0.14 mm rechts, 0.02 mm hoch
 Streuwert 1.55, horizontal: 1.86, vertikal: 1.16

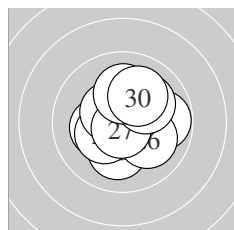

Serie 3:
 10.2 * 9.8 → 10.1 ↓ 10.3 * 10.5 *
 10.1 ↘ 10.8 * 10.1 ↗ 10.1 ↑ 10.1 ↗
 beste Teiler 46.0 (27.) 122.2 (25.) 159.2 (24.)
 Trefferlage 0.31 mm rechts, 0.13 mm hoch
 Streuwert 1.45, horizontal: 1.51, vertikal: 1.39

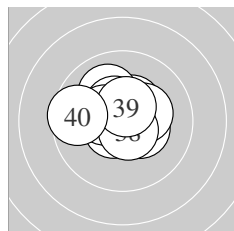

Serie 4:
 10.4 * 10.4 * 10.0 ↘ 10.3 * 10.6 *
 10.4 * 10.4 * 10.6 * 10.5 * 9.6 ←
 beste Teiler 79.0 (38.) 86.2 (35.) 110.1 (39.)
 Trefferlage 0.29 mm links, 0.51 mm hoch
 Streuwert 1.20, horizontal: 1.45, vertikal: 0.88

Unterschrift des Schützen

Meyton Elektronik

Ergebnis: **410.2** (393)
 Serien: 102.9 102.1 101.8 103.4
 Zähler: 33 7 0 0 0 0 0 0 0 0
 Innenzehner: 26
 weiteste: 472 (16), 351 (19), 334 (22)
 beste Teiler 42.4 (33.) 53.4 (1.) 54.4 (36.)
 Trefferlage 0.61 mm rechts, 0.11 mm hoch
 Streuwert 1.35, horizontal: 1.37, vertikal: 1.33

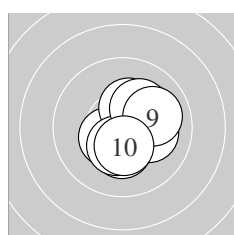
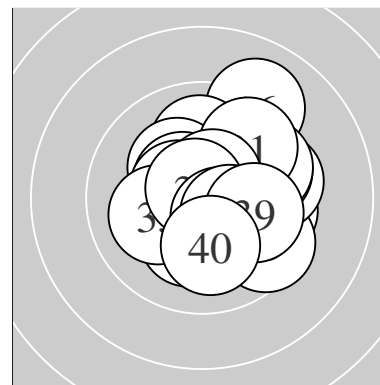

Serie 1:
 10.7 * 10.4 * 10.3 * 10.3 * 10.4 *
 10.1 → 10.1 ↗ 10.2 * 10.0 → 10.4 *
 beste Teiler 53.4 (1.) 132.0 (2.) 140.3 (10.)
 Trefferlage 0.65 mm rechts, 0.13 mm tief
 Streuwert 1.17, horizontal: 1.12, vertikal: 1.21

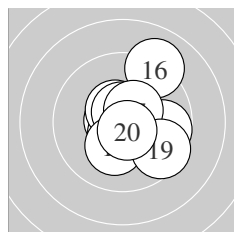

Serie 2:
 10.7 * 10.6 * 9.7 → 10.5 * 10.6 *
 9.1 ↗ 10.5 * 10.2 * 9.5 ↘ 10.7 *
 beste Teiler 69.2 (11.) 70.7 (20.) 78.7 (15.)
 Trefferlage 0.70 mm rechts, 0.10 mm hoch
 Streuwert 1.62, horizontal: 1.49, vertikal: 1.74

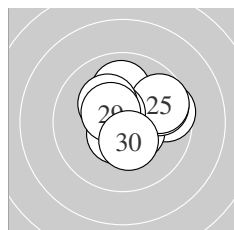

Serie 3:
 10.0 ↑ 9.6 → 10.5 * 9.8 → 9.7 →
 10.6 * 10.5 * 10.2 * 10.5 * 10.4 *
 beste Teiler 84.6 (26.) 101.5 (27.) 115.7 (29.)
 Trefferlage 0.70 mm rechts, 0.56 mm hoch
 Streuwert 1.44, horizontal: 1.65, vertikal: 1.19

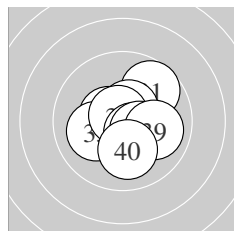

Serie 4:
 9.7 ↗ 10.5 * 10.8 * 10.6 * 10.1 ←
 10.7 * 10.5 * 10.4 * 10.0 → 10.1 ↓
 beste Teiler 42.4 (33.) 54.4 (36.) 98.0 (34.)
 Trefferlage 0.39 mm rechts, 0.08 mm tief
 Streuwert 1.28, horizontal: 1.34, vertikal: 1.22

Unterschrift des Schützen

Meyton Elektronik

Ergebnis: **414.6** (396)^{QF}
 Serien: 101.6 103.0 104.5 105.5
 Zähler: 36 4 0 0 0 0 0 0 0 0
 Innenzehner: 30
 weiteste: 291 (8), 281 (4), 265 (11)
 beste Teiler 14.1 (33.) 35.2 (38.) 43.1 (32.)
 Trefferlage 0.22 mm rechts, 0.39 mm hoch
 Streuwert 1.15, horizontal: 1.08, vertikal: 1.21

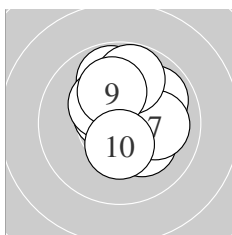
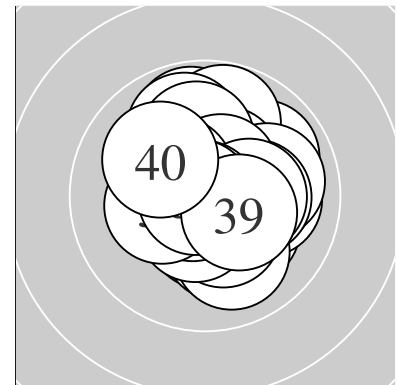

Serie 1:
 10.5 * 10.6 * 9.9 ↗ 9.8 ↑ 10.2 *
 10.3 * 10.0 → 9.8 ↑ 10.1 ↑ 10.4 *
 beste Teiler 95.0 (2.) 116.8 (1.) 137.0 (10.)
 Trefferlage 0.46 mm rechts, 0.88 mm hoch
 Streuwert 1.36, horizontal: 1.23, vertikal: 1.48

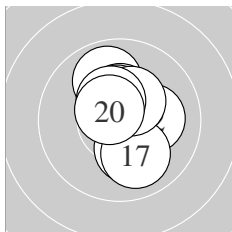

Serie 2:
 9.9 ↑ 10.2 * 10.2 * 10.4 * 10.4 *
 10.5 * 10.0 ↓ 10.4 * 10.4 * 10.6 *
 beste Teiler 94.0 (20.) 115.5 (16.) 131.7 (15.)
 Trefferlage 0.17 mm rechts, 0.55 mm hoch
 Streuwert 1.22, horizontal: 0.90, vertikal: 1.48

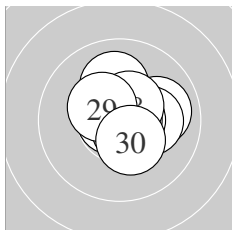

Serie 3:
 10.0 → 10.2 * 10.7 * 10.7 * 10.1 ↑
 10.7 * 10.8 * 10.5 * 10.4 * 10.4 *
 beste Teiler 50.0 (27.) 52.0 (23.) 67.0 (24.)
 Trefferlage 0.52 mm rechts, 0.27 mm hoch
 Streuwert 1.00, horizontal: 1.06, vertikal: 0.94

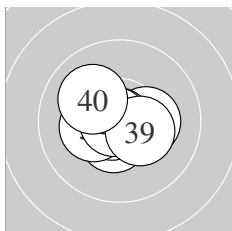

Serie 4:
 10.3 * 10.8 * 10.9 * 10.5 * 10.7 *
 10.7 * 10.3 * 10.8 * 10.4 * 10.1 ↘
 beste Teiler 14.1 (33.) 35.2 (38.) 43.1 (32.)
 Trefferlage 0.26 mm links, 0.15 mm tief
 Streuwert 0.89, horizontal: 1.09, vertikal: 0.64

QF – Schütze hat sich fürs Finale qualifiziert

Unterschrift des Schützen

Meyton Elektronik

Ergebnis: **408.9** (390)
 Serien: 103.6 99.7 102.9 102.7
 Zähler: 30 10 0 0 0 0 0 0 0 0
 Innenzehner: 25
 weiteste: 450 (13), 379 (14), 333 (26)
 beste Teiler 7.8 (24.) 13.6 (5.) 50.5 (35.)
 Trefferlage 0.18 mm rechts, 0.53 mm hoch
 Streuwert 1.44, horizontal: 1.70, vertikal: 1.13

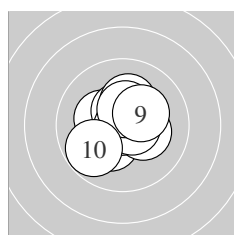
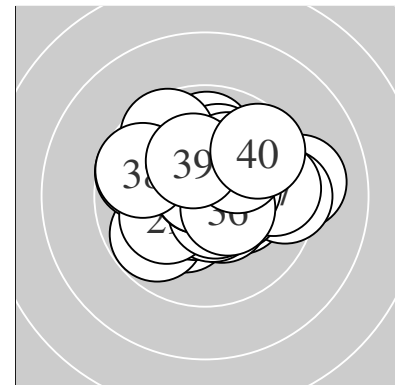

Serie 1:
 10.3 * 10.3 * 10.3 * 10.5 * 10.9 *
 10.6 * 10.2 * 10.4 * 10.3 * 9.8 ↙
 beste Teiler 13.6 (5.) 76.7 (6.) 115.7 (4.)
 Trefferlage 0.06 mm links, 0.17 mm hoch
 Streuwert 1.22, horizontal: 1.26, vertikal: 1.18

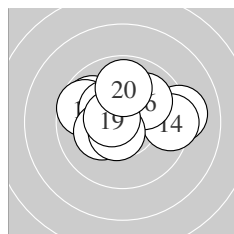

Serie 2:
 9.8 ↘ 9.7 ↘ 9.2 → 9.4 → 10.3 *
 10.0 ↗ 10.2 * 10.6 * 10.6 * 9.9 ↑
 beste Teiler 90.1 (19.) 91.9 (18.) 162.2 (15.)
 Trefferlage 0.04 mm rechts, 0.73 mm hoch
 Streuwert 1.93, horizontal: 2.51, vertikal: 1.09

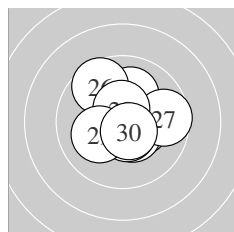

Serie 3:
 10.4 * 10.5 * 10.1 ↑ 10.9 * 10.6 *
 9.6 ↘ 9.6 → 10.5 * 10.1 ↙ 10.6 *
 beste Teiler 7.8 (24.) 87.0 (30.) 95.0 (25.)
 Trefferlage 0.33 mm rechts, 0.24 mm hoch
 Streuwert 1.41, horizontal: 1.47, vertikal: 1.34

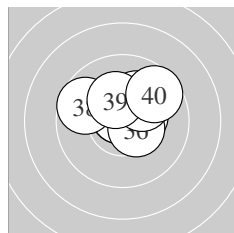

Serie 4:
 10.4 * 10.7 * 10.1 ↗ 10.5 * 10.8 *
 10.5 * 10.1 ↗ 9.7 ↘ 10.3 * 9.6 ↗
 beste Teiler 50.5 (35.) 53.3 (32.) 102.3 (34.)
 Trefferlage 0.40 mm rechts, 0.97 mm hoch
 Streuwert 1.21, horizontal: 1.51, vertikal: 0.81

Unterschrift des Schützen

Meyton Elektronik

Ergebnis: **403.8** (384)
 Serien: 100.6 102.5 100.3 100.4
 Zähler: 24 16 0 0 0 0 0 0 0 0
 Innenzehner: 20
 weiteste: 471 (26), 443 (7), 409 (31)
 beste Teiler 29.2 (40.) 44.9 (18.) 52.9 (20.)
 Trefferlage 0.18 mm rechts, 0.31 mm hoch
 Streuwert 1.72, horizontal: 2.01, vertikal: 1.38

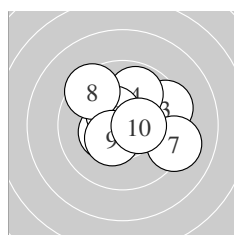
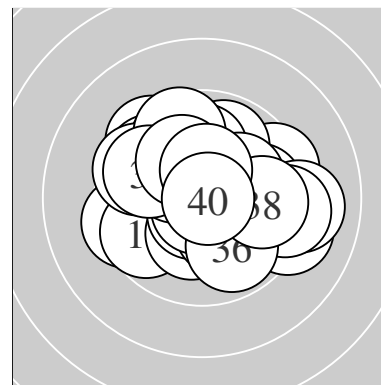

Serie 1:
 10.3 * 10.5 * 9.5 ↗ 9.9 ↗ 10.4 *
 10.5 * 9.2 ↘ 9.5 ↘ 10.4 * 10.4 *
 beste Teiler 104.6 (2.) 119.6 (6.) 131.0 (10.)
 Trefferlage 0.53 mm rechts, 0.65 mm hoch
 Streuwert 1.80, horizontal: 2.10, vertikal: 1.43

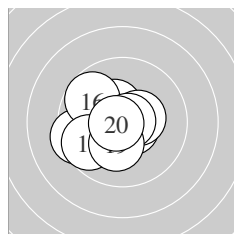

Serie 2:
 9.4 ← 10.6 * 10.4 * 10.6 * 10.4 *
 9.7 ↘ 9.7 ← 10.8 * 10.2 * 10.7 *
 beste Teiler 44.9 (18.) 52.9 (20.) 79.1 (14.)
 Trefferlage 0.86 mm links, 0.21 mm tief
 Streuwert 1.39, horizontal: 1.59, vertikal: 1.16

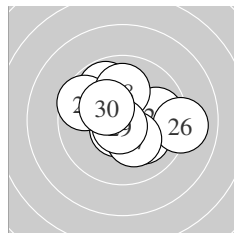

Serie 3:
 10.6 * 10.1 ↘ 9.8 ↘ 9.6 ↘ 9.9 →
 9.1 → 10.2 * 10.0 ↑ 10.7 * 10.3 *
 beste Teiler 54.5 (29.) 85.5 (21.) 165.0 (30.)
 Trefferlage 0.35 mm rechts, 0.31 mm hoch
 Streuwert 1.89, horizontal: 2.24, vertikal: 1.45

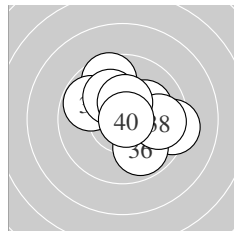

Serie 4:
 9.3 → 10.1 ↗ 9.6 ↖ 9.8 ↖ 10.6 *
 9.9 ↘ 10.1 ↖ 9.8 → 10.4 * 10.8 *
 beste Teiler 29.2 (40.) 92.7 (35.) 137.3 (39.)
 Trefferlage 0.69 mm rechts, 0.51 mm hoch
 Streuwert 1.76, horizontal: 1.97, vertikal: 1.51

Unterschrift des Schützen

Meyton Elektronik

Ergebnis: **393.0** (375)
 Serien: 96.4 98.8 99.7 98.1
 Zähler: 17 21 2 0 0 0 0 0 0 0
 Innenzehner: 10
 weiteste: 617 (9), 575 (5), 457 (37)
 beste Teiler 45.9 (1.) 64.2 (3.) 80.1 (27.)
 Trefferlage 0.50 mm links, 0.50 mm hoch
 Streuwert 2.16, horizontal: 1.94, vertikal: 2.36

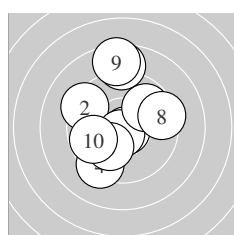
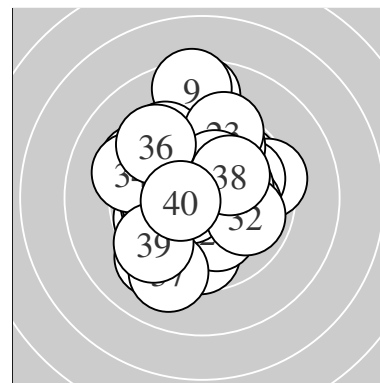

Serie 1:
 10.8 * 9.3 ↖ 10.7 * 9.3 ↙ 8.7 ↑
 10.1 ↘ 9.8 ↗ 9.4 → 8.5 ↑ 9.8 ←
 beste Teiler 45.9 (1.) 64.2 (3.) 218.0 (6.)
 Trefferlage 0.42 mm links, 0.93 mm hoch
 Streuwert 2.69, horizontal: 2.18, vertikal: 3.12

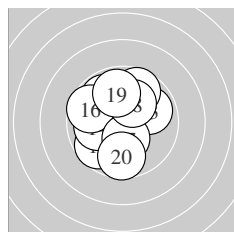

Serie 2:
 9.7 ↙ 9.8 ↖ 9.9 ↗ 10.0 ← 9.7 ↑
 9.7 ↖ 10.3 * 10.2 * 9.8 ↑ 9.7 ↓
 beste Teiler 155.1 (17.) 198.5 (18.) 237.5 (14.)
 Trefferlage 0.50 mm links, 0.46 mm hoch
 Streuwert 1.98, horizontal: 1.80, vertikal: 2.15

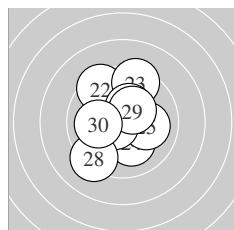

Serie 3:
 10.1 ↑ 9.4 ↖ 9.4 ↑ 10.1 ↘ 10.1 →
 10.4 * 10.6 * 9.2 ↙ 10.4 * 10.0 ←
 beste Teiler 80.1 (27.) 144.9 (29.) 150.4 (26.)
 Trefferlage 0.20 mm links, 0.53 mm hoch
 Streuwert 1.95, horizontal: 1.67, vertikal: 2.19

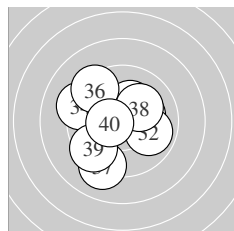

Serie 4:
 10.2 * 9.9 → 9.8 ↖ 9.3 ↖ 10.3 *
 9.4 ↖ 9.1 ↙ 10.1 ↗ 9.5 ↙ 10.5 *
 beste Teiler 122.1 (40.) 172.3 (35.) 186.9 (31.)
 Trefferlage 0.86 mm links, 0.08 mm hoch
 Streuwert 2.22, horizontal: 2.29, vertikal: 2.14

Unterschrift des Schützen

Meyton Elektronik

Ergebnis: **400.5** (386)
 Serien: 99.8 100.3 102.4 98.0
 Zähler: 27 12 1 0 0 0 0 0 0 0
 Innenzehner: 18
 weiteste: 541 (1), 475 (15), 469 (8)
 beste Teiler 60.4 (16.) 63.1 (20.) 73.0 (26.)
 Trefferlage 0.13 mm links, 0.12 mm hoch
 Streuwert 1.89, horizontal: 2.10, vertikal: 1.65

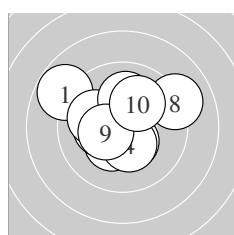
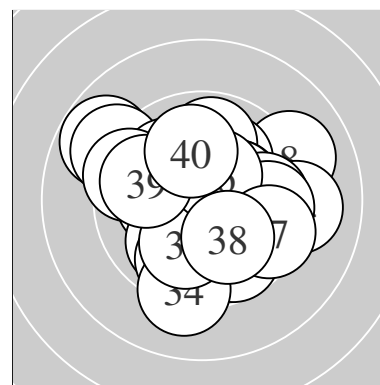

Serie 1:
 8.8 ↘ 10.4 * 10.3 * 10.4 * 10.3 *
 10.0 ↘ 10.0 ↑ 9.1 ↗ 10.4 * 10.1 ↗
 beste Teiler 132.4 (2.) 140.5 (9.) 145.2 (4.)
 Trefferlage 0.39 mm links, 0.54 mm hoch
 Streuwert 2.02, horizontal: 2.37, vertikal: 1.61

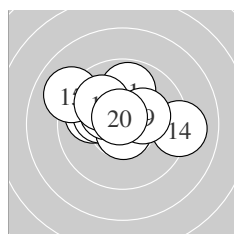

Serie 2:
 9.9 ↑ 10.0 ↖ 10.2 * 9.1 → 9.1 ↖
 10.7 * 10.3 * 10.0 ↘ 10.3 * 10.7 *
 beste Teiler 60.4 (16.) 63.1 (20.) 157.2 (17.)
 Trefferlage 0.47 mm links, 0.95 mm hoch
 Streuwert 1.85, horizontal: 2.39, vertikal: 1.06

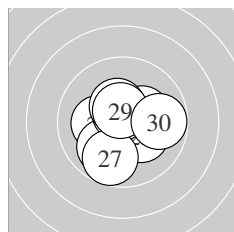

Serie 3:
 10.3 * 10.5 * 10.2 * 10.2 * 10.0 ↙
 10.7 * 9.7 ↓ 10.4 * 10.6 * 9.8 →
 beste Teiler 73.0 (26.) 94.7 (29.) 104.9 (22.)
 Trefferlage 0.17 mm rechts, 0.27 mm tief
 Streuwert 1.43, horizontal: 1.52, vertikal: 1.33

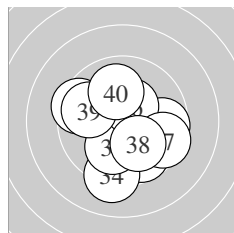

Serie 4:
 9.5 ↖ 9.7 ↘ 9.7 → 9.2 ↓ 10.1 ↙
 10.4 * 9.5 ↘ 10.1 ↘ 9.8 ↖ 10.0 ↑
 beste Teiler 136.0 (36.) 219.4 (38.) 220.0 (35.)
 Trefferlage 0.14 mm rechts, 0.71 mm tief
 Streuwert 2.19, horizontal: 2.26, vertikal: 2.11

Unterschrift des Schützen

Meyton Elektronik

Ergebnis: **399.8** (385)
 Serien: 101.3 100.1 98.8 99.6
 Zähler: 25 15 0 0 0 0 0 0 0 0
 Innenzehner: 17
 weiteste: 488 (21), 486 (31), 478 (19)
 beste Teiler 36.7 (33.) 64.0 (10.) 72.2 (4.)
 Trefferlage 0.10 mm links, 0.45 mm tief
 Streuwert 1.87, horizontal: 2.19, vertikal: 1.49

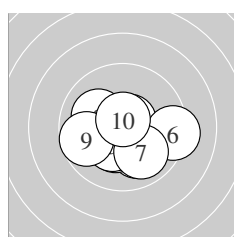
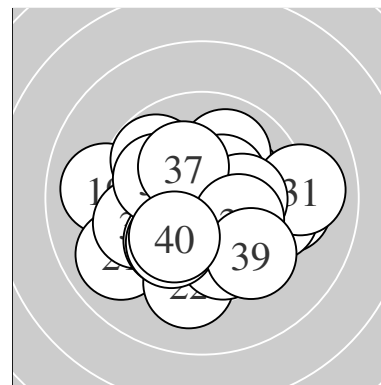

Serie 1:
 10.3 * 10.0 ↘ 10.3 * 10.7 * 10.3 *
 9.3 → 9.9 ↘ 10.1 ↖ 9.7 ← 10.7 *
 beste Teiler 64.0 (10.) 72.2 (4.) 160.8 (3.)
 Trefferlage 0.25 mm rechts, 0.71 mm tief
 Streuwert 1.62, horizontal: 2.02, vertikal: 1.07

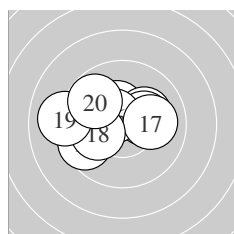

Serie 2:
 10.4 * 10.2 * 10.2 * 10.2 * 9.6 ↙
 10.6 * 10.0 → 10.1 ← 9.0 ← 9.8 ↘
 beste Teiler 99.0 (16.) 141.0 (11.) 181.4 (14.)
 Trefferlage 0.91 mm links, 0.43 mm hoch
 Streuwert 1.77, horizontal: 2.31, vertikal: 0.97

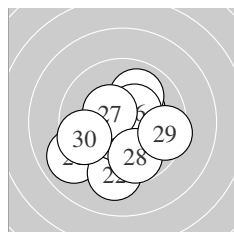

Serie 3:
 9.0 ↙ 9.3 ↓ 10.5 * 10.3 * 10.0 ↗
 10.4 * 10.4 * 9.8 ↘ 9.5 → 9.6 ↙
 beste Teiler 106.5 (23.) 131.6 (26.) 133.8 (27.)
 Trefferlage 0.15 mm links, 0.80 mm tief
 Streuwert 2.13, horizontal: 2.23, vertikal: 2.02

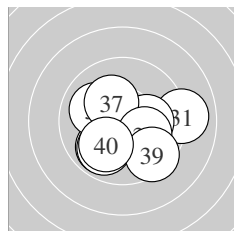

Serie 4:
 9.0 → 9.9 ↙ 10.8 * 10.2 * 9.9 ↙
 10.0 ↖ 10.2 * 10.1 ↘ 9.5 ↘ 10.0 ↙
 beste Teiler 36.7 (33.) 179.3 (37.) 198.0 (34.)
 Trefferlage 0.37 mm rechts, 0.74 mm tief
 Streuwert 1.94, horizontal: 2.30, vertikal: 1.48

Unterschrift des Schützen

Meyton Elektronik